



1

# CLASSIC

2012 - 2022

CATALOGO  
2023







VESPA | 1

APE | 517

LAMBRETTA | 641

CICLOMOTORE-MOPED | 687

GENERICICO | 769





*La motocicletta più bella è quella  
che devi ancora sistemare: la prossima.*

*The best motorcycle you still  
have to repair is the next one.*

Ispirato da  
*Inspired by*  
Enzo Ferrari

Con passione ed impegno  
*With dedication and commitment*  
Team RMS Moto



# 10 ANNI DI STORIA

OUR 10 YEARS ANNIVERSARY

Siamo giunti al decimo anniversario del catalogo Classic, il nostro catalogo dedicato a tutti quei modelli che hanno segnato la storia delle due ruote: parliamo infatti di Vespa, Ape, Lambretta e ciclomotore.

Questa edizione, ricca di novità, è frutto della volontà di offrirvi un catalogo sempre più ampio, completo ed aggiornato. Oltre alle novità di prodotto, sono state inserite descrizioni ed informazioni tecniche, volte ad offrire maggiore chiarezza e ad aiutarvi nel vostro lavoro quotidiano.

We have reached the tenth anniversary of the Classic catalogue which is dedicated to all those models that have marked the history of two wheels such as Vespa, Ape, Lambretta and moped.

This edition, full of novelties, wants to offer you a wider, comprehensive, and restyled catalogue. In addition to the new products, we have included descriptions and technical information to better assist you in your daily activities.



2012



2013



2014



2015



2016



2017  
2022

Una delle nostre priorità è stata quella di andare a prediligere tutti quei ricambi realizzati artigianalmente in Italia da piccole realtà locali, le quali, grazie all'esperienza acquisita nel corso degli anni, ci permettono di garantirvi un restauro nel perfetto rispetto di tutti gli standard qualitativi tipici dell'articolo originale.

Possiamo quindi affermare con certezza che dal 2012 ad oggi molte cose sono cambiate. Il restyling del logo storico testimonia proprio questa propensione al cambiamento, alla novità, alla modernità, senza però trascurare quelle che sono le nostre radici.

# 10



One of our priorities is to collaborate with small Italian local companies with a great expertise acquired through years of experience. This allows us to guarantee a restoration in compliance with quality standards typical of the original article.

Our willingness to grow and change since 2012 has led us to broaden our horizons with updated services, processes and strategies. We are now reintroducing ourselves with a restyle of our logo with a new look and feel, but with the same roots we have always held.

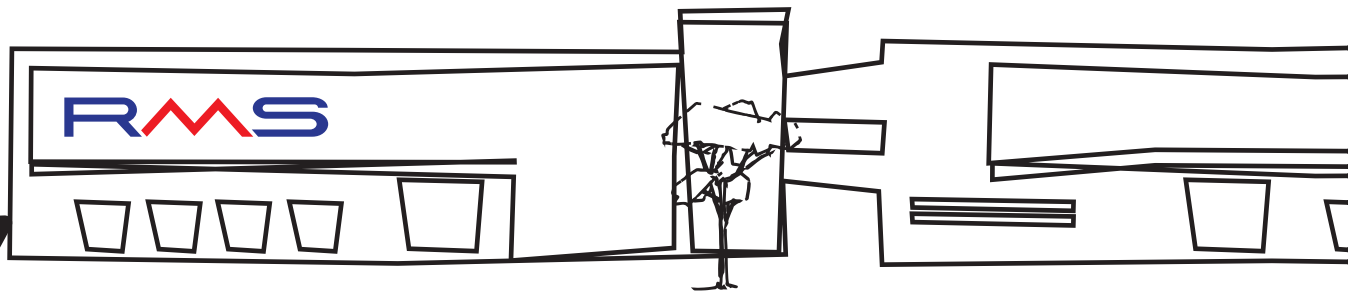

Alessandro  
 Andrea  
 Arianna  
 Barbara  
 Cinzia  
 Dankan  
 Dario  
 Filippo  
 Francesco  
 Francesca  
 Giacomo  
 Isabella  
 Laura  
 Marco F.  
 Marco M.  
 Roberto  
 Roberta  
 Rossella  
 Sonia  
 William

Alessandro  
 Andrea  
 Davide  
 Domenico P.  
 Domenico C.  
 Francesco  
 Giovanni  
 Luca M.  
 Luca P.  
 Marc  
 Marco  
 Massimo  
 Maurizio  
 Patrizio  
 Raffaele  
 Riccardo  
 Roberto  
 Samuel



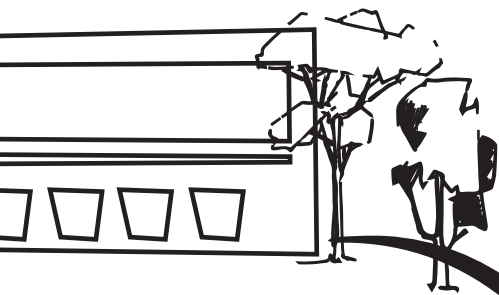

RETE VENDITA  
SALES NETWORK



# IL NOSTRO TEAM



Che si tratti di sportive, classiche o fuoristrada ciò che ci accomuna è la passione per le motociclette. Amiamo quella sensazione di libertà che si respira una volta allacciato il casco e abbassata la visiera.

È proprio quando si fa della propria passione un lavoro che si può ambire a grandi risultati. Costanza e determinazione ci aiutano poi ad essere perseveranti, in modo da rendere la nostra offerta ogni giorno più ampia, completa e consona alle vostre esigenze. Tutto ciò rimanendo sempre fedeli alla nostra missione:

rendere la manutenzione di un mezzo a due ruote facile, accessibile e alla portata di più persone possibili.

We all have the passion for motorcycles in common, whether it's racing, classic or off-road. We love the feeling of freedom that you breathe once you wear your helmet and lower the visor.

It is precisely when you turn your passion into a job that you can aspire to achieve great results. Consistency and determination help us to offer a wider, complete and more suited offer to your needs every day.

All this while remaining faithful to our mission:

to make the maintenance of a two-wheeled vehicle easy, accessible and within the reach of as many people as possible.



# VESPA

3	<b>ASPIRAZIONE</b>	INTAKE SYSTEM	SISTEMA DE ADMISION	SYSTÈME D'ADMISSION
7	<b>ALIMENTAZIONE</b>	FUEL SYSTEM	SISTEMA DE COMBUSTIBLE	SYSTÈME D'ALIMENTATION
27	<b>MOTORE</b>	ENGINE	MOTOR	MOTEUR
69	<b>SCARICO</b>	EXHAUST SYSTEM	SISTEMA DE ESCAPE	SYSTÈME D'ÉCHAPPEMENT
77	<b>IMPIANTO FRENANTE</b>	BRAKING SYSTEM	SISTEMA DE FRENADOS	SYSTÈME DE FREINAGE
87	<b>IMPIANTO ELETTRICO</b>	ELECTRICAL SYSTEM	INSTALACION ELECTRICA	SYSTÈME ÉLECTRIQUE
163	<b>BATTERIE</b>	BATTERIES	BATERIAS	BATTERIES
167	<b>TRASMISSIONE</b>	TRANSMISSION	TRANSMISIÓN	TRANSMISSION
211	<b>CARROZZERIA</b>	BODY WORK	CARROCERIA	CARROSSERIE
299	<b>TELAIO</b>	CHASSIS	CHASIS	CHASSIS
421	<b>SOSPENSIONI</b>	SUSPENSIONS	SUSPENSIONES	SUSPENSIONS
449	<b>CUSCINETTI</b>	BEARINGS	COJINETES	ROULEMENT
461	<b>TENUTA</b>	TIGHT SYSTEM	SISTEMA DE RETENES	SYSTÈME DE JOINTS
493	<b>GOMME</b>	TIRES	NEUMATICOS	PNEUS
501	<b>ACCESSORI</b>	ACCESSORIES	ACCESORIOS	ACCESSOIRES
511	<b>OFFICINA</b>	WORKSHOP	TALLER	ATELIER





# ASPIRAZIONE

INTAKE SYSTEM

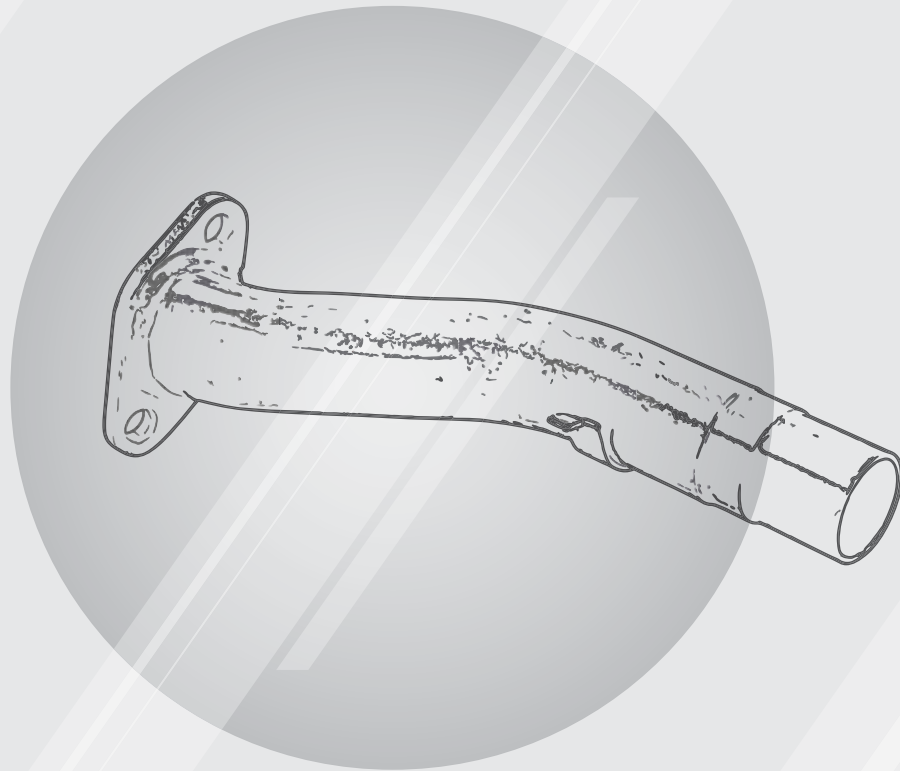

**100600501**



Cosa 1 CL/CLX 125-150-200 ('88-'91) • Cosa 2  
125-150-200 ('91-'97)  
R.O. 252971



**100601191**



Filtro aria secondario | *Secondary air filter*  
Vespa PX ('11-'16)  
R.O. 486942



**100602753**



Per SI 20-20 | *For SI 20-20*  
Vespa PX-PXE 125-150 • Vespa PX Arcobaleno  
125-150 • Vespa Sprint 150 • Vespa Sprint  
Veloce 150 • Vespa Super 150  
R.O. 113125



**100602810**



Per SI 24-24 | *For SI 24-24*  
1 foro su vite aria, 1 foro su vite minimo | *1 hole  
on air adjusting jet, 1 hole on idle jet*  
Vespa 200 Rally • Vespa P 200E • Vespa PX  
200E • Vespa Lusso • Cosa 125-150-200  
Adattabile a - Suitable for Vespa 125 TS • Vespa  
150 Sprint Veloce • Vespa 180 Rally • Vespa P  
80-150X • Vespa PX 80-150E • Vespa Lusso •  
Vespa '11  
R.O. 285352



**100603063**



Vespa GL 150 1° serie • Vespa Sprint 150 1° serie  
• Vespa Sprint Veloce 150 1° serie • Vespa 125  
VNB3/6  
R.O. 090926, 59710, 58343



**COLLETTORI ASPIRAZIONE - INLET PIPES**

**100520130**



Per carburatore SHBC 19-19 | *For carburetor SHBC 19-19*  
 Due fori | *Two holes*  
 Vespa 100 • Vespa 125 Primavera ('67-'83)  
 R.O.1128695

**PRODOTTI CORRELATI | RELATED PRODUCTS**



100703950



100620060



**100520150**



Per carburatore SHB 16-10 | *For carburetor SHB 16-10*  
 Due fori | *Two holes*  
 Vespa 50 ('63-'83) • Vespa 50 Special ('69-'83)  
 R.O. 4161114

**PRODOTTI CORRELATI | RELATED PRODUCTS**



100703950



100620060



**100520170**



Per carburatore SHB 16-10 / SHB 16-12 | *For carburetor SHB 16-10 / SHB 16-12*  
 Tre fori | *Three holes*  
 Vespa PK 50 • Vespa PK 50XL  
 R.O. 4308315

**PRODOTTI CORRELATI | RELATED PRODUCTS**



100703960



100620050



**SOFFIETTI / MANICOTTI - SLEEVES / INTAKE BELLOWS**

**100620050**



Vespa PK 50-125 • Vespa Rush • Vespa N •  
 Vespa FL2  
 R.O. 178694, 178695, 224781



**100620060**



Vespa 50 • Vespa 90 • Vespa 125 Primavera •  
 Vespa 125 Primavera ET3  
 R.O. 071813



## SOFFIETTI / MANICOTTI - SLEEVES / INTAKE BELLOWS

**120620070**



Con 8 nervature | *With 8 veinings*

Vespa PX • Vespa PE • Vespa GL

R.O. 227205, 179803



**120620080**



Lunghezza 175 mm | *Length 175 mm*

Vespa PX PE Arcobaleno • Vespa P 200E •

Vespa 125 T5

R.O. 181476



**120620090**



Vespa 150 Sprint • Vespa 180 Rally

R.O. 093766, 122327, 58246



**120620100**



Vespa 160 GS • Vespa 180 SS

R.O.077628, 97366



**100620130** NEW



Diametro interno Ø 85 mm | *Internal diameter  
Ø 85 mm*

Vespa 125 VN • Vespa 150 VL • Vespa VB1

R.O. 22674





# ALIMENTAZIONE

FUEL SYSTEM

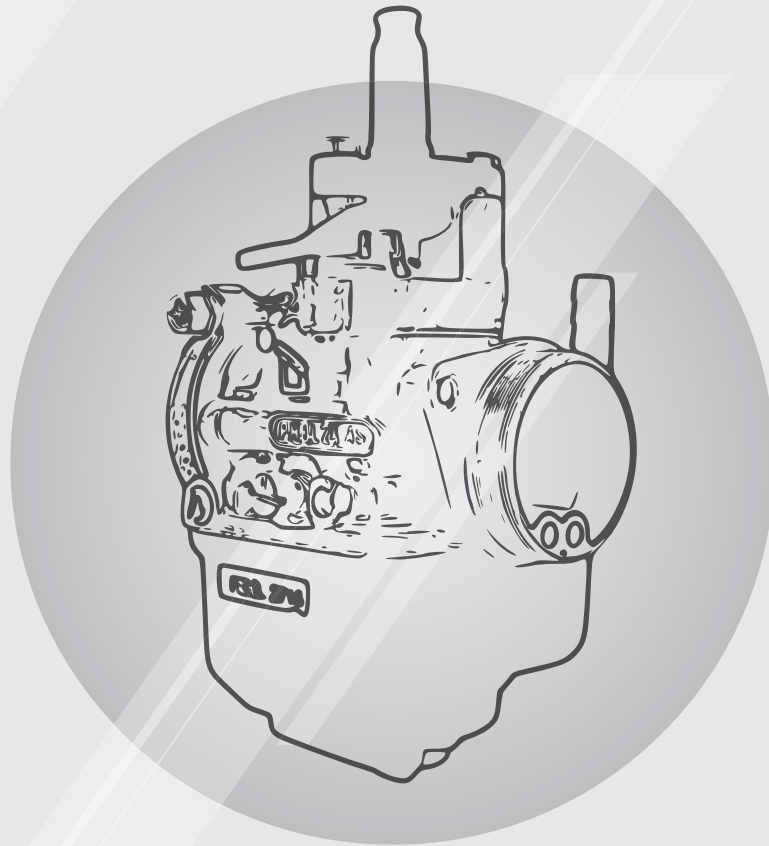

121700048 **NEW**



### DELL'ORTO

Tipologia SHB 16-10 | *Carburetor type SHB 16-10*

Codice Dell'Orto 00753 | *Dell'Orto part number 00753*

Getto massimo 51 | *Main jet 51*

Getto secondario 38 | *Idle mixture jet 38*

Vespa 50

R.O. 097587

PRODOTTI CORRELATI | *RELATED PRODUCTS*



121700003



121700049 **NEW**



### DELL'ORTO

Tipologia SHB 16-10F | *Carburetor type SHB 16-10F*

Codice Dell'Orto 00917 | *Dell'Orto part number 00917*

Getto massimo 53 | *Main jet 53*

Vespa PK 50XL

R.O. 245425

PRODOTTI CORRELATI | *RELATED PRODUCTS*



121700003



121700050 **NEW**



### DELL'ORTO

Tipologia SHB 16-12M | *Carburetor type SHB 16-12M*

Codice Dell'Orto 00926 | *Dell'Orto part number 00926*

Getto massimo 53 | *Main jet 53*

Vespa PK 50 Rush • Vespa 50 N

R.O. 246940

PRODOTTI CORRELATI | *RELATED PRODUCTS*



121700003



**CARBURATORI - CARBURETORS**

**121700051**

**NEW**



**DELL'ORTO**

Tipologia SHB 16-12N | *Carburetor type SHB 16-12N*  
 Codice Dell'Orto 00936 | *Dell'Orto part number 00936*  
 Getto massimo 58 | *Main jet 58*  
 Vespa PK 50 • Vespa 50 FL  
 R.O. 286700 - 430065

**PRODOTTI CORRELATI | RELATED PRODUCTS**



121700003



**121700052**

**NEW**



**DELL'ORTO**

Tipologia SHB 16-16 | *Carburetor type SHB 16-16*  
 Codice Dell'Orto 00764 | *Dell'Orto part number 00764*  
 Getto massimo 74 | *Main jet 74*  
 Getto secondario 42 | *Idle mixture jet 42*  
 Vespa 50 Special  
 R.O. 150600

**PRODOTTI CORRELATI | RELATED PRODUCTS**



121700003



**121700053**

**NEW**



**DELL'ORTO**

Tipologia SHB 16-16F | *Carburetor type SHB 16-16F*  
 Codice Dell'Orto 00879 | *Dell'Orto part number 00879*  
 Getto massimo 70 | *Main jet 70*  
 Vespa PK 50XL  
 R.O. 196930

**PRODOTTI CORRELATI | RELATED PRODUCTS**



121700003



121700061 **NEW**



### DELL'ORTO

Tipologia SHBC 19-19 | *Carburetor type SHBC 19-19*

Codice Dell'Orto 00773 | *Dell'Orto part number 00773*

Getto massimo 74 | *Main jet 74*

Getto secondario 45 | *Idle mixture jet 45*

Vespa 50 S ('63-'84) • Vespa 100 • Vespa 125

Primavera • Vespa 125 Primavera ET3

R.O. 196227

PRODOTTI CORRELATI | *RELATED PRODUCTS*



121700004



121700062 **NEW**



### DELL'ORTO

Tipologia SHBC 19-19E | *Carburetor type SHBC 19-19E*

Codice Dell'Orto 00866 | *Dell'Orto part number 00866*

Getto massimo 73 | *Main jet 73*

Getto secondario 45 | *Idle mixture jet 45*

Vespa PK 80 • Vespa PK 100 • Vespa PK 125

R.O. 178685

PRODOTTI CORRELATI | *RELATED PRODUCTS*



121700004



121700063 **NEW**



### DELL'ORTO

Tipologia SHBC 19-19E | *Carburetor type SHBC 19-19E*

Codice Dell'Orto 00943 | *Dell'Orto part number 00943*

Vespa PK 50XL • Vespa PK 125XL

PRODOTTI CORRELATI | *RELATED PRODUCTS*



121700004



**CARBURATORI - CARBURETORS****121700065** **NEW****DELL'ORTO**Tipologia SI 20-20D | *Carburetor type SI 20-20D*Codice Dell'Orto 00587 | *Dell'Orto part number 00587*Getto massimo 96 | *Main jet 96*

Vespa PX 125

**PRODOTTI CORRELATI | RELATED PRODUCTS**

121700007

**121700066** **NEW****DELL'ORTO**Tipologia SI 20-20D | *Carburetor type SI 20-20D*Codice Dell'Orto 00588 | *Dell'Orto part number 00588*Getto massimo 102 | *Main jet 102*Per modelli senza miscelatore | *For models without oil pump*

Vespa 125 TS • Vespa PX 125-150 • Vespa 150 Sprint Veloce • Vespa 180 Rally

**PRODOTTI CORRELATI | RELATED PRODUCTS**

121700007

**121700067** **NEW****DELL'ORTO**Tipologia SI 20-20D | *Carburetor type SI 20-20D*Codice Dell'Orto 00585 | *Dell'Orto part number 00585*Getto massimo 96 | *Main jet 96*Per modelli con miscelatore | *For oil pump equipped models*

Vespa PX 125

**PRODOTTI CORRELATI | RELATED PRODUCTS**

121700007



121700068 **NEW**



### DELL'ORTO

Tipologia SI 20-20D | *Carburetor type SI 20-20D*

Codice Dell'Orto 00590 | *Dell'Orto part number 00590*

Getto massimo 100 | *Main jet 100*

Per modelli con miscelatore | *For oil pump equipped models*

Vespa PX 150

PRODOTTI CORRELATI | *RELATED PRODUCTS*



121700007



121700069 **NEW**



### DELL'ORTO

Tipologia SI 24-24E | *Carburetor type SI 24-24E*

Codice Dell'Orto 00586 | *Dell'Orto part number 00586*

Getto massimo 118 | *Main jet 118*

Per modelli senza miscelatore | *For models without oil pump*

Vespa Rally 200 • Vespa P 200E • Vespa PX 200

PRODOTTI CORRELATI | *RELATED PRODUCTS*



121700007



121700070 **NEW**



### DELL'ORTO

Tipologia SI 24-24E | *Carburetor type SI 24-24E*

Codice Dell'Orto 00583 | *Dell'Orto part number 00583*

Getto massimo 116 | *Main jet 116*

Per modelli con miscelatore | *For oil pump equipped models*

Vespa Rally 200 • Vespa P 200E • Vespa PX 200

PRODOTTI CORRELATI | *RELATED PRODUCTS*



121700007



**CARBURATORI - CARBURETORS**

**121700071**

**NEW**



**DELL'ORTO**

Tipologia SI 24-24G | *Carburetor type SI 24-24G*  
Codice Dell'Orto 00593 | *Dell'Orto part number 00593*

Getto massimo 110 | *Main jet 110*

Per modelli senza miscelatore | *For models without oil pump*

Vespa PX 125 T5

**PRODOTTI CORRELATI | RELATED PRODUCTS**



121700007



**121700072**

**NEW**



**DELL'ORTO**

Tipologia SI 24-24G | *Carburetor type SI 24-24G*  
Codice Dell'Orto 00594 | *Dell'Orto part number 00594*

Getto massimo 110 | *Main jet 110*

Per modelli con miscelatore | *For oil pump equipped models*

Vespa PX 125 T5

**PRODOTTI CORRELATI | RELATED PRODUCTS**



121700007



**121700073**

**NEW**



**DELL'ORTO**

Tipologia SI 26-26E | *Carburetor type SI 26-26E*  
Codice Dell'Orto 00617 | *Dell'Orto part number 00617*

Getto massimo 120 | *Main jet 120*

Per modelli con miscelatore | *For oil pump equipped models*

Vespa PX 200 • Vespa PE 200

**PRODOTTI CORRELATI | RELATED PRODUCTS**



121700007



121700074 **NEW**



### DELL'ORTO

Tipologia SI 26-26G | *Carburetor type SI 26-26G*

Codice Dell'Orto 00618 | *Dell'Orto part number 00618*

Getto massimo 110 | *Main jet 110*

Per modelli con miscelatore | *For oil pump equipped models*

Vespa PX 125 T5

PRODOTTI CORRELATI | *RELATED PRODUCTS*



121700007



121700024 **NEW**



### DELL'ORTO

Tipologia PHBL 24AD | *Carburetor type PHBL 24AD*

Codice Dell'Orto 02733 | *Dell'Orto part number 02733*

Getto massimo 100 | *Main jet 100*

Getto secondario 50 | *Idle mixture jet 50*

Attacco a destra | *Right joint*

Adattabile Vespa | *Suitable for Vespa*



121700025 **NEW**



### DELL'ORTO

Tipologia PHBL 24AS | *Carburetor type PHBL 24AS*

Codice Dell'Orto 02715 | *Dell'Orto part number 02715*

Getto massimo 100 | *Main jet 100*

Getto secondario 50 | *Idle mixture jet 50*

Attacco a sinistra | *Left joint*

Adattabile Vespa | *Suitable for Vespa*





## CARBURATORI - CARBURETORS

121700026 **NEW****DELL'ORTO**

Tipologia PHBL 24BD | Carburetor type PHBL 24BD

Codice Dell'Orto 02762 | Dell'Orto part number 02762

Getto massimo 95 | Main jet 95

Getto secondario 50 | Idle mixture jet 50

Con attacco miscelatore | With oil mix intake

Adattabile Vespa | Suitable for Vespa



## RUBINETTI BENZINA - FUEL TAPS

121670050



Con Riserva | With reserve

Vespa PX 125-150-200

Adattabile a - Suitable for Vespa 125 VNA •

Vespa 125 TS • Vespa 150 VBB/VBA • Vespa 150

GS • Vespa 160 GS Vespa 180 SS • Vespa 180

Rally

R.O. 158793



121670150



Con Riserva | With reserve

Vespa 50-90-125 modelli small frame - small

frame models • Vespa 125 Primavera • Vespa

125 Primavera ET3 • Vespa PK 50-125 S

Adattabile a - Suitable for Vespa 125 V30-V33 •

Vespa 125 VM/VN/VNA • Vespa 125 TS • Vespa

150 VB/VBA/VL • Vespa 150 GS • Vespa 160 GS

• Vespa 180 SS • Vespa 180 Rally • Vespa PX

R.O. 139938



**121670170**



Senza Riserva, per modelli con miscelatore |  
*Without reserve, for oil mix models*  
 Vespa PX PE • Vespa PX PE Arcobaleno  
 R.O. 217872



**121678023**



Con vaschetta in alluminio | *With aluminium bowl*

Vespa 125-150 VBA/VBB/VNA • Vespa TS •  
 Vespa GS 160 • Vespa 180 SS • Vespa Rally  
 Adatto per - *Suitable for* Vespa 150 GS VS1-5T



**121678033**



Con vaschetta in vetro | *With glass bowl*

Vespa 125 VNB 1-6, VBB 1-2 • Vespa GT • Vespa  
 GTR • Vespa Sprint • Vespa GL 150 • Vespa  
 Sprint Veloce • Vespa Super VNC1T



**ACCESSORI RUBINETTI BENZINA - FUEL TAPS ACCESSORIES**

**121680020**



ASTA RUBINETTO | *FUEL TAP LEVER*

Lunghezza 175 mm | *Length 175 mm*

Vespa PX 125-150-200 Arcobaleno • Vespa PK •  
Vespa PK XL • Vespa T5

R.O. 103202



**121680040**



ASTA RUBINETTO | *FUEL TAP LEVER*

Lunghezza 200 mm | *Length 200 mm*

Vespa 50-90-125 Primavera • Vespa ET3

R.O. 217871



**121680124**



ASTA RUBINETTO | *FUEL TAP LEVER*

Lunghezza 150 mm | *Length 150 mm*

Materiale Alluminio | *Material Aluminium*

Vespa Sprint

R.O. 084224



**121680133**



ASTA RUBINETTO | *FUEL TAP LEVER*

Lunghezza 200 mm | *Length 200 mm*

Materiale Alluminio lucidato | *Material Polished  
aluminium*

Vespa 50

R.O. 98584



**121680143**



ASTA RUBINETTO | *FUEL TAP LEVER*

Lunghezza 165 mm | *Length 165 mm*

Materiale Alluminio lucidato | *Material Polished  
aluminium*

Vespa PX



**121830040**



GOMMINO ASTA RUBINETTO NERO | *FUEL ROD RUBBER BLACK*

Confezione 10 pz. | *10 Pcs Packing*

Diametro Ø 22 mm | *Diameter Ø 22 mm*

Vespa PX 80-200E Lusso • Vespa ('98) • Vespa MY • Vespa T5 • Vespa ('11)

R.O. 194631



**121830340**



GOMMINO ASTA RUBINETTO NERO | *FUEL ROD RUBBER BLACK*

Confezione 5 pz. | *5 Pcs Packing*

Diametro Ø 20 mm | *Diameter Ø 20 mm*

Vespa 50-125 PV • Vespa ET3 • Vespa PK • Vespa S • Vespa XL • Vespa VNA-TS • Vespa 150 VBA-T4 • Vespa 160 GS • Vespa 180 SS • Vespa Rally • Vespa P 80-150X • Vespa PX 80-200E • Vespa Lusso 1° serie • Vespa P 150S • Vespa P 200E

R.O. 132538, 047460



**121830341**



GOMMINO ASTA RUBINETTO GRIGIO | *FUEL ROD RUBBER GREY*

Confezione 5 pz. | *5 Pcs Packing*

Diametro Ø 20 mm | *Diameter Ø 20 mm*

Vespa 50-125 PV • Vespa ET3 • Vespa PK • Vespa S • Vespa XL • Vespa VNA-TS • Vespa 150 VBA-T4 • Vespa 160 GS • Vespa 180 SS • Vespa Rally • Vespa P 80-150X • Vespa PX 80-200E • Vespa Lusso 1° serie • Vespa P 150S • Vespa P 200E

R.O. 132538



**ACCESSORI RUBINETTI BENZINA - FUEL TAPS ACCESSORIES**

**121830530**



GUARNIZIONE RUBINETTO BENZINA | *FUEL TAP GASKET*

Confezione 5 pz. | *5 Pcs Packing*

Diametro Ø 21 mm | *Diameter Ø 21 mm*

Per tutti i modelli Vespa - *Vespa all models*

R.O. 13836



**FILTRI CARBURANTE - FUEL FILTERS**

**100607000**



FILTRO BENZINA | *FUEL FILTER*

Attacco tubo Ø 6-8 mm | *Pipe attack Ø 6-8 mm*

Elemento filtrante in carta | *Paper filter*

Confezione 10 pz. | *10 Pcs Packing*

Applicazioni varie | *Various applications*



**100607010**



FILTRO BENZINA | *FUEL FILTER*

Attacco tubo Ø 7 mm | *Pipe attack Ø 7 mm*

Confezione 10 pz. | *10 Pcs Packing*

Applicazioni varie | *Various applications*



**SERBATOI BENZINA E ACCESSORI - FUEL TANKS AND ACCESSORIES**

**121730060**



SERBATOIO CARBURANTE | *FUEL TANK*

Mesticato | *Primed*

Lungo | *Long*

Con coperchio serbatoio | *With tank cap*

Vespa 50-125 ('67-'82) • Vespa 50 S ('68-'82) •

Vespa 50 L-R ('70-'83) •

Vespa 50 Special ('75-'83) • Vespa 90-100 ('78-

'83) • Vespa 125 Primavera ('67-'83) • Vespa 125

ET3 ('76-'83)

R.O. 1386172



**121650043** **NEW**



TAPPO SERBATOIO | *FUEL CAP*

Fondo verde | *Green bottom*

Diametro Ø70 mm | *Diameter Ø70 mm*

Vespa PK FL ('89-'90) • Vespa PK FL2 ('90-'97)

• Vespa N ('89-'90) • Vespa PK XL ('85-'90) •

Vespa PK XL ('86-'89) • Vespa PX ('87-'17) •

Vespa PX T5 ('85-'89)

R.O. 575825



**121650063**



KIT TAPPO SERBATOIO VESPA | *VESPA CAP*

*TANK KIT*

Inclusa vite e coppiglia | *With screw and cotter pin*

Vespa 50 • Vespa Primavera ET3 125 • Vespa

PK • Vespa VNA • Vespa Super • Vespa TS •

Vespa GT • Vespa GTR • Vespa Sprint • Vespa

Rally • Vespa 180SS • Vespa PX 1° serie



**121650120** **NEW**



COPERCHIO GALLEGGIANTE | *FUEL GAUGE*

*CAP*

Vespa PK FL ('89-'90) • Vespa PK FL2 ('90-'97)

• Vespa N ('89-'90) • Vespa PK XL ('85-'90) •

Vespa PK XL ('86-'89) • Vespa PX ('87-'17) •

Vespa PX T5 ('85-'89)

R.O. 2705865



**121650133** **NEW**



TAPPO SERBATOIO ROSSO | *RED FUEL CAP*

Fondo rosso | *Red bottom*

Diametro Ø60 mm | *Diameter Ø60 mm*

Guarnizione inclusa | *Gasket included*

Vespa PK FL ('89-'90) • Vespa PK FL2 ('90-'97)

• Vespa N ('89-'90) • Vespa PK XL ('85-'90) •

Vespa PK XL ('86-'89) • Vespa PX ('87-'17) •

Vespa PX T5 ('85-'89)

R.O. 575825



SERBATOI BENZINA E ACCESSORI - FUEL TANKS AND ACCESSORIES

**121730043**



TRASMETTITORE LIVELLO BENZINA | FUEL GAUGE

Attacco a baionetta | *Bayonet connection*  
4 cavi (verde, bianco, giallo, nero) | *4 cables (green, white, yellow, black)*

Vespa PX 125-150-200 • Vespa 125 T5  
R.O. 218585



**121710053**



TRASMETTITORE LIVELLO BENZINA | FUEL GAUGE

Attacco 5 fori | *5 holes connection*

Vespa PX 125-150-200 Arcobaleno • Vespa T5  
R.O. C-4723019

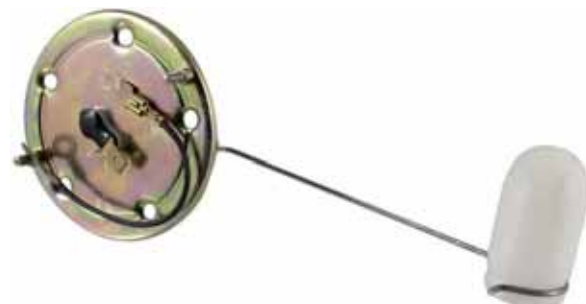

**121710090**



TRASMETTITORE LIVELLO BENZINA | FUEL GAUGE

Con guarnizione in Viton | *Viton gasket included*

Vespa 50 FL • Vespa FL2 • Vespa N • Vespa PK XL Rush • Vespa PK XL • Vespa 125 FL  
R.O. 228444



**121710100**



TRASMETTITORE LIVELLO BENZINA | FUEL GAUGE

Con guarnizione in Viton | *Viton gasket included*

Vespa PX 125 30 Anni • Vespa PX Euro2 • Vespa PX T5 • Vespa PX ('11-'17) • Vespa PX ('98-'01)  
R.O. 228090



## SERBATOI BENZINA E ACCESSORI - FUEL TANKS AND ACCESSORIES

121830950



GUARNIZIONE Sonda LIVELLO CARBURANTE |  
FUEL SENSOR LEVEL GASKET

Vespa PK 50XL • Vespa FL • Vespa FL2 • Vespa  
N • Vespa PX 125 30 Anni • Vespa PX ('11-'17) •  
Vespa PX ('98-'01)  
R.O. 228354, 258161



## ACCESSORI CARBURATORE - CARBURETOR ACCESSORIES

121680083



ASTA STARTER | CHOKE TIE ROD

Bottone in plastica nero | Black plastic knob  
Vespa PX 125-150-200 • Vespa old models  
R.O. 580938



121680153

**NEW**



ASTA STARTER | CHOKE TIE ROD

Vespa 50 N-R-L • Vespa 50 Special • Vespa 90  
• Vespa 125 Primavera • Vespa 125 Primavera  
ET3  
R.O. 98568



121680163

**NEW**



MOLLA LEVETTA ARIA | SPRING AIR LEVER

Vespa PX 125-150-200 • Vespa PX 125 T5  
R.O. 183321





**ACCESSORI CARBURATORE - CARBURETOR ACCESSORIES**

**121680090**



GALLEGGIANTE CARBURATORE Dell'Orto  
4567.80 | *CARBURETOR FLOAT Dell'Orto*  
4567.80

Cosa 125 • Cosa 2 125 • Vespa GT 125 • Vespa  
PX 125-150-200 • Vespa Super 125-150 • Vespa  
125 VNB • Vespa 150 GS • Vespa Sprint 150 •  
Vespa Rally 180-200  
R.O. 085293



**121680100**



SPIILLO CARBURATORE Quadro | *FLOAT NEEDLE*  
*4 sided*

Cosa 125 • Cosa 2 125 • Vespa GT 125 • Vespa  
PX 125-150-200 • Vespa Super 125-150 • Vespa  
125 VNB • Vespa 150 GS • Vespa Sprint 150 •  
Vespa Rally 180-200  
R.O. 247652



**121680110**



SPIILLO CARBURATORE Triangolare | *FLOAT*  
*NEEDLE 3 sided*

Vespa 50-90-125 Primavera • Vespa ET3 •  
Vespa PK  
R.O. 247653



**121680120**

**NEW**



COPERCHIO CARBURATORE | *CARBURATOR*  
*COVER*

Vespa 125 VNB-TS • Vespa 150 VBA-Super •  
Vespa Rally • Vespa  
P 80-150X • Vespa P 200E • Vespa PX 80-200E  
• Vespa Lusso • Vespa T5  
R.O. 87856



**121831063** **NEW**



TAPPO COPERCHIO VASCHETTA CARBURATORE  
| *RUBBER PLUG CARBURATOR CAISING COVER*

Vespa 125 VNB-TS • Vespa 150 VBA-Super •  
Vespa Rally • Vespa  
P 80-150X • Vespa P 200E • Vespa PX 80-200E  
• Vespa Lusso • Vespa T5 • Vespa ('98) • Vespa  
MY • Vespa ('11)  
R.O. 87975



**121831073** **NEW**



GOMMINO VITE MINIMO | *ADJUSTING SCREW  
IDLE RUBBER PAD*

Vespa 125 VNB-TS • Vespa 150 VBA-Super •  
Vespa Rally • Vespa  
P 80-150X • Vespa P 200E • Vespa PX 80-200E  
• Vespa Lusso • Vespa T5 • Vespa ('98) • Vespa  
MY • Vespa ('11)  
R.O. 58364



**121830223** **NEW**



GUARNIZIONE FILTRO ARIA | *AIR FILTER  
GASKET*

Vespa 180-200 Rally • Vespa P 80-150X • Vespa  
P 200E • Vespa PX 80-200E • Vespa Lusso •  
Vespa '98 • Vespa MY • Vespa '11 • Vespa T5  
R.O. 227609, 239049, 058853



**121830330**



TAPPO VASCHETTA CARBURATORE | *RUBBER  
PLUG CARBURATOR CAISING*

Confezione 5 pz. | *5 Pcs Packing*  
Vespa PX PE 125-150-200 • Vespa PX  
Arcobaleno  
R.O. 050274



ACCESSORI CARBURATORE - CARBURETOR ACCESSORIES

**121831113**

**NEW**



GUARNIZIONE COPERCHIO CARBURATORE |  
CARBURATOR COVER GASKET

Vespa 180-200 Rally • Vespa P 80-150X • Vespa  
P 200E • Vespa  
PX 80-200E • Vespa Lusso • Vespa ('98) •  
Vespa MY • Vespa ('11) • Vespa T5  
R.O. 028263, 028447

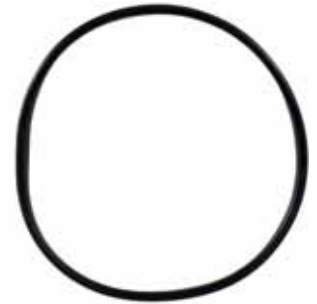

**121850190**

**NEW**



VITE FILTRO ARIA | AIR FILTER SCREW

Dimensione M5x36x0,8 mm | Dimension  
M5x36x0,8 mm

Vespa 125 VNB-TS • Vespa 150 VBA-Super •  
Vespa Rally • Vespa PX 80-200 • Vespa PE •  
Vespa Lusso • Cosa 1  
R.O. S.14743



**121850192**

**NEW**



VITE FILTRO ARIA ANTERIORE | FRONT AIR  
FILTER SCREW

Dimensione M5x35 mm | Dimension M5x35 mm  
Esagonale | Hexagonal

Vespa 125 VNB-TS • Vespa 150 VBA-Super •  
Vespa Rally • Vespa P 80-150X • Vespa P 200E  
• Vespa PX 80-200E • Vespa Lusso • Vespa T5  
Modelli senza miscelatore - Models without oil  
pump  
R.O. 014583, 015835



**121860333**



BULLONE CARBURATORE | CARBURATOR BOLT  
Confezione 5 pz. | 5 Pcs Packing

Vespa 125 ('55-'65) • Vespa 125 Sprint-GR-  
Super-Rally • Vespa 150-180 Sprint-GR-Super-  
Rally VNX-VLX-VSX  
R.O. 049542



**121859030**



FASCETTA BANDA PIENA Ø 15-25 mm | CLAMP  
 Ø 15-25 mm  
 Confezione 5 pz. | 5 Pcs Packing  
 Applicazioni varie | Various applications



**121859040**



FASCETTA BANDA PIENA Ø 20-32 mm | CLAMP  
 Ø 20-32 mm  
 Confezione 10 pz. | 10 Pcs Packing  
 Applicazioni varie | Various applications



**121859050**



FASCETTA BANDA PIENA Ø 32-50 mm | CLAMP  
 Ø 32-50 mm  
 Confezione 10 pz. | 10 Pcs Packing  
 Applicazioni varie | Various applications



**121859060**



FASCETTA BANDA PIENA Ø 50-70 mm | CLAMP  
 Ø 50-70 mm  
 Confezione 10 pz. | 10 Pcs Packing  
 Applicazioni varie | Various applications



# MOTORE

ENGINE

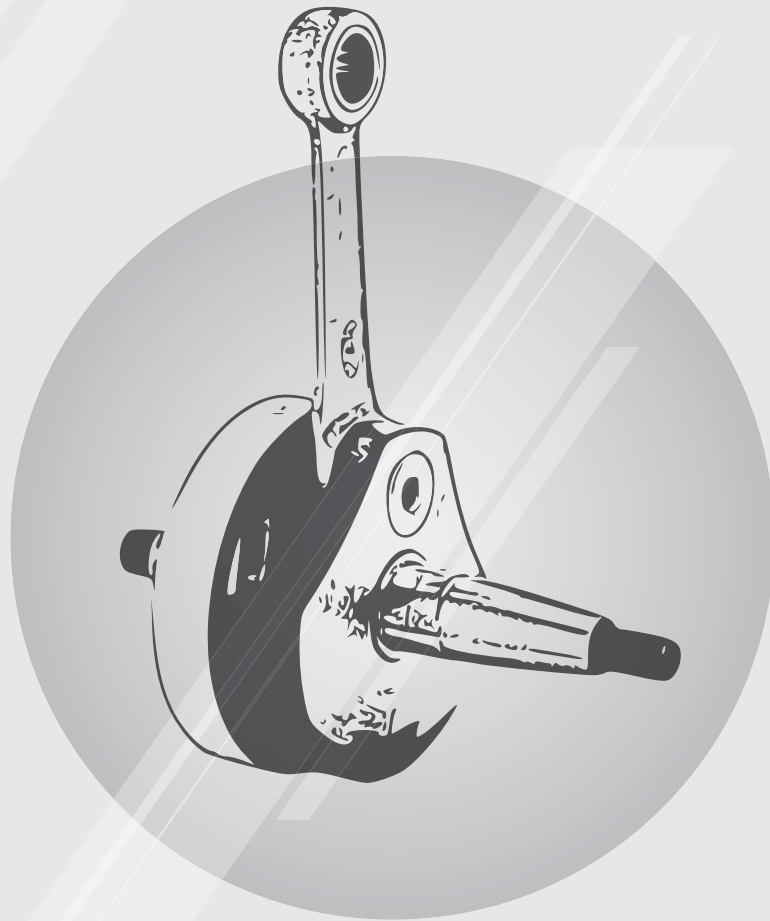

## ALBERI MOTORE - CRANKSHAFTS

**100010250**



TIPO STANDARD | *STANDARD TYPE*

Spinotto Ø 12 mm | *Ø 12 mm pin*

Gabbia a rulli inclusa | *Roller cage included*

Valvola a disco rotante | *Rotary disc valve intake*

Corsa 51 mm | *Stroke 51 mm*

Interasse biella 97 mm | *Tie rod wheelbase 97 mm*

Cono 19 mm | *Cone 19 mm*

Vespa 125 Primavera • Vespa Primavera ET3 •

Vespa PK 125 1° serie

R.O. 123296

### PRODOTTI CORRELATI | *RELATED PRODUCTS*



100200830



100150400



**100030250\***



BILANCIATO CON BIELLA LUCIDATA |

*BALANCED WITH POLISHED CONROD*

Spinotto Ø 12 mm | *Ø 12 mm pin*

Gabbia a rulli inclusa | *Roller cage included*

Per trasformazione da 50 a 125cc | *For racing cylinder from 50 to 125cc*

Corsa 51 mm | *Stroke 51 mm*

Interasse biella 97 mm | *Tie rod wheelbase 97 mm*

Cono 19 mm | *Cone 19 mm*

Vespa 125 Primavera ET3 • Vespa PK 125 1°

serie anticipato biella lucida | *Racing, polished connecting rod*

R.O. 123296

### PRODOTTI CORRELATI | *RELATED PRODUCTS*



100200830



100150400



\* Utilizzo esclusivo per uso agonistico, vietato l'uso su strade pubbliche | \* *Only for racing use, the use on public road is forbidden*

## ALBERI MOTORE - CRANKSHAFTS

**100010230**

TIPO STANDARD | STANDARD TYPE

Spinotto Ø 12 mm | Ø 12 mm pin

Cono Ø19mm | Flywheel side cone Ø19mm

Gabbia a rulli inclusa | Roller cage included

Corsa 43 mm | Stroke 43 mm

Interasse biella 87 mm | Tie rod wheelbase  
87 mm

Vespa 50 ('65-'66) • Vespa 50 Special • Vespa

PK 50 1° serie

R.O. 123292

## PRODOTTI CORRELATI | RELATED PRODUCTS



100200810 SKF



100150250

**100010240**

TIPO STANDARD | STANDARD TYPE

Spinotto Ø 12 mm | Ø 12 mm pin

Cono Ø20mm | Flywheel side cone Ø20mm

Gabbia a rulli inclusa | Roller cage included

Corsa 43 mm | Stroke 43 mm

Interasse biella 87 mm | Tie rod wheelbase  
87 mm

Vespa 50 FL/N ('89-'90) • Vespa PK 50 ('83-'84)

• Vespa PK 50XL ('85-'89) • Vespa HP/Rush/FL2

R.O. 224587

## PRODOTTI CORRELATI | RELATED PRODUCTS



100200810 SKF



100150300



**100010270**



TIPO STANDARD | STANDARD TYPE

Spinotto Ø 15 mm | Ø 15 mm pin

Gabbia a rulli inclusa | Roller cage included

Valvola a disco rotante | Rotary disc valve intake

Corsa 57 mm | Stroke 57 mm

Interasse biella 105 mm | Tie rod wheelbase 105 mm

Fasatura 112°/6° a pms | Valve timing 112°/6° post TDC

Vespa 125 GTR 2° serie • Vespa 125 TS 2° serie  
• Vespa 150 Sprint V 2° serie • Vespa Super 2° serie  
• Vespa P 125-150X/PX 125-150E • Vespa PX Lusso/MY • Vespa PX 125-150 • Cosa 125-150

R.O. 133154

### PRODOTTI CORRELATI | RELATED PRODUCTS



100200840



100150400



**100010280**



TIPO STANDARD | STANDARD TYPE

Spinotto Ø 16 mm | Ø 16 mm pin

Gabbia a rulli inclusa | Roller cage included

Valvola a disco rotante | Rotary disc valve intake

Corsa 57 mm | Stroke 57 mm

Interasse biella 110 mm | Tie rod wheelbase 110 mm

Fasatura 112°/6° a pms | Valve timing 112°/6° post TDC

Vespa 200 Rally VSE1T 33997 -> P 200E/PX  
200 E/Lusso/MY/Cosa • Vespa PE 200 • Cosa 200

R.O. 1331535, 238959

### PRODOTTI CORRELATI | RELATED PRODUCTS



100200860



100150450





## ALBERI MOTORE - CRANKSHAFTS

**100010290**TIPO STANDARD | *STANDARD TYPE*Spinotto Ø 15 mm | *Ø 15 mm pin*Gabbia a rulli inclusa | *Roller cage included*Valvola a disco rotante | *Rotary disc valve intake*Corsa 57 mm | *Stroke 57 mm*Interasse biella 105 mm | *Tie rod wheelbase 105 mm*Fasatura 112°/6° a pms | *Valve timing 112°/6° post TDC*

Vespa Super • Vespa 150 Sprint 1° serie • Vespa GL 150

Adattabile a - *Suitable for Vespa 150 2% del 59*

• Vespa 125 VNB 1-&gt;6 • Vespa 125 GT • Vespa 125 GTR 1° serie • Vespa VBA VBB

R.O. 91060, 98497, 130146, 131321, 131121, 1313215

PRODOTTI CORRELATI | *RELATED PRODUCTS*

100200850



100150400

**100030310\***

BILANCIATO CON BIELLA LUCIDATA |

*BALANCED WITH POLISHED CONROD*Spinotto Ø 15 mm | *Ø 15 mm pin*Cono Ø20 mm | *Flywheel side cone Ø20 mm*Gabbia a rulli inclusa | *Roller cage included*Corsa 51 mm | *Stroke 51 mm*Interasse biella 97 mm | *Tie rod wheelbase 97 mm*Per trasformazione da 50 a 125cc | *For racing cylinder from 50 to 125cc*

Vespa PK 50

PRODOTTI CORRELATI | *RELATED PRODUCTS*

100200820 SKF



100150400



100012000 **NEW**



TIPO STANDARD | *STANDARD TYPE*

Valvola a disco rotante | *Disc valve*

Corsa 43,00 mm | *Stroke 43,00 mm*

Biella 87,00 mm | *Connecting rod 87,00 mm*

Cono 19 mm, M10 | *Cone 19 mm, M10*

Codice fornitore AMT 120 | *Supplier product code AMT 120*

Vespa 50 N-L-R • Vespa 50 Special • Vespa 90 • Vespa 50-90 SS • Vespa PK 50 S

R.O. 196105



100012001 **NEW**



ANTICIPATO | *RACING*

Valvola a disco rotante | *Disc valve*

Corsa 43,00 mm | *Stroke 43,00 mm*

Biella 87,00 mm standard | *Connecting rod 87,00 mm standard*

Cono 19 mm, M10 | *Cone 19 mm, M10*

TUNING ROAD - affidabile e per uso quotidiano

| *TUNING ROAD - reliable and for daily use*

Codice fornitore AMT 158 | *Supplier product code AMT 158*

Vespa 50 N-L-R • Vespa 50 Special • Vespa 90 • Vespa 50-90 SS • Vespa PK 50 S



## ALBERI MOTORE - CRANKSHAFTS

100012002 **NEW**TIPO STANDARD | *STANDARD TYPE*Valvola a disco rotante | *Disc valve*Corsa 51,00 mm | *Stroke 51,00 mm*Biella 97,00 mm | *Connecting rod 97,00 mm*Cono 19 mm, M10 | *Cone 19 mm, M10*Codice fornitore AMT 126 | *Supplier product code AMT 126*Vespa 90 • Vespa 90 SS • Vespa 100 • Vespa  
125 Primavera • Vespa 125 Primavera ET3 •  
Vespa PK 80-100S • Vespa PK 125

R.O. 1232946

100012003 **NEW**ANTICIPATO | *RACING*Valvola a disco rotante | *Disc valve*Corsa 51,00 mm | *Stroke 51,00 mm*Biella 97,00 mm standard | *Connecting rod  
97,00 mm standard*Cono 19 mm, M10 | *Cone 19 mm, M10*Spinotto Ø 15 mm | *Ø 15 mm pin*

TUNING ROAD - affidabile e per uso quotidiano

| *TUNING ROAD - reliable and for daily use*Codice fornitore AMT 160 | *Supplier product code AMT 160*Vespa 90 • Vespa 90 SS • Vespa 100 • Vespa  
125 Primavera • Vespa 125 Primavera ET3 •  
Vespa PK 80-100S • Vespa PK 125

100012004 **NEW**



TIPO STANDARD | STANDARD TYPE

Valvola a disco rotante | Disc valve

Corsa 57,00 mm | Stroke 57,00 mm

Biella 105,00 mm | Connecting rod 105,00 mm

Spinotto Ø 15 mm | Ø 15 mm pin

Fasatura 112°/6° a pms | Valve timing 112°/6°  
post TDC

Perno biella 22mm | Con-rod pin 22mm

Codice fornitore AMT 132 | Supplier product  
code AMT 132

Vespa 125 VNB 1/6 • Vespa 125 GT/GTR 1° serie  
• Vespa 125 Super • Vespa 125 TS • Vespa 150  
VBA • Vespa 150 VBB • Vespa 150 GL • Vespa  
150 Sprint/V 1° serie • Vespa 150 Super 1° serie  
R.O. 91060, 98497, 130146, 131321, 131121,  
1313215



100012005 **NEW**



TIPO STANDARD | STANDARD TYPE

Valvola a disco rotante | Disc valve

Corsa 57,00 mm | Stroke 57,00 mm

Biella 110,00 mm | Connecting rod 110,00 mm

Spinotto Ø 16 mm | Ø 16 mm pin

Codice fornitore AMT 134 | Supplier product  
code AMT 134

Vespa 200 Rally VSE1T -> 33996

R.O. 122205, 123298, 131057



## ALBERI MOTORE - CRANKSHAFTS

100012006

NEW



ANTICIPATO | RACING

Valvola a disco rotante | Disc valve

Corso 57,00 mm | Stroke 57,00 mm

Biella 105,00 mm sport | Connecting rod  
105,00 mm sport

Spinotto Ø 15 mm | Ø 15 mm pin

TUNING ROAD - affidabile e per uso quotidiano

| TUNING ROAD - reliable and for daily use

Codice fornitore AMT 162 | Supplier product  
code AMT 162

Vespa P 125-150X • Vespa PX 125-150E • Vespa  
Lusso • Vespa MY • Vespa 125 GTR 2° serie •  
Vespa TS 2° serie • Vespa 150 Sprint V 2° serie  
• Vespa Super 2° serie



100012007

NEW



TIPO STANDARD | STANDARD TYPE

Valvola a disco rotante | Disc valve

Corso 57,00 mm | Stroke 57,00 mm

Biella 110,00 mm | Connecting rod 110,00 mm

Spinotto Ø 16 mm | Ø 16 mm pin

Fasatura 112°/6° a pms | Valve timing 112°/6°  
post TDCCodice fornitore AMT 164 | Supplier product  
code AMT 164

Vespa 200 Rally VSE1T 33997 -> • Vespa P  
200E • Vespa PX 200E • Vespa Lusso • Vespa  
MY • Cosa  
R.O. 238959



100012008 **NEW**



ANTICIPATO | *RACING*

Valvola a disco rotante | *Disc valve*

Corsa 57,00 mm | *Stroke 57,00 mm*

Biella 110,00 mm standard | *Connecting rod 110,00 mm standard*

Spinotto Ø 16 mm | *Ø 16 mm pin*

Fasatura 138°/6° a pms | *Valve timing 138°/6° post TDC*

TUNING ROAD - affidabile e per uso quotidiano | *TUNING ROAD - reliable and for daily use*

Codice fornitore AMT 166 | *Supplier product code AMT 166*

Vespa 200 Rally VSE1T 33997 -> • Vespa P 200E • Vespa PX 200E • Vespa Lusso • Vespa MY • Cosa



100012009 **NEW**



TIPO STANDARD | *STANDARD TYPE*

Valvola a disco rotante | *Disc valve*

Corsa 51,00 mm | *Stroke 51,00 mm*

Biella 97,00 mm | *Connecting rod 97,00 mm*

Cono 24/25 mm, M12 | *Cone 24/25 mm, M12*

Codice fornitore AMT 174 | *Supplier product code AMT 174*

Vespa PK 125 ETS • Vespa PK N • Vespa PK XL/ XL2

R.O. 2247885



## ALBERI MOTORE - CRANKSHAFTS

100012010

NEW



ANTICIPATO | RACING

Valvola a disco rotante | *Disc valve*Corsa 51,00 mm | *Stroke 51,00 mm*Biella 97,00 mm standard | *Connecting rod*  
*97,00 mm standard*Spinotto Ø 15 mm | *Ø 15 mm pin*Cono 24/25 mm, M12 | *Cone 24/25 mm, M12*

TUNING ROAD - affidabile e per uso quotidiano

| *TUNING ROAD - reliable and for daily use*Codice fornitore AMT 176 | *Supplier product*  
*code AMT 176*Vespa PK 125 ETS • Vespa PK N • Vespa PK XL/  
XL2

100012011

NEW

ANTICIPATO, RACE SUPER COMPETIZIONE |  
*RACING, SUPER COMPETITION*Valvola a disco rotante | *Disc valve*Corsa 51,00 mm | *Stroke 51,00 mm*Biella 97,00 mm standard | *Connecting rod*  
*97,00 mm standard*Spinotto Ø 15 mm | *Ø 15 mm pin*Cono 24/25 mm, M12 | *Cone 24/25 mm, M12*

TUNING ROAD - affidabile e per uso quotidiano

| *TUNING ROAD - reliable and for daily use*Codice fornitore AMT 178 | *Supplier product*  
*code AMT 178*Vespa PK 125 ETS • Vespa PK N • Vespa PK XL/  
XL2

100012012 **NEW**



TIPO STANDARD | *STANDARD TYPE*

Valvola a disco rotante | *Disc valve*

Corsa 43,00 mm | *Stroke 43,00 mm*

Biella 87,00 mm | *Connecting rod 87,00 mm*

Cono 20/20 mm, M12 | *Cone 20/20 mm, M12*

Codice fornitore AMT 026 | *Supplier product code AMT 026*

Vespa PK 50S • Vespa PK 50 SS • Vespa PK 50 XL/XL2/FL/HP/N/Rush

R.O. 224587



100012013 **NEW**



ANTICIPATO | *RACING*

Valvola a disco rotante | *Disc valve*

Corsa 43,00 mm | *Stroke 43,00 mm*

Biella 87,00 mm standard | *Connecting rod 87,00 mm standard*

Spinotto Ø 12 mm | *Ø 12 mm pin*

Cono 20/20 mm, M12 | *Cone 20/20 mm, M12*

TUNING ROAD - affidabile e per uso quotidiano

| *TUNING ROAD - reliable and for daily use*

Codice fornitore AMT 028 | *Supplier product code AMT 028*

Vespa PK 50S • Vespa PK 50 SS • Vespa PK 50 XL/XL2/FL/HP/N/Rush





## ALBERI MOTORE - CRANKSHAFTS

100012014

NEW



ANTICIPATO, RACE | RACING

Valvola a disco rotante | Disc valve

Corsa 43,00 mm | Stroke 43,00 mm

Biella 87,00 mm standard | Connecting rod  
87,00 mm standard

Cono 20/20 mm, M12 | Cone 20/20 mm, M12

TUNING ROAD - affidabile e per uso quotidiano

| TUNING ROAD - reliable and for daily use

Codice fornitore AMT 030 | Supplier product  
code AMT 030Vespa PK 50S • Vespa PK 50 SS • Vespa PK 50  
XL/XL2/FL/HP/N/Rush

## CILINDRI - CYLINDERS

### MOTORE PIAGGIO VESPA 50 CC - PIAGGIO VESPA ENGINE 50 CC

100080520 **NEW**



100080521



Ø 38,4 mm

Spinotto Ø 12 mm | Piston pin Ø 12 mm

3 Travasi | 3 Intake ports

Prigioniero scarico M6 | Stud outlet M6

Senza testa cilindro | No cylinder head

Vespa 50 tutti i modelli | All models of Vespa 50

R.O. 122457

#### RICAMBI | SPARE PARTS



100090520 - 38,4 mm

100090521 - 38,4 mm

100090529 - 39 mm



100100520 - 38,4 mm

100100521 - 38,4 mm



100684040



### MOTORE PIAGGIO VESPA/APE - PIAGGIO ENGINE VESPA/APE

100080280 **NEW**



100080281



Ø 47 mm

Spinotto Ø 12 mm | Piston pin Ø 12 mm

3 Travasi | 3 Intake ports

Corsa 43,00 mm | Stroke 43,00 mm

Prigioniero scarico M6 | Stud outlet M6

Testa cilindro inclusa | With cylinder head

Vespa 50 tutti i modelli | All models of Vespa 50

#### RICAMBI | SPARE PARTS



100090280 - 47 mm

100090281 - 47 mm

100090284 - 47,4 mm

100090285 - 47,4 mm

100090289 - 47,8 mm



100100280 - 47 mm

100100285 - 47,4 mm

100100288 - 47,8 mm

100100289 - 47,8 mm



-



100080270 **NEW**



100080271



Ø 50 mm

Spinotto Ø 12 mm | Piston pin Ø 12 mm

3 Travasi | 3 Intake ports

Corsa 43,00 mm | Stroke 43,00 mm

Prigioniero scarico M6 | Stud outlet M6

Testa cilindro inclusa | With cylinder head

Vespa 50 tutti i modelli | All models of Vespa 50

#### RICAMBI | SPARE PARTS



100090270 - 50 mm

100090271 - 50 mm

100090275 - 50,4 mm

100090278 - 50,8 mm

100090279 - 50,8 mm



100100270 - 50 mm

100100271 - 50 mm

100100274 - 50,4 mm

100100275 - 50,4 mm

100100278 - 50,8 mm

100100279 - 50,8 mm



-



## CILINDRI - CYLINDERS

100080140 **NEW**

Ø 55 mm  
 Spinotto Ø 12 mm | Piston pin Ø 12 mm  
 6 Travasi | 6 Intake ports  
 Corsa 43,00 mm | Stroke 43,00 mm  
 Prigioniero scarico M6 | Stud outlet M6  
 Testa cilindro inclusa | With cylinder head  
 Vespa 50 tutti i modelli | All models of Vespa 50

## RICAMBI | SPARE PARTS



100090140 - 55 mm  
 100090141 - 55 mm  
 100090145 - 55,4 mm  
 100090149 - 55,8 mm



100100140 - 55 mm  
 100100141 - 55 mm  
 100100145 - 55,4 mm  
 100100148 - 55,8 mm  
 100100149 - 55,8 mm



## MOTORE PIAGGIO VESPA PX 125 CC - PIAGGIO VESPA PX ENGINE 125 CC

100080680

**GOETZE®**

Ø 52,5 mm  
 Fasce pistone da 2,5 mm | Piston rings 2,5 mm  
 Spinotto Ø 15 mm | Piston pin Ø 15 mm  
 Vespa PX 125 • Cosa 125  
 R.O. 840087

## RICAMBI | SPARE PARTS



100090680 - 52,5 mm  
 100090684 - 52,9 mm  
 100090686 - 53,1 mm



-



100684110



100080630

**GOETZE®**

Ø 57,8 mm  
 Fasce pistone da 2 mm | Piston rings 2 mm  
 Spinotto Ø 15 mm | Piston pin Ø 15 mm  
 LML 150 2T • Vespa PX 150

## RICAMBI | SPARE PARTS



GOETZE  
 100090630 - 57,8 mm  
 100090632 - 58,0 mm  
 100090634 - 58,2 mm



-



100684110



## CILINDRI - CYLINDERS

### MOTORE LML 150 CC 2T - LML ENGINE 150 CC 2 STROKES

100080670



**GOETZE®**

Ø 57,8 mm

Fasce pistone da 2 mm | *Piston rings 2 mm*

Spinotto Ø 15 mm | *Piston pin Ø 15 mm*

Vespa PX 150 • Cosa 150

R.O. 244172, 241615

#### RICAMBI | SPARE PARTS



100090670 - 57,8 mm

100090676 - 58,4 mm

100090678 - 58,6 mm



-



100680630



### MOTORE PIAGGIO VESPA PX - PE 150 CC - PIAGGIO VESPA PX - PE ENGINE 150 CC

100080660



**GOETZE®**

Ø 57 mm

2 Travasi | *2 Intake ports*

Fasce pistone da 2,5 mm | *Piston rings 2,5 mm*

Spinotto Ø 15 mm | *Piston pin Ø 15 mm*

Vespa Super • Vespa Sprint • Vespa GL 150

Adattabile a - *Suitable for Vespa 150 2% ('59)*

• Vespa 125 VNB1-6 • Vespa GT • Vespa GTR •

Vespa TS • Vespa VBA-VBB

R.O. 134893

#### RICAMBI | SPARE PARTS



100090660 - 57,0 mm

100090664 - 57,4 mm

100090666 - 57,8 mm



-



100684110

100680630



### MOTORE PIAGGIO VESPA PX 200 CC - PIAGGIO VESPA PX ENGINE 200 CC

100080810 **NEW**



Ø 66,5 mm

Fasce pistone da 2,5 mm | *Piston rings 2,5 mm*

Spinotto Ø 15 mm | *Piston pin Ø 15 mm*

Vespa 200 Rally • Cosa 1-2 • Vespa PX 200

R.O. 414708



## CILINDRI EVOK - EVOK CYLINDERS

## MOTORE PIAGGIO VESPA PK 125 CC - PIAGGIO VESPA PK ENGINE 125 CC

100081160

**EVOX**

Ø55 mm  
 Spinotto Ø15 mm | Piston pin Ø 15 mm  
 3 travasi | 3 intake ports  
 Corsa 51,00 mm | Stroke 51,00 mm  
 Biella 97 mm | Connecting rod 97 mm  
 Prigionieri 8 mm | Stud 8 mm  
 Interasse prigionieri 56 mm | Stud wheelbase 56 mm  
 Candela inclusa | Spark plug included  
 Vespa PK 125  
 Adattabile a - Suitable for Vespa 125 Primavera ET3  
 R.O. 196771

## RICAMBI | SPARE PARTS



100091164 - 55,4 mm  
 100091166 - 55,6 mm



100101160 - 55 mm



## MOTORE PIAGGIO VESPA PRIMAVERA 125 CC - PIAGGIO ENGINE VESPA PRIMAVERA 125 CC

100081180

**EVOX**

Ø55 mm  
 2 Travasi | 2 Intake ports  
 Corsa 51,00 mm | Stroke 51,00 mm  
 Biella 97 mm | Connecting rod 97 mm  
 Prigioniero 6 mm | Stud 6 mm  
 Senza testa cilindro | No cylinder head  
 Candela inclusa | Spark plug included  
 Vespa 125 Primavera ('67-'78)  
 R.O. 151981

## RICAMBI | SPARE PARTS



100091164 - 55,4 mm  
 100091166 - 55,6 mm



100101160 - 55 mm



## MOTORE PIAGGIO VESPA PE 200 CC - PIAGGIO VESPA PE ENGINE 200 CC

100081190

**EVOX**

Ø66,5 mm  
 3 Travasi | 3 Intake ports  
 Corsa 57 mm | 57 mm stroke  
 Ghiera scarico inclusa | Exhaust connector included  
 Candela inclusa | Spark plug included  
 Vespa 200 Rally • Cosa 1-2 • Vespa PX 200  
 R.O. 414708

## RICAMBI | SPARE PARTS



-



-



100684100



## TESTE CILINDRO - CYLINDER HEADS

**100070123**



PER CILINDRO LML 100080630 | FOR LML  
CYLINDER 100080630

Vespa VBA-VBB • Vespa GL • Vespa Super •  
Vespa Sprint • Vespa PX • LML 2 Tempi



**100070140** **NEW**



Per cilindro maggiorato Vespa 50 Ø55 mm |  
For Vespa 50 big bore Ø55 mm

Materiale Alluminio | Material Aluminium

Vespa 50 N/L/R • Vespa 50 Special • Vespa 50  
PK S/XL/XL2 • Vespa HP FL



**100070270** **NEW**



Per cilindro maggiorato Vespa 50 Ø50 mm |  
For Vespa 50 big bore Ø50 mm

Materiale Alluminio | Material Aluminium

Vespa 50 N/L/R • Vespa 50 Special • Vespa 50  
PK S/XL/XL2 • Vespa HP FL



**100070280** **NEW**



Per cilindro maggiorato Vespa 50 Ø47 mm |  
For Vespa 50 big bore Ø47 mm

Materiale Alluminio | Material Aluminium

Vespa 50 N/L/R • Vespa 50 Special • Vespa 50  
PK S/XL/XL2 • Vespa HP FL



**100070520** **NEW**



**100070521**











































PER CILINDRO PIAGGIO 100080521 E  
100080520 | FOR PIAGGIO CYLINDER  
100080521

Per cilindri Vespa 50 Ø38,4 mm | For Vespa 50  
cylinders Ø38,4 mm

Vespa 50 tutti i modelli | All models Vespa 50  
R.O. 112515











## PISTONI - FASCE ELASTICHE - PISTON - PISTON RINGS

Applicazioni <i>Applications</i>	CC	PISTONI COMPLETI PER CILINDRI RMS <i>PISTONS FOR RMS CYLINDERS</i>			KIT FASCE ELASTICHE PER PISTONI RMS <i>PISTON RINGS FOR RMS PISTONS</i>		
		Ø pistone mm <i>Ø piston mm</i>	Codice RMS <i>RMS Code</i>	Codice a barre <i>Barcode</i>	Ø fasce elastiche mm <i>Ø piston rings mm</i>	Codice RMS <i>RMS Code</i>	Codice a barre <i>Barcode</i>
Motore Piaggio Vespa 50cc 2T raffreddato ad aria - Cilindro 100080521   <i>Piaggio Vespa engine 50 cc 2 Stroke air cooled - Cylinder 100080521</i>	50	38,4	100090521		38,4	100100521	
Motore Piaggio Vespa 50cc 2T raffreddato ad aria - Cilindro 100080520   <i>Piaggio Vespa engine 50 cc 2 Stroke air cooled - Cylinder 100080520</i>	50	38,4	100090520		38,4	100100520	
		39	100090529		39	100100529	
Motore Piaggio Vespa/Ape 75cc 2T raffreddato ad aria - Cilindro 100080281   <i>Piaggio Vespa/Ape engine 75cc 2 Stroke air cooled - Cylinder 100080281</i>	75	47	100090280		47 x 1,5	100100280	
Motore Piaggio Vespa/Ape 75cc 2T raffreddato ad aria - Cilindro 100080280   <i>Piaggio Vespa/Ape engine 75cc 2 Stroke air cooled - Cylinder 100080280</i>	75	47	100090281		47 x 1,5	100100280	
		47,4	100090284		47,4 x 1,5	100100284	
Motore Piaggio Vespa/Ape 75cc 2T raffreddato ad aria - Cilindro 100080280   <i>Piaggio Vespa/Ape engine 75cc 2 Stroke air cooled - Cylinder 100080280</i>	75	47,4	100090285		47,4 x 1,5	100100284	
		47,8	100090288		47,8 x 1,5	100100288	
Motore Piaggio Vespa/Ape 75cc 2T raffreddato ad aria - Cilindro 100080280   <i>Piaggio Vespa/Ape engine 75cc 2 Stroke air cooled - Cylinder 100080280</i>	75	47,8	1000902889		47,8 x 1,5	100100288	
Motore Piaggio Vespa/Ape 85cc 2T raffreddato ad aria - Cilindro 100080270   <i>Piaggio Vespa/Ape engine 85cc 2 Stroke air cooled - Cylinder 100080270</i>	85	50	100090270		50 x 1,5	100100270	
Motore Piaggio Vespa/Ape 85cc 2T raffreddato ad aria - Cilindro 100080271   <i>Piaggio Vespa/Ape engine 85cc 2 Stroke air cooled - Cylinder 100080271</i>	85	50	100090271		50 x 1,5	100100271	
Motore Piaggio Vespa/Ape 85cc 2T raffreddato ad aria - Cilindro 100080270   <i>Piaggio Vespa/Ape engine 85cc 2 Stroke air cooled - Cylinder 100080270</i>	85	50,4	100090275		50,4 x 1,5	100090275	
Motore Piaggio Vespa/Ape 85cc 2T raffreddato ad aria - Cilindro 100080271   <i>Piaggio Vespa/Ape engine 85cc 2 Stroke air cooled - Cylinder 100080271</i>	85	50,8	100090278		50,8 x 1,5	100100278	
Motore Piaggio Vespa/Ape 85cc 2T raffreddato ad aria - Cilindro 100080270   <i>Piaggio Vespa/Ape engine 85cc 2 Stroke air cooled - Cylinder 100080270</i>	85	50,8	100090279		50,8 x 1,5	100100279	
Motore Piaggio Vespa/Ape 100cc 2T raffreddato ad aria - Cilindro 100080140   <i>Piaggio Vespa/Ape engine 100cc 2 Stroke air cooled - Cylinder 100080140</i>	100	55	100090140		55 x 1,5	100100140	
Motore Piaggio Vespa/Ape 100cc 2T raffreddato ad aria - Cilindro 100080141   <i>Piaggio Vespa/Ape engine 100cc 2 Stroke air cooled - Cylinder 100080141</i>	100	55	100090141		55 x 1,5	100100141	
Motore Piaggio Vespa/Ape 100cc 2T raffreddato ad aria - Cilindro 100080140   <i>Piaggio Vespa/Ape engine 100cc 2 Stroke air cooled - Cylinder 100080140</i>	100	55,4	100090145		55,4 x 1,5	100090145	
Motore Piaggio Vespa/Ape 100cc 2T raffreddato ad aria - Cilindro 100080140   <i>Piaggio Vespa/Ape engine 100cc 2 Stroke air cooled - Cylinder 100080140</i>	100	55,8	100090149		55,8 x 1,5	100090149	
Motore Piaggio Vespa PX 125cc - Fasce da 2,5 mm - Cilindro 100080680   <i>Piaggio Vespa PX engine 125cc - Piston rings 2,5 mm - Cylinder 100080680</i>	125	52,5	100090680		-	-	-
Motore Piaggio Vespa PX 125cc - Fasce da 2,5 mm - Cilindro 100080680   <i>Piaggio Vespa PX engine 125cc - Piston rings 2,5 mm - Cylinder 100080680</i>	125	52,9	100090684		-	-	-
		53,1	100090686		-	-	-
Motore LML 150cc 2T raffreddato ad aria - Fasce da 2 mm - Cilindro 100080630   <i>LML engine 150cc 2 Stroke air cooled - Piston rings 2 mm - Cylinder 100080630</i>	150	57,8	100090630		-	-	-



## PISTONI - FASCE ELASTICHE - PISTON - PISTON RINGS

Applicazioni <i>Applications</i>	CC	PISTONI COMPLETI PER CILINDRI RMS <i>PISTONS FOR RMS CYLINDERS</i>			KIT FASCE ELASTICHE PER PISTONI RMS <i>PISTON RINGS FOR RMS PISTONS</i>		
		Ø pistone mm <i>Ø piston mm</i>	Codice RMS <i>RMS Code</i>	Codice a barre <i>Barcode</i>	Ø fasce elastiche mm <i>Ø piston rings mm</i>	Codice RMS <i>RMS Code</i>	Codice a barre <i>Barcode</i>
Motore LML 150cc 2T raffreddato ad aria - Fasce da 2 mm - Cilindro 100080630   <i>LML engine 150cc 2 Stroke air cooled - Piston rings 2 mm - Cylinder 100080630</i>	150	58	100090632		-	-	-
		58,2	100090634		-	-	-
Motore Piaggio Vespa PX-Sprint 150cc   <i>Piaggio Vespa PX-Sprint engine 150cc</i>	150	57,6	100090416		-	-	-
Motore Piaggio Vespa PX-PE 150cc raffreddato ad aria - Fasce da 2 mm - Cilindro 100080670   <i>Piaggio Vespa PX-PE engine 150cc air cooled - Piston rings 2 mm - Cylinder 100080670</i>	150	57,8	100090670		-	-	-
Motore Piaggio Vespa PX-PE 150cc raffreddato ad aria - Fasce da 2 mm - Cilindro 100080670   <i>Piaggio Vespa PX-PE engine 150cc air cooled - Piston rings 2 mm - Cylinder 100080670</i>	150	58,4	100090676		-	-	-
		58,6	100090678		-	-	-
Motore Piaggio Vespa Sprint 150cc - Fasce da 2,5 mm - Cilindro 100080660   <i>Piaggio Vespa Sprint engine 150cc - Piston rings 2,5 mm - Cylinder 100080660</i>	150	57	100090660		-	-	-
Motore Piaggio Vespa Sprint 150cc - Fasce da 2,5 mm - Cilindro 100080660   <i>Piaggio Vespa Sprint engine 150cc - Piston rings 2,5 mm - Cylinder 100080660</i>	150	57,4	100090664		-	-	-
		57,6	100090666		-	-	-



## CARTER MOTORE - CRANKCASE

100170013



Carter Motore 3 travasi | *Crankcase with 3 intake ports*

Vespa PX 125-150  
R.O. 8410315





## KIT REVISIONE ALBERO MOTORE - CRANKSHAFT REVISION KIT

**100200730**

Vespa PX 125-150-200

1	Cuscinetto a sfere SKF   <i>SKF ball bearing</i>	BB1-0855 25-62-12
1	Cuscinetto a rulli Nadella   <i>Nadella roller bearing</i>	25-38-15
1	Paraolio lato volano   <i>Flywheel oil seal</i>	24-35-6
1	Paraolio lato frizione   <i>Clutch oil seal</i>	31-62-4.3/5.8 Metallo/ gomma   <i>Metal/rubber</i>

**100200740**

Vespa PX 125-150-200

1	Cuscinetto a sfere Nadella   <i>Nadella ball bearing</i>	25-62-12
1	Cuscinetto a rulli Nadella   <i>Nadella roller bearing</i>	25-38-15
1	Paraolio lato volano   <i>Flywheel oil seal</i>	24-35-6
1	Paraolio lato frizione   <i>Clutch oil seal</i>	31-62-4.3/5.8

**100200743**Vespa Sprint • Vespa 150 GL • Vespa Super •  
Vespa GTR • Vespa VNB-VBB

2	Cuscinetto a sfere Nadella   <i>Nadella ball bearing</i>	25-62-12
1	Paraolio lato volano   <i>Flywheel oil seal</i>	20-40/60-6
1	Paraolio lato frizione   <i>Clutch oil seal</i>	20-62-6,5



## KIT REVISIONE ALBERO MOTORE - CRANKSHAFT REVISION KIT

**100200750**



Vespa 50-90

1	Cuscinetto a sfere SKF   <i>SKF ball bearing</i>	6204 C5 17-47-14
1	Cuscinetto a sfere SKF   <i>SKF ball bearing</i>	6303 C3 20-47-14
1	Paraolio lato frizione   <i>Clutch oil seal</i>	22,7-47-7/7.5
1	Paraolio lato volano   <i>Flywheel oil seal</i>	19-32-7



**100200760**



Vespa ET3 • Vespa 125 Primavera

1	Cuscinetto a rulli ISB   <i>ISB roller bearing</i>	N 204 ECJ 20-47-14
1	Cuscinetto a sfere SKF   <i>SKF ball bearing</i>	6303 C3 17-47-14
1	Paraolio lato frizione   <i>Clutch oil seal</i>	22,7-47-7/7.5
1	Paraolio lato volano   <i>Flywheel oil seal</i>	19-32-7



**100200790**



Vespa PK 50-125XL

1	Cuscinetto a sfere SKF   <i>SKF ball bearing</i>	6303 17-47-14
1	Cuscinetto a sfere SKF   <i>SKF ball bearing</i>	6204 C5 20-47-14
1	Paraolio   <i>Oil seal</i>	22,7-47-7/7.5
1	Paraolio   <i>Oil seal</i>	20-47-14



## KIT REVISIONE ALBERO MOTORE - CRANKSHAFT REVISION KIT

**100200810**

Vespa 50-90 • Vespa 125 Primavera

1	Cuscinetto a sfere SKF   SKF ball bearing	6204 C5 20-47-14
1	Cuscinetto a sfere SKF   SKF ball bearing	6303 C3 17-47-14
1	Paraolio Blu   Blue Oil seal	22,7-47-7/7,5
1	Paraolio Blu   Blue Oil seal	19-32-7
1	Paraolio Blu   Blue Oil seal	27-37-7
1	Anello   O Ring	15,88-2,62
1	Anello   O Ring	6,75-2
2	Anello   O Ring	12,5-2,4
1	Anello   O Ring	8,73-1,78

**100200820**

Vespa PK 50-125 XL

1	Cuscinetto a sfere SKF   SKF ball bearing	6204 C5 20-47-14
1	Cuscinetto a sfere SKF   SKF ball bearing	6303 C3 17-47-14
1	Paraolio Blu   Blue Oil seal	22,7-47-7/7,5
1	Paraolio Blu   Blue Oil seal	20-32-7
1	Paraolio Blu   Blue Oil seal	27-37-7
1	Anello   O Ring	15,88-2,62
1	Anello   O Ring	6,75-2
2	Anello   O Ring	12,5-2,4
1	Anello   O Ring	8,73-1,78

**100200830**

Vespa 50-90 • Vespa 125 Primavera • Vespa ET3

1	Cuscinetto a sfere SKF   SKF ball bearing	N 204 ECJ 20-47-14
1	Cuscinetto a sfere SKF   SKF ball bearing	6303 C3 17-47-14
1	Paraolio Blu   Blue Oil seal	22,7-47-7/7,5
1	Paraolio Blu   Blue Oil seal	19-32-7
1	Paraolio Blu   Blue Oil seal	30-47-6
1	Anello   O Ring	15,88-2,62
1	Anello   O Ring	6,75-2
2	Anello   O Ring	12,5-2,4
1	Anello   O Ring	8,73-1,78



## KIT REVISIONE ALBERO MOTORE - CRANKSHAFT REVISION KIT

**100200840**



Vespa PX 125-150-200

1	Cuscinetto a rulli Nadella   <i>Nadella roller bearing</i>	25-38-15
1	Cuscinetto a sfere SKF   <i>SKF ball bearing</i>	BB1-0855 25-62-12
1	Paraolio Blu   <i>Blue Oil seal</i>	24-35-6
1	Paraolio Blu   <i>Blue Oil seal</i>	31-62-4,3/5,8
1	Paraolio Blu   <i>Blue Oil seal</i>	27-47-6
1	Anello   <i>O Ring</i>	15,88-2,62
1	Anello   <i>O Ring</i>	6,75-2
1	Anello   <i>O Ring</i>	11,11-1,78
1	Anello   <i>O Ring</i>	123-2,1



**100200850**



Vespa Sprint • Vespa 150 GL • Vespa Super •  
Vespa GTR • Vespa VNB-VBB

2	Cuscinetto a sfere Nadella   <i>Nadella ball bearing</i>	25-62-12
1	Paraolio Blu   <i>Blue Oil seal</i>	20-62-6,5
1	Paraolio Blu   <i>Blue Oil seal</i>	20-40/60-6
1	Paraolio Blu   <i>Blue Oil seal</i>	27-37-7
1	Anello   <i>O Ring</i>	15,88-2,62
1	Anello   <i>O Ring</i>	6,75-2
1	Anello   <i>O Ring</i>	11,11-1,78
1	Anello   <i>O Ring</i>	123-2,1



**100200860**



Vespa PX 125-150

1	Cuscinetto a rulli Nadella   <i>Nadella roller bearing</i>	25-38-15
1	Cuscinetto a sfere SKF   <i>SKF ball bearing</i>	BB1-0855 25-62-12
1	Paraolio Blu   <i>Blue Oil seal</i>	31-62-4,3/5,8
1	Paraolio Blu   <i>Blue Oil seal</i>	24-35-6
1	Paraolio Blu   <i>Blue Oil seal</i>	30-47-6
1	Anello   <i>O Ring</i>	15,88-2,62
1	Anello   <i>O Ring</i>	6,75-2
1	Anello   <i>O Ring</i>	11,11-1,78
1	Anello   <i>O Ring</i>	123-2,1



## KIT REVISIONE ALBERO MOTORE - CRANKSHAFT REVISION KIT

**100201500** **NEW**

Vespa 125 VNA2 2° serie • Vespa VNB 3-4-5-6 •  
 Vespa 125 GT 1° serie • Vespa 125 GTR 1° serie  
 • Vespa 150 VBA 2° serie • Vespa 150 VBB •  
 Vespa 150 GL • Vespa 150 SPRINT 1°/ serie

2	Cuscinetto a sfere SKF   <i>SKF ball bearing</i>	BB1-0855 25-62-12
1	Paraolio Blu Corteco   <i>Corteco Blue Oil seal</i>	20-40-6
1	Paraolio Blu Corteco   <i>Corteco Blue Oil seal</i>	20-62-6,5
1	Kit O-Ring	-

**100201510** **NEW**

Vespa 50 N-L-R • Vespa 50 Special • Vespa 90  
 • Vespa 125 Primavera • Vespa 125 Primavera  
 ET3 • PK50-125 1° serie • PK50SS

1	Cuscinetto a sfere SKF   <i>SKF ball bearing</i>	6204 C3 20-47-14
1	Cuscinetto a sfere SKF   <i>SKF ball bearing</i>	6303 C3 17-47-14
1	Paraolio Blu Corteco   <i>Corteco Blue Oil seal</i>	22,7-47-7
1	Paraolio Blu Corteco   <i>Corteco Blue Oil seal</i>	19-32-7
1	Anello   <i>O Ring</i>	6,75-2
1	Anello   <i>O Ring</i>	8,73-1,78
2	Anello   <i>O Ring</i>	12,5-2,4
1	Anello   <i>O Ring</i>	15,88-2,62

**100201515** **NEW**

Vespa 50 N-L-R • Vespa 50 Special • Vespa 90  
 • Vespa 125 Primavera • Vespa 125 Primavera  
 ET3 • PK50-125 1° serie • PK50SS

1	Cuscinetto a sfere SKF   <i>SKF ball bearing</i>	6204 C3 20-47-14
1	Cuscinetto a sfere SKF   <i>SKF ball bearing</i>	6303 C3 17-47-14
1	Paraolio Viton Corteco   <i>Corteco Viton Oil seal</i>	22,7-47-7
1	Paraolio Viton Corteco   <i>Corteco Viton Oil seal</i>	19-32-7
1	Anello   <i>O Ring</i>	6,75-2
1	Anello   <i>O Ring</i>	8,73-1,78
2	Anello   <i>O Ring</i>	12,5-2,4
1	Anello   <i>O Ring</i>	15,88-2,62



## KIT REVISIONE ALBERO MOTORE - CRANKSHAFT REVISION KIT

**100201520** **NEW**



Vespa PK 50 XL • Vespa FL • Vespa HP

1	Cuscinetto a sfere SKF   SKF ball bearing	6204 C3 20-47-14
1	Cuscinetto a sfere SKF   SKF ball bearing	6303 C3 17-47-14
1	Paraolio Blu Corteco   Corteco Blue Oil seal	22,7-47-7
1	Paraolio Blu Corteco   Corteco Blue Oil seal	20-32-7
1	Anello   O Ring	6,75-2
1	Anello   O Ring	8,73-1,78
2	Anello   O Ring	12,5-2,4
1	Anello   O Ring	15,88-2,62



**100201525** **NEW**



Vespa PK 50 XL • Vespa FL • Vespa HP

1	Cuscinetto a sfere SKF   SKF ball bearing	6204 C3 20-47-14
1	Cuscinetto a sfere SKF   SKF ball bearing	6303 C3 17-47-14
1	Paraolio Viton Corteco   Corteco Viton Oil seal	22,7-47-7
1	Paraolio Viton Corteco   Corteco Viton Oil seal	20-32-7
1	Anello   O Ring	6,75-2
1	Anello   O Ring	8,73-1,78
2	Anello   O Ring	12,5-2,4
1	Anello   O Ring	15,88-2,62



**100201530** **NEW**



Vespa PK 50 XL • Vespa FL • Vespa HP

1	Cuscinetto a rulli ISB   ISB roller bearing	N 204 ECJ 20-47-14
1	Cuscinetto a sfere SKF   SKF ball bearing	6303 C3 17-47-14
1	Paraolio Blu Corteco   Corteco Blue Oil seal	22,7-47-7
1	Paraolio Blu Corteco   Corteco Blue Oil seal	20-32-7
1	Anello   O Ring	6,75-2
1	Anello   O Ring	8,73-1,78
2	Anello   O Ring	12,5-2,4
1	Anello   O Ring	15,88-2,62



## KIT REVISIONE ALBERO MOTORE - CRANKSHAFT REVISION KIT

100201535

NEW



Vespa PK 50 XL • Vespa FL • Vespa HP

1	Cuscinetto a rulli ISB   <i>ISB roller bearing</i>	N 204 ECJ 20-47-14
1	Cuscinetto a sfere SKF   <i>SKF ball bearing</i>	6303 C3 17-47-14
1	Paraolio Viton Corteco   <i>Corteco Viton Oil seal</i>	22,7-47-7
1	Paraolio Viton Corteco   <i>Corteco Viton Oil seal</i>	20-32-7
1	Anello   <i>O Ring</i>	6,75-2
1	Anello   <i>O Ring</i>	8,73-1,78
2	Anello   <i>O Ring</i>	12,5-2,4
1	Anello   <i>O Ring</i>	15,88-2,62



100201550

NEW

Vespa 125 GTR 2°serie • Vespa 125 TS 2°serie  
• Vespa 150 Sprint • Vespa 150 Super • Vespa Rally • Vespa PX80-200/PE/Lusso • Cosa 1/2 125-150 200

1	Cuscinetto a rulli Nadella   <i>Nadella roller bearing</i>	25-38-15
1	Cuscinetto a sfere SKF   <i>SKF ball bearing</i>	BB1-0855 25-62-12
1	Paraolio Blu Corteco   <i>Corteco Blue Oil seal</i>	24-35-6
1	Paraolio Blu Corteco   <i>Corteco Blue Oil seal</i>	31-62-4,3/5,8
1	Kit O-Ring	-



100201555

NEW

Vespa 125 GTR 2°serie • Vespa 125 TS 2°serie  
• Vespa 150 Sprint • Vespa 150 Super • Vespa Rally • Vespa PX80-200/PE/Lusso • Cosa 1/2 125-150 200

1	Cuscinetto a rulli Nadella   <i>Nadella roller bearing</i>	25-38-15
1	Cuscinetto a sfere SKF   <i>SKF ball bearing</i>	BB1-0855 25-62-12
1	Paraolio Blu Corteco   <i>Corteco Blue Oil seal</i>	24-35-6
1	Paraolio Viton Corteco   <i>Corteco Viton Oil seal</i>	31-62-4,3/5,8
1	Kit O-Ring	-



## SERBATOIO OLIO - OIL TANK

**121730033**



SERBATOIO OLIO | OIL TANK

Con indicatore livello carburante | *With fuel lever indicator*

Vespa PX 125-150-200 Arcobaleno • Vespa 125 T5 • Vespa 200 Rally  
R.O. 297175



## ACCESSORI SERBATOIO OLIO - OIL TANKS ACCESSORIES

**121710020**



SPIA OLIO VESPA | OIL BOWL

Confezione 5 Pz. | *5 Pcs Packing*

Vespa PX PE 125-150-200 Arcobaleno • Vespa 125 T5 • Vespa Rally  
R.O.623140, 155526



**121650053**



TAPPO OLIO MISCELATORE | OIL TANK CAP

Vespa PX 125-150-200 Arcobaleno • Vespa T5 • Vespa 200 Rally  
R.O. 102585



**121678010**



RACCORDO OLIO | OIL PIPE CONNECTING PIECE

Vespa PK • Vespa FL2 Plurimatic • Cosa 125-150-200  
R.O. 574362, 197572



**121830023** **NEW**



GOMMINO TELATO SPIA OLIO | OIL GAUGE GASKET VESPA

Vespa PX 80-200 • Vespa PE • Vespa Lusso • Vespa PX 125 T5 • Vespa Rally  
R.O. 102586





## ACCESSORI SERBATOI OLIO - OIL TANKS ACCESSORIES

**121856070**TAPPO SCARICO OLIO MOTORE | *ENGINE OIL CUP*

M8x8 mm

Confezione 5 Pz. | *5 Pcs Packing*

Vespa 50-90 • Vespa 125 Primavera ET3 •

Vespa PK 50-125S • Vespa PK XL

Vespa tutti i modelli | *All models*

R.O. 138345

**121860010**TAPPO OLIO | *OIL PLUG*

M8x10 mm

Confezione 10 Pz. | *10 Pcs Packing*

Vespa PX 80-200 • Vespa PE • Vespa Lusso •

Vespa T5 • Cosa 1 • Vespa large frame

R.O. 030280

**121856200****NEW**SET TAPPO E RONDELLA DI SCARICO OLIO  
MOTORE | *ENGINE OIL DRAIN PLUG AND  
WASHER SET*

Vespa 50-90 • Vespa 125 Primavera ET3

R.O. 138345, 485703

**121856201****NEW**TAPPO SCARICO OLIO MOTORE | *ENGINE OIL CUP*

M8x8 mm

Confezione 5 Pz. | *5 Pcs Packing*

Vespa 50-90 • Vespa 125 Primavera ET3 •

Vespa PK 50-125S • Vespa PK XL

Vespa tutti i modelli | *All models*

R.O. 138345, 485703



## ACCESSORI SERBATOI OLIO - OIL TANKS ACCESSORIES

121856202 **NEW**



RONDELLA IN RAME | COPPER MADE WASHER

8,2x12x1 mm

Vespa tutti i modelli | All Vespa models



## INGRANAGGI AVVIAMENTO - STARTER GEARS

### SETTORI MESSA IN MOTO - KICK STARTER SECTOR

100250030 **NEW**



11 denti | 11 teeth

Vespa P 80X • Vespa P 125X • Vespa P 150X •

Vespa P 150S • Vespa P 200E • Vespa PX PE

Arcobaleno • Cosa

R.O. 148570



100250661 **NEW**



11 denti | 11 teeth

Vespa 150 GL-Sprint

R.O. 140920



100250670



12 denti | 12 teeth

Vespa 50 S • Vespa 50 R • Vespa PK 50 • Vespa

SS

R.O. 79734



## INGRANAGGI AVVIAMENTO - STARTER GEARS

## INGRANAGGI MESSA IN MOTO - STARTER GEARS

**100250393**INGRANAGGIO MESSA IN MOTO | KICK STARTER  
GEAR

Z12, Foro Ø20,5 mm | Z12, Hole Ø20,5 mm

Vespa P 125X ('77-'82) dal telaio n. 146314 -  
from chassis n. 146314 • Vespa P 150X ('78-'81)  
dal telaio n. 264565 - from chassis n. 264565  
• Vespa P 125E ('81) • Vespa P 200E • Vespa PX  
PE Arcobaleno • Vespa 125 T5 • Vespa Rally •  
Cosa  
R.O. 113526**100250403**INGRANAGGIO MESSA IN MOTO | KICK STARTER  
GEAR

Z12, Foro Ø21,8 mm | Z12, Hole Ø21,8 mm

Vespa P 125X ('77-'82) fino al telaio n. 146313 -  
till chassis n. 146313 • Vespa P 150X ('78 - '81)  
fino al telaio n. 264564 - till chassis n. 264564  
• Vespa 150 Sprint • Vespa GTR • Vespa 150  
Super • Vespa 125 TS • Vespa GL  
R.O. 089229**100250413**INGRANAGGIO MESSA IN MOTO | KICK STARTER  
GEAR

Z12-13, Foro Ø22 mm | Z12-13, Hole Ø22 mm

Vespa 125 Super ('66-'68) • Vespa 150 Super  
( '66-'79) • Vespa P 150S ('78>) • Vespa 150  
(VBB1-VBB2)  
R.O. 058680**100250423**INGRANAGGIO MESSA IN MOTO | KICK STARTER  
GEAR

Z12, Foro Ø22 mm | Z12, Hole Ø22 mm

Vespa 150 ('59-'61)  
R.O. 089026

## INGRANAGGI AVVIAMENTO - STARTER GEARS

**100250430** **NEW**



INGRANAGGIO MESSA IN MOTO | *KICK STARTER GEAR*

Z12, 10 innesti, Foro Ø20,5 mm | Z12, 10 grafts, Hole Ø20,5 mm

Vespa 50 • Vespa 125 Primavera • Vespa 125 Primavera ET3 • Vespa PK 50-125/S/XL/XL2  
R.O. 078473, 78473, 132495, 078473, 0784735, 0784736



## PIGNONI MESSA IN MOTO - PINION STARTERS

**100254660**



Vespa PXE 125-150-200 Arcobaleno ('81-'97)  
• Vespa PK 50XL ('85-'88) • PK 50XL Rush ('88-'89) • Vespa PK 125XL ('86-'89) • Vespa PK 50-125 ('82-'84) • Vespa PK 50S • Vespa 50-125 Automatica ('84-'89) • Vespa PK 50XL Plurimatic ('85-'90) • Vespa 50 N ('89-'90) • Vespa 50 FL ('90) • Vespa 125 FL ('89-'90) • Vespa 50 FL2 HP ('91-'97) • Vespa 50 FL2 Automatica ('90-'91)  
• Cosa 2 125-150-200 ('91-'97) • Vespa CL-CLX 125-150-200 ('88-'91)  
R.O. 248293



## MOLLE MESSA IN MOTO - STARTER SPRINGS

**121930050**MOLLA MESSA IN MOTO | *STARTER SPRING*Confezione 5 Pz | *5 Pcs Packing*

Vespa PX 125-150-200 • Vespa T5 • Vespa GL •

Vespa TS • Vespa Sprint

R.O. 047218

**121930060**MOLLA MESSA IN MOTO | *STARTER SPRING*Confezione 5 Pz | *5 Pcs Packing*

Vespa 50-90 • Vespa 125 Primavera • Vespa

ET3

R.O. 078478

**121930070**

MOLLA INGRANAGGIO MESSA IN MOTO |

*STARTER GEAR SPRING*Confezione 20 Pz | *20 Pcs Packing*

Vespa PX 125-150-200 • Vespa T5 • Vespa GL •

Vespa TS • Vespa Sprint

R.O. 139100



## PRIGIONIERI MOTORE - ENGINE STUDS

### VITI CARTER MOTORE - CRANKCASE BOLTS



Dimensioni Dimensions	Applicazioni Applications	Pezzi Pcs	OEM	Codice RMS RMS Code	Codice a Barre Barcode
M7 x 45 mm	Vespa 50-90-125 • Vespa Primavera ET3	5	008420	121858660	
M7 x 50 mm	Vespa PX	5	239149	121858690	
M7 x 52 mm	Vespa PXE Arcobaleno	10	239153	121858740	
M7 x 54 mm	Vespa 50-90-125 • Vespa Primavera ET3	5	008421	121858670	
M7 x 75 mm	Vespa 50-90-125 • Vespa Primavera ET3	5	008499	121858650	
M7 x 80 mm	Vespa 50-90-125 • Vespa Primavera ET3	5	008419	121858680	
M7 x 95 mm	Vespa PX	5	239150	121858700	

## PRIGIONIERI - STUDS



Dimensioni Dimensions	Adatto Per Suitable	Applicazioni Applications	Pezzi Pcs	OEM	Codice RMS RMS Code	Codice a Barre Barcode
6 x 33 mm	Scarico   Exhaust	Vespa 50-90 • Vespa 125 Primavera • Vespa ET3 • Vespa PK 50	2	Piaggio: R.O. 003918	121856000	
7 x 35 mm	Carter motore   Crankcase	Vespa 50 • Vespa 50 PK • Vespa PK 50XL	1	Piaggio: R.O. 000480,458	121860280	
7 x 52 mm	Carter motore   Crankcase	Vespa PX 125 • Vespa GL 125 • Vespa Sprint 125	10	Piaggio: R.O. 239153	121858740	
7 x 58 mm	Base cilindro   Cylinder Base	Vespa 50-90 • Vespa 125 Primavera ET3 • Vespa PK 50-125	1	Piaggio: R.O. 004515	121860260	
7 x 142 mm	Cilindro   Cylinder	Vespa 125 Primavera • Vespa ET3 • Vespa PX 125-150 • Cosa 125-150	4	Piaggio: R.O. 150656	121856040	
8 x 36 mm	Flangia   Flange	Vespa PK 50 • Vespa PK 50XL • Vespa 50 N • Vespa 50 FL-FL2 Vespa PK 125XL • Vespa 125 FL	3	Piaggio: R.O. 000456	121860250	
8 x 160 mm	Cilindro   Cylinder	Vespa PE 200 • Vespa Rally 200	4	Piaggio: R.O. 016058	121856130	

## PRIGIONIERI MOTORE - ENGINE STUDS

## KIT BULLONI/PRIGIONIERI CARTER MOTORE - BOLT/STUD KIT CRANKCASE



Codice RMS RMS Code	Codice a Barre Barcode	Applicazioni Applications	Composto da Composed by			
			Descrizione Description	Dimensioni Dimensions	Pezzi Pcs	Codice RMS RMS Code
121860120		Vespa 50-90-125 • Vespa Primavera ET3 • Vespa PK 50-125	Bullone   Bolt	M7 x 75 mm	3	121858650
			Bullone   Bolt	M7 x 45 mm	5	121858660
			Bullone   Bolt	M7 x 54 mm	2	121858670
			Bullone   Bolt	M7 x 80 mm	1	121858680
			Rondella   Washer	7 mm	11	121858720
			Rondella Grower   Grower Washer	7 mm	11	121858730
			Dado   Nut	M7	11	121878710
121860130		Vespa PX 125-150	Colonnina   Spacer		1	121858620
			Bullone   Bolt	M7 x 50 mm	4	121858690
			Bullone   Bolt	M7 x 95 mm	1	121858700
			Rondella   Washer	7 mm	13	121858720
			Rondella Grower   Grower Washer	7 mm	13	121858730
			Bullone   Bolt	M7 x 52 mm	52	121858740
			Dado   Nut	M7	13	121878710
121860140		Vespa PX 200 • Vespa 200 Rally	Bullone   Bolt	M7 x 50 mm	4	121858690
			Bullone   Bolt	M7 x 95 mm	1	121858700
			Rondella   Washer	7 mm	13	121858720
			Rondella Grower   Grower Washer	7 mm	13	121858730
			Bullone   Bolt	M7 x 52 mm	8	121858740
			Colonnina   Spacer		1	121860290
			Dado   Nut	M7	13	121878710

## PRIGIONIERI MOTORE - ENGINE STUDS

121860160



KIT PRIGIONIERI CILINDRO | *CYLINDER STUDS KIT*

Vespa 125 Primavera ET3 • Vespa PX 125-150 •  
Cosa 125-150 • Vespa Primavera ET3



121860110



KIT BULLONI MOTORE | *ENGINE BOLT KIT*

M10 x 215 mm

Vespa 50-90 • Vespa 125 Primavera ET3 •  
Vespa PK 50-125  
R.O. 78588, 016410, 020110



121860353



KIT BULLONI MOTORE | *ENGINE BOLT KIT*

M14 x 240 mm

Vespa PX 125-150-200 • Vespa Sprint • Vespa  
GL • Vespa Super • Vespa TS  
Tutte large frame | *All large frame models*  
R.O. 81803



121860363



KIT TUBO MOTORE COMPLETO | *ENGINE TUBE KIT*

Vespa PX 125-150 • Vespa Sprint • Vespa GL •  
Vespa Super





## CUFFIE - CYLINDER COWLINGS

**142560110**CUFFIA MOTORE | *CYLINDER COWLING*Vespa 50 • Vespa PK 50 • Vespa PK 50XL •  
Vespa 50 FL • Vespa Rush • Vespa N  
R.O. 139261**142560120**CUFFIA MOTORE | *CYLINDER COWLING*Vespa PE 200 • Vespa PX 200 • Vespa 180-  
200 Rally  
R.O. 431054**142560130**CUFFIA MOTORE | *CYLINDER COWLING*Vespa PX 125-150  
R.O. 843530, 431056**142560160**CUFFIA MOTORE | *CYLINDER COWLING*Vespa 125 Primavera • Vespa Primavera ET3 •  
Vespa PK 125 • Vespa PK 125XL  
R.O.174702

142580090



COPRIVENTOLA IN ACCIAIO CROMATO |  
CHROMED STEEL FLYWHEEL COVER

Vespa PK 50-125 • Vespa Rush • Vespa N •  
Vespa FL • Vespa HP  
R.O. 2447355, 244735



142580091



COPRIVENTOLA IN ACCIAIO NERO | BLACK  
STEEL FLYWHEEL COVER

Vespa PK 50-125 • Vespa Rush • Vespa N •  
Vespa FL • Vespa HP  
R.O. 2447355, 244735



142580100



COPRIVENTOLA IN ACCIAIO CROMATO |  
CHROMED STEEL FLYWHEEL COVER

Senza avviamento elettrico | Without electric  
starter

Vespa PX • Vespa PE tutti i modelli | Vespa PE  
all models  
R.O. 610236M



142580101



COPRIVENTOLA IN ACCIAIO NERO | BLACK  
STEEL FLYWHEEL COVER

Senza avviamento elettrico | Without electric  
starter

Vespa PX • Vespa PE tutti i modelli | Vespa PE  
all models  
R.O. 194362



## COPRIVENTOLA - FAN COVERS

142580140



COPRIVENTOLA IN ACCIAIO NERO | BLACK  
STEEL FLYWHEEL COVER

Vespa 50-90-125 Primavera ET3  
R.O. 133658



## ACCESSORI COPRIVENTOLA - FAN COVER ACCESSORIES

121858890



VITE ZINCATA COPRIVENTOLA VESPA |  
GALVANIZED SCREW FLYWHEEL COVER  
M6 x 12 mm, Testa taglio | M6 x 12 mm, Flat  
head

Conf. 10 Pz. | 10 pcs Pack

Vespa tutti i modelli | Vespa all models  
R.O. 002856



## SILENTBLOCK MOTORE - ENGINE SILENTBLOCK

121830270



41 x 20 x 10 mm

Vespa 50-90 • Vespa 125 Primavera ET3 •  
Vespa PK 50-125 • Vespa 125 FL  
R.O. 112204



121830283



Ø 45,5 mm

Vespa 200 PX PE Arcobaleno • Vespa 200 Rally  
R.O. 174724



## SILENTBLOCK MOTORE - ENGINE SILENTBLOCK

**121830873**



Ø 30/40 mm

Vespa PX 125-150 • Vespa Sprint • Vespa GL •  
Vespa Sprint Veloce



## TAMPONI - BUFFERS

**121830380**



TAMPONE DI SCANTRO | *BUFFER*

Confezione 5 Pz. | *5 Pcs Packing*

Vespa PK 50-125XL

R.O. 078578



**121830390**



TAMPONE DI SCANTRO | *BUFFER*

Confezione 5 Pz. | *5 Pcs Packing*

Vespa 50-90 • Vespa 125 Primavera • Vespa

ET3 • Vespa PK

R.O. 165206



**121830400**



TAMPONE DI SCANTRO | *BUFFER*

Confezione 5 Pz. | *5 Pcs Packing*

Vespa PX • Vespa PE

Tutti i modelli | *All models*

R.O. 178338



**121830510**



TAMPONE MOTORE | *ENGINE BUFFER*

Dimensioni 33 x 18 x 20 mm | *Dimensions 33 x 18 x 20 mm*

Confezione 5 Pz. | *5 Pcs Packing*

Vespa PX 125-150 • Vespa Sprint • Vespa GL •

Vespa Sprint Veloce

R.O. 059589, 059588, 59588



## TAMPONI - BUFFERS

**121830520**

TAMPONE MOTORE | *ENGINE BUFFER*  
 Dimensioni 48 x 13 x 14 mm | *Dimensions 48 x 13 x 14 mm*  
 Confezione 5 Pz. | *5 Pcs Packing*  
 Vespa PX 125-150 • Vespa Sprint • Vespa GL •  
 Vespa Sprint Veloce  
 R.O. 059588

ACCESSORI MOTORE - *ENGINE ACCESSORIES***121858620**

COLONNINA CUFFIA | *SPACER*  
 Dimensioni 7 x 29 mm | *Dimensions 7 x 29 mm*  
 Confezione 5 Pz. | *5 Pcs Packing*  
 Vespa PX 125-150-200 Arcobaleno • Vespa T5  
 R.O. 001447

**121860290**

COLONNINA CUFFIA | *COOLING HOOD SPACER*  
 Dimensioni 8 x 33 mm | *Dimensions 8 x 33 mm*  
 Confezione 5 Pz. | *5 Pcs Packing*  
 Vespa P 200E  
 R.O. 015239

**121859231****NEW**

VITE SFIATO OLIO | *OIL DRAIN SCREW*  
 Vespa tutti i modelli large frame e small frame |  
*All models both large and small frame*  
 R.O. 019301, 0193014, S.193014

**121859236****NEW**

GUIDA OLIO | *OIL GUIDE*  
 Vespa PX 125-150-200 • Vespa T5 • Cosa 1-2  
 R.O. 146129





# SCARICO

EXHAUST SYSTEM



## MARMITTE - TUBI SCARICO - MUFFLERS

**100751000**



Resistente fino a 500°, verniciata trasparente |  
500° Heat resistance, transparent painting

Vespa 50 ('65-'82)  
R.O. 132106, 137655



**100751010**



Resistente fino a 500°, verniciata trasparente |  
500° Heat resistance, transparent painting

Vespa 125 Primavera  
R.O.120218, 1202184, 112501, 100119, 71108



**100751020**



Resistente fino a 500°, verniciata trasparente |  
500° Heat resistance, transparent painting

Vespa 150 GL • Vespa Sprint • Vespa Sprint  
Veloce  
R.O. 124046



**100751030**



Resistente fino a 500°, verniciata nera | 500°  
Heat resistance, black painting

Vespa PX 200 • Vespa PX PE Arcobaleno  
R.O. 417809





**MARMITTE - TUBI SCARICO - MUFFLERS****100751040**Vespa PX 125-150 • Vespa PX PE Arcobaleno  
R.O. 417806**100751170**Verniciata nera | *Black painting*  
Vespa 125 - 150 Super  
Adattabile a - *Suitable for* VNB-VBB  
R.O. 131869**100751190****NEW****FACO**Verniciata nera | *Black painting*  
Racing  
Incluso collettore e piastra di supporto | *With*  
*exhaust manifold and mounting plate*  
Vespa PE 200 • Vespa PX 200**100751200****NEW****FACO**Verniciata nera | *Black painting*  
Racing  
Incluso collettore e piastra di supporto | *With*  
*exhaust manifold and mounting plate*  
Vespa PX 125-150

100751210

NEW



**FACO**



Verniciata nera | *Black painting*  
 Incluso collettore e piastra di supporto | *With exhaust manifold and mounting plate*  
 Vespa 50/N/L/R/S/Special/SR/SS  
 R.O. 135998



100751211

NEW



**FACO**



Cromata | *Chromed*  
 Incluso collettore e piastra di supporto | *With exhaust manifold and mounting plate*  
 Vespa 50/N/L/R/S/Special/SR/SS  
 R.O. 135998



100751212

NEW



**FACO**



Verniciata nera | *Black painting*  
 Incluso collettore e piastra di supporto | *With exhaust manifold and mounting plate*  
 Vespa 50/N/L/R/S/Special/SR/SS  
 R.O. 135998



100751213

NEW



**FACO**



Cromata | *Chromed*  
 Incluso collettore e piastra di supporto | *With exhaust manifold and mounting plate*  
 Vespa 50/N/L/R/S/Special/SR/SS  
 R.O. 135998



**MARMITTE - TUBI SCARICO - MUFFLERS****100751220** **NEW****FACO**Verniciata nera | *Black painting*

Racing

Incluso collettore e piastra di supporto | *With exhaust manifold and mounting plate*

Vespa 125 Primavera ET3

Adatto per - *Suitable for* Vespa 90/R/SS • Vespa 100 • Vespa 125/PV

R.O. 139338

**100751221** **NEW****FACO**Cromata | *Chromed*

Racing

Incluso collettore e piastra di supporto | *With exhaust manifold and mounting plate*

Vespa 125 Primavera ET3

Adatto per - *Suitable for* Vespa 90/R/SS • Vespa 100 • Vespa 125/PV

R.O. 139338

**100751222** **NEW****FACO**Verniciata nera | *Black painting*Incluso collettore e piastra di supporto | *With exhaust manifold and mounting plate*

Vespa 125 Primavera ET3

Adatto per - *Suitable for* Vespa 90/R/SS • Vespa 100 • Vespa 125/PV

R.O. 139338

**100751223** **NEW****FACO**Cromata | *Chromed*Incluso collettore e piastra di supporto | *With exhaust manifold and mounting plate*

Vespa 125 Primavera ET3

Adatto per - *Suitable for* Vespa 90/R/SS • Vespa 100 • Vespa 125/PV

R.O. 139338



**100720010**



CARTUCCIA LANA DI ROCCIA Ø60x170 mm |  
ROCKWOOL CARTRIDGE Ø60x170 mm



**100720020**



CARTUCCIA LANA DI ROCCIA Ø80x300 mm |  
ROCKWOOL CARTRIDGE Ø80x300 mm



**100720030**



FOGLIO LANA DI ROCCIA 600x320x30 mm |  
ROCKWOOL SHEET 600x320x30 mm



**121858900**



VITE PER MARMITTA | BOLT MUFFLER  
Confezione 10 pz. | 10 Pcs Packing  
M10x79 mm  
Vespa PX 125-150-200  
R.O. 014691



**100751070**



GHIERA SCARICO | EXHAUST RING  
Vespa PX 200 • Cosa 200 • Vespa 200 Rally  
R.O. 130143



**142800040**



TERMINALE MARMITTA | EXHAUST TERMINAL  
Vespa tutti i modelli | All models  
R.O. 610157M



**ACCESSORI MARMITTE - TUBI DI SCARICO - MUFFLERS ACCESSORIES****142800060**TUBETTO MARMITTA | *EXHAUST TUBE*Vespa tutti i modelli | *All models***COLLETTORI SCARICO - EXHAUST MANIFOLDS****100540010**Prigionieri M6 | *Studs M6*Interasse 56 mm | *Distance 56 mm*Interasse fori 52 mm | *Hole distance 52 mm*Diametro fori Ø 8 mm | *Hole diameter Ø 8 mm*Vespa 50-90 • Vespa 125 Primavera • Vespa  
ET3 • Vespa PK 50 • Vespa PK 50XL • Vespa HP  
• Vespa N • Vespa Rush

R.O. 247033, 157042

**100540020**Prigionieri M6 | *Studs M6*Interasse 56 mm | *Distance 56 mm*Interasse fori 52 mm | *Hole distance 52 mm*Diametro fori Ø 8 mm | *Hole diameter Ø 8 mm*

Vespa PK 125

R.O. 222208, 240452





# IMPIANTO FREMANTE

BRAKING SYSTEM

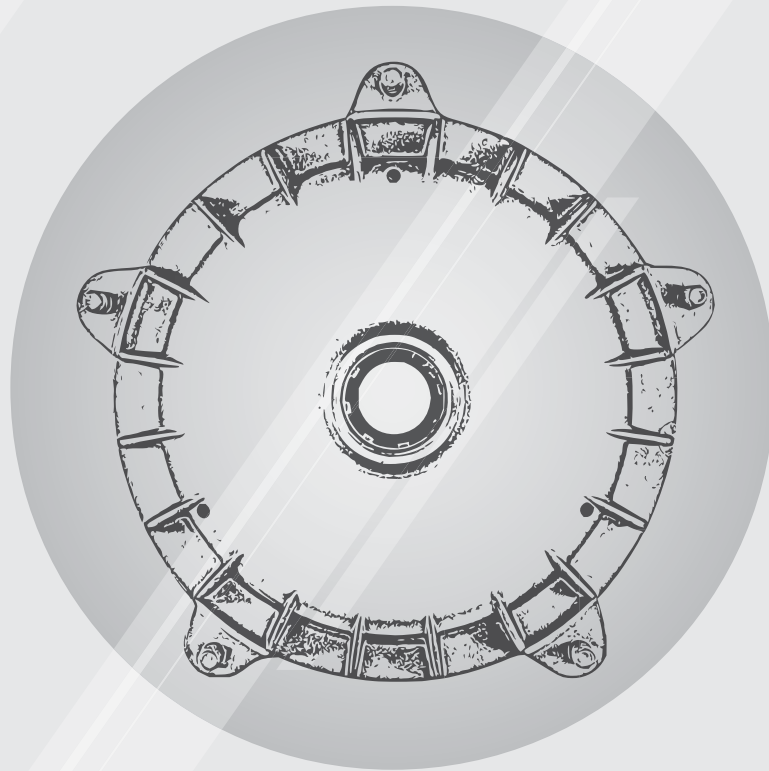

## PASTIGLIE FRENO - BRAKE PADS

225100160



Anteriore | *Front*

Dimensioni 51,1x31,6x5,5 mm | *Dimensions*

51,1x31,6x5,5 mm

Tipologia Organico | *Type Organic*

Con certificazione KBA | *With KBA certificaton*

Vespa PX 125 - 150 - 200 Arcobaleno ('98>)

R.O. 498416

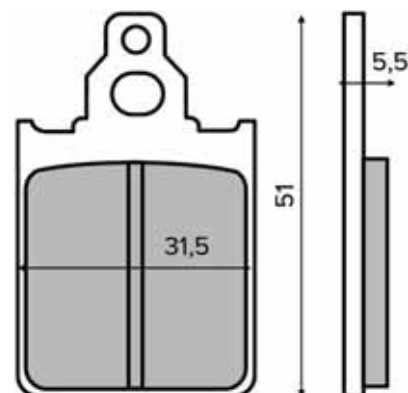

## GARANSCIE FRENO - BRAKE SHOES

225120161



225120570



225120572 **NEW**



Anteriore | *Front*

Posteriore | *Rear*

Vespa PX 125-150-200 Arcobaleno • Vespa PK

50 • Vespa PK 50-125XL • Vespa 50 FL • Vespa

Sprint Veloce • Vespa 160 GS • Vespa 180 SS

R.O. 414450, 4144504, 246409, 072339,

2464094, 2454095, 180200,

61034

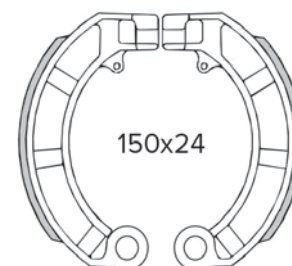

225120170



Anteriore | *Front*

Vespa 50-90 • Vespa 125 Primavera • Vespa

ET3 • Vespa PK 50 • Vespa PK 50XL (>'86) •

Vespa 125-150 ('51-'72) • Vespa Sprint Veloce •

Vespa Super

R.O. 266506, 091058, 267757, 022001,

003523, 18020

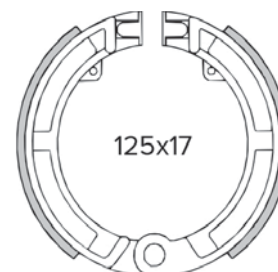



**GANASCE FRENO - BRAKE SHOES**

**225120180**



Posteriore | *Rear*

Vespa 50-90 • Vespa 125 Primavera • Vespa ET3  
R.O. 100492

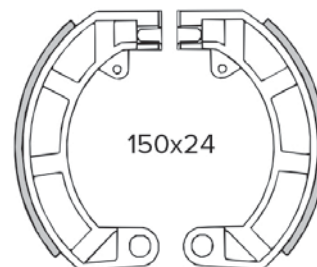

**225120501**



Posteriore | *Rear*

Cosa 125-150-200  
R.O. 414437, 229454



**225120511**



Anteriore | *Front*

Vespa Cosa 125-150-200  
R.O. 414429, 228867



**225120520**



Anteriore | *Front*

Vespa Sprint Veloce • Vespa 160 GS • Vespa 180 SS • Vespa 200 Rally  
R.O. 026832, 267764, 267767, 41588, 180203, 610345M



**225120531**



Posteriore | *Rear*

Vespa VNB ('63-'72)  
R.O. 81229, 078170, 096153



## GANASCE FRENO - BRAKE SHOES

**225120540**



Posteriore | *Rear*  
Vespa Super  
R.O. 110412, 267760, 610347M



**225120550**



Posteriore | *Rear*  
Vespa 125-150 ('51-'62)  
R.O. 078170, 081229, 022004, 026270,  
016355



## ACCESSORI GANASCE FRENO - BRAKE SHOES ACCESSORIES

**121950060**



MOLLA GANASCIA | *BRAKE SHOES SPRING*  
Lunghezza 50 mm | *Length 50 mm*  
Diametro Ø 12 mm | *Diameter Ø 12 mm*  
Vespa 50-90 • Vespa 125 Primavera • Vespa  
Primavera ET3 • Vespa PK • Vespa PK XL  
R.O. 025990, 89993



**121950070**



MOLLA GANASCIA | *BRAKE SHOES SPRING*  
Vespa 50-90 • Vespa 125 Primavera • Vespa  
Primavera ET3 • Vespa PK • Vespa PK XL •  
Vespa PX 125-150-200  
R.O. 078522



**121950080**



ANELLO GANASCIA | *BRAKE SHOES CLIP*  
Anteriore e posteriore | *Front and rear*  
Vespa PX 125-150-200 Arcobaleno • Vespa PK  
50 • Vespa PK 50-125XL • Vespa 50 FL • Vespa  
Sprint Veloce • Vespa 160 GS • Vespa 180 SS  
R.O. 000061



**DISCHI FRENO - BRAKE DISCS**

**225160160**



Ø Esterno 155 mm | Ø External 155 mm  
 Ø Interno 39 mm | Ø Internal 39 mm  
 Spessore 4,1 mm | Thickness 4,1 mm  
 Ø Fori Fiss. 6,5 mm | Ø Fixing holes 6,5 mm  
 Vespa PX 125-150-200 Arcobaleno ('98->)  
 R.O. 56395R, 563246, 562003, 274214



**TAMBURI FRENO - BRAKE DRUMS**

**225085020**



TAMBURO FRENO POSTERIORE | REAR BRAKE DRUM

Per cerchio aperto 10" | For open 10" rim  
 Ø interno 150 mm | Ø inside 150 mm  
 Vespa 50-90 • Vespa 125 Primavera • Vespa Primavera ET3  
 R.O. 100484, 1004844



**225085040**



TAMBURO FRENO POSTERIORE | REAR BRAKE DRUM

Mozzetto Ø27 mm | Hub Ø27 mm  
 Per cerchio aperto 10" | For open 10" rim  
 Ø interno 150 mm | Ø inside 150 mm  
 Vespa PX 125-150-200 • Vespa GL • Vespa Sprint • Vespa Sprint Veloce • Vespa 200 Rally  
 R.O. 078480, 0784804



**225085050**



**225085053**



TAMBURO FRENO POSTERIORE | REAR BRAKE DRUM

Mozzetto Ø30 mm | Hub Ø30 mm  
 Per cerchio aperto 10" | For open 10" rim  
 Ø interno 150 mm | Ø internal 150 mm  
 Vespa PX 125-150-200 Arcobaleno  
 R.O. 194433, 2427724



## TAMBURI FRENO - BRAKE DRUMS

**225085070**



TAMBURO FRENO POSTERIORE | *REAR BRAKE DRUM*

Per cerchio 8" aperto | *For open 8" rim*

Ø interno 135 mm | *Ø internal 135 mm*

Vespa 125-150 Super

R.O. 110375, 157743, 1577435



**225085080**



TAMBURO FRENO POSTERIORE | *REAR BRAKE DRUM*

Mozzetto Ø31,5 mm | *Hub Ø31,5 mm*

Per cerchio aperto 10" | *For open 10" rim*

Ø interno 150 mm | *Ø internal 150 mm*

Vespa PX 125-150 ('11>) • Vespa 125 T5

R.O. 245474, 235940, 2427724, 2427721



**225085090** **NEW**



TAMBURO FRENO ANTERIORE | *FRONT BRAKE DRUM*

Attacco asse conico con chiavetta | *Conical axis connection with key*

Per cerchio aperto 10" | *For open 10" rim*

Ø interno 150 mm | *Ø internal 150 mm*

Vespa PX 125-150-200 • Vespa 150 GL • Vespa Sprint • Vespa Sprint Veloce • Vespa 200 Rally

R.O. 078744



**225085100** **NEW**



TAMBURO FRENO ANTERIORE | *FRONT BRAKE DRUM*

Per cerchio aperto 10" | *For open 10" rim*

Ø interno 150 mm | *Ø internal 150 mm*

Vespa PX 125-150-200 Arcobaleno

R.O. 2421955, 242195, 177444



**TAMBURI FRENO - BRAKE DRUMS**

**225085110** **NEW**



TAMBURO FRENO ANTERIORE | *FRONT BRAKE DRUM*

Per cerchio aperto 10" | *For open 10" rim*  
 Ø interno 150 mm | *Ø internal 150 mm*

Vespa 50 FL-FL2 ('90-'97) • Vespa 50 N ('89-'90) • Vespa PK 50 ('82-'89) • Vespa PK 50XL ('88-'89) • Vespa 125 FL • Vespa PK 125XL ('86-'89)

R.O. 2744741



**225088023**



TAMBURO FRENO POSTERIORE | *REAR BRAKE DRUM*

Per cerchio 8" chiuso | *For closed 8" rim*  
 Ø interno 127 mm | *Ø internal 127 mm*

Vespa 125-150 VNA-VBA-VBB-VNB con ruote da 8" - *with 8 in. wheels*

R.O. 023831, 20596, 16351



**ACCESSORI TAMBURI FRENO - BRAKE DRUMS ACCESSORIES**

**121850480**



VITE FISSAGGIO RUOTA | *WHEEL FIXING BOLT*

Confezione 4 pz. | *4 Pcs Packing*

Per Cerchio 9" chiuso | *For 9" closed wheel rim*  
 M10x16mm

Vespa 50-90

R.O. 070156



**121860270**



KIT PRIGIONIERO TAMBURO | *DRUM STUD KIT*

Prigioniero M8 x 30 mm | *Stud M8 x 30 mm*

Dado M8 x 13 mm | *Nut M8 X 13 mm*

Vespa tutti i modelli | *All models*

R.O. 085914, 229769



**225084000**



TAPPO IN ACCIAIO PER TAMBURO POSTERIORE  
Ø 39 | *INOX REAR DRUM PLUG Ø 39*

Confezione 5 pz. | *5 Pcs Packing*

Vespa 50-90 • Vespa 125 Primavera •

Vespa ET3 • Vespa PX 125 T5 • Vespa PX PE

Arcobaleno (per tamburo anteriore e posteriore  
- *for front and rear drum*) • Vespa PX PE 1° serie

(per tamburo posteriore - *for rear drum*)

R.O. 182546, 82546, 000057M, 092517,

053783



**225084010**



TAPPO IN ACCIAIO PER TAMBURO POSTERIORE  
Ø 32 | *INOX REAR DRUM PLUG Ø 32*

Confezione 5 pz. | *5 Pcs Packing*

Vespa 125-150 PX PE ('78-'82)

R.O. 181757,126410



**225084023**



TAPPO TAMBURO | *DRUM PLUG*

Plastica | *Plastic Type*

Ø esterno 52 mm | *Ø outside 52 mm*

Ø interno 36 mm | *Ø inside 36 mm*

Vespa PX 125-150-200

R.O. 198015, 415519



**121860250**



PRIGIONIERO FLANGIA TAMBURO POSTERIORE  
| *REAR DRUM FLANGE STUD*

Confezione 10 pz. | *10 Pcs Packing*

Vespa 50-90 • Vespa 125 Primavera ET3 •

Vespa PK 50-125

R.O. 000456



**121870613**



CAMMA FRENO | *BRAKE CAM*

Anteriore | *Front*

Ø 13 mm

Vespa 125-150 ('51-'62)

R.O. 131942, 2661574, 97590, 2/2140



**ACCESSORI TAMBURI FRENO - BRAKE DRUMS ACCESSORIES**

**225088033**



DISCO PARAPOLVERE | *DUST SEAL*  
 Per cerchio 8" | *For 8" Rim*  
 Vespa 125-150 VNA-VBA-VBB-VNB  
 R.O. 110379



**225088043**



DISCO PARAPOLVERE | *DUST SEAL*  
 Per cerchio 10" | *For 10" Rim*  
 Vespa PX 125-150-200 • Vespa T5 • Vespa 200  
 Rally • Vespa 150 Sprint  
 R.O. 078482



**CILINDRETTI FRENO - BRAKE CYLINDERS**

**225140160**



4 fori | *4 holes*  
 Cosa 125-150-200  
 R.O. 248846



**225140170**



2 fori | *2 holes*  
 Cosa 125-150-200  
 R.O. 228828



**225130120**



Cosa 125-150-200  
 R.O. 229254, 2292545







# IMPIANTO ELETTRICO

ELECTRICAL SYSTEM

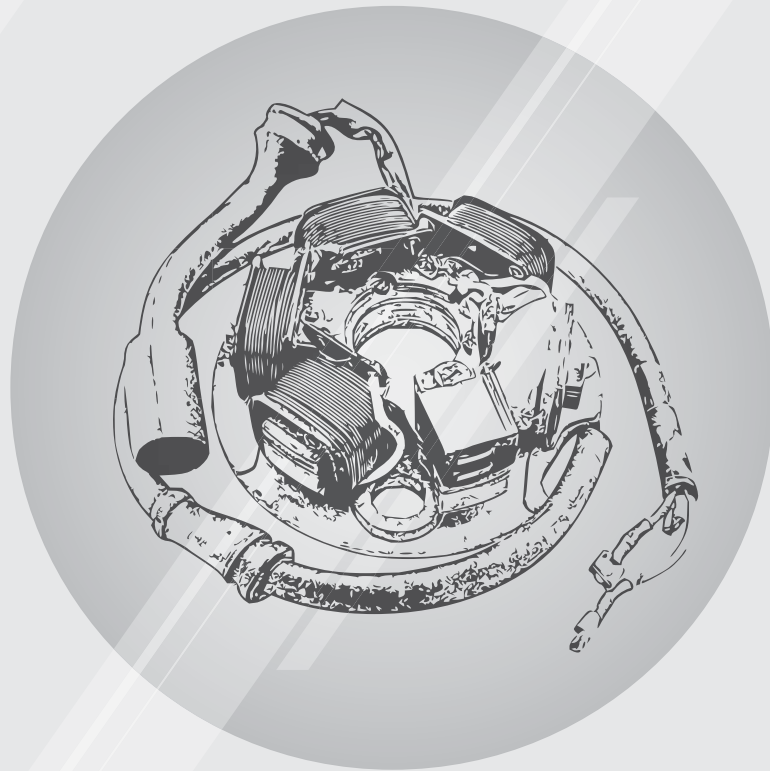

**121830230**



CAPPUCCIO CANDELA | *SPARK PLUG CAP*

Confezione 5 pz. | *5 pcs pack*

Vespa 50-90-125 Primavera • Vespa ET3 •  
Vespa PK • Vespa PK XL • Vespa Rush • Vespa  
FL • Vespa FL2 HP • Vespa PX 125 • Vespa PX  
125 EU2 • Cosa CL-CLX  
R.O. 244395, 72843



**121830843**



CAPPUCCIO CANDELA | *SPARK PLUG CAP*

Confezione 5 pz. | *5 pcs pack*

Vespa 125 • Vespa P 125X • Vespa 150 • Vespa  
150 • Vespa P 150X • Vespa PX PE Arcobaleno •  
Vespa Sprint • Vespa Super • Vespa Rally  
R.O. 046741



**246330060**



CAPPUCCIO CANDELA NERO | *BLACK SPARK  
PLUG CAP*

Resistente all'acqua | *Waterproof*  
Vespa tutti i modelli - *all models*



**246330070**



CAPPUCCIO CANDELA ROSSO | *RED SPARK  
PLUG CAP*

Resistente all'acqua | *Waterproof*  
Vespa tutti i modelli - *all models*



**246330140**



CAPPUCCIO CANDELA | *SPARK PLUG CAP*

Piega 90° | *90° spark plug cap*

Innesto terminale SAE | *SAE connector*

**PRO-OU**



**ACCESSORI CANDELE - SPARK PLUGS ACCESSORIES****246330150**

CAPPuccio CANDELA | SPARK PLUG CAP

Piega 90° | 90° spark plug cap

Schermata | With resistor

Innesto terminale 1 | Connector type 1

**PRO-5M****121858472**

CAPOCORDA CANDELA VESPA | SPARK PLUG

CLAMP

Confezione 10 pz. | 10 pcs pack

Vespa tutti i modelli | All models

R.O. 127966

**246490010**

CAVO CANDELA | SPARK PLUG CABLE

Rotolo da 10 mt, Ø 7mm | Packing 10/mtrs roll,  
Ø 7mm

Vespa tutti i modelli | All models

R.O. 80341 |

**246490011** **NEW**

CAVO CANDELA | SPARK PLUG CABLE

Rotolo da 10 mt, Ø 7mm | Packing 10/mtrs roll,  
Ø 7mm

Colore Blu | Color Blue

Vespa tutti i modelli | All models

R.O. 80341 |

**246490012** **NEW**

CAVO CANDELA | SPARK PLUG CABLE

Rotolo da 10 mt, Ø 7mm | Packing 10/mtrs roll,  
Ø 7mm

Colore Rosso | Color Red

Vespa tutti i modelli | All models

R.O. 80341 |



## FANALI COMPLETI - COMPLETE LIGHTS

### FANALI ANTERIORI - FRONT LIGHTS

**246410030**



In vetro | Glass headlight

Ø95 mm

Portalamпада abbaglianti e anabbaglianti

BA20d | Dipped beam socket BA20d

Portalamпада con luce di posizione: - | Parking light socket: -

Include lampadine | With bulbs

Con ghiera fanale | With headlamp rim

Vespa 98 ('46-'48) • Vespa 125 ('48-'52)

R.O. 10172



**246410040**



In vetro | Glass headlight

Ø105 mm

Portalamпада abbaglianti e anabbaglianti

BA20d | Dipped beam socket BA20d

Portalamпада con luce di posizione: BA15s |

Parking light socket: BA15s

Senza lampadine | Without bulbs

Con marchio di omologazione IGM | IGM certified

Vespa 50 N • Vespa 50 R • Vespa 50 L estero

R.O. 101231



**246410041** **NEW**



In plastica | Plastic headlight

Ø105 mm

Portalamпада abbaglianti e anabbaglianti P26s

| Dipped beam socket P26s

Portalamпада con luce di posizione: T 15 x 44 |

Parking light socket: T 15 x 44

Senza lampadine | Without bulbs

Con marchio di omologazione IGM | IGM certified

Vespa 50 N • Vespa 50 R • Vespa 50 L

R.O. 101231, 215399 SIEM



**FANALI COMPLETI - COMPLETE LIGHTS****246410050**In vetro | *Glass headlight*

Ø115 mm

Portalampada abbaglianti e anabbaglianti

BA20d | *Dipped beam socket BA20d*

Portalampada con luce di posizione: BA15s |

*Parking light socket: BA15s*Senza lampadine | *Without bulbs*Con ghiera fanale | *With headlamp rim*Con marchio di omologazione IGM | *IGM certified*

Vespa 125 VNB 3-4-5-6-('62-'65) • Vespa 150

('59-'65) • Vespa GS ('59-'64) • Vespa VBA-VBB

('59-'62)

R.O. 92326

**246410060**In vetro | *Glass headlight*

Ø115 mm

Portalampada abbaglianti e anabbaglianti

BA20d | *Dipped beam socket BA20d*

Portalampada con luce di posizione: BA15s |

*Parking light socket: BA15s*Senza lampadine | *Without bulbs*Con marchio di omologazione IGM | *IGM certified*

Vespa 50 SS • Vespa 90 SS-125('65-'66) •

Vespa 125 Super • Vespa 150 Super ('66&gt;) •

Vespa 125 Primavera ET3

R.O. 144773



246410070



In vetro | Glass headlight

Ø130 mm

Portalampada abbaglianti e anabbaglianti

BA20d | Dipped beam socket BA20d

Portalampada con luce di posizione: BA15s |

Parking light socket: BA15s

Senza lampadine | Without bulbs

Con ghiera fanale | With headlamp rim

Con marchio di omologazione IGM | IGM certified

Vespa Rally 180-200 • Vespa Sprint Veloce 150

• Vespa GTR 125 • Vespa TS 125

R.O. 141772



246410080



In vetro | Glass headlight

Portalampada abbaglianti e anabbaglianti

BA20d | Dipped beam socket BA20d

Portalampada con luce di posizione: BA15s |

Parking light socket: BA15s

Con ghiera fanale | With headlamp rim

Con serpentina ABG | With ABG

Vespa GL 150 • Vespa Sprint 150 • Vespa GT 125 •

Vespa 180 SS

R.O. 138508



246410090



In vetro | Glass headlight

Ø140 mm

Portalampada abbaglianti e anabbaglianti

BA20d | Dipped beam socket BA20d

Portalampada con luce di posizione: BA15s |

Parking light socket: BA15s

Senza lampadine | Without bulbs

Con marchio di omologazione DGM | DGM certified

Vespa PX 125-150-200 ('73-'83)

R.O. 163685, 161235



**FANALI COMPLETI - COMPLETE LIGHTS****246410100**In plastica | *Plastic headlight*Portalampada anabbaglianti P26s | *Dipped beam socket P26s*Portalampada con luce di posizione: Lampada tubolare | *Parking light socket: Festoon*Senza lampadine | *Without bulbs*Con marchio di omologazione DGM | *DGM certified*

Vespa 50 Special V5A2 (6V) • Vespa 50 Elestart V5A3 (12V)

R.O. 126695

**246410101****NEW**Alogeno | *Halogen*

Ø 90x140 mm

Vespa 50 Special

R.O. 126695

**246410102****NEW****EVOX**LED | *LED*

3000 lumen

Temperatura colore 6500 K | *Color temperature 6500 K*Applicabile a tutti gli impianti 12V sia AC che DC | *Suitable for 12V AC/DC wirings*

Vespa 50 Special

R.O. 126695



246410110



In vetro | Glass headlight

Ø105 mm

Portalamпада anabbaglianti P26s | Dipped beam socket P26s

Portalamпада con luce di posizione: Lampada

tubolare | Parking light socket: Festoon

Senza lampadine | Without bulbs

Con marchio di omologazione IGM | IGM certified

Vespa 50 ('69-'71) • Vespa 50 S ('63-'68) •

Vespa 50 L ('66-'70) • Vespa 50 R ('70-'83)

R.O. 101321, 1011321



246410170



In vetro | Glass headlight

Ø105 mm

Portalamпада abbaglianti e anabbaglianti

BA20d | Dipped beam socket BA20d

Senza lampadine | Without bulbs

Con ghiera fanale | With headlamp rim

Con marchio di omologazione IGM | IGM certified

Vespa 150 VL2 ('55-'56) • Vespa 150 VL3 ('56)

R.O. 025483



246410180



In vetro | Glass headlight

Ø105 mm

Portalamпада abbaglianti e anabbaglianti

BA20d | Dipped beam socket BA20d

Senza lampadine | Without bulbs

Con ghiera fanale e visore | With headlamp rim and visor

Con marchio di omologazione IGM | IGM certified

Vespa 150 VL2 ('55-'56) • Vespa 150 VL3 ('56)

R.O. 025483





**FANALI COMPLETI - COMPLETE LIGHTS****246410190**In vetro | *Glass headlight*

Ø105 mm

Portalampada abbaglianti e anabbaglianti

BA20d | *Dipped beam socket BA20d*

Portalampada con luce di posizione: BA15s |

*Parking light socket: BA15s*Senza lampadine | *Without bulbs*Con ghiera fanale | *With headlamp rim*Con marchio di omologazione IGM | *IGM certified*Vespa 125 VNA1T ('58) • Vespa 125 VNA2T ('58-'59) • Vespa VNB1T ('60) • Vespa VNB2T ('61)  
R.O. 087310**246410200**In vetro | *Glass headlight*

Ø105 mm

Portalampada abbaglianti e anabbaglianti

BA20d | *Dipped beam socket BA20d*Senza lampadine | *Without bulbs*Con ghiera fanale | *With headlamp rim*Con marchio di omologazione IGM | *IGM certified*Vespa 125 VM1T ('53) • Vespa 125 VM2T ('54)  
R.O. 018087**246410210**In vetro | *Glass headlight*

Ø115 mm

Portalampada abbaglianti e anabbaglianti

BA20d | *Dipped beam socket BA20d*Senza lampadine | *Without bulbs*Con ghiera fanale | *With headlamp rim*Con marchio di omologazione IGM | *IGM certified*Vespa 150 VB1T ('57-'58) • Vespa 150 GS VS  
1-2-3-4 ('56-'58)  
R.O. 025793

246410220



In vetro | *Glass headlight*  
 Ø115 mm  
 Portalampada abbaglianti e anabbaglianti  
 BA20d | *Dipped beam socket BA20d*  
 Senza lampadine | *Without bulbs*  
 Con ghiera fanale e visore | *With headlamp rim and visor*  
 Con marchio di omologazione IGM | *IGM certified*  
 Vespa 150 VB1T ('57-'58) • Vespa 150 GS VS  
 1-2-3-4 ('56-'58)  
 R.O. 025793



246410230



In vetro | *Glass headlight*  
 Ø105 mm  
 Portalampada abbaglianti e anabbaglianti  
 BA20d | *Dipped beam socket BA20d*  
 Senza lampadine | *Without bulbs*  
 Con ghiera fanale | *With headlamp rim*  
 Con marchio di omologazione IGM | *IGM certified*  
 Vespa 125 VN1T ('55) • Vespa 125 VN2T ('56)  
 R.O. 026008



246410240



In vetro | *Glass headlight*  
 Ø105 mm  
 Portalampada abbaglianti e anabbaglianti  
 BA20d | *Dipped beam socket BA20d*  
 Senza lampadine | *Without bulbs*  
 Con ghiera fanale | *With headlamp rim*  
 Con marchio di omologazione IGM | *IGM certified*  
 Vespa 150 VL1 ('55)  
 R.O. 23447



**FANALI COMPLETI - COMPLETE LIGHTS****246410310**In plastica | *Plastic made*

Ø140 mm

Portalampada abbaglianti e anabbaglianti P43t

| *Dipped beam socket P43t*

Portalampada con luce di posizione: W2, 1x9,5d

| *Parking light socket: W2, 1x9,5d*Senza lampadine | *Without bulbs*Con omologazione E4 | *E4 certified*

Vespa PX 125-150-200 ('00-'15)

R.O. 582946

**246410320** **NEW**In plastica | *Plastic made*

Ø 135 mm

Portalampada abbaglianti e anabbaglianti

BA20d | *Dipped beam socket BA20d*

Portalampada con luce di posizione: BA9s |

*Parking light socket: BA9s*Senza lampadine | *Without bulbs*Con marchio di omologazione DGM | *DGM**certified*Senza attacco | *Without socket*

Vespa PK 125 Automatica

R.O. 215967



## FANALI COMPLETI - COMPLETE LIGHTS

### FANALI POSTERIORI - REAR LIGHTS

246420010



Con guarnizione | *With gasket*  
 Alloggiamento di metallo non verniciato | *Metal casing, not painted*  
 Portalampada fanale posteriore lampada tubolare | *Rear light socket festoon bulb*  
 Senza lampadine | *Without bulbs*  
 Marchio di omologazione sul vetro | *IGM mark on glass*  
 Marchio di omologazione E sul riflettore | *E-mark on reflector*  
 Vespa 90 • Vespa 90 Sprint • Vespa 125 • Vespa 125 Primavera ('63-'66)  
 R.O. 078641



246420020



Con guarnizione | *With gasket*  
 Alloggiamento di metallo, riflettore con cornice di alluminio, senza luce stop | *Metal casing, reflector with alu frame, without brake light*  
 Portalampada fanale posteriore lampada tubolare | *Rear light socket festoon bulb*  
 Senza lampadine | *Without bulbs*  
 Marchio di omologazione sul vetro | *IGM mark on glass*  
 Marchio di omologazione E sul riflettore | *E-mark on reflector*  
 Vespa 50 1° Serie ('63>)  
 R.O. 78872



**FANALI COMPLETI - COMPLETE LIGHTS****246420030**Con guarnizione | *With gasket*Alloggiamento di metallo | *Metal casing*

Portalampada fanale posteriore lampada

tubolare | *Rear light socket festoon bulb*Portalampada luce di arresto BA15s | *Brake**light socket BA15s*Senza lampadine | *Without bulbs*

Marchio di omologazione IGM sul riflettore |

*IGM mark on reflector*

Vespa 125 VNB 1-2-3-4-5 ('60-'64) • Vespa 150

('59-'65) • Vespa 150 GS ('59-'64) • Vespa 150

VBB ('59-'64)

R.O. 93186

**246420040**Con guarnizione | *With gasket*Alloggiamento di metallo, cromo | *Chromed metal casing*

Portalampada fanale posteriore lampada

tubolare | *Rear light socket festoon bulb*

Portalampada luce di arresto lampada tubolare

| *Brake light socket festoon bulb*Senza lampadine | *Without bulbs*

Marchio di omologazione IGM sul riflettore/

vetro | *IGM mark on reflector/glass*

Vespa 125 ('65&gt;) • Vespa 125 Super ('66&gt;) •

Vespa 150 Super ('66&gt;) • Vespa GL • Vespa 150

Sprint ('64-'66) • Vespa 180 SS (&gt;'65)

R.O. 70700



246420050



Con guarnizione | *With gasket*  
 Alloggiamento di metallo | *Metal casing*  
 Portalampada fanale posteriore lampada  
 tubolare | *Rear light socket festoon bulb*  
 Portalampada luce di arresto BA15s | *Brake  
 light socket BA15s*  
 Senza lampadine | *Without bulbs*  
 Marchio di omologazione IGM sul riflettore |  
*IGM mark on reflector*  
 Vespa 125 Super ('66>) • Vespa 150 Super  
 ('66>) • Vespa 150 Sprint ('65-'74) • Vespa 180  
 SS ('65-'68)  
 R.O. 091419



246420060



Con guarnizione, colore nero | *With gasket,  
 black colour*  
 Senza luce stop | *Without brake light*  
 Portalampada fanale posteriore lampada  
 tubolare | *Rear light socket festoon bulb*  
 Senza lampadine | *Without bulbs*  
 Marchio E3 | *E3 mark*  
 Vespa 50 Special ('72>)  
 R.O. 143687



246420065



Con guarnizione, colore grigio | *With gasket,  
 grey colour*  
 Senza luce stop | *Without brake light*  
 Portalampada fanale posteriore lampada  
 tubolare | *Rear light socket festoon bulb*  
 Senza lampadine | *Without bulbs*  
 Marchio E3 | *E3 mark*  
 Vespa 50 Special (>'72)  
 R.O. 143687



**FANALI COMPLETI - COMPLETE LIGHTS****246420070**

Con guarnizione | *With gasket*  
 Alloggiamento di alluminio | *Aluminium casing*  
 Portalampada fanale posteriore lampada  
 tubolare | *Rear light socket festoon bulb*  
 Portalampada luce di arresto lampada tubolare  
 | *Brake light socket festoon bulb*  
 Senza lampadine | *Without bulbs*  
 Con marchio di omologazione IGM | *IGM*  
*certified*

Vespa 125 VN1-2 • Vespa VNA 1-2 ('58) • Vespa  
 150 VL1-2-3-VB1 ('58) • Vespa 150 GS VS1-2-3  
 ('58)  
 R.O. 021098

**246420080**

Con guarnizione | *With gasket*  
 Alloggiamento di metallo | *Metal casing*  
 Portalampada fanale posteriore lampada  
 tubolare | *Rear light socket festoon bulb*  
 Senza lampadine | *Without bulbs*  
 Marchio di omologazione IGM sul riflettore |  
*IGM mark on reflector*

Vespa 125 VM1-2 • Vespa 125 VU1T  
 R.O. 184280001

**246420090**

Con guarnizione | *With gasket*  
 Alloggiamento di metallo | *Metal casing*  
 Portalampada fanale posteriore lampada  
 tubolare | *Rear light socket festoon bulb*  
 Senza lampadine | *Without bulbs*  
 Marchio di omologazione IGM sul riflettore |  
*IGM mark on reflector*

Vespa 125 V30-V33 ('51 - '52>)  
 R.O. 018427



**246420140**



Con guarnizione | *With gasket*

Portalampana fanale posteriore lampada  
tubolare | *Rear light socket festoon bulb*

Senza lampadine | *Without bulbs*

Marchio di omologazione sul riflettore | *IGM  
mark on reflector*

Vespa dal V5A1T fino al '66-'67 - *from V5A1T to  
'66-'67*

R.O. 102459



**246420150**



**246420151** **NEW**



Con guarnizione | *With gasket*

Portalampana fanale posteriore BA15s | *Rear  
light socket BA15s*

Portalampana luce di arresto BA15s | *Brake  
light socket BA15s*

Marchio di omologazione E sul vetro | *E-mark  
on glass*

Vespa P 125-150X • Vespa P 200E • Vespa PX  
125-150-200E

R.O. 162740



**246420160**



Con guarnizione | *With gasket*

Portalampana fanale posteriore BA15s | *Rear  
light socket BA15s*

Portalampana luce di arresto BA15s | *Brake  
light socket BA15s*

Marchio di omologazione E su riflettore/vetro |  
*E-mark on reflector/glass*

Vespa PX Millennium ('00>)

R.O. 583081





**FANALI COMPLETI - COMPLETE LIGHTS****246420170**

Con guarnizione, colore nero | *With gasket, black colour*

Portalampada fanale posteriore BA15s | *Rear light socket BA15s*

Portalampada luce di arresto BA15s | *Brake light socket BA15s*

Senza lampadine | *Without bulbs*

Coperchio grigio | *Grey cover*

Vespa 125 GTR ('70>) • Vespa 125 TS VNL3T  
• Vespa 150 Sprint Veloce • Vespa 180 Rally ('68>)

R.O. 121017

**246420180**

Con guarnizione | *With gasket*

Portalampada fanale posteriore lampada tubolare | *Rear light socket festoon bulb*

Portalampada luce di arresto BA15s | *Brake light socket BA15s*

Senza lampadine | *Without bulbs*

Vespa 125 Primavera • Vespa 125 Primavera ET3

R.O. 159430

**246420192**

Con guarnizione | *With gasket*

Portalampada fanale posteriore BA15s | *Rear light socket BA15s*

Portalampada luce di arresto BA15s | *Brake light socket BA15s*

Senza lampadine | *Without bulbs*

Marchio di omologazione E sul vetro | *E-mark on glass*

Vespa P 125X • Vespa P 150X • Vespa PX 125E  
• Vespa PX 150E • Vespa T5

R.O. 219091



246420200



Senza guarnizione | *Without gasket*  
 Alloggiamento di metallo | *Metal casing*  
 Portalampana fanale posteriore lampada  
 tubolare | *Rear light socket festoon bulb*  
 Portalampana luce di arresto lampada tubolare  
 | *Brake light socket festoon bulb*  
 Senza lampadine | *Without bulbs*  
 Marchio di omologazione IGM sul riflettore |  
*IGM mark on reflector*

Vespa 150 GS VBA1T dal telaio n.1001 al  
 n.110485 - *from chassis n.1001 to n.110485*  
 • Vespa 150 GS VS4T dal telaio n.0035311  
 al n. 0087589 - *from chassis n. 0035311 to*  
*n.0087589*



246420210



Con guarnizione | *With gasket*  
 Vespa T5  
 R.O. 232774



246420240



Cromato | *Chromed*  
 Portalampana fanale posteriore BA15s | *Rear*  
*light socket BA15s*  
 Portalampana luce di arresto BA15s | *Brake*  
*light socket BA15s*  
 Senza lampadine | *Without bulbs*  
 Marchio di omologazione E | *E-mark*  
 Vespa PX 125-150  
 R.O. 58269R



**FANALI COMPLETI - COMPLETE LIGHTS****246420242** **NEW**

Cromato | *Chromed*  
 Portalamпада fanale posteriore BA15s | *Rear light socket BA15s*  
 Portalamпада luce di arresto BA15s | *Brake light socket BA15s*  
 Vespa PX125-200 MY  
 Adatto per - *Suitable for Vespa PX 80-200 PE/Lusso/*  
 '98/MY/'11/T5 Classic  
 R.O. 583081, 58269R

**246420270**

Con guarnizione | *With gasket*  
 Portalamпада fanale posteriore BA15s | *Rear light socket BA15s*  
 Portalamпада luce di arresto BA15s | *Brake light socket BA15s*  
 Senza lampadine | *Without bulbs*  
 Marchio di omologazione E sul riflettore | *E-mark on reflector*  
 Vespa PK 50 • Vespa PK 125  
 R.O. 215966, 2159661

**246420280**

Con guarnizione | *With gasket*  
 Portalamпада fanale posteriore BA15s | *Rear light socket BA15s*  
 Portalamпада luce di arresto BA15s | *Brake light socket BA15s*  
 Senza lampadine | *Without bulbs*  
 Marchio di omologazione E sul riflettore | *E-mark on reflector*  
 Senza illuminazione della targa | *Without number plate light*  
 Vespa PK 50XL  
 R.O. 234225



## FANALI COMPLETI - COMPLETE LIGHTS

246420290



Con guarnizione | *With gasket*  
 Portalamпада fanale posteriore BA15s | *Rear light socket BA15s*  
 Portalamпада luce di arresto: - | *Brake light socket: -*  
 Senza lampadine | *Without bulbs*  
 Marchio di omologazione E sul riflettore | *E-mark on reflector*  
 Vespa PK 50  
 R.O. 216444



246420300



Marchio di omologazione E su riflettore/vetro | *E-mark on reflector/glass*  
 Vespa PX 125 Arcobaleno • Vespa PX 150 Arcobaleno • Vespa PX 200 Arcobaleno  
 R.O. 219094



## FRECCHE - BLINKERS

246480400



FRECCIA ANTERIORE DESTRA (Lente arancione) | *FRONT INDICATOR RIGHT (Orange lens)*  
 Portalamпада indicatore di direzione BA15s | *Indicator socket BA15s*  
 Senza lampadine | *Without bulbs*  
 Con marchio di omologazione E | *With E-mark*  
 Vespa P 125-150X • Vespa PX 125 • Vespa PX 150 • Vespa PX 200E • Vespa PX 125 Arcobaleno • Vespa PX 150 Arcobaleno • Vespa PX 200 Arcobaleno • Vespa 125 T5  
 R.O. 163256



**FRECCHE - BLINKERS****246480410****FRECCIA ANTERIORE SINISTRA***(Lente arancione) | FRONT INDICATOR LEFT  
(Orange lens)**Portalampada indicatore di direzione BA15s |  
Indicator socket BA15s**Senza lampadine | Without bulbs**Con marchio di omologazione E | With E-mark**Vespa P 125-150X • Vespa PX 125 • Vespa  
PX 150 • Vespa PX 200E • Vespa PX 125  
Arcobaleno • Vespa PX 150 Arcobaleno • Vespa  
PX 200 Arcobaleno • Vespa 125 T5  
R.O. 162817***246480420****FRECCIA POSTERIORE DESTRA***(Lente arancione) | REAR INDICATOR RIGHT  
(Orange lens)**Portalampada indicatore di direzione BA15s |  
Indicator socket BA15s**Senza lampadine | Without bulbs**Con marchio di omologazione E | With E-mark**Vespa P 125-150X • Vespa PX 125 • Vespa  
PX 150 • Vespa PX 200E • Vespa PX 125  
Arcobaleno • Vespa PX 150 Arcobaleno • Vespa  
PX 200 Arcobaleno • Vespa 125 T5  
R.O. 230339***246480430****FRECCIA POSTERIORE SINISTRA***(Lente arancione) | REAR INDICATOR LEFT  
(Orange lens)**Portalampada indicatore di direzione BA15s |  
Indicator socket BA15s**Senza lampadine | Without bulbs**Con marchio di omologazione E | With E-mark**Vespa P 125-150X • Vespa PX 125 • Vespa  
PX 150 • Vespa PX 200E • Vespa PX 125  
Arcobaleno • Vespa PX 150 Arcobaleno • Vespa  
PX 200 Arcobaleno • Vespa 125 T5  
R.O. 230338*

**246480405**



FRECCIA ANTERIORE DESTRA (Lente bianca) |  
 FRONT INDICATOR RIGHT (White lens)  
 Alloggiamento cromo | Chrome casing  
 Portalampada indicatore di direzione BA15s |  
 Indicator socket BA15s  
 Senza lampadine | Without bulbs  
 Con marchio di omologazione E | With E-mark  
 Vespa P 125-150X • Vespa PX 125 • Vespa  
 PX 150 • Vespa PX 200E • Vespa PX 125  
 Arcobaleno • Vespa PX 150 Arcobaleno • Vespa  
 PX 200 Arcobaleno • Vespa 125 T5  
 R.O. 583083



**246480415**



FRECCIA ANTERIORE SINISTRA (Lente bianca) |  
 FRONT INDICATOR LEFT (White lens)  
 Alloggiamento cromo | Chrome casing  
 Portalampada indicatore di direzione BA15s |  
 Indicator socket BA15s  
 Senza lampadine | Without bulbs  
 Con marchio di omologazione E | With E-mark  
 Vespa P 125-150X • Vespa PX 125 • Vespa  
 PX 150 • Vespa PX 200E • Vespa PX 125  
 Arcobaleno • Vespa PX 150 Arcobaleno • Vespa  
 PX 200 Arcobaleno • Vespa 125 T5  
 R.O. 583082



**246480425**



FRECCIA POSTERIORE DESTRA (Lente bianca) |  
 REAR INDICATOR RIGHT (White lens)  
 Alloggiamento cromo | Chrome casing  
 Portalampada indicatore di direzione BA15s |  
 Indicator socket BA15s  
 Senza lampadine | Without bulbs  
 Con marchio di omologazione E | With E-mark  
 Vespa P 125-150X • Vespa PX 125 • Vespa  
 PX 150 • Vespa PX 200E • Vespa PX 125  
 Arcobaleno • Vespa PX 150 Arcobaleno • Vespa  
 PX 200 Arcobaleno • Vespa 125 T5  
 R.O. 583085



**FRECCHE - BLINKERS****246480435****FRECCIA POSTERIORE SINISTRA** (Lente bianca) |  
*REAR INDICATOR LEFT* (White lens)Alloggiamento cromo | *Chrome casing*Portalamпада indicatore di direzione BA15s |  
*Indicator socket BA15s*Senza lampadine | *Without bulbs*Con marchio di omologazione E | *With E-mark*

Vespa P 125-150X • Vespa PX 125 • Vespa

PX 150 • Vespa PX 200E • Vespa PX 125

Arcobaleno • Vespa PX 150 Arcobaleno • Vespa

PX 200 Arcobaleno • Vespa 125 T5

R.O. 583084

**246480450****FRECCIA ANTERIORE SINISTRA**(Lente arancione) (Cromata) | *FRONT**INDICATOR LEFT* (Orange lens) (Chromed)

Vespa PX 125-150-200 • Vespa PXE 125-150-

200 • Vespa 125-150-200 T5

VNX-VLX1-VSX-VNX5T-VNX2-VLX2-VSX2

**246480460****FRECCIA ANTERIORE DESTRA** (Lente arancione)  
(Cromata) | *FRONT INDICATOR RIGHT*

(Orange lens) (Chromed)

Vespa PX 125-150-200 • Vespa PXE 125-150-

200 • Vespa 125-150-200 T5

VNX-VLX1-VSX-VNX5T-VNX2-VLX2-VSX2



246480470



FRECCIA POSTERIORE SINISTRA  
(Lente arancione) (Cromata) | *REAR INDICATOR  
LEFT (Orange lens) (Chromed)*

Vespa PX 125-150-200 • Vespa PXE 125-150-  
200 • Vespa 125-150-200 T5  
VNX-VLX1-VSX-VNX5T-VNX2-VLX2-VSX2



246480472 **NEW**



FRECCIA POSTERIORE SINISTRA (Lente bianca) |  
*REAR INDICATOR LEFT (White lens)*

Alloggiamento cromo | *Chrome casing*  
Portalampana indicatore di direzione BA15s |  
*Indicator socket BA15s*

Senza lampadine | *Without bulbs*  
Con marchio di omologazione E | *With E-mark*  
Vespa PX 125-150-200 • Vespa PXE 125-150-  
200 • Vespa 125-150-200 T5  
VNX-VLX1-VSX-VNX5T-VNX2-VLX2-VSX2



246480480



FRECCIA POSTERIORE DESTRA  
(Lente arancione) | *REAR INDICATOR RIGHT  
(Orange lens)*

Vespa PX 125-150-200 • Vespa PXE 125-150-  
200 • Vespa 125-150-200 T5  
VNX-VLX1-VSX-VNX5T-VNX2-VLX2-VSX2





**FRECCHE - BLINKERS****246480482**

FRECCIA POSTERIORE DESTRA (Lente bianca) |  
 REAR INDICATOR RIGHT (White lens)  
 Alloggiamento cromo | Chrome casing  
 Portalampada indicatore di direzione BA15s |  
 Indicator socket BA15s  
 Senza lampadine | Without bulbs  
 Con marchio di omologazione E | With E-mark  
 Vespa PX 125-150-200 • Vespa PXE 125-150-  
 200 • Vespa 125-150-200 T5  
 VNX-VLX1-VSX-VNX5T-VNX2-VLX2-VSX2

**246480455**

FRECCIA ANTERIORE SINISTRA (Lente Bianca) |  
 FRONT INDICATOR LEFT (White lens)  
 Alloggiamento cromo | Chrome casing  
 Portalampada indicatore di direzione BA15s |  
 Indicator socket BA15s  
 Senza lampadine | Without bulbs  
 Con marchio di omologazione E | With E-mark  
 Vespa PX 125-150-200 • Vespa PXE 125-150-  
 200 • Vespa 125-150-200 T5  
 VNX-VLX1-VSX-VNX5T-VNX2-VLX2-VSX2  
 R.O. 638761

**246480465**

FRECCIA ANTERIORE DESTRA (Lente Bianca) |  
 FRONT INDICATOR RIGHT (White lens)  
 Alloggiamento cromo | Chrome casing  
 Portalampada indicatore di direzione BA15s |  
 Indicator socket BA15s  
 Senza lampadine | Without bulbs  
 Con marchio di omologazione E | With E-mark  
 Vespa PX 125-150-200 • Vespa PXE 125-150-  
 200 • Vespa 125-150-200 T5  
 VNX-VLX1-VSX-VNX5T-VNX2-VLX2-VSX2  
 R.O. 638762



246480475



FRECCIA POSTERIORE SINISTRA (Lente Bianca)

| REAR INDICATOR LEFT (White lens)

Alloggiamento cromo | Chrome casing

Portalampada indicatore di direzione BA15s |

Indicator socket BA15s

Senza lampadine | Without bulbs

Con marchio di omologazione E | With E-mark

Vespa PX 125-150-200 • Vespa PXE 125-150-

200 • Vespa 125-150-200 T5

VNX-VLX1-VSX-VNX5T-VNX2-VLX2-VSX2

R.O. 638763



246480485



FRECCIA POSTERIORE DESTRA (Lente Bianca) |

REAR INDICATOR RIGHT (White lens)

Alloggiamento cromo | Chrome casing

Portalampada indicatore di direzione BA15s |

Indicator socket BA15s

Senza lampadine | Without bulbs

Con marchio di omologazione E | With E-mark

Vespa PX 125-150-200 • Vespa PXE 125-150-

200 • Vespa 125-150-200 T5

VNX-VLX1-VSX-VNX5T-VNX2-VLX2-VSX2

R.O. 638764



246480504



FRECCIA ANTERIORE SINISTRA

(Lente arancione) | FRONT INDICATOR LEFT

(Orange lens)

Senza lampadine | Without bulbs

Vespa 50 FL • Vespa 50 FL2 • Vespa FL2 50 HP

• Vespa 50 N • Vespa PK 50XL • Vespa 125 FL •

Vespa PK 125XL

R.O. 233970



**FRECCHE - BLINKERS****246480505****FRECCIA ANTERIORE DESTRA (Lente arancione)**  
| *FRONT INDICATOR RIGHT (Orange lens)*Senza lampadine | *Without bulbs*Vespa 50 FL • Vespa 50 FL2 • Vespa FL2 50 HP  
• Vespa 50 N • Vespa PK 50XL • Vespa 125 FL •  
Vespa PK 125XL

R.O. 233971

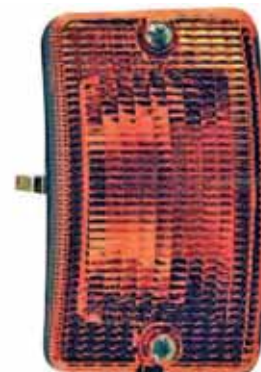
**246480506** **NEW****FRECCIA POSTERIORE SINISTRA**  
(Lente arancione) | *REAR INDICATOR LEFT*  
(Orange lens)Senza lampadine | *Without bulbs*Portalampada indicatore di direzione BA15s |  
*Indicator socket BA15s*Senza guarnizione | *Without gasket*Con marchio di omologazione E sul vetro |  
*With E-mark on the glass*

Vespa PK • Vespa FL • Vespa HP

R.O. 234061

**246480507** **NEW****FRECCIA POSTERIORE DESTRA**  
(Lente arancione) | *REAR INDICATOR RIGHT*  
(Orange lens)Senza lampadine | *Without bulbs*Portalampada indicatore di direzione BA15s |  
*Indicator socket BA15s*Senza guarnizione | *Without gasket*Con marchio di omologazione E sul vetro |  
*With E-mark on the glass*

Vespa PK • Vespa FL • Vespa HP

R.O. 234065



## LENTI FRECCIA - BLINKERS LENSES

**246470365**



ARANCIO

ANTERIORE SINISTRA (Arancione) | *FRONT LEFT (Orange)*

Senza guarnizione | *Without gasket*

Con marchio di omologazione E | *With E-mark*

Vespa PX PE 125-150-200 • Vespa PX PE 125-150-200 Arcobaleno • Vespa 125 T5

R.O. 185976



**246470375**



ARANCIO

ANTERIORE DESTRA (Arancione) | *FRONT RIGHT (Orange)*

Senza lampadine | *Without bulbs*

Senza guarnizione | *Without gasket*

Con marchio di omologazione E | *With E-mark*

Vespa PX PE 125-150-200 • Vespa PX PE 125-150-200 Arcobaleno • Vespa 125 T5

R.O. 185977



**246470360**



TRASPARENTE

ANTERIORE SINISTRA (Bianca) | *FRONT LEFT (White)*

Senza lampadine | *Without bulbs*

Senza guarnizione | *Without gasket*

Con marchio di omologazione E | *With E-mark*

Vespa PX PE 125-150-200 • Vespa PX PE 125-150-200 Arcobaleno • Vespa 125 T5

R.O. 196896

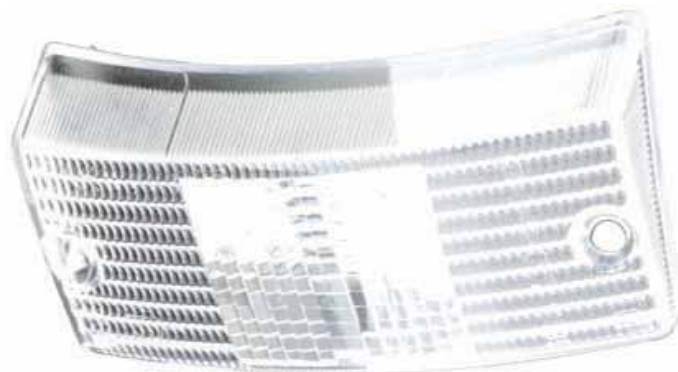

**LENTI FRECCIA - BLINKERS LENSES****246470370**

TRASPARENTE

ANTERIORE DESTRA (Bianca) | *FRONT RIGHT*  
(White)Senza lampadine | *Without bulbs*Senza guarnizione | *Without gasket*Con marchio di omologazione E | *With E-mark*Vespa PX PE 125-150-200 • Vespa PX PE 125-  
150-200 Arcobaleno • Vespa 125 T5  
R.O. 196897**246470385**

ARANCIO

POSTERIORE SINISTRA (Arancione) | *REAR LEFT*  
(Orange)Senza lampadine | *Without bulbs*Senza guarnizione | *Without gasket*Con marchio di omologazione E | *With E-mark*Vespa PX PE 125-150-200 • Vespa PX PE 125-  
150-200 Arcobaleno • Vespa 125 T5  
R.O. 185978**246470395**

ARANCIO

POSTERIORE DESTRA (Arancione) | *REAR RIGHT*  
(Orange)Senza lampadine | *Without bulbs*Senza guarnizione | *Without gasket*Con marchio di omologazione E | *With E-mark*Vespa PX PE 125-150-200 • Vespa PX PE 125-  
150-200 Arcobaleno • Vespa 125 T5  
R.O. 185979

246470380



TRASPARENTE

POSTERIORE SINISTRA (Bianca) | REAR LEFT

(White)

Senza lampadine | Without bulbs

Senza guarnizione | Without gasket

Con marchio di omologazione E | With E-mark

Vespa PX PE 125-150-200 • Vespa PX PE 125-

150-200 Arcobaleno • Vespa 125 T5

R.O. 196898



246470390



TRASPARENTE

POSTERIORE DESTRA (Bianca) | REAR RIGHT

(White)

Senza lampadine | Without bulbs

Senza guarnizione | Without gasket

Con marchio di omologazione E | With E-mark

Vespa PX PE 125-150-200 • Vespa PX PE 125-

150-200 Arcobaleno • Vespa 125 T5

R.O. 196899



246470615



ARANCIO

POSTERIORE DESTRA (Arancione) | REAR RIGHT

(Orange)

Senza lampadine | Without bulbs

Senza guarnizione | Without gasket

Con marchio di omologazione E | With E-mark

Vespa 50 FL • Vespa 50 FL2 • Vespa 50 FL2 HP

• Vespa 50 N • Vespa PK 50XL • Vespa 125 FL •

Vespa PK 125XL

R.O. 234778



**LENTI FRECCIA - BLINKERS LENSES****246470625**

ARANCIO

**POSTERIORE SINISTRA (Arancione) | REAR LEFT**  
(Orange)Senza lampadine | *Without bulbs*Senza guarnizione | *Without gasket*Con marchio di omologazione E | *With E-mark*Vespa 50 FL • Vespa 50 FL2 • Vespa 50 FL2 HP  
• Vespa 50 N • Vespa PK 50XL • Vespa 125 FL •  
Vespa PK 125XL

R.O. 234774

**246470635**

ARANCIO

**ANTERIORE DESTRA (Arancione) | FRONT RIGHT**  
(Orange)Senza lampadine | *Without bulbs*Senza guarnizione | *Without gasket*Con marchio di omologazione E | *With E-mark*Vespa 50 FL • Vespa 50 FL2 • Vespa 50 FL2 HP  
• Vespa 50 N • Vespa PK 50XL • Vespa 125 FL •  
Vespa PK 125XL

R.O. 234772

**246470645**

ARANCIO

**ANTERIORE SINISTRA (Arancione) | FRONT LEFT**  
(Orange)Senza lampadine | *Without bulbs*Senza guarnizione | *Without gasket*Con marchio di omologazione E | *With E-mark*Vespa 50 FL • Vespa 50 FL2 • Vespa 50 FL2 HP  
• Vespa 50 N • Vespa PK 50XL • Vespa 125 FL •  
Vespa PK 125XL

R.O. 234769



246470406



ROSSO

LENTE FANALE POSTERIORE | REAR LENS

Senza lampadine | Without bulbs

Riflettore con cornice in alluminio | Reflector with aluminium frame

Vespa 90 • Vespa 90 Sprint • Vespa 125 •

Vespa 125 Primavera ('63-'66)

R.O. 78627



246470416



ROSSO

LENTE FANALE POSTERIORE | REAR LENS

Senza lampadine | Without bulbs

Riflettore con cornice in alluminio | Reflector with aluminium frame

Vespa 50 1° serie ('63>)

R.O. 78715



246470426



ROSSO

LENTE FANALE POSTERIORE | REAR LENS

Senza lampadine | Without bulbs

Con marchio di omologazione IGM sul riflettore | With IGM mark on reflector

Vespa 125 VNB 1-2-3-4-5 ('60-'64) • Vespa 150

('59-'65) • Vespa 150 GS ('59-'64) • Vespa 150

VBB ('59-'64)

R.O. 89441





**LENTI FANALI - COMPLETE LIGHTS LENSES****246470436**MADE  
IN ITALY

ROSSO

**LENTE FANALE POSTERIORE | REAR LENS**Senza lampadine | *Without bulbs*Con marchio di omologazione IGM sul riflettore/  
vetro | *With IGM mark on reflector/glass*Vespa 125 ('65>) • Vespa 125 Super ('66>) •  
Vespa 150 Super ('66>) • Vespa GL • Vespa 150  
Sprint ('64-'66) • Vespa 180 SS (> '65)  
R.O. 097440**246470446**MADE  
IN ITALY

ROSSO

**LENTE FANALE POSTERIORE | REAR LENS**Senza lampadine | *Without bulbs*Con marchio di omologazione E sul riflettore |  
*With E-mark on reflector*Vespa 125 Super ('66>) • Vespa 150 Super  
( '66>) • Vespa 150 Sprint ('65-'74) • Vespa 180  
SS ('65-'68)  
R.O. 150369**246470455**MADE  
IN ITALY

ROSSO

**LENTE FANALE POSTERIORE | REAR LENS**Senza lampadine | *Without bulbs*Con visiera grigia | *With grey upper visor*Vespa 50 Special ('69-'72) • Vespa Special 50  
Elestart ('72-'75)  
R.O. 125681**246470456**MADE  
IN ITALY

ROSSO

**LENTE FANALE POSTERIORE | REAR LENS**Senza lampadine | *Without bulbs*Con visiera nera | *With black upper visor*Vespa 50 Special ('69-'71)  
R.O. 125681

246470486



ROSSO

LENTE FANALE POSTERIORE | REAR LENS

Senza lampadine | Without bulbs

Riflettore con cornice in alluminio | Reflector with aluminium frame

Con marchio di omologazione E sul riflettore/vetro | With E-mark on reflector/glass

Vespa dal V5A1T esemplari fino al '66-'67 - from V5A1T to '66-'67



246470496



ROSSO

LENTE FANALE SUPERIORE POSTERIORE | UPPER REAR LENS

Senza lampadine | Without bulbs

Vespa 150 GS VBA1T • Vespa 150 GS VS4T  
produzione dal '59 - production since '59



246470506



ROSSO

LENTE FANALE POSTERIORE | REAR LENS

Senza lampadine | Without bulbs

Con marchio di omologazione E | With E-mark

Vespa P 125-150X • Vespa P 200E • Vespa PX 125 • Vespa PX 150 • Vespa PX 200E

R.O. 162741



246470516



ROSSO

LENTE FANALE POSTERIORE | REAR LENS

Senza lampadine | Without bulbs

Vespa PX Millennium ('00>)



**LENTI FANALI - COMPLETE LIGHTS LENSES****246470566**

LENTE FANALE POSTERIORE | *REAR LENS*  
 Senza lampadine | *Without bulbs*  
 Con marchio di omologazione E | *With E-mark*  
 Vespa P 125X • Vespa P 150X • Vespa PX •  
 Vespa P 200E • Vespa PX 200E  
 R.O. 162741

**246470576**

LENTE FANALE POSTERIORE | *REAR LENS*  
 Senza lampadine | *Without bulbs*  
 Con marchio di omologazione E | *With E-mark*  
 Vespa PX 125-150-200 • Vespa PXE 125-150-  
 200 Arcobaleno  
 R.O. 219094

**ACCESSORI FANALI E FRECCHE - LIGHTS AND BLINKERS ACCESSORIES****142710010**

CORNICE FARO | *HEADLIGHT RIM*  
 Per fanale 246410100 | *For headlight*  
 246410100  
 Cromata | *Chromed*  
 Vespa 50 Special  
 R.O. 124200

**142710020**

CORNICE FARO | *HEADLIGHT RIM*  
 Per fanale Ø115 mm | *Per fanale Ø115 mm*  
 Diametro Ø135 mm | *Diameter Ø135 mm*  
 Cromata | *Chromed*  
 Vespa 50 SS • Vespa 90 SS • Vespa 125 ('65-  
 '66) • Vespa 125 Super • Vespa 150 Super ('66->  
 • Vespa 125 Primavera ET3  
 R.O. 151742



142710030



CORNICE FARO | HEADLIGHT RIM

Per fanale 246410040 - 246410110 Ø105 mm |

For headlight 246410040 - 246410110 Ø105 mm

Diametro Ø125 mm | Diameter Ø125 mm

Cromata | Chromed

Vespa 50 ('69-'71) • Vespa 50 S ('63-'68) •

Vespa 50 L ('66-'70) • Vespa 50 R ('70-'83)

R.O. 151731



142710040



CORNICE FARO | HEADLIGHT RIM

Cromata | Chromed

Vespa 125 GT • Vespa 150 GL • Vespa 150

Sprint • Vespa 180 SS

R.O. 070543



142710050



CORNICE FARO | HEADLIGHT RIM

Per fanale 246410070 Ø130 mm | For headlight

246410070 Ø130 mm

Diametro Ø130 mm | Diameter Ø130 mm

Cromata | Chromed

Vespa 125 GTR • Vespa 125 TS • Vespa 150

Sprint Veloce • Vespa 180-200 Rally

R.O. 113891



142710060



CORNICE FARO | HEADLIGHT RIM

Per fanale Ø140 mm | For headlight Ø140 mm

Diametro Ø160 mm | Diameter Ø160 mm

Cromata | Chromed

Vespa PX 125-150-200



**ACCESSORI FANALI E FRECCHE - LIGHTS AND BLINKERS ACCESSORIES****142710070**

CORNICE FARO | HEADLIGHT RIM

Diametro Ø95 mm | Diameter Ø95 mm

Cromata | Chromed

Vespa 125 ('62-'65) • Vespa 150 ('59-'65) •

Vespa GS ('59-'64) •

Vespa VBA VBB ('59-'62)

R.O. 084489

**142710080**

CORNICE FARO | HEADLIGHT RIM

Per fanale Ø115 mm | For headlight Ø115 mm

Diametro Ø115 mm | Diameter Ø115 mm

Cromata | Chromed

Vespa 150 VB1T ('57-'58) • Vespa 150 GS VS1-2-

3-4 ('56-'58)

R.O. 025576

**142710090**

CORNICE FARO | HEADLIGHT RIM

Per fanale Ø115 mm | For headlight Ø115 mm

Diametro Ø115 mm | Diameter Ø115 mm

Cromata | Chromed

Vespa 150 VB1T ('57-'58) • Vespa 150 GS VS1-2-

3-4 ('56-'58)

R.O. 025576, 1R000191

**142710100**

CORNICE FARO | HEADLIGHT RIM

Per fanale Ø105 mm | For headlight Ø105 mm

Diametro Ø105 mm | Diameter Ø105 mm

Cromata | Chromed

Vespa 125 VM1T ('53) • Vespa 125 VM2T ('54)

R.O. 018088



142710110



CORNICE FARO | HEADLIGHT RIM

Per fanale Ø105 mm | For headlight Ø105 mm

Diametro Ø105 mm | Diameter Ø105 mm

Cromata | Chromed

Vespa 150 VL2 ('55-'56) • Vespa 150 VL3 ('56)

R.O. 025092



142710120



CORNICE FARO | HEADLIGHT RIM

Per fanale Ø105 mm | For headlight Ø105 mm

Diametro Ø105 mm | Diameter Ø105 mm

Cromata | Chromed

Vespa 125 VNA1T ('58) • Vespa 125 VNA2T ('58-'59) • Vespa VNB1T ('60) • Vespa VNB2T ('61)

R.O. 082079



142710130



CORNICE FARO | HEADLIGHT RIM

Per fanale Ø105 mm | For headlight Ø105 mm

Diametro Ø105 mm | Diameter Ø105 mm

Cromata | Chromed

Vespa 125 VN1T ('55) • Vespa 125 VN2T ('56)

R.O.026009



142710140



CORNICE FARO | HEADLIGHT RIM

Per fanale Ø105 mm | For headlight Ø105 mm

Diametro Ø105 mm | Diameter Ø105 mm

Cromata | Chromed

Vespa 150 VL1 ('55)

R.O. 48300



**ACCESSORI FANALI E FRECCHE - LIGHTS AND BLINKERS ACCESSORIES****246470466**CATADIOTTRO FANALE POSTERIORE |  
REFLECTOR REAR LENSPer fanale 246420070 | For rearlight  
246420070Con marchio di omologazione IGM sul riflettore  
| With IGM mark on reflectorVespa 125 VN1-2 • Vespa VNA1-2 ('58) • Vespa  
150 VL1-2-3 • Vespa VB1 ('58) • Vespa 150 GS  
VS1-2-3 ('58)  
R.O. 020914**246470476**CATADIOTTRO FANALE POSTERIORE |  
REFLECTOR REAR LENSPer fanale 246420080 | For rearlight  
246420080Con marchio di omologazione E sul riflettore |  
With E-mark on reflectorVespa 125 VM1-2 • Vespa 125 VU1T  
R.O. F6398-1**121830880**CAPPuccio FRECCIA ANTERIORE | FRONT  
BLINKER CAPVespa PX 125-150-200 • Vespa T5 • Vespa PXE  
125-150-200  
R.O. 182599

121830890



CAPPUCCIO FRECCIA POSTERIORE | REAR

BLINKER CAP

Vespa PX 125-150-200 • Vespa PXE 125-150-

200 • Vespa T5

R.O. 230320



121830853



SUPPORTO ELASTICO RELÈ FRECCHE | RELAIS

ELASTIC BRACKET

Vespa PX 125-150-200 • Vespa T5 • Cosa 1-2

R.O. 291017, 290222, 292341, 164343



246420100



GUARNIZIONE FANALE POSTERIORE | REAR

LIGHT GASKET

Per fanale 246420010 | For rearlight

246420010

Vespa 90 • Vespa 90 Sprint • Vespa 125 •

Vespa 125 Primavera ('63-'66)

R.O. 71193



246420110



GUARNIZIONE FANALE POSTERIORE | REAR

LIGHT GASKET

Vespa 50 1° serie ('63->)

R.O. 4588





**ACCESSORI FANALI E FRECCHE - LIGHTS AND BLINKERS ACCESSORIES****246420120**GUARNIZIONE FANALE POSTERIORE | REAR  
LIGHT GASKETVespa 125 VNB 1-2-3-4-5 ('60-'64) • Vespa 150 ('59-'65) • Vespa 150 GS ('59-'64) • Vespa 150 VBB ('59-'64)  
R.O. 89222**246420130**GUARNIZIONE FANALE POSTERIORE | REAR  
LIGHT GASKETVespa 125 ('65>) • Vespa Super 125 ('66>) • Vespa Super 150 ('66>) • Vespa GL • Vespa 150 Sprint ('64-'66) • Vespa 180 SS (>'65)  
R.O. 70767**246480440**

SPIE INDICATRICI | INDICATOR LIGHTS

Vespa PX 125 1° serie • Vespa PX 150 1° serie • Vespa PX 200 1° serie  
R.O. 139980, 163682**246490340**

CAVO FRECCHE | BLINKER CABLE

Interno cofano | Inner sidepanels  
Vespa PX tutti i modelli - all models

246472000



PORTALAMPADA FANALE ANTERIORE | *FRONT LIGHT BULB SOCKET*

Per fanale 246410080 | *For headlight 246410080*

Piedistallo abbaglianti e anabbaglianti BA20d | *Main and dipped beam socket BA20d*

Luce di posizione BA15s | *Parking light socket BA15s*

Forma di trapezio | *Trapezoidal*

Vespa 125 GT • Vespa 150 GL • Vespa 150

Sprint • Vespa 180 SS

R.O. 97406



246472010



PORTALAMPADA FANALE ANTERIORE | *FRONT LIGHT BULB SOCKET*

Per fanale 246410060 | *For headlight 246410060*

Piedistallo abbaglianti e anabbaglianti BA20d | *Main and dipped beam socket BA20d*

Luce di posizione BA15s | *Parking light socket BA15s*

Vespa 50 SS • Vespa 90 SS • Vespa 125 ('65-'66) • Vespa 125 Super • Vespa 150 Super ('66)

• Vespa 125 Primavera • Vespa 125 Primavera ET3 ('62-'65) • Vespa 150 ('59-'65) • Vespa GS ('59-'64) • Vespa GL ('59-'62) • Vespa GTR •

Vespa 125 TS • Vespa 150 Sprint Veloce • Vespa 180 Rally • Vespa 200 Rally

R.O. 92780



**PORTALAMPADA - HOLDERS FOR BULBS****246472020**PORTALAMPADA FANALE ANTERIORE | *FRONT LIGHT BULB SOCKET*Per fanale 246410090 | *For headlight 246410090*Piedistallo abbaglianti e anabbaglianti BA20d | *Main and dipped beam socket BA20d*Luce di posizione BA15s | *Parking light socket BA15s*Vespa PX PE 125-150-200 • Vespa PX PE 125-150-200 Arcobaleno  
R.O. 162926**246472030**PORTALAMPADA FANALE ANTERIORE | *FRONT LIGHT BULB SOCKET*Per fanale 246410190 | *For headlight 246410190*Piedistallo abbaglianti e anabbaglianti BA20d | *Main and dipped beam socket BA20d*Vespa 125 VNA1T ('58)-VNA2T ('58-'59)-VNB1T ('60)-VNB2T ('61)  
R.O. 87311**246472040**PORTALAMPADA FANALE ANTERIORE | *FRONT LIGHT BULB SOCKET*Per fanale 246410210 | *For headlight 246410210*Piedistallo abbaglianti e anabbaglianti BA20d | *Main and dipped beam socket BA20d*Vespa 125 VM1T ('53)-VM2 ('54)-VN1T ('55)-VN2T ('56) • Vespa 150 VL1 ('55) • Vespa 150 VL2 ('55-'56)-VL3 ('56) • Vespa 150 VB1T ('57-'58) • Vespa 150 GS VS1T ('55) - VS2T 2-3-4-t ('56-'58)  
R.O. 25972

## PORTALAMPADA - HOLDERS FOR BULBS

246472090



PORTALAMPADA PER LAMPADINE T10 WB |  
HOLDER FOR T10 WB BULBS

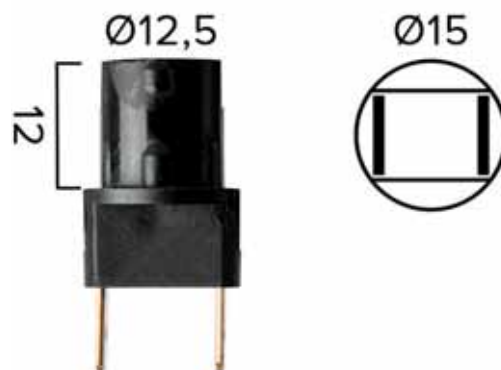

## PULSANTI - BUTTONS

246130050



PULSANTE SPEGNIMENTO | STOP BUTTON

Vespa 200 Rally  
R.O. 073185



246135060



PULSANTE AVVIAMENTO | START BUTTON

Vespa PX  
Veicoli con freno a disco | For brake disc  
models  
R.O. 580937



## DEVIO FRECCHE - BLINKERS SWITCHES

246110040



6 cavi | 6 wires

Senza batteria | Without battery

Vespa PX 125 • Vespa PX 150 • Vespa PX 200  
R.O. 215669



**DEVIO FRECCHE - BLINKERS SWITCHES****246110070**

6 cavi | 6 wires

1 multi connettore (6 pins) | 1 multi plug (6 pins)

Senza e-start | Without e-start

Vespa PK 50 • Vespa PK 50XL • Vespa Rush •  
Vespa N • Vespa PK 125XL • Vespa S • Vespa  
125-150-200E Arcobaleno ('83>) • Vespa PX 125  
• Vespa T5

R.O. 580395

**246110140****NEW**

Cromato | Chromed

Vespa 50-125 PV/ET3

Adatto per - Suitable for Vespa VNA-TS • Vespa

150 VBA-T4 • Vespa 160 GS • Vespa 180 SS •

Vespa Rally

R.O. 061350

**DEVIO LUCI - LIGHTS SWITCHES****246090050**

Contatto di chiusura | Function: shutter

Pulsante clacson ad angolo | Square horn  
button

Con batteria | With battery

Cromato | Chromed

Vespa 150 ('63) • Vespa GL • Vespa Sprint •

Vespa Super

R.O. 087558

**246090060**

Contatto di apertura | Function: opener

Pulsante clacson rotondo | Round horn button

3 posizioni | 3 settings

Cromato | Chromed

Vespa 125 Primavera • Vespa 125 GT • Vespa

GTR • Vespa TS

R.O. 092041



**246090070**



Contatto di apertura | *Function: opener*  
 Pulsante clacson rotorondo | *Round horn button*  
 2 posizioni | *2 settings*  
 Con luce abbagliante/anabbagliante | *With high-/ low beam*  
 Cromato | *Chromed*  
 Vespa 50 • Vespa 50 R • Vespa 50 L  
 R.O. 092654



**246090080**



Contatto di apertura | *Function: opener*  
 Pulsante clacson rotorondo | *Round horn button*  
 3 posizioni | *3 settings*  
 Cromato | *Chromed*  
 Vespa 125 Primavera ET3  
 R.O. 143324



**246090090**



Contatto di apertura | *Function: opener*  
 9 cavi | *9 wires*  
 Vespa PX 125 • Vespa PX 150 • Vespa PX 200  
 R.O. 215668



**246090100**



Contatto di apertura | *Function: opener*  
 7 cavi | *7 wires*  
 1 multi connettore (5 pins) | *1 multi plug (5 pins)*  
 Senza batteria - senza avviamento elettrico | *Without battery and electric starter*  
 Vespa PX 125-150-200E Arcobaleno('83>) •  
 Vespa PK 125 S - estero • Vespa PX 125 E ('82>)  
 - estero  
 R.O. 217898



**DEVIO LUCI - LIGHTS SWITCHES****246090110**

Contatto di apertura | *Function: opener*  
 Pulsante clacson rotondo | *Round horn button*  
 Luce on/off, luce alta/bassa | *Light on/off, high/low beam*  
 Con pulsante spegnimento | *With kill-switch*  
 7 cavi | *7 wires*  
 Solo 6 Volt possibili, poiché dotato di funzione anti-corto circuito | *Only 6 volts possible due to short-circuit function*  
 Vespa 50 Special  
 R.O. 123152

**246090240**

Contatto di chiusura | *Function: shutter*  
 Pulsante clacson ad angolo | *Square horn button*  
 Cromato | *Chromed*  
 Vespa 50 • Vespa 50 S • Vespa 50 SS  
 R.O. 073169

**246090260**

Contatto di chiusura | *Function: shutter*  
 10 cavi | *10 wires*  
 3 multi connettori | *3 multi plugs*  
 Con batteria | *With battery*  
 Vespa PXE 125-150-200 Arcobaleno  
 R.O. 583090



**246070040**



6V C.A. - 18-24 W

Modelli senza batteria | *No battery models*

Diametro Ø72 mm | *Diameter Ø72 mm*

Barra fissaggio 4 fori | *Mounting plate 4 holes*

Cromato | *Chromed*

Vespa 50 V5A1T ('63-'67) - V5SS ('66-'71) •

Vespa 90 V9A1 ('63-'67) • Vespa 90 V9SS ('65-

'71) • Vespa 125 Primavera • Vespa 125 ET3

R.O. 070300



**246070050**



12V C.A. - 18-24 W

Modelli senza batteria | *No battery models*

Diametro Ø72 mm | *Diameter Ø72 mm*

Zincato | *Galvanized*

Vespa P 125X • Vespa P 150X • Vespa P 200E

('77-'82) • Vespa PX Arcobaleno ('83>) • Vespa

P 150S ('78>)

Veicoli con frecce - *models with blinkers*

R.O. 189379,163599,148436



**246070100**



12V D.C.

Modelli con batteria | *Models with battery*

Diametro Ø72 mm | *Diameter Ø72 mm*

Barra fissaggio 2 fori | *Mounting plate 2 holes*

Staffa foro Ø 4 mm | *Bracket hole Ø 4 mm*

Vespa PX 125-200 Arcobaleno • Vespa PK •

Vespa PX Arcobaleno ('84>) • Vespa PK 80 •

Vespa PK 125 S • Vespa Automatica ('84>)

R.O. 58144R, 216904, 216903, 264094

(Piaggio) 264094 (LML)





**AVVISATORI ACUSTICI - HORNS****246070140**

6V C.A.

Modelli senza batteria | *No battery models*Diametro Ø72 mm | *Diameter Ø72 mm*Barra fissaggio 4 fori | *Mounting plate 4 holes*

Vespa 125 V1T-V15T • Vespa 125 V30T-V33T -

fino al '52 - *till '52*

R.O. 011635

**246070150**

6V C.A.

Modelli senza batteria | *No battery models*Diametro Ø72 mm | *Diameter Ø72 mm*Barra fissaggio 4 fori | *Mounting plate 4 holes*

Vespa 125-150 VM1/2T-VUU1T ('53-'57)

R.O. 020250

**246070160**

6V C.A.

Modelli senza batteria | *No battery models*Diametro Ø72 mm | *Diameter Ø72 mm*Barra fissaggio 4 fori | *Mounting plate 4 holes*Cromato | *Chromed*

Vespa 150 VL3T-VB1T ('56-'57)

R.O. 025714

**246070170**

6V C.C.

Modelli con batteria | *Models with battery*Diametro Ø72 mm | *Diameter Ø72 mm*Barra fissaggio 4 fori | *Mounting plate 4 holes*Cromato | *Chromed*

Vespa 150 VL3T-VB1T ('56-'57)

R.O. 025714B



**246070180**



6V C.A.

Modelli senza batteria | *No battery models*

Diametro Ø72 mm | *Diameter Ø72 mm*

Barra fissaggio 6 fori | *Mounting plate 6 holes*

Cromato | *Chromed*

Vespa 50 V5A1T ('63-'67) - V5SS ('66-'71) •

Vespa 90 V9A1 ('63-'67)-V9SS ('65-'71) • Vespa

125 VNB 3-4 ('61-'63)

R.O. 093753



**246070190**



6V C.A.

Modelli senza batteria | *No battery models*

Diametro Ø72 mm | *Diameter Ø72 mm*

Barra fissaggio 4 fori | *Mounting plate 4 holes*

Cromato | *Chromed*

Vespa 50 ('65-'68) • Vespa 125 Super • Vespa

150 Super • Vespa 150 Sprint 1° Serie • Vespa

150 VBB2 ('63-'65)

R.O. 097828



**246070210**



6/12V C.C.

Modelli con batteria | *Models with battery*

Diametro Ø72 mm | *Diameter Ø72 mm*

Barra fissaggio 4 fori | *Mounting plate 4 holes*

Cromato | *Chromed*

Vespa 150 GS VS2T-3-4-5 ('56-'61) • Vespa 160

GS VSB ('62-'64)

R.O. 028249



**246070220**



6V C.A.

Modelli senza batteria | *No battery models*

Diametro Ø72 mm | *Diameter Ø72 mm*

Barra fissaggio 4 fori | *Mounting plate 4 holes*

Cromato | *Chromed*

Vespa 150 VBA-VBB ('59-'66)

R.O. 089840



**INTERRUTTORI - SWITCHES****246140080****INTERRUTTORE STOP | BRAKE LIGHT SWITCH**Pulsante nero | *Black switch*Vespa 50 ('67-'82) • Vespa 125 Primavera •  
Vespa Primavera ET3 • Vespa PX PE  
R.O. 181878**246140090****INTERRUTTORE STOP | BRAKE LIGHT SWITCH**Pulsante rosso | *Red switch*Vespa 50 FL ('90) • Vespa 125 FL ('89-'90) •  
Vespa 50 FL2 HP ('91-'97) • Vespa 50 N ('89-'90) •  
Vespa PK 50 ('82-'84) • Vespa PK 50XL ('85-'88) •  
Vespa PK 125XL ('86-'89) • Vespa PK 50XL Rush ('88-'89) •  
Vespa PX 125 ('98-'01) • Vespa PX 125 ('11-'12) •  
Vespa PX 150 ('11-'12) • Vespa PX 125 30 anni ('07-'08) •  
Vespa PX 125 EU2 ('01-'07) • Vespa 125 T5 ('85-'89) •  
Vespa PXE 125 Arcobaleno ('81-'97)  
R.O. 181881**246140110****INTERRUTTORE STOP | BRAKE LIGHT SWITCH**Vespa 125 VNB1T ('60) • Vespa 150 VBA1T ('59-'60)/VBB1T ('61-'62) •  
Vespa 150 GL VLA1T ('63-'64) • Vespa 150 GS VS4T ('58)/VS5T ('59-'61) •  
Vespa 160 GS VSB1T ('62-'64) • Vespa 180 SS VSC1T ('65-'68)  
R.O. 181637**246140140****INTERRUTTORE STOP | BRAKE LIGHT SWITCH**Interruttore "a tirare" | *Pull switch type*Per modelli Vespa fino al 1957 | *For Vespa models until 1957*Vespa vecchi modelli | *Vespa old models*  
R.O. 610200M

## INTERRUTTORI - SWITCHES

246140150



INTERRUTTORE STOP | BRAKE LIGHT SWITCH

Interruttore "a tirare" | Pull switch type

Per modelli Vespa fino al 1957 | For Vespa models until 1957

Vespa vecchi modelli | Vespa old models

R.O. 610201M



246140500



INTERUTTORE CONSENSO AVVIAMENTO |

SWITCH START

Vespa N • Vespa PK • Vespa PX • Vespa PXE

Veicoli con freno a disco | Models with brake disc

R.O. 583330 ex 219337



## RELÈ - RELAYS

246120010



RELÈ FRECCHE | BLINKERS RELAYS

6-12V, 10-21 Watt

3 terminali | 3 pins

Vespa PX 125-150 • Vespa PX EU2 • Vespa PXE

Arcobaleno • Vespa PX 30 anni • Vespa 125 T5

• Cosa • Vespa PK tutti i tipi - all models

R.O. 163968, 195703



246120011



RELÈ FRECCHE | BLINKERS RELAYS

6-12V, 10-21 Watt

3 terminali | 3 pins

Vespa PX 125-150 • Vespa PX EU2 • Vespa PXE

Arcobaleno • Vespa PX 30 anni • Vespa 125 T5

• Cosa • Vespa PK tutti i tipi - all models

R.O. 163968, 195704



**RELÈ - RELAYS****246120173**RELÈ FRECCHE | *BLINKERS RELAYS*

12V 21W

2 terminali | 2 pins

Avvisatore acustico | *Buzzer*Vespa PX/Cosa/T5 125 ('85-'12) • Vespa PX/  
Cosa/T5 150 ('85-'12) • Vespa PX/Cosa/T5 200  
( '85-'12)

R.O. 231284

**246400093**RELÈ AVVIAMENTO STARTER ELETTRICO |  
*ELECTRIC STARTER RELAYS*

12V 80A

4 terminali | 4 pins

Vespa PX 125-150-200 • Vespa PXE Arcobaleno  
• Vespa T5

R.O. 218824

**246400111**RELÈ AVVIAMENTO STARTER ELETTRICO |  
*ELECTRIC STARTER RELAYS*

12V 80A

4 terminali | 4 pins

Vespa PX 125 • Vespa PX 150

Veicoli con freno a disco | *Models with brake  
disc*

R.O. 58115R

**246400143**RELÈ AVVIAMENTO | *STARTER RELAYS*Consenso avviamento | *Fire-up consent*

4 terminali | 4 pins

Vespa PX 125 • Vespa PX 150 • Vespa PX 200

R.O. 233707



## FUSIBILI - FUSES

246151001



Kit 10 fusibili lamellari standard assortiti | 10  
Pcs fuses kit



246151031



Kit 200 fusibili lamellari standard | 200 Pcs  
standard fuses kit



## CENTRALINE - CDI

246010050



246010051



4 collegamenti | 4 pins  
Vespa 125 Primavera ET3 • Vespa PX-PXE  
125-150-200 Arcobaleno • Vespa PX 30 anni  
• Vespa 125 T5 • Vespa Rally • Vespa PK tutti i  
tipi - all models  
R.O. 244128



246010062



246010063



3 collegamenti | 3 pins  
Vespa PK 50XL  
R.O. 244127



**CENTRALINE - CDI****246010472**

4 collegamenti | 4 pins

Con cavo di accensione | With ignition cable

Vespa 125 Primavera ET3 • Vespa PX-PXE  
 125-150-200 Arcobaleno • Vespa PX 30 anni  
 • Vespa 125 T5 • Vespa Rally • Vespa PK tutti i  
 tipi - all models  
 R.O. 642443

**246010580**

4 collegamenti | 4 pins

Vespa 125 Primavera ET3 • Vespa PK 50-125/S/  
 XL/XL2 • Vespa Automatica • Vespa 200 Rally  
 2° serie • Vespa PX 80-125-150-200/PE/Lusso/  
 T5 • Cosa

R.O. 159576, 244128, 0298201, SC 9520001,  
 32398112

**246010582**

4 collegamenti | 4 pins

Vespa 125 Primavera ET3 • Vespa PX-PXE  
 125-150-200 Arcobaleno • Vespa PX 30 anni  
 • Vespa 125 T5 • Vespa Rally • Vespa PK tutti i  
 tipi - all models

R.O. 2441285

**ACCESSORI CENTRALINE - CDI ACCESSORIES****121830560**

CAPPUCCIO BOBINA | COIL CAP

Vespa PK 50-125 • Vespa PK Rush • Vespa N  
 R.O. 231571

**121830570**

CAPPUCCIO CENTRALINA | CDI UNIT CAP

Vespa PK 50-125 Rush • Vespa PK • Vespa N  
 R.O. 255256



## ACCESSORI CENTRALINE - CDI ACCESSORIES

**121830580**



CAPPUCCIO CENTRALINA | *CDI UNIT CAP*

Vespa PX 125-150-200 • Cosa 1-2

R.O. 198686



**121830910**



CAPPUCCIO BOBINA | *COIL CAP*

Ø 50 mm

Vespa (VBA1T-VBB1-2T) • Vespa 150 GL (VLA1T)

• Vespa Rally (VSD1T)

R.O. 048525



## REGOLATORI DI TENSIONE - REGULATORS

**246030020**



**246030022** **NEW**



5 collegamenti | *5 pins*

12V 20A

Vespa 50 FL ('90) • Vespa 125 FL ('89-'90) •

Vespa 50 N ('89-'90) • Vespa PK 50XL ('85-'88)

• Vespa PL 125XL ('86-'89) • Vespa 50 Rush

('88-'89) • Vespa 125 T5 ('85-'89) • Vespa PX

125-150-200 ('98-'01) • Vespa PX 125 Euro 2

('01-'07) • Vespa PX 125 30 anni ('07-'08) • Cosa

2 125-150-200('91-'97) • Cosa 125-150-200 CL/

CLX con avviamento elettrico - *with electric*

*starter* ('88-'91)

R.O. 2308245, 58074R



**246030030**



3 collegamenti | *3 pins*

12V 20A

Vespa PX 125-150 • Vespa PX 150E • Vespa PX

200E •

Vespa PK 50SS • Vespa PK 125 • Vespa 125

Primavera ET3

Veicoli con batteria - *Models with battery*

R.O. 1616395





**REGOLATORI DI TENSIONE - REGULATORS****246030040**

5 collegamenti | 5 pins

12V 34/36W

Vespa 50 • Vespa FL • Vespa HP • Vespa PKS •

Vespa PXE 125-150-200 Arcobaleno

Veicoli con batteria - *Models with battery*

R.O. 2940165

**MOTORINI D'AVVIAMENTO - STARTER MOTORS****246390071**

Vespa PK 50-125 ('82-'84) • Vespa PK  
50XL ('84-'88) • Vespa PK 50S • Vespa 125  
Automatica ('84-'89) • Vespa PK 50XL Rush  
( '88-'89) • Vespa 50 N ('89-'90) • Vespa 50 FL  
( '90) • Vespa 125 FL ('89-'90) • Vespa FL2 HP  
( '91-'97) • Vespa 50 FL2 Automatica ('90 '91)  
R.O. 1791165

**246390261**

Vespa PXE Arcobaleno 125-150-200 ('81-'97) •  
Vespa PX 125-150-200 ('98-'01) • Vespa PX 125  
Euro 2 ('01-'07) • Vespa PX 125 30 anni ('07-'08)  
• Cosa CL-CLX 125-150-200 ('88-'91)  
R.O. 249235

**246390450**

Vespa PK 50-125/S/XL/XL2 • Vespa PX 80-200E  
Lusso • Vespa ('98) • Vespa ('11) • Vespa T5 •  
Cosa  
Adatto per - *Suitable for* LML Star Deluxe 125-  
150 4S/Speedy  
R.O. 249235, SF513-0501, C-3727628



## ANELLI PORTASPAZZOLE - BRUSH HOLDERS

**246350030**



ANELLO PORTASPAZZOLE | *BRUSH HOLDER*

Vespa PK 50  
R.O. 179755, 291383



## STATORI - STATORS

**246350011**



**246350013**



5 POLI | *5 POLES*

3 Fili Fastom - Connettore a 5 attacchi | *3*

*Fastom wires - 5 Pins connector*

Vespa PK 50-125 ('82-'84)

R.O. 199500, 497651



**246350063**



6 POLI | *6 POLES*

3 Fili Fastom - Connettore a 3 attacchi | *3*

*Fastom wires - 3 Pins connector*

Vespa FL 50 ('90)-125 ('89-'90) • Vespa 50 N ('89-'90) • Vespa PK 50-125 ('82-'84) • Vespa PK 50XL ('85-'88) • Vespa PK 125XL ('86-'89) • Vespa PK 50XL Rush ('88-'89)

R.O. 199495



**STATORI - STATORS****246350073**5 POLI | 5 *POLES*5 cavi | 5 *wires*

80 W

Vespa PX 125-150-200E Arcobaleno • Cosa

R.O. 217866

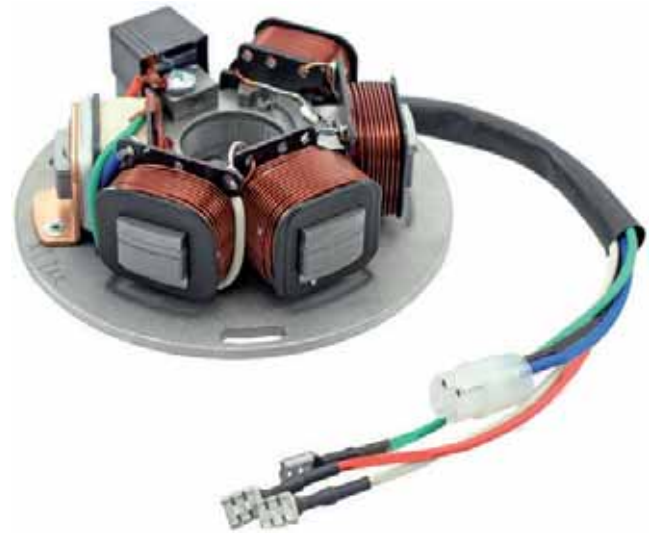
**246350220**5 POLI | 5 *POLES*7 cavi | 7 *wires*

6 V

Vespa 125 Primavera ET3 ('76-'83)

R.O. 186974

**246350292**12 POLI | 12 *POLES*4 cavi | 4 *wires*Spina multipla | *Multi plug*

Vespa PX 125-150 ('11)

R.O. 642427



**246350433**



3 POLI | 3 POLES

5 cavi | 5 wires

6 V

Vespa 125 • Vespa 150 Sprint • Vespa GL

Adattabile a Vespa VNB- VBB vecchi modelli |

*Suitable for Vespa VNB- VBB old models*

R.O. 150776



**246350453**



5 POLI - Ø 95 MM | 5 POLES - Ø 95 MM

5 cavi | 5 wires

90 W

Vespa 125 T5

R.O. 232172



**246350493**



5 POLI | 5 POLES

5 cavi | 5 wires

Su Vespa PX rimuovere spina multipla |

*Remove multi plug on Vespa PX*

LML 125-150 Star/DLX/Stella/Via Toscana

Adattabile a - *Suitable for* Vespa PX 80 • Vespa

200E Lusso • Vespa ('98) • Vespa MY

R.O. SF512-0150 (LML)



## STATORI - STATORS

246350583 **NEW**

5 POLI | 5 POLES

3 cavi | 3 wires

12 V

Vespa PX 125-150-200 ('77-'81)

Veicoli senza batteria e dotati di frecce -  
Models without battery and equipped with  
blinkers

R.O. 166479



## ROTORI - ROTORS

246350302



Peso 2480 g | Weight 2480 g

Vespa PX 125 • Vespa PX 150 • Vespa PXE  
Arcobaleno ('84->)Veicoli con avviamento elettrico - Models with  
e-start

R.O. 642426



## VOLANO - FLYWHEELS

246360143 **NEW**

VOLANO COMPLETO | FLYWHEEL

Volano 6 magneti, 6V | Flywheel 6 magnets, 6V

Statore 3 poli, 5 cavi | Stator 3 poles, 5 wires

Vespa 150 VBA • Vespa 125 VNB 1-6 • Vespa  
150 VBB • Vespa 150 Sprint •Vespa 150 GL • Vespa 125 VNA/VNB/GT/GTR 1°  
serie/Super/TS 1°serie • Vespa 150 VBA/VBB/T4/  
GL/Sprint/V 1° serie/Super 1

Veicoli senza batteria - Models without battery

R.O. 133503, 71473, 97709, 56747



246365000 **NEW**



### EVOX

#### KIT ACCENSIONE ELETTRONICA

Composizione Kit:

Volano 1400 g - Ventola di raffreddamento maggiorata - Statore 4 poli - Piastra statore graduata - Bobina d'accensione - Regolatore di tensione - Estrattore volano 28x1 mm - Piastrina di fissaggio bobina - Pipetta candela - Kit minuteria

#### ELECTRONIC IGNITION KIT

Kit Composition:

Flywheel 1400 g - Enlarged cooling fan - Stator 4 coil - Graduate stator plate - Ignition coil - Voltage regulator - Flywheel puller 28x1 mm - Ignition coil plate - Spark plug cap - Small parts kit

Vespa 50 N-R-L • Vespa 50 Special • Vespa 90 • Vespa 100 • Vespa 125 Primavera • Vespa 125 Primavera ET3 • Vespa PK 50-125 S

Per tutti i modelli cono Ø19 mm | For all Ø19 mm



246365001 **NEW**



### EVOX

#### KIT ACCENSIONE ELETTRONICA

Composizione Kit:

Volano 1400 g - Ventola di raffreddamento maggiorata - Statore 4 poli - Piastra statore graduata - Bobina d'accensione - Regolatore di tensione - Estrattore volano 28x1 mm - Piastrina di fissaggio bobina - Pipetta candela - Kit minuteria

#### ELECTRONIC IGNITION KIT

Kit Composition:

Flywheel 1400 g - Enlarged cooling fan - Stator 4 coil - Graduate stator plate - Ignition coil - Voltage regulator - Flywheel puller 28x1 mm - Ignition coil plate - Spark plug cap - Small parts kit

Vespa PK 50-125 S ('82-'84) • Vespa PK 50XL ('84-'88) • Vespa PK 50 SS • Vespa PK 125 ETS Elestart • Vespa PK 50 XL Rush ('88-'89) • Vespa 50 N ('89-'90) • Vespa 50 FL • Vespa 125 FL • Vespa PK 50 XL HP ('91-'97)

Per tutti i modelli cono Ø20 mm | For all Ø20 mm



**ACCENSIONI ELETTRICHE - ELECTRONIC IGNITION KIT****246365002** **NEW****EVOX****KIT ACCENSIONE ELETTRONICA**

Composizione Kit:

Volano 1400 g - Ventola di raffreddamento maggiorata - Statore 4 poli - Piastra statore graduata - Bobina d'accensione - Regolatore di tensione - Estrattore volano 28x1 mm - Pipetta candela - Kit minuteria

**ELECTRONIC IGNITION KIT**

Kit Composition:

Flywheel 1400 g - Enlarged cooling fan - Stator 4 coil - Graduate stator plate - Ignition coil - Voltage regulator - Flywheel puller 28x1 mm - Spark plug cap - Small parts kit

Vespa VBA/VBB • Vespa VNB • Vespa GL • Vespa GT/GTR • Vespa Sprint • Vespa Super 125/150

Per tutti i modelli cono Ø17 mm | For all Ø17 mm cone models

**246365003** **NEW****EVOX****KIT ACCENSIONE ELETTRONICA**

Composizione Kit:

Volano 1400 g - Ventola di raffreddamento maggiorata - Statore 4 poli - Piastra statore graduata - Bobina d'accensione - Estrattore volano M22x1,5 - Pipetta candela - Kit minuteria

**ELECTRONIC IGNITION KIT**

Kit Composition:

Flywheel 1400 g - Enlarged cooling fan - Stator 4 coil - Graduate stator plate - Ignition coil - Flywheel puller M22x1,5 - Spark plug cap - Small parts kit

Cosa 1 125-150-200 • Cosa 2 125-150-200 • Vespa 125 TS • Vespa 150 Sprint Veloce • Vespa PX 80-125-150-200



**121650073**



TAPPO VOLANO | *FLYWHEEL CAP*

Vespa PX 125-150-200 • Cosa 125-150-200

R.O. 226990



**121830310**



TAPPO GOMMA FERITOIA VOLANO | *FLYWHEEL SLOT RUBBER PLUG*

Dimensioni 40x17x12 mm | *Dimensions*

40x17x12 mm

Vespa 125 Primavera ET3 • Vespa PE• Vespa PX

R.O. 133652



**121830320**



TAPPO GOMMA FERITOIA VOLANO | *FLYWHEEL SLOT RUBBER PLUG*

Dimensioni 44x19x10,5 mm | *Dimensions*

44x19x10,5 mm

Vespa 50-90-125

R.O. 110162



**121850400**



DADO VOLANO | *FLYWHEEL NUT*

M10x1,5 mm

Diametro base Ø 24,2 mm | *Base diameter Ø*

24,2 mm

Confezione 10 pz. | *10 Pcs Packing*

Vespa 50-90 • Vespa 125 Primavera ET3

R.O. 001545





**ACCESSORI VOLANI, ROTORI E STATORI - FLYWHEELS, ROTORS AND STATORS ACCESSORIES****121858103****NEW**KIT FELTRO LUBRIFICAZIONE PERNO VENTOLA |  
FLYWHEEL FELT LUBRIFICATION KITVespa 50-125/PV • Vespa 125 VM-TS •  
Vespa150 VL- Super • Vespa 160 GS • Vespa  
180 SS/Rally • Vespa P 125-150X • Vespa P 150S  
R.O. 072836, 72836, 16421, 79639**121859247****NEW**

DADO VOLANO | FLYWHEEL NUT

Cono 17 mm | Cone 17 mm

M11x1,5 mm

Chiave 14 mm | AF 14 mm

Con bordo | With flange

Vespa 125 VNB1-6 • Vespa GT • Vespa GTR •  
Vespa 125 Super • Vespa 150 VBB1-2 • Vespa  
150 GL • Vespa Sprint 150 • Vespa Sprint Veloce  
• Vespa 150 Super  
R.O. S.12066, 012065**121858430**

CHIAVETTA VOLANO | FLYWHEEL KEY

Dimensioni 12,6x5x3mm | Dimensions

12,6x5x3mm

Confezione 50 pz. | 50 Pcs Packing

Lato volano e lato frizione - Flywheel and clutch

side: Vespa 50-90 • Vespa 125 Primavera ET3 •

Vespa PK • Vespa PK XL • Vespa FL2

Lato volano - Flywheel side: Vespa PX PE

Lato frizione - Clutch side: Vespa 160 GS •

Vespa 180 SS

R.O. 000267

**121858440**

CHIAVETTA VOLANO | FLYWHEEL KEY

Dimensioni 15,3x6,45x4 mm | Dimensions

15,3x6,45x4 mm

Confezione 50 pz. | 50 Pcs Packing

Vespa 125 V1-TS • Vespa 150 VL-Super • Vespa

Rally • Vespa PX • Vespa PE • Vespa Lusso •

Cosa • Vespa T5

R.O. 000097, 97



## PICK UP - PICK UP

**246170023**



Vespa PX-PXE 125-150-200 Arcobaleno • Vespa 125 T5 • Vespa PK XL • Vespa PK 50-125 • Vespa Rush • Vespa N • Vespa FL • Vespa FL2 • Vespa HP • Cosa CL/CLX 125-150-200  
R.O. 196549



## QUADRI CHIAVE - KEY SETS MAIN SWITCHES

**246050230**



4 collegamenti | 4 connections  
Vespa PX 125 ('78-'82) • Vespa PX 150 ('78-'82)  
• Vespa PX 200 ('78-'82)  
Adattabile a - Suitable for Vespa 125 ET3  
R.O. 160743



## COMMUTATORI ACCENSIONE - IGNITION SWITCHES

**246050693**



2 cavi | 2 wires  
Vespa PX • Vespa PK  
R.O. 178593



**COMMUTATORI ACCENSIONE - IGNITION SWITCHES****246050740**

5 Posizioni | *5 Positions*  
10 collegamenti | *10 connections*  
Vespa 160 GS VSB1 ('63-'64->)  
R.O. 70113

**246050750**

5 Posizioni | *5 Positions*  
8 collegamenti | *8 connections*  
Vespa 150 GS VS5 ('59-'61) • Vespa 160 GS VSB  
( '62-'64)  
R.O. 92962



### IMPIANTI ELETTRICI VESPA - VESPA CABLE HARNESS



Codice RMS RMS Code	Descrizione Description	OEM	Codice a Barre Barcode
246490040	Impianto elettrico Vespa 125 VM2 • Vespa 125 VN • Vespa 150 VL1 - (Senza batteria, senza frecce, con luce abbagliante/anabbagliante, senza luce di arresto)   Vespa Cable Harness Vespa 125 VM2 • Vespa 125 VN • Vespa 150 VL1 - (Without battery, without blinkers, with low/beam lights, without stop light)	022681	
246490050	Impianto Elettrico Vespa 125 (65>66) • Vespa 150 VBB2 63>66 • Vespa Super 125-150 • Vespa Sprint 150 (64-74 dal tel. 025401>) senza batteria, con luce di posizione abbagliante/anabbagliante   Vespa Cable Harness Vespa 125 (65>66) • Vespa 150 VBB2 63>66 • Vespa Super 125-150 • Vespa Sprint 150 (64-74 from frame n. 025401>) - (Without battery, with position low/beam lights)	091462	
246490060	Impianto Elettrico Vespa 50 N-L-R (Senza batteria, senza frecce, con luce abbagliante/anabbagliante, senza luce di arresto)   Vespa Cable Harness 50 N-L-R - (Without battery, without blinkers, with low/beam lights, without stop light)	102462	
246490070	Impianto Elettrico Vespa 180 Rally • Vespa Gtr 125 • Vespa Sprint Veloce 150 - (senza batteria)   Vespa Cable Harness 180 Rally • Vespa Gtr 125 • Vespa Sprint Veloce 150 - (without battery)	114309	
246490080	Impianto Elettrico Vespa 50 Special - (senza batteria, senza frecce)   Vespa Cable Harness 50 Special - (without battery, without blinkers)	142965	
246490090	Impianto Elettrico Vespa 90-125 Primavera   Vespa Cable Harness 90-125 Primavera	144505	
246490100	Impianto Elettrico Vespa 125 ET3   Vespa Cable Harness 125 ET3	149247	
246490110	Impianto Elettrico Vespa Px 2 Serie - (Con frecce, senza batteria)   Vespa Cable Harness Px 2nd Series - (With flashers, without battery)	243566	
246490120	Impianto Elettrico Vespa GL 150 - (senza batteria)   Vespa Cable Harness GL 150 - (without battery)	090388	
246490140	Impianto Elettrico Vespa Pk 50 S V5X2T - (Con frecce)   Vespa Cable Harness Pk 50 S V5X2T - (With blinkers)	243203	
246490150	Impianto Elettrico Vespa Px 125-150-200 - (Senza avviamento elettrico, senza batteria, con frecce, senza raddrizzatore e clacson)   Vespa Cable Harness Px 125-150-200 - (No electric starter, without battery, with blinkers, without regulator and horn)	217897	
246490160	Impianto Elettrico Vespa Px 125-150-200 - (Con avviamento elettrico)   Vespa Cable Harness Px 125-150-200 - (With electric starter)	242182	
246490170	Impianto Elettrico Vespa 125 V30T-V33T-VM1T-VU1T   Vespa Cable Harness 125 V30T-V33T-VM1T-VU1T	018201	
246490180	Impianto Elettrico Vespa 150 VBB1 • Vespa GL 150 - (con batteria, senza frecce)   Vespa Cable Harness 150 VBB1 - (with battery, without blinkers)	057126	
246490191	Impianto Elettrico Vespa Gs 160 VSB1   Vespa Cable Harness Gs 160 VSB1	070124	
246490210	Impianto Elettrico Vespa GL 150 VLA1T • Vespa 150 VBB1T - (con batteria, senza frecce)   Vespa Cable Harness GL 150 VLA1T • Vespa 150 VBB1T - (with battery, without blinkers)	070651	
246490220	Impianto Elettrico Vespa 150 VL2/3-VB1 - (Con batteria, senza frecce)   Vespa Cable Harness 150 VL2/3-VB1 - (With battery, without blinkers)	81300	
246490230	Impianto Elettrico Vespa 125 VNA1/2T - (senza batteria, senza frecce)   Vespa Cable Harness 125 VNA1/2T (without battery, without blinkers)	081021	
246490241	Impianto Elettrico Vespa 150 VBA1 - (Con batteria, senza frecce)   Vespa Cable Harness 150 VBA1 - (With battery, without blinkers)	084354001	
246490270	Impianto Elettrico Vespa Px 125-150-200 1° serie - (Senza batteria, senza frecce, impianto 6V)   Vespa Cable Harness Px 125-150-200 1° series - (Without battery, without blinkers, 6V harness)	162064	
246490290	Impianto Elettrico Vespa 150 Ss 180 VBB2-VSC1 - (Senza batteria, senza frecce)   Vespa Cable Harness 150 Ss 180 VBB2-VSC1 - (Without battery, without blinkers)	098253	
246490302	Impianto Elettrico Vespa Gs 150 58-61 VS4T VS5T - (Con batteria, senza frecce)   Vespa Cable Harness Gs 150 58-61 VS4T VS5T - (With battery, without blinkers)	084612	
246490303	Impianto Elettrico Vespa 150 VBB 1961 - (Con batteria, senza frecce)   Vespa Cable Harness 150 VBB 1961 - (With battery, without blinkers)	086844	

**ACCESSORI CABLAGGI - WIRINGS ACCESSORIES****246490200**

GUAINA CABLAGGIO | *ELECTRIC SHEATH*  
 Vespa vari modelli | *Vespa various models*  
 R.O. 610076M

**246490201**

GUAINA CABLAGGIO VESPA - VERDE | *ELECTRIC SHEATH VESPA - GREEN*  
 Lunghezza 3210 mm | *Length 3210 mm*  
 Vespa vari modelli | *Vespa various models*

**267005000**

KIT GUAINA TERMORETRAIBILE IMPERMEABILE  
 (106 Pz) | *WATERPROOF HEAT SHRINKABLE TUBE SET (106 Pcs)*

**CONDENSATORI - CONDENSER****246190010**

Dimensioni Ø20x32 mm | *Dimensions Ø20x32 mm*

Senza piastra di fissaggio | *Without mounting plate*

1 cavo mF 0,32 (giallo) | *1 cable, mF 0,32 (yellow)*

Vespa 50 SS • Vespa 50 R V5A1T (dal telaio n.853411 - *from chassis n.853411*) • Vespa 50 Special V5B1T (dal telaio n.70567 - *from chassis n.70567*) • Vespa 50 Special V5B3T  
 R.O. 078937



**246190020**



Dimensioni Ø20x32 mm | *Dimensions Ø20x32 mm*

Con piastra di fissaggio | *With mounting plate*  
1 cavo mF 0,32 (giallo) | *1 cable, mF 0,32 (yellow)*

Vespa 50 V5A1T (fino al telaio n.76350 - *till chassis n.76350*) • Vespa 90 • Vespa 90SS • Vespa Nuova 125 ('65) • Vespa 125 Primavera VMA

R.O. 079697



**246190030**



Dimensioni Ø14x35 mm | *Dimensions Ø14x35 mm*

Senza cavo, 1 contatto, 12 V mF 0,34 | *No cable, 1 contact, 12V mF 0,34*

Vespa PX 125 • Vespa PX 150 • Vespa PX 200

R.O. 182343



**246190060**



Dimensioni Ø20x32 mm | *Dimensions Ø20x32 mm*

Con piastra di fissaggio | *With mounting plate*  
2 cavi mF 0,34 | *2 cables, mF 0,34*

Vespa 125 GT • Vespa GTR • Vespa GL • Vespa Sprint • Vespa Super • Vespa 180 Rally

R.O. 155973



**246190070**



Con piastra di fissaggio | *With mounting plate*  
1 cavo mF 0,22 | *1 cable, mF 0,22*

Vespa 50 modello Spagna



**CONDENSATORI - CONDENSER****246190080**Dimensioni Ø20x35 mm | *Dimensions Ø20x35 mm*Con piastra di fissaggio | *With mounting plate*  
1 cavo mF 0,34 | *1 cable, mF 0,34*Vespa VM1-2VN1-2 • Vespa VL1-2-3 • Vespa VB1  
• Vespa VNA1-2 • Vespa VNB 1-2-3-4-5 • Vespa  
GS VS1-2-3-4-5

R.O. 018941

**246190090**Dimensioni Ø20x36 mm | *Dimensions Ø20x36 mm*Con piastra di fissaggio | *With mounting plate*  
2 cavi, mF 0,32 | *2 cables, mF 0,32*

6v

Senza frecce

Vespa 125 Super • Vespa 150 Super • Vespa  
150 GL • Vespa Sprint

R.O. 133052

**CONNETTORI - ELECTRICAL CONNECTORS****246330310**CONNETTORI PREISOLATI (7 Tipi) | *PLASTIC  
COATED CONNECTORS (7 Types)*Confezione 35 pz. | *35 Pcs Packing***PUNTINE - CONTACTS****246150020**Vespa 50 • Vespa 50 Special • Vespa 50 R •  
Vespa 50 L • Vespa 50 N

R.O. 101761



**246150030**



Lungo con perno | *Long with pin*  
 Vespa 90 • Vespa 125 Primavera  
 R.O. 141838



**246150050**



Lungo senza perno | *Long without pin*  
 Vespa 90 • Vespa 125 VMA1 • Vespa VM • Vespa  
 VN • Vespa VNA • Vespa VNB • Vespa VU •  
 Vespa ACMA • Vespa GT • Vespa GTR 1° serie  
 • Vespa Super • Vespa 150 VL • Vespa VB •  
 Vespa VBA • Vespa VBB • Vespa VGL1 • Vespa  
 GL • Vespa Sprint • Vespa V 1° serie • Vespa  
 Super 1° serie  
 R.O. 129434



**246150060**



Lungo con perno | *Long with pin*  
 Impianti con bobina | *Models with coil*  
 Vespa PX 1° serie • Vespa Sprint ('74>) • Vespa  
 Super • Vespa 125 Primavera  
 R.O. 140963



**246150070**



Perno 4 mm | *Pin 4 mm*  
 Modello con frecce | *Model with blinkers*  
 Vespa PX 125 • Vespa PX 150  
 R.O. 134117,182342





## PUNTINE - CONTACTS

246150080

Lungo senza perno | *Long without pin*

Vespa 90 1° serie • Vespa 125 VM • Vespa VN  
 • Vespa VNA • Vespa VNB1-6T 2° serie • Vespa  
 VU • Vespa ACMA • Vespa 150 VL • Vespa VB •  
 Vespa VBA • Vespa VBB1-2T 2° serie • Vespa  
 VGL1 • Vespa GL • Vespa Sprint 1° serie  
 R.O. 97478



246150090

Lungo senza perno | *Long without pin*

Vespa 180 Rally • Vespa 200 Rally • Vespa 180  
 SS  
 R.O. 111300



246150100



Vespa 50 modello Spagna



246150120

Lungo senza perno | *Long without pin*

Vespa 98-125 V1-V15/V30-V33/ACMA (>'54)  
 R.O. 610075M



246150130

Lungo con doppia molla | *Long with double spring*

Vespa 150 GS VS1-2-3-4-5  
 R.O. 097477



**246490020**



PRESA BASSA TENSIONE | *L.T. SOCKET ASSY*  
 Con contatti avvitati | *With screwed contacts*  
 Vespa 50-90-125 Primavera • Vespa ET3 •  
 Vespa 50 L-R-S • Vespa Super • Vespa Sprint  
 R.O. 070744



**246490030**



PRESA BASSA TENSIONE | *L.T. SOCKET ASSY*  
 Vespa 125 VNB6 • Vespa GT • Vespa GTR •  
 Vespa Super • Vespa TS • Vespa 150 GL • Vespa  
 Sprint • Vespa Rally  
 R.O. 120811



**246490133**



PRESA DI CORRENTE | *L.T. SOCKET ASSY*  
 Con avviamento elettrico | *With e-start*  
 Vespa PX 80-200 E Lusso • Vespa ('98) • Vespa  
 MY • Vespa ('11) • Vespa T5  
 Adatto per - *Suitable for* LML Star 125-200 2T/  
 4T/Deluxe 2T/4S/Speedy/Stella  
 R.O. 178895



**246490280**



PRESA BASSA TENSIONE | *L.T. SOCKET ASSY*  
 Con contatti inseriti | *With inserted contacts*  
 Vespa 50 R 2° serie • Vespa S 2° Serie • Vespa  
 Special V5B3T 2° Serie • Vespa 100 2° Serie •  
 Vespa 125 PV 2° Serie • Vespa ET3 2° Serie  
 Adatto per - *Suitable for* Vespa 50-125 • Vespa  
 PV • Vespa ET3  
 R.O. 185458



**PRESE DI CORRENTE - SOCKETS****246490310**PRESA DI CORRENTE | *SOCKET ASSY*Per 3 cavi | *For 3 cables*

Vespa P 80-150X • Vespa P 200E

Veicoli senza batteria | *Models without battery*

R.O. 016347

**246490320**PRESA DI CORRENTE | *SOCKET ASSY*Modello con frecce | *Blinkers Model*

Vespa PX 125-150-200 Arcobaleno

R.O. 163603

**246490330**PRESA DI CORRENTE | *SOCKET ASSY*Per 7 cavi | *For 7 cables*

Vespa 125 GTR • Vespa 150 Sprint Veloce •

Vespa 200 Rally • Vespa PX 125 • Vespa PX 150

• Vespa PX 200

R.O. 163476, 149082

**121830620**CAPPuccio PRESA CORRENTE | *RUBBER**SOCKET*

Vespa 50-90-125

R.O. 161125





# BATTERIE

BATTERIES

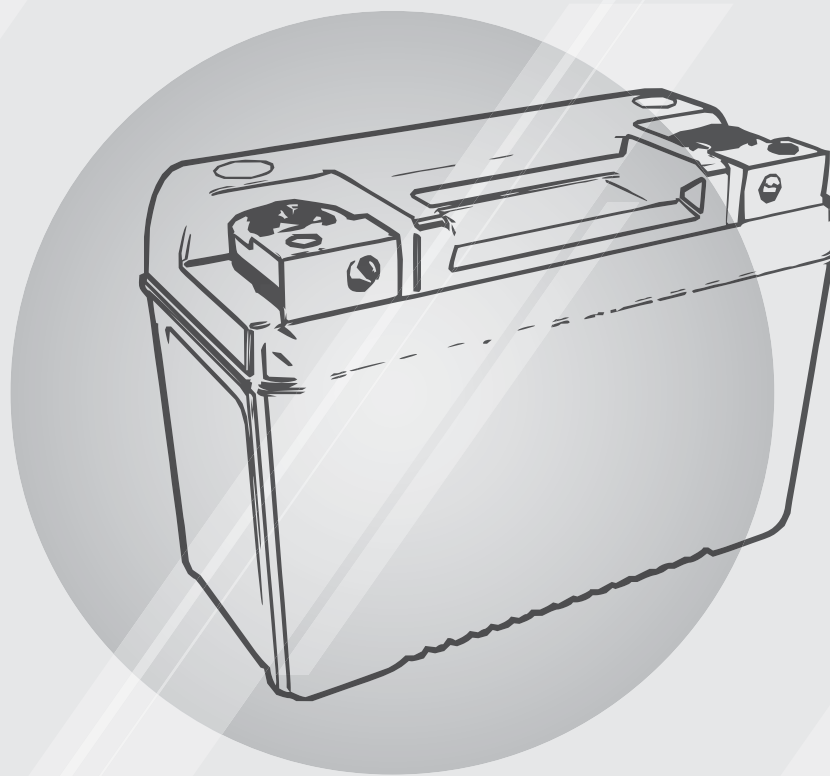

**121830732** **NEW**



CINGHIA BATTERIA | *BATTERY BELT*

Lunghezza 170 mm | *Length 170 mm*

Vespa PX

R.O. 090854



**121830733**



CINGHIA BATTERIA | *BATTERY BELT*

Vespa PX 125-150-200 • Cosa • Vespa T5 •

Vespa PXE Arcobaleno

R.O. 218812



**121830743**



CINGHIA BATTERIA | *BATTERY BELT*

Vespa PK 50-125

R.O. 90854



**246650195** **NEW**



plug  
play

BATTERIA SLA BB9-B | *BATTERY SLA BB9-B*

Voltaggio 12 v | *Voltage 12 v*

CCA 120 A | *CCA 120 A*

Capacità 9 Ah | *Capacity 9 Ah*

Dimensioni 135x75x139 mm | *Dimensions*

*135x75x139 mm*

Peso 3,10 kg | *Weight 3,10 kg*

Adattabile a | *Suitable for Vespa PX • Vespa PK*



**246650605** **NEW**



plug  
play

BATTERIA SLA B49-6 | *BATTERY SLA B49-6*

Voltaggio 6 v | *Voltage 6 v*

CCA 80 A | *CCA 80 A*

Capacità 10,5 Ah | *Capacity 10,5 Ah*

Dimensioni 91x83x159 mm | *Dimensions*

*91x83x159 mm*

Peso 2,07 kg | *Weight 2,07 kg*

Adattabile a | *Suitable for Vespa VL1-2 • Vespa GS 160 • Vespa 180 SS*



**CARICABATTERIE - TESTER - ACCESSORI - BATTERY CHARGERS - TESTERS - ACCESSORIES****246650615** **NEW****BATTERIA SLA 6N11A-1B/3-A** | BATTERY SLA  
6N11A-1B/3-A

Voltaggio 6 v | Voltage 6 v

CCA 90 A | CCA 90 A

Capacità 11,6 Ah | Capacity 11,6 Ah

Dimensioni 121x58x130 mm | Dimensions

121x58x130 mm

Peso 1,76 kg | Weight 1,76 kg

Adattabile a | Suitable for Vespa VL3 • Vespa

VNB1 • Vespa VB1 • Vespa VBA1 • Vespa VBB

1-2 • Vespa VLA

**246650620** **NEW****BATTERIA SLA 6N11A-4A** | BATTERY SLA 6N11A-4A

Voltaggio 6 v | Voltage 6 v

CCA 90 A | CCA 90 A

Capacità 11,6 Ah | Capacity 11,6 Ah

Dimensioni 121x58x130 mm | Dimensions

121x58x130 mm

Peso 1,76 kg | Weight 1,76 kg

Adattabile a | Suitable for Vespa VL3 • Vespa

VNB1 • Vespa VB1 • Vespa VBA1 • Vespa VBB

1-2 • Vespa VLA

**246700010** **NEW**Caricabatteria BS10 6V/12V | Battery Charger  
BS10 6V/12V*The Power you need...***GOOD TO KNOW**

- **SLA** are ready to use : **Just Plug & Play !**
- No acid handling - **100% spilproof design,**
- **Absolutely maintenance free,**
- Multi-positioning mounting: **Up to 90°,**
- **BS 10 Smart Battery Charger** delivered with clamps set and fused ring terminals: **connect & forget !**

**PLUG AND PLAY  
SOLUTION**  
*306 425 436 446 456 466 476 486*





# TRASMISSIONE

TRANSMISSION

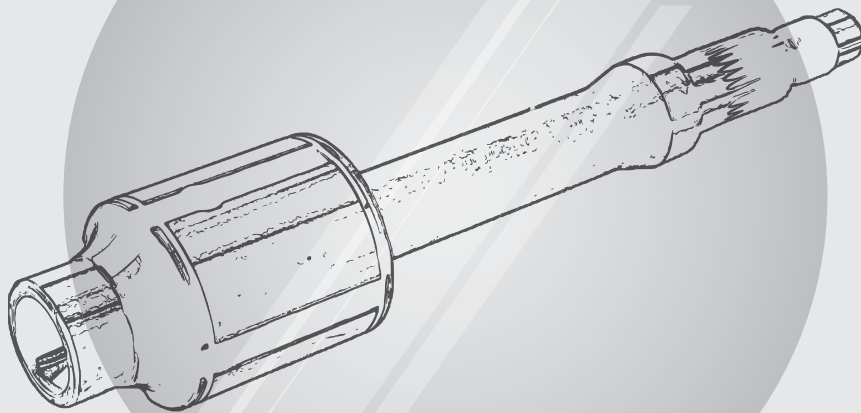

100240120



ALBERO SECONDARIO | *DRIVEN SHAFT*

Vespa PX PE Arcobaleno ('89>) • Vespa 125 T5

• Cosa

R.O. 235908



100240193



ALBERO SECONDARIO | *DRIVEN SHAFT*

Vespa PX • Vespa PE Arcobaleno ('81-'97) •

Vespa Sprint • Vespa Rally

R.O. 157800

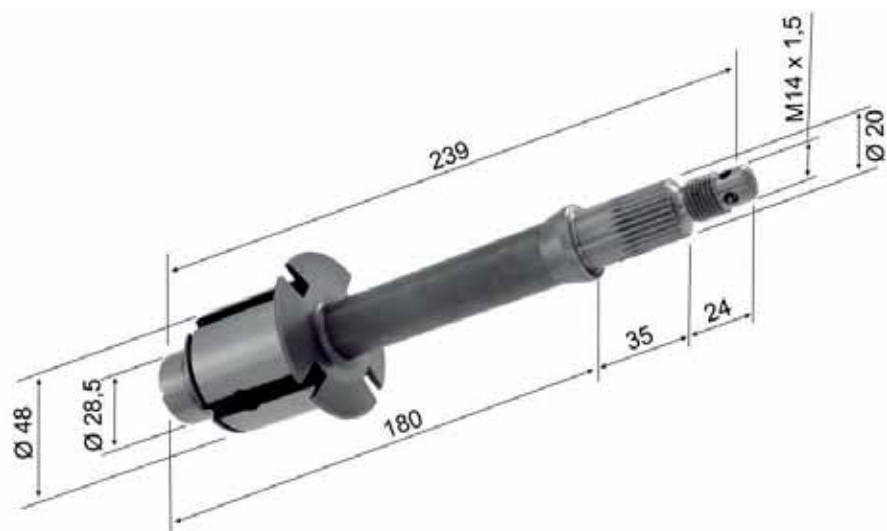

100240233 **NEW**



ALBERO PRIMARIO | *PRIMARY SHAFT*

12x13x17x21

Vespa PX PE 80-125-150- 200 • Vespa PX PE

Arcobaleno • Vespa 125 T5 • Vespa Rally 180 •

Vespa T5 Rally • Cosa 1-2

R.O. 236223, 174735



**ALBERI TRASMISSIONE - TRANSMISSION SHAFTS****100240243** **NEW**CORONA ALBERO PRIMARIO | *PRIMARY SHAFT SPROCKET*Denti elicoidali Z 68 | *Helicoidal teeth Z 68*Vespa 125 T5 (VNX5) • Vespa P 80X-PX 80E-PX 125E(VNX2) • Vespa P 125X (VNX1T dal telaio n.146314 - *from frame n.146314*) • Vespa P 150X (VLX1T dal telaio n.264565 - *from frame n.264565*) • Cosa 1-2 200  
R.O.174825.5**100240253** **NEW**INGRANAGGIO Z 57 1a VELOCITA' | *GEAR 1st SPEED*

Ø 117,5 mm

Spessore denti 11 mm | *Teeth thickness 11 mm*Sezione centale 5,5 mm | *Mid section 5,5mm*Vespa P125-150-200E • Vespa Rally 180 (VSD1T) • Vespa Rally 200 (VSE1T)  
R.O. 152804**100240263** **NEW**INGRANAGGIO Z 42 2a VELOCITA' | *GEAR 2nd SPEED*

Ø 109,5 mm

Sezione centrale 4,88mm | *Mid section 4,88 mm*Vespa P125-150-200E • Vespa Rally 180 (VSD1T) • Vespa Rally 200 (VSE1T)  
R.O. 152805

**100240273** **NEW**



INGRANAGGIO Z 38 3a VELOCITA' | *GEAR 3rd SPEED*

Ø 100,2 mm

Sezione centrale 4,88mm | *Mid section 4,88 mm*

Vespa P125-150-200E • Vespa Rally 180 (VSD1T)

• Vespa Rally 200 (VSE1T)

R.O. 152806



**100240283** **NEW**



INGRANAGGIO Z 35 4a VELOCITA' | *GEAR 4th SPEED*

Ø 90,5 mm

Spessore denti 11,5 mm | *Teeth thickness 11,5 mm*

Sezione centrale 4,85 mm | *Mid section 4,85 mm*

Vespa P125-150-200E • Vespa Rally 180 (VSD1T)

• Vespa Rally 200 (VSE1T)

R.O. 152807



**100240303** **NEW**



ALBERO PRIMARIO COMPLETO | *PRIMARY SHAFT*

12x13x17x21

Corona Z68 con denti elicoidali | *Z68 sprocket with helicoidal teeth*

Vespa PX PE 80-125-150-200 • Vespa PX PE Arcobaleno • Vespa 125 T5 • Vespa Rally 180 •

Vespa T5 Rally • Cosa

R.O. 236223, 174735



**ALBERI TRASMISSIONE - TRANSMISSION SHAFTS****100240313** **NEW**ALBERO PRIMARIO COMPLETO | *PRIMARY SHAFT*

12x13x17x21

Corona Z67 con denti elicoidali | *Z67 sprocket with helicoidal teeth*Vespa 150 Super • Vespa PX PE 125-150 •  
Vespa 150 Sprint • Vespa 150 VBB • Vespa 125  
GT • Vespa 125 GTR • Vespa 125 TS**100240323** **NEW**PERNO PER INGRANAGGIO ALBERO MULTIPLIO  
PRIMARIO | *INPUT SHAFT*Vespa PE 200 • Vespa Rally 200  
R.O. 111715**100240333** **NEW**ALBERO CAMBIO PRIMARIO INGRANAGGIO  
MULTIPLIO | *PRIMARY SHAFT*

12X16X20X25

Corona Z67 con denti elicoidali | *Z67 sprocket with helicoidal teeth*Vespa 125 GT • Vespa GTR • Vespa TS • Vespa  
150 GL • Vespa 150 Sprint • Vespa Veloce •  
Vespa PX

## ALBERI TRASMISSIONE - TRANSMISSION SHAFTS

**100240343** **NEW**



PERNO INGRANAGGIO MULTIPLIO | *INPUT  
SHAFT*

Vespa PX 80-125-150 • Vespa Sprint 150



**100240373** **NEW**



INGRANAGGIO ALBERO MULTIPLIO PRIMARIO |  
*COUNTERSHAFT WITH PRIMARY GEAR*

12x13x17x21

Vespa 80-125-150-180- 200 • Vespa PX PE  
Arcobaleno • Vespa 125 T5 • Vespa 180 Rally •  
Cosa 125-150  
R.O. 1315874



## ACCESSORI ALBERI DI TRASMISSIONE - TRANSMISSION SHAFTS ACCESSORIES

**100220070** **NEW**



CROCERA INNESTO MARCE | *GEAR SELECTOR*

Spessore 5 mm | *Thickness 5 mm*

Vespa 125-150 ('57-'76)

R.O. 0949446



**ACCESSORI ALBERI DI TRASMISSIONE - TRANSMISSION SHAFTS ACCESSORIES****100220071** **NEW**

CROCERA INNESTO MARCE | *GEAR SELECTOR*  
 Vespa 125 VM/VN/VNA/VNB/Super/GT 1° serie/  
 GTR 1° serie • Vespa 150 Super/VL/VB1/VBA/  
 VBB/VD/VGLA/B/VGL/GL/GS/Sprint 1° serie/  
 Sprint Veloce 1° serie • Vespa 160 GS • Vespa  
 180 SS • Vespa 180-200 Rally  
 R.O. 0949446

**100220080** **NEW**

CROCERA INNESTO MARCE | *GEAR SELECTOR*  
 4 Griffe | 4 Jaws  
 4 Velocità | 4 Speeds  
 Spessore 5 mm | 5mm Thickness  
 Vespa PX 80-125-150-200E Lusso 2° serie •  
 Vespa PX '98/MY/'11/T5 • Cosa  
 R.O. 2232251

**100220081** **NEW**

CROCERA INNESTO MARCE | *GEAR SELECTOR*  
 Vespa PX80-200 E Lusso 2° serie • Vespa ('98)  
 • Vespa MY • Vespa ('11) • Vespa T5 • Cosa  
 Adatto per | Suitable for LML Star 125-200  
 2T/4T/Deluxe 2T/4S/Speedy/Stella  
 R.O. 2232251

**100220101** **NEW**

CROCERA INNESTO MARCE | *GEAR SELECTOR*  
 Vespa 125 GT 2° serie • Vespa GTR 2° serie •  
 Vespa TS • Vespa 150 Sprint 2° serie • Vespa  
 V 2° serie • Vespa Super 2° serie • Vespa 180-  
 200 Rally 2° serie • Vespa P80-150X • Vespa  
 P 150S 1° serie • Vespa P 200E • Vespa PX 80-  
 200E • Vespa Lusso 1° serie  
 R.O. 1309396

**100220140** **NEW**

CROCERA INNESTO MARCE | *GEAR SELECTOR*  
 4 Griffe | 4 Jaws  
 4 Velocità | 4 Speeds  
 Spessore 5 mm | 5 mm Thickness  
 Cosa 1-2 • Vespa PX 80E Lusso • Vespa PX 125-  
 150-200 • Vespa T5  
 R.O. 2232255



**100220020**



CROCERA INNESTO MARCE | *GEAR SELECTOR*

4 Griffe | *4 Jaws*

4 Velocità | *4 Speeds*

Altezza totale 50,2 mm | *Total height 50,2 mm*

Angolo arrotondato | *Rounded corner*

Vespa 50 • Vespa 50 Special • Vespa 90 •

Vespa 90 SS • Vespa 125 Primavera • Vespa

Primavera ET3 • Vespa PK 50-125 • Vespa PK

50-125XL • Vespa 50-125 FL • Vespa HP

R.O. 134902



**100220110**



CROCERA INNESTO MARCE | *GEAR SELECTOR*

4 Griffe | *4 Jaws*

4 Velocità | *4 Speeds*

Altezza totale 51 mm | *Total height 51 mm*

Angolo vivo | *Sharp corner*

Vespa 50 • Vespa 50 Special • Vespa 90 •

Vespa 90 SS • Vespa 125 Primavera

R.O. 1115896



**100220120**



CROCERA INNESTO MARCE | *GEAR SELECTOR*

4 Griffe | *4 Jaws*

3 Velocità | *3 Speeds*

Altezza totale 50 mm | *Total height 50 mm*

Vespa PK 50FL (fino al telaio n.73407 - *till chassis n.73407*) • Vespa 50 HP • Vespa 50-90 ('78-'80)

R.O. 1653046, 165304



**100220143** **NEW**



LEVA COMANDO PRESELETTORE MARCE | *GEAR SELECTOR LEVER*

Completo di molla e vite | *With spring and screw*

Vespa 125 VNB5-6T-TS • Vespa 150 VBB-Super • Vespa 160 GS •

Vespa 180 SS • Vespa Rally • Vespa PX 80-125-150-200/PE/Lusso/T5/Cosa 1

R.O. 2854525, 059407, 059410





**ACCESSORI ALBERI DI TRASMISSIONE - TRANSMISSION SHAFTS ACCESSORIES****100220153** **NEW**STELO COMANDO CAMBIO | *SHIFT CONTROL*  
*STEM*

86x63 mm | 86x63 mm

Vespa 125 VNA/VNB1-4 • Vespa 150 VBA/VBB1M

1° serie/VGLA

R.O. 46605, 92105

**100221070** **NEW**STELO COMANDO CAMBIO | *SHIFT CONTROL*  
*STEM*Vespa Sprint • Vespa Rally • Vespa PX • Vespa  
PE (> '89)

R.O. 1309406

**100221080** **NEW**STELO COMANDO CAMBIO | *SHIFT CONTROL*  
*STEM*

Vespa PX PE • Vespa T5 • Cosa ('89&gt;)

R.O. 2232325

**100240293** **NEW**PIGNONE FRIZIONE Z21/26 | *CLUTCH*  
*SPROCKET Z21/26*Denti elicoidali Z21 | *Helicoidal teeth Z21*Denti dritti Z26 | *Straight teeth Z26*Vespa P 125X (VNX1T dal telaio n.146314 - *from**chassis n.146314*) • Vespa P 150X (VLX1T daltelaio n.264565 - *from chassis n.264565*) •

Vespa PX 150E Arcobaleno/Elestart

R.O. 174733

**100240383** **NEW**PIGNONE FRIZIONE Z23/26 | *CLUTCH*  
*SPROCKET Z23/26*Denti elicoidali Z23 | *Helicoidal teeth Z23*Denti dritti Z26 | *Straight teeth Z26*

Vespa PE 200 • Vespa Rally 180-200

R.O. 130823



**100240403** **NEW**



PIGNONE FRIZIONE Z21/26 | *CLUTCH*

*SPROCKET Z21/26*

Denti elicoidali Z21 | *Helicoidal teeth Z21*

Denti dritti Z26 | *Straight teeth Z26*

Cosa 1-2 200

R.O. 237272



**100300543** **NEW**



SCODELLINO PER MOLLA FRIZIONE | *CAP FOR*

*CLUTCH SPRING*

Vespa PX PE • Vespa Rally • Vespa Sprint •

Vespa Super

R.O. 21868



**121850290**



DADO ALBERO PRIMARIO M9x1,25 | *PRIMARY*

*SHAFT NUT M9x1,25*

Confezione 10 pz. | *10 Pcs Packing*

Vespa PX 125-150-200 • Cosa • Vespa 200

Rally

R.O. 015231



**121850340**



KIT DADO-SCODELLINO-COPPIGLIA ALBERO

RUOTA POSTERIORE | *REAR WHEEL SHAFT*

*NUT-CAP SET*

Vespa PK • Vespa PK XL • Vespa N • Vespa FL2

• Vespa PX PE 125-150-200 Arcobaleno • Cosa

R.O. 194423, 563728



**121860320**



DADO FRIZIONE M10x1,5 | *FLYWHEEL NUT*

*M10x1,5*

Confezione 5 pz. | *5 Pcs Packing*

Vespa 50-90 • Vespa 125 Primavera • Vespa

ET3

R.O. 001508



**ACCESSORI ALBERI DI TRASMISSIONE - TRANSMISSION SHAFTS ACCESSORIES****121850350**DADO ALBERO RUOTA POSTERIORE | *REAR WHEEL SHAFT NUT*Confezione 10 pz. | *10 Pcs Packing*Vespa PK • Vespa PK XL • Vespa N • Vespa FL2  
• Vespa PX PE Arcobaleno

R.O. 563728

**121858520**RONDELLA DI FERMO | *WASHER PIN*Confezione 10 pz. | *10 Pcs Packing*

Vespa PX 125-150-200 • Cosa • Vespa 200

Rally

R.O. 016305

**121859230****NEW**RONDELLA FRIZIONE | *CLUTCH WASHER*28,3X36,2 mm | *28,3X36,2 mm*Vespa tutti i modelli large frame - *all large frame models*

R.O. 59109

**FRIZIONI COMPLETE - COMPLETE CLUTCHES****100290015****FERODO**FRIZIONE COMPLETA | *COMPLETE CLUTCH*

Composizione

4 Dischi conduttori - 3 Dischi condotti - 8 Molle

*Composition*

4 Friction plates - 3 Steel plates - 8 Springs

Pignone Z20 | *Pinion Z20*Codice fornitore FCC0501 | *Supplier code*

FCC0501

Cosa 1 • Cosa 2 • Vespa PX 125 T5 • Vespa PX 125 E ('98-'11) • Vespa PX 150 E ('98-'11) modelli freno a disco | *All brake discs models*

100290020



**FERODO**

FRIZIONE COMPLETA RINFORZATA |  
REINFORCED COMPLETE CLUTCH

Composizione

4 Dischi conduttori - 3 Dischi condotti - 8 Molle

*Composition*

4 Friction plates - 3 Steel plates - 8 Springs

Pignone Z20 | Pinion Z20

Codice fornitore FCC0501R | Supplier code  
FCC0501R

Cosa 1 • Cosa 2 • Vespa PX 125 T5 • Vespa PX  
125 E ('98-'11) • Vespa PX 150 E ('98-'11) modelli  
freno a disco | All brake discs models



100290000



**FERODO**

FRIZIONE COMPLETA | COMPLETE CLUTCH

Composizione

3 Dischi conduttori - 3 Dischi condotti - 1 Molla

*Composition*

3 Friction plates - 3 Steel plates - 1 Spring

Codice fornitore FCC0502 | Supplier code

FCC0502

Vespa 50 N/L/R • Vespa 50 Special • Vespa  
90 • Vespa 100 • Vespa PK 50-125 S • Vespa  
PK 50-125 XL • Vespa Primavera 125 • Vespa  
Primavera 125 ET3



100290001



**FERODO**

FRIZIONE COMPLETA MODIFICATA | MODIFIED  
COMPLETE CLUTCH

Composizione

4 Dischi conduttori - 4 Dischi condotti - 1 Molla

*Composition*

4 Friction plates - 4 Steel plates - 1 Spring

Codice fornitore FCC0502M | Supplier code

FCC0502M

Vespa 50 N/L/R • Vespa 50 Special • Vespa  
90 • Vespa 100 • Vespa PK 50-125 S • Vespa  
PK 50-125 XL • Vespa Primavera 125 • Vespa  
Primavera 125 ET3



**FRIZIONI COMPLETE - COMPLETE CLUTCHES****100290002****FERODO**FRIZIONE COMPLETA MODIFICATA RINFORZATA  
| *MODIFIED REINFORCED COMPLETE CLUTCH*

Composizione

4 Dischi conduttori - 4 Dischi condotti - 1 Molla

*Composition**4 Friction plates - 4 Steel plates - 1 Spring*Codice fornitore FCC0502MR | *Supplier code**FCC0502MR*Vespa 50 N/L/R • Vespa 50 Special • Vespa  
90 • Vespa 100 • Vespa PK 50-125 S • Vespa  
PK 50-125 XL • Vespa Primavera 125 • Vespa  
Primavera 125 ET3**100290011****FERODO**FRIZIONE COMPLETA | *COMPLETE CLUTCH*

Composizione

3 Dischi conduttori - 2 Dischi condotti - 6 Molle

*Composition**3 Friction plates - 2 Steel plates - 6 Springs*Pignone Z20 | *Pinion Z20*Codice fornitore FCC0510 | *Supplier code**FCC0510*Vespa P 80 E • Vespa PX 80 • Vespa PX 125 E  
( '81-'94)**100290014****FERODO**FRIZIONE COMPLETA MODIFICATA | *MODIFIED  
COMPLETE CLUTCH*

Composizione

4 Dischi conduttori - 3 Dischi condotti - 6 Molle

*Composition**4 Friction plates - 3 Steel plates - 6 Springs*Pignone Z20 | *Pinion Z20*Codice fornitore FCC0510M | *Supplier code**FCC0510M*Vespa P 80 E • Vespa PX 80 • Vespa PX 125 E  
( '81-'94)

## FRIZIONI COMPLETE - COMPLETE CLUTCHES

100290004



**FERODO**

FRIZIONE COMPLETA | COMPLETE CLUTCH

Composizione

3 Dischi conduttori - 3 Dischi condotti - 6 Molle

*Composition*

3 Friction plates - 3 Steel plates - 6 Springs

Codice fornitore FCC0512 | *Supplier code*

FCC0512

Vespa PK 50 XL FL • Vespa PK 50 XL HP •

Vespa PK 50 XL2 • Vespa PK 125 N • Vespa PK

125 XL2



100290005



**FERODO**

FRIZIONE COMPLETA MODIFICATA | MODIFIED  
COMPLETE CLUTCH

Composizione

4 Dischi conduttori - 3 Dischi condotti - 6 Molle

*Composition*

4 Friction plates - 3 Steel plates - 6 Springs

Codice fornitore FCC0512M | *Supplier code*

FCC0512M

Vespa PK 50 XL FL • Vespa PK 50 XL HP •

Vespa PK 50 XL2 • Vespa PK 125 N • Vespa PK

125 XL2



100290006



**FERODO**

FRIZIONE COMPLETA | COMPLETE CLUTCH

Composizione

4 Dischi conduttori - 3 Dischi condotti - 6 Molle

*Composition*

4 Friction plates - 3 Steel plates - 6 Springs

Codice fornitore FCC0512MR | *Supplier code*

FCC0512MR

Vespa PK 50 XL FL • Vespa PK 50 XL HP •

Vespa PK 50 XL2 • Vespa PK 125 N • Vespa PK

125 XL2



**FRIZIONI COMPLETE - COMPLETE CLUTCHES****100290010****FERODO**FRIZIONE COMPLETA | *COMPLETE CLUTCH*

Composizione

3 Dischi conduttori - 2 Dischi condotti - 6 Molle

*Composition**3 Friction plates - 2 Steel plates - 6 Springs*Pignone Z21 | *Pinion Z21*Codice fornitore FCC0518 | *Supplier code**FCC0518*

Vespa PX 150 ('78-'85) • Vespa PX 150 E ('83-'97)

**100290013****FERODO**FRIZIONE COMPLETA MODIFICATA | *MODIFIED COMPLETE CLUTCH*

Composizione

4 Dischi conduttori - 3 Dischi condotti - 6 Molle

*Composition**4 Friction plates - 3 Steel plates - 6 Springs*Pignone Z21 | *Pinion Z21*Codice fornitore FCC0518M | *Supplier code**FCC0518M*

Vespa PX 150 ('78-'85) • Vespa PX 150 E ('83-'97)

**100290023****FERODO**FRIZIONE COMPLETA | *COMPLETE CLUTCH*

Composizione

3 Dischi conduttori - 2 Dischi condotti - 7 Molle

*Composition**3 Friction plates - 2 Steel plates - 7 Springs*Pignone Z23 | *Pinion Z23*Codice fornitore FCC0519 | *Supplier code**FCC0519*

Cosa 1 ('88-'91) • Vespa 200 Rally • Vespa P 200 E ('77-'83) • Vespa PX 200 E ('83-'97)



## FRIZIONI COMPLETE - COMPLETE CLUTCHES

100290024



**FERODO**

FRIZIONE COMPLETA MODIFICATA | *MODIFIED COMPLETE CLUTCH*

Composizione

4 Dischi conduttori - 3 Dischi condotti - 7 Molle

*Composition*

4 Friction plates - 3 Steel plates - 7 Springs

Pignone Z23 | *Pinion Z23*

Codice fornitore FCC0519M | *Supplier code FCC0519M*

Cosa 1 ('88-'91) • Vespa 200 Rally • Vespa P 200 E ('77-'83) • Vespa PX 200 E ('83-'97)



100290017



**FERODO**

FRIZIONE COMPLETA | *COMPLETE CLUTCH*

Composizione

4 Dischi conduttori - 4 Dischi condotti - 8 molle

*Composition*

4 Friction plates - 4 Steel plates - 8 springs

Pignone Z23 | *Pinion Z23*

Codice fornitore FCC0533 | *Supplier code FCC0533*

Cosa 1 • Cosa 2 • Vespa Rally 200 • Vespa PX 150 ('95-'11) • Vespa PX 200 ('98-'05)



100290022



**FERODO**

FRIZIONE COMPLETA RINFORZATA | *REINFORCED COMPLETE CLUTCH*

Composizione

4 Dischi conduttori - 4 Dischi condotti - 8 molle

*Composition*

4 Friction plates - 4 Steel plates - 8 springs

Pignone Z23 | *Pinion Z23*

Codice fornitore FCC0533R | *Supplier code FCC0533R*

Cosa 1 • Cosa 2 • Vespa Rally 200 • Vespa PX 150 ('95-'11) • Vespa PX 200 ('98-'05)





**FRIZIONI COMPLETE - COMPLETE CLUTCHES****100290007****FERODO**FRIZIONE COMPLETA | *COMPLETE CLUTCH*

Composizione

3 Dischi conduttori - 2 Dischi condotti - 6 Molle

*Composition**3 Friction plates - 2 Steel plates - 6 Springs*Pignone Z22 | *Pinion Z22*Codice fornitore FCC0534 | *Supplier code**FCC0534*Vespa 125 VNB4-6 • Vespa 125 GT/GTR • Vespa  
125 Sprint • Vespa 125 Super • Vespa 125 TS  
• Vespa 150 VBB • Vespa 150 GL • Vespa 150  
Sprint/Sprint Veloce • Vespa 150 Super**100290008****FERODO**FRIZIONE COMPLETA MODIFICATA | *MODIFIED  
COMPLETE CLUTCH*

Composizione

4 Dischi conduttori - 3 Dischi condotti - 6 Molle

*Composition**4 Friction plates - 3 Steel plates - 6 Springs*Pignone Z22 | *Pinion Z22*Codice fornitore FCC0534M | *Supplier code**FCC0534M*Vespa 125 VNB4-6 • Vespa 125 GT/GTR • Vespa  
125 Sprint • Vespa 125 Super • Vespa 125 TS  
• Vespa 150 VBB • Vespa 150 GL • Vespa 150  
Sprint/Sprint Veloce • Vespa 150 Super**100290018****FERODO**FRIZIONE COMPLETA | *COMPLETE CLUTCH*

Composizione

4 Dischi conduttori - 3 Dischi condotti - 8 Molle

*Composition**4 Friction plates - 3 Steel plates - 8 Springs*Pignone Z22 | *Pinion Z22*Codice fornitore FCC0562 | *Supplier code**FCC0562*Cosa 1 • Cosa 2 • Vespa Rally 180-200 • Vespa  
PX 125 ('95-'11) • Vespa PX 125 T5 • Vespa PX  
150 ('95-'11) • Vespa P200E ('77-'83) • Vespa PX  
200 ('77-'05) •

## FRIZIONI COMPLETE - COMPLETE CLUTCHES

100290019



**FERODO**

FRIZIONE COMPLETA RINFORZATA |  
REINFORCED COMPLETE CLUTCH

Composizione

4 Dischi conduttori - 3 Dischi condotti - 8 Molle

Composition

4 Friction plates - 3 Steel plates - 8 Springs

Pignone Z22 | Pinion Z22

Codice fornitore FCC0562R | Supplier code  
FCC0562R

Cosa 1 • Cosa 2 • Vespa Rally 180-200 • Vespa  
PX 125 ('95-'11) • Vespa PX 125 T5 • Vespa PX  
150 ('95-'11) • Vespa P200E ('77-'83) • Vespa PX  
200 ('77-'05) •



## DISCHI FRIZIONE - CLUTCH DISCS

100300070



DISCO INTERNO FRIZIONE | CLUTCH INTERNAL  
DISC

Vespa PX • Vespa PE Sprint • Vespa Super •  
Vespa TS

R.O. 094425



100287526



**FERODO**

SERIE DISCHI FRIZIONE CONDUTTORI  
STANDARD | STANDARD FRICTION PLATES

Composizione kit 3 Dischi | Kit Composition 3  
Friction Plates

Codice fornitore FCD0507 | Supplier code  
FCD0507

Vespa PK 50-125 FL/FL2/RUSH/HP/N Per  
modelli 3 velocità | For 3 gears models



100287537



**FERODO**

SERIE DISCHI FRIZIONE CONDUTTORI  
STANDARD | STANDARD FRICTION PLATES

Composizione kit 4 Dischi | Kit Composition 4  
Friction Plates

Codice fornitore FCD0518 | Supplier code  
FCD0518

Vespa PX 125-150-200 ('95-'11) Per modelli  
freno a disco | For brake disc models



**DISCHI FRIZIONE - CLUTCH DISCS****100287538****FERODO**SERIE DISCHI FRIZIONE CONDUTTORI RACING |  
*RACING FRICTION PLATES*Composizione kit 4 Dischi | *Kit Composition 4*  
*Friction Plates*Codice fornitore FCD0518/1 | *Supplier code*  
*FCD0518/1*Vespa PX 125-150-200 ('95-'11) Per modelli  
freno a disco | *For brake disc models***100287564****FERODO**SERIE DISCHI FRIZIONE CONDUTTORI  
STANDARD | *STANDARD FRICTION PLATES*Composizione kit 3 Dischi | *Kit Composition 3*  
*Friction Plates*Codice fornitore FCD0554 | *Supplier code*  
*FCD0554*Cosa 1 125-150-200 • Vespa GS 150-160 •  
Vespa 150 Sprint • Vespa Rally 180-200 • Vespa  
180 SS • Vespa PX 200 ('77-'94) • Vespa PX 125  
T5**100287580****FERODO**SERIE DISCHI FRIZIONE CONDUTTORI  
STANDARD | *STANDARD FRICTION PLATES*Composizione kit 3 Dischi | *Kit Composition 3*  
*Friction Plates*Codice fornitore FCD0578 | *Supplier code*  
*FCD0578*Vespa 50 N/L/R • Vespa 50 Special • Vespa  
90 • Vespa 100 • Vespa PK 50-125 S • Vespa  
PK 50-125 XL • Vespa Primavera 125 • Vespa  
Primavera 125 ET3

100287606



**FERODO**

SERIE DISCHI FRIZIONE CONDUTTORI  
STANDARD | STANDARD FRICTION PLATES  
Composizione kit 3 Dischi | Kit Composition 3  
Friction Plates

Codice fornitore FCD0607 | Supplier code  
FCD0607

Vespa 125 VNA/VNB • Vespa 125 GT/GTR •  
Vespa 125 Super • Vespa 125 TS • Vespa 150  
VBA/VBB • Vespa 150 GL • Vespa 150 Sprint/  
Sprint Veloce • Vespa 150 • Super Vespa P 80  
E • Vespa PX 80 • Vespa PX 125 E ('81-'94) •  
Vespa PX 150 E ('81-'94)



100287704



**FERODO**

SERIE DISCHI FRIZIONE CONDUTTORI  
STANDARD | STANDARD FRICTION PLATES  
Composizione kit 2 Dischi | Kit Composition 2  
Friction Plates

Codice fornitore FCD0723 | Supplier code  
FCD0723

Vespa V1/V15 • Vespa V30/V33 • Vespa 98



100287703



**FERODO**

SERIE DISCHI FRIZIONE CONDUTTORI  
STANDARD | STANDARD FRICTION PLATES  
Composizione kit 3 Dischi | Kit Composition 3  
Friction Plates

Codice fornitore FCD0722 | Supplier code  
FCD0722

Vespa 125 VM/VN ('52-'57) • Vespa U VU1T



100287702



**FERODO**

SERIE DISCHI FRIZIONE CONDUTTORI  
STANDARD | STANDARD FRICTION PLATES  
Composizione kit 3 Dischi | Kit Composition 3  
Friction Plates

Codice fornitore FCD0721 | Supplier code  
FCD0721

Vespa 125 VN • Vespa 150 VL



**DISCHI FRIZIONE - CLUTCH DISCS****100287705****FERODO**

SERIE DISCHI FRIZIONE CONDUTTORI  
 STANDARD | *STANDARD FRICTION PLATES*  
 Composizione kit 3 Dischi | *Kit Composition 3 Friction Plates*  
 Codice fornitore FCD0724 | *Supplier code FCD0724*  
 Vespa GS 150 VS1/2

**100287706****FERODO**

SERIE DISCHI FRIZIONE CONDUTTORI  
 STANDARD | *STANDARD FRICTION PLATES*  
 Composizione kit 3 Dischi | *Kit Composition 3 Friction Plates*  
 Codice fornitore FCD0725 | *Supplier code FCD0725*  
 Vespa GS 150 VS2/3/4 VS5 dal telaio 47351 al 63168 | *VS5 from frame 47351 to 63168*

**100288478****FERODO**

KIT DISCHI FRIZIONE STANDARD | *STANDARD CLUTCH PLATES KIT*  
 Composizione kit 3 Dischi Conduttori  
 2 Dischi Condotti | *Kit Composition 3 Friction Plates*  
 2 Steel Plates  
 Codice fornitore FCS0507/2 | *Supplier code FCS0507/2*  
 Vespa PK 50 XL FL • Vespa PK 50 XL HP •  
 Vespa PK 50 XL2 • Vespa PK 125 N • Vespa PK 125 XL2



100288015



**FERODO**

KIT DISCHI FRIZIONE E MOLLE STANDARD |  
STANDARD CLUTCH PLATES AND SPRINGS KIT

Composizione kit 3 Dischi Conduttori

2 Dischi Condotti

6 Molle | Kit Composition 3 Friction Plates

2 Steel Plates

6 Springs

Codice fornitore FCS0507/2S | Supplier code

FCS0507/2S

Vespa PK 50 XL FL • Vespa PK 50 XL HP •

Vespa PK 50 XL2 • Vespa PK 125 N • Vespa PK

125 XL2



100288327



**FERODO**

KIT DISCHI FRIZIONE E MOLLE MODIFICA |  
MODIFIED CLUTCH PLATES AND SPRINGS KIT

Composizione kit 4 Dischi Conduttori

3 Dischi Condotti

6 Molle | Kit Composition 4 Friction Plates

3 Steel Plates

6 Springs

Codice fornitore FCS0507M | Supplier code

FCS0507M

Vespa PK 50 XL FL • Vespa PK 50 XL HP •

Vespa PK 50 XL2 • Vespa PK 125 N • Vespa PK

125 XL2



100288328



**FERODO**

KIT DISCHI FRIZIONE E MOLLE MODIFICA  
ECONOMICA | MODIFIED ECONOMIC CLUTCH  
PLATES AND SPRINGS KIT

Composizione kit 4 Dischi Conduttori

3 Dischi Condotti

6 Molle | Kit Composition 4 Friction Plates

3 Steel Plates

6 Springs

Codice fornitore FCS0507ME | Supplier code

FCS0507ME

Vespa PK 50 XL FL • Vespa PK 50 XL HP •

Vespa PK 50 XL2 • Vespa PK 125 N • Vespa PK

125 XL2



**DISCHI FRIZIONE - CLUTCH DISCS****100288475****FERODO**

KIT DISCHI FRIZIONE E MOLLE MODIFICA  
ECONOMICA | *MODIFIED ECONOMIC CLUTCH  
PLATES AND SPRINGS KIT*

Composizione kit 4 Dischi Conduttori

3 Dischi Condotti

12 Molle | *Kit Composition 4 Friction Plates*

3 Steel Plates

12 Springs

Codice fornitore FCS0507MME | *Supplier code  
FCS0507MME*

Vespa PK 50 XL FL • Vespa PK 50 XL HP •

Vespa PK 50 XL2 • Vespa PK 125 N • Vespa PK  
125 XL2

**100288335****FERODO**

KIT DISCHI FRIZIONE E MOLLE MODIFICA |  
*MODIFIED CLUTCH PLATES AND SPRINGS KIT*

Composizione kit 4 Dischi Conduttori

3 Dischi Condotti

12 Molle | *Kit Composition 4 Friction Plates*

3 Steel Plates

12 Springs

Codice fornitore FCS0507MML | *Supplier code  
FCS0507MML*

Vespa PK 50 XL FL • Vespa PK 50 XL HP •

Vespa PK 50 XL2 • Vespa PK 125 N • Vespa PK  
125 XL2

**100288329****FERODO**

KIT DISCHI FRIZIONE E MOLLE MODIFICA  
RACING | *MODIFIED RACING CLUTCH PLATES  
AND SPRINGS KIT*

Composizione kit 4 Dischi Conduttori

3 Dischi Condotti

6 Molle | *Kit Composition 4 Friction Plates*

3 Steel Plates

6 Springs

Codice fornitore FCS0507MR | *Supplier code  
FCS0507MR*

Vespa PK 50 XL FL • Vespa PK 50 XL HP •

Vespa PK 50 XL2 • Vespa PK 125 N • Vespa PK  
125 XL2



100288332



**FERODO**

KIT DISCHI FRIZIONE E MOLLE MODIFICA RACING | *MODIFIED RACING CLUTCH PLATES AND SPRINGS KIT*

Composizione kit 4 Dischi Conduttori

3 Dischi Condotti

12 Molle | *Kit Composition 4 Friction Plates*

3 Steel Plates

12 Springs

Codice fornitore FCS0507MMR | *Supplier code FCS0507MMR*

Vespa PK 50 XL FL • Vespa PK 50 XL HP •

Vespa PK 50 XL2 • Vespa PK 125 N • Vespa PK 125 XL2



100288021



**FERODO**

KIT DISCHI FRIZIONE STANDARD | *STANDARD CLUTCH PLATES KIT*

Composizione kit 4 Dischi Conduttori

4 Dischi Condotti | *Kit Composition 4 Friction Plates*

4 Steel Plates

Codice fornitore FCS0518/2 | *Supplier code FCS0518/2*

Cosa 2 125-150-200 • Vespa PX 125 ('95-'11) •

Vespa PX 150 ('95-'11) • Vespa PX 200 ('95-'05)



100288333



**FERODO**

KIT DISCHI FRIZIONE E MOLLE STANDARD | *STANDARD CLUTCH PLATES AND SPRINGS KIT*

Composizione kit 4 Dischi Conduttori

4 Dischi Condotti

8 Molle | *Kit Composition 4 Friction Plates*

4 Steel Plates

8 Springs

Codice fornitore FCS0518/2S | *Supplier code FCS0518/2S*

Cosa 2 125-150-200 • Vespa PX 125 ('95-'11) •

Vespa PX 150 ('95-'11) • Vespa PX 200 ('95-'05)





**DISCHI FRIZIONE - CLUTCH DISCS****100288022****FERODO**KIT DISCHI FRIZIONE RACING | *RACING CLUTCH PLATES AND SPRINGS KIT*

Composizione kit 4 Dischi Conduttori

4 Dischi Condotti | *Kit Composition 4 Friction Plates*

4 Steel Plates

Codice fornitore FCS0518/3 | *Supplier code FCS0518/3*Cosa 2 125-150-200 • Vespa PX 125 ('95-'11) •  
Vespa PX 150 ('95-'11) • Vespa PX 200 ('95-'05)**100288334****FERODO**

KIT DISCHI FRIZIONE E MOLLE RACING |

*RACING CLUTCH PLATES AND SPRINGS KIT*

Composizione kit 4 Dischi Conduttori

4 Dischi Condotti

8 Molle | *Kit Composition 4 Friction Plates*

4 Steel Plates

8 Springs

Codice fornitore FCS0518/3S | *Supplier code FCS0518/3S*Cosa 2 125-150-200 • Vespa PX 125 ('95-'11) •  
Vespa PX 150 ('95-'11) • Vespa PX 200 ('95-'05)**100288034****FERODO**KIT DISCHI FRIZIONE STANDARD | *STANDARD CLUTCH PLATES KIT*

Composizione kit 3 Dischi Conduttori

2 Dischi Condotti | *Kit Composition 3 Friction Plates*

2 Steel Plates

Codice fornitore FCS0554/2 | *Supplier code FCS0554/2*Cosa 1 • Cosa 2 • Vespa Rally 180-200 • Vespa  
PX 125 ('95-'11) • Vespa PX 125 T5 • Vespa PX  
150 ('95-'11) • Vespa P200E ('77-'83) • Vespa PX  
200 ('77-'05) •

100288330



**FERODO**

KIT DISCHI FRIZIONE E MOLLE MODIFICA |  
MODIFIED CLUTCH PLATES AND SPRINGS KIT

Composizione kit 3 Dischi Conduttori

2 Dischi Condotti

7 Molle | Kit Composition 3 Friction Plates

2 Steel Plates

7 Springs

Codice fornitore FCS0554M | Supplier code  
FCS0554M

Cosa 1 • Cosa 2 • Vespa Rally 180-200 • Vespa  
PX 125 ('95-'11) • Vespa PX 125 T5 • Vespa PX  
150 ('95-'11) • Vespa P200E ('77-'83) • Vespa PX  
200 ('77-'05) •



100288479



**FERODO**

KIT DISCHI FRIZIONE STANDARD | STANDARD  
CLUTCH PLATES KIT

Composizione kit 3 Dischi Conduttori

2 Dischi Condotti | Kit Composition 3 Friction  
Plates

2 Steel Plates

Codice fornitore FCS0578/2 | Supplier code  
FCS0578/2

Vespa 50 N/L/R • Vespa 50 Special • Vespa  
90 • Vespa 100 • Vespa PK 50-125 S • Vespa  
PK 50-125 XL • Vespa Primavera 125 • Vespa  
Primavera 125 ET3



100288043



**FERODO**

KIT DISCHI FRIZIONE E MOLLE STANDARD |  
STANDARD CLUTCH PLATES AND SPRINGS KIT

Composizione kit 3 Dischi Conduttori

2 Dischi Condotti

1 Molla | Kit Composition 3 Friction Plates

2 Steel Plates

1 Spring

Codice fornitore FCS0578/2S | Supplier code  
FCS0578/2S

Vespa 50 N/L/R • Vespa 50 Special • Vespa  
90 • Vespa 100 • Vespa PK 50-125 S • Vespa  
PK 50-125 XL • Vespa Primavera 125 • Vespa  
Primavera 125 ET3



**DISCHI FRIZIONE - CLUTCH DISCS****100288324****FERODO**KIT DISCHI FRIZIONE E MOLLE MODIFICA I  
*MODIFIED CLUTCH PLATES AND SPRINGS KIT*

Composizione kit 4 Dischi Conduttori

3 Dischi Condotti

1 Molla | *Kit Composition 4 Friction Plates*

3 Steel Plates

1 Spring

Codice fornitore FCS0578M | *Supplier code*  
FCS0578MVespa 50 N/L/R • Vespa 50 Special • Vespa  
90 • Vespa 100 • Vespa PK 50-125 S • Vespa  
PK 50-125 XL • Vespa Primavera 125 • Vespa  
Primavera 125 ET3**100288325****FERODO**KIT DISCHI FRIZIONE E MOLLE MODIFICA  
ECONOMICA | *MODIFIED ECONOMIC CLUTCH*  
*PLATES AND SPRINGS KIT*

Composizione kit 4 Dischi Conduttori

3 Dischi Condotti

1 Molla | *Kit Composition 4 Friction Plates*

3 Steel Plates

1 Spring

Codice fornitore FCS0578ME | *Supplier code*  
FCS0578MEVespa 50 N/L/R • Vespa 50 Special • Vespa  
90 • Vespa 100 • Vespa PK 50-125 S • Vespa  
PK 50-125 XL • Vespa Primavera 125 • Vespa  
Primavera 125 ET3**100288326****FERODO**KIT DISCHI FRIZIONE E MOLLE MODIFICA  
RACING | *MODIFIED RACING CLUTCH PLATES*  
*AND SPRINGS KIT*

Composizione kit 4 Dischi Conduttori

3 Dischi Condotti

1 Molla | *Kit Composition 4 Friction Plates*

3 Steel Plates

1 Spring

Codice fornitore FCS0578MR | *Supplier code*  
FCS0578MRVespa 50 N/L/R • Vespa 50 Special • Vespa  
90 • Vespa 100 • Vespa PK 50-125 S • Vespa  
PK 50-125 XL • Vespa Primavera 125 • Vespa  
Primavera 125 ET3

100288064



**FERODO**

KIT DISCHI FRIZIONE STANDARD | *STANDARD CLUTCH PLATES KIT*

Composizione kit 3 Dischi Conduttori  
2 Dischi Condotti | *Kit Composition 3 Friction Plates*

2 Steel Plates

Codice fornitore FCS0607/2 | *Supplier code FCS0607/2*

Vespa 125 VNA/VNB • Vespa 125 GT/GTR •  
Vespa 125 Super • Vespa 125 TS • Vespa 150  
VBA/VBB • Vespa 150 GL • Vespa 150 Sprint/  
Sprint Veloce • Vespa 150 • Super Vespa P 80  
E • Vespa PX 80 • Vespa PX 125 E ('81-'94) •  
Vespa PX 150 E ('81-'94)



100288331



**FERODO**

KIT DISCHI FRIZIONE E MOLLE MODIFICA | *MODIFIED CLUTCH PLATES AND SPRINGS KIT*

Composizione kit 4 Dischi Conduttori  
3 Dischi Condotti

6 Molle | *Kit Composition 4 Friction Plates*  
3 Steel Plates

6 Springs

Codice fornitore FCS0607M | *Supplier code FCS0607M*

Vespa 125 VNA/VNB • Vespa 125 GT/GTR •  
Vespa 125 Super • Vespa 125 TS • Vespa 150  
VBA/VBB • Vespa 150 GL • Vespa 150 Sprint/  
Sprint Veloce • Vespa 150 • Super Vespa P 80  
E • Vespa PX 80 • Vespa PX 125 E ('81-'94) •  
Vespa PX 150 E ('81-'94)



100288130



**FERODO**

KIT DISCHI FRIZIONE STANDARD | *STANDARD CLUTCH PLATES KIT*

Composizione kit 3 Dischi Conduttori  
3 Dischi Condotti | *Kit Composition 3 Friction Plates*

3 Steel Plates

Codice fornitore FCS0721/2 | *Supplier code FCS0721/2*

Vespa 125 VN • Vespa 150 VL • Vespa 150 VB1 •  
Vespa 150 Sprint VLB1 • Vespa ACMA 125-150



**DISCHI FRIZIONE - CLUTCH DISCS****100288347****FERODO**KIT DISCHI FRIZIONE E MOLLE STANDARD I  
*STANDARD CLUTCH PLATES AND SPRINGS KIT*

Composizione kit 3 Dischi Conduttori

3 Dischi Condotti

6 Molle | *Kit Composition 3 Friction Plates*

3 Steel Plates

6 Springs

Codice fornitore FCS0721/2S | *Supplier code*  
FCS0721/2S

Vespa 125 VN • Vespa 150 VL • Vespa 150 VB1 •

Vespa 150 Sprint VLB1 • Vespa ACMA 125-150

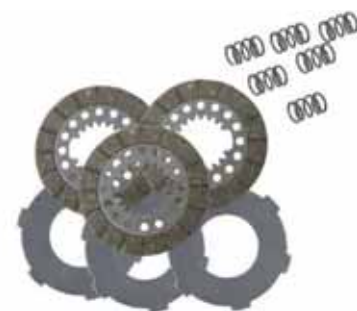
**100288131****FERODO**KIT DISCHI FRIZIONE STANDARD I | *STANDARD*  
*CLUTCH PLATES KIT*

Composizione kit 3 Dischi Conduttori

3 Dischi Condotti | *Kit Composition 3 Friction*  
*Plates*

3 Steel Plates

Codice fornitore FCS0722/2 | *Supplier code*  
FCS0722/2

Vespa 125 VM/VN ('52-'57) • Vespa U VU1T

**100288348****FERODO**KIT DISCHI FRIZIONE E MOLLE STANDARD I  
*STANDARD CLUTCH PLATES AND SPRINGS KIT*

Composizione kit 3 Dischi Conduttori

3 Dischi Condotti

6 Molle | *Kit Composition 3 Friction Plates*

3 Steel Plates

6 Springs

Codice fornitore FCS0722/2S | *Supplier code*  
FCS0722/2S

Vespa 125 VM/VN ('52-'57) • Vespa U VU1T



## DISCHI FRIZIONE - CLUTCH DISCS

100288132



**FERODO**

KIT DISCHI FRIZIONE STANDARD | *STANDARD CLUTCH PLATES KIT*

Composizione kit 2 Dischi Conduttori  
2 Dischi Condotti | *Kit Composition 2 Friction Plates*

2 Steel Plates

Codice fornitore FCS0723/2 | *Supplier code FCS0723/2*

Vespa V1/V15 • Vespa V30/V33 • Vespa 98



100288349



**FERODO**

KIT DISCHI FRIZIONE E MOLLE STANDARD | *STANDARD CLUTCH PLATES AND SPRINGS KIT*

Composizione kit 2 Dischi Conduttori  
2 Dischi Condotti

6 Molle | *Kit Composition 2 Friction Plates*

2 Steel Plates

6 Springs

Codice fornitore FCS0723/2S | *Supplier code FCS0723/2S*

Vespa V1/V15 • Vespa V30/V33 • Vespa 98



100288133



**FERODO**

KIT DISCHI FRIZIONE STANDARD | *STANDARD CLUTCH PLATES KIT*

Composizione kit 3 Dischi Conduttori  
3 Dischi Condotti | *Kit Composition 3 Friction Plates*

3 Steel Plates

Codice fornitore FCS0724/2 | *Supplier code FCS0724/2*

Vespa GS 150 VS1/2



**DISCHI FRIZIONE - CLUTCH DISCS****100288350****FERODO**KIT DISCHI FRIZIONE E MOLLE STANDARD I  
*STANDARD CLUTCH PLATES AND SPRINGS KIT*

Composizione kit 3 Dischi Conduttori

3 Dischi Condotti

6 Molle | *Kit Composition 3 Friction Plates*

3 Steel Plates

6 Springs

Codice fornitore FCS0724/2S | *Supplier code*  
FCS0724/2S

Vespa GS 150 VS1/2

**100288134****FERODO**KIT DISCHI FRIZIONE STANDARD I | *STANDARD*  
*CLUTCH PLATES KIT*

Composizione kit 3 Dischi Conduttori

3 Dischi Condotti | *Kit Composition 3 Friction*  
*Plates*

3 Steel Plates

Codice fornitore FCS0725/2 | *Supplier code*  
FCS0725/2Vespa GS 150 VS2/3/4 VS5 dal telaio 47351 al  
63168 | *VS5 from frame 47351 to 63168***100288351****FERODO**KIT DISCHI FRIZIONE E MOLLE STANDARD I  
*STANDARD CLUTCH PLATES AND SPRINGS KIT*

Composizione kit 3 Dischi Conduttori

3 Dischi Condotti

6 Molle | *Kit Composition 3 Friction Plates*

3 Steel Plates

6 Springs

Codice fornitore FCS0725/2S | *Supplier code*  
FCS0725/2SVespa GS 150 VS2/3/4 VS5 dal telaio 47351 al  
63168 | *VS5 from frame 47351 to 63168*

## MOLLE FRIZIONE - CLUTCH SPRINGS

100288313



**FERODO**

Codice Fornitore FSS0502 | *Supplier code*  
FSS0502

Vespa 50-90 • Vespa 125 Primavera • Vespa  
ET3 • Vespa PK 50 • Vespa PK 50-125XL  
R.O. 112890



121950140



Confezione Pz. 10 | *10 Pcs Packing*

Vespa PX • Vespa PE Sprint • Vespa Super •  
Vespa TS  
R.O. 022821

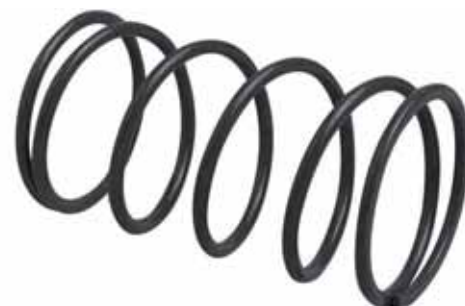

100288323



**FERODO**

Codice Fornitore FSS0521 | *Supplier code*  
FSS0521

Vespa PX • Vespa PE Sprint • Vespa Super •  
Vespa TS  
R.O. 022821



100288256



**FERODO**

Codice Fornitore FSS0131 | *Supplier code*  
FSS0131

Vespa PX 125 • Vespa PE 125



100288274



**FERODO**

KIT MOLLE FRIZIONE | *CLUTCH SPRINGS KIT*  
Codice Fornitore FSS0218 | *Supplier code*  
FSS0218

Confezione Pz. 6 | *6 Pcs Packing*

Vespa 125 VM/VN ('52-'57) • Vespa U VU1T

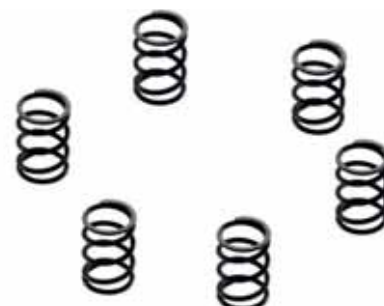



**COPPIA TRASMISSIONI PRIMARIE - CLUTCH GEARS COUPLE****100240130**DENTI ELICOIDALI Z22 - Z63 | *HELICOIDAL  
TEETH Z22 - Z63*Vespa 50-90 • Vespa 125 Primavera • Vespa  
ET3 • Vespa PK 50 • Vespa PK 50-125XL**100240140**DENTI ELICOIDALI Z24 - Z61 | *HELICOIDAL  
TEETH Z24 - Z61*Vespa 50-90 • Vespa 125 Primavera ET3 •  
Vespa PK  
R.O. 110670**100240150**DENTI DRITTI Z24 - Z72 | *STRAIGHT TEETH Z24  
- Z72*Vespa 50-90-125 • Vespa Primavera • Vespa  
ET3 • Vespa PK 50 • Vespa PK 50-125XL

## COPPIA TRASMISSIONI PRIMARIE - CLUTCH GEARS COUPLE

100240160



DENTI DRITTI Z27 - Z69 | *STRAIGHT TEETH Z27 - Z69*

Vespa 50-90 • Vespa 125 Primavera ET3 • Vespa PK



100240170



DENTI ELICOIDALI Z18 - Z67 SENZA PARASTRAPPI | *HELICOIDAL TEETH Z18 - Z67 WITHOUT BUFFER SPRINGS*

Vespa 50 • Vespa 50 Special • Vespa PK 50



100268038



**FERODO**

DENTI DRITTI Z29 - Z68 CON PARASTRAPPO | *STRAIGHT TEETH Z29 - Z68 WITH DAMPER*

Vespa 50-90 • Vespa 125 Primavera ET3 • Vespa PK



**PRESELETTORI CAMBIO - GEAR BOX SELECTORS****100221000**4 marce | *4 gears*Vespa 150 Super • Vespa Sprint  
R.O. 092167**100221010**4 marce | *4 gears*Vespa P 125X • Vespa P 150X • Vespa P 200E •  
Vespa PX Arcobaleno ('81-'97)  
R.O. 138880**100221020**CON SENSORE FOLLE | *WITH NEUTRAL SENSOR*4 marce | *4 gears*Vespa PX PE Arcobaleno • Cosa  
R.O. 199803**100221030**4 marce | *4 gears*Vespa PX 125-150-200  
R.O. 196585

## PRESELETTORI CAMBIO - GEAR BOX SELECTORS

**100240203** **NEW**



LEVA COMANDO PRESELETTORE MARCE,  
SUPERIORE | *SELECTOR GEAR ARM LEVER*

Vespa 125 VNB5-6T-TS • Vespa 150 VBB-Super  
• Vespa 160 GS • Vespa 180 SS • Vespa Rally •  
Vespa PX 80-200 • Vespa PE • Vespa Lusso •  
Vespa T5 • Cosa

R.O. 202503, 285452, 059408, 59408



**121850194** **NEW**



PERNO PRESELETTORE MARCE | *GEAR BOX  
SELECTOR PIN*

Vespa 125 VNB5-6T-TS • Vespa 150 VBB-Super  
• Vespa 160 GS • Vespa 180 SS • Vespa Rally •  
Vespa PX 80-200 • Vespa PE • Vespa Lusso •  
Vespa T5 • Cosa 1

R.O. 059407



## ACCESSORI TRASMISSIONE - TRANSMISSION ACCESSORIES

**100260100**



MOZZETTO FRIZIONE | *CLUTCH SPIDER*

Ø 65 mm

Standard

Vespa 50-90-125 • Vespa Primavera • Vespa  
ET3 • Vespa PK 50 • Vespa PK 50-125XL

R.O. 79497



**100260130**



CAMPANA FRIZIONE | *CLUTCH BOX*

Vespa PX • Vespa PE Sprint • Vespa Super •

Vespa TS

R.O. 059369



**ACCESSORI TRASMISSIONE - TRANSMISSION ACCESSORIES****100260230**

Tipo originale | *Original Type*  
 Trattamento ad Induzione | *Induction Treatment*  
 Vespa PX • Vespa PE Sprint • Vespa Super •  
 Vespa TS  
 R.O. 059369

**100260140**

CAMPANA FRIZIONE | *CLUTCH BOX*  
 Vespa PE 200 • Vespa 125 T5 • Vespa 180-200  
 Rally • Cosa 1-2  
 R.O. 2458295

**100260240**

Tipo originale | *Original Type*  
 Trattamento ad Induzione | *Induction Treatment*  
 Vespa PE 200 • Vespa 125 T5 • Vespa 180-200  
 Rally • Cosa 1-2  
 R.O. 2458295

**100260253**

BOCCOLA FRIZIONE | *CLUTCH BUSH*  
 Ø106 x 31 mm  
 Vespa PE 200 • Vespa 125 T5 • Vespa 180-200  
 Rally • Cosa 1-2  
 R.O. 159853

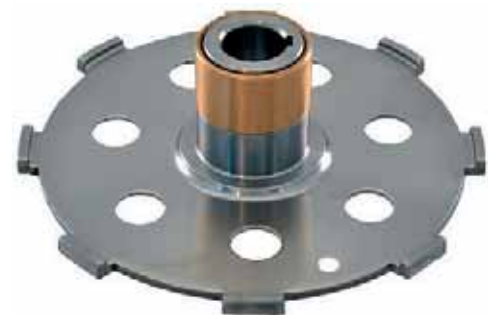

**100300050**



KIT PARASTRAPPI TRASMISSIONE PRIMARIA |  
PRIMARY DRIVE KIT

Vespa PX • Vespa PE Sprint • Vespa Super •  
Vespa TS

R.O. 077370, 077371, 078853



**100300060**



KIT PARASTRAPPI TRASMISSIONE PRIMARIA |  
PRIMARY DRIVE KIT

Vespa PE 200 • Vespa 125 T5 • Vespa 180-200  
Rally • Cosa 1-2

R.O. 077370, 077371, 078853, 077372



**100300080**



KIT PARASTRAPPI TRASMISSIONE PRIMARIA |  
PRIMARY DRIVE KIT

Vespa 50-90-125 • Vespa Primavera • Vespa  
ET3 • Vespa PK 50 • Vespa PK 50-125XL

R.O. 154625



**100300161**



PIATTELLO CON MOLLA RALLINO FRIZIONE |  
ACTUATING PLATE FOR CLUTCH

Vespa PX • Vespa PE Sprint • Vespa Super •  
Vespa TS

R.O. 016821, 014457, 2/89858



**ACCESSORI TRASMISSIONE - TRANSMISSION ACCESSORIES****100300171**PIATTELLO CON MOLLA RALLINO FRIZIONE |  
*ACTUATING PLATE FOR CLUTCH*Vespa PE 200 • Vespa 125 T5 • Vespa 180-200  
Rally • Cosa 1-2  
R.O. 025026, 014457, 2/89858**100300180**PIATTELLO CON MOLLA RALLINO FRIZIONE |  
*ACTUATING PLATE FOR CLUTCH*Vespa 50-90-125 • Vespa Primavera • Vespa  
ET3 • Vespa PK 50 • Vespa PK 50-125XL  
R.O. 016821, 014457, 165019**100300430**RALLINO FRIZIONE | *PUSH ROD CLUTCH*Vespa 50-90  
R.O. 078453**100300440**RALLINO FRIZIONE | *PUSH ROD CLUTCH*Vespa 50-90-125 • Vespa Primavera • Vespa  
ET3 • Vespa PK 50 • Vespa PK 50-125XL  
R.O. 165019

**100300450**



LEVETTA FRIZIONE | *CLUTCH LEVER*

Confezione 5 pz. | *5 Pcs Packing*

Vespa PX • Vespa PE Sprint • Vespa Super •

Vespa TS

R.O. 083806



**100300460**



RALLINO FRIZIONE | *PUSH ROD CLUTCH*

Vespa PX • Vespa PE Sprint • Vespa Super •

Vespa TS

R.O. 089858



**100300483**



LEVA ESTERNA FRIZIONE | *EXTERNAL CLUTCH LEVER*

Vespa tutti i modelli large frame - *all large frame models*

R.O. 0979844



**100300493**



COPERCHIO FRIZIONE | *CLUTCH COVER*

Vespa tutti i modelli large frame - *all large frame models*

R.O. 50100



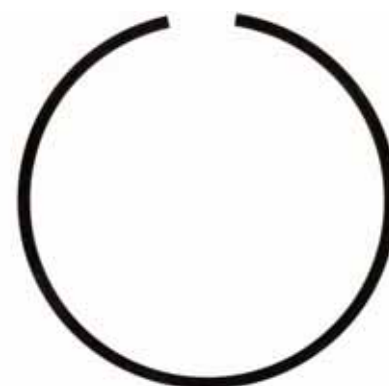

**ACCESSORI TRASMISSIONE - TRANSMISSION ACCESSORIES****100300500** **NEW**DISTANZIALE CAMPANA FRIZIONE | *CLUTCH BELL SPACERS*Confezione 10 pz. | *10 Pcs Packing*Vespa 50-125 Primavera Et3 • Vespa 50-125 FL  
• Vespa PK 50-125 • Vespa PK 50-125XL  
R.O. 078594**100300531** **NEW**RACCOGLITORE OLIO | *OIL CANS*Vespa 50-90-125 • Vespa Primavera • Vespa  
ET3 • Vespa PK 50 • Vespa PK 50-125XL  
R.O. 286018**100300532** **NEW**ANELLO ELASTICO CHIUSURA FRIZIONE |  
*CLUTCH GROUP CLOSING ELASTIC RING*Vespa 50-90-125 • Vespa Primavera • Vespa  
ET3 • Vespa PK 50 • Vespa PK 50-125XL  
R.O. 286019**100300533** **NEW**ANELLO ELASTICO CHIUSURA FRIZIONE |  
*CLUTCH GROUP CLOSING ELASTIC RING*Vespa P 125X • Vespa PX 125 EFL • Vespa P  
150X • Vespa PX 150E • Vespa 150 Super •  
Vespa Sprint • Vespa GT

121850390



DADO CAMPANA FRIZIONE | CLUTCH RING NUT

Confezione 10 pz. | 10 Pcs Packing

Vespa PX 125-150-200 • Vespa PX PE

Arcobaleno • Cosa • Vespa T5

Vespa tutti i modelli large frame - all large  
frame models

R.O. 020375, 40316



121859170

NEW



KIT DADI E RONDELLE FRIZIONE/COPPIA

PRIMARIA | KIT NUTS AND CLUTCH WASHERS/  
PRIMARY TORQUE

Confezione 20 pz. | 20 Pcs Packing

Vespa 50-90 • Vespa 125 Primavera • Vespa  
ET3



121859171

NEW



RONDELLA BLOCCA DADO FRIZIONE | LOCKING  
WASHER CLUTCH

Confezione 20 pz. | 20 Pcs Packing

Vespa 50-90 • Vespa 125 Primavera • Vespa  
ET3

R.O. 244297



121859172

NEW



RONDELLA BLOCCA DADO PIGNONE CP.

PRIMARIA | LOCKING WASHER PRIMARY GEAR

Confezione 20 pz. | 20 Pcs Packing

Vespa 50-90 • Vespa 125 Primavera • Vespa  
ET3

R.O. 001821



**ACCESSORI TRASMISSIONE - TRANSMISSION ACCESSORIES****121859242** **NEW**

PIASTRA FERMA BULLONE PERNO  
 INGRANAGGIO MULTIPIO | *SECURING PLATE*  
 INPUT SHAFT

Vespa PX 50-90-125-150-160-180-200  
 R.O. 016305

**121859245** **NEW**

PIASTRA FERMA BULLONE PERNO  
 INGRANAGGIO MULTIPIO | *SECURING PLATE*  
 INPUT SHAFT

Vespa 125 VNB 2° serie • Vespa TS • Vespa 150  
 VBA 2° serie • Vespa Super • Vespa P 125-150X  
 1° serie • Vespa P 150S 1° serie  
 Adatto per - *Suitable for* Vespa 160 GS • Vespa  
 180 SS  
 R.O. 058560

**121859248** **NEW**

KIT DADO FRIZIONE | *CLUTCH NUT SET*  
 M12 mm

Vespa 125 V1-TS • Vespa 150 VL-Super • Vespa  
 160 GS • Vespa 180 SS/Rally • Vespa PX 80-  
 200/PE/Lusso/Cosa/T5

**121859249** **NEW**

RONDELLA BLOCCO DADO FRIZIONE | *CLUTCH*  
 NUT WASHER

M12 mm  
 Ø 13x24 mm | Ø 13x24 mm

Spessore 1,2 mm | *Thickness 1,2 mm*

Vespa 50-90 • Vespa 125 Primavera • Vespa  
 ET3

R.O. 244297



**121859258** **NEW**



RONDELLA FRIZIONE | *CLUTCH WASHER*

32x15,8x1,55 mm | *32x15,8x1,55 mm*

Vespa 125 VNA2T (dal telaio n.081469 - *from chassis n.081469*) • Vespa VNB • Vespa GT • Vespa GTR 1° serie • Vespa Super • Vespa TS 1° serie • Vespa 150 VBA • Vespa VBB • Vespa VGLA • Vespa VGLB • Vespa GL • Vespa Sprint • Vespa V 1°serie • Vespa Super 1° serie  
R.O. 048834



**121860330**



DADO PIGNONE | *CLUTCH NUT*

M12 x 1,5 mm | *M12 x 1,5 mm*

Confezione 5 pz. | *5 Pcs Packing*

Vespa 50-90 • Vespa 125 Primavera • Vespa ET3  
R.O. 001510, 015239



# CARROZZERIA

BODY WORK



## SPECCHIETTI RETROVISORI - REAR VIEW MIRRORS

### SPECCHIETTI LATO SINISTRO - LEFT REAR MIRRORS

**122760110**



Dimensioni 92x92 mm | *Dimensions 92x92 mm*

Lunghezza della barra 175 mm | *Stem length 175 mm*

Inclusa piastra specchietto | *Mounting plate included*

Vespa tutti i modelli | *All models*

Specchio sinistro/destro nero - *Black left/right mirror*

R.O. 244141



**122760790**



Passo Perno cilindrico Ø 10 mm | *Thread Cylindrical pin Ø 10 mm*

Diametro specchio Ø 100mm | *Mirror diameter Ø 100mm*

Lunghezza della barra 270 mm | *Stem length 270 mm*

Con marchio di omologazione E | *With E-mark Cromato | Chromed*

Vespa PX 125-150 Millenium • Vespa PX 125-150 (\*11)

R.O. CM181301, CM181302



**122760920**



Passo M10 | *Thread M10*

Diametro specchio Ø 110mm | *Mirror diameter Ø 110mm*

Lunghezza della barra 220 mm | *Stem length 220 mm*

Con marchio di omologazione E | *With E-mark Cromato | Chromed*

Inclusa piastra specchietto | *Mounting plate included*

Vespa tutti i modelli | *All models*

R.O. 610092M



**SPECCHIETTI RETROVISORI - REAR VIEW MIRRORS**

**SPECCHIETTI LATO DESTRO - RIGHT REAR MIRRORS**

**122770920**



Passo M10 | *Thread M10*  
 Diametro specchio Ø 110mm | *Mirror diameter Ø 110mm*  
 Lunghezza della barra 220 mm | *Stem length 220 mm*  
 Con marchio di omologazione E | *With E-mark*  
 Cromato | *Chromed*  
 Inclusa piastra specchietto | *Mounting plate included*  
 Vespa tutti i modelli | *All models*  
 R.O. 610092M



**122770790**



Passo Perno cilindrico Ø 10 mm | *Thread Cylindrical pin Ø 10 mm*  
 Diametro specchio Ø 100mm | *Mirror diameter Ø 100mm*  
 Lunghezza della barra 270 mm | *Stem length 270 mm*  
 Con marchio di omologazione E | *With E-mark*  
 Cromato | *Chromed*  
 Vespa PX 125-150 Millenium • Vespa PX 125-150 ("11)  
 R.O. CM181302, CM181303



**122771580**



Passo M10 | *Thread M10*  
 Diametro specchio Ø 110mm | *Mirror diameter Ø 110mm*  
 Lunghezza della barra 290 mm | *Stem length 290 mm*  
 Con marchio di omologazione E | *With E-mark*  
 Cromato | *Chromed*  
 Inclusa piastra specchietto | *Mounting plate included*  
 Vespa tutti i modelli | *All models*  
 Specchio sinistro/destro | *Left/right mirror*



## SPECCHIETTI RETROVISORI - REAR VIEW MIRRORS

**122771780**



Passo M10 | *Thread M10*  
 Dimensioni 130x95 mm | *Dimensions 130x95 mm*  
 Lunghezza della barra 290 mm | *Stem length 290 mm*  
 Con marchio di omologazione E | *With E-mark*  
 Cromato | *Chromed*  
 Inclusa piastra specchietto | *Mounting plate included*  
 Vespa tutti i modelli | *All models*  
 Specchio sinistro/destro | *Left/right mirror*



**122771790**



Passo M10 | *Thread M10*  
 Dimensioni 130x95 mm | *Dimensions 130x95 mm*  
 Lunghezza della barra 290 mm | *Stem length 290 mm*  
 Con marchio di omologazione E | *With E-mark*  
 Cromato | *Chromed*  
 Inclusa piastra specchietto | *Mounting plate included*  
 Vespa tutti i modelli | *All models*  
 Specchio sinistro/destro | *Left/right mirror*



## ADATTATORI SPECCHIETTI - REAR VIEW MIRRORS ADAPTERS

**121850040**



M8, Ø14 mm  
 Vespa PX Millenium  
 R.O. 622391, 581675





**ADATTATORI SPECCHIETTI - REAR VIEW MIRRORS ADAPTERS**

**ACCESSORI SPECCHIETTI - REAR VIEW MIRRORS ACCESSORIES**

**121850180**



STAFFA SUPPORTO SPECCHIO CROMATA |  
CHROMED MIRROR HOLDER

Vespa tutti i modelli | All models



**PARAFANGHI - MUDGUARDS**

**PARAFANGO ANTERIORE - FRONT MUDGUARD**

**142680070**



Materiale Acciaio | Material Steel

Colore Nero | Colour Black

Vespa 50 N/R/L • Vespa 50 Special • Vespa 125  
Primavera • Vespa 125 Primavera ET3  
R.O. 183680



**142680071**

**NEW**



Materiale Plastica | Material Plastic

Colore Nero | Colour Black

Vespa 50 N/R/L • Vespa 50 Special • Vespa 125  
Primavera • Vespa 125 Primavera ET3  
R.O. 183680



## PARAFANGHI - MUDGUARDS

142680072 **NEW**



**FACO**



Materiale Acciaio | *Material Steel*

Colore Nero | *Colour Black*

Vespa 50 N/R/L • Vespa 50 Special • Vespa 125  
Primavera • Vespa 125 Primavera ET3  
R.O. 183680



142680080



Materiale Acciaio | *Material Steel*

Colore Nero | *Colour Black*

Vespa PX • Vespa PXE Arcobaleno 125-150-  
200 ('81-'97)  
R.O. 1774976



142680081 **NEW**



Materiale Plastica | *Material Plastic*

Colore Nero | *Colour Black*

Vespa PX • Vespa PXE Arcobaleno 125-150-  
200 ('81-'97)  
R.O. 1774976



**PARAFANGHI - MUDGUARDS**

**142680082** **NEW**



**FACO**



Materiale Acciaio | *Material Steel*

Colore Nero | *Colour Black*

Vespa PX • Vespa PXE Arcobaleno 125-150-200 ('81-'97)

R.O. 1774976



**142680130**



Materiale Acciaio | *Material Steel*

Colore Nero | *Colour Black*

Vespa PX 80-200'98/MY

R.O. 5638116

Modelli con freno a disco | *Models with brake disc*



**142680131** **NEW**



Materiale Plastica | *Material Plastic*

Colore Nero | *Colour Black*

Vespa PX 80-200'98/MY

R.O. 5638116

Modelli con freno a disco | *Models with brake disc*



## PARAFANGHI - MUDGUARDS

142680132 **NEW**



**FACO**



Materiale Acciaio | *Material Steel*

Colore Nero | *Colour Black*

Vespa PX 80-200'98/MY

R.O. 5638116

Modelli con freno a disco | *Models with brake disc*



142680140



Materiale Acciaio | *Material Steel*

Colore Nero | *Colour Black*

Vespa 150 Sprint-Sprint Veloce • Vespa GT-GTR

• Vespa Rally 180-200

R.O. 120604



142680150



Materiale Acciaio | *Material Steel*

Colore Nero | *Colour Black*

Vespa PK 50XL ('85-'88) • Vespa PK 125XL

('86-'89) • Vespa PK XL Plurimatic 50 ('85-'90) •

Vespa Rush 50 ('88-'89)

R.O. 226754



**PARAFANGHI - MUDGUARDS**

**142680151**

**NEW**



Materiale Plastica | *Material Plastic*

Colore Nero | *Colour Black*

Vespa PK 50XL ('85-'88) • Vespa PK 125XL ('86-'89) • Vespa PK XL Plurimatic 50 ('85-'90) • Vespa Rush 50 ('88-'89)  
R.O. 226754



**142680152**

**NEW**



**FACO**



Materiale Acciaio | *Material Steel*

Colore Nero | *Colour Black*

Vespa PK 50XL ('85-'88) • Vespa PK 125XL ('86-'89) • Vespa PK XL Plurimatic 50 ('85-'90) • Vespa Rush 50 ('88-'89)  
R.O. 226754



**142680330**



Vespa PK N ('89-90) • Vespa PK FL2 HP ('91-'97) • Vespa PK FL2 Automatica ('90-'91) • Vespa PK FL • Vespa PK 125 FL ('89-'90)  
R.O. 911100



## CRESTE PARAFANGO - FENDER CRESTS

142660060



142660062 **NEW**



CRESTA PARAFANGO ALLUMINIO | ALLOY  
FENDER CREST

Dimensioni 185x20 mm | Dimensions 185x20 mm

Interasse fori 90 mm | Pin distance 90 mm

Materiale Alluminio | Material Aluminium

Vespa 50 Special • Vespa TS • Vespa Sprint Veloce

R.O. 124708



142660070



CRESTA PARAFANGO ALLUMINIO | ALLOY  
FENDER CREST

Lunghezza 200 mm | Length 200 mm

Interasse fori 85 mm | Pin distance 85 mm

Materiale Alluminio opaco | Material Matt aluminium

Vespa 160 GS • Vespa Sprint • Vespa GT • Vespa GTR • Vespa 180 SS

R.O. 092714



142660080



142660082 **NEW**



CRESTA PARAFANGO ALLUMINIO | ALLOY  
FENDER CREST

Lunghezza 165 mm | Length 165 mm

Interasse fori 90 mm | Pin distance 90 mm

Materiale Alluminio opaco | Material Matt aluminium

Vespa 50 (dal '67 fino alla Vespa R - from '67 to Vespa R) • Vespa 125 (da VBN2 a VBN6 - from VBN2 to VBN6) • Vespa 125 Primavera • Vespa Primavera ET3 • Vespa 125-150 Super • Vespa 150 (VBA-VBB1-VBB2)

R.O. 150070



**CRESTE PARAFANGO - FENDER CRESTS**

**142660300** **NEW**



CRESTA PARAFANGO A TRIANGOLO | *TRIANGLE FENDER CREST*

Materiale Alluminio lucido | *Material Polished aluminium*

Interasse fori 60 mm | *Pin distance 60 mm*

Vespa 150 VL1-VL3 • Vespa 150 VB1 • Vespa GS 150 VS1-VS4T

R.O. 023585



**142660310** **NEW**



CRESTA PARAFANGO CON PIOLI E PIASTRINE | *FENDER CREST WITH PEGS AND PLATES*

Vespa 125 VM1 ('53-'54)



**142660320** **NEW**



CRESTA PARAFANGO CON PIOLI FILETTATI | *FENDER CREST WITH THREADED PEGS*

Vespa 125 VNA1/2 VNB1/2 ('57-'60)



## CRESTE PARAFANGO - FENDER CRESTS

142660340 **NEW**



CRESTA PARAFANGO CON LINGUETTE |  
FENDER CREST WITH TABS

Vespa 98-125 V1/V15/V30/V33 ('48-'52)



## COPRIMANUBRI - HANDLEBAR COVERS

142680250



Sede contachilometri Ø 82 mm | Ø 82 mm

odometer seat

3 fori | 3 holes

Non verniciato | Not painted

Vespa PX-PE 1° Serie ('78-'82)

R.O. 139829, 610368M



142680260



Sede contachilometri Ø 100 mm | Ø 100 mm

odometer seat

Senza fori per specchietti | Without holes for  
mirrors

Non verniciato | Not painted

Vespa PX 80-125-150-200 Arcobaleno ('81-'97)

R.O. 9046005, 179731





COPRIMANUBRI - HANDLEBAR COVERS

142680270



Sede contachilometri Ø 82 mm | Ø 82 mm  
 odometer seat  
 2 fori | 2 holes  
 Non verniciato | Not painted  
 Modello senza lampeggiatori | Model without  
 flashers  
 Vespa PX 1° Serie  
 R.O. 174014



142680310



Sede contachilometri Ø 100 mm | Ø 100 mm  
 odometer seat  
 Con fori per specchietti | With holes for mirrors  
 Non verniciato | Not painted  
 Vespa PX 125 ('98-'01) • Vespa PX 125 ('11-'13) •  
 Vespa PX 125 Euro2 ('01-'07) • Vespa PX 125 30  
 Anni ('07-'08) • Vespa PX 150 ('11-'15)  
 R.O. 6224306, 581517, CM060001



142680430



Sede contachilometri Ø 70 mm | Ø 70 mm  
 odometer seat  
 Contachilometri piccolo con spie di controllo |  
 Small speedometer, with control light  
 Non verniciato | Not painted  
 Vespa PK 50-125S  
 R.O. 178933



**142680440**



Sede contachilometri Ø 70 mm | Ø 70 mm  
odometer seat

Contachilometri piccolo senza spie di controllo

| Small speedometer, without control light

Non verniciato | Not painted

Vespa PK 50-125 1° Serie

R.O. 178637



**142680450**



Sede contachilometri Ø 100 mm | Ø 100 mm  
odometer seat

In plastica | Plastic made

Non verniciato | Not painted

Vespa PK 50-125XL

R.O. 226730



**142680460**



Vespa 50 FL • Vespa 50 FL2 Automatica •

Vespa 50 FL2 HP

R.O. 921700



**COPRIMANUBRI - HANDLEBAR COVERS**

**142680503**



Modelli freno a tamburo | *Brake drum models*  
 Vespa PX  
 R.O. 563789



**142680514**



Modelli freno a disco | *Brake disc models*  
 Vespa LML  
 Adattabile a Vespa PX - *Suitable for Vespa PX*  
 R.O. 563789, C-4721746, C-4721745, SF504,  
 1130



**CALANDRE - STEERING COVERS**

**142600010**



Grigio | *Grey*  
 Vespa 50 Special  
 R.O. 143593



**142600011**



Nero | *Black*

Vespa 50 Special V5A2 (>'72) • Vespa 50

Elestart V5A3 (>'72)

R.O. 123222, 143593



**142600020**



Non verniciato | *Not painted*

Vespa PX-PE 125-150-200

R.O. 183779



**142600050**



Nero | *Black*

Vespa PK 50-125XL • Vespa 50 Rush

R.O. 9007005, 226726



CALANDRE - STEERING COVERS

142600060



Non verniciato | *Not painted*  
 Vespa FL2 • Vespa N • Vespa HP  
 R.O. 256344



142600071

**NEW**



Vespa PX-PE 125-150-200  
 R.O. 9004005



142600080



Non verniciato | *Not painted*  
 Vespa 125 T5  
 R.O. 232893



## CALANDRE - STEERING COVERS

142600090



Non verniciato | *Not painted*  
 In plastica | *Plastic made*  
 Vespa PK 50 ('82-'84) • Vespa PK 50  
 Automatica ('84-'89)  
 R.O. 219564, 214387



## PROFILI CARROZZERIA - CHASSIS BEADINGS

142640040



PROFILO SCUDO IN PLASTICA | *LEGSHIELD*  
 FRAME PROFILE  
 Metallizzato grigio | *Silver colour*  
 Vespa PX PE • Vespa PX PE Arcobaleno  
 R.O. 218944

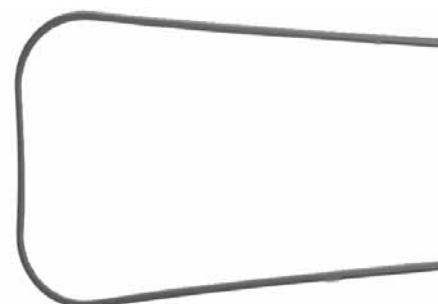

142640050



PROFILO SCUDO IN PLASTICA | *LEGSHIELD*  
 FRAME PROFILE  
 Colore nero | *Black colour*  
 Vespa PX PE • Vespa PX PE Arcobaleno • Vespa  
 125 T5  
 R.O. 226097, 218944



142640220



PROFILO SCUDO IN GOMMA | *RUBBER*  
 LEGSHIELD FRAME PROFILE  
 Nero | *Black*  
 Vespa PK • Vespa PK XL • Vespa FL  
 R.O.256938

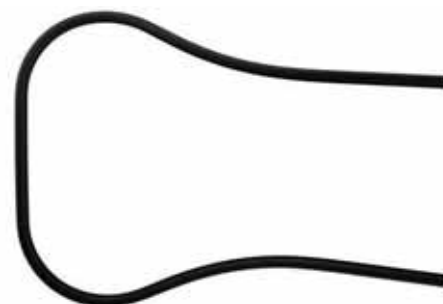

PROFILI CARROZZERIA - CHASSIS BEADINGS

142640060



PROFILO BORDO SCUDO IN GOMMA | RUBBER STRIP

Rotoli da 8 m, nero | 8 m roll, black colour

Vespa 50-90 • Vespa 125 Primavera • Vespa ET3



142640070



PROFILO COFANO LATERALE IN GOMMA | SIDE PANEL RUBBER STRIP

Rotoli da 12 m, nero | 12 m roll, black colour

Larghezza 14 mm | Width 14 mm

Vespa PX 125-150-200 • Vespa PXE Arcobaleno  
R.O. C-4727150, C-4727151 (LML)



142640080



PROFILO CUPOLINO STANDARD IN GOMMA | WINDSHIELD RUBBER STRIP

Rotoli da 12 m, nero | 12 m roll, black colour



142640090



PROFILO FILTRO ARIA IN GOMMA | AIR FILTER RUBBER STRIP

Rotoli da 10 m, nero | 10 m roll, black colour

Vespa 50 • Vespa PK • Vespa PX  
R.O. 058853, 227609, 239049



142640100



PROFILO SCUDO IN GOMMA | RUBBER STRIP  
Lunghezza 165 cm, nero | Length 165 cm, black colour

Vespa 50-90 • Vespa 125 Primavera • Vespa ET3



**142640101**



PROFILO SCUDO | *RUBBER STRIP*

Lunghezza 165 cm, grigio | *Length 165 cm, grey colour*

Vespa 50-90 • Vespa 125 Primavera • Vespa ET3



**142640110**



PROFILO BAULETTO IN GOMMA | *TOP BOX RUBBER STRIP*

Lunghezza 180 cm, nero | *Length 180 cm, black colour*

Larghezza 9 mm | *Width 9 mm*

Vespa PX 125-150-200 • Vespa PXE Arcobaleno • Vespa 50-90 • Vespa 125 Primavera • Vespa ET3

R.O. 219165, 183540



**142640120**



PROFILO COFANO LATERALE | *SIDEPANEL RUBBER STRIP*

Lunghezza 110 cm, nero | *Length 110 cm, black colour*

Larghezza 14 mm | *Width 14 mm*

Vespa PX 125-150-200 • Vespa PXE Arcobaleno

R.O. 196230, 196232, C-4727150, C-4727151 (LML)



**142640140**



PROFILO PEDANA IN GOMMA | *RUBBER PROFILE FOR FOOTBOARD STRIPS*

Lunghezza 270 cm, nero | *Length 270 cm, black colour*

Larghezza 9 mm | *Width 9 mm*

Vespa 50-90 • Vespa 125 Primavera • Vespa ET3

R.O. 154777, 097237





**PROFILI CARROZZERIA - CHASSIS BEADINGS**

**142640150**



PROFILO PEDANA IN GOMMA | *RUBBER*  
 PROFILE FOR FOOTBOARD STRIPS

Lunghezza 340 cm, nero | *Length 340 cm,*  
*black colour*

Larghezza 14 mm | *Width 14 mm*

Vespa 150 Sprint • Vespa GL • Vespa Sprint  
 Veloce • Vespa Super • Vespa 180-200 Rally

R.O. 94625



**142640160**



PROFILO PEDANA IN GOMMA | *RUBBER*  
 PROFILE FOR FOOTBOARD STRIPS

Lunghezza 380 cm, nero | *Length 380 cm,*  
*black colour*

Larghezza 14 mm | *Width 14 mm*

Liscio | *Smooth*

Vespa PX 125-150-200 • Vespa PXE • Vespa PK  
 R.O. 154778, 159829



**142640170**



PROFILO COFANO | *SIDEPANEL RUBBER*  
*SCRIPT*

Lunghezza 300 cm, grigio | *Length 300 cm,*  
*silver colour*

Larghezza 10 mm | *Width 10 mm*

Vespa 125 ('51-'66) • Vespa 150 ('55-'66) •

Vespa 150 GS

R.O. 011751



**142640280** **NEW**



GUARNIZIONE IN GOMMA PER COFANI  
LATERALI | RUBBER SEAL FOR SIDE PANELS

Dimensioni 3000x16mm | Dimensions

3000x16mm

Grigio | Grey

Vespa 125 Super/GT/GTR • Vespa 150 GL •  
Vespa Super • Vespa Sprint/V • Vespa 160 GS •  
Vespa 180 SS

Adatto per - Suitable for Vespa 125 TS • Vespa  
Rally



**142640130**



PROFILO SCUDO IN ALLUMINIO | ALUMINIUM  
LEGSHIELD FRAME PROFILE

Tipo originale | Original type

Vespa 50-90 • Vespa 125 Primavera • Vespa  
125 Primavera ET3

R.O. 070416, 150179



**142640230** **NEW**



PROFILO SCUDO IN ALLUMINIO | ALUMINIUM  
LEGSHIELD FRAME PROFILE

Vespa 125-150 VBB-VBA-VNB 4-5-6

R.O. 084930



**142640240** **NEW**



PROFILO SCUDO IN PLASTICA | PLASTIC  
LEGSHIELD FRAME PROFILE

Argento | Silver

Vespa PK50-125 • Vespa PK 50 S/SS

R.O.192086



**PROFILI CARROZZERIA - CHASSIS BEADINGS**

**142640250** **NEW**



PROFILO SCUDO IN ALLUMINIO | *ALUMINIUM*  
 LEGSHIELD FRAME PROFILE

Argento | *Silver*

Vespa GL 150

R.O.070687



**142640260** **NEW**



PROFILO SCUDO IN ALLUMINIO | *ALUMINIUM*  
 LEGSHIELD FRAME PROFILE

Argento | *Silver*

Vespa 125 GT/GTR/TS • Vespa Super 125-150 •

Vespa 150 Sprint/V

R.O. 072271



**142640270** **NEW**



PROFILO SCUDO IN ALLUMINIO | *ALUMINIUM*  
 LEGSHIELD FRAME PROFILE

Vespa 50-90 V5SS

R.O. 101215



## STRISCE PEDANA - FLOOR RUNNER KIT

142660230



Vespa 50-90-125 Primavera • Vespa ET3  
 V5A1-V5B1-V5B2-V5SA1-V9A1-VMA2-VMB1-  
 VMX1T  
 R.O. 610232M



142660240



Vespa PX 125-150-200  
 VNX-VLX-VSX  
 R.O. 610231M



STRISCE PEDANA - FLOOR RUNNER KIT

142660350 **NEW**



Vespa 125 V1-V15 • Vespa Hoffmann A/B ('49-'50)



142660360 **NEW**



Vespa 125 V30-V33 ('51-'52)



## STRISCE PEDANA - FLOOR RUNNER KIT

142660370 **NEW**



Vespa 125 VM1-VM2 ('53-'54)



142660380 **NEW**



Vespa 125 VM1-VM2 ('54-'57)



STRISCE PEDANA - FLOOR RUNNER KIT

142660390 NEW



Vespa 125 VN1-VN2, VL1-2 ('54-'56)



142660400 NEW



Vespa 150 VL3 ('56>)



## STRISCE PEDANA - FLOOR RUNNER KIT

142660410 **NEW**



Vespa 150 VB1 ('58)



142660420 **NEW**



Vespa 150 GS VS1 ('55-'56)





STRISCE PEDANA - FLOOR RUNNER KIT

142660430 **NEW**



Vespa 150 GS VS2-3-4-5 ('56>)



142660440 **NEW**



Vespa 160 GS VSB1 ('62>)



## STRISCE PEDANA - FLOOR RUNNER KIT

142660450 **NEW**



Vespa 150 VBA-VBB ('59>)



142660460 **NEW**



Vespa 125 VNA1/2 ('57-'58)



STRISCE PEDANA - FLOOR RUNNER KIT

142660470 **NEW**



Vespa 125 VNB1/2 ('59-'61)



142660480 **NEW**



Vespa 125 VNB3/6 ('62->)



## STRISCE PEDANA - FLOOR RUNNER KIT

142660490 **NEW**



Vespa 125-150 VNC/VBC ('63>)



142660500 **NEW**



Vespa 150 GL VLA ('63>)



**STRISCE PEDANA - FLOOR RUNNER KIT**

**142660290**



Vespa 150 GL • Vespa 150 Sprint • Vespa 150 Sprint Veloce •  
Vespa 180-200 Rally  
VLA-VLB-VLB1T-VNL2T-VSD1T-VSE1T



**TAPPETINI IN GOMMA - FLOOR MATS**

**142670010**



TAPPETINO CENTRALE IN GOMMA | *CENTRAL RUBBER MAT*

Vespa 150 ('59>) • Vespa 125 ('62>) • Vespa GS ('62-'64) • Vespa Sprint • Vespa Super • Vespa GTR • Vespa Rally  
R.O. 085072, 610009M



## TAPPETINI IN GOMMA - FLOOR MATS

**142670020**



TAPPETINO CENTRALE IN GOMMA | *CENTRAL RUBBER MAT*

Vespa PX 1° serie  
R.O. 180052, 219109



**142670030**



TAPPETINO CENTRALE IN GOMMA | *CENTRAL RUBBER MAT*

Vespa 125 Primavera • Vespa Primavera ET3  
R.O. 100445



**142670040**



TAPPETINO IN GOMMA | *RUBBER MAT*

Vespa 50  
R.O. 610303M



TAPPETINI IN GOMMA - FLOOR MATS

**142670050**



TAPPETINO IN GOMMA | *RUBBER MAT*  
 Vespa 90-125 • Vespa Primavera • Vespa  
 Primavera ET3  
 R.O. 610303M



**142670060**



TAPPETINO IN GOMMA | *RUBBER MAT*  
 Vespa PX PE• Vespa PX PE Arcobaleno  
 R.O. 437941



**142670070**



TAPPETINO IN GOMMA | *RUBBER MAT*  
 Vespa PK 50 • Vespa PK 125  
 Veicoli con listelli pedana - *Models with floor  
 runner kit*



## TAPPETINI IN GOMMA - FLOOR MATS

**142670080**



TAPPETINO IN GOMMA | RUBBER MAT

Vespa PK 50XL • Vespa PK 125XL

Veicoli senza listelli pedana - *Models without floor runner kit*



**142670090**



TAPPETINO IN GOMMA | RUBBER MAT

Vespa GL • Vespa Sprint

Adattabile VNB-VBB per tutte le annate '60 - '70

| *Suitable for VNB-VBB ('60-'70)*

R.O. 610304M



**142670120**



TAPPETINO IN GOMMA | RUBBER MAT

Grigio | Grey

Vespa GL • Vespa Sprint

Adattabile VNB-VBB per tutte le annate '60 - '70

| *Suitable for VNB-VBB ('60-'70)*

R.O. 610304M





TAPPETINI IN GOMMA - FLOOR MATS

142670130



TAPPETINO CENTRALE IN PLASTICA | *CENTRAL PLASTIC MAT*

Vespa 125 T5

R.O. 226093, 6732010090



142670150



COPPIA TAPPETINI | *RUBBER MAT PAIR*

Grigio | *Grey*

Vespa PK 50-125XL • Vespa 50 FL2 Automatica

• Vespa Plurimatic • Vespa Rush

R.O. 498463



142680300



TAPPETINO CENTRALE IN PLASTICA | *CENTRAL PLASTIC MAT*

Vespa PK 50-125 • Vespa PK 50-125XL • Vespa 50 Rush

R.O. 214512



142720040



SCUDETTO ANTERIORE | *FRONT SHIELD*

Esagono 26 mm | *Hexagon 26 mm*

Materiale Alluminio | *Material Aluminium*

Colore Blu | *Colour Blue*

Adesivo | *Sticker*

Confezione 5 Pz. | *5 Pcs Packing*

Vespa 50-90-125 • Vespa Primavera ET3 •

Vespa 125 GT/GTR • Vespa Sprint Veloce •

Vespa Rally 180-200

R.O. 152280



142720100



SCUDETTO ANTERIORE | *FRONT SHIELD*

Esagono 31 mm | *Hexagon 31 mm*

Materiale Alluminio | *Material Aluminium*

Colore Blu | *Colour Blue*

Adesivo | *Sticker*

Confezione 5 Pz. | *5 Pcs Packing*

Vespa PX 125-150-200 1° serie ('78 - '83) •

Vespa PK 50 • Vespa 125 S

R.O. 149876



142720110



SCUDETTO ANTERIORE | *FRONT SHIELD*

Esagono 42 mm | *Hexagon 42 mm*

Materiale Alluminio | *Material Aluminium*

Colore Blu | *Colour Blue*

Adesivo | *Sticker*

Confezione 5 Pz. | *5 Pcs Packing*

Vespa GL 150 ('63-'64) • Vespa Sprint 150 ('65-

'74) • Vespa Sprint Veloce 150 ('69-'79) • Vespa

Rally 180 ('68-'73) • Vespa Rally 200 ('72-'79)

R.O. 152290



TARGHETTE - SCUDI - FREGI - NAMEPLATES - BADGES - EMBLEMS

142720430



SCUDETTO ANTERIORE | *FRONT SHIELD*  
 Scudetto rettangolare 37x47 mm | *Rectangular shield 37x47 mm*  
 Materiale Alluminio | *Material Aluminium*  
 Colore Blu scuro | *Colour Dark blue*  
 Adesivo | *Sticker*  
 Confezione 5 Pz. | *5 Pcs Packing*  
 Vespa 125 GT • Vespa Sprint • Vespa Super ('67)  
 • Vespa 150 VBA-VBB-GL-GS VS5 • Vespa Sprint/  
 Super (>'67) • Vespa 160 GS • Vespa 180 SS  
 R.O. 080349



142720080



SCUDETTO RESINATO ADESIVO PIAGGIO  
 PER CALANDRA STERZO | *STEERING COVER*  
*PIAGGIO ADHESIVE RESINED SHIELD*  
 Esagono 27 mm | *Hexagon 27 mm*  
 Confezione 5 Pz. | *5 Pcs Packing*  
 R.O. 295596



142720020



SCUDETTO RESINATO ADESIVO PIAGGIO  
 PER CALANDRA STERZO | *STEERING COVER*  
*PIAGGIO ADHESIVE RESINED SHIELD*  
 Dimensioni 32x37mm | *Dimensions 32x37mm*  
 Materiale Resinato | *Material Resin-coated*  
 Colore Blu | *Colour Blue*  
 Fissaggio: da inserire | *Fixing: to plug*  
 Confezione 5 Pz. | *5 Pcs Packing*  
 Vespa PK 50-125 XL/XL2 • Vespa PX 80-200E •  
 Vespa Lusso • Vespa ('98) • Vespa T5  
 R.O. 295486



142720050



SCUDETTO RESINATO PER SCUDO ANTERIORE  
 | *PIAGGIO RESINED FRONT SHIELD*  
 Esagono 32 mm | *Hexagon 32 mm*  
 Materiale Resinato | *Material Resin-coated*  
 R.O. 574771



## TARGHETTE - SCUDI - FREGI - NAMEPLATES - BADGES - EMBLEMS

142720500



SCUDETTO ANTERIORE | *FRONT SHIELD*  
 Dimensioni 37x46 mm | *Dimensions 37x46 mm*  
 Materiale Plastica | *Material Plastic*  
 Colore Blu chiaro | *Colour Light blue*  
 Fissaggio: da inserire | *Fixing: to plug*  
 Vespa PX 125-200 MY • Vespa (\*11)  
 R.O. 576464



142720890 **NEW**



TARGHETTA VESPA CROMATA | *CHROMED*  
 VESPA NAMEPLATE



142721280 **NEW**



TARGHETTA POSTERIORE PER SELLA | *REAR*  
 NAMEPLATE SADDLE  
 Vespa PX 125-150-200 • Vespa PX 125-150-200  
 Arcobaleno



142721290 **NEW**



ETICHETTA PER TARGHETTA SELLA | *LABEL*  
 FOR SEAT PLATE  
 Vespa PX 125-150-200 • Vespa PX 125-150-200  
 Arcobaleno



142721400 **NEW**



TARGHETTA AUTOMATICA | *AUTOMATICA*  
 NAMEPLATE  
 Materiale Alluminio | *Material Aluminium*  
 Vespa automatica



TARGHETTE - SCUDI - FREGI - NAMEPLATES - BADGES - EMBLEMS

142721450 **NEW**



EMBLEMA PIAGGIO ADESIVO | PIAGGIO LOGO  
STICKER

Dimensioni 37x46 mm | *Dimensions 37x46 mm*  
Vespa vari modelli | *Vespa various models*



142721500 **NEW**



TARGHETTA PIAGGIO PICCOLA | SMALL  
PIAGGIO NAMEPLATE

Materiale Alluminio | *Material Aluminium*  
Vespa PK

**PIAGGIO**

142721550 **NEW**



SCUDETTO ANTERIORE PIAGGIO GENOVA CON  
ALETTE | PIAGGIO GENOVA FRONT SHIELD  
WITH FLAPS

Dimensioni 36x47 mm | *Dimensions 36x47 mm*  
Colore Blu acqua, smaltato | *Colour Water blue,  
varnished*  
Fissaggio 4 alette | *Fixing 4 flaps*  
Vespa 98-125 V1/V15/V30/V33 ('47-'52)



142721560 **NEW**



SCUDETTO ANTERIORE PIAGGIO GENOVA CON  
ALETTE | PIAGGIO GENOVA FRONT SHIELD  
WITH FLAPS

Dimensioni 36x47 mm | *Dimensions 36x47 mm*  
Colore Blu acqua, smaltato | *Colour Water blue,  
varnished*  
Fissaggio 4 alette | *Fixing 4 flaps*  
Vespa 125 VM1/2 ('53-'54)



142721570 **NEW**



SCUDETTO ANTERIORE PIAGGIO GENOVA CON  
ALETTE | *PIAGGIO GENOVA FRONT SHIELD  
WITH FLAPS*

Dimensioni 36x47 mm | *Dimensions 36x47 mm*  
Colore Blu acqua, smaltato | *Colour Water blue,  
varnished*

Fissaggio 4 alette | *Fixing 4 flaps*

Vespa VN1/2 ('55-'57)



142721580 **NEW**



SCUDETTO ANTERIORE PIAGGIO CON ALETTE |  
*PIAGGIO GENOVA FRONT SHIELD WITH FLAPS*

Dimensioni 36x47 mm | *Dimensions 36x47 mm*  
Colore Blu acqua, smaltato | *Colour Water blue,  
varnished*

Fissaggio 4 alette | *Fixing 4 flaps*

Vespa GS 150 VB1 VL3 ('57-'61)



142721590 **NEW**



SCUDETTO ANTERIORE ACMA CON ALETTE |  
*ACMA FRONT SHIELD*

Dimensioni 37x47 mm | *Dimensions 37x47 mm*  
Materiale Alluminio | *Material Aluminium*

Colore Blu scuro | *Colour Dark blue*

Fissaggio 4 alette | *Fixing 4 flaps*

Scritta in rilievo | *Engraved badge*

Vespa ACMA 125-150 ('54-'56) • Vespa 150 GL  
( '56)

R.O. H13605



## TARGHETTE - SCUDI - FREGI - NAMEPLATES - BADGES - EMBLEMS

142720220



TARGHETTA SCUDO ANTERIORE | FRONT  
SHIELD NAMEPLATE

Dimensioni 35x15mm | Dimensions 35x15mm

Cromata | Chromed

Fissaggio 2 perni | Fixing 2 pins

Interasse perni 15mm | Pin distance 15 mm

Vespa 50 Special V5A2-V5A3-V5B1T (fino a telaio n.38639 - till chassis n.38639) - V5B2T (fino a telaio n.1868 - till chassis n.1868 )

R.O. 610288M



142720240



TARGHETTA SCUDO ANTERIORE | FRONT  
SHIELD NAMEPLATE

Dimensioni 135x35 mm | Dimensions 135x35 mm

Cromata | Chromed

Fissaggio 3 perni | Fixing 3 pins

Vespa 50 L • Vespa 50 R ('70-'75)

R.O. 151727



142720250



TARGHETTA SCUDO ANTERIORE | FRONT  
SHIELD NAMEPLATE

Dimensioni 135x35 mm | Dimensions 135x35 mm

Cromata | Chromed

Fissaggio 3 perni | Fixing 3 pins

Vespa 125 Primavera ('68-'74) • Vespa 125 Nuova ('65-'66)

R.O. 73488



142720290



TARGHETTA SCUDO ANTERIORE | *FRONT*  
SHIELD NAMEPLATE

Dimensioni 120x35 mm | *Dimensions 120x35*  
*mm*

Materiale Alluminio anodizzato | *Material*  
*Anodized aluminium*

Fissaggio 2 perni | *Fixing 2 pins*

Interasse perni 107 mm | *Pin distance 107 mm*

Vespa 50 Revival • Vespa Sprint 150 VLB1  
(‘67-‘69) • Vespa Sprint Veloce • Vespa Super •  
Vespa 180 Rally

R.O. 141345



142720330



TARGHETTA SCUDO ANTERIORE | *FRONT*  
SHIELD NAMEPLATE

Dimensioni 150x45 mm | *Dimensions 150x45*  
*mm*

Cromata | *Chromed*

Fissaggio 3 perni | *Fixing 3 pins*

Vespa 125 GT (e) • Vespa 150 Sprint VLB1T (dal  
telaio n.050001 al n.051523 - *from chassis*  
*n.050001 to n.051523*)

R.O. 90556



142720310



TARGHETTA SCUDO ANTERIORE | *FRONT*  
SHIELD NAMEPLATE

Dimensioni 160x45 mm | *Dimensions 160x45*  
*mm*

Cromata | *Chromed*

Fissaggio 3 perni | *Fixing 3 pins*

Interasse perni 145 mm | *Pin distance 145 mm*

Vespa Gran Turismo

R.O. 151713





TARGHETTE - SCUDI - FREGI - NAMEPLATES - BADGES - EMBLEMS

142720340



TARGHETTA SCUDO ANTERIORE | FRONT  
SHIELD NAMEPLATE

Fissaggio 3 perni | Fixing 3 pins

Interasse perni 175 mm | Pin distance 175 mm

Vespa 180 SS

R.O. 90496



142720160



TARGHETTA SCUDO ANTERIORE | FRONT  
SHIELD NAMEPLATE

Dimensioni 84x29 mm | Dimensions 84x29 mm

Materiale Plastica | Material Plastic

Cromata | Chromed

Fissaggio 2 perni | Fixing 2 pins

Interasse perni 45 mm | Pin distance 45 mm

Vespa 50 ET2 (97-'05) • Vespa 50 ET4 • Vespa  
PX 125-150-200 ('98-'16)

R.O. 577082



142720400



TARGHETTA SCUDO ANTERIORE | FRONT  
SHIELD NAMEPLATE

Dimensioni 75x30 mm | Dimensions 75x30 mm

Cromata | Chromed

Fissaggio 2 perni | Fixing 2 pins

Interasse perni 55 mm | Pin distance 55 mm

Vespa Super 125-150

R.O. 121080



142720380



TARGHETTA SCUDO ANTERIORE | FRONT  
SHIELD NAMEPLATE

Dimensioni 80x24 mm | Dimensions 80x24 mm

Cromata | Chromed

Fissaggio 2 perni | Fixing 2 pins

Interasse perni 65 mm | Pin distance 65 mm

Vespa Sprint 150 VLB1 ('67-'69) • Vespa Sprint  
Veloce

R.O. 20483



142720170



TARGHETTA SCUDO ANTERIORE | *FRONT*  
SHIELD NAMEPLATE

Dimensioni 120x20 mm | *Dimensions 120x20*  
*mm*

Colore Nero/Alluminio | *Colour Black/Aluminium*

Fissaggio 2 perni | *Fixing 2 pins*

Interasse perni 80 mm | *Pin distance 80 mm*

Vespa 50 Special • Vespa 90 • Vespa 125  
Primavera • Vespa ET3 • Vespa PX 125-150-200  
• Vespa GTR • Vespa Sprint Veloce  
R.O. 152541

142720180



TARGHETTA SCUDO ANTERIORE | *FRONT*  
SHIELD NAMEPLATE

Dimensioni 120x18 mm | *Dimensions 120x18*  
*mm*

Colore Nero/Alluminio | *Colour Black/Aluminium*

Fissaggio 2 perni | *Fixing 2 pins*

Interasse perni 59 mm | *Pin distance 59 mm*

Vespa PX-PX 125-150-200 Arcobaleno  
R.O. 197601, 241012

142720520



TARGHETTA SCUDO ANTERIORE | *FRONT*  
SHIELD NAMEPLATE

Cromo | *Chromed*

Fissaggio 2 perni | *Fixing 2 pins*

Interasse perni 19 mm | *Pin distance 19 mm*

Vespa Gran Turismo  
R.O. 151716, 122314



142720640



TARGHETTA SCUDO ANTERIORE | *FRONT*  
SHIELD NAMEPLATE

Interasse perni 55 mm | *Pin distance 55 mm*

Vespa PK 50-125 • Vespa PK 50-125XL  
R.O. 195629

TARGHETTE - SCUDI - FREGI - NAMEPLATES - BADGES - EMBLEMS

142720850



TARGHETTA SCUDO ANTERIORE | FRONT  
SHIELD NAMEPLATE

Dimensioni 165x46 mm | Dimensions 165x46  
mm

Colore Nero | Colour Black  
Fissaggio 9 rivetti | Fixing 9 rivets  
Vespa 160 GS VSB1 ('62-'64)  
R.O. 057182



142720870



TARGHETTA SCUDO ANTERIORE | FRONT  
SHIELD NAMEPLATE

Dimensioni 165x45 mm | Dimensions 165x45  
mm

Colore Nero | Colour Black  
Fissaggio 9 rivetti | Fixing 9 rivets  
Vespa GL VLA1T  
R.O. 94793



142720900



TARGHETTA SCUDO ANTERIORE | FRONT  
SHIELD NAMEPLATE

Dimensioni 101x45 mm | Dimensions 101x45  
mm

Colore Nero | Colour Black  
Fissaggio 6 rivetti | Fixing 6 rivets  
Vespa 125 VNB1-2-3 ('60-'66)  
R.O. 086325



142720920



TARGHETTA SCUDO ANTERIORE | FRONT  
SHIELD NAMEPLATE

Dimensioni 142x60 mm | Dimensions 142x60  
mm

Colore Verde scuro | Colour Dark green  
Fissaggio 6 rivetti | Fixing 6 rivets  
Vespa 125 VN1-2 ('55-'59) • Vespa 125 VNA1-2  
( '55-'59)  
R.O. 023569



142720930



TARGHETTA SCUDO ANTERIORE | *FRONT*  
SHIELD NAMEPLATE

Dimensioni 142x60 mm | *Dimensions 142x60*  
*mm*

Colore Blu | *Colour Blue*

Fissaggio 6 rivetti | *Fixing 6 rivets*

Vespa 125 VN1-2 ('55-'59) • Vespa 125 VNA1-2 ('55-'59)

R.O. 023569



142720810



TARGHETTA SCUDO ANTERIORE | *FRONT*  
SHIELD NAMEPLATE

Dimensioni 135x35 mm | *Dimensions 135x35*  
*mm*

Colore Nero | *Colour Black*

Fissaggio 7 rivetti | *Fixing 7 rivets*

Vespa 50 N V5A1T fino a telaio n.11599 - *till*  
*chassis n.11599*

R.O. 090944, 71275



142720820



TARGHETTA SCUDO ANTERIORE | *FRONT*  
SHIELD NAMEPLATE

Dimensioni 140x50 mm | *Dimensions 140x50*  
*mm*

Colore Cromata | *Colour Chromed*

Fissaggio 7 rivetti | *Fixing 7 rivets*

Vespa 150 VBA-VBB

R.O. 084809



TARGHETTE - SCUDI - FREGI - NAMEPLATES - BADGES - EMBLEMS

142720830



TARGHETTA SCUDO ANTERIORE | FRONT  
SHIELD NAMEPLATE

Dimensioni 140x45 mm | Dimensions 140x45  
mm

Colore Argento | Colour Silver

Fissaggio 9 rivetti | Fixing 9 rivets

Vespa 150 GS VS1-2-3-4 ('55-'61)

R.O. 023902, 57182



142720840



TARGHETTA SCUDO ANTERIORE | FRONT  
SHIELD NAMEPLATE

Dimensioni 140x45 mm | Dimensions 140x45  
mm

Colore Nero | Colour Black

Fissaggio 9 rivetti | Fixing 9 rivets

Vespa 150 GS VS1-2-3-4 ('55-'61)

R.O. 023902, 57182



142720910



TARGHETTA SCUDO ANTERIORE | FRONT  
SHIELD NAMEPLATE

Dimensioni 140x60 mm | Dimensions 140x60  
mm

Colore Alluminio | Colour Aluminium

Fissaggio 6 rivetti | Fixing 6 rivets

Vespa 125 VN1-2 ('55-'59) • Vespa 125 VNA1-2  
( '55-'59)

R.O. 002790



142720980



TARGHETTA SCUDO ANTERIORE | FRONT  
SHIELD NAMEPLATE

Dimensioni 120x18 mm | Dimensions 120x18  
mm

Colore Nero/Alluminio | Colour Black/Aluminium

Fissaggio 2 perni | Fixing 2 pins

Interasse perni 60 mm | Pin distance 60 mm

Vespa PK 50 • Vespa 1° serie senza frecce -  
without blinkers • Vespa PX 125-150-200

R.O. 194955

142721190



TARGHETTA SCUDO ANTERIORE | FRONT  
SHIELD NAMEPLATE

Dimensioni 130x45 mm | Dimensions 130x45  
mm

Colore Argento | Colour Silver

Fissaggio 2 perni diagonali | Fixing 2 diagonal  
pins

Interasse perni 107 mm | Pin distance 107 mm

Vespa 200 Rally ('72-'74)

R.O. 91188, 141345

142721510

NEW



TARGHETTA SCUDO ANTERIORE VESPA | VESPA  
FRONT SHIELD NAMEPLATE

Lunghezza 120 mm | Length 120 mm

Vespa 50 Special 1° serie ('69-'72)

142721520

NEW



TARGHETTA SCUDO ANTERIORE 50 | 50 FRONT  
SHIELD NAMEPLATE

Vespa 50 Special 1° serie ('69-'72)

R.O. 610288M

TARGHETTE - SCUDI - FREGI - NAMEPLATES - BADGES - EMBLEMS

142720440



TARGHETTA CALANDRA ANTERIORE | FRONT  
COVER NAMEPLATE  
Fissaggio con vite | Fixing with screw  
Vespa PX PE 125-150-200 ('78-'83)  
R.O. 181329



142720450



TARGHETTA CALANDRA ANTERIORE | FRONT  
COVER NAMEPLATE  
Fissaggio ad incastro | Snap-fit fixing  
Colore Nero/Argento | Colour Black/Silver  
Vespa PX Arcobaleno • Vespa 125 T5  
R.O. 232895, 198123



142720320



TARGHETTA POSTERIORE | REAR NAMEPLATE  
Dimensioni 160x25 mm | Dimensions 160x25  
mm  
Colore Cromata | Colour Chromed  
Fissaggio 4 perni | Fixing 4 pins  
Vespa 180 Rally  
R.O. 121012



142720350



TARGHETTA POSTERIORE | REAR NAMEPLATE  
Dimensioni 160x27 mm | Dimensions 160x27  
mm  
Colore Cromata | Colour Chromed  
Fissaggio 4 perni | Fixing 4 pins  
Vespa Primavera ('68-'74)  
R.O. 151715



142720270



TARGHETTA POSTERIORE | REAR NAMEPLATE  
Dimensioni 130x20 mm | Dimensions 130x20 mm

Colore Cromata | Colour Chromed  
Fissaggio 4 perni | Fixing 4 pins  
Vespa 150 Sprint VLB ('65-'66')  
R.O. 151905

150 Sprint

142720280



TARGHETTA POSTERIORE | REAR NAMEPLATE  
Colore Cromata | Colour Chromed  
Fissaggio 4 perni | Fixing 4 pins  
Interasse perni 98 mm | Pin distance 98 mm  
Vespa Super  
R.O. 121081

150 Super

142720410



TARGHETTA POSTERIORE | REAR NAMEPLATE  
Dimensioni 170x30 mm | Dimensions 170x30 mm  
Colore Cromata | Colour Chromed  
Fissaggio 4 perni | Fixing 4 pins  
Vespa Gran Turismo  
R.O. 151714

Gran Turismo

142720300



TARGHETTA POSTERIORE | REAR NAMEPLATE  
Dimensioni 170x25 mm | Dimensions 170x25 mm  
Colore Cromata | Colour Chromed  
Fissaggio 4 perni | Fixing 4 pins  
Interasse perni 160 mm | Pin distance 160 mm  
Vespa 150 Sprint VLB ('67-'69) • Vespa Sprint Veloce  
R.O. 90653

Vespa Sprint



TARGHETTE - SCUDI - FREGI - NAMEPLATES - BADGES - EMBLEMS

142720360



TARGHETTA POSTERIORE | REAR NAMEPLATE

Dimensioni 132x27 mm | Dimensions 132x27 mm

Colore Cromata | Colour Chromed

Fissaggio 4 perni | Fixing 4 pins

Vespa 50 Special ('69-'72) • Vespa 50 Revival V5R1T

R.O. 126072



142720370



TARGHETTA POSTERIORE | REAR NAMEPLATE

Colore Cromata | Colour Chromed

Fissaggio 4 perni | Fixing 4 pins

Interasse perni 140 mm | Pin distance 140 mm

Vespa 180 SS ('64)

R.O. 100042



142720260



TARGHETTA POSTERIORE | REAR NAMEPLATE

Dimensioni 115x23 mm | Dimensions 115x23 mm

Colore Cromata | Colour Chromed

Fissaggio 4 perni | Fixing 4 pins

Interasse perni 98 mm | Pin distance 98 mm

Vespa Super

R.O. 150498



142720540



TARGHETTA POSTERIORE | REAR NAMEPLATE

Dimensioni 132x17 mm | Dimensions 132x17 mm

Colore Nero/Alluminio | Colour Black/Aluminium

Fissaggio 2 perni | Fixing 2 pins

Interasse perni 110 mm | Pin distance 110 mm

Vespa 50 S • Vespa 50 Special

R.O. 152510

vespa 50s

142720550



TARGHETTA POSTERIORE | REAR NAMEPLATE  
 Dimensioni 132x17 mm | Dimensions 132x17 mm  
 Colore Nero/Alluminio | Colour Black/Aluminium  
 Fissaggio 2 perni | Fixing 2 pins  
 Interasse perni 110 mm | Pin distance 110 mm  
 Vespa 50 Special ('72-'82)  
 R.O. 152511

**50 special**

142720570



TARGHETTA POSTERIORE | REAR NAMEPLATE  
 Dimensioni 132x17 mm | Dimensions 132x17 mm  
 Colore Nero/Alluminio | Colour Black/Aluminium  
 Fissaggio 2 perni | Fixing 2 pins  
 Interasse perni 110 mm | Pin distance 110 mm  
 Vespa 200 Rally  
 R.O. 152515, 26793

**rally 200**

142720580



TARGHETTA POSTERIORE | REAR NAMEPLATE  
 Dimensioni 85x26 mm | Dimensions 85x26 mm  
 Colore Nero/Rosso | Colour Black/Red  
 Fissaggio 2 perni | Fixing 2 pins  
 Interasse perni 65 mm | Pin distance 65 mm  
 Vespa 125 Primavera ET3 ('76-'82)  
 R.O. 158562

**ET3**

142720530



TARGHETTA POSTERIORE | REAR NAMEPLATE  
 Dimensioni 132x17 mm | Dimensions 132x17 mm  
 Colore Nero/Alluminio | Colour Black/Aluminium  
 Fissaggio 2 perni | Fixing 2 pins  
 Interasse perni 110 mm | Pin distance 110 mm  
 Vespa 50 V5A1T ('70-'74)  
 R.O. 152509

**vespa 50**

## TARGHETTE - SCUDI - FREGI - NAMEPLATES - BADGES - EMBLEMS

142720950



TARGHETTA POSTERIORE | REAR NAMEPLATE  
 Dimensioni 147x17 mm | Dimensions 147x17 mm  
 Colore Nero/Alluminio | Colour Black/Aluminium  
 Fissaggio 2 perni | Fixing 2 pins  
 Interasse perni 110 mm | Pin distance 110 mm  
 Vespa 125 Primavera ET3 ('74-'83)  
 R.O. 145340

125 primavera

142721020



TARGHETTA POSTERIORE | REAR NAMEPLATE  
 Dimensioni 132x17 mm | Dimensions 132x17 mm  
 Colore Nero/Cromata | Colour Black/Chromed  
 Fissaggio 2 perni | Fixing 2 pins  
 Interasse perni 110 mm | Pin distance 110 mm  
 Vespa 125 TS ('75-'77)  
 R.O. 156202

125 t.s.

142720510



TARGHETTA POSTERIORE | REAR NAMEPLATE  
 Dimensioni 132x17 mm | Dimensions 132x17 mm  
 Colore Nero/Alluminio | Colour Black/Aluminium  
 Fissaggio 2 perni | Fixing 2 pins  
 Interasse perni 110 mm | Pin distance 110 mm  
 Vespa 90 ('63-'68)  
 R.O. 150729

vespa 90

142720960



TARGHETTA POSTERIORE | REAR NAMEPLATE  
 Dimensioni 132x17 mm | Dimensions 132x17 mm  
 Colore Nero/Alluminio | Colour Black/Aluminium  
 Fissaggio 2 perni | Fixing 2 pins  
 Interasse perni 110 mm | Pin distance 110 mm  
 Vespa 150 Sprint Veloce ('77-'79)  
 R.O. 145342

150 sprint v.

142720970



TARGHETTA POSTERIORE | REAR NAMEPLATE  
 Dimensioni 132x17 mm | Dimensions 132x17 mm  
 Colore Nero/Alluminio | Colour Black/Aluminium  
 Fissaggio 2 perni | Fixing 2 pins  
 Interasse perni 110 mm | Pin distance 110 mm  
 Vespa 50 Special Elestart V5B4T ('72-'76)  
 R.O. 152512

50 elestart

142721340

NEW



TARGHETTA POSTERIORE | REAR NAMEPLATE  
 Vespa 100 V9B1T  
 R.O. 181953

vespa 100

142721530

NEW



TARGHETTA POSTERIORE VESPA 50 L | VESPA  
 50 L REAR NAMEPLATE  
 Dimensioni 155x35 mm | Dimensions 155x35  
 mm  
 Colore Cromata | Colour Chromed  
 Fissaggio 4 perni | Fixing 4 pins  
 Vespa 50 L  
 R.O. 151712

Vespa 50 L

142720470



ETICHETTA MISCELA 2% | 2% FUEL MIXTURE  
 LABEL  
 Dimensioni 55x10 mm | Dimensions 55x10 mm  
 Confezione 10 Pz. | 10 Pcs Packing  
 Vespa 50-90 • Vespa 125 Primavera • Vespa  
 125 ET3 • Vespa GTR • Vespa GT • Vespa TS  
 • Vespa 150 Sprint Veloce • Vespa Super •  
 Vespa PE PX • Vespa Rally  
 R.O. 610054M003

USARE MISCELA AL 2%

TARGHETTE - SCUDI - FREGI - NAMEPLATES - BADGES - EMBLEMS

142720480



ETICHETTA MISCELA 2% | 2% FUEL MIXTURE LABEL

Dimensioni 60x20 mm | Dimensions 60x20 mm

Confezione 10 Pz. | 10 Pcs Packing

Vespa PX PE 125-150- 200 • Vespa 125

VNB1T>6T • Vespa 150 VBA1T • Vespa

VBB1T>2T • Vespa GL

R.O. 610054M00R, 610084M00R



142720490



ETICHETTA MISCELA 5% | 5% FUEL MIXTURE LABEL

Dimensioni 60x20 mm | Dimensions 60x20 mm

Confezione 10 Pz. | 10 Pcs Packing

Vespa V30>33T • Vespa VM1>2T • Vespa U •

Vespa VNA1>2T • Vespa 150 VL1>3T • Vespa

VB1T • Vespa 160 GS • Vespa 180 SS VSC1T

R.O. 61 0054M001



142721030



ETICHETTA RODAGGIO ROSSA | RUNNING RED LABEL

Dimensioni 135x130 mm | Dimensions 135x130 mm

Vespa GS 150 VS1-5

R.O. 610292M



142721040



ETICHETTA RODAGGIO ROSSA | RUNNING RED LABEL

Dimensioni 127x115 mm | Dimensions 127x115 mm

Confezione 10 Pz. | 10 Pcs Packing

Vespa VNB5T>6T • Vespa Super VNC1T • Vespa

VNL2T • Vespa GTR VNL2T • Vespa VBB1T>2T •

Vespa VLA1T • Vespa VBC1T • Vespa VLB1T

R.O. 610170M



142721050



ETICHETTA RODAGGIO ROSSA | *RUNNING RED LABEL*

Dimensioni 127x115 mm | *Dimensions 127x115 mm*

Vespa 50-V5A1T N • Vespa L • Vespa R SS •  
Vespa Special V5A2>3T V5B1>4T-V5B3T •  
Vespa V90 • Vespa V90SS  
R.O. 610170M002



142721060



ETICHETTA RODAGGIO BLU | *RUNNING BLUE LABEL*

Dimensioni 127x115 mm | *Dimensions 127x115 mm*

Confezione 10 Pz. | *10 Pcs Packing*

Vespa Rally 180-200-VNL3T> • Vespa Rally  
VSD1T VSE1T  
R.O. 610170M001



142721070



ETICHETTA RODAGGIO BLU | *RUNNING BLUE LABEL*

Dimensioni 127x115 mm | *Dimensions 127x115 mm*

Confezione 10 Pz. | *10 Pcs Packing*

Vespa 50-V5A1T N • Vespa L • Vespa R SS •  
Vespa Special V5A2>3T V5B1>4T-V5B3T • Vespa  
V90 • Vespa V90SS  
R.O. 610170M003



142721080



ETICHETTA BENZINA | *FUEL LABEL*

Dimensioni 60x20 mm | *Dimensions 60x20 mm*

Vespa PX ('85-'15) con miscelatore - *with oil pump*



TARGHETTE - SCUDI - FREGI - NAMEPLATES - BADGES - EMBLEMS

142721230



TARGHETTA NON OSTRUIRE IL FORO ROSSA |  
*RED LABEL*  
 Dimensioni 50x40 mm | *Dimensions 50x40 mm*  
 Confezione 4 Pz. | *4 Pcs Packing*  
 Vespa tutti i modelli large frame | *Vespa large*  
*frame models*  
 R.O. 610176M



142721240



TARGHETTA NON OSTRUIRE IL FORO BLU |  
*BLU LABEL*  
 Dimensioni 50x40 mm | *Dimensions 50x40 mm*  
 Confezione 4 Pz. | *4 Pcs Packing*  
 Vespa tutti i modelli large frame | *Vespa large*  
*frame models*  
 R.O. 610176M0001



142720150



TARGHETTA COFANO LATERALE | *SIDE PANEL*  
*NAMEPLATE*  
 Dimensioni 177x60 mm | *Dimensions 177x60*  
*mm*  
 Colore Alluminio opaco | *Colour Matt aluminium*  
 Fissaggio 2 perni | *Fixing 2 pins*  
 Interasse perni 137 mm | *Pin distance 137 mm*  
 Vespa PX 125-150-200 freno a disco ('01-'08) -  
*with brake disc*  
 R.O. 577081



142720190



TARGHETTA COFANO LATERALE | *SIDE PANEL*  
*NAMEPLATE*  
 Colore Argento | *Colour Silver*  
 Fissaggio Adesivo | *Fixing Sticker*  
 Vespa PX 125 freno a disco ('98-'07) - *with*  
*brake disc*  
 R.O. 575795



142720200



TARGHETTA COFANO LATERALE | *SIDE PANEL  
NAMEPLATE*

Dimensioni 177x60 mm | *Dimensions 177x60  
mm*

Colore Alluminio opaco | *Colour Matt aluminium*

Fissaggio 2 perni | *Fixing 2 pins*

Interasse perni 137 mm | *Pin distance 137 mm*

Vespa PX 150 freno a disco ('98-'07) - *with  
brake disc*

R.O. 577081

PX150

142720460



TARGHETTA COFANO LATERALE | *SIDE PANEL  
NAMEPLATE*

Dimensioni 150x50 mm | *Dimensions 150x50  
mm*

Colore Cromata | *Colour Chromed*

Fissaggio Adesivo | *Fixing Sticker*

Vespa PX 125-150 ('11-'17) • Vespa GTS - LX  
( '09-'12)

R.O. 656220, 620529

Vespa

142720600



TARGHETTA COFANO LATERALE | *SIDE PANEL  
NAMEPLATE*

Colore Nero/Alluminio | *Colour Black/Aluminium*

Fissaggio 2 perni | *Fixing 2 pins*

Interasse perni 105 mm | *Pin distance 105 mm*

Vespa P 200X ('78-'81)

R.O. 181328

P200E



TARGHETTE - SCUDI - FREGI - NAMEPLATES - BADGES - EMBLEMS

142720610



TARGHETTA COFANO LATERALE | *SIDE PANEL NAMEPLATE*

Dimensioni 145x20 mm | *Dimensions 145x20 mm*

Colore Nero/Alluminio | *Colour Black/Aluminium*

Fissaggio 2 perni | *Fixing 2 pins*

Interasse perni 105 mm | *Pin distance 105 mm*

Vespa P 150X ('78-'81)

R.O. 182117



142720620



TARGHETTA COFANO LATERALE | *SIDE PANEL NAMEPLATE*

Dimensioni 158x20 mm | *Dimensions 158x20 mm*

Colore Nero/Alluminio | *Colour Black/Aluminium*

Fissaggio 2 perni | *Fixing 2 pins*

Interasse perni 105 mm | *Pin distance 105 mm*

Vespa PX 125E ('83)

R.O. 194717



142720630



TARGHETTA COFANO LATERALE | *SIDE PANEL NAMEPLATE*

Dimensioni 158x20 mm | *Dimensions 158x20 mm*

Colore Nero/Alluminio | *Colour Black/Aluminium*

Fissaggio 2 perni | *Fixing 2 pins*

Interasse perni 105 mm | *Pin distance 105 mm*

Vespa PX 150E ('83)

R.O. 194718



142720680



TARGHETTA COFANO LATERALE | *SIDE PANEL*  
NAMEPLATE

Dimensioni 162x20 mm | *Dimensions 162x20*  
*mm*

Colore Nero/Alluminio | *Colour Black/Aluminium*

Fissaggio 2 perni | *Fixing 2 pins*

Interasse perni 105 mm | *Pin distance 105 mm*

Vespa PX 200 E ('83)

R.O. 195641

PX 200 E

142720690



TARGHETTA COFANO LATERALE | *SIDE PANEL*  
NAMEPLATE

Dimensioni 95x15 mm | *Dimensions 95x15 mm*

Fissaggio 2 perni | *Fixing 2 pins*

Interasse perni 71 mm | *Pin distance 71 mm*

Vespa 50 Elestart V5B2T

R.O. 196459

elestart

142720700



TARGHETTA COFANO LATERALE | *SIDE PANEL*  
NAMEPLATE

Dimensioni 135x33 mm | *Dimensions 135x33*  
*mm*

*mm*

Colore Nero/Alluminio | *Colour Black/Aluminium*

Fissaggio 2 perni | *Fixing 2 pins*

Interasse perni 105 mm | *Pin distance 105 mm*

Vespa PX 125 E Arcobaleno Elestart VNX2

('81-'97)

R.O. 198179

PX 125 E  
elestart

TARGHETTE - SCUDI - FREGI - NAMEPLATES - BADGES - EMBLEMS

142720710



TARGHETTA COFANO LATERALE | *SIDE PANEL  
NAMEPLATE*

Dimensioni 135x33 mm | *Dimensions 135x33  
mm*

Colore Nero/Alluminio | *Colour Black/Aluminium*

Fissaggio 2 perni | *Fixing 2 pins*

Interasse perni 105 mm | *Pin distance 105 mm*

Vespa PX 125E Arcobaleno ('83>)

R.O. 1198181, 226736



142720720



TARGHETTA COFANO LATERALE | *SIDE PANEL  
NAMEPLATE*

Dimensioni 140x32 mm | *Dimensions 140x32  
mm*

Colore Nero/Alluminio | *Colour Black/Aluminium*

Fissaggio 2 perni | *Fixing 2 pins*

Interasse perni 105 mm | *Pin distance 105 mm*

Vespa PX 150E Arcobaleno ('83>)

R.O. 198182, 1198182



142720730



TARGHETTA COFANO LATERALE | *SIDE PANEL  
NAMEPLATE*

Dimensioni 145x32 mm | *Dimensions 145x32  
mm*

Colore Nero/Alluminio | *Colour Black/Aluminium*

Fissaggio 2 perni | *Fixing 2 pins*

Interasse perni 105 mm | *Pin distance 105 mm*

Vespa PX 200E Arcobaleno ('83>)

R.O. 226735



142720740



TARGHETTA COFANO LATERALE | *SIDE PANEL*  
NAMEPLATE

Dimensioni 100x45 mm | *Dimensions 100x45*  
*mm*

Colore Nero/Alluminio | *Colour Black/Aluminium*

Fissaggio 2 perni | *Fixing 2 pins*

Interasse perni 80 mm | *Pin distance 80 mm*

In plastica | *Plastic made*

Vespa 125 T5 ('85-'89)

R.O. 241316



142720750



TARGHETTA COFANO LATERALE | *SIDE PANEL*  
NAMEPLATE

Dimensioni 170x46 mm | *Dimensions 170x46*  
*mm*

Fissaggio 2 perni | *Fixing 2 pins*

Interasse perni 103 mm | *Pin distance 103 mm*

Cosa 125-150-200 ('81-'97)

R.O. 258152



142720760



TARGHETTA COFANO LATERALE | *SIDE PANEL*  
NAMEPLATE

Dimensioni 170x21 mm | *Dimensions 170x21 mm*

Colore Nero/Alluminio | *Colour Black/Aluminium*

Fissaggio 3 perni | *Fixing 3 pins*

Vespa 50 N ('89-'90)

R.O. 256452



TARGHETTE - SCUDI - FREGI - NAMEPLATES - BADGES - EMBLEMS

142720780



TARGHETTA COFANO LATERALE | *SIDE PANEL  
NAMEPLATE*

Dimensioni 130x33 mm | *Dimensions 130x33  
mm*

Colore Nero/Alluminio | *Colour Black/Aluminium*

Fissaggio 2 perni | *Fixing 2 pins*

Interasse perni 105 mm | *Pin distance 105 mm*

Vespa PX 80E Arcobaleno ('83>)

R.O. 198180



142720590



TARGHETTA COFANO LATERALE | *SIDE PANEL  
NAMEPLATE*

Dimensioni 145x20 mm | *Dimensions 145x20  
mm*

Colore Nero/Alluminio | *Colour Black/Aluminium*

Fissaggio 2 perni | *Fixing 2 pins*

Interasse perni 105 mm | *Pin distance 105 mm*

Vespa P 125X ('78-'81)

R.O. 181327



142720770



TARGHETTA COFANO LATERALE | *SIDE PANEL  
NAMEPLATE*

Dimensioni 138x20 mm | *Dimensions 138x20  
mm*

Colore Nero/Alluminio | *Colour Black/Aluminium*

Fissaggio 2 perni | *Fixing 2 pins*

Interasse perni 105 mm | *Pin distance 105 mm*

Vespa P 150S VBX

R.O. 182895



142720790



TARGHETTA COFANO LATERALE | *SIDE PANEL*  
NAMEPLATE

Dimensioni 135x33 mm | *Dimensions 135x33*  
*mm*

Colore Nero/Alluminio | *Colour Black/Aluminium*

Fissaggio 2 perni | *Fixing 2 pins*

Interasse perni 105 mm | *Pin distance 105 mm*

Vespa PX 150E Arcobaleno Elestart VLX1 ('84-  
'97)

R.O. 198657



142720800



TARGHETTA COFANO LATERALE | *SIDE PANEL*  
NAMEPLATE

Dimensioni 145x32 mm | *Dimensions 145x32*  
*mm*

Colore Nero/Alluminio | *Colour Black/Aluminium*

Fissaggio 2 perni | *Fixing 2 pins*

Interasse perni 105 mm | *Pin distance 105 mm*

Vespa PX 200E Elestart VSX2 ('81-'97)

R.O. 198658



142721150



TARGHETTA COFANO LATERALE | *SIDE PANEL*  
NAMEPLATE

Dimensioni 140x32 mm | *Dimensions 140x32*  
*mm*

Colore Nero/Alluminio/Rosso | *Colour Black/*  
*Aluminium/Red*

Fissaggio 2 perni | *Fixing 2 pins*

Interasse perni 105 mm | *Pin distance 105 mm*

Vespa PX 150E Lusso VLX1T (Mercato tedesco -  
*German market*)

R.O. 199363



## TARGHETTE - SCUDI - FREGI - NAMEPLATES - BADGES - EMBLEMS

142721180

TARGHETTA COFANO LATERALE | SIDE PANEL  
NAMEPLATEDimensioni 140x32 mm | Dimensions 140x32  
mmColore Nero/Alluminio/Rosso | Colour Black/  
Aluminium/Red

Fissaggio 2 perni | Fixing 2 pins

Interasse perni 105 mm | Pin distance 105 mm

Vespa PX 200E Elestart Lusso VSX1T (Mercato  
tedesco - German market)

R.O. 199366



142721110

TARGHETTA COFANO LATERALE | SIDE PANEL  
NAMEPLATEDimensioni 100x35 mm | Dimensions 100x35  
mm

Colore Cromata | Colour Chromed

Fissaggio Adesivo | Fixing Sticker

Vespa PX 125-150 ('11-'17) • Vespa GTS-LX ('09-  
'12)

R.O. 656219



142721130

TARGHETTA COFANO LATERALE | SIDE PANEL  
NAMEPLATEDimensioni 130x33 mm | Dimensions 130x33  
mmColore Nero/Alluminio/Rosso | Colour Black/  
Aluminium/Red

Fissaggio 2 perni | Fixing 2 pins

Interasse perni 105 mm | Pin distance 105 mm

Vespa PX 80E Lusso V8X1T (Mercato tedesco -  
German market)

R.O. 199361



142721170



TARGHETTA COFANO LATERALE | *SIDE PANEL NAMEPLATE*

Dimensioni 130x33 mm | *Dimensions 130x33 mm*

Colore Nero/Alluminio/Rosso | *Colour Black/Aluminium/Red*

Fissaggio 2 perni | *Fixing 2 pins*

Interasse perni 105 mm | *Pin distance 105 mm*

Vespa PX 80E Elestart Lusso V8X1T (Mercato tedesco - *German market*)

R.O. 199365



142721250



TARGHETTA COFANO LATERALE | *SIDE PANEL NAMEPLATE*

Colore Nero/Alluminio | *Colour Black/Aluminium*

Fissaggio 2 perni | *Fixing 2 pins*

Vespa GS (Mercato tedesco - *German market*)

R.O. 226542



142721370

**NEW**



TARGHETTA COFANO LATERALE | *SIDE PANEL NAMEPLATE*

Dimensioni 130x33 mm | *Dimensions 130x33 mm*

Colore Nero/Alluminio/Rosso | *Colour Black/Aluminium/Red*

Fissaggio 2 perni | *Fixing 2 pins*

Interasse perni 105 mm | *Pin distance 105 mm*

Vespa PX 80E Lusso (D)

R.O. 199361



142721270



TARGHETTA LATERALE E BAULETTO | *SIDE AND CARRIER NAMEPLATE*

Dimensioni 90x25 mm | *Dimensions 90x25 mm*

Vespa PK 50XL Rush

R.O. 229276





TARGHETTE - SCUDI - FREGI - NAMEPLATES - BADGES - EMBLEMS

142721430

NEW



TARGHETTA COFANO LATERALE - BAULETTO  
ANTERIORE | *SIDE PANEL NAMEPLATE - FRONT  
CARRIER*

Dimensioni 128x18 mm | *Dimensions 128x18 mm*

Colore Nero/Alluminio/Rosso | *Colour Black/  
Aluminium/Red*

Fissaggio 2 perni | *Fixing 2 pins*

Interasse perni 75 mm | *Pin distance 75 mm*

Vespa PK 50XL ('85-'90)

R.O. 2274688

**PK 50 XL**

142720650



TARGHETTA LATERALE E BAULETTO | *SIDE AND  
CARRIER NAMEPLATE*

Fissaggio 2 perni | *Fixing 2 pins*

Interasse perni 80 mm | *Pin distance 80 mm*

Vespa PK 50 S ('82-'84)

R.O. 195631

**PK 50 S**

142720660



TARGHETTA LATERALE E BAULETTO | *SIDE AND  
CARRIER NAMEPLATE*

Colore Nero/Alluminio | *Colour Black/Aluminium*

Fissaggio 2 perni | *Fixing 2 pins*

Interasse perni 80 mm | *Pin distance 80 mm*

Vespa PK 125 S ('82-'84)

R.O. 195635

**PK 125**

142720670



TARGHETTA LATERALE E BAULETTO | *SIDE AND  
CARRIER NAMEPLATE*

Dimensioni 132x17 mm | *Dimensions 132x17 mm*

Colore Nero/Alluminio | *Colour Black/Aluminium*

Fissaggio 2 perni | *Fixing 2 pins*

Interasse perni 80 mm | *Pin distance 80 mm*

Vespa PK 125 S

R.O. 195635

**PK 125 S**

142720990



TARGHETTA LATERALE E BAULETTO | *SIDE AND CARRIER NAMEPLATE*

Dimensioni 95x17 mm | *Dimensions 95x17 mm*

Colore Nero/Alluminio | *Colour Black/Aluminium*

Fissaggio 2 perni | *Fixing 2 pins*

Interasse perni 80 mm | *Pin distance 80 mm*

Vespa PK 50 ('82-'84) senza frecce - *without blinkers*

R.O. 195630



142721000



TARGHETTA LATERALE E BAULETTO | *SIDE AND CARRIER NAMEPLATE*

Dimensioni 125x32 mm | *Dimensions 125x32 mm*

Colore Nero/Alluminio | *Colour Black/Aluminium*

Fissaggio 2 perni | *Fixing 2 pins*

Interasse perni 80 mm | *Pin distance 80 mm*

Vespa PK 80S Elestart V5X2T

R.O. 198199



142721010



TARGHETTA LATERALE E BAULETTO | *SIDE AND CARRIER NAMEPLATE*

Dimensioni 135x32 mm | *Dimensions 135x32 mm*

Colore Nero/Alluminio | *Colour Black/Aluminium*

Fissaggio 2 perni | *Fixing 2 pins*

Interasse perni 80 mm | *Pin distance 80 mm*

Vespa PK 100S Elestart V9X1T

R.O. 198201



**TARGHETTE - SCUDI - FREGI - NAMEPLATES - BADGES - EMBLEMS**

**121850010**



MOLLETTA FISSAGGIO TARGHETTA | *PLATE FIXING SPRING*  
 Dimensioni 15x8 mm | *Dimensions 15x8 mm*  
 Diametro 3-4 mm | *Diameter 3-4 mm*  
 Confezione 100 Pz. | *100 Pcs Packing*  
 Vespa tutti i modelli | *All models*  
 R.O. 008108



**142721090**



SERIE FREGI | *DECORATIVE TRIMS*  
 Colore Bianco | *Colour White*  
 Vespa Rally 200  
 R.O. 610193M



**142721100**



SERIE FREGI | *DECORATIVE TRIMS*  
 Colore Blu | *Colour Blue*  
 4 pezzi | *4 pieces*  
 Vespa ET3  
 R.O. 610194M



**PORTATARGA - PLATE HOLDERS**

**142700010**



PORTATARGA EUROPEO | *PLATE HOLDER*  
 In nylon antiurto predisposto per il montaggio su tutte le moto e scooter | *Nylon material, suitable for all motorcycle and scooter models*  
 Vespa 125-150-200 tutti i modelli - *all models*

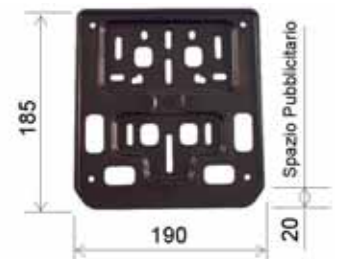

## PORTATARGA - PLATE HOLDERS

142700040



PORTATARGA EUROPEO | *PLATE HOLDER*  
Per Ciclomotori e Scooter 50 cc | *50 cc applications*  
Vespa 50 tutti i modelli - *all models*



142681056 **NEW**



PORTATARGA EUROPEO | *PLATE HOLDER*  
Dimensioni 165x170 mm | *Dimensions 165x170 mm*  
Colore Grigio | *Colour Grey*  
Materiale Metallo | *Material Metal*  
Vespa 90 SS • Vespa 90 • Vespa 100 • Vespa 125 • Vespa Primavera • Vespa ET3  
R.O. 0704106, 70410, 070410



142681057 **NEW**



PORTATARGA ANNI '50 | *PLATE HOLDER 50'S*  
Dimensioni 165x170 mm | *Dimensions 165x170 mm*  
Colore Grigio | *Colour Grey*  
Materiale Metallo | *Material Metal*  
Vespa 125 V1-V33/VM/VN/VNA • Vespa 150 VL • Vespa 150 VB1 • Vespa GS • Vespa VBA  
R.O. 018306, 18306



142700070 **NEW**



PORTATARGA EUROPEO | *EUROPEAN PLATE HOLDER*  
Dimensioni 150x130mm | *Dimensions 150x130mm*  
Colore Cromato | *Colour Chromed*  
Vespa 50 N/L/R • Vespa 50 Special • Vespa PK50/S/XL/XL2



**PORTATARGA - PLATE HOLDERS**

**142700390**



PORTATARGA VINTAGE | *VINTAGE PLATE  
HOLDER*

Dimensioni 170x170 mm | *Dimensions 170x170  
mm*

Colore Cromato | *Colour Chromed*

Vespa 125-150-200

R.O. 610016M

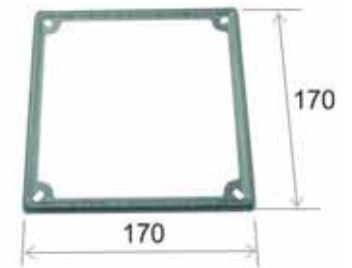

**142700400**



PORTATARGA VINTAGE | *VINTAGE PLATE  
HOLDER*

Dimensioni 170x170 mm | *Dimensions 170x170  
mm*

Colore Nero | *Colour Black*

Vespa 125-150-200

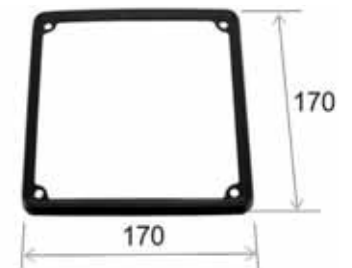

**PLASTICHE CARROZZERIA - CHASSIS PLASTICS**

**142560050**



VASCHETTA SOTTOSELLA | *UNDERSEAT  
TOOLBOX*

In plastica | *Plastic made*

Vespa PK • Vespa FL • Vespa HP • Vespa Rush  
• Vespa N

R.O. 219383



**142560030**



VASCHETTA SOTTOSELLA | *UNDERSEAT  
TOOLBOX*

Vespa 50-90 • Vespa 125 Primavera • Vespa  
125 ET3

R.O. 100389



## PLASTICHE CARROZZERIA - CHASSIS PLASTICS

**142560143**



PORTAOGGETTI PER BAULETTO ANTERIORE |  
STORAGE FOR FRONT CARRIER

Vespa PX 125 T5

Adattabile a tutte le versioni PX | *Suitable for all  
PX models*

R.O. 233112



**142620090**



COPRIMOLLEGGIO | *SUSPENSION ARM COVER*

Alluminio lucido | *Polished aluminium*

Vespa 125 VNB6 • Vespa GT • Vespa GTR •

Vespa Super 150 • Vespa 125 TS • Vespa 150

Sprint/Sprint Veloce • Vespa 180-200 Rally

R.O. 079227



**142680170**



PARASPRUZZO | *SPLASH GUARD*

Vespa tutti i modelli | *All models*

R.O. 610062M



**142680280**



PARASPRUZZO PARAFANGO ANTERIORE |  
*FRONT SPLASH GUARD*

Vespa 50-125 FL • Vespa FL2 • Vespa HP •

Vespa N

R.O. 266308



**142680290**



PARASPRUZZO POSTERIORE | *REAR SPLASH  
GUARD*

Grigio | *Grey*

Vespa FL2 • Vespa HP • Vespa N

R.O. 256940, 296982



**PLASTICHE CARROZZERIA - CHASSIS PLASTICS**

**142680560**



PARASPRUZZO | *SPLASH GUARD*  
 Vespa PK 50-125XL • Vespa 50 Rush  
 R.O. 9044005



**142600200**



GRIGLIA CALANDRA | *HORN COVER GRID*  
 Cromata | *Chromed*  
 Dimensioni 117x42 mm | *Dimensions 117x42 mm*  
 Vespa PX PE Arcobaleno • Vespe LML  
 R.O. 564221, 219119



**142600201**



GRIGLIA CALANDRA | *HORN COVER GRID*  
 Grigio scuro | *Dark grey*  
 Dimensioni 117x42 mm | *Dimensions 117x42 mm*  
 Vespa PX PE Arcobaleno • Vespe LML  
 R.O.219119



**142600300**



GRIGLIA CALANDRA | *HORN COVER GRID*  
 Nera | *Black*  
 Vespa 125 T5  
 R.O. 232894



**142600303**



GRIGLIA CALANDRA | *HORN COVER GRID*  
 Nera | *Black*  
 Vespa 125 T5  
 R.O. 232894



**142620040**



COPERCHIO MOZZO ALLUMINIO | *ALUMINIUM*  
 HUB COVER  
 Opaco | *Matt*  
 Vespa 50-90 • Vespa 125 Primavera  
 R.O. 070177



**142620050**



COPERCHIO PLASTICA GRIGIO | *GREY PLASTIC*  
 HUB COVER  
 Confezione 5 Pz. | *5 Pcs Packing*  
 Vespa PX 125-150-200 • Vespa PE Arcobaleno  
 R.O. 178048



**142620051**



COPERCHIO PLASTICA NERO | *BLACK PLASTIC*  
 HUB COVER  
 Confezione 5 Pz. | *5 Pcs Packing*  
 Vespa PX 125 T5  
 R.O. 178048, 232927



**142680090**



PROTEZIONE POSTERIORE SCOCCA | *REAR*  
 FRAME PROTECTION  
 In plastica | *Plastic made*  
 Vespa PX 125-150-200 ('98-'01) • Vespa PX  
 125 Euro 2 ('01-'07) • Vespa PXE 125-150-200  
 Arcobaleno ('81-'97)  
 R.O. 219110



**142680160**



PROTEZIONE POSTERIORE SCOCCA | *REAR*  
 FRAME PROTECTION  
 Distanza fori 115 mm | *Holes distance 115 mm*  
 Vespa P 125X • Vespa P 150X • Vespa P 200E  
 R.O. 162105





**PLASTICHE CARROZZERIA - CHASSIS PLASTICS**

**142680190**



PROTEZIONE SCOCCA | *REAR FRAME*

*PROTECTION*

Grigio | *Grey*

Vespa PX ('11-'15) • Vespa PX ('98-'01) • Vespa  
PX Euro 2 ('01-'07) • Vespa PX 30 Anni ('07-'08)  
• Vespa PX 150 ('11-'15)

R.O. 219110



**142680540**



PORTELLO BAULETTO | *GLOVEBOX DOOR*

In plastica, non verniciato | *Plastic made, not  
painted*

Vespa PK 50-125S

R.O. 216467



**142680550**



PULSANTE PORTELLO | *GLOVEBOX BUTTON*

Nero | *Black*

Fresato CNC | *CNC machined*

Vespa PK 50-125S

R.O. 216624



**ACCESSORI CARROZZERIA - BODYPARTS ACCESSORIES**

**121810073**



MANIGLIETTA COFANO DESTRA | *RIGHT HOOD  
HANDLE*

Completo di gommino e boccola | *With rubber  
and bushing*

Vespa ('59-'76)

R.O. 610399M



**121810080** **NEW**



LEVA COPERCHIO PORTAOGGETTI | *STORAGE COMPARTMENT LEVER*

Materiale Alluminio | *Material Aluminium*

Colore Argento | *Colour Silver*

Vespa ('98) • Vespa 125 V1-15T/V30-33T /VM/VN/

VNA/VNB1-2T/150 VL/VB1/150 GS

R.O. 50262



**121810090** **NEW**



PUNTALINO RIGATO LISTELLI PEDANA ESTERNO  
| *OUTSIDE GROOVED FLOOR RUNNER END CAP*

Materiale Alluminio | *Material Aluminium*

Lunghezza 30 mm | *Length 30 mm*

Scanalato | *Grooved*

Vespa 125 V1-15/V30-33/Hoffmann

R.O. 002992



**121810100** **NEW**



PUNTALINO RIGATO LISTELLI PEDANA INTERNO  
| *INNER GROOVED FLOOR RUNNER END CAP*

Materiale Alluminio | *Material Aluminium*

Scanalato | *Grooved*

Vespa 125 V1-15/V30-33/Hoffmann

R.O. 002982



**121810110** **NEW**



PUNTALINO LISCIO LISTELLI PEDANA ESTERNO  
| *OUTSIDE FLAT FLOOR RUNNER END CAP*

Materiale Alluminio | *Material Aluminium*

Liscio | *Smooth*

Confezione 1 pezzo | *1 piece pack*

Vespa 125-150 VM1-2/VN1-2/VL1-2

R.O. 18768



ACCESSORI CARROZZERIA - BODYPARTS ACCESSORIES

**121810120**

**NEW**



PUNTALINO LISCIO LISTELLI PEDANA INTERNO  
 | *INNER FLAT FLOOR RUNNER END CAP*  
 Materiale Alluminio | *Material Aluminium*  
 Liscio | *Smooth*  
 Confezione 1 pezzo | *1 piece pack*  
 Vespa 125-150 VM1-2/VN1-2/VL1-2/ GS150 >  
 005150  
 R.O. 018769



**121810130**

**NEW**



PUNTALINO DESTRO LUNGO CON GRADINO |  
 | *LONG FLOOR RUNNER END CAP WITH STEP, RIGHT*  
 Materiale Alluminio | *Material Aluminium*  
 Con fase | *With step*  
 Confezione 1 pezzo | *1 piece pack*  
 Vespa 150 GS VS2-3 > 0031830



**121810140**

**NEW**



PUNTALINO SINISTRO LUNGO CON GRADINO  
 | *LONG FLOOR RUNNER END CAP WITH STEP, LEFT*  
 Materiale Alluminio | *Material Aluminium*  
 Con fase | *With step*  
 Confezione 1 pezzo | *1 piece pack*  
 Vespa 150 GS VS2-3 > 0031830



**121810150**

**NEW**



PUNTALINO DESTRO LUNGO SENZA GRADINO  
 | *RIGHT FLOOR RUNNER END CAP WITHOUT STEP*  
 Materiale Alluminio | *Material Aluminium*  
 Senza fase | *Without step*  
 Confezione 1 pezzo | *1 piece pack*  
 Vespa 150 GS VS3 0031831 > VS5



121810160

NEW



PUNTALINO SINISTRO LUNGO SENZA GRADINO  
| *LEFT FLOOR RUNNER END CAP WITHOUT STEP*

Materiale Alluminio | *Material Aluminium*

Senza fase | *Without step*

Vespa 150 GS VS3 0031831 > VS5



121810170

NEW



PUNTALINO LISCIO CON SORMONTO | *FLOOR RUNN.END CAP WITH OVERLAP*

Materiale Alluminio | *Material Aluminium*

Liscio | *Smooth*

Vespa 150 VL3/VB/VBA/VBB1/T4/ GL/160 GS

R.O. 018768



121810180

NEW



KIT PUNTALINO | *FLOOR RUNNER END CAP KIT*

Vespa 125 V1-V15 V30/33 ('47-'49/'51-52)



121810190

NEW



KIT PUNTALINO | *FLOOR RUNNER END CAP KIT*

Vespa VM1/2-VS1 ('53-'57/'55-'57)



121810200

NEW



KIT PUNTALINO | *FLOOR RUNNER END CAP KIT*

Vespa 125 VN1 ('55-56)



ACCESSORI CARROZZERIA - BODYPARTS ACCESSORIES

121810210

NEW



KIT PUNTALINO | FLOOR RUNNER END CAP KIT  
Vespa 125 VN2('56-'57)



121810220

NEW



KIT PUNTALINO | FLOOR RUNNER END CAP KIT  
Vespa 150 VB1 ('57-'58)



121810230

NEW



KIT PUNTALINO | FLOOR RUNNER END CAP KIT  
Vespa VBA/VBB VLA-VSB1 ('59-'61)



121810240

NEW



KIT PUNTALINO | FLOOR RUNNER END CAP KIT  
Vespa 150 GS VS2/VS3-318302



121810250

NEW



KIT PUNTALINO | FLOOR RUNNER END CAP KIT  
Vespa 150 GS VS3 31831-VS5



142680910

NEW



PARAURTI COFANO E PARAFANGO | SIDE  
PANEL AND FRONT MUDGUARD BUMPER  
Materiale Gomma | Material Rubber  
Colore Nero | Colour Black  
Vespa PX ('82-'16)



**121830863**



GUAINA DI PROTEZIONE GANCIO COFANO |

HOOD HOOK PROTECTION SLEEVE

Confezione 10 pz. | 10 Pcs Packing

Vespa PX 80-200 • Vespa PE • Vespa Lusso •

Vespa T5

Adattabile a - Suitable for LML Star 125-150 2T/

4T/Stella

R.O. 178689



**121850370**



VITE PARAFANGO | SCREW MUDGUARD

Confezione 25 pz. | 25 Pcs Packing

Vespa tutti i modelli | All models

R.O. 014467



**121858490**



BULLONE RUOTA DI SCORTA | BOLT

Confezione 5 pz. | 5 Pcs Packing

Vespa PX 125-150-200 • Vespa PXE Arcobaleno

R.O. 159873



**121858500**



MOLLETTA ELASTICA PER PARASPRUZZI

POSTERIORE | REAR FLEXIBLE SPLASHGUARD

SPRING

Confezione 10 pz. | 10 Pcs Packing

Dimensioni Ø 16mm/ Øi 13,3mm/10 mm |

Dimensions Ø 16mm/ Øi 13,3mm/10 mm

Sono necessari 2 pezzi | 2 pieces required

Vespa PX 125-150-200 • Vespa PXE Arcobaleno

R.O. 181475



ACCESSORI CARROZZERIA - BODYPARTS ACCESSORIES

**121858610**



VITE TESTA PHILIPS ZINCATA M5 X 35 mm |

PHILIPS GALVANIZED SCREW M5 x 35 mm

Confezione 10 Pz. | 10 Pcs Packing

Per copri manubrio Vespa PX | For Vespa PX handlebar

Vespa PX 125-150-200 • Vespa PXE Arcobaleno

• Vespa PK 50-125 • Vespa PK 50-125XL

R.O. 015835, 015881



**142620070**

**NEW**



COPRIRUOTA CON TASCA | WHEEL COVER

WITH POCKET

3-50-8

Vespa anni '50-'60 con cerchio 8" - 50's and 60's models with 8" rims

Adattabile al cerchio 9 pollici - Suitable for 9" rims



**142620080**

**NEW**



COPRIRUOTA CON TASCA | WHEEL COVER

WITH POCKET

3-50-10

Vespa anni '60-'70-'80 con cerchio 10" -

60's-70's-80's models with 10" rims



**142660200**



COPPIA LISTELLI ACCIAIO INOX | STAINLESS

STEEL FLOOR RUNNERS FOR FLOOR MAT

Vespa GTR • Vespa Sprint • Vespa Super •

Vespa 160 GS ('62-'64) • Vespa Rally • Vespa

150 ('59>) • Vespa 125 ('62>)

R.O. 085073/74, 610295M



**142660210**



COPPIA LISTELLI ACCIAIO INOX | *STAINLESS STEEL FLOOR RUNNERS FOR FLOOR MAT*

Vespa 125 Primavera • Vespa Primavera ET3  
R.O. 610296M



**142660220**



COPPIA LISTELLI ACCIAIO INOX | *STAINLESS STEEL FLOOR RUNNERS FOR FLOOR MAT*

Vespa PX 1° serie  
R.O. 610296M



**142580113**



COPRISELETTORE CROMATO | *CHROMED GEAR BOX COVER*

Vespa PX 125-150-200



**142580253** **NEW**



COPRISELETTORE CROMATO | *CHROMED GEAR BOX COVER*

Materiale Acciaio inossidabile lucidato | *Material Polished stainless steel*

Distanza dal supporto 27 mm | *Distance from holder 27 mm*

Vespa PX 2° serie • Vespa T5  
R.O. 235538

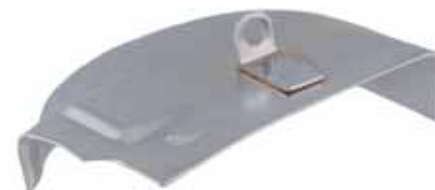

**142600040**



MODANATURA CALANDRA | *STEERING MOULDING*

Incluso morsetti ed emblema | *With clamp and emblem*

Vespa 50 Special ('69-'82)  
R.O. 123576





ACCESSORI CARROZZERIA - BODYPARTS ACCESSORIES

**142700030**



PORTABOLLO | *ROAD TAX HOLDER*  
 Confezione 5 pz. | *5 Pcs Packing*  
 Vespa tutti i modelli | *All models*



**142800030**



PARAURTI ANTERIORE | *FRONT BUMPER*  
 Grigio | *Grey*  
 Tubo doppio | *Double tube*  
 Vespa PX • LML  
 R.O. 610272M



**142800031**



PARAURTI ANTERIORE | *FRONT BUMPER*  
 Nero | *Black*  
 Tubo doppio | *Double tube*  
 Vespa PX • LML



**246140510**



BOCCOLA PER CONTATTO COFANI | *HOOD CONNECTION BUSH*  
 Con contatto freccia, chiusura interna | *With indicator contact, inner closing*  
 Vespa PX tutti i modelli - *all models*  
 R.O. 216053



**121810063**



GANCI COFANO | *SIDEPANEL HOOKS*  
 Per apertura e chiusura | *For opening and closing*  
 Vespa PX 125-150-200  
 R.O. 227229, 244093



## ACCESSORI CARROZZERIA - BODYPARTS ACCESSORIES

**121810033**



GANCIO PORTABORSE NERO | *BLACK BAG HOOK*

Distanza fori 23 mm | *Holes distance 23 mm*

Vespa PX T5 • Vespa PX 125-150 ('11-'17)

R.O. 227153



**121810030**



GANCIO PORTABORSA ZINCATO | *HOOK FOR BAG GALVANIZED*

Distanza fori 23 mm | *Holes distance 23 mm*

Vespa 50-90 • Vespa 125 Primavera • Vespa ET3 • Vespa PX

R.O. 057468, 227153



**121810041**



GANCIO PORTACASCO | *HELMET HOOK*

Vespa PX

R.O. 219857



**121810050**



GANCIO PORTABORSA | *BAG HOOK*

Vespa 125 VNA-VNB-150 VBB

R.O. 011653



## GOMMINI ANTIVIBRANTI - RUBBER PADS

**121830420**



TUBETTO COFANO | *SIDEPANEL RUBBER TUBE*

Confezione 5 Pz. | *5 Pcs Packing*

Vespa PX PE 125-150-200 ('59>)

R.O. 024041



**GOMMINI ANTIVIBRANTI - RUBBER PADS**

**121830490**



TAMPONI BATTUTA COFANI MOTORE | *ENGINE  
SIDEPANELS BUFFERS*

Confezione 5 Pz. | *5 Pcs Packing*

Vespa PK 50 • Vespa PK 50-125XL

R.O. 232222, 231589



**121830590**



GOMMINO DI BATTUTA SPORTELLO BAULETTO  
| *GLOVE BOX DOOR RUBBER BUFFER*

Confezione 5 Pz. | *5 Pcs Packing*

Vespa PX 125-150-200 • Vespa T5 • Vespa 50-

125 • Cosa

R.O. 149908



**142640543**



KIT GOMMINI COFANO | *RUBBER HOOD  
SIDEPANEL KIT*

Include boccola perno cofano/boccola leva  
chiusura e gomma albero cofano | *With  
sidepanel pin bushing/ locking lever bushing  
and sidepanel rubber*

Vespa 125-150 ('59-'77)



**142640553**



KIT GOMMINI PORTELLO | *RUBBER DOOR KIT*

Vespa 50 1° serie Vespa 90



**142640563**



KIT GOMMINI PORTELLO | *RUBBER DOOR KIT*

Include boccole coperchio laterale | *With  
bushing for side cover*

In gomma/plastica | *Plastic/rubber made*

Nero/bianco | *Black/white*

Vespa 50 • Vespa 90 SS • Vespa 125 Primavera

• Vespa ET3



## GOMMINI ANTIVIBRANTI - RUBBER PADS

**142640573**



KIT GOMMINI COFANO | *RUBBER COWLS KIT*  
 Include boccola leva di bloccaggio/  
 ammortizzatore in gomma e mandrino in  
 gomma per calotta laterale | *Incl. bush lock*  
*lever/rubber buffer and rubber spike side panel*  
 Vespa P 125-150X • Vespa P 200E



**142640583**



KIT GOMMINI COFANO | *RUBBER COWLS KIT*  
 Include boccola leva chiusura/gommino e  
 gomma albero cofano | *Incl. bush lock lever/*  
*rubber buffer and rubber spike side panel*  
 Vespa PX PE 125-150-200 Arcobaleno



# TELAIO

CHASSIS



**184100212**



Leva freno/frizione | *Brake/Clutch lever*  
 Lunghezza 130 mm | *Length 130 mm*  
 Materiale Alluminio | *Material Aluminium*  
 Colore Argento | *Colour Silver*  
 Appuntita | *Pointed*  
 Vespa 50 ('63-'69) • Vespa GL  
 R.O. 070578



**184100250**



Leva freno/frizione | *Brake/Clutch lever*  
 Lunghezza 145 mm | *Length 145 mm*  
 Materiale Alluminio | *Material Aluminium*  
 Colore Nero | *Colour Black*  
 Sfera grande | *Large ball*  
 Vespa PX PE Arcobaleno (>'83) • Vespa Rally  
 R.O. 226792/A (LML)



**184100251**



Leva freno/frizione | *Brake/Clutch lever*  
 Lunghezza 145 mm | *Length 145 mm*  
 Materiale Alluminio | *Material Aluminium*  
 Colore Argento | *Colour Silver*  
 Sfera grande | *Large ball*  
 Vespa PX Arcobaleno (>'83)  
 R.O. 138336, 2425314



**184100431**



Leva freno/frizione | *Brake/Clutch lever*  
 Materiale Alluminio | *Material Aluminium*  
 Colore Argento | *Colour Silver*  
 Sfera grande | *Large ball*  
 Vespa 50 Special • Vespa 125 Primavera ET3  
 ('76>)  
 R.O. 165279



**184100890**



Leva freno/frizione | *Brake/Clutch lever*  
 Materiale Alluminio | *Material Aluminium*  
 Colore Argento | *Colour Silver*  
 Vespa 125-150 ('58-'65) • Vespa 150-160 GS  
 tutti i modelli - *all models*  
 R.O. 033882



**LEVE - LEVERS****184100891**

Leva freno/frizione | *Brake/Clutch lever*  
 Materiale Alluminio | *Material Aluminium*  
 Colore Argento | *Colour Silver*  
 Vespa 125-150 ('58-'65) • Vespa 150-160 GS  
 tutti i modelli- *all models*  
 R.O. 033882

**184100901**

Leva freno/frizione | *Brake/Clutch lever*  
 Lunghezza 145 mm | *Length 145 mm*  
 Materiale Alluminio | *Material Aluminium*  
 Colore Argento | *Colour Silver*  
 Sfera grande | *Large ball*  
 Vespa 180-200 Rally  
 R.O. 120487

**184100911**

Leva freno/frizione | *Brake/Clutch lever*  
 Lunghezza 145 mm | *Length 145 mm*  
 Materiale Alluminio | *Material Aluminium*  
 Colore Argento | *Colour Silver*  
 Sfera grande | *Large ball*  
 Vespa PX Arcobaleno con freno a disco - *with  
 brake disc*  
 R.O. 2425314, 242531, 138336

**184100941**

Leva freno/frizione | *Brake/Clutch lever*  
 Lunghezza 130 mm | *Length 130 mm*  
 Materiale Alluminio | *Material Aluminium*  
 Colore Argento opaco | *Colour Matt silver*  
 Striato | *Striped*  
 Vespa 50-125 Primavera • Vespa PX modello  
 Sport - *Sport model*  
 R.O. 610285M

**184100961**

Leva frizione | *Clutch lever*  
 Materiale Alluminio | *Material Aluminium*  
 Colore Nero | *Colour Black*  
 Vespa 50 FL • Vespa FL2 • Vespa HP • Vespa  
 Automatica • Vespa PK 125FL  
 R.O. 265947



**184100261**



Leva frizione | *Clutch lever*

Materiale Alluminio | *Material Aluminium*

Colore Argento | *Colour Silver*

Vespa 50 FL • Vespa FL2 • Vespa HP • Vespa

Automatica • Vespa PK 125FL

R.O. 274489



**184100971**



Leva frizione | *Clutch lever*

Materiale Alluminio | *Material Aluminium*

Colore Grigio | *Colour Grey*

Vespa 50 FL • Vespa FL2 • Vespa HP • Vespa

Automatica • Vespa PK 125FL

R.O. 265948



**184120281**



Leva freno | *Brake lever*

Materiale Alluminio | *Material Aluminium*

Colore Nero | *Colour Black*

Vespa 50 FL • Vespa FL2 • Vespa HP • Vespa

Automatica • Vespa PK 125FL

R.O. 265947



**184120291**



Leva freno | *Brake lever*

Materiale Alluminio | *Material Aluminium*

Colore Argento | *Colour Silver*

Vespa 50 FL • Vespa FL2 • Vespa HP • Vespa

Automatica • Vespa PK 125FL

R.O. 274547, 274490



**184120791**



Leva freno | *Brake lever*

Materiale Alluminio | *Material Aluminium*

Colore Argento | *Colour Silver*

Sfera grande | *Large ball*

Vespa PX Arcobaleno con freno a disco - *with  
brake disc*

R.O. 494804, 494891, 646805





**LEVE - LEVERS****184120911**Leva freno | *Brake lever*Materiale Alluminio | *Material Aluminium*Colore Grigio | *Colour Grey*

Vespa 50 FL • Vespa FL2 • Vespa HP • Vespa Automatica • Vespa PK 125FL

**ACCESSORI LEVE - LEVERS ACCESSORIES****121856120**VITE LEVA FRENO E FRIZIONE | *LEVER  
SECURING SCREW*Confezione 50 pz. | *50 Pcs Packing*Dado incluso | *With nut*Vespa tutti i modelli escluso PK | *All models  
except for PK*

R.O. 150235, 012136, 008520

**121858640**VITE LEVA FRENO E FRIZIONE | *LEVER  
SECURING SCREW*Confezione 5 pz. | *5 Pcs Packing*Dado incluso | *With nut*Vespa tutti i modelli fino al '72 | *All models till  
'72*

R.O. 6610283M, 150235, 012136

**121860033**LEVETTA FRENO POSTERIORE | *REAR BRAKE  
LEVER*Dimensioni 67x4,0/6,2 mm | *Dimensions  
67x4,0/6,2 mm*Materiale Acciaio zincato | *Material Galvanized  
steel*

Vespa PX 125-150-200 Arcobaleno

R.O. 1001014, 215572



## ACCESSORI LEVE - LEVERS ACCESSORIES

**121860323**



KIT SERRACAVO FRENO ANTERIORE | *FRONT BRAKE CABLE NIPPLE*

Confezione 5 pz. | *5 Pcs Packing*

Incluso piastre, bullone e coppiglia | *With plates, nut and split pin*

Vespa tutti i modelli | *All models*

R.O. 177271



**121950010**



Molla ritorno leva | *Return spring lever*

Confezione 5 pz. | *5 Pcs Packing*

Incluso piastre, bullone e coppiglia | *With plates, nut and split pin*

Vespa PK • Cosa

R.O. 177072



## TUBI COMANDO - THROTTLE AND SHIFT CONTROLS

### TUBO COMANDO CAMBIO - SHIFT CONTROL

**184040320**



4 Velocità | *4 Speed*

Ø 24 mm

Vespa 50 S (V5SA1T 67571->)

R.O. 138223, 1382235

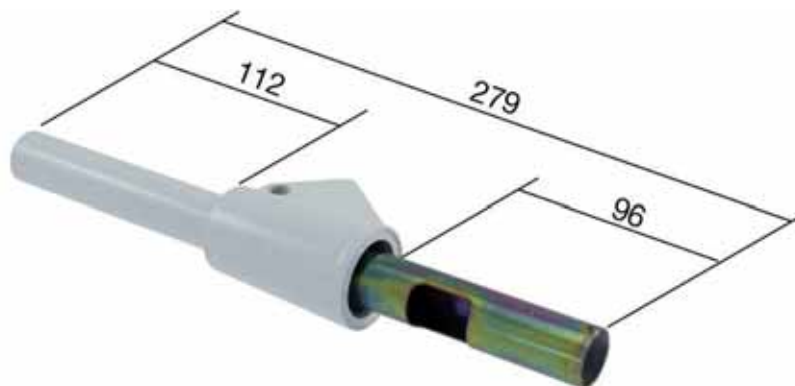

**184040330**



4 Velocità | *4 Speed*

Ø 24 mm

Vespa 50 Special (V5B3T 62020->)

R.O. 135935, 139008

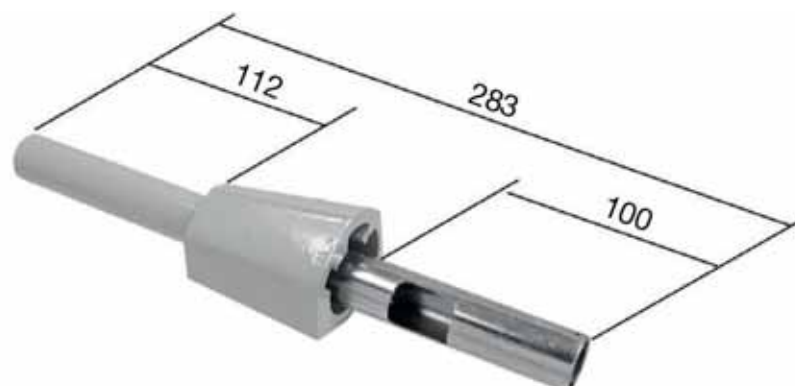

**TUBI COMANDO - THROTTLE AND SHIFT CONTROLS****184040380**

4 Velocità | 4 Speed

Ø 24 mm

Vespa 125 Primavera (VMA2T > 0135425) •  
 Vespa 125 Super (VNC1T) • Vespa 150 Super  
 (VBC1T>356682) • Vespa Sprint (VLB1T) • Vespa  
 Sprint Veloce (VLB1T 015001>0228777) • Vespa  
 GL (VLA1T) • Vespa 125 GT (VNL2T) • Vespa 125  
 GTR (VNL2T 100001>138888) • Vespa 180 Rally  
 (VSD1T) • Vespa 200 Rally (VSE1T>0025731) •  
 Vespa 125 TS (VNL3T>4174)  
 R.O. 090538, 070587, 70587

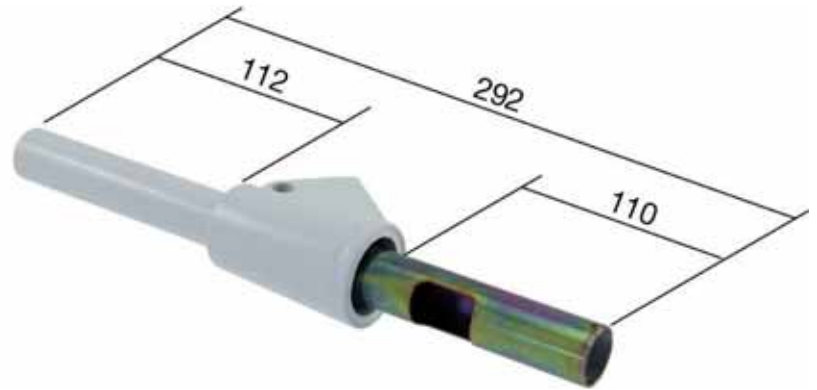
**184040390**

Freno a disco | Brake disc

Con sede per comando lampeggiatori | With  
seat for flashers control

Ø 24 mm

Vespa PX 125 30 Anni ('07-'08) • Vespa PX PE •  
 Vespa Arcobaleno • Vespa PX 125 EU 2 ('01-'07)  
 R.O. 219356, 139918

**184040400**

3 Velocità | 3 Speed

Ø 24 mm

Vespa 50 (V5A1T>881915) • Vespa 90  
 (V9A1T>122983)  
 R.O. 138011

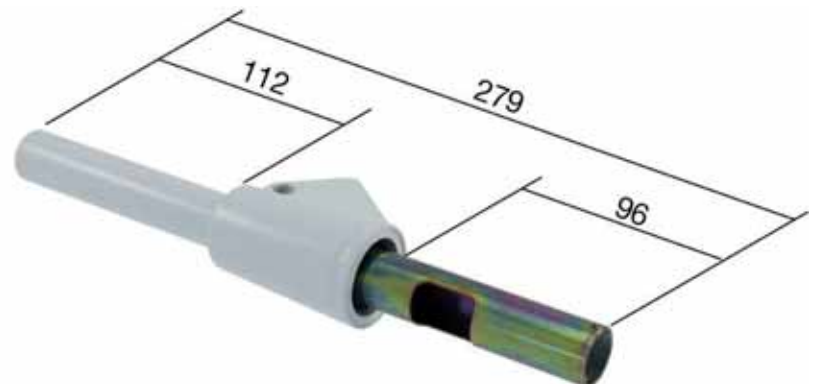

## TUBI COMANDO - THROTTLE AND SHIFT CONTROLS

**184040720**



4 Velocità | 4 Speed  
Ø 24 mm

Vespa 125 Primavera (VMA2T>0135425)

• Vespa 125 ET3 • Vespa 150 Super (VBC1T>356682) • Vespa Sprint (VLB1T) • Vespa Sprint Veloce (VLB1T 015001>0228777) • Vespa 125 GTR (VNL2T 100001>138888) • Vespa 200 Rally (VSE1T>0025731) • Vespa 125 TS (VNL3T>4174)

R.O. 137840, 1378406

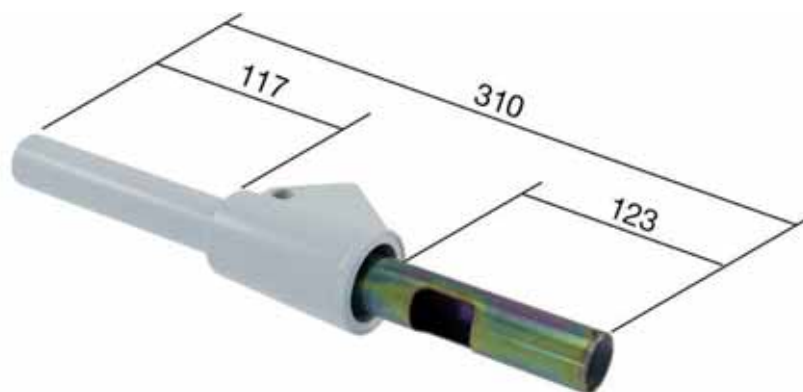

**184040730**



3 Velocità | 3 Speed

Per modelli senza lampeggiatori | For vehicles without flashers

Ø 24 mm

Vespa 50 Special (fino al V5B3T 62019> - till V5B3T 62019>)

R.O. 139780, 112147, 123258

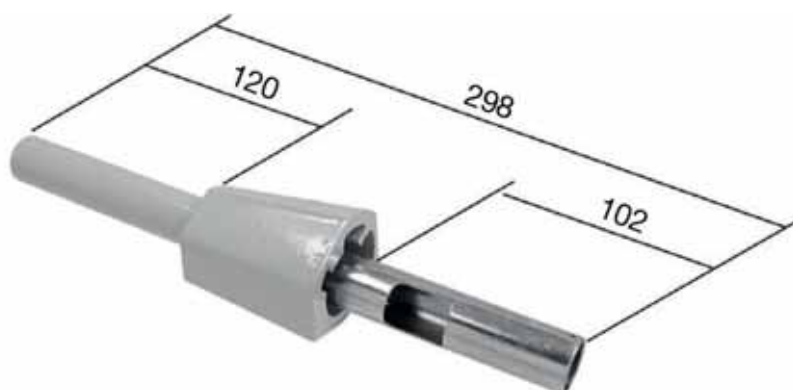

## TUBO COMANDO GAS - THROTTLE CONTROL

**184040833** **NEW**



Kit tubo comando cambio/puleggia | Throttle control tube

Vespa GT • Vespa GTR • Vespa Super 125-150 • Vespa 150 GL • Vespa Sprint/Veloce • Vespa 180-200 Rally • Vespa 180 SS

Adattabile a - suitable for Vespa 50/N/L/R/S/SR/90/R • Vespa 125 Primavera

R.O. 70573, 70569



**184040853** **NEW**



Kit comando gas 24mm | Throttle control 24mm

Vespa tutti i modelli - all models



**TUBI COMANDO - THROTTLE AND SHIFT CONTROLS****TUBO COMANDO GAS - THROTTLE CONTROL****184080270**

3 Velocità | 3 Speed

Ø 24 mm

Vespa 50-50L-50R (V5A1T>881915) • Vespa 50  
S (V5SA1T>67570) • Vespa 50 SS (V5SS2T) •  
Vespa 90 (V9A1T>122983)

R.O. 70690

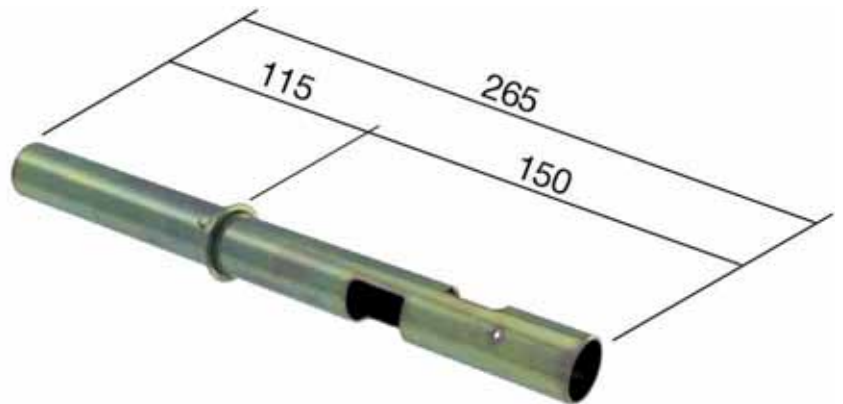
**184080290**

Ø 24 mm

Vespa PX PE • Vespa PX PE Arcobaleno • Vespa  
125 PX 30 anni • Vespa PX 125 EU2 • Vespa PK  
50 • Vespa 50 Rush • Vespa 50 N • Vespa PK  
50 Automatica • Vespa PK 50-125XL • Vespa  
PK 50XL Plurimatic

R.O. 139778

**184080291** **NEW**

Ø 24 mm

Vespa PX PE • Vespa PX PE Arcobaleno • Vespa  
125 PX 30 anni • Vespa PX 125 EU2 • Vespa PK  
50 • Vespa 50 Rush • Vespa 50 N • Vespa PK  
50 Automatica • Vespa PK 50-125XL • Vespa  
PK 50XL Plurimatic

R.O. 139778

**184080320**

3/4 Velocità | 3/4 Speed

Ø 24 mm

Vespa 50 Special (V5A2T-V5B1T-V5B3T>62020)  
• Vespa 50 Elestart (V5A3T-V5B2T)

R.O. 123260



**184080690**



Ø 22 mm

Con molla | With spring

Vespa 125 (dal VNB3T - from VNB3T) • Vespa 150 (VB1T-VBA1T-VBB1T-VBB2T) • Vespa 150 GS (VS2T>VS5T) • Vespa 160 GS (VSB1T)  
R.O. 94370, 6055, 84468, 60544

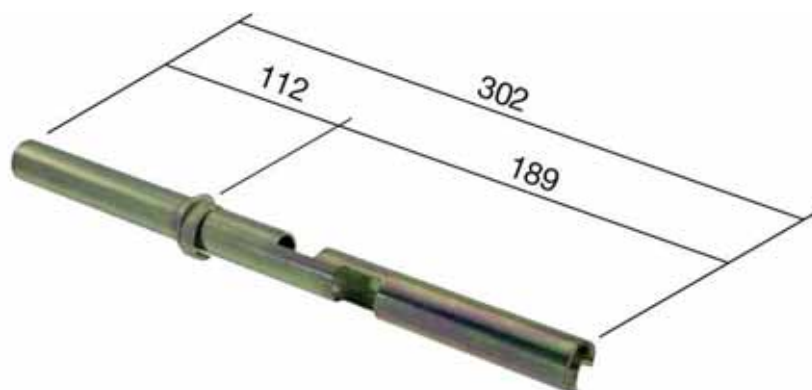

**184080700**



Ø 24 mm

Vespa 125 Primavera (VMA2T>0135425) • Vespa Super 125 (VNC1T) • Vespa Super 150 (VBC1T>356682) • Vespa Sprint (VLB1T) • Vespa Sprint Veloce (VLB1T 015001>0228777) • Vespa GL (VLA1T) • Vespa GT 125 (VNL2T) • Vespa GTR 125 (VNL2T 100001>138888) • Vespa Rally 180 (VSD1T) • Vespa Rally 200 (VSE1T>0025731)  
R.O. 70589



**184080710**



4 Velocità | 4 Speed

Ø 24 mm

Vespa 50 SS • Vespa 90 SS  
R.O. 101464

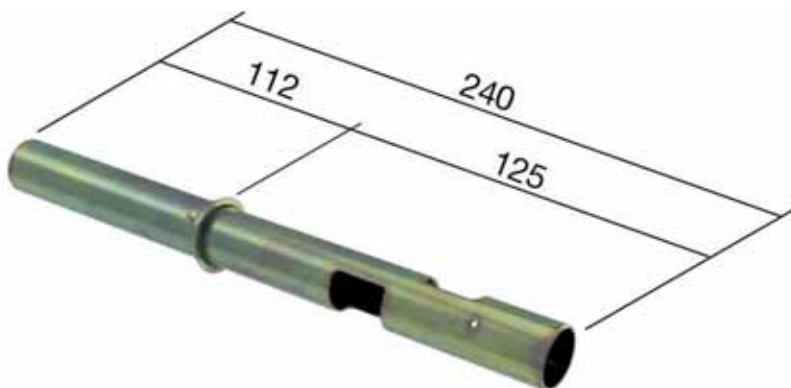

**184080720**



4 Velocità | 4 Speed

Ø 24 mm

Vespa 50 Special (V5B3T 62021>)  
R.O. 137939, 137951



**TUBI COMANDO - THROTTLE AND SHIFT CONTROLS****184080721** **NEW**

4 Velocità | 4 Speed

Ø 24 mm

Vespa 50 Special (V5B3T 62021&gt;)

R.O. 137939, 137951

**184080753**

Cosa 2 125 ('91-'97) • Cosa 125 CL-CLX ('88-'91)

R.O. 228531

**184040783**

TUBETTO GAS | THROTTLE CONTROL

Vespa 50 N-L-R

R.O. 0573, 73556, 102633

**ACCESSORI COMANDI - CONTROLS ACCESSORIES****121858510**

RONDELLA PER TUBO COMANDO GAS/CAMBIO

| WASHER FOR THROTTLE/SHIFT CONTROL

Ondulata | Waved

Confezione 20 pz. | 20 Pcs Packing

Vespa 50-90 • Vespa 125 Primavera • Vespa

ET3 • Vespa PX 125-150-200

R.O. 139890, 101473

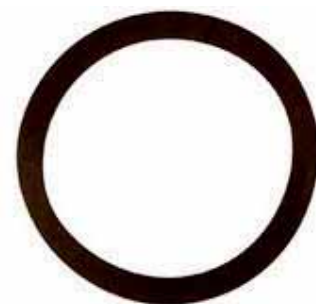

**121860520**



PIASTRA SUPPORTO GUAINA | *CABLE GUIDE  
HOLDER*

Per interno manubrio | *For inner handlebar*  
Vespa 50 Special ('69-'80)



**184040610**



PULEGGIA CAMBIO | *GEAR PULLEY*

Vespa 50 N • Vespa PK 50 • Vespa PK 50  
Automatica • Vespa PK 50-125XL • Vespa PK  
50XL Plurimatic • Vespa 50 Rush • Vespa PX  
125-150 • Vespa PX 125 30 anni • Vespa PX 125  
EU2 • Vespa PXE 125 Arcobaleno • Vespa 125  
T5  
R.O. 139796



**184040620**



PULEGGIA GAS | *THROTTLE PULLEY*

Vespa 50 N • Vespa PK 50 • Vespa PK 50  
Automatica • Vespa PK 50-125XL • Vespa PK  
50XL Plurimatic • Vespa 50 Rush • Vespa PX  
125-150 • Vespa PX 125 30 anni • Vespa PX 125  
EU2 • Vespa PXE 125 Arcobaleno • Vespa 125  
T5  
R.O. 139797



**184040673**



BUSSOLA CAVO | *BUSH*

Vespa 50 N • Vespa PK 50 • Vespa PK 50  
Automatica • Vespa PK 50-125XL • Vespa PK  
50XL Plurimatic • Vespa 50 Rush • Vespa PX  
125-150 • Vespa PX 125 30 Anni • Vespa 125  
PX Euro2 • Vespa PXE 125 Arcobaleno • Vespa  
125 T5  
R.O. 133912





**ACCESSORI COMANDI - CONTROLS ACCESSORIES****184040683**BUSSOLA CAVO | *BUSH*In plastica | *Plastic made*

Vespa 50 N • Vespa PK 50 • Vespa PK 50 automatica • Vespa PK 50-125XL • Vespa PK 50XL Plurimatic • Vespa 50 Rush • Vespa PX 125-150 • Vespa PX 125 30 anni • Vespa PX 125 Euro 2 • Vespa 125 PXE Arcobaleno • Vespa 125 T5  
R.O. 133913

**184040690**KIT BOCCOLE MANUBRIO | *HANDLEBAR MOUNTING BUSHINGS KIT*

Per installazione dei coprimanubrio inferiore:  
142680503 - 142680513 - 142680514 | *Adapt for handbar lower part installation: 142680503 - 142680513 - 142680514*

Composizione kit:

2 x 184040790

2 x 184040800

1 x 184040810

Adattabile a Vespa PX | *Suitable for Vespa PX***184040790**BOCCOLA MANUBRIO | *HANDLEBAR BUSHING*  
Ø27 x Ø24 x 11 mmConfezione 10 pz. | *10 Pcs Packing*Adattabile a Vespa PX | *Suitable for Vespa PX***184040800**BOCCOLA MANUBRIO | *HANDLEBAR BUSHING*  
Ø27 x Ø24 x 17 mmConfezione 10 pz. | *10 Pcs Packing*Adattabile a Vespa PX | *Suitable for Vespa PX*

## ACCESSORI COMANDI - CONTROLS ACCESSORIES

184040810



BOCCOLA MANUBRIO | *HANDLEBAR BUSHING*  
 Ø27 x Ø24 x 39 mm  
 Confezione 10 pz. | *10 Pcs Packing*  
 Adattabile a Vespa PX | *Suitable for Vespa PX*



184040843



COPPIGLIA A MOLLA TUBO COMANDO  
 CAMBIO/ACCELERATORE | *SPRING COTTER PIN*  
*THROTTLE*  
 Acciaio zincato | *Galvanized steel*  
 Vespa 50/N/L/R/S/SR/90/R • Vespa 125  
 Primavera • Vespa GT • Vespa GTR • Vespa  
 125-150 Super • Vespa 150 GL • Vespa Sprint  
 • Vespa Sprint Veloce • Vespa 180 SS • Vespa  
 180-200 Rally  
 R.O. 097356



184040873



COPPIGLIA A MOLLA TUBO COMANDO  
 CAMBIO/ACCELERATORE | *SPRING COTTER PIN*  
*THROTTLE*  
 Vespa V 50R/S/Special/90/100 • Vespa 125  
 Primavera • Vespa ET3/PK XL FL/HP/N/XL2/  
 Automatica • Vespa ET3  
 R.O. 101481



## MANOPOLE E ACCESSORI - GRIPS AND ACCESSORIES

184160080



Nero | *Black*  
 Ø 22 mm  
 Vespa 50 • Vespa Primavera • Vespa ET3 •  
 Vespa PK • Vespa FL • Vespa HP  
 R.O. 3040.82.40.04 (Domino), 274489 (Piaggio)

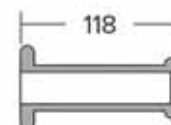

Estremità chiusa  
*Closed end*



**MANOPOLE E ACCESSORI - GRIPS AND ACCESSORIES****184160090**Nero | *Black*

Ø 22 mm

Vespa PK • Vespa PK 50-125XL

R.O.227077

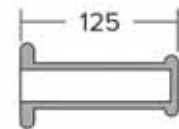
Estremità chiusa  
*Closed end***184160100**Nero | *Black*

Ø 24 mm

Vespa 50 • Vespa Primavera • Vespa ET3

R.O.141924

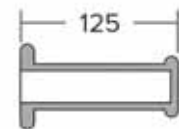
Estremità chiusa  
*Closed end***184160110**Nero | *Black*

Ø 24 mm

Vespa PX 125-150-200 • Vespa PE • Vespa GTR

• Vespa Super

Vespa Sprint • Vespa Rally

R.O.141923

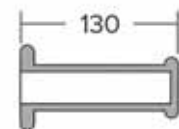
Estremità chiusa  
*Closed end***184160120**Nero | *Black*

Ø 24 mm

Vespa PX 125E • Vespa PX 150E • Vespa PX

200E Arcobaleno

R.O.179833

Estremità chiusa  
*Closed end*

**184160140**



Grigio | Grey  
Ø 24 mm

Vespa PX • Vespa PE • Vespa Super • Vespa  
GTR • Vespa Sprint • Vespa Rally

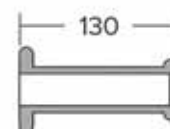

Estremità chiusa  
Closed end

**184160390**



Nero | Black  
Ø 24 mm

Vespa PX • Vespa PE • Vespa Super • Vespa  
GTR • Vespa Sprint • Vespa Rally  
R.O. 582234

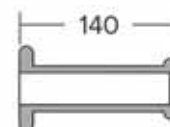

Estremità chiusa  
Closed end

**184160550**



Grigio | Grey  
Ø 24 mm

Vespa 50 • Vespa Primavera • Vespa ET3

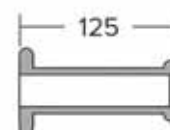

Estremità chiusa  
Closed end

**184161210**



Bianco | White  
Ø 24 mm

Vespa V30-V31-V33-VM-VN-VL  
R.O. 012153

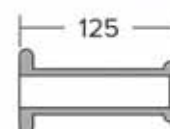

Estremità chiusa  
Closed end

**CAVALLETTI LATERALI - SIDE STANDS****121630470**

Con ritorno automatico | *Automatic return*  
 Nero | *Black*  
 Vespa 50-90 • Vespa 125 Primavera • Vespa  
 ET3

**121630471**

Con ritorno automatico | *Automatic return*  
 Cromato | *Chromed*  
 Vespa PK 50-125

**121630480**

Con ritorno automatico | *Automatic return*  
 Nero | *Black*  
 Vespa PK 50 • Vespa PK 125XL

**121630481**

Con ritorno automatico | *Automatic return*  
 Cromato | *Chromed*  
 Vespa 50-90 • Vespa 125 Primavera • Vespa  
 ET3

**121630490**

Con ritorno automatico | *Automatic return*  
 Nero | *Black*  
 Vespa PX 125-150-200 Arcobaleno



## CAVALLETTI LATERALI - SIDE STANDS

**121630491**



Con ritorno automatico | *Automatic return*

Cromato | *Chromed*

Vespa PX 125-150-200 Arcobaleno



## CAVALLETTI CENTRALI - CENTRAL STANDS

**121610670**



Nero Ø 22 mm | *Black Ø 22 mm*

Ruota 10" | *Wheel 10"*

Completo di piedini | *With stand feet*

Vespa PK • Vespa PK XL • Vespa Rush • Vespa N • Vespa HP • Vespa FL

R.O. 2172476



**121610350**



Nero Ø 20 mm | *Black Ø 20 mm*

Ruota 10" | *Wheel 10"*

Completo di piedini | *With stand feet*

Vespa 50-90 • Vespa Primavera • Vespa ET3

R.O. 1353846



**121610351**



Zincato Ø 20 mm | *Galvanized Ø 20 mm*

Ruota 10" | *Wheel 10"*

Completo di piedini | *With stand feet*

Vespa 50-90 • Vespa 125 Primavera • Vespa 125 ET3

R.O. 1353847



**CAVALLETTI CENTRALI - CENTRAL STANDS****121610352**

Cromato Ø 20 mm | *Chromed Ø 20 mm*  
 Ruota 10" | *Wheel 10"*  
 Completo di piedini | *With stand feet*  
 Vespa 50-90 • Vespa 125 Primavera • Vespa  
 125 ET3  
 R.O. 1353848

**121610671**

Zincato Ø 22 mm | *Galvanized Ø 22 mm*  
 Ruota 10" | *Wheel 10"*  
 Completo di piedini | *With stand feet*  
 Vespa PK • Vespa PK XL • Vespa Rush • Vespa  
 N • Vespa HP • Vespa FL  
 R.O. 2172476

**121610672**

Cromato Ø 22 mm | *Chromed Ø 22 mm*  
 Ruota 10" | *Wheel 10"*  
 Completo di piedini | *With stand feet*  
 Vespa PK • Vespa PK XL • Vespa Rush • Vespa  
 N • Vespa HP • Vespa FL • Vespa PK S • Vespa  
 PK SS • Vespa ETS • Vespa PK XL2 • Vespa  
 Plurimatic • Vespa Automatica  
 R.O. 2172476

**121610830**

Zincato Ø 16 mm | *Galvanized Ø 16 mm*  
 Ruota 9" | *Wheel 9"*  
 Senza piedini | *Without stand feet*  
 Vespa 50 V5A1T, V5SA1, V5SS1 • Vespa 90 •  
 Vespa Nuova 125 VMA1T (>'71) • Vespa 50 N-L-R  
 • Vespa Special • Vespa Elestart • Vespa SR •  
 Vespa 90 • Vespa R • Vespa 125 Primavera ('72)  
 R.O. 070161



## CAVALLETTI CENTRALI - CENTRAL STANDS

**121610360**



Nero Ø 22 mm | Black Ø 22 mm  
 Ruota 10" | Wheel 10"  
 Completo di piedini | With stand feet  
 Vespa FL 125-150-199 • Cosa  
 R.O. 2533615,253361



**121610370**



Nero Ø 22 mm | Black Ø 22 mm  
 Ruota 10" | Wheel 10"  
 Completo di piedini | With stand feet  
 Vespa PX 125-150-200 • Vespa PX Arcobaleno  
 Adattabile a - Suitable for LML



**121610371**



Zincato Ø 22 mm | Galvanized Ø 22 mm  
 Ruota 10" | Wheel 10"  
 Completo di piedini | With stand feet  
 Vespa PX 125-150-200 • Vespa PX Arcobaleno  
 Adattabile a - Suitable for LML  
 R.O. SF522-0846 (LML)



**121610372**



Cromato Ø 22 mm | Chromed Ø 22 mm  
 Ruota 10" | Wheel 10"  
 Completo di piedini | With stand feet  
 Vespa PX 125-150-200 • Vespa PX Arcobaleno  
 Adattabile a - Suitable for LML



**121610374**



Nero Ø 22 mm | Black Ø 22 mm  
 Ruota 10" | Wheel 10"  
 Completo di piedini | With stand feet  
 Vespa PX 125-150-200 • Vespa PX Arcobaleno  
 Adattabile a - Suitable for LML





**CAVALLETTI CENTRALI - CENTRAL STANDS****121610380**Nero Ø 22 mm | *Black Ø 22 mm*Ruota 10" | *Wheel 10"*Completo di piedini | *With stand feet*

Vespa PX 125-150-200 • Vespa PX Arcobaleno

Adattabile a - *Suitable for LML***121610790**Nero Ø 22 mm | *Black Ø 22 mm*Ruota 10" | *Wheel 10"*Completo di piedini | *With stand feet*

Vespa 125 T5

R.O. 232904

**121610800**Zincato Ø 20 mm | *Galvanized Ø 20 mm*Ruota 8" | *Wheel 8"*Senza piedini | *Without stand feet*

Vespa 125 VNB2T dal telaio n.09001 fino a

VNB3-6T - *from chassis n.09001 till VNB3-6T*

• Vespa 125-150 Super • Vespa 150 VBB1T

dal telaio n.17451 fino a VBB2T - *from chassis**n17451 till VBB2T*

R.O. 54140

**121610860****NEW**Zincato Ø 15 mm | *Galvanized Ø 15 mm*Senza piedini | *Without stand feet*

Vespa 150 GS VS4/5

R.O. 82732



## CAVALLETTI CENTRALI - CENTRAL STANDS

**121610870**



Zincato Ø 15 mm | Galvanized Ø 15 mm  
 Ruota 8" | Wheel 8"  
 Senza piedini | Without stand feet  
 Vespa 125 ('51-'54)  
 VM1T-VM2T-VL1T-VL2T  
 R.O. 26226



**121610880**



Zincato Ø 15 mm | Galvanized Ø 15 mm  
 Ruota 8" | Wheel 8"  
 Senza piedini | Without stand feet  
 Vespa 150 GS VS4/5  
 R.O. 82732



**121610890**



Zincato Ø 15 mm | Galvanized Ø 15 mm  
 Ruota 8" | Wheel 8"  
 Senza piedini | Without stand feet  
 Vespa 125 V13 dal telaio n.63601 fino a V15 -  
 from chassis n.63601 till V15 • Vespa V30-33 •  
 Vespa Hoffmann AB • Vespa ACMA ('51-'53)  
 R.O. 15032, 13967



**121610910**

**NEW**



Zincato Ø 16 mm | Galvanized Ø 16 mm  
 Senza piedini | Without stand feet  
 Vespa 125 VNA1T dal telaio n.030505 fino a  
 VNA2T - from chassis n.030505 till VNA2T •  
 Vespa VNB1T • Vespa VNB2T fino al telaio  
 n.09000 - till chassis n.09000 • Vespa 150 VBA  
 • Vespa VBB1T fino al telaio n.17450 - till chassis  
 n.17450  
 R.O. 83814, 020051



**CAVALLETTI CENTRALI - CENTRAL STANDS****121610920** **NEW**

Zincato Ø 16 mm | Galvanized Ø 16 mm  
 Senza piedini | Without stand feet  
 Vespa VGLA 150 fino al telaio n.032000 - till  
 chassis n.032000 • Vespa VGLB

**121611020**

Zincato Ø 15 mm | Galvanized Ø 15 mm  
 Ruota 8" | Wheel 8"  
 Senza piedini | Without stand feet  
 Vespa 125 VM2/VN/VU  
 R.O. 19555

**121610810**

Zincato Ø 20 mm | Galvanized Ø 20 mm  
 Ruota 10" | Wheel 10"  
 Senza piedini | Without stand feet  
 Vespa Sprint/GL/GT/Rally/GS 160 • Vespa 180SS  
 R.O. 91047

**121611051**

Zincato Ø 20 mm | Galvanized Ø 20 mm  
 Ruota 10" | Wheel 10"  
 Completo di piedini | With stand feet  
 Vespa Sprint • Vespa GL • Vespa GT • Vespa  
 Rally  
 Adattabile a - Suitable for Vespa GS 160 •  
 Vespa 180  
 R.O. 91047



## CAVALLETTI CENTRALI - CENTRAL STANDS

121611052



Cromato Ø 20 mm | *Chromed Ø 20 mm*

Ruota 10" | *Wheel 10"*

Completo di piedini | *With stand feet*

Vespa Sprint • Vespa GL • Vespa GT • Vespa Rally

Adattabile a - *Suitable for Vespa GS 160 •*

Vespa 180

R.O. 91047



## ACCESSORI CAVALLETTI - STANDS ACCESSORIES

121890030



MOLLA CAVALLETTO | *STAND SPRING*

Lunghezza 136 mm | *Length 136 mm*

Diametro Ø 19 mm | *Diameter Ø 19 mm*

Vespa 50-90-125 Primavera • Vespa 50-90-125

Primavera • Vespa TS

R.O. 277269, 077269



121890040



MOLLA CAVALLETTO | *STAND SPRING*

Lunghezza 122 mm | *Length 122 mm*

Diametro Ø 17 mm | *Diameter Ø 17 mm*

Vespa PK • Vespa PK XL • Vespa Rush • Vespa

FL • Vespa N • Vespa HP

R.O. 216255



121890050



MOLLA CAVALLETTO | *STAND SPRING*

Lunghezza 121 mm | *Length 121 mm*

Diametro Ø 32 mm | *Diameter Ø 32 mm*

Vespa PX PE • Vespa PX PE Arcobaleno • Vespa

GL • Vespa Sprint • Vespa Sprint Veloce • Vespa

200 Rally

R.O. 176444, 070994



**ACCESSORI CAVALLETTI - STANDS ACCESSORIES****121890080**

MOLLA CAVALLETTO | *STAND SPRING*  
 Lunghezza 155 mm | *Length 155 mm*  
 Diametro Ø 17 mm | *Diameter Ø 17 mm*  
 Cosa 125-150-200  
 R.O. 257430, 252906

**121890090**

MOLLA CAVALLETTO | *STAND SPRING*  
 Lunghezza 112 mm | *Length 112 mm*  
 Diametro Ø 17 mm | *Diameter Ø 17 mm*  
 Vespa 125 T5 • Vespa PX 125-150 (\*11)  
 R.O. 176444, 175031

**121830630**

TAMPONE CAVALLETTO | *CENTRAL STAND*  
*BUFFER*

Diametro Ø 22 mm | *Diameter Ø 22 mm*  
 Materiale Gomma | *Material Rubber*  
 Colore Nero | *Colour Black*  
 Vespa PX 125-150-200 Arcobaleno • Vespa 125  
 T5  
 R.O. 176167, 174919

**121830140**

GOMMINI CAVALLETTO | *RUBBER PADS*  
 Diametro Ø 20 mm | *Diameter Ø 20 mm*  
 Materiale Gomma | *Material Rubber*  
 Colore Nero | *Colour Black*  
 Vespa 50 • Vespa 90 • Vespa 125 Primavera •  
 Vespa ET3  
 R.O. 135387



121830150



GOMMINI CAVALLETTO | RUBBER PADS

Diametro Ø 22 mm | Diameter Ø 22 mm

Materiale Gomma | Material Rubber

Colore Nero | Colour Black

Confezione 2 pezzi | 2 pcs pack

Vespa PK-PK 50XL/FL/Rush/N/HP • Vespa PX

PE • Vespa PX PE Arcobaleno • Vespa 125 T5 •

Cosa

R.O. 176166



121830152



GOMMINI CAVALLETTO | RUBBER PADS

Diametro Ø 22 mm | Diameter Ø 22 mm

Materiale Gomma | Material Rubber

Colore Nero | Colour Black

Confezione 6 pezzi | 6 pcs pack

Vespa PK-PK 50XL/FL/Rush/N/HP • Vespa PX

PE • Vespa PX PE Arcobaleno • Vespa 125 T5 •

Cosa

R.O. 176166



121830159



GOMMINI CAVALLETTO | RUBBER PADS

Diametro Ø 20 mm | Diameter Ø 20 mm

Materiale Gomma | Material Rubber

Colore Nero | Colour Black

Confez. Industriale 100 Cp. | Packing 100 pcs

Vespa PK-PK 50XL/FL/Rush/N/HP • Vespa PX

PE • Vespa PX PE Arcobaleno • Vespa 125 T5 •

Cosa

R.O. 135387



121830540



GOMMINI CAVALLETTO | RUBBER PADS

Diametro Ø 20 mm | Diameter Ø 20 mm

Vespa GTR • Vespa TS • Vespa Sprint • Vespa

GT • Vespa Super • Vespa 180-200 Rally

R.O. 54146, 54147



## ACCESSORI CAVALLETTI - STANDS ACCESSORIES

**121619130**COPPIA PIASTRINE CAVALLETTO CENTRALE |  
CENTRAL STAND BRACKETS

Diametro Ø 20 mm | Diameter Ø 20 mm

2 pezzi | 2 pieces

Vespa 50-90 • Vespa 125 Primavera • Vespa  
ET3 • Vespa tutti i modelli compresi nella  
produzione dal '66 al '76 - all models produced  
between '66 and '76

R.O. 135389, 135390

**121619140**COPPIA PIASTRINE CAVALLETTO CENTRALE |  
CENTRAL STAND BRACKETS

Diametro Ø 22 mm | Diameter Ø 22 mm

2 pezzi | 2 pieces

Vespa PX PE-PX PE Arcobaleno • Vespa 125 T5

R.O. 176167, 176168, 258733

**121619210**COPPIA PIASTRINE CAVALLETTO CENTRALE |  
CENTRAL STAND BRACKETS

Diametro Ø 22 mm | Diameter Ø 22 mm

2 pezzi | 2 pieces

Vespa GL • Vespa 150 Sprint • Vespa 200 Rally

R.O. 77086, 77087

**121619220**COPPIA PIASTRINE CAVALLETTO CENTRALE |  
CENTRAL STAND BRACKETS

Diametro Ø 16 mm | Diameter Ø 16 mm

2 pezzi | 2 pieces

Vespa 50 L/N/R • Vespa 90 • Vespa 125 VMA1T  
( '65-'67)

R.O. 135390, 135390



## ACCESSORI CAVALLETTI - STANDS ACCESSORIES

121619230



COPPIA PIASTRINE CAVALLETTO CENTRALE |

*CENTRAL STAND BRACKETS*

Diametro Ø 15 mm | *Diameter Ø 15 mm*

2 pezzi | *2 pieces*

Vespa 150 GS VS4-5T

R.O. 82689



121619250



COPPIA PIASTRINE CAVALLETTO CENTRALE |

*CENTRAL STAND BRACKETS*

Diametro Ø 22 mm | *Diameter Ø 22 mm*

Vespa PK XL • Vespa PK • Vespa FL • Vespa

Rush • Vespa N • Vespa HP

R.O. 233120, 258734



## LAMIERATI - REPAIR SHEETS

142680780



LAMIERATO SCUDO E PEDANA | *REPAIR SHEET*

*LEGSCHILD AND FLOOR*

Dimensioni 1260x420 mm | *Dimensions*

*1260x420 mm*

Senza rinforzi | *Without reinforcement*

Non verniciato | *Not painted*

1 "X"

Vespa 50 R-L • Vespa 125 Primavera Et3



FORO TONDO PER PEDALE FRENO  
*Rounded hole for brake pedal*



**LAMIERATI - REPAIR SHEETS****142680790****LAMIERATO SCUDO E PEDANA | REPAIR SHEET**  
**LEGSHIELD AND FLOOR**Dimensioni 1260x420 mm | *Dimensions*  
1260x420 mmSenza rinforzi | *Without reinforcement*Non verniciato | *Not painted*  
1 "X"

Vespa 50 Special ('69-'83)

○ **FORO TONDO PER PEDALE FRENO**  
*Rounded hole for brake pedal***142680800****LAMIERATO SCUDO E PEDANA | REPAIR SHEET**  
**LEGSHIELD AND FLOOR**Dimensioni 1270x460 mm | *Dimensions*  
1270x460 mmSenza rinforzi | *Without reinforcement*Oliato | *Oiled*  
2 "X"Vespa Sprint • Vespa GT • Vespa GTR • Vespa  
Rally! **FORO PER PEDALE FRENO ASSENTE**  
*Without brake pedal hole*

142680810



LAMIERATO SCUDO E PEDANA | *REPAIR SHEET*  
 LEGSHIELD AND FLOOR

Dimensioni 1260x460 mm | *Dimensions*  
 1260x460 mm

Senza rinforzi | *Without reinforcement*

Oliato | *Oiled*

2 "X"

Vespa VNA1-2T VNB VBA VBB



! FORO PER PEDALE FRENO ASSENTE  
*Without brake pedal hole*

142680820



LAMIERATO SCUDO E PEDANA | *REPAIR SHEET*  
 LEGSHIELD AND FLOOR

Dimensioni 1290x465 mm | *Dimensions*  
 1290x465 mm

Con rinforzi saldati | *With welded*  
*reinforcements*

Non verniciato | *Not painted*

1 "X"

Vespa PX



□ FORO QUADRATO PER PEDALE FRENO  
*Squared hole for brake pedal*

**LAMIERATI - REPAIR SHEETS****142680841** **NEW**

COFANO POSTERIORE DESTRO | *RIGHT SIDE*  
PANEL

Vespa PX 80-125-150-200E Arcobaleno • Vespa  
P X80-200E Lusso/ '98/MY/T5  
Adatto per - *Suitable for* LML Star 125-200 2T/  
4T  
R.O. 5775136 (Piaggio), SF524-0821 (LML)

**142680842** **NEW**

COFANO POSTERIORE SINISTRO | *LEFT SIDE*  
PANEL

Vespa PX 80-125-150-200E Arcobaleno • Vespa  
P X80-200E Lusso/ '98/MY/T5  
Adatto per - *Suitable for* LML Star 125-200 2T/  
4T  
R.O. 5758016 (Piaggio), C-4727250,C-4721371  
(LML)



142681000



COPPIA ANGOLARI RINFORZO PEDANA |  
FLOOR BOARD REINFORCEMENT

Dimensioni 110x85 mm | Dimensions 110x85  
mm

2 pezzi | 2 pieces

Vespa 50 • Vespa 125 Primavera • Vespa ET3



142681010



KIT TRAVERSINE DI RINFORZO | FLOOR BOARD  
REINFORCEMENT

Lunghezza 390 mm | Length 390 mm

Per scudo cod. RMS - For front shield RMS code  
142680780, 142680790



**LAMIERATI - REPAIR SHEETS****142681020****KIT TRAVERSINE DI RINFORZO | FLOOR BOARD REINFORCEMENT**Dimensioni 440x35 mm | *Dimensions 440x35 mm*Per scudo cod. RMS - *For front shield RMS code 142680800, 142680810***142681028****NEW****PEDANA | FLOOR BOARD**Dimensioni 800x500 mm | *Dimensions 800x500 mm*Piegata, con 5 traverse con passacavo trapezoidale | *Bended, with 5 reinforcements and trapezoidal wiring passage*Oliato | *Oiled*

Vespa 125 V30-33/VM/VN1T/VU/150 VL1T

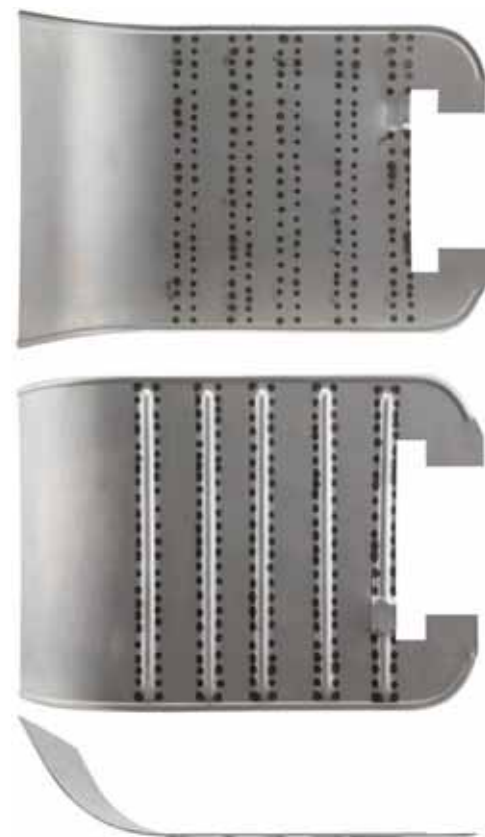

142681030 **NEW**



PEDANA | FLOOR BOARD

Dimensioni 800x492 mm | Dimensions

800x492 mm

Piegata, con 5 traverse | Bended, with 5

reinforcements

Oliato | Oiled

Vespa 150 VB1T • Vespa 150 VL2/3T • Vespa

125 VN2T

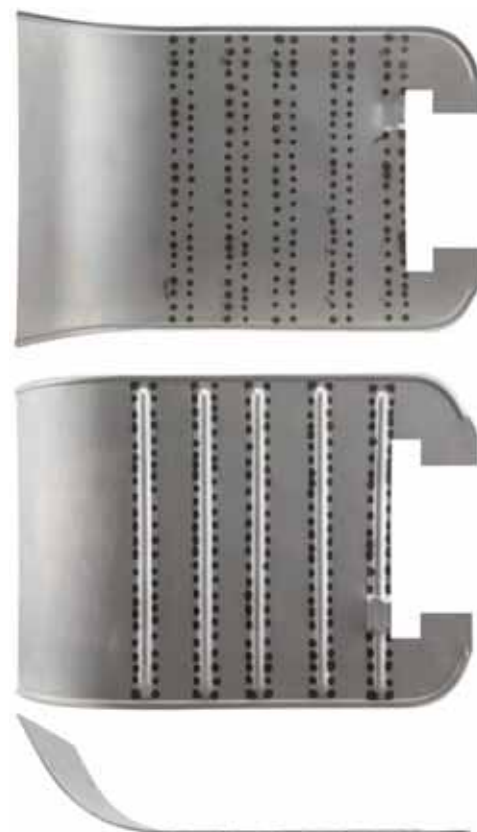

142681032 **NEW**



PEDANA | FLOOR BOARD

Dimensioni 700x472 mm | Dimensions 700x472

mm

Piegata, con 3 traverse con passacavo

trapezoidale | Bended, with 3 reinforcements

and trapezoidal wiring passage

Oliato | Oiled

2 "X"

Vespa 125 VNA ('59-'60) • Vespa 150 VBA ('58)



**LAMIERATI - REPAIR SHEETS****142681034** **NEW**

PEDANA | FLOOR BOARD

Dimensioni 700x472 mm | Dimensions 700x472 mm

Piegata, con 3 traverse con passacavo trapezoidale | Bended, with 3 reinforcements and trapezoidal wiring passage

Oliato | Oiled

2 "X"

Vespa 125 VNB1 ('59-'61) • Vespa 150 VBA1 ('58)

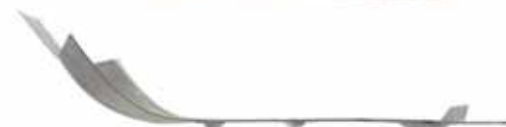
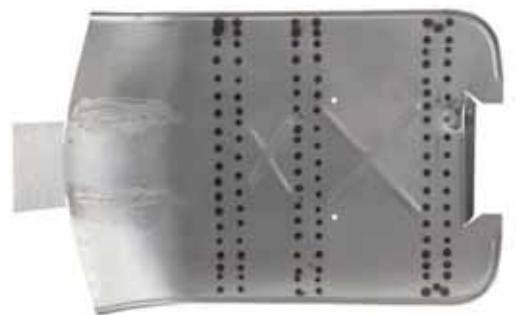
**142681036** **NEW**

PEDANA | FLOOR BOARD

Dimensioni 700x472 mm | Dimensions 700x472 mm

Piegata, con 3 traverse con passacavo trapezoidale | Bended, with 3 reinforcements and trapezoidal wiring passage

Oliato | Oiled

2 "X"

Vespa 150 VBB1T ('60-'62)

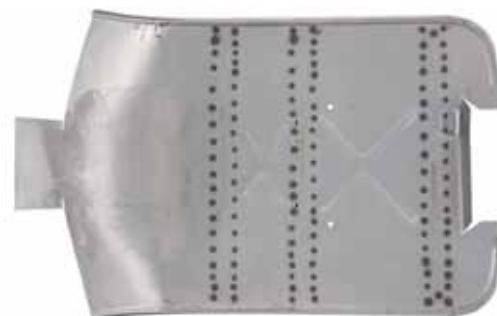

142681038 **NEW**



PEDANA | FLOOR BOARD

Dimensioni 700x470 mm | Dimensions 700x470 mm

Piegata, con 3 traverse, passacavo Ø20mm | Bended, with 3 reinforcements, wiring fairlead Ø20mm

Oliato | Oiled  
2 "X"

Vespa 125 VNB2-6T • Vespa 150 VBB2T • Vespa 150 GL VGLA/B

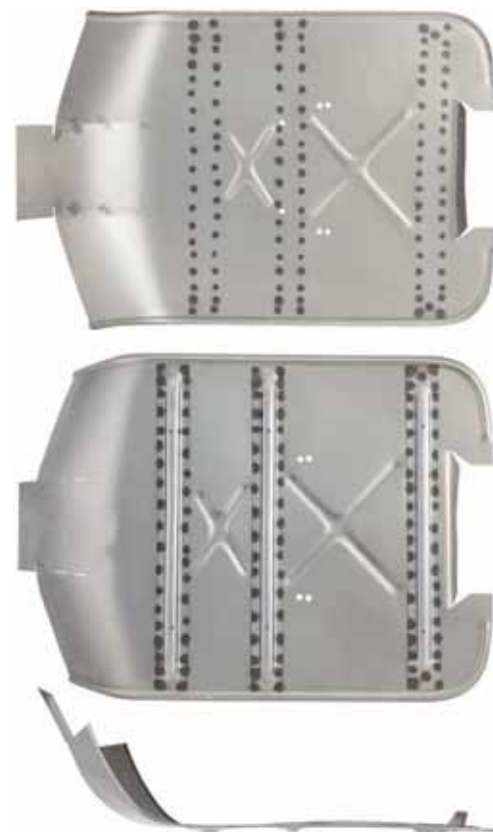

142681040 **NEW**



PEDANA | FLOOR BOARD

Dimensioni 700x472 mm | Dimensions 700x472 mm

Piegata, con 3 traverse con passacavo trapezoidale | Bended, with 3 reinforcements and trapezoidal wiring passage

Oliato | Oiled  
2 "X"

Vespa 150 GL VLA • Vespa 180 Rally VSD •  
Vespa 125 Super VNC • Vespa 150 Super VBC •  
Vespa 150 Sprint VLB





**LAMIERATI - REPAIR SHEETS****142681042** **NEW**

PEDANA | FLOOR BOARD

Dimensioni 700x463 mm | *Dimensions 700x463 mm*Piegata, con 3 traverse con passacavo |  
*Bended, with 3 reinforcements and wiring passge*Oliato | *Oiled*  
2 "X"Vespa 125 GT/GTR • Vespa TS • Vespa Sprint  
150 • Vespa Rally 180-200**142681045** **NEW**

PEDANA | FLOOR BOARD

Dimensioni 700x462 mm | *Dimensions 700x462 mm*Fori per pedale freno e poggia piedi, con 2  
traverse | *With brake pedal and footpegs holes, bended, 2 reinforcements*Oliato | *Oiled*  
1 "X"

Vespa P 125-150-200X

Adatto per - *Suitable for* Vespa PX 80-200 •  
Vespa PE • Vespa Lusso • Vespa '98 • Vespa  
MY Vespa T5

142681048 **NEW**



PEDANA | FLOOR BOARD

Dimensioni 700x462 mm | Dimensions 700x462 mm

Fori per pedale freno e poggipiedi, con 2 traverse | With brake pedal and footpegs holes, bended, 2 reinforcements

Oliato | Oiled

1 "X"

Vespa PX 80-200E Lusso • Vespa '98 • Vespa MY • Vespa T5

Adatto per - Suitable for LML Star 125-150 2T/ Deluxe

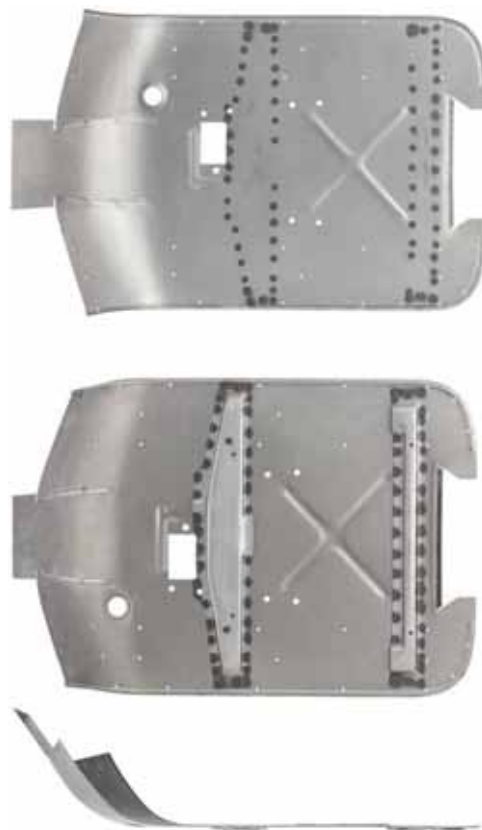

142681049 **NEW**



PEDANA | FLOOR BOARD

Dimensioni 700x462 mm | Dimensions 700x462 mm

Fori per pedale freno e poggipiedi, con 2 traverse | With brake pedal and footpegs holes, bended, 2 reinforcements

Oliato | Oiled

1 "X"

Vespa PX 80-200E Lusso • Vespa '98 • Vespa MY • Vespa T5

Adatto per - Suitable for LML Star 125-150 2T/ Deluxe



**LAMIERATI - REPAIR SHEETS****142681052** **NEW**

PEDANA | FLOOR BOARD

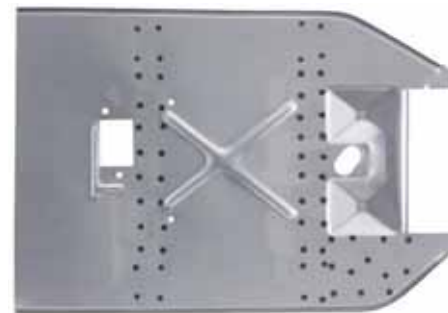
Dimensioni 600x420 mm | Dimensions  
600x420 mmCon 2 traverse di rinforzo | With 2  
reinforcements  
1 "X"Vespa 50 N/L/R • Vespa 90 • Vespa 125  
Primavera Et3 • Vespa 50-90 SS**142681182** **NEW**

PEDANA | FLOOR BOARD

Lunghezza 90 cm | Length 90 cm  
con fori | with holes

Vespa 50 N/R dal'66 in poi - from '66 onwards

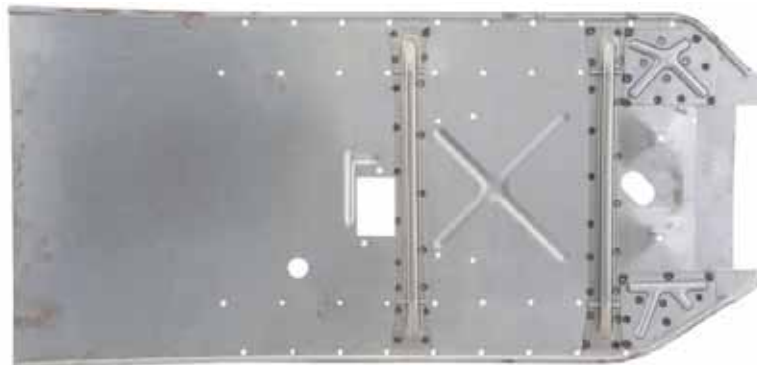

142681183

NEW



PEDANA | FLOOR BOARD

Lunghezza 90 cm | Length 90 cm

senza fori | without holes

Vespa 50 Special • Vespa 125 Primavera •

Vespa 125 Primavera ET3



142681184

NEW



PEDANA | FLOOR BOARD

Lunghezza 70 cm | Length 70 cm

senza fori | without holes

Vespa 50 Special • Vespa 125 Primavera •

Vespa 125 Primavera ET3

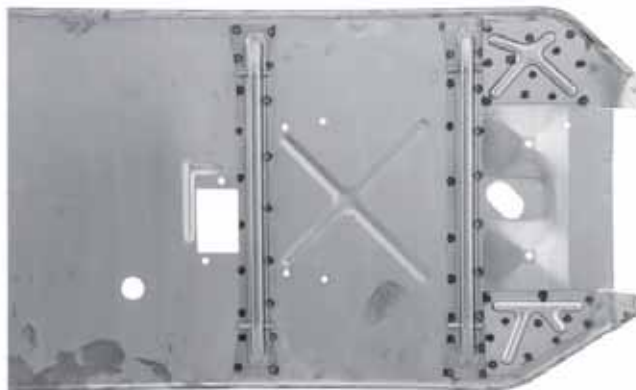
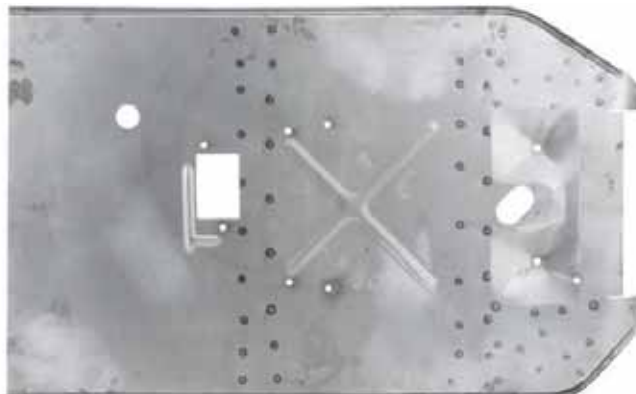

**LAMIERATI - REPAIR SHEETS****142681058** **NEW**

TRAVERSA DI RINFORZO PEDANA | *FLOOR*  
 BOARD REINFORCEMENT

1 pezzo | *1 piece*

Con passacavo trapezoidale | *With trapezoidal*  
*wiring passage*

Vespa 125 V30-V33 • Vespa 125 VM/VN • Vespa  
 150 VL • Vespa 150 VB1

Adatto per modelli - *Suitable for Hoffmann/*  
*ACMA/Douglas/Allstate*

**142681059** **NEW**

TRAVERSA DI RINFORZO PEDANA | *FLOOR*  
 BOARD REINFORCEMENT

1 pezzo | *1 piece*

Vespa 98 • Vespa 125 V1-15/V30-33/VM/VN •  
 Vespa 150 VL/VB1



142681061 **NEW**



TRAVERSA DI RINFORZO POSTERIORE PEDANA  
| REAR FLOOR BOARD REINFORCEMENT

1 pezzo | 1 piece

Vespa 125 VNA/VNB • Vespa 125 Super/GT/  
GTR/TS • VESPA 150 VBA/VBB/VLA-B/ Sprint/V.  
• Vespa 180 SS • Vespa 180-200Rally • Vespa P  
125-150-200X



142681062 **NEW**



TRAVERSA DI RINFORZO PEDANA | FLOOR  
BOARD REINFORCEMENT

Dimesnioni 430x70 mm | Dimensions 430x70  
mm

1 pezzo | 1 piece

Vespa PX 80-200E Lusso • Vespa '98 • Vespa  
MY • Vespa T5



**LAMIERATI - REPAIR SHEETS****142681063** **NEW**

TRAVERSA DI RINFORZO POSTERIORE PEDANA  
| *REAR FLOOR BOARD REINFORCEMENT*  
Dimensioni 420x45 mm | *Dimensions 420x45 mm*

Vespa PX 80-200E Lusso • Vespa '98 • Vespa MY • Vespa T5

**142681064** **NEW**

TRAVERSA DI RINFORZO POSTERIORE PEDANA  
| *REAR FLOOR BOARD REINFORCEMENT*  
Vespa PK 50-125 S/XL/XL2



142681189

NEW



TRAVERSA DI RINFORZO PEDANA QUADRATA |  
SQUARED FLOOR BOARD REINFORCEMENT

Vespa 50 N/L/R • Vespa 50 Special • Vespa 125  
Primavera • Vespa 125 Primavera ET3 dal '63 in  
poi - *from '63 onwards*



142681065

NEW



TUNNEL CENTRALE | TUNNEL MIDDLE PART

Senza lati | *Without sides*

Vespa 125 VNA-TS • Vespa 150 VBA-Super •  
Vespa 160 GS • Vespa 180 SS • Vespa Rally •  
Vespa PX 80-200 • Vespa PE • Vespa Lusso •  
Vespa T5

Adatto per - *Suitable for* LML Star 125-150 2T/  
Deluxe





**LAMIERATI - REPAIR SHEETS****142681066** **NEW****TUNNEL LATERALE DESTRO** | *TUNNEL RIGHT SIDE*Vespa 125 VNA-TS • Vespa 150 VBA-Super •  
Vespa 160 GS • Vespa 180 SS • Vespa Rally •  
Vespa PX 80-200 • Vespa PE • Vespa Lusso •  
Vespa T5Adatto per - *Suitable for* LML Star 125-150 2T/  
Deluxe**142681067** **NEW****TUNNEL LATERALE SINISTRO** | *TUNNEL LEFT SIDE*Vespa 125 VNA-TS • Vespa 150 VBA-Super •  
Vespa 160 GS • Vespa 180 SS • Vespa Rally •  
Vespa PX 80-200 • Vespa PE • Vespa Lusso •  
Vespa T5Adatto per - *Suitable for* LML Star 125-150 2T/  
Deluxe

142681068 **NEW**



**TUNNEL COMPLETO** | *TUNNEL COMPLETE*  
 Due componenti laterali e uno centrale, non saldati | *Two side parts and one middle part, not welded*

Vespa 125 VNA-TS • Vespa 150 VBA-Super •  
 Vespa 160 GS • Vespa 180 SS • Vespa Rally •  
 Vespa PX 80-200 • Vespa PE • Vespa Lusso •  
 Vespa T5

Adatto per - *Suitable for* LML Star 125-150 2T/  
 Deluxe



142681069 **NEW**



**TUNNEL LATERALE SINISTRO** | *TUNNEL LEFT SIDE*

Vespa 125 VNA-TS • Vespa 150 VBA-Super •  
 Vespa 160 GS • Vespa 180 SS • Vespa Rally •  
 Vespa PX 80-200 • Vespa PE • Vespa Lusso •  
 Vespa T5

Adatto per - *Suitable for* LML Star 125-150 2T/  
 Deluxe



**LAMIERATI - REPAIR SHEETS****142681070****NEW****TUNNEL LATERALE DESTRO** | *TUNNEL RIGHT SIDE*Vespa 125 VNA-TS • Vespa 150 VBA-Super •  
Vespa 160 GS • Vespa 180 SS • Vespa Rally •  
Vespa PX 80-200 • Vespa PE • Vespa Lusso •  
Vespa T5Adatto per - *Suitable for* LML Star 125-150 2T/  
Deluxe**142681071****NEW****TUNNEL CENTRALE** | *TUNNEL MIDDLE PART*Vespa 125 VNA-TS • Vespa 150 VBA-Super •  
Vespa 160 GS • Vespa 180 SS • Vespa Rally •  
Vespa PX 80-200 • Vespa PE • Vespa Lusso •  
Vespa T5Adatto per - *Suitable for* LML Star 125-150 2T/  
Deluxe

142681113

NEW



RINFORZO INTERNO, LATO FRIZIONE |  
REINFORCEMENT INSIDE, CLUTCH SIDE

Vespa V50 N/L/R/S/Special/SR/SS • Vespa 90SS



142681114

NEW



RINFORZO INTERNO CENTRALE |  
REINFORCEMENT INSIDE MIDDLE PART

Vespa V50 N/L/R/S/Special/SR/SS • Vespa 90SS



**LAMIERATI - REPAIR SHEETS****142681115****NEW**

RINFORZO INTERNO, LATO VOLANO I  
*REINFORCEMENT INSIDE, FLYWHEEL SIDE*  
Vespa V50 N/L/R/S/Special/SR/SS • Vespa 90SS

**142681116****NEW**

RINFORZO INTERNO, LATO VOLANO I  
*REINFORCEMENT INSIDE, FLYWHEEL SIDE*  
Vespa V50 N/L/R/S/Special/SR/SS • Vespa 90SS



142681136

NEW



SUPPORTO BATTERIA | *BATTERY MOUNT*  
 Vespa 125 VNB/GT/R/Super • Vespa 150 VBA/  
 VBB/VGLA/GL/Sprint/V/Super



142681138

NEW



PIASTRINA IMPIANTO ELETTRICO | *HOLDING  
 PLATE WIRING LOOM*  
 Vespa 125 Primavera • Vespa ET3



**LAMIERATI - REPAIR SHEETS****142681165****NEW**SPORTELLO MOTORE NON VERNICIATO |  
*ENGINE DOOR NOT PAINTED*Vespa 50 3° serie/L/R/N • Vespa 50 Special •  
Vespa SS/90 • Vespa R/SS • Vespa 100 • Vespa  
125 Primavera • Vespa 125 ET3**FORCELLE - FORKS****121570050**Vespa PK 50 • Vespa FL2 • Vespa PK 125FL  
R.O. 266303

**121570080**



Vespa 50 Rush • Vespa N • Vespa PK • Vespa  
PK 125XL  
R.O. 265752



**121570090**



Perno Ø16 mm | *Pin Ø16 mm*  
Asse ruota Ø18 mm | *Wheel axle Ø18 mm*  
Perno sterzo Ø 32 mm | *Steering axle Ø 32 mm*  
Vespa PX 125-150-200 1° serie (Fino al 1981 -  
*Until 1981*)  
R.O. 183435, 174118



**121570100**



Perno Ø20 mm | *Pin Ø20 mm*  
Asse ruota Ø22 mm | *Wheel axle Ø22 mm*  
Perno sterzo Ø 34 mm | *Steering axle Ø 34 mm*  
Vespa PX 125-150-200 ('82>)  
R.O. 178050





**FORCELLE - FORKS****121570110**

Vespa PK 50 Automatica • Vespa Plurimatic  
R.O. 244830

**121570120**

Perno Ø20 mm | *Pin Ø20 mm*  
Asse ruota Ø22 mm | *Wheel axle Ø22 mm*  
Perno sterzo Ø 36 mm | *Steering axle Ø 36 mm*  
Vespa PX 125-150-200 Arcobaleno  
R.O. 216744

**121570150**

Vespa 50-90 • Vespa 125 Primavera • Vespa  
125 ET3  
R.O. 183678, 13320, 099370, 099371, 100603,  
152329



## FORCELLE - FORKS

121570820 **NEW**



Vespa 50 L-R • Vespa 125 Primavera • Vespa  
125 Primavera ET3  
R.O. 183678, 13320, 099370, 099371, 100603,  
152329



## SERIE STERZO - STEERING HEAD BEARING SETS

184220010



184220011



SUPERIORE | UPPER

Ø sede cuscinetto telaio 31x36,55-42,90 mm |

Ø bearing frame seat 31x36,55-42,90 mm

Ø sfere 4,0 mm | Ø spheres 4,0 mm

Vespa 50-90 • Vespa 125 Primavera • Vespa  
125 ET3 • Vespa 150 Sprint • Vespa Super •  
Vespa TS • Vespa PX 125-150-200 • Vespa Rally  
• Vespa PK 50-125 • Cosa • Vespa T5

R.O. 56002R, 65069345, 154698, CM061303,  
650693



184220020



184220021



INFERIORE | LOWER

Ø sede cuscinetto telaio 36,7x64mm | Ø

bearing frame seat 36,7x64mm

Ø sede cuscinetto piantone 35x46,8 mm | Ø

bearing steering column seat 35x46,8 mm

Ø rondella copripolvere 35x63 mm | Ø dust  
seal 35x63mm

Vespa 50-90 • Vespa 125 Primavera • Vespa  
125 ET3 • Vespa 150 Sprint • Vespa Super •  
Vespa TS • Vespa PX 125-150-200 • Vespa Rally  
• Vespa PK 50-125 • Cosa • Vespa T5

R.O. 56003R, 153024, CM061304, 650075



**SERIE STERZO - STEERING HEAD BEARING SETS****184220100****184220101****184220013**

COMPLETA | COMPLETE

Ø sede cuscinetto telaio superiore 31x36,55-42,90 mm | Ø upper bearing frame seat 31x36,55-42,90 mm

Ø sede cuscinetto telaio inferiore 36,7x64mm | Ø lower bearing frame seat 36,7x64mm

Ø sede cuscinetto piantone 35x46,8 mm | Ø bearing steering column seat 35x46,8 mm

Ø rondella copripolvere 35x63 mm | Ø dust seal 35x63mm

Vespa 50-90 • Vespa 125 Primavera • Vespa 125 ET3 • Vespa 150 Sprint • Vespa Super • Vespa TS • Vespa PX 125-150-200 • Vespa Rally • Vespa PK 50-125 • Cosa • Vespa T5  
R.O. 153024, CM061304, 56003R, 650075, 650075 + 65069345, 154698, 56002R, CM061303, 650693

**184220300**

SUPERIORE | UPPER

Ø sede cuscinetto telaio 31x36,55-42,90 mm | Ø bearing frame seat 31x36,55-42,90 mm  
Ø sfere 4,0 mm | Ø spheres 4,0 mm

Vespa 50-90 • Vespa 125 Primavera • Vespa 125 ET3 • Vespa 150 Sprint • Vespa Super • Vespa TS • Vespa PX 125-150-200 • Vespa Rally • Vespa PK 50-125 • Cosa • Vespa T5  
R.O. CM061303, 65069345, 154698, 56002R, 650693

**184220583**

COMPLETA | COMPLETE

Ø sede cuscinetto telaio superiore 31x43mm | Ø upper bearing frame seat 31x43 mm

Ø sede cuscinetto telaio inferiore 36,7x43,5/64 mm | Ø lower bearing frame seat 36,7x43,5/64 mm

Ø sede cuscinetto forcella 35x53,7 mm | Ø fork bearing seat 35x53,7 mm

Vespa 125 VNA-VNB 3-VBA VBB 1T-VGLB 1T



## ACCESSORI SERIE STERZO - STEERING HEAD BEARING SET ACCESSORIES

### GROSSE SFERE - BALL SETS

**484120201**



1 Conf. Grosse sfere 1/8" (Tot. 144 Pz.) | 1 Grs  
ball set 1/8" (Tot. 144 Pcs)  
Vespa V30-V33-VM-VN-VL



**484120211**



1 Conf. Grosse sfere 5/32" (Tot. 144 Pz.) | 1 Grs  
ball set 5/32" (Tot. 144 Pcs)  
Vespa 125 VN/VNA/VNB1-3 fino al telaio  
n.061000 - till chassis n.061000 • Vespa 150  
VL • Vespa VB • Vespa VBA • Vespa VBB1 fino  
al telaio n.82819 - till chassis n.82819 • Vespa  
VGLA-B fino al telaio n. 041664 - till chassis  
n.041664 • Vespa ACMA • Vespa VGL1 • Vespa  
T1-4 • Vespa GS VS1-5 • Vespa PX 80-200E  
Lusso • Vespa ('98) • Cosa  
R.O. 14246



**484120231**



1 Conf. Grosse sfere 1/4" (Tot. 144 Pz.) | 1 Grs  
ball set 1/4" (Tot. 144 Pcs)  
Vespa V30-V33-VM-VN-VL



### GABBIETTE STERZO - BALL CAGES

**184240010**



GABBIETTE STERZO SUPERIORE SFERE 1/8" |  
UPPER BALL CAGES  
Confezione 50 Pz. | 50 Pcs Packing  
Vespa 50-125 • Vespa 125 ET3 • Vespa PK  
50-125 • Vespa Sprint • Vespa SS • Vespa PK  
XL • Vespa 125 VNB3 dal telaio n.061001 - from  
chassis n.061001 • Vespa GT • Vespa GTR •  
Vespa TS • Vespa Super • Vespa 150 VBB1 dal  
telaio n.82820 - from chassis n.82820 • Vespa  
VLB dal telaio n. 041665 - from chassis n.  
041665 • Vespa Sprint • Vespa Super • Vespa  
160 GS • Vespa 180 SS • Vespa Rally • Vespa PX  
80-200 • Vespa PE • Vespa ('98) • Vespa MY •  
Vespa ('11) • Vespa T5 • Cosa • LML 2-4T  
R.O. 077024



**ACCESSORI SERIE STERZO - STEERING HEAD BEARING SET ACCESSORIES****184240020**

GABBIETTE STERZO INFERIORE SFERE 1/4" |

LOWER BALL CAGES

Confezione 50 Pz. | 50 Pcs Packing

Vespa 50-125 • Vespa PV • Vespa ET3 • Vespa  
 PK 50-125 • Vespa S • Vespa SS • Vespa  
 XL • Vespa XL2 • Vespa 125 VNB3 dal telaio  
 n.061001 - from chassis n.061001 • Vespa GT •  
 Vespa GTR • Vespa TS • Vespa Super • Vespa  
 150 VBB1 dal telaio n.82820 - from chassis  
 n.82820 • Vespa VGLB dal telaio n.041665 -  
 from chassis n.041665 • Vespa Sprint • Vespa V  
 • Vespa Super • Vespa 160 GS • Vespa 180 SS  
 • Vespa Rally • Vespa PX 80-200 • Vespa PE •  
 Vespa Lusso • Vespa ('98) • Vespa MY • Vespa  
 ('11) • Vespa T5 • Cosa  
 R.O. 077023, 77023

**184240030**

GABBIETTE SUPERIORI 5/32" | UPPER BALL

CAGES 5/32"

Confezione 50 Pz. | 50 Pcs Packing

Per ricambio serie 184220300 | Spare Parts for 184220300

Vespa 50-125 • Vespa PV • Vespa ET3 • Vespa  
 PK 50-125 • Vespa S • Vespa SS • Vespa XL  
 • Vespa XL2 • Vespa 125 VNB3 dal telaio  
 n.061001 - from chassis n.061001 • Vespa GT •  
 Vespa GTR • Vespa TS • Vespa Super • Vespa  
 150 VBB1 dal telaio n.82820 - from chassis  
 n.82820 • Vespa VGLB dal telaio n.041665 -  
 from chassis n.041665 • Vespa Sprint • Vespa V  
 • Vespa Super • Vespa 160 GS • Vespa 180 SS  
 • Vespa Rally • Vespa PX 80-200 • Vespa PE •  
 Vespa Lusso • Vespa ('98) • Vespa MY • Vespa  
 ('11) • Vespa T5 • Cosa • LML 2-4T  
 R.O. 77023, 077023



## ACCESSORI SERIE STERZO - STEERING HEAD BEARING SET ACCESSORIES

**184240043**



KIT GABBETTE STERZO SFERE 1/4" ; 1/8" |  
UPPER BALL CAGES

Vespa 50-125 • Vespa PV • Vespa ET3 • Vespa  
PK 50-125 • Vespa S • Vespa SS • Vespa  
XL • Vespa XL2 • Vespa 125 VNB3 dal telaio  
n.061001 - from chassis n.061001 • Vespa GT •  
Vespa GTR • Vespa TS • Vespa Super • Vespa  
150 VBB1 dal telaio n.82820 - from chassis  
n.82820 • Vespa VGLB dal telaio n.041665 -  
from chassis n.041665 • Vespa Sprint • Vespa V  
• Vespa Super • Vespa 160 GS • Vespa 180 SS  
• Vespa Rally • Vespa PX 80-200 • Vespa PE •  
Vespa Lusso • Vespa ('98) • Vespa MY • Vespa  
(‘11) • Vespa T5 • Cosa  
R.O. 077023-077024



## CONTACHILOMETRI - SPEEDOMETERS

**163680004**



Scala 80 Km/h | 80 Km/h scale  
Completo di trasmissione e pignoncino  
rocchetto | With pinions and transmission  
Dimensioni Ø52 mm | Dimensions Ø52 mm  
Colore quadrante Bianco | Quadrant color  
White  
Colore cifre Nero | Number color Black  
Attacco filo 2,7 mm | Cable fit 2,7 mm  
Cornice Cromata | Frame Chromed  
Senza piastrina di fissaggio | Without mounting  
plate  
Vespa 50 N-R-L • Vespa 90  
R.O. 190748



**163680014**



Scala 80 Km/h | 80 Km/h scale  
Completo di trasmissione e pignoncino  
rocchetto | With pinions and transmission  
Dimensioni Ø84x73 mm | Dimensions  
Ø84x73 mm  
Colore quadrante Nero | Quadrant color Black  
Colore cifre Bianco | Number color White  
Attacco filo 2,7 mm | Cable fit 2,7 mm  
Cornice Cromata | Frame Chromed  
Vespa 50 Special ('69-'82)  
R.O. 123424



**CONTACHILOMETRI - SPEEDOMETERS****163680023**

Scala 90 Km/h | *90 Km/h scale*  
 Dimensioni Ø72x62 mm | *Dimensions*  
 Ø72x62 mm  
 Colore quadrante Bianco | *Quadrant color*  
 White  
 Colore cifre Nero | *Number color* Black  
 Attacco filo 2,7 mm | *Cable fit* 2,7 mm  
 Cornice Cromata | *Frame* Chromed  
 Vespa 125 VNA-VNB  
 R.O. 083205

**163680040**

Scala 120 Km/h | *120 Km/h scale*  
 Dimensioni Ø81x61 mm | *Dimensions*  
 Ø81x61 mm  
 Colore quadrante Nero | *Quadrant color* Black  
 Colore cifre Bianco | *Number color* White  
 Attacco filo 2,7 mm | *Cable fit* 2,7 mm  
 Alloggiamento di plastica | *Plastic casing*  
 Con illuminazione | *With lighting*  
 Vespa 125 Primavera ET3 • Vespa Sprint Veloce  
 • Vespa TS • Vespa 180-200 Rally  
 R.O. 141712

**163680044**

Scala 120 Km/h | *120 Km/h scale*  
 Completo di trasmissione e pignoncino  
 rocchetto | *With pinions and transmission*  
 Dimensioni Ø81x61 mm | *Dimensions*  
 Ø81x61 mm  
 Colore quadrante Nero | *Quadrant color* Black  
 Colore cifre Bianco | *Number color* White  
 Attacco filo 2,7 mm | *Cable fit* 2,7 mm  
 Alloggiamento di plastica | *Plastic casing*  
 Con illuminazione | *With lighting*  
 Vespa Sprint Veloce • Vespa TS • Vespa 180-  
 200 Rally  
 R.O. 141713



**163680053**



Scala 100 Km/h | 100 Km/h scale  
 Dimensioni Ø73x62 mm | Dimensions  
 Ø73x62 mm  
 Colore quadrante Verde/Nero | Quadrant color  
 Green/Black  
 Colore cifre Bianco | Number color White  
 Attacco filo 2,7 mm | Cable fit 2,7 mm  
 Cornice Cromata | Frame Chromed  
 Vespa VM-VN  
 R.O. 22743, 26263



**163680063**



Scala 90 Km/h | 90 Km/h scale  
 Dimensioni Ø73x62 mm | Dimensions  
 Ø73x62 mm  
 Colore quadrante Nero | Quadrant color Black  
 Colore cifre Bianco | Number color White  
 Attacco filo 1,9 mm | Cable fit 1,9 mm  
 Cornice Cromata | Frame Chromed  
 Vespa VM-VN-VL



**163680070**



Scala 120 Km/h | 120 Km/h scale  
 Dimensioni Ø81x61 mm | Dimensions  
 Ø81x61 mm  
 Colore quadrante Bianco | Quadrant color  
 White  
 Colore cifre Nero | Number color Black  
 Attacco filo 2,7 mm | Cable fit 2,7 mm  
 Alloggiamento di plastica | Plastic casing  
 Con illuminazione | With lighting  
 Vespa 125 Primavera ET3 • Vespa Sprint Veloce  
 • Vespa TS • Vespa 180-200 Rally  
 R.O. 141712





**CONTACHILOMETRI - SPEEDOMETERS****163680074**

Scala 120 Km/h | *120 Km/h scale*  
 Completo di trasmissione e pignoncino  
 rocchetto | *With pinions and transmission*  
 Dimensioni Ø81x61 mm | *Dimensions*  
 Ø81x61 mm  
 Colore quadrante Bianco | *Quadrant color*  
 White  
 Colore cifre Nero | *Number color Black*  
 Attacco filo 2,7 mm | *Cable fit 2,7 mm*  
 Alloggiamento di plastica | *Plastic casing*  
 Con illuminazione | *With lighting*  
 Vespa 125 Primavera • Vespa 125 Primavera  
 ET3  
 R.O. 141713

**163680093**

Scala 120 Km/h | *120 Km/h scale*  
 Completo di trasmissione e pignoncino  
 rocchetto | *With pinions and transmission*  
 Dimensioni Ø85 mm | *Dimensions Ø85 mm*  
 Colore quadrante Nero | *Quadrant color Black*  
 Colore cifre Giallo | *Number color Yellow*  
 Attacco filo 2,7 mm | *Cable fit 2,7 mm*  
 Cornice Nera | *Frame Black*  
 Vespa PX 125-150-200 • Vespa PE  
 R.O. 190523

**163680094**

Scala 120 Km/h | *120 Km/h scale*  
 Completo di trasmissione e pignoncino  
 rocchetto | *With pinions and transmission*  
 Dimensioni Ø85 mm | *Dimensions Ø85 mm*  
 Colore quadrante Nero | *Quadrant color Black*  
 Colore cifre Giallo | *Number color Yellow*  
 Attacco filo 2,7 mm | *Cable fit 2,7 mm*  
 Cornice Cromata | *Frame Chromed*  
 Vespa PX 125-150-200 • Vespa PE  
 R.O. 190523



**163680104**



Scala 60 Km/h | 60 Km/h scale  
 Completo di trasmissione e pignoncino  
 rocchetto | With pinions and transmission  
 Dimensioni Ø52 mm | Dimensions Ø52 mm  
 Colore quadrante Bianco | Quadrant color  
 White  
 Colore cifre Nero | Number color Black  
 Attacco filo 2,7 mm | Cable fit 2,7 mm  
 Cornice Cromata | Frame Chromed  
 Senza piastrina di fissaggio | Without mounting  
 plate  
 Vespa 50 N-R-L • Vespa 90  
 R.O. 190748



**163680114**



Scala 100 Km/h | 100 Km/h scale  
 Completo di trasmissione e pignoncino  
 rocchetto | With pinions and transmission  
 Dimensioni Ø112x69 mm | Dimensions  
 Ø112x69 mm  
 Colore quadrante Bianco | Quadrant color  
 White  
 Colore cifre Blu | Number color Blue  
 Attacco filo 2,7 mm | Cable fit 2,7 mm  
 Cornice Cromata | Frame Chromed  
 Vespa 150 VBA-VBB-GL  
 R.O. 089377



**163680120**



Scala 120 Km/h | 120 Km/h scale  
 Dimensioni Ø112x69 mm | Dimensions  
 Ø112x69 mm  
 Colore quadrante Bianco | Quadrant color  
 White  
 Colore cifre Blu | Number color Blue  
 Attacco filo 2,7 mm | Cable fit 2,7 mm  
 Cornice Cromata | Frame Chromed  
 Vespa 160 GS • Vespa 180 SS  
 R.O. 098473



**CONTACHILOMETRI - SPEEDOMETERS****163680123**

Scala 120 Km/h | *120 Km/h scale*  
 Completo di trasmissione | *With transmission*  
 Dimensioni Ø112x69 mm | *Dimensions*  
 Ø112x69 mm  
 Colore quadrante Bianco | *Quadrant color*  
 White  
 Colore cifre Blu | *Number color Blue*  
 Attacco filo 2,7 mm | *Cable fit 2,7 mm*  
 Cornice Cromata | *Frame Chromed*  
 Vespa 160 GS • Vespa 180 SS  
 R.O. 098473

**163680133**

Scala 110 Km/h | *110 Km/h scale*  
 Dimensioni Ø112x69 mm | *Dimensions*  
 Ø112x69 mm  
 Colore quadrante Bianco | *Quadrant color*  
 White  
 Colore cifre Blu | *Number color Blue*  
 Attacco filo 2,7 mm | *Cable fit 2,7 mm*  
 Cornice Cromata | *Frame Chromed*  
 Vespa GT • Vespa GTR • Vespa Sprint • Vespa  
 150 GL  
 R.O. 098844

**163680143**

Scala 120 Km/h | *120 Km/h scale*  
 Completo di trasmissione | *With transmission*  
 Dimensioni Ø112x69 mm | *Dimensions*  
 Ø112x69 mm  
 Colore quadrante Bianco | *Quadrant color*  
 White  
 Colore cifre Blu | *Number color Blue*  
 Attacco filo 2,7 mm | *Cable fit 2,7 mm*  
 Cornice Cromata | *Frame Chromed*  
 Vespa GS 160 • Vespa 180 SS



**163680153**



Scala 120 Km/h | *120 Km/h scale*  
 Completo di trasmissione | *With transmission*  
 Dimensioni Ø84x73 mm | *Dimensions*  
 Ø84x73 mm  
 Colore quadrante Bianco | *Quadrant color*  
 White  
 Colore cifre Bianco | *Number color* White  
 Attacco filo 2,7 mm | *Cable fit* 2,7 mm  
 Cornice Cromata | *Frame Chromed*  
 Vespa 50 Special  
 R.O. 123474



**163681103**



Scala 120 Km/h | *120 Km/h scale*  
 Dimensioni Ø70 mm | *Dimensions* Ø70 mm  
 Colore quadrante Nero | *Quadrant color* Black  
 Colore cifre Bianco | *Number color* White  
 Cornice Cromata | *Frame Chromed*  
 Vespa PK 50-125 • Vespa PK 50-125S  
 R.O. 179151, 178864, 196894, 196895, 196905,  
 197019



**163681113**



Scala 120 Km/h | *120 Km/h scale*  
 Dimensioni Ø70 mm | *Dimensions* Ø70 mm  
 Colore quadrante Nero | *Quadrant color* Black  
 Colore cifre Bianco | *Number color* White  
 Cornice Nera | *Frame* Black  
 Vespa PK 50-125 • Vespa PK 50-125S  
 R.O. 179151, 178864, 196894, 196895, 196905,  
 197019



**CONTACHILOMETRI - SPEEDOMETERS****163680163** **NEW**

Scala 160 km/h | 160 Km/h scale

Dimensioni Ø105 mm | Dimensions Ø105 mm

Colore quadrante Nero | Quadrant color Black

Colore cifre Bianco | Number color White

Cornice Cromata | Frame Chromed

Vespa PX 80-125-150-200E • Vespa PX Lusso •

Vespa T5 Classic

Adattabile per - Suitable for Vespa Plurimatic/

XLS • Vespa PK80 S Lusso • Vespa PK125 ETS/

XL/XL2

R.O. 227765

**163680173** **NEW**

Scala 120 Km/h | 120 Km/h scale

Dimensioni Ø105 mm | Dimensions Ø105 mm

Colore quadrante Nero | Quadrant color Black

Colore cifre Arancione | Number color Orange

Cornice Nera | Frame Black

Vespa PK 50S Lusso Vespa SS/Automatica/XL/

N/ Plurimatic/XLS • Vespa PK 80S Lusso • Vespa

PK125 ETS/XL/XL2

R.O. 226739

**ACCESSORI CONTACHILOMETRI - SPEEDOMETERS ACCESSORIES****121830013** **NEW**

TAMPONE IN GOMMA CONTACHILOMETRI |

SPEEDOMETER TRANSMISSION GROMMET

Vespa PK/S/XL/FL/HP/N/XL2/PX/T5 • Cosa

Adattabile a - Suitable for LML Star 125-200 2T/

4T/Star Lite 125

R.O. 174129 (Piaggio) 174129 (LML)



121859239 **NEW**



VITE CONTACHILOMETRI | SPEEDOMETER

SCREW

M5x50 mm

Vespa 50 Special/Elestart/SS • Vespa 90 SS •

Vespa 125 Primavera/Primavera ET3

R.O. S015624, S.15624



163680203



CORNICE CONTACHILOMETRI | SPEEDOMETER

RING

Dimensioni Ø73x63 mm | Dimensions

Ø73x63 mm

Cornice Cromata | Frame Chromed

Vespa VNA-VNB

R.O. 083204



163680213



CORNICE CONTACHILOMETRI | SPEEDOMETER

RING

In metallo | Metallic

Vespa 50 Special

R.O. 610355M



163680223



CORNICE CONTACHILOMETRI | SPEEDOMETER

RING

Dimensioni Ø73x63 mm | Dimensions

Ø73x63 mm

Cornice Cromata | Frame Chromed

Vespa V30-V33-VM-VN-VL

R.O. 83204



**ACCESSORI CONTACHILOMETRI - SPEEDOMETERS ACCESSORIES****163680233**CORNICE CONTACHILOMETRI | *SPEEDOMETER RING*Dimensioni Ø61x81 mm | *Dimensions Ø61x81 mm*Cornice Cromata | *Frame Chromed*Vespa 125 Primavera • Vespa ET3 • Vespa Sprint Veloce • Vespa GTR • Vespa TS  
R.O. 151837**163680243**CORNICE CONTACHILOMETRI | *SPEEDOMETER RING*Dimensioni Ø112x69 mm | *Dimensions Ø112x69 mm*Cornice Cromata | *Frame Chromed*Vespa 125-150 VBA-VBB • Vespa GL • Vespa GT • Vespa Sprint • Vespa 180 SS • Vespa GS 160  
R.O. 084202, 020211**163680253**CORNICE CONTACHILOMETRI | *SPEEDOMETER RING*Vespa 150 ('57-'58) • Vespa 150 GS ('55-'58)  
VB1-VS1-VS2-VS3-VS4  
R.O. 024817**163680303**TRASPARENTE CONTACHILOMETRI | *SPEEDOMETER TRANSPARENT*Dimensioni Ø51x61 mm | *Dimensions Ø51x61 mm*Vespa 125-150 V30-V33-VM-VN-VL  
R.O. 017713

**163680313**



TRASPARENTE CONTACHILOMETRI |  
SPEEDOMETER TRANSPARENT

Dimensioni Ø71x61 mm | Dimensions  
Ø71x61 mm

Vespa VB1-VS1-2  
R.O. 024818



**163680323**



TRASPARENTE CONTACHILOMETRI |  
SPEEDOMETER TRANSPARENT

Dimensioni Ø65x56 mm | Dimensions  
Ø65x56 mm

Vespa 125 VNA-VNB  
R.O. 083202



**163680333**



TRASPARENTE CONTACHILOMETRI |  
SPEEDOMETER TRANSPARENT

Dimensioni Ø106,5x63,5 mm | Dimensions  
Ø106,5x63,5 mm

Vespa 125-150 VBA-VBB • Vespa GL • Vespa GT  
• Vespa Sprint • Vespa 180 SS • Vespa GS 160  
R.O. 084803



**163680343**



TRASPARENTE CONTACHILOMETRI |  
SPEEDOMETER TRANSPARENT

Dimensioni Ø60x82 mm | Dimensions  
Ø60x82 mm

Vespa 125 Primavera • Vespa ET3 • Vespa  
Sprint Veloce • Vespa GTR • Vespa TS  
R.O. 100619





**ACCESSORI CONTACHILOMETRI - SPEEDOMETERS ACCESSORIES****163680353**

TRASPARENTE CONTACHILOMETRI |

SPEEDOMETER TRANSPARENT

In plastica | Plastic made

Vespa 50 Special

R.O. 610356M

**163680363****NEW**

PIASTRINA FISSAGGIO CAVI | CABLES HOLDER

Vespa 50/N/L/R/S/ SR/Revival • Vespa 90/R •

Vespa 100

R.O. 070695

**163681123****NEW**

GUARNIZIONE CONTACHILOMETRI |

SPEEDOMETER GASKET

Vespa 50 Special/Elestart

R.O. 151836

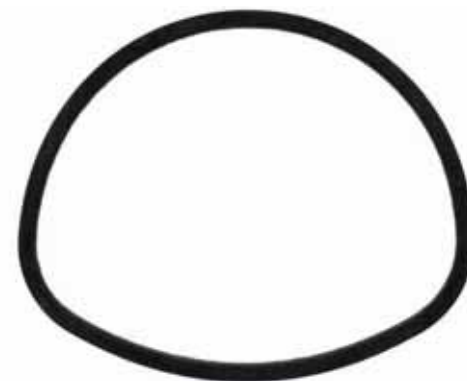
**163681133****NEW**

GUARNIZIONE CONTACHILOMETRI TONDO |

ROUND SPEEDOMETER GASKET

Dimensioni Ø46 mm | Dimensions Ø46 mm

Vespa 50 N/R/L



## ACCESSORI CONTACHILOMETRI - SPEEDOMETERS ACCESSORIES

163681143

NEW



GUARNIZIONE CONTACHILOMETRI I

SPEEDOMETER GASKET

Vespa 125 GT • Vespa 150 VBA/VBB/GL/Sprint/

GS VS5 • Vespa 160 GS • Vespa 180 SS

R.O. 49548



142680410



COPERCHIO CONTACHILOMETRI I

SPEEDOMETER COVER

Vespa 50 Special • Vespa Elestart

R.O. 123678



## PIGIONI CONTACHILOMETRI - SPEEDOMETERS PINIONS

163690030



12 Denti | 12 Teeth

Diametro Ø 13,1 mm | Diameter Ø 13,1 mm

Lunghezza 27,3 mm | Length 27,3 mm

Collegamento 2,7 mm | Connection 2,7 mm

Confezione 5 Pz. | 5 Pcs Packing

Vespa PX-PE (Fino al 1981 - Till 1981)

R.O. 174048



163690040



12 Denti | 12 Teeth

Diametro Ø 12 mm | Diameter Ø 12 mm

Collegamento 2,7 mm | Connection 2,7 mm

Confezione 5 Pz. | 5 Pcs Packing

Vespa PX PE Arcobaleno • Cosa

R.O. 177508, PX2371



**PIGNONI CONTACHILOMETRI - SPEEDOMETERS PINIONS****163690050**

8 Denti | 8 Teeth

Diametro Ø 11 mm | Diameter Ø 11 mm

Lunghezza 30,6 mm | Length 30,6 mm

Collegamento 2,7 mm | Connection 2,7 mm

Confezione 5 Pz. | 5 Pcs Packing

Vespa 50-90-125 • Vespa PK 50 • Vespa PK 50XL • Vespa Primavera • Vespa ET3

R.O. 151614

**163690060**

12 Denti | 12 Teeth

Collegamento 2,7 mm | Connection 2,7 mm

Confezione 10 Pz. | 10 Pcs Packing

Vespa PK 50 FL2 • Vespa PK 125 • Vespa PK 125XL • Vespa Rush • Vespa N

R.O. 217128

**163690070**

11 Denti | 11 Teeth

Diametro Ø 11,8 mm | Diameter Ø 11,8 mm

Lunghezza 44,3 mm | Length 44,3 mm

Collegamento 2,7 mm | Connection 2,7 mm

Confezione 5 Pz. | 5 Pcs Packing

Vespa 125 VNB5-VNB6 • Vespa 125 Super • Vespa 150 ('63-'66)

R.O. 93525

**163690080**

9 Denti | 9 Teeth

Diametro Ø 12/6 mm | Diameter Ø 12/6 mm

Lunghezza 43,8 mm | Length 43,8 mm

Collegamento 2,7 mm | Connection 2,7 mm

Vespa 125 GT • Vespa 150 Sprint • Vespa 150 GL • Vespa 150 GS ('59-'61) • Vespa 200 Rally

R.O. 98652, 019974B



## PIGIONI CONTACHILOMETRI - SPEEDOMETERS PINIONS

**163690090**



Diametro Ø 22,8 mm | *Diameter Ø 22,8 mm*  
 Vespa 50-90-125 • Vespa PK 50 • Vespa PK  
 50XL • Vespa Primavera • Vespa ET3  
 R.O. 151615



## CAVI TRASMISSIONE - TRANSMISSION CABLES

### CAVI GAS - THROTTLE CABLES

**163510011**



**163510019\***



Cavo standard | *Standard cable*  
 Diametro 1,2 mm | *Cable diameter 1,2 mm*  
 Lunghezza cavo 2000 mm | *Cable Length 2000 mm*  
 Terminale: Barilotto 2,8x3 mm | *Nipple type: Nipple 2,8x3 mm*  
 Confezione 10 pz | *Packaging 10 pcs*  
 \* Confezione 50 pz | *Packaging 50 pcs*  
 Vespa tutti i modelli | *All models*



**163510021**



**163510029\***



Cavo modificato | *Modified cable*  
 Diametro 1,2 mm | *Cable diameter 1,2 mm*  
 Lunghezza cavo 2000 mm | *Cable Length 2000 mm*  
 Terminale: Barilotto fisso al comando gas  
 5,5x6,5 mm | *Nipple type: Fixed pawl to throttle control 6,5x5 mm*  
 Confezione 10 pz | *Packaging 10 pcs*  
 \* Confezione 50 pz | *Packaging 50 pcs*  
 Vespa tutti i modelli dal 1958 fino alla Vespa PX  
 senza mix, eccetto Vespa 50, 125 Primavera,  
 ET3 | *All models from 1958 to Vespa PX without mix. Except Vespa 50, 125 Primavera, ET3*



**CAVI TRASMISSIONE - TRANSMISSION CABLES****CAVI FRIZIONE - CLUTCH CABLES****163514011****163514019\***Cavo standard | *Standard cable*Diametro 1,8 mm | *Cable diameter 1,8 mm*Lunghezza cavo 2500 mm | *Cable Length 2500 mm*Terminale: Barilotto 8x8 mm | *Nipple type: Big nipple 8x8 mm*Confezione 10 pz | *Packaging 10 pcs*\* Confezione 50 pz | *Packaging 50 pcs*Vespa tutti i modelli | *All models***163514021**Cavo standard | *Standard cable*Diametro 1,9 mm | *Cable diameter 1,9 mm*Lunghezza cavo 2000 mm | *Cable Length 2000 mm*Terminale: Nipplo tipo B 6x8 mm | *Nipple type: Type B nipple 6x8 mm*Confezione 10 pz | *Packaging 10 pcs*Per sostituire solo il cavo utilizzare il regolatore cod. 121858120 | *To replace only the cable, use the adjuster code 121858120*

Vespa PK • Vespa HP • Vespa PX PE 125-150-200 Arcobaleno • Vespa 125 T5

**CAVI CAMBIO - SHIFT CABLES****163516011****163516019\***Cavo standard | *Standard cable*Diametro 1,6 mm | *Cable diameter 1,6 mm*Lunghezza cavo 2000 mm | *Cable Length 2000 mm*Terminale: Barilotto 6,5x5,5 mm | *Nipple type: Big nipple 6,5x5,5 mm*Confezione 10 pz | *Packaging 10 pcs*\* Confezione 50 pz | *Packaging 50 pcs*Vespa tutti i modelli | *All models*

## CAVI TRASMISSIONE - TRANSMISSION CABLES

**163580010**



Diametro 2,0/7,0 mm | *Cable diameter*  
2,0/7,0 mm

Lunghezza cavo 1690 mm | *Cable Length*  
1690 mm

Lunghezza guaina: 1500 mm | *Sheath Length:*  
1500 mm

Vespa PK50 XL FL • Vespa HP • Vespa XL2 •  
Vespa PK125 N • Vespa XL2



**163516020**



Diametro 2,0 mm | *Cable diameter* 2,0 mm

Lunghezza cavo 1690 mm | *Cable Length*  
1690 mm

Vespa PK50 XL FL • Vespa HP • Vespa XL2 •  
Vespa PK125 N • Vespa XL2



## CAVI FRENO - BRAKE CABLES

**163518021**



**163518029\***



Freno posteriore | *Rear brake*

Diametro 3 mm | *Cable diameter* 3 mm

Lunghezza cavo 1000 mm | *Cable Length*  
1000 mm

Terminale: Occhiello stampato Ø6,5 mm |

*Nipple type: Printed eyelet* Ø6,5 mm

Confezione 10pz | *Packaging* 10 pcs

\* Confezione 50 pz | *Packaging* 50 pcs

Vespa tutti i modelli ('70-'15) | *All models*



**163550090** **NEW**



Freno anteriore | *Front brake*

Diametro 1,9 mm-7,0 mm | *Diametro* 1,9 mm-  
7,0 mm

Lunghezza cavo 1270 mm | *Cable Length*  
1270 mm

Lunghezza guaina 1150 mm | *Sleeve Length*  
1150 mm

Terminale: Barilotto | *Nipple type: Nipple*

Vespa PK50-80 S • Vespa Lusso • Vespa PX  
80-200 • Vespa PE • Vespa T5

R.O. 179642



**CAVI TRASMISSIONE - TRANSMISSION CABLES****CAVO STARTER - STARTER CABLE****163610040****NEW**Diametro 0,8 mm-5,0 mm | *Diametro 0,8 mm-5,0 mm*Lunghezza cavo 200 mm | *Cable Length 200 mm*Lunghezza guaina: 147 mm | *Sheath Length: 147 mm*Terminale: Barilotto | *Nipple type: Nipple*Vespa 50/N/L/R/S • Vespa Special • Vespa SS •  
Vespa 90/SS • Vespa PK 50/S/XL/Rush/Elestart  
• Vespa PK 125XL/Elestart

R.O. 982212

**163610060****NEW**Diametro 0,9 mm-5,0 mm | *Diametro 0,9 mm-5,0 mm*Lunghezza cavo 200 mm | *Cable Length 200 mm*Lunghezza guaina: 130 mm | *Sheath Length: 130 mm*Terminale: Barilotto | *Nipple type: Nipple*Vespa 50 S • Vespa PK50SS • Vespa PK 80-125S •  
Vespa PK 125 ETS • Vespa 100 (UK) • Vespa 125 Primavera •  
Vespa 125 Primavera ET3

R.O. 1523912

**163610120****NEW**Diametro 0,8 mm-5,0 mm | *Diametro 0,8 mm-5,0 mm*Lunghezza cavo 555 mm | *Cable Length 555 mm*Lunghezza guaina: 470 mm | *Sheath Length: 470 mm*Vespa PX 125-150-200 • Vespa VBA • Vespa VNB •  
Vespa VBB • Vespa TS • Vespa Sprint • Vespa Rally •  
Vespa GS

R.O. 92370

per modelli senza miscelatore - *for models without oil pump*

## CAVI TRASMISSIONE - TRANSMISSION CABLES

163610130

NEW



Diametro 0,9 mm-5,0 mm | *Diametro 0,9 mm-5,0 mm*

Lunghezza cavo 700 mm | *Cable Length 700 mm*

Lunghezza guaina: 630 mm | *Sheath Length: 630 mm*

Vespa PX • Vespa PX arcobaleno

R.O. 104292,667208

per modelli con freno a disco e miscelatore - *for models with brake disc and oil pump*



## KIT CAVI TRASMISSIONE - TRANSMISSION CABLES KITS

### KIT TRASMISSIONI GUAINE GRIGIE E CAVI COMPLETI STANDARD VESPA STANDARD VESPA TRANSMISSION KIT



Modello <i>Model</i>	CC	Codice RMS <i>RMS Code</i>	Codice a barre <i>Barcode</i>	OEM Gas <i>Throttle</i>	OEM Cambio <i>Gear</i>	OEM Frizione <i>Clutch</i>	OEM Freno Ant. <i>Front Brake</i>	OEM Freno Post. <i>Rear Brake</i>	OEM Starter Choke	OEM Contakm <i>Speedometer</i>
Vespa	50-90	163620010		139403	139402	192681	174164	174701	098221	071059
Vespa Primavera Et3	125	163620020		139403	139402	192681	174164	174701	152391	071059
Vespa GL-Sprint	125-150	163620030		139403	139402	192681	174164	174701	092370	099011
Vespa Px 1° Serie Tamburo	125-150-200	163620040		139403	139402	192681	174164	174701	092370	174161
Vespa Px Arcobaleno	125-150-200	163620050		139403	139402	192681	179642	191804	104292	179271
Vespa Px Disco	125-150-200	163620060		139403	139402	192681	-	191804	104292	563796
Vespa	50-90	163620190		139403	139402	192681	174164	174701	098221	-
Vespa Special	50	163620220		139403	139402	192681	174164	191804	098221	071059
Vespa Px 2 °Serie	125-150-200	163620170		139403	139402	192681	174164	191804	092370	174161





**KIT CAVI TRASMISSIONE - TRANSMISSION CABLES KITS****KIT TRASMISSIONI GUAINE GRIGIE E CAVI COMPLETI TEFLON® - TEFLON® TRANSMISSION KIT**

Modello Model	CC	Codice RMS RMS Code	Codice a barre Barcode	OEM Gas Throttle	OEM Cambio Gear	OEM Frizione Clutch	OEM Freno Ant. Front Brake	OEM Freno Post. Rear Brake	OEM Starter Choke	OEM Contakm Speedometer
Vespa	50-90	163620070		139403	139402	192681	174164	174701	098221	071059
Vespa Special	50	163620230		139403	139402	192681	174164	191804	098221	071059
Vespa Et3 Primavera	125	163620080		139403	139402	192681	174164	174701	152391	071059
Vespa GL Sprint	125-150	163620090		139403	139402	192681	174164	174701	092370	099011
Vespa Px Tamburo	125-150 200	163620100		139403	139402	192681	174164	174701	092370	174161
Vespa Px Arcobaleno	125-150 200	163620110		139403	139402	192681	179642	191804	104292	179271
Vespa Px Disco	125-150 200	163620120		139403	139402	192681	-	174701	098221	563796
Vespa Px 2°Serie	125-150 200	163620180		139403	139402	192681	174164	191804	092370	174161
Vespa	50-90	163620200		139403	139402	192681	174164	174701	098221	-

**ACCESSORI CAVI TRASMISSIONE - TRANSMISSION CABLES ACCESSORIES****121860310**SDOPPIATORE | *SPLITTER*

Vespa 50 ET2 • Vespa 50 LX • Vespa 50 LXV •  
Vespa 50 Primavera • Vespa 50 S • Vespa 50  
Sprint  
R.O. 269571

**121860343**NIPPLO | *NIPPLE*

Dimensioni Ø8x8 mm | *Dimensions Ø8x8 mm*  
Confezione 10 pz. | *10 Pcs Packing*  
Vespa PK 50 • Vespa 125 S • Vespa PXE  
Arcobaleno XL  
R.O. 018699, 018695

**121830470**

SOFFIETTO PROTEZIONE FILO FRENO  
POSTERIORE | *REAR BRAKE RUBBER BELLOW*  
Lunghezza 70 mm | *Length 70 mm*  
Confezione 5 pz. | *5 Pcs Packing*  
Vespa 125 - 150 ('59-'77)  
R.O. 57321, 057321



## ACCESSORI CAVI TRASMISSIONE - TRANSMISSION CABLES ACCESSORIES

**184040683**



BUSSOLA CAVO | *BUSH*

Confezione 5 pz. | *5 Pcs Packing*

Vespa 50 N • Vespa PK 50 • Vespa PK 50 Automatica • Vespa PK 50-125 XL • Vespa PK 50 XL Plurimatic • Vespa 50 Rush • Vespa PX 125-150 • Vespa PX 125 30 Anni • Vespa PX 125 EU2 • Vespa PXE 125 Arcobaleno • Vespa 125 T5  
R.O.139913



## MORSETTI CAVI - CABLE CLAMPS

**121858010**



MORSETTO CON VITE LATERALE | *CLAMPS WITH SIDE SCREW*

Ø 7x11 - M4

Per cavo frizione Ø 2,7mm | *For clutch cable Ø 2,7mm*

Confezione 10 pz. | *10 Pcs Packing*

Vespa vecchi modelli ('46-'63) | *Vespa old models ('46-'63)*



**121858040**



MORSETTO CAVO GAS | *THROTTLE CABLE CLAMPS*

Ø 5,5x7,3 - M4

Tipo Magura | *Magura type*

Confezione 10 pz. | *10 Pcs Packing*



**121858050**



MORSETTO CAVO GAS | *THROTTLE CABLE CLAMPS*

Ø 5,5x6 - Filetto 1/8

Super pratic

Confezione 10 pz. | *10 Pcs Packing*

Vespa tutti i modelli | *All models*



**MORSETTI CAVI - CABLE CLAMPS****121858060****MORSETTO CILINDRICO CAVO GAS | THROTTLE  
CABLE CLAMPS**

Ø 4x9

Per carburatore Vespa | For Vespa carburetor

Confezione 10 pz. | 10 Pcs Packing

Vespa tutti i modelli | All models

R.O. 26608

**121858070****MORSETTO CAVO CAMBIO | GEAR CABLE  
CLAMPS**

Lunghezza 11 mm | Length 11 mm

Esagono 8x11 mm | Hexagon 8x11 mm

Gambo Ø 6,8 mm | Stem Ø 6,8 mm

Confezione 10 pz. | 10 Pcs Packing

Vespa tutti i modelli | All models

R.O. 153198

**121858120****MORSETTO REGOLATORE FILO FRENO  
FRIZIONE | TERMINAL ADJUSTING SCREW**

Confezione 5 pz. | 5 Pcs Packing

Vespa PX Arcobaleno (freno anteriore e  
modifica frizione - front brake and clutch  
upgrade)**PASSACAVI - GROMMETS****121830090****PASSACAVO TUBO BENZINA | FUEL HOSE  
GROMMET**

Confezione 5 pz. | 5 Pcs Packing

Diametro Ø 14 mm | Diameter Ø 14 mm

Dimensioni foro telaio Ø 21x27,5 mm | Frame  
hole dimension Ø 21x27,5 mmVespa 125-150 ('59-'77) • Vespa PX 125-150-  
200 • Vespa T5 • Vespa PXE Arcobaleno

R.O. 084262



## PASSACAVI - GROMMETS

121830103

NEW



PASSACAVO TUBO BENZINA CARBURATORE |  
FUEL HOSE CARBURETOR GROMMET

Vespa 125 VNB-TS/GT/GTR • Vespa Rally •  
Vespa Sprint • Vespa P200E • Vespa PX125-200  
R.O. 92774



121830110



PASSACAVO COFANO MOTORE | COWL  
GROMMET

Confezione 10 pz. | 10 Pcs Packing

Vespa PX 125-150-200 • Vespa T5 • Vespa  
50-125  
R.O. 156946



121830360



PASSACAVO TELAIO | FRAME GROMMET

Confezione 5 pz. | 5 Pcs Packing

Vespa PX 125-150-200 • Vespa PE 125-150-200  
VNX2-VLX2-VSX1  
R.O. 048171



## REGISTRI CAVI - CABLE REGISTERS

121858130



REGISTRO CAVO Ø 5 MM | ADJUSTING SCREW  
Ø 5 MM

Esagono 8 mm | Hexagon 8 mm

M5x31 mm | M5x31 mm

Confezione 10 pz. | 10 Pcs Packing

Vespa tutti i modelli | All models

R.O. 090527, 020105, 090257



121858160

NEW



REGISTRO CAVO Ø 7 MM | ADJUSTING SCREW  
Ø 7 MM

Esagono 10 mm | Hexagon 10 mm

M8x40 mm | M8x40 mm

Confezione 10 pz. | 10 Pcs Packing



**REGISTRI CAVI - CABLE REGISTERS****121858250**REGOLATORE M8 | *M8 ADJUSTING SCREW*  
Confezione 5 pz. | *5 Pcs Packing***121858260**REGOLATORE M5 | *M5 ADJUSTING SCREW*  
Confezione 10 pz. | *10 Pcs Packing***121858270**REGOLATORE M6 | *M6 ADJUSTING SCREW*  
Confezione 5 pz. | *5 Pcs Packing***121858300**REGOLATORE M10 | *M10 ADJUSTING SCREW*  
Confezione 5 pz. | *5 Pcs Packing*  
M10x1.25 | *M10x1.25***GUAINA - OUTER CABLES****GUAINA CON SPIRALE IN ACCIAIO TONDO (TIPO ITALIA) - OUTER CABLE ROUND WIRE (ITALIAN TYPE)****163530400**Colore Nero | *Colour Black*  
Misura 50/mtrs roll | *Size 50/mtrs roll*  
Foro interno 2,5 mm | *Inside hole 2,5 mm*  
Diametro esterno 4,5 mm | *Outside diameter 4,5 mm*  
Diametro esterno con rivestimento 5,2 mm | *Outside hole with rubber mm 5,2 mm*

**163530401**



Colore Grigio | *Colour Gray*  
 Misura 50/mtrs roll | *Size 50/mtrs roll*  
 Foro interno 2,5 mm | *Inside hole 2,5 mm*  
 Diametro esterno 4,5 mm | *Outside diameter 4,5 mm*  
 Diametro esterno con rivestimento 5,2 mm | *Outside hole with rubber mm 5,2 mm*



**163530411**



Colore Grigio millerighe | *Colour Gray grooved*  
 Misura 50/mtrs roll | *Size 50/mtrs roll*  
 Foro interno 2,5 mm | *Inside hole 2,5 mm*  
 Diametro esterno 4,5 mm | *Outside diameter 4,5 mm*  
 Diametro esterno con rivestimento 5,2 mm | *Outside hole with rubber mm 5,2 mm*



**163530500**



Colore Nero | *Colour Black*  
 Misura 50/mtrs roll | *Size 50/mtrs roll*  
 Foro interno 3 mm | *Inside hole 3 mm*  
 Diametro esterno 5 mm | *Outside diameter 5 mm*  
 Diametro esterno con rivestimento 5,8 mm | *Outside hole with rubber mm 5,8 mm*



**163530600**



Colore Nero | *Colour Black*  
 Misura 25/mtrs roll | *Size 25/mtrs roll*  
 Foro interno 3,5 mm | *Inside hole 3,5 mm*  
 Diametro esterno 6 mm | *Outside diameter 6 mm*  
 Diametro esterno con rivestimento 7 mm | *Outside hole with rubber mm 7 mm*



**GUAINA - OUTER CABLES****163530700**

Colore Nero | *Colour Black*  
 Misura 25/mtrs roll | *Size 25/mtrs roll*  
 Foro interno 4,2 mm | *Inside hole 4,2 mm*  
 Diametro esterno 7 mm | *Outside diameter 7 mm*  
 Diametro esterno con rivestimento 8 mm |  
*Outside hole with rubber mm 8 mm*

**163530800****NEW**

Colore Nero | *Colour Black*  
 Misura 50/mtrs roll | *Size 50/mtrs roll*  
 Foro interno 2,5 mm | *Inside hole 2,5 mm*  
 Diametro esterno 4 mm | *Outside diameter 4 mm*  
 Diametro esterno con rivestimento 5 mm |  
*Outside hole with rubber mm 5 mm*  
 In PVC | *PVC made*

**163530801****NEW**

Colore Grigia | *Colour Gray*  
 Misura 50/mtrs roll | *Size 50/mtrs roll*  
 Foro interno 2,5 mm | *Inside hole 2,5 mm*  
 Diametro esterno 4 mm | *Outside diameter 4 mm*  
 Diametro esterno con rivestimento 5 mm |  
*Outside hole with rubber mm 5 mm*  
 In PVC | *PVC made*

**163530810****NEW**

Colore Nero | *Colour Black*  
 Misura 50/mtrs roll | *Size 50/mtrs roll*  
 Foro interno 2,5 mm | *Inside hole 2,5 mm*  
 Diametro esterno 5 mm | *Outside diameter 5 mm*  
 Diametro esterno con rivestimento 6 mm |  
*Outside hole with rubber mm 6 mm*  
 In PVC | *PVC made*



## GUAINA - OUTER CABLES

163530811 **NEW**



Colore Grigia | *Colour Gray*  
 Misura 50/mtrs roll | *Size 50/mtrs roll*  
 Foro interno 2,5 mm | *Inside hole 2,5 mm*  
 Diametro esterno 5 mm | *Outside diameter 5 mm*  
 Diametro esterno con rivestimento 6 mm |  
*Outside hole with rubber mm 6 mm*  
 In PVC | *PVC made*



163530820 **NEW**



Colore Nero | *Colour Black*  
 Misura 50/mtrs roll | *Size 50/mtrs roll*  
 Foro interno 3 mm | *Inside hole 3 mm*  
 Diametro esterno 6 mm | *Outside diameter 6 mm*  
 Diametro esterno con rivestimento 7 mm |  
*Outside hole with rubber mm 7 mm*  
 In PVC | *PVC made*



163530821 **NEW**



Colore Grigia | *Colour Gray*  
 Misura 50/mtrs roll | *Size 50/mtrs roll*  
 Foro interno 3 mm | *Inside hole 3 mm*  
 Diametro esterno 6 mm | *Outside diameter 6 mm*  
 Diametro esterno con rivestimento 7 mm |  
*Outside hole with rubber mm 7 mm*  
 In PVC | *PVC made*



## CAPIGUAINA - CABLE ENDS

421830201



CAPOGUAINA Ø 5,5 x 9,5 MM | *CABLE ENDS*  
 Ø 5,5 x 9,5 MM  
 Confezione 10 pz. | *10 Pcs Packing*  
 Vespa tutti i modelli | *All models*



121858190



CAPOGUAINA Ø 6 x 10 MM | *CABLE ENDS*  
 Ø 6 x 10 MM  
 Confezione 50 pz. | *50 Pcs Packing*  
 Vespa tutti i modelli | *All models*





**CAPIGUAINA - CABLE ENDS****121858200**CAPOGUAINA Ø 7 x 11 MM | *CABLE ENDS*

Ø 7 x 11 MM

Confezione 50 pz. | *50 Pcs Packing*Vespa tutti i modelli | *All models***421830211**

CAPOGUAINA Ø 5 x 9,5 MM NICHELATA |

*NICHEL - PLATED CABLE ENDS Ø 5 x 9,5 MM*Confezione 10 pz. | *10 Pcs Packing*Vespa tutti i modelli | *All models***121858210**BUSSOLA GUAINA Ø 4,5 MM | *CABLE END*

Ø 4,5 MM

Dimensioni 7x9 mm | *Dimensions 7x9 mm*Confezione 20 pz. | *20 Pcs Packing*Vespa tutti i modelli . *all models*

R.O. 90511

**SERRATURE - LOCKS****SERRATURE - LOCKS****121790042**2 Cilindretti | *Cylinder lock 2 pcs*

Vespa PK50-125/S/XL/XL2/Automatica • Vespa

PX 80-200/PE/Lusso/T5 • Cosa

Adatto per - *Suitable for* LML Star 125-200 2T-

4T/Star 125 Deluxe/II Automatica/CVT

R.O. 179292

**121790060****121790062**Kit 3 pezzi cilindretti | *Cylinder lock set 3 pcs*

Vespa PK • Vespa PK XL • Vespa PX Arcobaleno

R.O. 1792925



**121790090**



**121790092**



Cilindretto per serratura | *Cylinder lock*

Vespa PK • Vespa PK XL • Vespa PX Arcobaleno  
R.O. 196486



**121790232**



Kit 5 pezzi cilindretti | *Cylinder lock set 5 pcs*

Vespa PK • Vespa PK XL • Vespa PX Arcobaleno  
R.O. 1792925



**121790293**



Serratura sterzo | *Steering lock*

Vespa 125 VNA-VNB ('57-'65) • Vespa 150 VBA-VBB ('59-'65)  
R.O. 082416



**121790303**



Serratura sterzo | *Steering lock*

Piastrina corta | *Short plate*

Vespa 125 ('51-'57) • Vespa 150 ('54-'56) •  
Vespa GS 150 VS1 ('55)  
R.O. 20456



**121790713**



Serratura sterzo | *Steering lock*

Piastrina lunga 27 mm | *Long plate 27 mm*

Vespa 150 VB1 ('57-'58) • Vespa GS 150 ('56-'61)  
R.O. 060727



**SERRATURE - LOCKS****121790272**

Kit serratura 4 mm + Bauletto | *Kit cylinder 4 mm + Tool box*

Vespa 50 • Vespa 125 Primavera • Vespa P 125X • Vespa P 150S • Vespa 150 Super • Vespa 200 Rally  
R.O. 139188

**121790162**

Kit serratura 4 mm + Bauletto - Chiavi in plastica | *Kit cylinder 4 mm + Tool box - Plastic keys*

Vespa 50 • Vespa 125 Primavera • Vespa P 125X • Vespa P 150S • Vespa 150 Super • Vespa 200 Rally  
R.O. 139188

**121790262**

Kit serratura 4 mm + Bauletto + Sella | *Kit cylinder 4 mm + Tool box + Seat*

Vespa PX 125-150 • Vespa P 200E ('78-'84)  
R.O. 184860

**121790172**

Kit serratura 6 mm + Bauletto | *Kit cylinder 6 mm + Tool box*

Vespa 50 S • Vespa Elestart • Vespa Primavera 125 ET3 • Vespa PX • Vespa PE  
R.O. 182178



121790122



Serratura sterzo - Chiavi in plastica | *Steering lock - 2 plastic keys*

Guida mm 4 | *Size mm 4*

Vespa 50 • Vespa 125 Primavera • Vespa PX 1250-150 • Vespa Super • Vespa Sprint • Vespa Rally

R.O. 139371



121790192



Serratura sterzo - Chiavi in metallo | *Steering lock - 2 metal keys*

Guida mm 4 | *Size mm 4*

Vespa 50 • Vespa 125 Primavera • Vespa P 125X • Vespa P 150S • Vespa 150 Super • Vespa 200 Rally

R.O. 152096, 139188



121790132



Serratura sterzo - Chiavi in plastica | *Steering lock - 2 plastic keys*

Guida mm 6 | *Size mm 6*

Vespa 50 S • Vespa Elestart • Vespa R • Vespa 125 ET3 • Vespa PX • Vespa PE

R.O. 139371



121790202



Serratura sterzo - Chiavi in metallo | *Steering lock - 2 metal keys*

Guida mm 6 | *Size mm 6*

Vespa 50 S • Vespa Elestart • Vespa R • Vespa 125 ET3 • Vespa PX • Vespa PE

R.O. 139371



**SERRATURE - LOCKS****121790222**

Serratura sterzo - Chiavi in metallo | *Steering lock - 2 metal keys*

Guida mm 4 | *Size mm 4*

Vespa 50 R • Vespa SS • Vespa Special • Vespa 90 SS • Vespa 125 Primavera • Vespa Super • Vespa Sprint

R.O. 120328, 70603

**121790142**

Serratura bauletto | *Tool box lock*

Vespa 125 Primavera • Vespa Primavera ET3 • Vespa Super • Vespa PX • Vespa PE • Vespa Rally

R.O. 73258

**121790180**

Serratura bauletto | *Tool box lock*

Vespa PX PE Arcobaleno ('84-'05) • Vespa PK XL Rush • Vespa PK 50-125XL

R.O. 198560, 196486

**121790252**

Serratura bauletto | *Tool box lock*

Vespa PX Arcobaleno • Vespa T5 • Vespa PK XL

R.O. 198560

**121790513**

Serratura bauletto laterale o posteriore | *Tool box rear or side lock*

Vespa 150 VL3-VBA-VBB1/2 • Vespa Sprint 150 VLB 1° serie (dal telaio n.025478 - *from chassis n.025478*) • Vespa GS 150 VS2-VS5 • Vespa GS 160 VSB1 ('62)

R.O. 025911



**121790613**



Con Coperchio | *With Cover*  
Vespa VN • Vespa VL • Vespa GS



**121790152**



Serratura sportello laterale | *Side door lock*  
Vespa 50-90-125 • Vespa Primavera • Vespa  
ET3



**121790313**



Serratura sella | *Seat lock*  
Vespa PX PE ('78-'83)  
R.O. 1900135, 437959



**121790170**



Serratura sella | *Seat lock*  
Vespa PX PE Arcobaleno ('85-98)  
R.O. 178887



**121790413**



Serratura sella | *Seat lock*  
Vespa Millenium  
R.O. 577267



**SERRATURE - LOCKS****121790430** **NEW**

Serratura sella | *Seat lock*  
 Compatibile con selle cod. 142760003-  
 142760004-142760005 | *Suitable for seats*  
*code 142760003-142760004-142760005*  
 Vespa 125 ET3 Adattabile a Sella Yankee |  
*Suitable for Yankee seat*

**ACCESSORI SERRATURE - LOCKS ACCESSORIES****121790182**

KIT COPERCHIETTO SERRATURA | *LOCK COVER*  
 Diametro Ø 4,45 mm | *Diameter Ø 4,45 mm*  
 Vespa 50-90 ('63>) • Vespa 125 Primavera •  
 Vespa ET3 • Vespa 150 GL • Vespa Sprint •  
 Vespa Super • Vespa Rally  
 R.O. 152097

**121790190**

COPERCHIETTO SERRATURA | *LOCK COVER*  
 Sono necessari 2 rivetti | *2 rivets needed*  
 Confezione 5 pz. | *5 Pcs Packing*  
 Vespa 50-125  
 R.O. 174628

**121790442** **NEW**

SBOZZATO CHIAVE VESPA 32x7,8 mm | *VESPA*  
*KEY BLANK 32x7,8 mm*  
 Confezione 1 pz. | *1 Pcs Packing*  
 Tutti modelli Vespa | *All Vespa models*  
 R.O. 225557, 257710



**121790743** **NEW**



ALLOGGIAMENTO SERRATURA BLOCCASTERZO

| *STEERING LOCK TUBE*

Lunghezza 59 mm | *Length 59 mm*

Ø esterno 29,5/27,0 mm | *Ø external*

29,5/27,0 mm

Ø interno 23,5/22,0 mm | *Ø internal*

23,5/22,0 mm

Vespa 50-125 PK/S/XL • Vespa PK 125-150-200



**121830460**



FONDELLO BLOCCA STERZO | *GASKET FOR CYLINDER LOCK*

Altezza 8,5 mm | *Height 8,5 mm*

Ø esterno 38 mm | *Ø external 38 mm*

Ø interno 22 mm | *Ø internal 22 mm*

In gomma | *Rubber made*

Confezione 5 pz. | *5 Pcs Packing*

Vespa 50 N • Vespa L • Vespa R • Vespa Special

• Vespa 50 SS • Vespa 125 Primavera VMA1T-2

• Vespa Super • Vespa GT • Vespa GTR • Vespa

TS • Vespa GL • Vespa Sprint • Vespa Sprint

Veloce • Vespa 160 GS • Vespa 180 SS • Vespa

180-200 Rally

R.O. 174092



**121870012**



CORPO CILINDRETTO SERRATURA | *CYLINDER LOCKBODY*

Vespa PX 125-150 • Vespa P 200E • Vespa PX

125 T5 ('84-'02) • Vespa PK 50 • Vespa 125 S •

Vespa PK 50-125XL • Vespa 50 N • Vespa 50

PKS • Vespa 125 Automatica

R.O. 297777



**121870022**



CORPO CILINDRETTO SERRATURA | *CYLINDER LOCKBODY*

Vespa 50 FL • Vespa 125 FL • Vespa 50 FL2

automatica • Vespa 50 FL2 HP • Cosa 2 125-

150-200

R.O. 254536





**ACCESSORI SERRATURE - LOCKS ACCESSORIES****121950090**PIASTRINA SERRATURA BAULETTO | *TOOLBOX*  
LOCK PLATEConfezione 10 pz. | *10 Pcs Packing*Vespa 125 Primavera • Vespa Primavera ET3 •  
Vespa PX PE • Vespa Super • Vespa Rally  
R.O. 073260**121870160****NEW**MOLLA CILINDRETTO BLOCCASTERZO |  
CYLINDER LOCK SPRINGConfezione 10 pz. | *10 Pcs Packing*Vespa 50 N • Vespa L • Vespa R • Vespa Special  
• Vespa 50 SS • Vespa 125 Primavera VMA1T-2  
• Vespa Super • Vespa GT • Vespa GTR • Vespa  
TS • Vespa GL • Vespa Sprint • Vespa Sprint  
Veloce • Vespa PX 125-150-200 ('81-'97)  
R.O. 152195**246050770****NEW**PIASTRINA CROMATA SERRATURA NEIMAN Ø  
Bohrloch 4,45 mm | *CHROMED PLATE NEIMAN*  
LOCKColore Cromato | *Colour Chromed*Forma Goccia | *Shape Drop*con scritta NEIMANN dritta | *with straight*  
*NEIMANN logo*Vespa 50 • Vespa 125 Primavera/GL/Sprint/Rally  
V5A1T-V5A2T-V5A3T-V5SA1T-V9A1T-VMA2T-  
VNL2T-VBC1T-VLB1T  
R.O. 70604

## ACCESSORI SERRATURE - LOCKS ACCESSORIES

**246050780** **NEW**



PIASTRINA CROMATA SERRATURA NEIMAN  
DBP Ø Bohrloch 4,45 mm | *CHROMED PLATE*  
*NEIMAN LOCK DBP*

Colore Cromato | *Colour Chromed*

Forma Goccia | *Shape Drop*

con scritta NEIMANN DBP | *with NEIMANN DBP*  
*logo*

Vespa 50 1° serie/N 1° serie/L 1° serie/R/S 1°  
serie/Special • Vespa 90 1° serie/R • Vespa 125  
Primavera 2° serie • Vespa 125 Primavera ET3  
1° serie • Vespa 125 GT 2° serie/ GTR/TS • Vespa  
150 Sprint 2° serie /V/Super 2° serie • Vespa  
180 Rally • Vespa 200 Rally 1° serie

R.O.152097

Adatto per - *Suitable for* Vespa 50 S 1° serie/SS  
• Vespa 90 1° serie/SS • Vespa 160 GS 2° serie •  
Vespa 180 SS



## PEDALI E PUNTAPIEDI - FOOTRESTS AND PEDALS

**121530190**



PEDALE E PIASTRA FRENO COMPLETO | *BRAKE*  
*PEDAL ASSY*

Vespa 50 Special • Vespa 125 Primavera ET3 •  
Vespa PK 50-125XL • Vespa PX 125-150-200

R.O. 182049, 138474



**121530313**



PEDALE FRENO | *BRAKE PEDAL*

Con gommino | *With rubber*

Vespa 125 GT-GTR • Vespa 150 GL • Vespa  
Sprint • Vespa Sprint Veloce • Vespa VNB-VBB-  
VBA

R.O. 94451, 94364, 84420, 59956



**ACCESSORI PEDALI - PEDALS ACCESSORIES****121830450**

GOMMINO PEDALE FRENO | *BRAKE PEDAL RUBBER*

Dimensione 40x20x18 mm | *Dimensions 40x20x18 mm*

Confezione 10 pz. | *10 Pcs Packing*

Vespa 125 VNB3-4-5-6 ('61-'66) • Vespa 150 VBB1-2T ('61-'66) • Vespa 125 Super ('66-'68) • Vespa 150 ('66-'79) • Vespa GT VNL1T ('66-'73) dal telaio n.30001 - *from chassis n.30001* • Vespa GL 150 • Vespa GS 150 • Vespa GS 160 • Vespa 180 SS • Vespa 180-200 Rally  
R.O. 093100

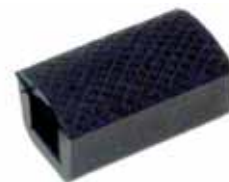
**121830480**

GOMMINO PEDALE FRENO BUCO QUADRO | *BRAKE PEDAL RUBBER SQUARED HOLE*

Dimensione 50x38x24 mm | *Dimensions 50x38x24 mm*

Confezione 5 pz. | *5 Pcs Packing*

Vespa 50 (V5A1T 914748>) • Vespa 50 Special (V5B3T 230536>) • Vespa 50 S (V5SA1T 79735>) • Vespa 90 (V9A1T 184927>) • Vespa 100 (V9B1T 5363>) • Vespa 125 Primavera (VMA2T 0192145>) ET3 • Vespa PX 125-150-200  
R.O. 182051

**121830500**

GOMMINO PEDALE FRENO BUCO TONDO | *BRAKE PEDAL RUBBER ROUNDED HOLE*

Dimensione 54x32x18 mm | *Dimensions 54x32x18 mm*

Confezione 5 pz. | *5 Pcs Packing*

Vespa 50 V5SST ('66-'71)/V5A1T ('65-'67) dal telaio n.92877 - *from chassis n.92877* • Vespa 90 V9SST ('65-'71) • Vespa 100 V9B1T 5363> • Vespa 125 VNA 1/2T ('58-'59) • Vespa 125 Primavera ET3 VMB1T ('76-'79)  
R.O. 100426



## ACCESSORI PEDALI - PEDALS ACCESSORIES

**121950100**



MOLLA PEDALE FRENO | BRAKE PEDAL SPRING

Lunghezza 121 mm | Length 121 mm

Diametro Ø 32 mm | Diameter Ø 32 mm

Confezione 5 pz. | 5 Pcs Packing

Vespa 50-90-125 Primavera • Vespa 125 ET3 •

Vespa PX PE Arcobaleno

R.O. 070994, 176444



## PEDIVELLE MESSA IN MOTO - KICK STARTER LEVERS

**121530050**



Alluminio | Aluminium

Vespa 50-90 • Vespa 125 Primavera • Vespa

Primavera ET3

R.O. 079077



**121530060**



Alluminio | Aluminium

Vespa PK 50 • Vespa PK 50XL • Vespa PK 125 •

Vespa PK 125XL • Vespa Rush • Vespa N

R.O. 216141



**121530170**



Alluminio | Aluminium

Vespa 125-150 • Vespa GL • Vespa Super •

Vespa Sprint ('59>)

R.O. 174310



**PEDIVELLE MESSA IN MOTO - KICK STARTER LEVERS****121530180**Alluminio | *Aluminium*

Vespa 125-150 (&gt;'58)

R.O. 083986

**121530200**Alluminio | *Aluminium*

Vespa PX PE • Vespa PX PE Arcobaleno ECO

R.O. 1743125

**121530201**Alluminio | *Aluminium*

Vespa PX PE • Vespa PX PE Arcobaleno

R.O. 1743125

**CERCHI - WHEELRIMS****225000010**COLORE GRIGIO ORIGINALE | *ORIGINAL GREY COLOR*Dimensione gomma 3,00X10"/3.50 x 10" | *Tyre dimensions 3,00X10"/3.50 x 10"*Dimensioni cerchio 2.10x10" | *Rim dimensions 2.10x10"*Vespa 50-125 Primavera • Vespa 125 Primavera  
ET3 • Vespa PK • Vespa PX • Vespa 180-200  
Rally

R.O. 0846315, 5800010



**225000011**



COLORE NERO | *BLACK COLOR*

Dimensione gomma 3,00X10"/3.50 x 10" | *Tyre dimensions 3,00X10"/3.50 x 10"*

Dimensioni cerchio 2.10x10" | *Rim dimensions 2.10x10"*

Vespa 50-125 Primavera • Vespa 125 Primavera  
ET3 • Vespa PK • Vespa PX • Vespa 180-200

Rally

R.O. 0846315, 5800010



**225000012**



COLORE GRIGIO ORIGINALE | *ORIGINAL GREY COLOR*

Dimensione gomma 3,00X10"/3.50 x 10" | *Tyre dimensions 3,00X10"/3.50 x 10"*

Dimensioni cerchio 2.10x10" | *Rim dimensions 2.10x10"*

Vespa 50-125 Primavera • Vespa 125 Primavera  
ET3 • Vespa PK • Vespa PX • Vespa 180-200

Rally

R.O. 0846315, 5800010



**225000013**



COLORE ROSSO | *RED COLOR*

Dimensione gomma 3,00X10"/3.50 x 10" | *Tyre dimensions 3,00X10"/3.50 x 10"*

Dimensioni cerchio 2.10x10" | *Rim dimensions 2.10x10"*

Vespa 50-125 Primavera • Vespa 125 Primavera  
ET3 • Vespa PK • Vespa PX • Vespa 180-200

Rally

R.O. 0846315, 5800010



**225000014**



COLORE GRIGIO | *GREY COLOR*

Dimensione gomma 3,00X8"/3.50 x 8" | *Tyre dimensions 3,00X8"/3.50 x 8"*

Dimensioni cerchio 2.10x8" | *Rim dimensions 2.10x8"*

Vespa 125-150 Super

R.O. 1103765



**CERCHI - WHEELRIMS****225000015**COLORE BIANCO | *WHITE COLOR*Dimensione gomma 3,00X10"/3.50 x 10" | *Tyre dimensions 3,00X10"/3.50 x 10"*Dimensioni cerchio 2.10x10" | *Rim dimensions 2.10x10"*Vespa 50-125 • Vespa Primavera • Vespa 125  
Primavera ET3 • Vespa PK • Vespa PX • Vespa  
180-200 Rally

R.O. 0846315, 5800010

**225000016**CROMATO | *CHROMED*Dimensione gomma 3,00X10"/3.50 x 10" | *Tyre dimensions 3,00X10"/3.50 x 10"*Dimensioni cerchio 2.10x10" | *Rim dimensions 2.10x10"*Vespa 50-125 Primavera • Vespa 125  
Primavera ET3 • Vespa PK • Vespa PX • Vespa  
180-200 Rally

R.O. 0846315, 5800010

**225000017**CROMATO | *CHROMED*Dimensione gomma 3,00X10"/3.50 x 10" | *Tyre dimensions 3,00X10"/3.50 x 10"*Dimensioni cerchio 2.10x10" | *Rim dimensions 2.10x10"*Vespa 50-125 Primavera • Vespa 125  
Primavera ET3 • Vespa PK • Vespa PX • Vespa  
180-200 Rally

R.O. 0846315, 5800010

**225000018**COLORE GRIGIO | *GREY COLOR*Dimensione gomma 3,00X8"/3.50 x 8" | *Tyre dimensions 3,00X8"/3.50 x 8"*Dimensioni cerchio 2.10x8" | *Rim dimensions 2.10x8"*

Vespa 125 ('51-'65)

Vespa 150 ('55-'66)

R.O. 014984, 14894



## CERCHI - WHEELRIMS

225000026



COLORE GRIGIO | GREY COLOR

Dimensione gomma 3,00X10"/3.50 x 10" | Tyre dimensions 3,00X10"/3.50 x 10"

Dimensioni cerchio 2.10x10" | Rim dimensions 2.10x10"

Vespa 50-125 Primavera • Vespa 125

Primavera ET3 • Vespa PK • Vespa PX • Vespa 180-200 Rally



## SELLE - SEATS

142760001

NEW



Con levetta | With lever

Vespa 125 Primavera ET3

Adattabile a - Suitable for Vespa 50 tutti i modelli - all models • Vespa 125 Primavera



142760002

NEW



Con serratura | With lock

Vespa 125 Primavera • Vespa 125 Primavera ET3

Adattabile a - Suitable for Vespa 50 tutti i modelli - all models • Vespa 125 Primavera



142760003

NEW



Con gobba | Single seater

Vespa PK 50 • Vespa PK 50S





**SELLE - SEATS****142760004** **NEW**

Lunga con serratura | *Long with lock*  
 Vespa PK 125 • Vespa PK 125S

**142760005** **NEW**

Colore nero | *Black color*  
 Vespa PK 50-125 XL

**142760006** **NEW**

Vespa PX 125-150-200 ('78-'83)

**142760007** **NEW**

Vespa PX 125-150-200 ('83-'89/'90)



## SELLE - SEATS

142760008 **NEW**



Con gobba | *With hump*  
Vespa 50 N/R/L • Vespa 50 Special



142760009 **NEW**



Lunga | *Long*  
Vespa 50 N/R/L • Vespa 50 Special



142760010 **NEW**



Vespa 125 Primavera  
Adattabile a - *Suitable for* Vespa 50 N/R/L •  
Vespa 50 Special



142760011 **NEW**



Con bottone | *With button*  
Vespa 150 Sprint Veloce • Vespa 180 SS



**SELLE - SEATS****142760012** **NEW**Vespa 125 GTR • Vespa 125 GT • Vespa Sprint •  
Vespa GL 150**142760026** **NEW**Lunga | *Long*  
Vespa PK 50-125 FL2**142760029** **NEW**

Vespa 180-200 Rally

**142760030** **NEW**

Vespa PX 125-150 ('13-'15)



142760031 **NEW**



Fondo in plastica | *Plastic bottom*  
Vespa PX 125-150-200 ('97-'01)



142760040 **NEW**



Fondo in lamiera verniciato a polvere nero |  
*Seat bottom in black powder coated metal sheet*

Chiusura a calamita | *Magnetic closure*

Imbottitura in poliuretano espanso |

*Polyurethane foam padding*

Copertina in simil-pelle | *Leatherette cover*

Logo Nisa stampato a caldo | *Hot-stamped Nisa logo*

Colore Nero | *Black colour*

Vespa 50 N-L-R • Vespa 50 Special • Vespa 90 • Vespa 90 SS • Vespa 100 • Vespa 125 Primavera • Vespa 125 Primavera ET3



142760041 **NEW**



Fondo in lamiera verniciato a polvere nero |  
*Seat bottom in black powder coated metal sheet*

Chiusura a calamita | *Magnetic closure*

Imbottitura in poliuretano espanso |

*Polyurethane foam padding*

Copertina in simil-pelle | *Leatherette cover*

Logo Nisa stampato a caldo | *Hot-stamped Nisa logo*

Colore Marrone | *Brown colour*

Vespa 50 N-L-R • Vespa 50 Special • Vespa 90 • Vespa 90 SS • Vespa 100 • Vespa 125 Primavera • Vespa 125 Primavera ET3



**SELLE - SEATS****142760042** **NEW**

Fondo in lamiera verniciato a polvere nero |  
*Seat bottom in black powder coated metal sheet*

Chiusura a calamita | *Magnetic closure*

Imbottitura in poliuretano espanso |  
*Polyurethane foam padding*

Copertina in simil-pelle | *Leatherette cover*

Logo Nisa stampato a caldo | *Hot-stamped Nisa logo*

Colore Nero | *Black colour*

Vespa 125 VNB 1/6 • Vespa 125 GT/GTR 1° serie  
 • Vespa 125 Super • Vespa 125 TS • Vespa 150 VBA • Vespa 150 VBB • Vespa 150 GL • Vespa 150 Sprint/V 1° serie • Vespa 150 Super 1° serie  
 • Vespa PX tutti i modelli - *all models*

**142760043** **NEW**

Fondo in lamiera verniciato a polvere nero |  
*Seat bottom in black powder coated metal sheet*

Chiusura a calamita | *Magnetic closure*

Imbottitura in poliuretano espanso |  
*Polyurethane foam padding*

Copertina in simil-pelle | *Leatherette cover*

Logo Nisa stampato a caldo | *Hot-stamped Nisa logo*

Colore Marrone | *Brown colour*

Vespa 125 VNB 1/6 • Vespa 125 GT/GTR 1° serie  
 • Vespa 125 Super • Vespa 125 TS • Vespa 150 VBA • Vespa 150 VBB • Vespa 150 GL • Vespa 150 Sprint/V 1° serie • Vespa 150 Super 1° serie  
 • Vespa PX tutti i modelli - *all models*



142760044 **NEW**



Fondo in lamiera verniciato a polvere nero |  
*Seat bottom in black powder coated metal sheet*

Chiusura a calamita | *Magnetic closure*

Imbottitura in poliuretano espanso |  
*Polyurethane foam padding*

Copertina in simil-pelle | *Leatherette cover*

Logo Nisa stampato a caldo | *Hot-stamped Nisa logo*

Colore Nero | *Black colour*

Vespa Rally 180-200



142760045 **NEW**



Fondo in lamiera verniciato a polvere nero |  
*Seat bottom in black powder coated metal sheet*

Chiusura a calamita | *Magnetic closure*

Imbottitura in poliuretano espanso |  
*Polyurethane foam padding*

Copertina in simil-pelle | *Leatherette cover*

Logo Nisa stampato a caldo | *Hot-stamped Nisa logo*

Colore Marrone | *Brown colour*

Vespa Rally 180-200



142760046 **NEW**



Fondosella in abs | *ABS seat frame*

Rivestimento in finta pelle con cuciture a mano.

Attacco a calamita con ammortizzatore |

*Faux leather upholstery with hand stitching.*

*Magnetic attachment with shock absorber*

Colore Nero | *Black colour*

Vespa 50 N-L-R • Vespa 50 Special • Vespa 90 • Vespa 90 SS • Vespa 100 • Vespa 125 Primavera • Vespa 125 Primavera ET3



**SELLE - SEATS****142760047** **NEW**

Fondosella in abs | *ABS seat frame*  
 Rivestimento in finta pelle con cuciture a mano.  
 Attacco a calamita con ammortizzatore |  
*Faux leather upholstery with hand stitching.*  
*Magnetic attachment with shock absorber*  
 Colore Marrone | *Brown colour*  
 Vespa 50 N-L-R • Vespa 50 Special • Vespa  
 90 • Vespa 90 SS • Vespa 100 • Vespa 125  
 Primavera • Vespa 125 Primavera ET3

**142760048** **NEW**

Fondosella in abs | *ABS seat frame*  
 Rivestimento in finta pelle con cuciture a mano.  
 Attacco a calamita con ammortizzatore |  
*Faux leather upholstery with hand stitching.*  
*Magnetic attachment with shock absorber*  
 Colore Nero | *Black colour*  
 Vespa 125 VNB 1/6 • Vespa 125 GT/GTR 1° serie  
 • Vespa 125 Super • Vespa 125 TS • Vespa 150  
 VBA • Vespa 150 VBB • Vespa 150 GL • Vespa  
 150 Sprint/V 1° serie • Vespa 150 Super 1° serie  
 • Vespa PX tutti i modelli - *all models*

**142760049** **NEW**

Fondosella in abs | *ABS seat frame*  
 Rivestimento in finta pelle con cuciture a mano.  
 Attacco a calamita con ammortizzatore |  
*Faux leather upholstery with hand stitching.*  
*Magnetic attachment with shock absorber*  
 Colore Marrone | *Brown colour*  
 Vespa 125 VNB 1/6 • Vespa 125 GT/GTR 1° serie  
 • Vespa 125 Super • Vespa 125 TS • Vespa 150  
 VBA • Vespa 150 VBB • Vespa 150 GL • Vespa  
 150 Sprint/V 1° serie • Vespa 150 Super 1° serie  
 • Vespa PX tutti i modelli - *all models*



142760051 **NEW**



Sella Yankee Giuliani 756 | *Seat Yankee Giuliani 756*

Vespa 50 N-L-R • Vespa 50 Special • Vespa 90 • Vespa 90 SS • Vespa 100 • Vespa 125 Primavera • Vespa 125 Primavera ET3



142760052 **NEW**



Sella Yankee Giuliani 757 | *Seat Yankee Giuliani 757*

Vespa 125 VNB 1/6 • Vespa 125 GT/GTR 1° serie • Vespa 125 Super • Vespa 125 TS • Vespa 150 VBA • Vespa 150 VBB • Vespa 150 GL • Vespa 150 Sprint/V 1° serie • Vespa 150 Super 1° serie • Vespa PX tutti i modelli - *all models*



142760053 **NEW**



Sella Yankee Giuliani 758 | *Seat Yankee Giuliani 758*

Vespa PK 50S • Vespa PK 50SS • Vespa PK 50 XL/XL2/FL/HP/N/Rush



142760056 **NEW**



Sella sport Racing con gobba | *Seat sport racing with hump*

Vespa 125 VNB 1/6 • Vespa 125 GT/GTR 1° serie • Vespa 125 Super • Vespa 125 TS • Vespa 150 VBA • Vespa 150 VBB • Vespa 150 GL • Vespa 150 Sprint/V 1° serie • Vespa 150 Super 1° serie • Vespa PX tutti i modelli - *all models*





**SELLE - SEATS****142760058** **NEW**Sella Sport Racing con gobbeta | *Seat sport racing with small hump*

Vespa PK 50S • Vespa PK 50SS • Vespa PK 50 XL/XL2/FL/HP/N/Rush

**142760059** **NEW**Fondosella a molle | *Spring seat frame*Sella biposto tipo originale | *Two-seater saddle as the original*

Vespa PK 50-125 XL/XL2

**142760060** **NEW**Sella biposto | *Two-seater seat*

Vespa PK50-125 V/FL/HP/N/Rush

**142760073** **NEW**Fondosella in plastica | *Plastic seat frame*Sella biposto | *Two-seater seat*

Vespa 125 Primavera ET3

Adattabile a - *Suitable for* Vespa 50 N-L-R •  
Vespa 50 Special • Vespa 90 • Vespa 90 SS •  
Vespa 100 • Vespa 125 Primavera

142760074 **NEW**



Sella monoposto | *Front single seat*

Disponibile con svassi per maniglia o con fori interasse 18-24 cm | *Available with joint for handle or with holes. Wheelbase 18-24 cm*

Colore Nero | *Black colour*

Vespa 125 VNB 1/6 • Vespa 125 GT/GTR 1° serie  
 • Vespa 125 Super • Vespa 125 TS • Vespa 150 VBA • Vespa 150 VBB • Vespa 150 GL • Vespa 150 Sprint/V 1° serie • Vespa 150 Super 1° serie  
 • Vespa PX tutti i modelli - *all models*



142760075 **NEW**



Sella monoposto | *Front single seat*

Disponibile con svassi per maniglia o con fori interasse 18-24 cm | *Available with joint for handle or with holes. Wheelbase 18-24 cm*

Colore Blu | *Blue colour*

Vespa 125 VNB 1/6 • Vespa 125 GT/GTR 1° serie  
 • Vespa 125 Super • Vespa 125 TS • Vespa 150 VBA • Vespa 150 VBB • Vespa 150 GL • Vespa 150 Sprint/V 1° serie • Vespa 150 Super 1° serie  
 • Vespa PX tutti i modelli - *all models*



142760076 **NEW**



Sella monoposto | *Front single seat*

Disponibile con svassi per maniglia o con fori interasse 18-24 cm | *Available with joint for handle or with holes. Wheelbase 18-24 cm*

Colore Verde | *Green colour*

Vespa VNA1-2

Adattabile a - *Suitable for* Vespa 125 VNB 1/6 •  
 Vespa 125 GT/GTR 1° serie • Vespa 125 Super •  
 Vespa 125 TS • Vespa 150 VBA • Vespa 150 VBB  
 • Vespa 150 GL • Vespa 150 Sprint/V 1° serie  
 • Vespa 150 Super 1° serie • Vespa PX tutti i  
 modelli - *all models*



**SELLE - SEATS****142760077** **NEW**Sella monoposto | *Front single seat*Colore blu | *Blue colour*

Vespa 50 N • Vespa 90

**142760078** **NEW**Fondosella in lamiera | *Sheet metal frame*Sella Sport | *Sport seat*Senza maniglia | *No handle*Vespa 50 N-L-R • Vespa 50 Special • Vespa  
90 • Vespa 90 SS • Vespa 100 • Vespa 125  
Primavera • Vespa 125 Primavera ET3**142760079** **NEW**Fondosella in ABS verniciabile | *ABS paintable  
frame*Sella Corsa | *Race seat*Vespa 50 N-L-R • Vespa 50 Special • Vespa  
90 • Vespa 90 SS • Vespa 100 • Vespa 125  
Primavera • Vespa 125 Primavera ET3**142760080** **NEW**Fondosella in ABS verniciabile | *ABS paintable  
frame*Ricoperta con doppio skai e bordino bianco |  
*Covered with double cover skai fabric and  
white trim*Vespa 50 N-L-R • Vespa 50 Special • Vespa  
90 • Vespa 90 SS • Vespa 100 • Vespa 125  
Primavera • Vespa 125 Primavera ET3

142760081 **NEW**



Sella Sport | *Sport seat*  
 Ricoperta con doppio skai e bordino bianco |  
 Covered with double cover skai fabric and  
 white trim  
 Vespa 150 Sprint/ V 1°  
 Adattabile a - *Suitable for* Vespa 125 VNB 1/6  
 • Vespa 125 GT/GTR 1° • Vespa 125 Super •  
 Vespa 125 TS • Vespa 150 VBA • Vespa 150 VBB  
 • Vespa 150 GL • Vespa 150 Super 1° • Vespa PX  
 tutti i modelli - *all models*



142760082 **NEW**



Sella Sport | *Sport seat*  
 Ricoperta con doppio skai e bordino bianco |  
 Covered with double cover skai fabric and  
 white trim  
 Vespa Rally 180-200



142760083 **NEW**



Fondosella in ABS | *ABS seat frame*  
 Sella monoposto | *Front single seat*  
 Ricoperta con doppio skai e bordino bianco |  
 Covered with double cover skai fabric and  
 white trim  
 Vespa PX tutti i modelli - *All models*  
 Adattabile a - *Suitable also for* Vespa 125 VNB  
 1/6 • Vespa 125 GT/GTR 1° serie • Vespa 125  
 Super • Vespa 125 TS • Vespa 150 VBA • Vespa  
 150 VBB • Vespa 150 GL • Vespa 150 Super 1°  
 serie • Vespa 150 Sprint/ V 1° serie



**SELLE - SEATS****142760084** **NEW**Fondosella in ABS verniciabile | *ABS paintable frame*Sella monoposto | *Front single seat*Vespa PX tutti i modelli - *all models*Adattabile a - *Suitable for* Vespa 125 VNB 1/6 •

• Vespa 125 GT/GTR 1° serie • Vespa 125 Super

• Vespa 125 TS • Vespa 150 VBA • Vespa 150

VBB • Vespa 150 GL • Vespa 150 Super 1° serie

• Vespa 150 Sprint/ V 1° serie

**142760103** **NEW**Cuscino posteriore | *Back cushion*Colore blu | *Blue colour*

Vespa 125 VNB 1/6 • Vespa 125 GT/GTR 1° serie

• Vespa 125 Super • Vespa 125 TS • Vespa 150

VBA • Vespa 150 VBB • Vespa 150 GL • Vespa

150 Super 1° serie • Vespa 150 Sprint/ V 1° serie

**142760104** **NEW**Cuscino posteriore | *Back cushion*Colore verde | *Green colour*

Vespa 125 VNB 1/6 • Vespa 125 GT/GTR 1° serie

• Vespa 125 Super • Vespa 125 TS • Vespa 150

VBA • Vespa 150 VBB • Vespa 150 GL • Vespa

150 Super 1° serie • Vespa 150 Sprint/ V 1° serie

**142760105** **NEW**Cuscino posteriore | *Back cushion*

Con attacchi per fissaggio sul portapacchi |

*Joints for fixing on the luggage rack*

Vespa 50 N • Vespa 90



## SELLE - SEATS

142760107 **NEW**



Cuscino quadrato | *Squared cushion*

Colore Nero | *Black colour*

Dimensioni 25x25 cm | *Dimensions 25x35 cm*

Vespa V30-V33 • Vespa VM1-2 • Vespa VN1-VN2



142760108 **NEW**



Cuscino quadrato | *Squared cushion*

Colore Verde | *Green colour*

Dimensioni 25x25 cm | *Dimensions 25x35 cm*

Vespa V30-V33 • Vespa VM1-2 • Vespa VN1-VN2



142760109 **NEW**



Cuscino quadrato con rialzo | *Squared cushion with raised part*

Colore Nero | *Black colour*

Dimensioni 25x25 cm | *Dimensions 25x35 cm*

Vespa VM1-2 • Vespa VN1-VN2



142760110 **NEW**



Cuscino quadrato con rialzo | *Squared cushion with raised part*

Colore Verde | *Green colour*

Dimensioni 25x25 cm | *Dimensions 25x35 cm*

Vespa VM1-2 • Vespa VN1-VN2



## ACCESSORI SELLE - SEATS ACCESSORIES

**121830940**TAMPONE SELLA | *SADDLE BUFFER*Diametro Ø 10/30 mm | *Diameter Ø 10/30 mm*Lunghezza 31 mm | *Length 31 mm*Confezioni 5 pz. | *5 Pcs Packing*

Vespa PX 125-150-200

R.O. 267420

**121858400**PERNO ANCORAGGIO SELLA TIPO CORTO |  
*SADDLE PIN SHORT TYPE*Filetto M7 | *Thread M7*Lunghezza totale 44 mm | *Total Length 44 mm*Confezione 5 pz. | *5 Pcs Packing*Vespa 50 (Vari modelli - *Various models*) •

Vespa 125 Primavera • Vespa 125 Primavera

ET3

R.O. 056729

**121858410**PERNO ANCORAGGIO SELLA TIPO LUNGO |  
*SADDLE PIN LONG TYPE*Filetto M7 | *Thread M7*Lunghezza totale 73 mm | *Total Length 73 mm*Confezione 5 pz. | *5 Pcs Packing*Vespa 50 (Vari modelli - *Various models*) •

Vespa 125 Primavera • Vespa 125 Primavera

ET3

R.O. 139318

**121858420**PERNO ANCORAGGIO SELLA | *SADDLE PIN*Filetto M8 | *Thread M8*Lunghezza totale 45 mm | *Total Length 45 mm*Confezione 5 pz. | *5 Pcs Packing*

Vespa PX 125-150-200 • Vespa PE 125-150-200

R.O. 240165



121860480 **NEW**



GOMMINO PICCOLO SOTTOSELLA | *SMALL  
RUBBER PAD BELOW SEAT*

Vespa 50 N-R-L • Vespa 50 Special • Vespa 125  
Primavera • Vespa 125 Primavera ET3 • Vespa  
PK 50-125S • Vespa PK 50-125XL



121860490 **NEW**



GOMMINO COPRILEVETTA SELLA | *SEAT LEVER  
GROMMET*

Vespa 50 N-R-L • Vespa 50 Special • Vespa 125  
Primavera • Vespa 125 Primavera ET3 • Vespa  
Sprint/Sprint Veloce • Vespa 150 GL • Vespa  
125 GT • Vespa 125 GTR • Vespa 125 TS •  
Vespa 180 SS



121860450 **NEW**



MANIGLIA SELLA | *SEAT HANDLE*

Vespa 125 Primavera • Vespa 125 Primavera  
ET3 • Vespa Sprint/Sprint Veloce • Vespa 150  
GL • Vespa 125 GT • Vespa 125 GTR • Vespa  
125 TS • Vespa 180 SS



121860460 **NEW**



MANIGLIA SELLA | *SEAT HANDLE*

Vespa PK 125S • Vespa PK 125XL • Vespa PK  
Automatica • Vespa 50 HP • Vespa 125 FL2



121860470 **NEW**



MANIGLIA SELLA | *SEAT HANDLE*

Vespa PX 125-150-200 • Vespa PX 125-150-200  
Arcobaleno • Vespa PX Millennium





**ACCESSORI SELLE - SEATS ACCESSORIES****142760037** **NEW**COPERTINA SELLA CON GOBBA | *SEAT COVER WITH HUMP*

Vespa 50 N-L-R • Vespa 50 Special

**142760038** **NEW**COPERTINA SELLA | *SEAT COVER*Vespa 125 GTR • Vespa 125 GT • Vespa Sprint  
• Vespa 150 GL**142760039** **NEW**COPERTINA SELLA | *SEAT COVER*

Vespa 125 Primavera

**142760100** **NEW**COPERTINA SELLA | *SEAT COVER*Colore Nero | *Black colour*Vespa 125 VNB 1/6 • Vespa 125 GT/GTR 1° serie  
• Vespa 125 Super • Vespa 125 TS • Vespa 150  
VBA • Vespa 150 VBB • Vespa 150 GL • Vespa  
150 Sprint/V 1° serie • Vespa 150 Super 1° serie

## ACCESSORI SELLE - SEATS ACCESSORIES

142760101 **NEW**



COPERTINA SELLA | SEAT COVER

Colore Blu | Blue colour

Vespa 125 VNB 1/6 • Vespa 125 GT/GTR 1° serie  
 • Vespa 125 Super • Vespa 125 TS • Vespa 150  
 VBA • Vespa 150 VBB • Vespa 150 GL • Vespa  
 150 Sprint/V 1° serie • Vespa 150 Super 1° serie



142760102 **NEW**



COPERTINA SELLA | SEAT COVER

Colore Verde | Green colour

Vespa 125 VNB 1/6 • Vespa 125 GT/GTR 1° serie  
 • Vespa 125 Super • Vespa 125 TS • Vespa 150  
 VBA • Vespa 150 VBB • Vespa 150 GL • Vespa  
 150 Sprint/V 1° serie • Vespa 150 Super 1° serie



142760106 **NEW**



COPERTINA SELLA | SEAT COVER

Vespa V30-V33 • Vespa VM1-2 • Vespa VN1-VN2



## ACCESSORI TELAIO - CHASSIS ACCESSORIES

121830080



GOMMINO LEVA MESSA IN MOTO | KICKSTART  
 RUBBER

Confezioni 5 pz. | 5 Pcs Packing

Vespa PX PE • Vespa Sprint • Vespa Super •  
 Vespa Rally  
 R.O. 241004



**ACCESSORI TELAI0 - CHASSIS ACCESSORIES****121830900**GOMMINO LEVA MESSA IN MOTO | *KICKSTART RUBBER*Confezioni 5 pz. | *5 Pcs Packing*Vespa tutti i modelli | *All models ('59 - '85)*

R.O. 049642, GI 49642

**121855000**SCODELLINO DADO RUOTA POSTERIORE -  
ANTERIORE | *REAR FRONT WHEEL SHAFT CAP*Confezioni 5 pz. | *5 Pcs Packing*

Vespa PK • Vespa PK XL • Vespa N • Vespa FL2

• Vespa PX PE Arcobaleno

R.O. 194423

**121858460**DADO PERNO RUOTA | *WHEEL PIN NUTS*Confezione 10 pz. | *10 Pcs Packing*

M12x1,75

Vespa PK 125-150-200 • Vespa PK 125-150-  
200XL • Vespa PX 125-150-200 • Vespa PXE  
125-150-200 Arcobaleno • Vespa 125-150-200

Primavera

R.O. 015222

**121860340**DADO CERCHIO RUOTA | *WHEEL NUT*Confezione 4 pz. | *4 Pcs Packing*

M10x22

Vespa 125 VNB3-6T • Vespa 150 VBB1T  
71001>VBB2T

R.O. 019411, 012131, 0197750, S.12131

**121858450**VITE + DADO MANUBRIO | *HANDLE BAR  
SCREW + NUT*Confezione 5 pz. | *5 Pcs Packing*

Vespa 50-125-150 ('63&gt;)

R.O. 0015542, 070620, S.15542



**121860023**



PIASTRINA FERMA GUAINA | *CABLE PLATE*

Confezione 10 pz. | *10 Pcs Packing*

Vespa PX-PE Arcobaleno • Vespa old models

R.O. 82385



**121860373**



FERMO DADO RUOTA ANTERIORE | *FRONT*

*WHEEL NUT LOCK*

Confezione 10 pz. | *10 Pcs Packing*

Vespa PX 125-150-200 • Vespa PK XL • Vespa

FL

R.O. 177609



**225180180**



ASSE RUOTA ANTERIORE | *FRONT AXLE*

Vespa 50-90 • Vespa 125 Primavera • Vespa

ET3 • Vespa PK 50 • Vespa PKS

R.O. 100483, 1582516, 158251



**225180183** **NEW**



ASSE RUOTA ANTERIORE | *FRONT AXLE*

Vespa 50 • Vespa 125



**121850360**



DADO FRESATO FISSA TAMBURO RUOTA  
POSTERIORE | *REAR WHEEL DRUM SECURING*  
*NUT*

Confezione 5 pz. | *5 Pcs Packing*

Vespa 50-90 • Vespa 125 Primavera • Vespa

ET3 • Vespa Super • Vespa Sprint • Vespa PX PE

Arcobaleno

R.O. 002314



**ACCESSORI TELAI0 - CHASSIS ACCESSORIES****KIT GOMMINI TELAI0 - FRAME RUBBERS KIT****142640500**

Vespa 50-90 • Vespa 125 Primavera • Vespa ET3

Composto da pezzi 22 | *Made by 22 pcs*

Codice RMS <i>RMS Code</i>	Descrizione <i>Description</i>	Quantità <i>Quantity</i>
121830290	Tappo mozzo anteriore   <i>Plug hub</i>	1
121830320	Tassello feritoia volano   <i>Flywheel plug</i>	1
121830340	Asta rubinetto benzina   <i>Tie rod</i>	1
121830350	Ammortizzatore posteriore   <i>Rear damper</i>	1
121830370	Tappo benzina   <i>Fuel cap</i>	1
121830380	Tampone di scontro carter   <i>Buffer</i>	2
121830410	Passacavo telaio   <i>Frame buffer</i>	1
121830430	Clacson   <i>Horn</i>	1
121830490	Sportello motore   <i>Engine door</i>	6
121830460	Fondello bloccasterzo   <i>Lock</i>	1
121830500	Pedale freno   <i>Brake</i>	1
121830530	Rubinetto benzina   <i>Fuel cock</i>	1
121830560	Bobina   <i>Coil</i>	1
121830600	Ammortizzatore anteriore   <i>Front damper</i>	2

**142640540**

Vespa 150 GL Sprint anni '60

Composto da pezzi 19 | *Made by 19 pcs*

Codice RMS <i>RMS Code</i>	Descrizione <i>Description</i>	Quantità <i>Quantity</i>
100706210	Coperchio frizione   <i>Clutch cover</i>	1
121830090	Passacavo   <i>Grommet</i>	1
121830300	Tappo benzina   <i>Fuel cap</i>	1
121830330	Depuratore   <i>Air cleaner</i>	1
121830340	Asta rubinetto   <i>Tie rod</i>	1
121830350	Ammortizzatore posteriore   <i>Rear damper</i>	1
121830360	Passacavo telaio   <i>Frame grommet</i>	1
121830400	Tampone di scontro carter   <i>Buffer</i>	2
121830430	Clacson   <i>Horn</i>	1
121850450	Gommino pedale freno   <i>Pedal Rubber</i>	1
121830460	Fondello bloccasterzo   <i>Lock</i>	1
121830510	Tampone motore   <i>Engine buffer</i>	1
121830520	Tampone motore   <i>Engine buffer</i>	1
121830530	Rubinetto benzina   <i>Fuel cock</i>	1
121830560	Bobina   <i>Coil</i>	1
121830843	Cappuccio Candela   <i>Spark Plug cap</i>	1
121830900	Leva messa in moto   <i>Starter lever</i>	1
142640543	Kit gommini cofano   <i>Rubber hood kit</i>	1



## ACCESSORI TELAIO - CHASSIS ACCESSORIES

**142640520**



Vespa PX 125-150-200 • Vespa PXE Arcobaleno  
Composto da pezzi 21 | *Made by 21 pcs*

Codice RMS <i>RMS Code</i>	Descrizione <i>Description</i>	Quantità <i>Quantity</i>
121830230	Cappuccio candela   <i>Spark plug</i>	1
121830080	Leva messa in moto   <i>Kick starter lever</i>	1
100706210	Coperchio frizione   <i>Clutch cover</i>	1
121830090	Passacavo   <i>Grommet</i>	1
121830110	Passacavo cofano   <i>Cowl grommet</i>	1
121830300	Tappo benzina   <i>Fuel cap</i>	1
121830330	Depuratore   <i>Air cleaner</i>	1
121830340	Asta rubinetto   <i>Tie rod</i>	1
121830350	Ammortizzatore posteriore   <i>Rear damper</i>	1
121830360	Passacavo telaio   <i>Frame grommet</i>	1
121830400	Tampone di scontro carter   <i>Buffer</i>	2
121830420	Tubetto cofano   <i>Tube cowl</i>	2
121830460	Fondello bloccasterzo   <i>Lock</i>	1
121830470	Soffietto cavo frizione   <i>Clutch cable folding</i>	1
121830480	Pedale freno   <i>Brake pedal</i>	1
121830510	Tampone motore   <i>Engine buffer</i>	1
121830520	Tampone motore   <i>Engine buffer</i>	1



**142640530**



Vespa PK 50-125  
Composto da pezzi 17 | *Made by 17 pcs*

Codice RMS <i>RMS Code</i>	Descrizione <i>Description</i>	Quantità <i>Quantity</i>
121830230	Cappuccio candela   <i>Spark plug</i>	1
121830290	Tappo mozzo anteriore   <i>Plug hub</i>	1
121830340	Asta rubinetto benzina   <i>Tie rod</i>	1
121830370	Tappo benzina   <i>Fuel cap</i>	1
121830390	Tampone di scontro carter   <i>Buffer</i>	1
121830480	Pedale freno   <i>Brake pedal</i>	1
121830490	Sportello motore   <i>Engine door</i>	6
121830530	Rubinetto benzina   <i>Fuel cock</i>	1
121830560	Bobina   <i>Coil</i>	1
121830570	Cappuccio Centralina   <i>Ignition Device</i>	1
121830600	Ammortizzatore anteriore   <i>Front damper</i>	2



# SOSPENSIONI

S U S P E N S I O N S

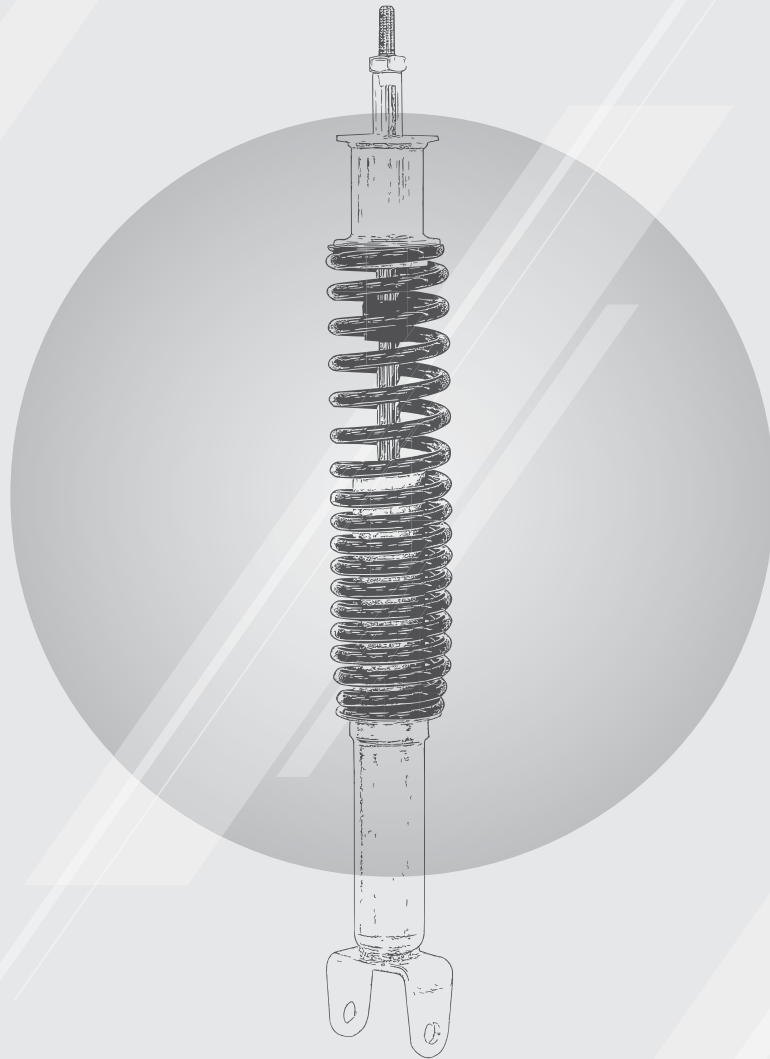

## AMMORTIZZATORI - SHOCK ABSORBERS

204550292



Vespa 50-90-125 • Vespa Primavera • Vespa PK 50 • Vespa PX PE • Vespa PX PE Arcobaleno •  
Vespa PX 125-150-200 • Vespa 125 T5 •  
Vespa Sprint Veloce • Vespa GL • Vespa 200 Rally

LUNGHEZZA LENGTH (mm)	ATTACCO SUPERIORE UPPER FASTENING POINT			ATTACCO INFERIORE LOWER FASTENING POINT		
	TIPO - TYPE	D (mm)	W (mm)	TIPO - TYPE	D (mm)	W (mm)
348		M9x1,25	16		9,6	47



204550382



Vespa PK 50-125 • Vespa PK 50-125XL • Vespa PK Rush

LUNGHEZZA LENGTH (mm)	ATTACCO SUPERIORE UPPER FASTENING POINT			ATTACCO INFERIORE LOWER FASTENING POINT		
	TIPO - TYPE	D (mm)	W (mm)	TIPO - TYPE	D (mm)	W (mm)
353		M9x1,25	24		9,6	47



204550412



Vespa PX 125 EU2 ('01-'07) • Vespa PX 30 anni ('07-'08) • Vespa PX ('98-'13) • Vespa PXE Arcobaleno •  
Vespa PX 200 • Vespa PX freno a disco - with brake disc

LUNGHEZZA LENGTH (mm)	ATTACCO SUPERIORE UPPER FASTENING POINT			ATTACCO INFERIORE LOWER FASTENING POINT		
	TIPO - TYPE	D (mm)	W (mm)	TIPO - TYPE	D (mm)	W (mm)
391		M9x1,25	16		9,6	47





**AMMORTIZZATORI - SHOCK ABSORBERS**

**204550872**



Vespa 50-90-125 Primavera • Vespa PK 50 • Vespa PX PE • Vespa PX PE Arcobaleno • Vespa PX 125-150-200 • Vespa 125 T5 • Vespa Sprint Veloce • Vespa GL • Vespa 200 Rally

LUNGHEZZA LENGTH (mm)	ATTACCO SUPERIORE UPPER FASTENING POINT			ATTACCO INFERIORE LOWER FASTENING POINT		
	TIPO - TYPE	D (mm)	W (mm)	TIPO - TYPE	D (mm)	W (mm)
348		M9x1,25	16		9,6	47



**204550892**



Cosa 125-150-200 • Vespa Cosa 2 125-150-200  
R.O. 2681414, 229529

LUNGHEZZA LENGTH (mm)	ATTACCO SUPERIORE UPPER FASTENING POINT			ATTACCO INFERIORE LOWER FASTENING POINT		
	TIPO - TYPE	D (mm)	W (mm)	TIPO - TYPE	D (mm)	W (mm)
453		M9x1,25	22		10	50



**204551180**



Vespa PX 125 EU2 ('01-'07) • Vespa PX 30 anni ('07-'08) • Vespa PX ('98-'13) • Vespa PXE Arcobaleno • Vespa PX 200 • Vespa PX freno a disco - *with brake disc*



LUNGHEZZA LENGTH (mm)	ATTACCO SUPERIORE UPPER FASTENING POINT			ATTACCO INFERIORE LOWER FASTENING POINT		
	TIPO - TYPE	D (mm)	W (mm)	TIPO - TYPE	D (mm)	W (mm)
348		M9x1,25	16		9,6	47



204560182



Vespa 50 S-90-90SS • Vespa 125 Primavera ET3 • Vespa PX PE • Vespa PX PE Arcobaleno  
 Adattabile a - *Suitable for* Vespa PX freno a disco con ausilio di estensione • Vespa Sprint Veloce •  
 Vespa GL • Vespa 200 Rally  
 R.O. 246620, 174238, 73756, 150397, 101195, 70643



LUNGHEZZA LENGTH (mm)	ATTACCO SUPERIORE UPPER FASTENING POINT			ATTACCO INFERIORE LOWER FASTENING POINT		
	TIPO - TYPE	D (mm)	W (mm)	TIPO - TYPE	D (mm)	W (mm)
348		M9x1,25	16		9,6	47



204560191



Vespa 50 S-90-90SS • Vespa 125 Primavera ET3 • Vespa PX PE • Vespa PX PE Arcobaleno  
 Adattabile a - *Suitable for* Vespa PX Freno a disco con ausilio di estensione • Vespa Sprint Veloce •  
 Vespa GL • Vespa 200 Rally  
 R.O. 83816, 82230, 610294M



LUNGHEZZA LENGTH (mm)	ATTACCO SUPERIORE UPPER FASTENING POINT			ATTACCO INFERIORE LOWER FASTENING POINT		
	TIPO - TYPE	D (mm)	W (mm)	TIPO - TYPE	D (mm)	W (mm)
344		M9x1,25	16		9,8	47



204560192



Vespa 50 S-90-90SS • Vespa 125 Primavera ET3 • Vespa PX PE • Vespa PX PE Arcobaleno  
 Adattabile a - *Suitable for* Vespa PX Freno a disco con ausilio di estensione • Vespa Sprint Veloce •  
 Vespa GL • Vespa 200 Rally  
 R.O. 83816, 82230, 610294M

LUNGHEZZA LENGTH (mm)	ATTACCO SUPERIORE UPPER FASTENING POINT			ATTACCO INFERIORE LOWER FASTENING POINT		
	TIPO - TYPE	D (mm)	W (mm)	TIPO - TYPE	D (mm)	W (mm)
344		M9x1,25	16		9,6	47



**AMMORTIZZATORI - SHOCK ABSORBERS**

**204560193**



Vespa 50-90 • Vespa 125 Primavera • Vespa PK 50 • Vespa PX PE • Vespa PX PE Arcobaleno • Vespa PX 125-150-200 • Vespa 125 T5 • Vespa Sprint Veloce • Vespa GL • Vespa 200 Rally

LUNGHEZZA LENGTH (mm)	ATTACCO SUPERIORE UPPER FASTENING POINT			ATTACCO INFERIORE LOWER FASTENING POINT		
	TIPO - TYPE	D (mm)	W (mm)	TIPO - TYPE	D (mm)	W (mm)
344		M9x1,25	16		9,6	47



**204560201**



Vespa PK 50-125 • Vespa PK 50-125XL • Vespa PK Rush  
R.O. 266426, 240267, 2664264

LUNGHEZZA LENGTH (mm)	ATTACCO SUPERIORE UPPER FASTENING POINT			ATTACCO INFERIORE LOWER FASTENING POINT		
	TIPO - TYPE	D (mm)	W (mm)	TIPO - TYPE	D (mm)	W (mm)
348		M8x1,0	30		9,6	47



**204560202**



Vespa PK 50-125 • Vespa PK 50-125XL • Vespa PK Rush  
R.O. 266426, 240267, 2664264



LUNGHEZZA LENGTH (mm)	ATTACCO SUPERIORE UPPER FASTENING POINT			ATTACCO INFERIORE LOWER FASTENING POINT		
	TIPO - TYPE	D (mm)	W (mm)	TIPO - TYPE	D (mm)	W (mm)
348		M8x1,0	30		9,6	47



204560212



Vespa PK 50-125 • Vespa PK 50-125XL • Vespa PK Rush  
R.O. 2664264



LUNGHEZZA LENGTH (mm)	ATTACCO SUPERIORE UPPER FASTENING POINT			ATTACCO INFERIORE LOWER FASTENING POINT		
	TIPO - TYPE	D (mm)	W (mm)	TIPO - TYPE	D (mm)	W (mm)
348		M8x1,0	30		9,6	47



204560242



Vespa 125 ('58-'63) VNA-VNB1/2/3-VNB4 fino al telaio n.114713 - till chassis n.114713  
R.O. 083816, 20360, 82230



LUNGHEZZA LENGTH (mm)	ATTACCO SUPERIORE UPPER FASTENING POINT			ATTACCO INFERIORE LOWER FASTENING POINT		
	TIPO - TYPE	D (mm)	W (mm)	TIPO - TYPE	D (mm)	W (mm)
355		M9x1,25	16		9,2	47



204560272



Vespa PX 125 EU2 ('01-'07) • Vespa PX 30 anni ('07-09) • Vespa PX ('98-'13) • Vespa PXE Arcobaleno •  
Vespa PX 200 • Vespa PX con freno a disco - with brake disc  
R.O. 56188R, 58571R5

LUNGHEZZA LENGTH (mm)	ATTACCO SUPERIORE UPPER FASTENING POINT			ATTACCO INFERIORE LOWER FASTENING POINT		
	TIPO - TYPE	D (mm)	W (mm)	TIPO - TYPE	D (mm)	W (mm)
391		M9x1,25	16		9,6	47



**AMMORTIZZATORI - SHOCK ABSORBERS**

**204560282**



Vespa 50 N-R V5A1T ('63-' 83)  
R.O. 83816, 82230, 610294M

LUNGHEZZA LENGTH (mm)	ATTACCO SUPERIORE UPPER FASTENING POINT			ATTACCO INFERIORE LOWER FASTENING POINT		
	TIPO - TYPE	D (mm)	W (mm)	TIPO - TYPE	D (mm)	W (mm)
344		M9x1,25	16		9,6	47



**204584242**



Vespa 50-90 • Vespa 125 Primavera • Vespa PK 50 • Vespa Rush  
R.O. 1379364

LUNGHEZZA LENGTH (mm)	ATTACCO SUPERIORE UPPER FASTENING POINT			ATTACCO INFERIORE LOWER FASTENING POINT		
	TIPO - TYPE	D (mm)	W (mm)	TIPO - TYPE	D (mm)	W (mm)
217		M8x1,0	25		14,1	40



**204584243**



Vespa 50-90 • Vespa 125 Primavera • Vespa PK 50 • Vespa Rush  
R.O. 1379365

LUNGHEZZA LENGTH (mm)	ATTACCO SUPERIORE UPPER FASTENING POINT			ATTACCO INFERIORE LOWER FASTENING POINT		
	TIPO - TYPE	D (mm)	W (mm)	TIPO - TYPE	D (mm)	W (mm)
217		M8x1,0	25		14,1	40





## AMMORTIZZATORI - SHOCK ABSORBERS

204584251



Vespa 50-90 • Vespa 125 Primavera • Vespa PK 50



LUNGHEZZA LENGTH (mm)	ATTACCO SUPERIORE UPPER FASTENING POINT			ATTACCO INFERIORE LOWER FASTENING POINT		
	TIPO - TYPE	D (mm)	W (mm)	TIPO - TYPE	D (mm)	W (mm)
215		M8x1,0	30		14,1	40



204584252



Vespa 50-90 • Vespa 125 Primavera • Vespa PK 50



LUNGHEZZA LENGTH (mm)	ATTACCO SUPERIORE UPPER FASTENING POINT			ATTACCO INFERIORE LOWER FASTENING POINT		
	TIPO - TYPE	D (mm)	W (mm)	TIPO - TYPE	D (mm)	W (mm)
215		M8x1,0	30		14,1	40



204584262



Vespa PK 125 • Vespa PK 125XL • Vespa Rush  
R.O. 266538, 225739, 2665384, 6022020

LUNGHEZZA LENGTH (mm)	ATTACCO SUPERIORE UPPER FASTENING POINT			ATTACCO INFERIORE LOWER FASTENING POINT		
	TIPO - TYPE	D (mm)	W (mm)	TIPO - TYPE	D (mm)	W (mm)
253		M10x1,25	17		M8x1,25	35



**AMMORTIZZATORI - SHOCK ABSORBERS**

**204584272**



Vespa 125-150 ('60>) • Vespa GL • Vespa GTR • Vespa TS • Vespa 150 Sprint Veloce • Vespa 150 Super • Vespa 200 Rally (' 63-'83)  
R.O. 137571, 150398, 028513, 1011BCR

LUNGHEZZA LENGTH (mm)	ATTACCO SUPERIORE UPPER FASTENING POINT			ATTACCO INFERIORE LOWER FASTENING POINT		
	TIPO - TYPE	D (mm)	W (mm)	TIPO - TYPE	D (mm)	W (mm)
212		11,2	20		11,2	26



**204584292**



Vespa PX PE • Vespa PX PE Arcobaleno • Vespa PX 125-150-200 • Vespa 125 T5

LUNGHEZZA LENGTH (mm)	ATTACCO SUPERIORE UPPER FASTENING POINT			ATTACCO INFERIORE LOWER FASTENING POINT		
	TIPO - TYPE	D (mm)	W (mm)	TIPO - TYPE	D (mm)	W (mm)
310		M10x1,25	14		8,1	38



**204584302**



Vespa PK 125 • Vespa PK 125XL • Vespa PK Rush

LUNGHEZZA LENGTH (mm)	ATTACCO SUPERIORE UPPER FASTENING POINT			ATTACCO INFERIORE LOWER FASTENING POINT		
	TIPO - TYPE	D (mm)	W (mm)	TIPO - TYPE	D (mm)	W (mm)
253		M10x1,25	17		M8x1,25	35



## AMMORTIZZATORI - SHOCK ABSORBERS

204584312



Vespa PX PE • Vespa PX PE Arcobaleno • Vespa PX 125-150-200 • Vespa 125 T5

LUNGHEZZA LENGTH (mm)	ATTACCO SUPERIORE UPPER FASTENING POINT			ATTACCO INFERIORE LOWER FASTENING POINT		
	TIPO - TYPE	D (mm)	W (mm)	TIPO - TYPE	D (mm)	W (mm)
310		M10x1,25	14		8,1	38



204584332



Vespa PX  
Veicoli con freno a disco | Models with brake disc  
R.O. 56286R, 56263R, 601876, 597765, 56192R

LUNGHEZZA LENGTH (mm)	ATTACCO SUPERIORE UPPER FASTENING POINT			ATTACCO INFERIORE LOWER FASTENING POINT		
	TIPO - TYPE	D (mm)	W (mm)	TIPO - TYPE	D (mm)	W (mm)
310		M10x1,25	14		8,1	38



204584342



Vespa PX PE • Vespa PX PE Arcobaleno • Vespa PX 125-150-200 • Vespa 125 T5

LUNGHEZZA LENGTH (mm)	ATTACCO SUPERIORE UPPER FASTENING POINT			ATTACCO INFERIORE LOWER FASTENING POINT		
	TIPO - TYPE	D (mm)	W (mm)	TIPO - TYPE	D (mm)	W (mm)
310		M10x1,25	14		M8x1,25	38





**AMMORTIZZATORI - SHOCK ABSORBERS**

**204584362**



Vespa 50 N-R V5A1T ('63-'83)  
R.O. 100282

LUNGHEZZA LENGTH (mm)	ATTACCO SUPERIORE UPPER FASTENING POINT			ATTACCO INFERIORE LOWER FASTENING POINT		
	TIPO - TYPE	D (mm)	W (mm)	TIPO - TYPE	D (mm)	W (mm)
214		M8x1,0	16		14,1	40



**204584391**



Vespa PX PE • Vespa PX PE Arcobaleno • Vespa PX 125-150-200 • Vespa 125 T5  
R.O. 232928

LUNGHEZZA LENGTH (mm)	ATTACCO SUPERIORE UPPER FASTENING POINT			ATTACCO INFERIORE LOWER FASTENING POINT		
	TIPO - TYPE	D (mm)	W (mm)	TIPO - TYPE	D (mm)	W (mm)
310		M10x1,25	12,5		8,5	38



**204584392**



Vespa PX PE • Vespa PX PE Arcobaleno • Vespa PX 125-150-200 • Vespa 125 T5  
R.O. 232929

LUNGHEZZA LENGTH (mm)	ATTACCO SUPERIORE UPPER FASTENING POINT			ATTACCO INFERIORE LOWER FASTENING POINT		
	TIPO - TYPE	D (mm)	W (mm)	TIPO - TYPE	D (mm)	W (mm)
310		M10x1,25	12,5		8,5	38



204584402



Vespa 125 T5  
R.O. 232928, 174446

LUNGHEZZA LENGTH (mm)	ATTACCO SUPERIORE UPPER FASTENING POINT			ATTACCO INFERIORE LOWER FASTENING POINT		
	TIPO - TYPE	D (mm)	W (mm)	TIPO - TYPE	D (mm)	W (mm)
310		M10x1,25	14		8,1	38



204584412



Vespa PX PE • Vespa PX PE Arcobaleno • Vespa PX 125-150-200 • Vespa 125 T5

LUNGHEZZA LENGTH (mm)	ATTACCO SUPERIORE UPPER FASTENING POINT			ATTACCO INFERIORE LOWER FASTENING POINT		
	TIPO - TYPE	D (mm)	W (mm)	TIPO - TYPE	D (mm)	W (mm)
310		M10x1,25	14		8,1	38



204584430



Vespa PX PE • Vespa PX PE Arcobaleno • Vespa PX 125-150-200 • Vespa 125 T5 • Cosa

LUNGHEZZA LENGTH (mm)	ATTACCO SUPERIORE UPPER FASTENING POINT			ATTACCO INFERIORE LOWER FASTENING POINT		
	TIPO - TYPE	D (mm)	W (mm)	TIPO - TYPE	D (mm)	W (mm)
310		M10x1,25	14		8,1	38



**AMMORTIZZATORI - SHOCK ABSORBERS**

**204585043**



Vespa PX 125 EU2 ('01-'07) • Vespa PX 30 anni ('07-'08) • Vespa PX ('98-'13) • Vespa PXE Arcobaleno • Vespa PX 200 • Vespa PX freno a disco - *with brake disc*

LUNGHEZZA LENGTH (mm)	ATTACCO SUPERIORE UPPER FASTENING POINT			ATTACCO INFERIORE LOWER FASTENING POINT		
	TIPO - TYPE	D (mm)	W (mm)	TIPO - TYPE	D (mm)	W (mm)
310		M10x1,25	12,5		8,5	38



**204585062**



Vespa 125-150 ('60>) • Vespa GL • Vespa GTR • Vespa TS • Vespa 150 Sprint Veloce • Vespa 150 Super • Vespa 200 Rally ('63-'83)  
R.O. 1375714001

LUNGHEZZA LENGTH (mm)	ATTACCO SUPERIORE UPPER FASTENING POINT			ATTACCO INFERIORE LOWER FASTENING POINT		
	TIPO - TYPE	D (mm)	W (mm)	TIPO - TYPE	D (mm)	W (mm)
212		11,2	20		11,2	26



**204585072**



Vespa 50-90 • Vespa 125 Primavera • Vespa PK 50

LUNGHEZZA LENGTH (mm)	ATTACCO SUPERIORE UPPER FASTENING POINT			ATTACCO INFERIORE LOWER FASTENING POINT		
	TIPO - TYPE	D (mm)	W (mm)	TIPO - TYPE	D (mm)	W (mm)
217		M8x1,0	16		14,1	40



204585082



Vespa 125 Primavera ET3  
R.O. 1379364

LUNGHEZZA LENGTH (mm)	ATTACCO SUPERIORE UPPER FASTENING POINT			ATTACCO INFERIORE LOWER FASTENING POINT		
	TIPO - TYPE	D (mm)	W (mm)	TIPO - TYPE	D (mm)	W (mm)
220		M8x1,0	14		14	40



204585092



Vespa 50-90 • Vespa 125 Primavera • Vespa PK 50

LUNGHEZZA LENGTH (mm)	ATTACCO SUPERIORE UPPER FASTENING POINT			ATTACCO INFERIORE LOWER FASTENING POINT		
	TIPO - TYPE	D (mm)	W (mm)	TIPO - TYPE	D (mm)	W (mm)
220		M8x1,0	14		14	40



204585102



Cosa 125 -150-200 • Cosa 2 125-150-200 ('91-'97)  
R.O. 228627

LUNGHEZZA LENGTH (mm)	ATTACCO SUPERIORE UPPER FASTENING POINT			ATTACCO INFERIORE LOWER FASTENING POINT		
	TIPO - TYPE	D (mm)	W (mm)	TIPO - TYPE	D (mm)	W (mm)
312		M10x1,25	12		8	38



**AMMORTIZZATORI - SHOCK ABSORBERS**



204590158

**NEW**



Vespa 50 • Vespa 125 Primavera ET3 • Vespa PK S XL HP FL2

LUNGHEZZA LENGTH (mm)	ATTACCO SUPERIORE UPPER FASTENING POINT			ATTACCO INFERIORE LOWER FASTENING POINT		
	TIPO - TYPE	D (mm)	W (mm)	TIPO - TYPE	D (mm)	W (mm)
330		M10x1,25	-		M10x1,25	



204590081

**NEW**



Vespa 50 • Vespa 125 Primavera ET3 • Vespa PK S XL HP FL2

LUNGHEZZA LENGTH (mm)	ATTACCO SUPERIORE UPPER FASTENING POINT			ATTACCO INFERIORE LOWER FASTENING POINT		
	TIPO - TYPE	D (mm)	W (mm)	TIPO - TYPE	D (mm)	W (mm)
330		M10x1,25	-		M10x1,25	



204590381

**NEW**



Vespa 50 • Vespa 125 Primavera ET3 • Vespa PK 50-125S

LUNGHEZZA LENGTH (mm)	ATTACCO SUPERIORE UPPER FASTENING POINT			ATTACCO INFERIORE LOWER FASTENING POINT		
	TIPO - TYPE	D (mm)	W (mm)	TIPO - TYPE	D (mm)	W (mm)
200		M10x1,25	-		14	



## AMMORTIZZATORI - SHOCK ABSORBERS



204590391

NEW



Cosa 125-150-200

LUNGHEZZA LENGTH (mm)	ATTACCO SUPERIORE UPPER FASTENING POINT			ATTACCO INFERIORE LOWER FASTENING POINT		
	TIPO - TYPE	D (mm)	W (mm)	TIPO - TYPE	D (mm)	W (mm)
265		M10x1,25	-		8	35/38



204593096

NEW



Vespa PK XL HP FL2

LUNGHEZZA LENGTH (mm)	ATTACCO SUPERIORE UPPER FASTENING POINT			ATTACCO INFERIORE LOWER FASTENING POINT		
	TIPO - TYPE	D (mm)	W (mm)	TIPO - TYPE	D (mm)	W (mm)
200		M10x1,25	-		M8x1,25	35



204593138

NEW



Vespa PK XL HP FL2

LUNGHEZZA LENGTH (mm)	ATTACCO SUPERIORE UPPER FASTENING POINT			ATTACCO INFERIORE LOWER FASTENING POINT		
	TIPO - TYPE	D (mm)	W (mm)	TIPO - TYPE	D (mm)	W (mm)
200		M10x1,25	-		M8x1,25	35



**AMMORTIZZATORI - SHOCK ABSORBERS**



204593095 **NEW**



Vespa PK S XL HP FL2

LUNGHEZZA LENGTH (mm)	ATTACCO SUPERIORE UPPER FASTENING POINT			ATTACCO INFERIORE LOWER FASTENING POINT		
	TIPO - TYPE	D (mm)	W (mm)	TIPO - TYPE	D (mm)	W (mm)
345		M9x1,25	-		8	48



204593139 **NEW**



Vespa 50 • Vespa 125 Primavera ET3 • Vespa PK S XL HP FL2

LUNGHEZZA LENGTH (mm)	ATTACCO SUPERIORE UPPER FASTENING POINT			ATTACCO INFERIORE LOWER FASTENING POINT		
	TIPO - TYPE	D (mm)	W (mm)	TIPO - TYPE	D (mm)	W (mm)
345		M9x1,25	-		8	48



204590386 **NEW**



Vespa PK XL HP FL2

LUNGHEZZA LENGTH (mm)	ATTACCO SUPERIORE UPPER FASTENING POINT			ATTACCO INFERIORE LOWER FASTENING POINT		
	TIPO - TYPE	D (mm)	W (mm)	TIPO - TYPE	D (mm)	W (mm)
200		M10x1,25	-		8	35/38



## AMMORTIZZATORI - SHOCK ABSORBERS



204590118

NEW



Vespa PK S XL HP FL2

LUNGHEZZA LENGTH (mm)	ATTACCO SUPERIORE UPPER FASTENING POINT			ATTACCO INFERIORE LOWER FASTENING POINT		
	TIPO - TYPE	D (mm)	W (mm)	TIPO - TYPE	D (mm)	W (mm)
330		M10x1,25	-		M10x1,25	48



204590390

NEW



Vespa PX 125-150-200

LUNGHEZZA LENGTH (mm)	ATTACCO SUPERIORE UPPER FASTENING POINT			ATTACCO INFERIORE LOWER FASTENING POINT		
	TIPO - TYPE	D (mm)	W (mm)	TIPO - TYPE	D (mm)	W (mm)
255		M10x1,25	-		8	35/38



204592777

NEW



Vespa PX 125-150-200

LUNGHEZZA LENGTH (mm)	ATTACCO SUPERIORE UPPER FASTENING POINT			ATTACCO INFERIORE LOWER FASTENING POINT		
	TIPO - TYPE	D (mm)	W (mm)	TIPO - TYPE	D (mm)	W (mm)
255		M10x1,25	-		8	35/38





**AMMORTIZZATORI - SHOCK ABSORBERS**



204590168

**NEW**



Vespa PX 125-150-200

LUNGHEZZA LENGTH (mm)	ATTACCO SUPERIORE UPPER FASTENING POINT			ATTACCO INFERIORE LOWER FASTENING POINT		
	TIPO - TYPE	D (mm)	W (mm)	TIPO - TYPE	D (mm)	W (mm)
340		M9x1,25	-		M10x1,25	48



204590119

**NEW**



Vespa PX 125-150-200 • Vespa 50 • Vespa 125 Primavera

LUNGHEZZA LENGTH (mm)	ATTACCO SUPERIORE UPPER FASTENING POINT			ATTACCO INFERIORE LOWER FASTENING POINT		
	TIPO - TYPE	D (mm)	W (mm)	TIPO - TYPE	D (mm)	W (mm)
340		M9x1,25	-		M10x1,25	48



204590076

**NEW**



Vespa PX 125-150-200 • Vespa 50 • Vespa 125 Primavera

LUNGHEZZA LENGTH (mm)	ATTACCO SUPERIORE UPPER FASTENING POINT			ATTACCO INFERIORE LOWER FASTENING POINT		
	TIPO - TYPE	D (mm)	W (mm)	TIPO - TYPE	D (mm)	W (mm)
340		M9x1,25	-		M10x1,25	48





204593008

NEW



Vespa PX 125-150-200

LUNGHEZZA LENGTH (mm)	ATTACCO SUPERIORE UPPER FASTENING POINT			ATTACCO INFERIORE LOWER FASTENING POINT		
	TIPO - TYPE	D (mm)	W (mm)	TIPO - TYPE	D (mm)	W (mm)
255		M10x1,25	-		M8x1,25	38



204592919

NEW



Vespa PX 125-150-200

LUNGHEZZA LENGTH (mm)	ATTACCO SUPERIORE UPPER FASTENING POINT			ATTACCO INFERIORE LOWER FASTENING POINT		
	TIPO - TYPE	D (mm)	W (mm)	TIPO - TYPE	D (mm)	W (mm)
255		M10x1,25	-		M8x1,25	38



204592778

NEW



Vespa PX 125-150-200

LUNGHEZZA LENGTH (mm)	ATTACCO SUPERIORE UPPER FASTENING POINT			ATTACCO INFERIORE LOWER FASTENING POINT		
	TIPO - TYPE	D (mm)	W (mm)	TIPO - TYPE	D (mm)	W (mm)
255		M10x1,25	-		M8x1,25	38



**AMMORTIZZATORI - SHOCK ABSORBERS**



204593161

**NEW**



Vespa PX 125-150-200

LUNGHEZZA LENGTH (mm)	ATTACCO SUPERIORE UPPER FASTENING POINT			ATTACCO INFERIORE LOWER FASTENING POINT		
	TIPO - TYPE	D (mm)	W (mm)	TIPO - TYPE	D (mm)	W (mm)
340		M9x1,25	-		M10x1,25	48



204593137

**NEW**



Vespa PX 125-150-200

LUNGHEZZA LENGTH (mm)	ATTACCO SUPERIORE UPPER FASTENING POINT			ATTACCO INFERIORE LOWER FASTENING POINT		
	TIPO - TYPE	D (mm)	W (mm)	TIPO - TYPE	D (mm)	W (mm)
340		M9x1,25	-		M10x1,25	48



**ACCESSORI AMMORTIZZATORI - SOSPENSIONI - SHOCK ABSORBERS - SUSPENSIONS ACCESSORIES**

121570840

**NEW**



BRACCIO OSCILLANTE | *SUSPENSION ARM*  
 Perno 20mm | *Stud 20mm*  
 Vespa PK50-125/S/SS/XL/XL2/P150X 346431->/  
 PX125 1116->/ P200E 112625->/PX100/PX80-  
 200E Lusso/'98/MY/'11/T5/Cosa  
 Adatto a | *Suitable for* LML Star 125-200 4T/Star  
 Deluxe 125-150 4S/Speedy  
 R.O. 178051, 1780515 (Piaggio), SF534,1925/A  
 (LML)



121830060



TAMPONE AMMORTIZZATORE | *SHOCK  
ABSORBER RUBBER BUFFER*

Foro M9 | *Hole M9*

Perno M8 | *Stud M8*

Confezione 5 Pz. | *5 Pcs Packing*

Vespa 50-90 • Vespa 125 Primavera • Vespa  
ET3 • Vespa PX 125-150-200 tutti i modelli - *all  
models*

R.O. 060536



121830350



TAMPONE AMMORTIZZATORE POSTERIORE |  
*REAR SHOCK ABSORBER RUBBER BUFFER*

Dimensioni 31x29,5x13,6 mm | *Dimensions  
31x29,5x13,6 mm*

Confezione 5 Pz. | *5 Pcs Packing*

Vespa 50-90 • Vespa 125 Primavera • Vespa  
Primavera ET3 • Vespa PX 125-150-200 tutti i  
modelli - *all models*

R.O. 157103



121830600



TAMPONE AMMORTIZZATORE | *SHOCK  
ABSORBER BUFFER*

Foro Ø 14 mm | *Hole Ø 14 mm*

Ø Esterno 31 mm | *Ø External 31 mm*

Spessore 9 mm | *Thickness 9 mm*

Confezione 5 Pz. | *5 Pcs Packing*

Vespa 50-90 • Vespa Primavera ET3 • Vespa  
125 Primavera

R.O. 057012, 216209



**ACCESSORI AMMORTIZZATORI - SOSPENSIONI - SHOCK ABSORBERS - SUSPENSIONS ACCESSORIES****121830790****TAMPONE AMMORTIZZATORE | SHOCK  
ABSORBER BUFFER**

Foro Ø 12 mm | Hole Ø 12 mm

Ø Esterno 33 mm | Ø External 33 mm

Spessore 17 mm | Thickness 17 mm

Confezione 5 Pz. | 5 Pcs Packing

Vespa 50 1° serie

R.O. 215499

**121830800****TAMPONE SUPERIORE AMMORTIZZATORE |  
SHOCK ABSORBER BUFFER**

Foro Ø 13 mm | Hole Ø 13 mm

Ø Esterno 30 mm | Ø External 30 mm

Spessore 14 mm | Thickness 14 mm

Confezione 5 Pz. | 5 Pcs Packing

Vespa 50 1° serie

R.O. 057012

**121830810****TAMPONE SUPERIORE AMMORTIZZATORE |  
SHOCK ABSORBER BUFFER**

Foro Ø 14,5 mm | Hole Ø 14,5 mm

Ø Esterno 31,5 mm | Ø External 31,5 mm

Spessore 17 mm | Thickness 17 mm

Confezione 5 Pz. | 5 Pcs Packing

Vespa Sprint • Vespa GTR • Vespa Super •

Vespa Rally

R.O. 015019



**121830820**



TAMPONE SUPERIORE AMMORTIZZATORE |  
SHOCK ABSORBER BUFFER

Foro Ø 16 mm | Hole Ø 16 mm

Ø Esterno 33 mm | Ø External 33 mm

Spessore 10 mm | Thickness 10 mm

Confezione 5 Pz. | 5 Pcs Packing

Vespa PX 125-150-200 • Vespa 50-90 • Vespa

125 Primavera • Vespa ET3

R.O. 174085



**121830833**



TAMPONE INFERIORE AMMORTIZZATORE |  
LOWER SHOCK ABSORBER BUFFER

Foro Ø 14,3 mm | Hole Ø 14,3 mm

Ø Esterno 31,5 mm | Ø External 31,5 mm

Spessore 17 mm | Thickness 17 mm

Confezione 5 Pz. | 6 Pcs Packing

Vespa 125 V30-V33 • Vespa VM • Vespa VN •

Vespa VNA-TS • Vespa 150 VL • Vespa VB •

Vespa GS • Vespa VBA-T4 • Vespa Rally • Vespa

P 150S

R.O. 136554, S.15019, 015019



**121870120**



PROLUNGA AMMORTIZZATORE POSTERIORE |  
REAR SHOCK ABSORBERS EXTENSION

Lunghezza 42 mm | Length 42 mm

Ø M9 mm

Confezione 5 Pz. | 5 Pcs Packing

Vespa 125-150 Super

R.O. 070634



**121870130**



PROLUNGA AMMORTIZZATORE POSTERIORE |  
REAR SHOCK ABSORBERS EXTENSION

Lunghezza 26 mm | Length 26 mm

Ø M9 mm

Confezione 5 Pz. | 5 Pcs Packing

Vespa 150 Sprint • Vespa GL • Vespa Sprint

Veloce • Vespa Super • Vespa 180 - 200 Rally

R.O. 070642



**ACCESSORI AMMORTIZZATORI - SOSPENSIONI - SHOCK ABSORBERS - SUSPENSIONS ACCESSORIES****121870140**

PROLUNGA AMMORTIZZATORE POSTERIORE |  
 REAR SHOCK ABSORBERS EXTENSION  
 Lunghezza 52 mm | Length 52 mm  
 Ø M9 mm  
 Confezione 5 Pz. | 5 Pcs Packing  
 Vespa PX 125-150-200  
 R.O. 149871

**121870150**

PROLUNGA AMMORTIZZATORE POSTERIORE |  
 REAR SHOCK ABSORBERS EXTENSION  
 Lunghezza 48 mm | Length 48 mm  
 Ø M9 mm  
 Confezione 5 Pz. | 5 Pcs Packing  
 Vespa PX 125-150-200 Arcobaleno • Vespa T5  
 R.O. 199344

**225180193**

KIT PERNO MOZZO | HUB PIN KIT  
 Ø interno 10 mm | Inner Ø 10 mm  
 Con perno | With stud  
 Vespa 125-150 VNA VNB VBB VNB1-6 • Vespa  
 Sprint • Vespa GL • Vespa TS  
 R.O. 2/35581

**121858630**

BULLONE AMMORTIZZATORE POSTERIORE |  
 REAR SHOCK ABSORBER BOLT  
 Confezione 5 Pz. | 5 Pcs Packing  
 Vespa tutti i modelli | All models  
 R.O. 014689, 12263



KIT PERNO SOSPENSIONE - SUSPENSION PIN KIT

**225180020**



2 Gabbie Ø 18 x 24 x 16 | 2 Cages Ø 18 x 24 x 16  
1 Perno Ø 22 x 107,5 | 1 Pin Ø 22 x 107,5

Vespa 50-90 • Vespa 125 Primavera • Vespa  
ET3 • Vespa PK 50 • Vespa PKS

(Gabbia + Perno • Cage + Pin R.O: 090457 +  
070181)

R.O. 154657



**225180030**



2 Gabbie Ø 12 x 18 x 12 | 2 Cages Ø 12 x 18 x 12  
2 Guarnizioni | 2 Gaskets

1 Perno Ø 12 x 50 | 1 Pin Ø 12 x 50

Vespa PX 125-150-200 1° serie

R.O. 174099 - 138725 - 174098



**225180040**



2 Gabbie Ø 16 x 22 x 14 | 2 Cages Ø 16 x 22 x 14  
2 Guarnizioni | 2 Gaskets

1 Perno Ø 16 x 56 | 1 Pin Ø 16 x 56

Vespa PX 125-150-200 • Vespa PXE • Vespa  
Arcobaleno • Vespa PK • Cosa

R.O. 177451



**225180060**



2 Gabbie Ø 12 x 20 x 12 | 2 Cages Ø 12 x 20 x 12  
2 Rondelle Ø 12 x 23 x 2 | 2 Washer Ø 12 x 23  
x 2

1 Perno Ø 12 x 104 | 1 Pin Ø 12 x 104

Vespa 125-150 ('53-'63) VM-VN-VL-VB1-VBA-VBB

R.O. 016781





**ACCESSORI AMMORTIZZATORI - SOSPENSIONI - SHOCK ABSORBERS - SUSPENSIONS ACCESSORIES****BOCCOLA SILENTBLOCK - SILENTBLOCK BUSH****121859237** **NEW**

Dimensioni Ø 10 x 48 mm | *Dimensions Ø 10 x 48 mm*

Vespa 50-125/PV/ET3/VNB4T 0114714 ->/GT/  
GTR/Super/TS/150 VBB 170750 ->/Sprint/Sprint  
Veloce/Super/Rally/P80-150X/ P200E/PK50-125  
S/SS/ETS/160 GS/180 SS/Rally/PX/T5/Cosa/PK  
XL/XL2/FL

R.O. 094727, 223604





# CUSCINETTI

BEARINGS



## CUSCINETTI A SFERE - BALL BEARINGS

### CUSCINETTI RADIALI A SFERE NON SCHERMATI - BALL BEARINGS WITHOUT SEAL

100200200



Misure (mm) 10 - 30 - 9 (6200 C3) | Size (mm)

10 - 30 - 9 (6200 C3)

Albero primario | Driven pulley shaft

Gabbia in acciaio | Steel cage

Vespa 50-125/Primavera/ET3 • Vespa PK50-125/S/XL/XL2

R.O. 007035



100200230



Misure (mm) 12 - 37 - 12 (6301) | Size (mm) 12 -

37 - 12 (6301)

Albero primario | Driven pulley shaft

Gabbia in acciaio | Steel cage

Vespa 125 VM/VN/VNA/VNB/Super 1° serie/

Hoffmann C/M24/150 VL/VB1/VBA/VBB/VD/

VGL1/VGLA-B/GL 1° serie/GS/P80X/PX 80-100E/

Lusso

R.O. 090024



100200503



**NRB**

Misure (mm) 12 - 40 - 12 | Size (mm) 12 - 40 - 12

Alberino ingranaggio quadruplo | Gear cluster shaft

Gabbia in acciaio | Steel cage

Vespa 125 GT 1° serie/3° serie /GTR/TS • Vespa

150 GL 2°serie/150 Sprint 1°serie/3°serie/V •

Vespa P 125-150X 1° serie

R.O. 097718



## CUSCINETTI A SFERE - BALL BEARINGS

**100200640****SKF**

Misure (mm) 15 - 42 - 13 (6302) | Size (mm) 15 - 42 - 13 (6302)

Albero primario | *Driven pulley shaft*

Gabbia in acciaio | *Steel cage*

Vespa 180-200 Rally • Vespa P 125-150-200E •

Vespa PX 200 E/Lusso/'98/MY • Cosa 125-150-

200 1/2 • Vespa PX 125T5 • Vespa GTR 125 •

Vespa 150 Super • Vespa Sprint

R.O. 235934, 112793, 485912, 83018R

**100200090****SKF**

Misure (mm) 17 - 47 - 14 (6303) | Size (mm) 17 - 47 - 14 (6303)

Albero motore lato frizione | *Crankshaft clutch side*

Gabbia in acciaio | *Steel cage*

Vespa 50-125/Primavera/ET3 • Vespa PK50-

125/S/XL/XL2

R.O. 227687

**100200430****SKF**

Misure (mm) 17 - 47 - 14 (6303 C3) | Size (mm) 17 - 47 - 14 (6303 C3)

Albero motore lato frizione | *Crankshaft clutch side*

Gabbia in acciaio | *Steel cage*

Vespa 50-125/Primavera/ET3 • Vespa PK50-

125/S/XL/XL2

R.O. 227687



**100200391** **NEW**



Misure (mm) 20 - 47 - 14 (6204 C4) | *Size (mm)*

20 - 47 - 14 (6204 C4)

Albero motore lato volano | *Crankshaft flywheel side*

Gabbia in acciaio | *Steel cage*

Vespa 50 2° serie/N/L/R/S 2° serie/Special/SR/

SS • Vespa PK50/S/SS/XL/XL2

R.O. 090131



**100200110**



Misure (mm) 20 - 47 - 14 (6204 C5) | *Size (mm)*

20 - 47 - 14 (6204 C5)

Albero motore lato volano | *Crankshaft flywheel side*

Gabbia in acciaio | *Steel cage*

Vespa 50 2° serie/N/L/R/S 2° serie/Special/SR/

SS • Vespa PK50/S/SS/XL/XL2

R.O. 090131



**100200390**



Misure (mm) 20 - 47 - 14 (6204 C3) | *Size (mm)*

20 - 47 - 14 (6204 C3)

Albero motore lato volano | *Crankshaft flywheel side*

Gabbia in acciaio | *Steel cage*

Vespa 50 2° serie/N/L/R/S 2° serie/Special/SR/

SS • Vespa PK50/S/SS/XL/XL2

R.O. 090131



## CUSCINETTI A SFERE - BALL BEARINGS

**100200590**

Misure (mm) 20 - 47 - 14 (6204) | Size (mm) 20 - 47 - 14 (6204)

Albero motore lato frizione | *Crankshaft clutch side*

Gabbia in acciaio | *Steel cage*

Vespa 50 2° serie/N/L/R/S 2° serie/Special/SR/SS • Vespa PK50/S/SS/XL/XL2

R.O. 090131

**100200520**

Misure (mm) 25 - 47 - 8 (16005) | Size (mm) 25 - 47 - 8 (16005)

Carter alloggiamento campana frizione | *Clutch drum housing carter*

Gabbia in acciaio | *Steel cage*

Vespa 50-125/Primavera/ Primavera ET3 •

Vespa PK 50-125/S/XL/XL2

R.O. S007130, 007130, S.7130, 237239

**100200160**

Misure (mm) 25 - 62 - 12 (BB1-0855) | Size (mm) 25 - 62 - 12 (BB1-0855)

Albero Motore lato frizione/lato volano | *For Crankshaft clutch/flywheel side*

Gabbia in acciaio | *Steel cage*

Vespa 125 V30-V31-V33-VM1-2-VN1-2-VL-VNA-VBA-VBB-VNB-TS • Vespa 150 VL-Super • Vespa 160 GS • Vespa 180 SS • Vespa Rally • Vespa PX 80-200/PE/Lusso/T5 • Cosa 097804 (Piaggio)



## CUSCINETTI A SFERE - BALL BEARINGS

100200161



**NRB**

Misure (mm) 25 - 62 - 12 | Size (mm) 25 - 62 - 12  
 Albero Motore lato frizione/lato volano | For  
 Crankshaft clutch/flywheel side  
 Gabbia in acciaio | Steel cage  
 Vespa 125 V30-V31-V33-VM1-2-VN1-2-VL-VNA-  
 VBA-VBB-VNB-TS • Vespa 150 VL-Super • Vespa  
 160 GS • Vespa 180 SS • Vespa Rally • Vespa PX  
 80-200/PE/Lusso/T5 • Cosa  
 R.O. 097804



100200163



**NRB**

Misure (mm) 25 - 62 - 12 | Size (mm) 25 - 62 - 12  
 Albero Motore lato frizione/lato volano | For  
 Crankshaft clutch/flywheel side  
 Gabbia in acciaio | Steel cage  
 Vespa 125 V30-V31-V33-VM1-2-VN1-2-VL-VNA-  
 VBA-VBB-VNB-TS • Vespa 150 VL-Super • Vespa  
 160 GS • Vespa 180 SS • Vespa Rally • Vespa PX  
 80-200/PE/Lusso/T5 • Cosa  
 R.O. 097804



## CUSCINETTI RADIALI A SFERE CON SCHERMO RS1 SU ENTRAMBI I LATI - BALL BEARINGS WITH SYNTHETIC RUBBER SEAL RS1 ON BOTH SIDES

100200360



Misure (mm) 12 - 32 - 10 (6201-2RSH) | Size  
 (mm) 12 - 32 - 10 (6201-2RSH)  
 Ruota anteriore | Front Wheel  
 Gabbia in acciaio | Steel cage  
 Vespa PX 1° serie • Vespa large frame old  
 models  
 R.O. 007135





## CUSCINETTI A SFERE - BALL BEARINGS

**100200370**

Misure (mm) 15 - 35 - 11 (6202-2RSH) | Size  
(mm) 15 - 35 - 11 (6202-2RSH)  
Tamburo anteriore | *Front Drum*  
Gabbia in acciaio | *Steel cage*  
Vespa PX Arcobaleno  
R.O. 177610

**100200130**

Misure (mm) 20 - 47 - 14 (BB1-0843) | Size (mm)  
20 - 47 - 14 (BB1-0843)  
Albero ruota posteriore | *Rear wheel axle*  
Gabbia in acciaio | *Steel cage*  
Vespa tutti i modelli - *all models*  
R.O. 434735

**100200600**

Misure (mm) 20 - 47 - 14 (6204-2RSH) | Size  
(mm) 20 - 47 - 14 (6204-2RSH)  
Albero ruota posteriore | *Rear wheel axle*  
Gabbia in acciaio | *Steel cage*  
Vespa tutti i modelli - *all models*  
R.O. 434735



## CUSCINETTO A RULLI - ROLLER BEARINGS

**100190023**

Misure (mm) 20 - 47 - 14 | Size (mm) 20 - 47 - 14  
Albero Motore lato volano | *Crankshaft flywheel side*  
Vespa 125 Primavera ET3 ('76-'83)  
R.O. 007160, S.7160, 0071605, S007160



**100190010**



Misure (mm) 25 - 38 - 15 | Size (mm) 25 - 38 - 15  
Albero Motore lato volano | Crankshaft flywheel side

Vespa PK125S 2° serie/ETS/N/XL/XL2/125  
GTR 2° serie/TS 2° serie/150 Sprint V 2° serie/  
Super/200 Rally 2° serie/PX 80-200/PE/Lusso  
• Cosa  
R.O. 133524, 133068 (Piaggio), 133068 (LML)



**100190013**



Misure (mm) 25 - 38 - 15 | Size (mm) 25 - 38 - 15  
Albero Motore Lato Volano | Crankshaft  
Flywheel Side

Vespa PK125S 2° serie/ETS/N/XL/XL2/125  
GTR 2° serie/TS 2° serie/150 Sprint V 2° serie/  
Super/200 Rally 2° serie/PX 80-200/PE/Lusso  
• Cosa  
R.O. 133524, 133068 (Piaggio), 133068 (LML)



**100190033**



Misure (mm) 29,7 - 42,5 - 9,5 | Size (mm) 29,7 -  
42,5 - 9,5  
Albero ruota lato cambio | Wheel axle gear side  
Vespa 125 VNA/VNB/GT 1° serie/Super 1° serie •  
Vespa 150 VBA/VBB/VGLA/B/GL/Sprint 1° serie/  
Super 1° serie



**100151513**



RULLINI | ROLLERS  
Vespa PX 125-150 • Vespa T5  
R.O. 002457



**100200870**



KIT CUSCINETTI | BEARING KIT  
Vespa PX 125-150 • LML 150 2t



## GABBIE A RULLI - ROLLER CAGES

**100151200**

Confezione 5 Pz. | *Packing 5 Pcs*  
 Misura: **Ø 12x12** | *Size: Ø 12x12*  
 Perno sospensione | *Suspension pin*  
 Vespa PX PE 125-150-200  
 R.O. 174099

**100151000**

Confezione 5 Pz. | *Packing 5 Pcs*  
 Misura: **Ø 12x18x12** | *Size: Ø 12x18x12*  
 Carter motore | *Crank case*  
 Asse ruota posteriore | *Wheel axle*  
 Mozzo ruota posteriore | *Rear wheel axle*  
 Vespa 50 N  
 R.O. 224309

**100151180**

Confezione 1 Pz. | *Packing 1 Pc*  
 Misura: **Ø 12x20x12** | *Size: Ø 12x20x12*  
 Vespa 150 GL • Vespa Super • Vespa Sprint  
 R.O. 152837

**100151190**

Confezione 5 Pz. | *Packing 5 Pcs*  
 Misura: **Ø 16x14,3** | *Size: Ø 16x14,3*  
 Perno sospensione | *Suspension pin*  
 Vespa PX 125-150-200 • Vespa PK XL  
 R.O. 198513, 137146

**100151210**

Confezione 1 Pz. | *Packing 1 Pc*  
 Misura: **Ø 16x22x12** | *Size: Ø 16x22x12*  
 Vespa 50-90 • Vespa 125 Primavera • Vespa  
 ET3 • Vespa PK • Vespa PK XL • Vespa FL •  
 Vespa Rush • Vespa N  
 R.O. 137731



## GABBIE A RULLI - ROLLER CAGES

**100151290**



Confezione 10 Pz. | *Packing 10 Pcs*  
 Misura: HK Ø **16x22x16** | *Size: HK Ø 16x22x16*  
 Mozzo ruota posteriore | *Rear wheel axle*  
 Vespa 125-150-200 1° serie  
 R.O. AP8550099, 174710



**100151340**

**NEW**



Confezione 1 Pz. | *Packing 1 Pcs*  
 Misura: HK 1812 Ø **18x24x12** | *Size: HK 1812 Ø 18x24x12*  
 Perno ruota anteriore | *Front wheel shaft*  
 Vespa PX 1° serie  
 R.O. 132094



**100151110**



Confezione 5 Pz. | *Packing 5 Pcs*  
 Misura: Ø **18x24x16** | *Size: Ø 18x24x16*  
 Perno sospensione anteriore | *Pin front suspension*  
 Vespa 50-90 • Vespa 125 Primavera • Vespa  
 ET3 • Vespa PK 50 • Vespa PKS  
 R.O. 121095, 090457



**100151130**



Confezione 5 Pz. | *Packing 5 Pcs*  
 Misura: Ø **20x26x16** | *Size: Ø 20x26x16*  
 Mozzo anteriore | *Front brake drum*  
 Vespa 50 FL • Vespa HP • Vespa PX 125-150-  
 200 • Vespa T5 • Cosa  
 R.O. 177442



**100151120**



Confezione 5 Pz. | *Packing 5 Pcs*  
 Misura: Ø **22x28x12** | *Size: Ø 22x28x12*  
 Mozzo anteriore | *Front brake drum*  
 Vespa 50 FL • Vespa HP • Vespa PX 125-150-  
 200 • Vespa T5 • Cosa  
 R.O. 177436



## GABBIE A RULLI - ROLLER CAGES

**100151150**Confezione 1 Pz. | *Packing 1 Pc*Misura: **Ø 28,5x35x12** | *Size: Ø 28,5x35x12*Albero secondario | *Driven shaft*Vespa PX PE tutti i modelli large frame - *all large frame models* • Vespa 125 • Vespa T5 •

Cosa

R.O. 106956

**100151153**Confezione 1 Pz. | *Packing 1 Pc*Misura: **Ø 28,5x35x12** | *Size: Ø 28,5x35x12*Albero secondario | *Driven shaft*Vespa PX PE tutti i modelli large frame - *all large frame models* • Vespa 125 • Vespa T5 •

Cosa

R.O. 106956

**100150250**Confezione 5 Pz. | *Packing 5 Pcs*Modello "**DURKOP**" per spinotto Ø 12x17x15 |*Model "DURKOP" for piston pin Ø 12x17x15*

Vespa 50 • Vespa PK 50 • Vespa PK 50XL

**100150300**Confezione 5 Pz. | *Packing 5 Pcs*Modello "**DURKOP**" per spinotto Ø 12x17x13 |*Model "DURKOP" for piston pin Ø 12x17x13*

Vespa 50 • Vespa PK 50 • Vespa PK 50XL

R.O. 500501

**100150400**Confezione 5 Pz. | *Packing 5 Pcs*Modello "**DURKOP**" per spinotto Ø 15x19x20 |*Model "DURKOP" for piston pin Ø 15x19x20*

Vespa 125 Primavera • Vespa ET3 • Vespa PK 125 • Vespa PK 125XL • Vespa PX 125

R.O. 500541



## GABBIE A RULLI - ROLLER CAGES

**100150450**



Confezione 5 Pz. | *Packing 5 Pcs*

Modello "**DURKOP**" per spinotto Ø 16x20x20 |

*Model "DURKOP" for piston pin Ø 16x20x20*

Vespa PE 200 • Vespa Rally

R.O. 500511



**100150453**



Confezione 5 Pz. | *Packing 5 Pcs*

Modello Per spinotto Ø 16x20x20 | *Model for*

*piston pin Ø 16x20x20*

Vespa PE 200 • Vespa Rally

R.O. 500511



# TENUTA

TIGHT SYSTEM



## GUARNIZIONI - GASKETS

**100684040**



Vespa 50-90 • Vespa 125 Primavera • Vespa  
ET3  
R.O. 091925



**100684050**



Vespa PK 50 • Vespa PK 50XL • Vespa Rush •  
Vespa FL  
R.O. 154616



**100684070**



Vespa 125 T5  
R.O. 154699



**100684160**



Vespa 125 GT VNL2T ('66-'73)

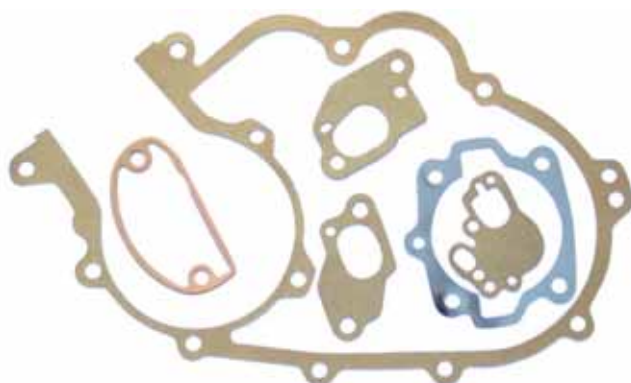



**GUARNIZIONI - GASKETS****100684090**

Vespa PX 125-150 • Vespa PX 125-150  
 Arcobaleno • Vespa Sprint Veloce  
 R.O. 1545636

**100684110****100684112****NEW**

Con Miselatore | *With mixer*

Vespa 125-150 Cosa CL-CLX ('88-'91) • Vespa  
 125-150 Cosa 2 ('91-'97) • Vespa PXE 125-150  
 Arcobaleno ('81-'97) • Vespa PX 125-150 ('98-  
 '01)  
 R.O. 154546

**100684130**

Vespa 150 ('54-'58)  
 R.O. 86684

**100684140**

Vespa 125-150 VNB1T-VNB2T  
 R.O. 86686



## GUARNIZIONI - GASKETS

**100684180**



Vespa Super 125-150 VBC1T  
R.O. 91991



**100684080**



Vespa 2% 125 VNA- VNB ('58-'65) • Vespa 150 ('59-'65) • Vespa 150 GL  
R.O. 091730



**100684170**



Vespa 2% 125-150 Super-Sprint-GT-GTR

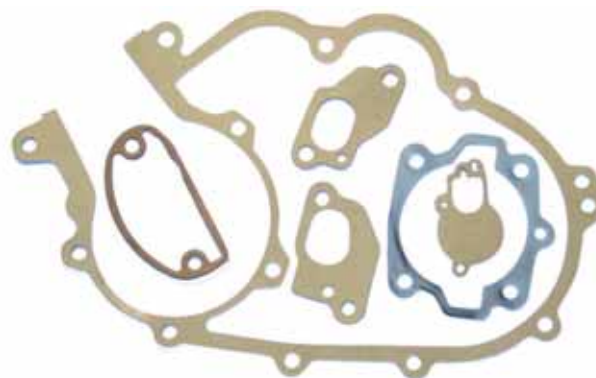

**100684190**



Vespa PX 200



**GUARNIZIONI - GASKETS****100684150**

Vespa 160 GS • Vespa 180 SS

**100684100**Vespa PE 200 • Vespa PE 200 Arcobaleno •  
Vespa 200 Rally  
R.O. 154547**100684120**Con Miscelatore | *With mixer*  
Cosa 200 • Vespa PE 200 Arcobaleno  
R.O. 154546**100684122****NEW**Con Miscelatore | *With mixer*  
Con O-ring | *With O-ring*  
Cosa 200 ('88-'91) • Cosa 2 200 ('91-'97) •  
Vespa PXE 200 Arcobaleno ('81-'97) • Vespa PX  
200 ('98-'01)  
R.O. 154546

## GUARNIZIONI - GASKETS

### GUARNIZIONI BASE CILINDRO - BOTTOM CYLINDER GASKET

**100680660** **NEW**



Per Cilindro 100080660 | *For Cylinder*  
100080660

Vespa 150 ('59-'65) • Vespa 125-150 Super •  
Vespa Sprint • Vespa 125 GT • Vespa 150 GL •  
Vespa 125 VNA-VNB ('58-'65)



**100703030**



Confezione 5 Pz. | *5 Pcs Packing*

Vespa 50-90 • Vespa 125 Primavera • Vespa  
ET3 • Vespa PK • Vespa PK XL

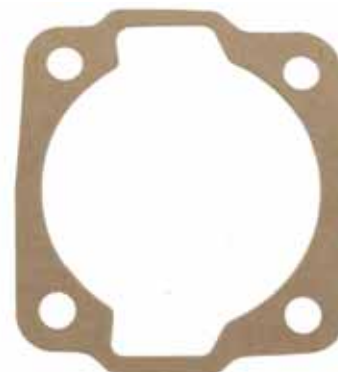

**100703090**



In alluminio | *Aluminium made*  
Confezione 5 Pz. | *5 Pcs Packing*

Vespa 50-90 • Vespa 125 Primavera • Vespa  
ET3 • Vespa PK • Vespa PK XL  
R.O.826911



**100704000**



In alluminio | *Aluminium made*  
Confezione 5 Pz. | *5 Pcs Packing*

Vespa PX 125-150 • Cosa 125-150



**GUARNIZIONI - GASKETS****100704010**

Confezione 5 Pz. | 5 Pcs Packing

Vespa PE 200 • Vespa 200 Rally • Cosa 200  
R.O. 191695**100704020**

In alluminio | Aluminium made

Confezione 5 Pz. | 5 Pcs Packing

Vespa 150 ('59-'65) • Vespa 125-150 Super •  
Vespa Sprint • Vespa 125 GT • Vespa 150 GL •  
Vespa 125 VNA-VNB ('58-'65)  
R.O. 89120**GUARNIZIONI CARTER MOTORE - CLUTCH COVER GASKETS****100706200**

Confezione 5 Pz. | 5 Pcs Packing

Vespa 50 • Vespa 125 Primavera • Vespa ET3 •  
Vespa PK 50-125 • Vespa PK XL**100707120**Flangia portaganasce posteriori | Rear brake  
shoes flange

Confezione 5 Pz. | 5 Pcs Packing

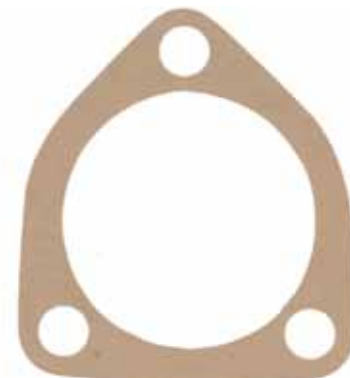
Vespa 50 • Vespa 125 Primavera • Vespa ET3 •  
Vespa PK 50-125 • Vespa PK XL

## GUARNIZIONI - GASKETS

100708000



Rondella in fibra | *Fiber washer*  
 Rondella Ø 8 x 12 x 1 | *Washer Ø 8 x 12 x 1*  
 Confezione 10 Pz. | *10 Pcs Packing*  
 Vespa tutti i modelli | *All models*  
 R.O. 000397, 485703



## SET GUARNIZIONI CARBURATORE - CARBURETOR GASKETS KIT

100684310 **NEW**



Vespa PX



## GUARNIZIONI CARBURATORE - CARBURETOR GASKETS

100703950



Confezione 5 Pz. | *5 Pcs Packing*  
 Vespa 50-90 • Vespa 125 Primavera • Vespa  
 ET3 • Vespa PK 50-125

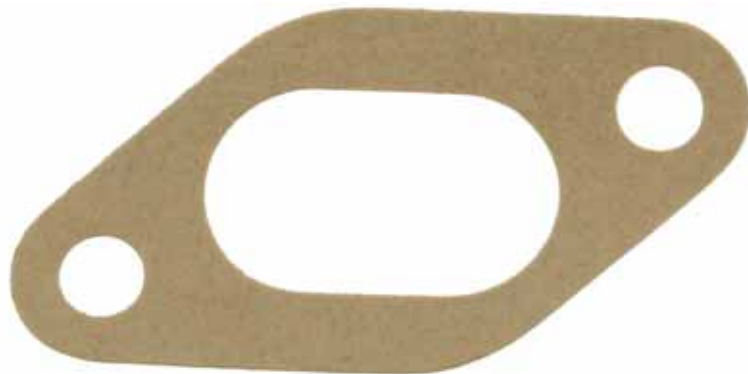

100703960



Confezione 5 Pz. | *5 Pcs Packing*  
 Vespa PK XL  
 R.O. 196431



**GUARNIZIONI - GASKETS****100709040**

Confezione 5 Pz. | 5 Pcs Packing

Vespa PX 125-150 • Vespa PE 200 • Vespa 200  
Rally • Cosa 125-150-200 • Vespa 125 T5  
R.O.131079**100709050**

Confezione 5 Pz. | 5 Pcs Packing

Vespa 200 Rally • Cosa 200 • Vespa PE 200 •  
Vespa 125 T5  
R.O. 131115**100709060**

Confezione 5 Pz. | 5 Pcs Packing

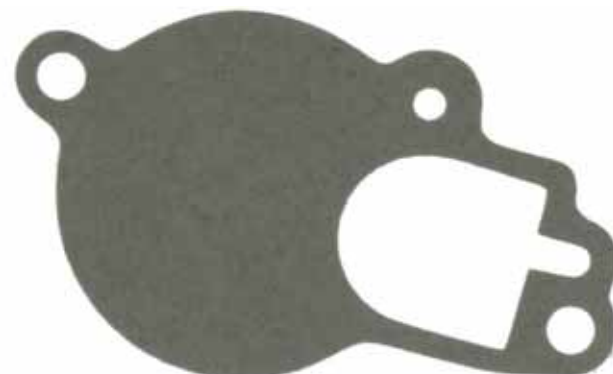
Vespa PX 125-150 • Vespa PE 200 • Vespa 200  
Rally • Cosa 125-150-200 • Vespa 125 T5  
R.O. 150131**GUARNIZIONE SCARICO - EXHAUST GASKET****100705100**

Verde | Green

Confezione 5 Pz. | 5 Pcs Packing

Vespa 50 • Vespa 50 Automatica • Vespa 50  
Revival • Vespa 50 Special • Vespa Nuova 125  
• Vespa 90 • Vespa 90 Racer • Vespa 125 ET3 •  
Vespa 50 FL • Vespa 50 L • Vespa 50 N • Vespa  
50 R • Vespa 50 S • Vespa PK 50-125 • Vespa  
PK 50-125XL • Vespa PK 50XLS • Vespa 50  
Ø 6 mm

## GUARNIZIONI - GASKETS

100705111



Grigio | Grey

Confezione 5 Pz. | 5 Pcs Packing

Vespa 50 • Vespa 50 Automatica • Vespa 50 Revival • Vespa 50 Special • Vespa Nuova 125 • Vespa 90 • Vespa 90 Racer • Vespa 125 ET3 • Vespa 50 FL • Vespa 50 L • Vespa 50 N • Vespa 50 R • Vespa 50 S • Vespa PK 50-125 • Vespa PK 50-125XL • Vespa PK 50XLS • Vespa 50 Ø 8 mm



100705120



Confezione 5 Pz. | 5 Pcs Packing

Vespa PK 125 • Vespa PK 125XL



## GUARNIZIONI SERBATOIO BENZINA - FUEL CAP GASKETS

121830300



Confezione 5 Pz. | 5 Pcs Packing

Vespa ('46 - '83) tutti i modelli - all models • Vespa 125 (VN1-VN2-VNAVNB) • Vespa PX 125-150-200  
R.O. 002319



121830370



Confezione 5 Pz. | 5 Pcs Packing

Vespa 50-125 ('67-'82) • Vespa 50 S • Vespa 50 L • Vespa 50 R • Vespa 50 Special • Vespa 90-100 • Vespa 125 Primavera • Vespa 125 ET3  
R.O. 071734





**GUARNIZIONI - GASKETS****121830650**

Vespa 125-150 ('60>) • Vespa 125 GT • Vespa 125 TS • Vespa 150 GL • Vespa Super • Vespa 160 GS • Vespa 180 SS • Vespa Rally • Vespa PX 125 • Vespa PX 125 EU2 ('01-'07) • Vespa PX 30 Anni • Vespa PXE 125 Arcobaleno ('81-'97) • Vespa 125 T5 ('85-'89)  
R.O. 159804

**121830660**

Vespa 125 Bacchetta V1-V15 ('48-'50) • Vespa 125 V30-33 ('51-'52)  
R.O. 003979

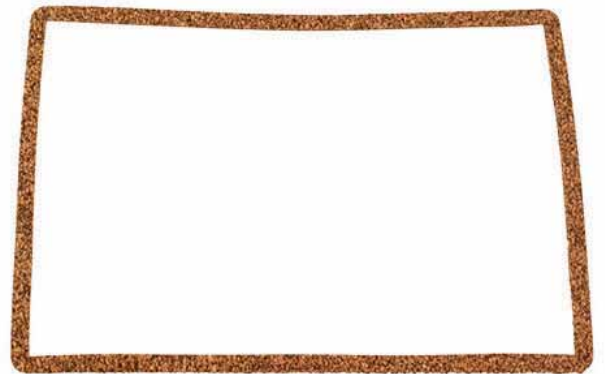
**121830670**

Vespa VM1-VM2 ('53-'54)  
R.O. 016704

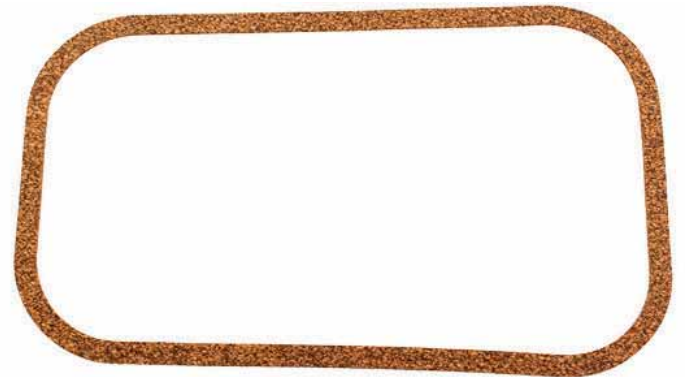
**121830680**

Vespa 125 VN1-VN2 • Vespa 150 VL2-3-VB1  
R.O. 028231



## GUARNIZIONI - GASKETS

121830690



Guarnizione tappo benzina sughero | *Cork*  
*Gasket fuel cap*

Confezione 5 Pz. | *5 Pcs Packing*

Vespa 50-125 ('67-'82) • Vespa 50 S • Vespa 50 L • Vespa 50 R • Vespa 50 Special • Vespa 90-100 • Vespa 125 Primavera • Vespa 125 ET3



121830700



Guarnizione tappo benzina sughero | *Cork*  
*Gasket fuel cap*

Confezione 5 Pz. | *5 Pcs Packing*

Vespa tutti i modelli ('46-'83) - *all models* • Vespa 125(VN1-VN2-VNA-VNB) • Vespa PX 125-150-200



## GUARNIZIONI RUBINETTO BENZINA - FUEL TAP GASKET

121830530



Confezione 5 Pz. | *5 Pcs Packing*

Vespa 50-90 • Vespa 125 Primavera ET3 • Vespa ET3 • Vespa PX PE  
R.O. 13836, 610219M, 414779



121830710



In sughero | *Cork made*

Confezione 5 Pz. | *5 Pcs Packing*

Vespa 125 (VNB1-6, VBB 1-2) • Vespa GT • Vespa GTR • Vespa Sprint Vespa 150 GL • Vespa Sprint Veloce



**GUARNIZIONI - GASKETS****121830720**

Confezione 5 Pz. | 5 Pcs Packing  
 Vespa 125-150 anni '50

**GUARNIZIONI CAMBIO - GEAR SELECTOR GASKETS****100703980**

Confezione 5 Pz. | 5 Pcs Packing  
 Vespa PX PE  
 R.O. 47162

**GUARNIZIONI CLACSON - HORN GASKETS****121830430**

Confezione 5 Pz. | 5 Pcs Packing  
 Vespa 125 Primavera ET3  
 R.O. 120798

**121830431**

Confezione 5 Pz. | 5 Pcs Packing  
 Vespa 50-90 • Vespa 125 VNB2 dal telaio  
 n.4718 - from chassis n.4718, VBB1T dal telaio  
 n.32070 - from chassis n.32070 • Vespa Super  
 125 ('66-'68) • Vespa Super 150 ('66-'79)  
 R.O. 92468. 174091



## GUARNIZIONI - GASKETS

### GUARNIZIONI FILTRO - FILTER GASKETS

100703970



Confezione 5 Pz. | 5 Pcs Packing

Vespa 50-90

R.O. 79900

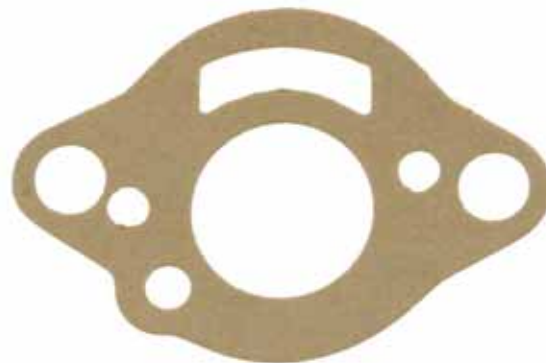

## PARAOLI - OIL SEALS

100660205 **NEW**



Dimensioni 10-18-4 | Dimensions 10-18-4

Leva comando- coperchio frizione | Lever - Clutch cover

Vespa 50-125 FL • Vespa 50 HP

R.O. 152351



100660085 **NEW**



Dimensioni 17-40-7 | Dimensions 17-40-7

Ruota anteriore | Front wheel

Vespa V50 N/L/R/S • Vespa 90/100 • Vespa Rally • Vespa Sprint • Vespa GTR • Vespa P 125-150S



100661700



Dimensioni 19-32-7 | Dimensions 19-32-7

Albero motore lato volano | Crankshaft flywheel side

Vespa 50-90 • Vespa 125 Primavera • Vespa ET3

R.O. 430390, 155579



**PARAOLI - OIL SEALS****100661710**Dimensioni 19-32-7 | *Dimensions 19-32-7*Paraolio Blu | *Blue Oil Seal*Albero motore lato volano | *Crankshaft  
flywheel side*Vespa 50-90 • Vespa 125 Primavera • Vespa  
ET3

R.O. 430390, 155579

**100661715****NEW**Dimensioni 19-32-7 | *Dimensions 19-32-7*Paraolio Blu | *Blue Oil Seal*Albero motore lato volano | *Crankshaft  
flywheel side*Vespa V50 N/L/R/S • Vespa 50 Special • Vespa  
50 Special Elestart • Vespa 90/R/100 • Vespa  
125 Primavera • Vespa 125 Primavera ET3 •  
Vespa PK 50/S

R.O. 430390, 155579, S.8720, 008720

**100661725****NEW**Dimensioni 19-32-7 | *Dimensions 19-32-7*In Viton | *Viton made*Albero motore lato volano | *Crankshaft  
flywheel side*Vespa V50 N/L/R/S • Vespa 50 Special • Vespa  
50 Special Elestart • Vespa 90/R/100 • Vespa  
125 Primavera • Vespa 125 Primavera ET3 •  
Vespa PK 50/S

R.O. 430390, 155579, S.8720, 008720

**100662000**Dimensioni 20-32-7 | *Dimensions 20-32-7*Albero motore lato volano | *Crankshaft  
flywheel side*

Vespa PK 50 • Vespa FL

R.O. 289306



**100662020**



Dimensioni 20-32-7 | *Dimensions 20-32-7*

Paraolio Blu | *Blue Oil Seal*

Albero motore lato volano | *Crankshaft  
flywheel side*

Vespa PK50/S • Vespa PK50 2° serie/S 2° serie/  
SS • Vespa PK 50 XL/XL2/FL/HP/N/Rush • Vespa  
PK80-100 S 2° serie/PK 125 2° serie/S 1° serie  
Adattabile a - *Suitable for Vespa V50 N/L/R/S* •  
Vespa 50 Special • Vespa 50 Special Elestart •  
Vespa 90/R/100 • Vespa 125 Primavera • Vespa  
125 Primavera ET3 con albero motore cono  
20mm - *with crankshaft with cone 20 mm*  
R.O. 82539R, 289306, 017016, 229496,  
430392, 82878R



**100662025** **NEW**



Dimensioni 20-32-7 | *Dimensions 20-32-7*

Paraolio Blu | *Blue Oil Seal*

Albero motore lato volano | *Crankshaft  
flywheel side*

Vespa PK50/S • Vespa PK50 2° serie/S 2° serie/  
SS • Vespa PK 50 XL/XL2/FL/HP/N/Rush • Vespa  
PK80-100 S 2° serie/PK 125 2° serie/S 1° serie  
Adattabile a - *Suitable for Vespa V50 N/L/R/S* •  
Vespa 50 Special • Vespa 50 Special Elestart •  
Vespa 90/R/100 • Vespa 125 Primavera • Vespa  
125 Primavera ET3 con albero motore cono  
20mm - *with crankshaft with cone 20 mm*  
R.O. 82539R, 289306, 017016, 229496,  
430392, 82878R



**PARAOLI - OIL SEALS****100662015** **NEW****CORTECO**Dimensioni 20-32-7 | *Dimensions 20-32-7*In Viton | *Viton made*

Vespa PK50/S • Vespa PK50 2° serie/S 2° serie/SS • Vespa PK 50 XL/XL2/FL/HP/N/Rush • Vespa PK80-100 S 2° serie/PK 125 2° serie/S 1° serie Adattabile a - *Suitable for* Vespa V50 N/L/R/S • Vespa 50 Special • Vespa 50 Special Elestart • Vespa 90/R/100 • Vespa 125 Primavera • Vespa 125 Primavera ET3 con albero motore cono 20mm - *with crankshaft with cone 20 mm*  
R.O. 82539R, 289306, 017016, 229496, 430392, 82878R

**100660095** **NEW****CORTECO**Dimensioni 20-35-7 | *Dimensions 20-35-7*In Viton | *Viton made*

Albero motore a spalle piene (carter modificato Quattrini/BFA Motori). Lato frizione/volano | *Full circle crankshaft (modified crankcase Quattrini/BFA Motori). Clutch/Flywheel side.*

Vespa 50 tutti i modelli - *all models* • Vespa 125 Primavera • Vespa 125 Primavera ET3 • Vespa PK 50-125/S/SS/XL/XL2

**100660105** **NEW****CORTECO**Dimensioni 20-35-7 | *Dimensions 20-35-7*Paraolio Blu | *Blue Oil Seal*

Albero motore a spalle piene (carter modificato Quattrini/BFA Motori). Lato frizione/volano | *Full circle crankshaft (modified crankcase Quattrini/BFA Motori). Clutch/Flywheel side.*

Vespa 50 tutti i modelli - *all models* • Vespa 125 Primavera • Vespa 125 Primavera ET3 • Vespa PK 50-125/S/SS/XL/XL2



100660115 **NEW**



**CORTECO**

Dimensioni 20-35-7 | *Dimensions 20-35-7*

Paraolio TC | *TC Oil Seal*

Albero motore a spalle piene (carter modificato Quattrini/BFA Motori). Lato frizione/volano | *Full circle crankshaft (modified crankcase Quattrini/BFA Motori). Clutch/Flywheel side.*

Vespa 50 tutti i modelli - *all models* • Vespa 125 Primavera • Vespa 125 Primavera ET3 • Vespa PK 50-125/S/SS/XL/XL2



100662102 **NEW**



**ROLF**

Dimensioni 20-40-6 | *Dimensions 20-40-6*

Albero motore lato volano | *Crankshaft flywheel side*

Vespa Sprint • Vespa Sprint Veloce • Vespa GT • Vespa GTR • Vespa Super • Vespa GL 150 • Vespa GS 150 (VS1-2-3-4-5)  
R.O. 025180



100662110



Dimensioni 20-40-6 | *Dimensions 20-40-6*

Paraolio Blu | *Blue Oil Seal*

Albero motore lato volano | *Crankshaft flywheel side*

Vespa Super • Vespa Sprint • Vespa GL  
R.O. 025180

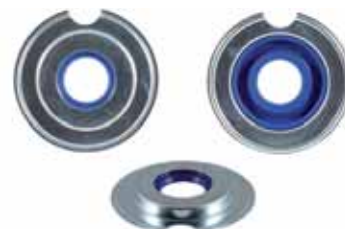

100662370



**ROLF**

Dimensioni 20-40-6 | *Dimensions 20-40-6*

Rolf

Albero motore lato volano | *Crankshaft flywheel side*

Vespa Super • Vespa Sprint • Vespa 200 Rally • Vespa 150 GL • Vespa VNA  
R.O. 084644





**PARAOLI - OIL SEALS****100662375****NEW****CORTECO**Dimensioni 20-40-6 | *Dimensions 20-40-6*Paraolio Blu | *Blue Oil Seal*Albero motore lato volano/frizione | *Crankshaft flywheel/clutch side*

Vespa 125 V30-33/Hoffmann (\*52&gt;)

R.O. 19616

**100662360****FACTORY QUALITY**Dimensioni 20-62-6.5 | *Dimensions 20-62-6.5*Albero motore lato frizione | *Crankshaft clutch side*

Vespa 150 Sprint • Vespa Sprint Veloce • Vespa GT • Vespa GTR • Vespa Super • Vespa 150 GL • Vespa 125 TS • Vespa 125-150

R.O. 048290

**100662390****FACTORY QUALITY**Dimensioni 20-62-6.5 | *Dimensions 20-62-6.5*

Blue

Albero motore lato frizione | *Crankshaft clutch side*

Vespa 150 Sprint • Vespa Sprint Veloce • Vespa GT • Vespa GTR • Vespa Super • Vespa 150 GL • Vespa 125 TS • Vespa 125-150

R.O. 048290

**100662395****NEW****CORTECO**Dimensioni 20-62-6.5 | *Dimensions 20-62-6.5*Paraolio Blu | *Blue Oil Seal*Albero motore lato frizione | *Crankshaft clutch side*

Vespa 125 VNA2 2° serie • Vespa 125 VNB/GT/GTR 1° serie/Super/TS 1° serie • Vespa 150 VBA 2° serie/VBB/VGLA/B/GL/Super 1° serie • Vespa 150 Sprint/V 1° serie

R.O. 2/49290, 049290



## PARAOLI - OIL SEALS

100662430



Dimensioni 22-32-7 | *Dimensions 22-32-7*  
Semiassa | *Half Shaft*  
R.O. 431044



100666075 **NEW**



**CORTECO**

Dimensioni 22-32-7/9 | *Dimensions 22-32-7/9*  
Paraolio Blu | *Blue Oil Seal*

Vespa V 50 N/L/R/S • Vespa 50 Special • Vespa  
50 Special Elestart • Vespa 90/R/100 • Vespa  
125 Primavera • Vespa 125 Primavera ET3 •  
Vespa PK 50/S/SS/XL/XL2



100660125 **NEW**



**CORTECO**

Dimensioni 22.7-47-7 | *Dimensions 22.7-47-7*  
Paraolio Blu | *Blue Oil Seal*

Albero motore lato frizione | *Crankshaft clutch  
side*

Vespa 50 tutti i modelli - *all models* • Vespa 125  
Primavera • Vespa 125 Primavera ET3 • Vespa  
PK 50-125/S/SS/XL/XL2  
R.O. 7125, 289305, 007125, 237071, 243521,  
430391



100660135 **NEW**



**CORTECO**

Dimensioni 22.7-47-7 | *Dimensions 22.7-47-7*  
In Viton | *Viton made*

Albero motore lato frizione | *Crankshaft clutch  
side*

Vespa 50 tutti i modelli - *all models* • Vespa 125  
Primavera • Vespa 125 Primavera ET3 • Vespa  
PK 50-125/S/SS/XL/XL2  
R.O. 7125, 289305, 007125, 237071, 243521,  
430391



**PARAOLI - OIL SEALS****100662700**Dimensioni 22.7-47-7/7.5 | *Dimensions 22.7-47-7/7.5*Albero motore lato frizione | *Crankshaft clutch side*Vespa 50-90 • Vespa 125 Primavera • Vespa ET3 • Vespa PK 50-125 • Vespa PK 50-125XL • Vespa FL  
R.O. 289305**100662710**Dimensioni 22.7-47-7/7.5 | *Dimensions 22.7-47-7/7.5*Paraolio Blu | *Blue Oil Seal*Albero motore lato frizione | *Crankshaft clutch side*Vespa 50-90 • Vespa 125 Primavera • Vespa ET3 • Vespa PK 50-125 • Vespa PK 50-125XL • Vespa FL  
R.O. 289305**100660145****NEW**Dimensioni 24-32-7 | *Dimensions 24-32-7*Paraolio Blu | *Blue Oil Seal*Conversione ETS | *ETS Conversion*

Vespa V 50 N/L/R/S • Vespa 50 Special • Vespa 50 Special Elestart • Vespa 90/R/100 • Vespa 125 Primavera • Vespa 125 Primavera ET3 • Vespa PK 50/S/SS/XL/XL2

**100663000**Dimensioni 24-35-6 | *Dimensions 24-35-6*Albero motore lato volano | *Crankshaft flywheel side*Vespa PX 125-150-200 • Vespa 150 Super  
R.O. 431121

## PARAOLI - OIL SEALS

**100663010**



Dimensioni 24-35-6 | *Dimensions 24-35-6*  
 Paraolio Blu | *Blue Oil Seal*  
 Albero motore lato volano | *Crankshaft flywheel side*  
 Vespa PX 125-150-200 • Vespa 150 Super  
 R.O. 431121



**100663015** **NEW**



Dimensioni 24-35-6 | *Dimensions 24-35-6*  
 Paraolio Blu | *Blue Oil Seal*  
 Albero motore lato volano | *Crankshaft flywheel side*  
 Vespa PX 80-200/PE/Lusso/T5/Cosa • Vespa PK 125S 2° serie/ETS/N/XL/XL2 • Vespa 125 GTR 2° serie/TS 2° serie • Vespa 150 Sprint V 2° serie/Super 2° serie • Vespa 200 Rally 2° serie  
 R.O. 158962, 431121



**100660155** **NEW**



Dimensioni 24-40-7 | *Dimensions 24-40-7*  
 Paraolio Blu | *Blue Oil Seal*  
 Ruota anteriore | *Front wheel*  
 Vespa 50-90 • Vespa 125 Primavera • Vespa 125 Primavera ET3  
 R.O. 8795, 008795



**100666095** **NEW**



Dimensioni 24.9-45-6.5 | *Dimensions 24.9-45-6.5*  
 Paraolio Blu | *Blue Oil Seal*  
 Albero motore lato volano | *Crankshaft flywheel side*  
 Vespa 160 GS • Vespa 180 SS  
 R.O. 78002, 078002



**PARAOLI - OIL SEALS****100666105** **NEW****CORTECO**Dimensioni 24.9-45-6.5 | *Dimensions 24.9-45-6.5*In Viton | *Viton made*Albero motore lato volano | *Crankshaft flywheel side*

Vespa 160 GS • Vespa 180 SS

R.O. 78002, 078002

**100660165** **NEW****CORTECO**Dimensioni 25-40-7 | *Dimensions 25-40-7*Paraolio Blu | *Blue Oil Seal*Ruota anteriore | *Front wheel*

Vespa V 50 N/L/R/S • Vespa 50 Special • Vespa 50 Special Elestart • Vespa 90/R/100 • Vespa 125 Primavera • Vespa 125 Primavera ET3 • Vespa PK 50/S/SS/XL/XL2

R.O. 128217

**100664500****FACTORY QUALITY**Dimensioni 27-37-7 | *Dimensions 27-37-7*Albero ruota posteriore | *Rear wheel shaft*

Vespa 50-90 • Vespa 125 Primavera • Vespa ET3 • Vespa PK 50-125 • Vespa PK 50-125XL • Vespa FL • Vespa 150 GL • Vespa Sprint • Vespa Super

R.O. 046699

**100664510****FACTORY QUALITY**Dimensioni 27-37-7 | *Dimensions 27-37-7*Paraolio Blu | *Blue Oil Seal*Albero ruota posteriore | *Rear wheel shaft*

Vespa 50-90 • Vespa 125 Primavera • Vespa ET3 • Vespa PK 50-125 • Vespa PK 50-125XL • Vespa FL • Vespa 150 GL • Vespa Sprint • Vespa Super

R.O. 046699



100664515 **NEW**



**CORTECO**

Dimensioni 27-37-7 | Dimensions 27-37-7

Paraolio Blu | Blue Oil Seal

Ruota posteriore | Rear wheel

Vespa 50-125/PV/ET3 • Vespa PK 50/S /XL/XL2/

125 • Vespa 125 VNA/VNB/GT 1° serie/GTR 1°

serie • Vespa 150 VBA/VBB/VGLA/B/GL • Vespa

150 Sprint 1° serie/V 1° serie • Vespa 180 Rally

R.O. 046699, 346699, 46699



100664705 **NEW**



**CORTECO**

Dimensioni 27-42-10 | Dimensions 27-42-10

Paraolio Blu | Blue Oil Seal

Ruota posteriore | Rear wheel

Vespa PX 80-200 E Lusso 2° serie • Vespa ('98)

• Vespa MY'11 • Vespa T5 • Cosa

Adatto per - Suitable for Vespa 125 V1-15/V30-

33/VN/VM/150 VL/VB1

R.O. 118058



100664800



**FACTORY  
QUALITY**

Dimensioni 27-47-6 | Dimensions 27-47-6

Ruota posteriore | Rear wheel

Vespa PE PXE 125-150-200 • Vespa GL • Vespa

Sprint • Vespa Rally

R.O. 130536



100664810



**FACTORY  
QUALITY**

Dimensioni 27-47-6 | Dimensions 27-47-6

Paraolio Blu | Blue Oil Seal

Ruota posteriore | Rear wheel

Vespa PE PXE 125-150-200 • Vespa GL • Vespa

Sprint • Vespa 200 Rally

R.O. 130536



**PARAOLI - OIL SEALS****100664815** **NEW****CORTECO**Dimensioni 27-47-6 | *Dimensions 27-47-6*Paraolio Blu | *Blue Oil Seal*Ruota posteriore | *Rear wheel*Vespa P 80-150X/P 200E 1° serie • Vespa PX  
80-200E 1° serie • Vespa 125 GT 2° serie/GTR 2°  
serie/TS • Vespa 150 Sprint 2° serie/V 2° serie •  
Vespa 200 Rally

R.O. 130536

**100666085** **NEW****CORTECO**Dimensioni 28-40-7 | *Dimensions 28-40-7*Paraolio Blu | *Blue Oil Seal*Ruota posteriore | *Rear wheel*

Vespa 160 GS • Vespa 180 SS

R.O. 600109901, 02640

**100660175** **NEW****CORTECO**Dimensioni 30-40-7 | *Dimensions 30-40-7*Paraolio Blu | *Blue Oil Seal*Albero cambio, asse ruota posteriore | *Drive  
shaft, rear wheel shaft*Vespa 125 Super • Vespa 150 Super 1° serie •  
Vespa 160 GS • Vespa 180 SS

R.O. 2/94119, 094119, 7286, 07286

**100660185** **NEW****CORTECO**Dimensioni 30-40-7 | *Dimensions 30-40-7*Albero cambio, asse ruota posteriore | *Drive  
shaft, rear wheel shaft*Vespa 125 Super • Vespa 150 Super 1° serie •  
Vespa 160 GS • Vespa 180 SS

R.O. 2/94119, 094119, 7286, 07286



## PARAOLI - OIL SEALS

**100665500**



Dimensioni 30-47-6 | *Dimensions 30-47-6*  
 Albero ruota posteriore | *Rear wheel shaft*  
 Vespa PE PXE 125-150-200  
 R.O. 478498, 008714



**100665510**



Dimensioni 30-47-6 | *Dimensions 30-47-6*  
 Paraolio Blu | *Blue Oil Seal*  
 Albero ruota posteriore | *Rear wheel shaft*  
 Vespa PE PXE 125-150-200  
 R.O. 008714



**100665515** **NEW**



Dimensioni 30-47-6 | *Dimensions 30-47-6*  
 Paraolio Blu | *Blue Oil Seal*  
 Ruota posteriore | *Rear wheel*  
 Vespa P 150S/P 200E 2° serie • Vespa PX 80-200E 2° serie • Vespa PX 80-200 E Lusso 1° serie/T5/Cosa 1 • Vespa 150 Super 2° serie  
 R.O. 478498



**100662362**



Dimensioni 30-62-6.5 | *Dimensions 30-62-6.5*  
 Rolf  
 Albero motore lato frizione | *Crankshaft clutch side*  
 Vespa 150 Sprint • Vespa Sprint Veloce • Vespa GT • Vespa GTR • Vespa Super • Vespa 150 GL • Vespa 125 TS • Vespa 125-150  
 R.O. 049290





**PARAOLI - OIL SEALS****100666020**Dimensioni 31-62-4.3 | *Dimensions 31-62-4.3*Paraolio Blu | *Blue Oil Seal*Albero motore lato frizione | *Crankshaft clutch side*

Vespa PE PXE 125-150-200 ('98)

R.O. 433122

**100666000**Dimensioni 31-62-4.3/5.8 | *Dimensions 31-62-4.3/5.8*Albero motore lato frizione | *Crankshaft clutch side*

Vespa PE PXE 125-150-200 ('98)

R.O. 431122, 131102

**100666010**Dimensioni 31-62-4.3/5.8 | *Dimensions 31-62-4.3/5.8*Albero motore lato frizione struttura metallo | *Crankshaft clutch side metal frame*

Vespa PE PXE 125-150-200 ('98)

R.O. 242550

**100666025** **NEW****CORTECO**Dimensioni 31-62-4.3/5.8 | *Dimensions 31-62-4.3/5.8*Paraolio Blu | *Blue Oil Seal*Albero motore lato frizione | *Crankshaft clutch side*

Vespa 125 GTR 2° serie/TS 2° serie • Vespa 150 Sprint V 2° serie • Vespa Super 2° serie • Vespa Rally • Vespa PX 80-125-150-200/PE/Lusso/T5/Cosa

R.O. 131102/1



**100666045** NEW



**CORTECO**

Dimensioni 31-62,1-5,8/4,3 | Dimensions 31-62,1-5,8/4,3

Paraolio Blu | Blue Oil Seal

Vespa 125 GTR 2° serie/TS 2° serie • Vespa 150 Sprint V 2° serie • Vespa Super 2° serie • Vespa Rally • Vespa PX 80-125-150-200/PE/Lusso/T5/Cosa

R.O. 131102/1



**100666035** NEW



**CORTECO**

Dimensioni 31-62,1-4,3/5,8 | Dimensions 31-62,1-4,3/5,8

Paraolio Blu | Blue Oil Seal

Albero motore lato frizione | Crankshaft clutch side

Vespa PX PE 125-150-200('84-) Vespa T5 125 • Cosa 125-150-200 • Vespa Rally 180-200



**100666055** NEW



**CORTECO**

Dimensioni 32-52-5 | Dimensions 32-52-5

Paraolio Blu | Blue Oil Seal

Albero motore lato volano | Crankshaft flywheel side

Vespa 160 GS • Vespa 180 SS

R.O. S8733, 077976, 182789



**100666065** NEW



**CORTECO**

Dimensioni 35-47-7 | Dimensions 35-47-7

Paraolio Blu | Blue Oil Seal

Ruota posteriore | Rear wheel

Vespa 150 GS

R.O. 2/20359, 020359



**PARAOLI - OIL SEALS****KIT PARAOLI CON KIT OR - OIL SEAL KIT WITH OR****100640110**

Vespa 50-90 • Vespa 125 Primavera • Vespa ET3

Composizione Composition	Misure Measures	Q.tà	Codice RMS RMS Code
Albero motore lato volano - <i>Flywheel side</i>	19x32x7	1	<b>100661700</b>
Albero motore lato frizione - <i>Clutch side</i>	22.7x47x7/7.5	1	<b>100662700</b>
Albero ruota posteriore - <i>Rear wheel shaft</i>	27x37x7	1	<b>100664500</b>
Anelli O-Ring		6	-

**100640130**

Vespa PK 50 • Vespa PK XL • Vespa FL2 • Vespa Rush

Composizione Composition	Misure Measures	Q.tà	Codice RMS RMS Code
Albero motore lato volano - <i>Flywheel side</i>	20x32x7	1	<b>100662000</b>
Albero motore lato frizione - <i>Clutch side</i>	22.7x47x7/7.5	1	<b>100662700</b>
Albero ruota posteriore - <i>Rear wheel shaft</i>	27x37x7	1	<b>100664500</b>
Anelli O-Ring		6	-

**100640140**

Vespa Super • Vespa Sprint • Vespa 150 GL • Vespa VBB

Composizione Composition	Misure Measures	Q.tà	Codice RMS RMS Code
Albero motore lato frizione - <i>Clutch side</i>	20x40/60x56	1	-
Albero motore lato volano - <i>Flywheel side</i>	20x62x6,5	1	<b>100662360</b>
Albero ruota posteriore - <i>Rear wheel shaft</i>	27x37x7	1	<b>100664500</b>

**100640160**

Vespa PX 125-150 • Vespa PX Arcobaleno

Composizione Composition	Misure Measures	Q.tà	Codice RMS RMS Code
Albero motore lato volano - <i>Flywheel side</i>	24x35x6	1	<b>100663000</b>
Albero motore lato frizione - <i>Clutch side</i>	31x62x4.3/5.8	1	<b>100666060</b>
Albero ruota posteriore - <i>Rear wheel shaft</i>	27x47x6	1	<b>100664800</b>

**100640170**

Vespa PX 200 Arcobaleno

Composizione Composition	Misure Measures	Q.tà	Codice RMS RMS Code
Albero motore lato volano - <i>Flywheel side</i>	24x35x6	1	<b>100663000</b>
Albero motore lato frizione - <i>Clutch side</i>	31x62x4.3/5.8	1	<b>100666000</b>
Albero ruota posteriore - <i>Rear wheel shaft</i>	30x47x6	1	<b>100665500</b>

**100640180**

Vespa 125-150 T5 • Vespa Cosa

Composizione Composition	Misure Measures	Q.tà	Codice RMS RMS Code
Albero motore lato volano - <i>Flywheel side</i>	24x35x6	1	<b>100663000</b>
Albero motore lato frizione - <i>Clutch side</i>	31x62x4.3/5.8	1	<b>100666000</b>
Albero ruota posteriore - <i>Rear wheel shaft</i>	27x42x10	1	<b>100664700</b>

**100640250**

Vespa PX 200 Arcobaleno

Composizione Composition	Misure Measures	Q.tà	Codice RMS RMS Code
Albero motore lato volano - <i>Flywheel side</i>	24x35x6	1	<b>100663000</b>
Albero motore lato frizione struttura metallo - <i>Clutch side metal frame</i>	31x62x4,3/5/8	1	<b>100666010</b>
Albero ruota posteriore - <i>Rear wheel shaft</i>	30x47x6	1	<b>100665500</b>

**100640260****Blue**

Vespa PX 125-150 Arcobaleno

Composizione Composition	Misure Measures	Q.tà	Codice RMS RMS Code
Albero motore lato volano - <i>Flywheel side</i>	24x35x6	1	-
Albero motore lato frizione struttura metallo - <i>Clutch side metal frame</i>	31x62x4,3/5/8	1	-
Albero ruota posteriore - <i>Rear wheel shaft</i>	27x47x6	1	-

## PAROLI - OIL SEALS

100640270



### Blue

Vespa PX 200 Arcobaleno blue

Composizione <i>Composition</i>	Misure <i>Measures</i>	Q.tà	Codice RMS <i>RMS Code</i>
Albero motore lato volano - <i>Flywheel side</i>	24x35x6	1	-
Albero motore lato frizione struttura metallo - <i>Clutch side metal frame</i>	31x62x4,3/5/8	1	-
Albero ruota posteriore - <i>Rear wheel shaft</i>	30x47x6	1	-

## O-RING - O-RINGS

100706210



GUARNIZIONE COPERCHIO FRIZIONE | *CLUTCH COVER GASKET*

Confezione 5 Pz. | *5 Pcs Packing*

Vespa PX 125-150-200 • Vespa PX Arcobaleno  
• Vespa 150 GL • Vespa 150 Sprint • Vespa 180-  
200 Rally

R.O. 017881

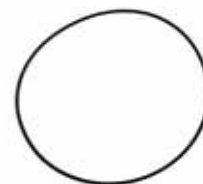

100706220



O-RING LEVETTA CAMBIO 6.75x2 mm | *O-RING GEAR LEVER 6.75x2 mm*

Confezione 5 Pz. | *5 Pcs Packing*

Vespa 50-90 • Vespa 125 Primavera • Vespa  
ET3

R.O. 006706



100706230



O-RING LEVETTA CAMBIO 8.73x1.78 mm |  
*O-RING GEAR LEVER 8.73x1.78 mm*

Confezione 5 Pz. | *5 Pcs Packing*

Vespa PX PE 125-150-200 • Vespa PX  
Arcobaleno

R.O. 006708



**O-RING - O-RINGS****100706240**

O-RING PER CAMMA FRENO 11.11x1.78 mm |  
*O-RING REAR CAM 11.11x1.78 mm*  
 Confezione 5 Pz. | 5 Pcs Packing  
 Vespa PX 125-150-200 • Vespa PX Arcobaleno  
 R.O. 006714

**100706260**

O-RING PER PERNO RUOTA 23.4x3.53 mm |  
*O-RING HUB 23.4x3.53 mm*  
 Confezione 5 Pz. | 5 Pcs Packing  
 Vespa PX 125-150-200  
 R.O. 006731

**100706270**

O-RING CARTER | *O-RING CRANKCASE*  
 Confezione 5 Pz. | 5 Pcs Packing  
 Vespa 50-90 • Vespa 125 Primavera • Vespa  
 ET3  
 R.O. 006716

**100706280**

O-RING PERNO SOSPENSIONE | *O-RING FRONT  
 WHEEL PIN*  
 Confezione 5 Pz. | 5 Pcs Packing  
 Vespa PX 125-150-200  
 R.O. 177408

**100706290**

O-RING MOZZO POSTERIORE | *O-RING REAR  
 HUB*  
 Confezione 5 Pz. | 5 Pcs Packing  
 Vespa PX 125-150-200  
 R.O. 78163



**100706300**



O-RING MOZZO POSTERIORE | O-RING REAR  
HUB

Confezione 5 Pz. | 5 Pcs Packing

Vespa old models

R.O. 79164



**100709030**



KIT O-RING

Kit 7 Pz. | 7 Pcs Kit

Vespa PX 125-150-200 • Vespa PX Arcobaleno

• Vespa GL • Vespa 150 Sprint • Vespa 180-200

Rally

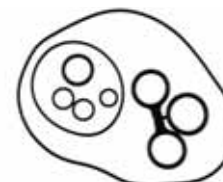

**100706330** **NEW**



ANELLO O-RING INGRANAGGIO ACCENSIONE

15.54X2.62 mm | STARTER GEAR O-RING

15.54X2.62 mm

Confezione 5 Pz. | 5 Pcs Packing

R.O.006721



G O M M E

T I R E S



## GOMME - TIRES

10"

997000160



**Continental**

Misura 3.00 - 10 | *Size 3.00 - 10*  
 Battistrada Contitwist | *Tread Contitwist*  
 Cod. Continental 0220014  
 Indice di Carico 50 | *Load Index 50*  
 Indice di velocità M | *Speed Index M*  
 Coperture TL (Tubeless) | *Tyres TL (Tubeless)*  
 Vespa small frame



997000310



**Continental**

Misura 3.50 -10 | *Size 3.50 -10*  
 Battistrada Contitwist | *Tread Contitwist*  
 Cod. Continental 0240101  
 Indice di Carico 59 | *Load Index 59*  
 Indice di velocità M | *Speed Index M*  
 Coperture TL (Tubeless) | *Tyres TL (Tubeless)*  
 Vespa large frame



8"

991000010 **NEW**



**KENDA**

Misura 3.50-8 | *Size 3.50-8*  
 Pattern K303  
 Indice di Carico 46 | *Load Index 46*  
 Indice di velocità J | *Speed Index J*  
 Coperture TL (Tubeless) | *Tyres TL (Tubeless)*  
 Vespa large frame



10"

991100011



**KENDA**

Misura 3.00-10 | *Size 3.00-10*  
 Battistrada Mich 83 | *Tread Mich 83*  
 Pattern K333  
 Indice di Carico 50 | *Load Index 50*  
 Indice di velocità J | *Speed Index J*  
 Coperture TT (Set copertura + camera) | *Tyres TT (Kit tyre and inner tube)*  
 Vespa small frame





## GOMME - TIRES

991100015

**KENDA**

Misura 3.00-10 | Size 3.00-10

Battistrada Fascia Bianca | Tread White Wall

Pattern K333

Indice di Carico 50 | Load Index 50

Indice di velocità J | Speed Index J

Coperture TL (Tubeless) | Tyres TL (Tubeless)

Vespa small frame



K333

991100030

NEW

**KENDA**

Misura 3.00-10 | Size 3.00-10

Pattern K303

Indice di Carico 42 | Load Index 42

Indice di velocità J | Speed Index J

Coperture TT (Set copertura + camera) | Tyres TT (Kit tyre and inner tube)

TT (Kit tyre and inner tube)

Vespa small frame



K303 A

991100102

**KENDA**

INVERNALE | WINTER

Misura 3.00-10 | Size 3.00-10

Battistrada Mich M+S | Tread Mich M+S

Pattern K701

Indice di Carico 47 | Load Index 47

Indice di velocità L | Speed Index L

Coperture TL (Tubeless) | Tyres TL (Tubeless)

Vespa small frame

K701  
M+S

991100021

NEW

**KENDA**

Misura 3.00-10 | Size 3.00-10

Pattern K711

Indice di Carico 47 | Load Index 47

Indice di velocità L | Speed Index L

Coperture TL (Tubeless) | Tyres TL (Tubeless)



K711

991200102



### KENDA



INVERNALE | WINTER

Misura 3.50-10 | Size 3.50-10

Battistrada Mich M+S | Tread Mich M+S

Pattern K701

Indice di Carico 56 | Load Index 56

Indice di velocità L | Speed Index L

Coperture TL (Tubeless) | Tyres TL (Tubeless)

Vespa large frame



991200001



### KENDA

Misura 3.50-10 | Size 3.50-10

Battistrada Mich 83 | Tread Mich 83

Pattern K333

Indice di Carico 51 | Load Index 51

Indice di velocità J | Speed Index J

Coperture TT (Set copertura + camera) | Tyres TT (Kit tyre and inner tube)

Vespa large frame



991200003



### KENDA

Misura 3.50-10 | Size 3.50-10

Battistrada Fascia Bianca | Tread White Wall

Pattern K333

Indice di Carico 51 | Load Index 51

Indice di velocità J | Speed Index J

Coperture TL (Tubeless) | Tyres TL (Tubeless)

Vespa large frame



991200010 **NEW**



### KENDA

Misura 3.50-10 | Size 3.50-10

Pattern K711

Indice di Carico 56 | Load Index 56

Indice di velocità L | Speed Index L

Coperture TL (Tubeless) | Tyres TL (Tubeless)



## GOMME - TIRES

991200015 **NEW****KENDA**

Misura 3.50-10 | Size 3.50-10

Pattern K303

Indice di Carico 51 | Load Index 51

Indice di velocità J | Speed Index J

Coperture TT (Set copertura + camera) | Tyres

TT (Kit tyre and inner tube)

Vespa large frame



K303 A

991103001

**DURO**

Misura 3.00-10 | Size 3.00-10

Battistrada Rock | Tread Rock

Pattern HF204A

N° Tele 4

Indice di Carico Non omologata | Load Index

Not homologated

Indice di velocità Non omologata | Speed Index

Not homologated

Coperture TT (Set copertura + camera) | Tyres

TT (Kit tyre and inner tube)

Valvola TR87 | Valve TR87

Vespa small frame

ROCK  
HF204A

991203001

**DURO**

Misura 3.50-10 | Size 3.50-10

Battistrada Rock | Tread Rock

Pattern HF204

N° Tele 4

Indice di Carico Non omologata | Load Index

Not homologated

Indice di velocità Non omologata | Speed Index

Not homologated

Coperture TT (Set copertura + camera) | Tyres

TT (Kit tyre and inner tube)

Valvola TR87 | Valve TR87

Vespa large frame

ROCK  
HF204

## CAMERE D'ARIA - TUBES

999100100



### KENDA

Misura 3.50-8 | Size 3.50-8  
 Valvola TR 87 | Valve TR 87  
 Valvola vulcanizzata | Vulcanised valve  
 Vespa large e small frame



999200001



### KENDA

Misura 3.00/3.50-10 | Size 3.00/3.50-10  
 Valvola TR 87 | Valve TR 87  
 Valvola vulcanizzata | Vulcanised valve  
 Vespa large e small frame



## VALVOLE - VALVES

### VALVOLE TUBELESS - TUBELESS VALVE

999999020



TR412  
 Valvola standard rivestita in gomma | Rubber covered straight valve  
 L: 25 mm



999999000



TR413  
 Valvola standard rivestita in gomma | Rubber covered straight valve  
 L: 35 mm



**VALVOLE - VALVES****999999010**

PVRT70

Valvola a gomito con base in gomma | 90°

*valve with rubber base*

A: 17 mm

B: 33 mm

90°

Ø foro valvola 10,2 mm | Ø Valve hole 10,2 mm

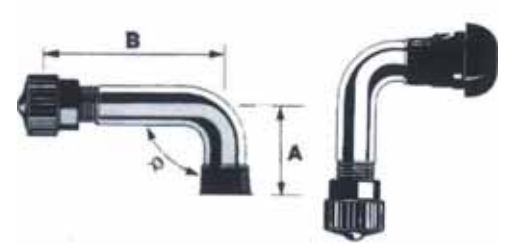



# ACCESSORI

ACCESSORIES



142560230 **NEW**



**FACO**



BAULETTO PORTAOGGETTI inclusa serratura e gommino portapacchi | *TOOL BOX with lock and rubber for carrier*

Per montaggio richiede staffa cod. 142561230 | *Required mounting plate cod. 142561230*

Vespa 50 N-L-R • Vespa 50 Special • Vespa 125 Primavera • Vespa 125 Primavera ET3



142561230 **NEW**



**FACO**



STAFFA SUPPORTO BAULETTO ANTERIORE | *FRONT CARRIER SUPPORT*

Vespa 50 N-L-R • Vespa 50 Special • Vespa 125 Primavera • Vespa 125 Primavera ET3



142800000



PORTAPACCO ANTERIORE CROMATO | *CHROMED FRONT CARRIER*

Vespa PX • LML  
R.O.610271M



142800071



PORTAPACCO ANTERIORE NERO | *BLACK FRONT CARRIER*

Vespa PX • LML





**PORTAPACCHI - CARRIERS****142800010**PORTAPACCO POSTERIORE CROMATO |  
*CHROMED REAR CARRIER*Vespa PX • LML  
R.O. 610270M**142800001**PORTAPACCO POSTERIORE NERO | *BLACK*  
*REAR CARRIER*

Vespa PX • LML

**142800020**PORTABAULETTO POSTERIORE CROMATO |  
*CHROMED REAR CARRIER*

Vespa PX • LML

**142800021**PORTABAULETTO POSTERIORE NERO | *BLACK*  
*REAR CARRIER*

Vespa PX • LML



## PORTAPACCHI - CARRIERS

142800080



PORTABAULETTO POSTERIORE CROMATO |  
*CHROMED REAR CARRIER*

Vespa 50-90 • Vespa 125 Primavera • Vespa  
ET3



142800081



PORTABAULETTO POSTERIORE NERO | *BLACK  
REAR CARRIER*

Vespa 50-90 • Vespa 125 Primavera • Vespa  
ET3



142800100 **NEW**



**FACO**



PORTAPACCO POSTERIORE VERNICIATO |  
*PAINTED REAR CARRIER*

Vespa PK 50-125 S/XL/XL2/FL/HP/N/Rush/  
Plurimatic



142800101 **NEW**



**FACO**



PORTAPACCO POSTERIORE CROMATO |  
*CHROMED REAR CARRIER*

Vespa PK 50-125 S/XL/XL2/FL/HP/N/Rush/  
Plurimatic



**PORTAPACCHI - CARRIERS****142800110** **NEW****FACO**PORTAPACCO ANTERIORE VERNICIATO |  
PAINTED FRONT CARRIERVespa tutti i modelli eccetto per - *All models*  
except for Vespa 50-90SS • Cosa**142800111** **NEW****FACO**PORTAPACCO ANTERIORE CROMATO |  
CHROMED FRONT CARRIERVespa tutti i modelli eccetto per - *All models*  
except for Vespa 50-90SS • Cosa**142800120** **NEW****FACO**PORTAPACCO POSTERIORE VERNICIATO |  
PAINTED REAR CARRIERVespa PX 80-125-150-200 • Vespa PE 125-150-  
200/Lusso/T5 Classic**142800121** **NEW****FACO**PORTAPACCO POSTERIORE CROMATO |  
CHROMED REAR CARRIERVespa PX 80-125-150-200 • Vespa PE 125-150-  
200/Lusso/T5 Classic

## PORTAPACCHI - CARRIERS

142800141 **NEW**



**FACO**



PORTABAULE POSTERIORE CROMATO |  
CHROMED REAR CARRIER

Vespa PX 80-125-150-200 • Vespa PE 125-150-200/Lusso/T5 Classic



142800160 **NEW**



**FACO**



PORTAPACCHI POSTERIORE VERNICIATO CON  
PORTATARGA | PAINTED REAR CARRIER WITH  
NUMBER PLATE HOLDER

Vespa 50 tutti i modelli - all models • Vespa 125 Primavera ET3



142800161 **NEW**



**FACO**



PORTAPACCHI POSTERIORE CROMATO CON  
PORTATARGA | CHROMED REAR CARRIER WITH  
NUMBER PLATE HOLDER

Vespa 50 tutti i modelli - all models • Vespa 125 Primavera ET3



142800170 **NEW**



**FACO**



PORTAPACCO POSTERIORE VERNICIATO |  
PAINTED REAR CARRIER

Vespa 50 tutti i modelli - all models • Vespa 125 Primavera ET3



**PORTAPACCHI - CARRIERS****142800171** **NEW****FACO**PORTAPACCO POSTERIORE CROMATO |  
*CHROMED REAR CARRIER*Vespa 50 tutti i modelli - *all models* • Vespa 125  
Primavera ET3**PARABREZZA E CUPOLINI - WINDSCREENS AND FAIRINGS****267008058** **NEW****FACO**Parabrezza Aste verniciate, attacchi inclusi |  
*Windscreen Painted rod, mounting kit included*Vespa FL/FL2 • Vespa N • Vespa PK 50-125S •  
Vespa PK 50-125XL**267008023** **NEW****FACO**Parabrezza Aste verniciate, attacchi inclusi |  
*Windscreen Painted rod, mounting kit included*

Vespa PE • Vespa PX • Vespa PX Arcobaleno

**267008056** **NEW****FACO**Parabrezza modello "4 stagioni" Aste  
verniciate, attacchi inclusi | *"4 seasons"*  
*Windscreen model Painted rod, mounting kit*  
*included*Omologato TÜV | *TÜV Homologation*

Vespa PE • Vespa PX • Vespa PX Arcobaleno



## PARABREZZA E CUPOLINI - WINDSCREENS AND FAIRINGS

267008007 **NEW**



**FACO**



Parabrezza Aste verniciate, attacchi inclusi |  
*Windscreen Painted rod, mounting kit included*  
Vespa PX ('01-'17) • Vespa PX Arcobaleno ('01-'17)



267008116 **NEW**



**FACO**



Parabrezza modello "Twin Screen" Aste cromate, attacchi inclusi | *"Twin Screen"*  
*Windscreen model Chromed rod, mounting kit included*  
Vespa PE • Vespa PX • Vespa PX Arcobaleno



267008349 **NEW**



**FACO**



Cupolino modello "New Design" Attacchi inclusi | *"New Design" model fairing Mounting kit included*  
Vespa PE • Vespa PX • Vespa PX Arcobaleno



267008350 **NEW**



**FACO**



Cupolino modello "Classic" Lastra chiara, aste cromate, attacchi inclusi | *"Classic" model fairing Clear sheet, chromed rod, mounting kit included*  
Vespa PE • Vespa PX • Vespa PX Arcobaleno



## PARABREZZA E CUPOLINI - WINDSCREENS AND FAIRINGS

267008351 **NEW****FACO**

Cupolino modello "Classic" Lastra chiara, aste verniciate, attacchi inclusi | *"Classic" model fairing Clear sheet, painted rod, mounting kit included*

Vespa PE • Vespa PX • Vespa PX Arcobaleno

267008134 **NEW****FACO**

Parabrezza Aste verniciate, attacchi inclusi | *Windscreen Painted rod, mounting kit included*

Vespa 50 Special







# OFFICINA

WORKSHOP

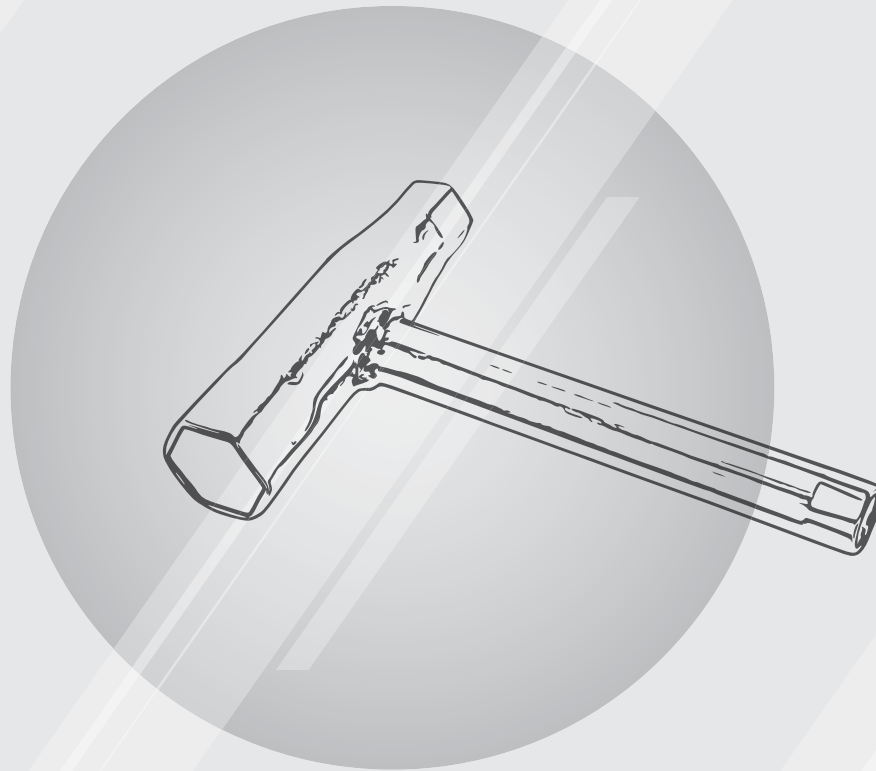

**267009123**



SUPPORTO MOTORE | *ENGINE SUPPORT*

Vespa PX • LML  
R.O. T0025095

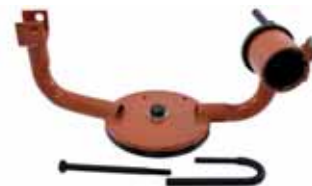

**267000010**



ATTREZZO TENDICAVO FRENO FRIZIONE |  
*BRAKE AND CLUTCH CABLE TENSIONER TOOL*

Vespa tutti i modelli | *Vespa all models*



**267009113**



ATTREZZO FERMA VOLANO | *HOLDING  
FLYWHEEL TOOL*

Vespa PX 125 - 150 • Vespa PE 200 • Vespa 150  
GL • Vespa Super • Vespa Sprint  
Veicoli large frame | *Large frame models*  
R.O. 19.1.20095



**267000030**



LEVA GOMME | *TIRES LEVER*



**267000193**



SET CHIAVI | *KEYS SET*

Vespa PX 125-150 • Vespa PE 200 • Vespa 150  
GL • Vespa Super • Vespa Sprint  
Veicoli large frame | *Large frame models*



**267000490**



CAVALLETTO BASE MOBILE | *MOVABLE STAND*

Portata massima: 250Kg | *Maximum Weight:  
250Kg*



ATTREZZI E UTENSILI - TOOLS

267000070



ESTRATTORE VOLANO Ø 22x1,5 (dx) |  
FLYWHEEL PULLER Ø 22x1,5 (dx)



267000080



ESTRATTORE VOLANO Ø 24x1 (dx) | FLYWHEEL  
PULLER Ø 24x1 (dx)



267000090



ESTRATTORE VOLANO Ø 26x1 (dx) | FLYWHEEL  
PULLER Ø 26x1 (dx)



267000100



ESTRATTORE VOLANO Ø 27x1 (sx) | FLYWHEEL  
PULLER Ø 27x1 (sx)



267000120



ESTRATTORE VOLANO Ø 28x1 (dx) | FLYWHEEL  
PULLER Ø 28x1 (dx)

Vespa 50 • Vespa 125 Primavera • Vespa ET3 •  
Vespa PK • Vespa PX



267000150



ESTRATTORE SMONTAGGIO FRIZIONE |  
CLUTCH PULLER

Filetto interno | Internal thread

Vespa 50-90 • Vespa 125 Primavera • Vespa  
ET3



**267000160**



ATTREZZO SMONTAGGIO GHIERA FRIZIONE |  
CLUTCH NUT REMOVAL TOOL

Vespa PX 125-150 • Vespa PE 200



**267000140**



ATTREZZO SPINGIDISCO FRIZIONE | CLUTCH  
PRESSURE PLATE TOOL

Vespa 50-90 • Vespa 125 Primavera • Vespa  
ET3



**267000170**



CHIAVE SERBATOIO | TANK TOOL

Vespa tutti i modelli | All models  
R.O. T032973



**267000173**



CHIAVE SERBATOIO | TANK TOOL

Vespa 160 GS • Vespa 180 SS • Vespa 180 - 200  
Rally  
R.O. T0027329



**267000183**



CHIAVE SERBATOIO | TANK TOOL

Vespa 50-90 • Vespa 125 Primavera • Vespa  
ET3



**121860200**



PIASTRINA PER VITE AUTOFILETTANTE Ø 2,9  
mm | SELF THREADING PLATE Ø 2,9 mm

Confezione 50 pz. | 50 Pcs Packing

Per fissaggio Clacson | For Horn fixing

Vespa 50 N-L-R • Vespa GL-Super 125-150 SS  
180 GT • Vespa 125 Sprint 150 • Vespa Rally  
180-200 • Vespa T5 125



## MINUTERIA METALLICA - HARDWARE

121860210



PIASTRINA PER VITE AUTOFILETTANTE Ø 3,5 mm | *SELF THREADING PLATE Ø 3,5 mm*  
 Confezione 50 pz. | *50 Pcs Packing*  
 Per fissaggio bordo scudo inferiore | *For lower shield fixing*



121860220



PIASTRINA PER VITE AUTOFILETTANTE Ø 4,2 mm | *SELF THREADING PLATE Ø 4,2 mm*  
 Confezione 50 pz. | *50 Pcs Packing*  
 Applicazioni varie | *Various applications*



121860230



PIASTRINA BRUNITA PER VITE AUTOFILETTANTE Ø 4,2 mm | *SELF THREADING PLATE Ø 4,2 mm*  
 Confezione 50 pz. | *50 Pcs Packing*  
 Applicazioni varie | *Various applications*



121860240



PIASTRINA PER VITE M 6 | *PLATE M 6*  
 Confezione 50 pz. | *50 Pcs Packing*  
 Applicazioni varie | *Various applications*



121856201

NEW



TAPPO SCARICO OLIO M8X10mm | *OIL DRAIN CUP M8X10mm*  
 Confezione 5 pz. | *5 Pcs Packing*  
 Applicazioni varie | *Various applications*  
 R.O. 138345



121859225

NEW

COPPIGLIA | *COTTER PIN*

**121859232** **NEW**



RONDELLA | *WASHER*

Dimensioni 12X6X0,5 mm | *Dimensions*

12X6X0,5 mm

Vespa ET2 • Vespa ET4 • Vespa LX • Vespa LXV  
• Vespa S • Vespa Primavera • Vespa Sprint •  
Vespa 946 • Vespa GTS/GTS Super • Vespa GTV  
• Vespa GT 60 • Vespa GT • Vespa GT L 50-300  
2T/4T

R.O. 006976



**121859233** **NEW**



RONDELLA FRIZIONE | *CLUTCH WASHER*

Dimensioni 34,0x15,2x3,4 mm | *Dimensions*

34,0x15,2x3,4 mm

Vespa 125 GTR • Vespa 125 TS • Vespa 150  
Sprint • Vespa Super • Vespa Rally • Vespa PX-  
PE-Lusso-T5

R.O. 113519



**121859234** **NEW**



RONDELLA PARKER | *PARKER WASHER*

Dimensioni 20,4X13 mm | *Dimensions*

20,4X13 mm

Vespa PK50-125/S/XL/XL2/PX80-200/PE/Lusso/  
Cosa/T5

R.O. 012555 (Piaggio)



**121859235** **NEW**



DADO VENTOLA FRIZIONE | *FAN CLUTCH NUT*

Dimensioni M12x1,25 mm | *Dimensions*

M12x1,25 mm

Vespa PK50-125 2°/S 2°/XL/XL2/125 GTR 2°/150  
TS 2°/Sprint V 2°/Super 2°/200 Rally 2°/PX80-  
200/PE/Lusso/Cosa/T5

Adattabile a | *Suitable for* LML Star 125-150 4T/  
Star Deluxe 125-150 4S/Speedy

R.O. 021112 (Piaggio) SF504-1048 (LML)



# A P E

519	<b>ASPIRAZIONE</b>	INTAKE SYSTEM	SISTEMA DE ADMISION	SYSTÈME D'ADMISSION
523	<b>ALIMENTAZIONE</b>	FUEL SYSTEM	SISTEMA DE COMBUSTIBLE	SYSTÈME D'ALIMENTATION
533	<b>MOTORE</b>	ENGINE	MOTOR	MOTEUR
543	<b>SCARICO</b>	EXHAUST SYSTEM	SISTEMA DE ESCAPE	SYSTÈME D'ÉCHAPPEMENT
547	<b>IMPIANTO FRENANTE</b>	BRAKING SYSTEM	SISTEMA DE FRENADOS	SYSTÈME DE FREINAGE
557	<b>IMPIANTO ELETTRICO</b>	ELECTRICAL SYSTEM	INSTALACION ELECTRICA	SYSTÈME ÉLECTRIQUE
579	<b>BATTERIE</b>	BATTERIES	BATERIAS	BATTERIES
581	<b>TRASMISSIONE</b>	TRANSMISSION	TRANSMISIÓN	TRANSMISSION
587	<b>CARROZZERIA</b>	BODY WORK	CARROCERIA	CARROSSERIE
595	<b>TELAIO</b>	CHASSIS	CHASIS	CHASSIS
619	<b>SOSPENSIONI</b>	SUSPENSIONS	SUSPENSIONES	SUSPENSIONS
625	<b>CUSCINETTI</b>	BEARINGS	COJINETES	ROULEMENT
631	<b>TENUTA</b>	TIGHT SYSTEM	SISTEMA DE RETENES	SYSTÈME DE JOINTS







# ASPIRAZIONE

INTAKE SYSTEM

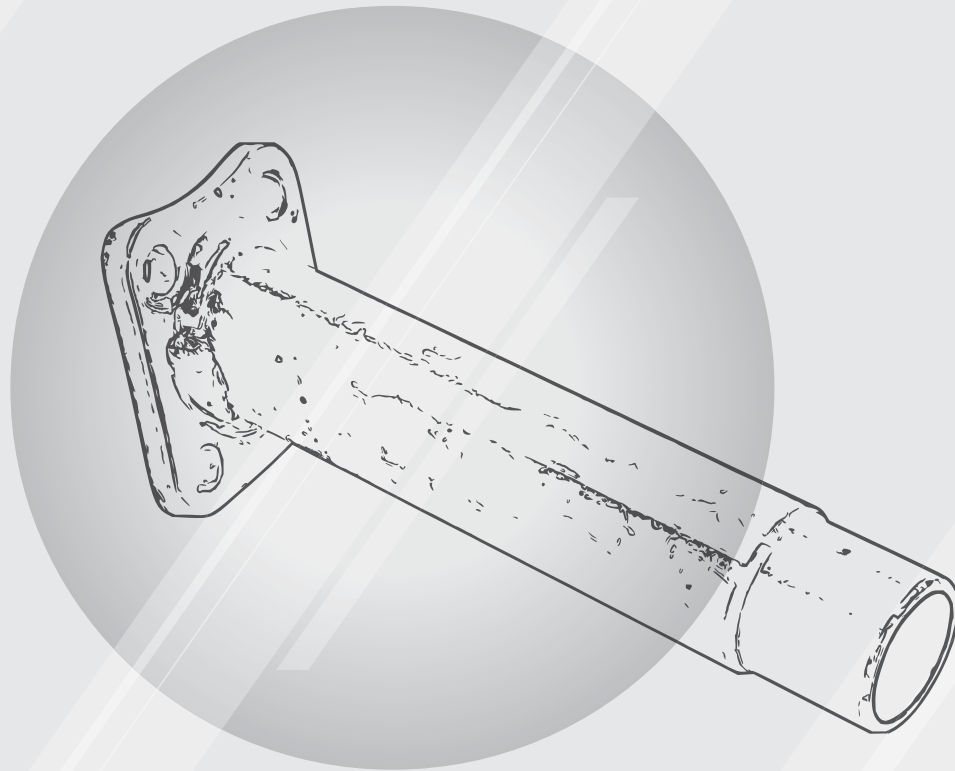

## FILTRI ARIA - AIR FILTERS

**100600610**



Ape 50 FL/FL2 ('80-'17)  
R.O. 119572, 260569, 295322, 234417



**100601191**



Filtro aria secondario | *Secondary air filter*  
Ape 50 FL/FL2 ('80-'17)  
R.O. 486942



## COLLETTORI ASPIRAZIONE - INLET PIPES

**100520220**



Tipologia attacco Tre fori | *Connection type*  
*Three holes*  
Diametro esterno Ø19 mm | *External diameter*  
*Ø19 mm*  
Lunghezza 115 mm | *Length 115 mm*  
Ape 50 FL/FL2 ('80-'17)  
R.O. 286889

### PRODOTTI CORRELATI | RELATED PRODUCTS



100703930



**100520230**



Tipologia attacco Tre fori | *Connection type*  
*Three holes*  
Diametro esterno Ø19 mm | *External diameter*  
*Ø19 mm*  
Lunghezza 135 mm | *Length 135 mm*  
Ape 250cc  
R.O. 127183

### PRODOTTI CORRELATI | RELATED PRODUCTS



100703930



COLLETTORI ASPIRAZIONE - INLET PIPES

**100520240**



Ape Car 220cc ('72-'86) • Ape MP 220cc ('78-'96) • Ape TM 220cc ('82-'07)  
R.O. 566859



**100520244**



Ape Car 220cc ('72-'86) • Ape MP 220cc ('78-'96) • Ape TM 220cc ('82-'07)  
R.O. 566859





# ALIMENTAZIONE

FUEL SYSTEM

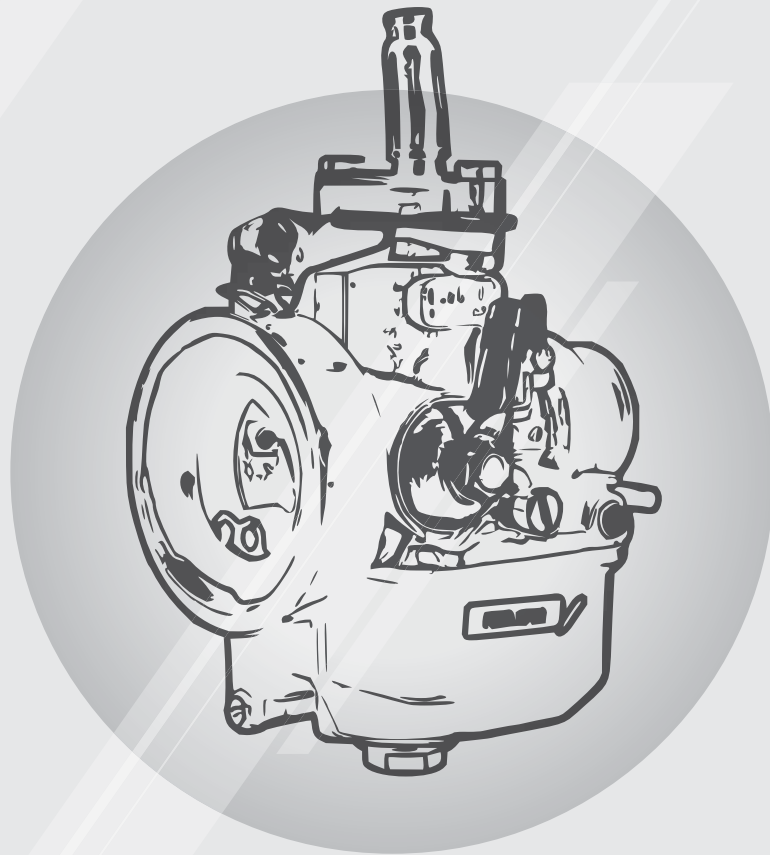

121700026 **NEW****DELL'ORTO**

Tipologia PHBL 24 BD | *Carburetor type PHBL 24 BD*

Codice Dell'Orto 02762 | *Dell'Orto part number 02762*

Getto massimo 95 | *Main jet 95*

Getto secondario 50 | *Idle mixture jet 50*

Con attacco miscelatore | *With oil mix plug*

Attacco elastico Ø 31 mm | *Soft connection Ø 31 mm*

Adattabile Piaggio Ape 50 | *Suitable for Piaggio Ape 50*

121700054 **NEW****DELL'ORTO**

Tipologia SHB 27-17B | *Carburetor type SHB 27-17B*

Codice Dell'Orto 00843 | *Dell'Orto part number 00843*

Getto massimo 90 | *Main jet 90*

Per modelli con lubrificazione separata | *For vehicles with separate lubrication*

Spillo quadrato molleggiato | *Square jet needle with spring*

Diametro foro aspirazione aria Ø 17 mm | *Intake hole diameter Ø 17 mm*

Ape MP P501-601 ('78-'96)

R.O. 183061

121700055 **NEW****DELL'ORTO**

Tipologia SHB 27-24 | *Carburetor type SHB 27-24*

Codice Dell'Orto 00834 | *Dell'Orto part number 00834*

Getto massimo 120 | *Main jet 120*

Spillo quadrato molleggiato | *Square jet needle with spring*

Diametro foro aspirazione aria Ø 24 mm | *Intake hole diameter Ø 24 mm*

Ape MP P501-601 ('78-'96)

R.O. 180597



## CARBURATORI - CARBURETORS

121700056

NEW

**DELL'ORTO**

Tipologia SHB 27-24 | Carburetor type SHB  
27-24

Codice Dell'Orto 00777 | Dell'Orto part number  
00777

Getto massimo 120 | Main jet 120

Spillo quadrato molleggiato | Square jet needle  
with spring

Diametro foro aspirazione aria Ø 24 mm |  
Intake hole diameter Ø 24 mm

Ape MP 600  
R.O. 125278



121700058

NEW

**DELL'ORTO**

Tipologia SHBC 18-16A | Carburetor type SHBC  
18-16A

Codice Dell'Orto 00896 | Dell'Orto part number  
00896

Getto massimo 71 | Main jet 71

Attacco manicotto al motore Ø 23 mm | Engine  
connection Ø 23 mm

Ape P 50 ('80-'85) • Ape 50



121700059

NEW

**DELL'ORTO**

Tipologia SHBC 18-16N | Carburetor type SHBC  
18-16N

Codice Dell'Orto 00938 | Dell'Orto part number  
00938

Getto massimo 60 | Main jet 60

Attacco manicotto al motore Ø 23 mm | Engine  
connection Ø 23 mm

Ape FL-FL2 ('89-'95) • Ape FL3 Europa ('96-'99)  
• Ape TM P ('85-'89)

R.O. 286890



## CARBURATORI - CARBURETORS

121700060 **NEW**



### DELL'ORTO

Tipologia SHBC 18-16P | *Carburetor type SHBC 18-16P*

Codice Dell'Orto 00958 | *Dell'Orto part number 00958*

Getto massimo 56 | *Main jet 56*

Attacco manicotto al motore Ø 23 mm | *Engine connection Ø 23 mm*

Ape 50 ('09-'17) • Ape Mix 2T ('98-'08) • Ape RST Mix ('99-'03)

R.O. B015238 - 834870



121700309 **NEW**



### DELL'ORTO

Tipologia SHBB 22-22 | *Carburetor type SHBB 22-22*

Codice Dell'Orto 00893 | *Dell'Orto part number 00893*

Getto massimo 76 | *Main jet 76*

Ape Car P2-P3 ('78-'85) • Ape TM P703-P703V FL2 ('84-'07) • Ape TM ('09-'16)

R.O. 832103



## RUBINETTI BENZINA - FUEL TAPS

121670180



Ape P 50 ('80-'85) • Ape TM P 50 ('85-'89)

R.O. 118092





## RUBINETTI BENZINA - FUEL TAPS

121670190



Diametro foro di uscita benzina Ø8mm | Fuel  
oulet pipe dimension Ø8mm

Ape 50 ('89-'17) • Ape TM 220cc ('09-'16) • Ape  
TM P602 220cc ('82-'83) • Ape TM P703 220cc  
( '84-'07)

R.O. 189320



121670200



Ape MP P501-P601 220cc ('78-'96)

R.O. 118422



## FILTRI CARBURANTE - FUEL FILTERS

100607000



Tipologia Filtro benzina | Filter type Fuel filter

Attacco tubo Ø 6-8 mm | Pipe attack Ø 6-8 mm

Elemento filtrante in carta | Paper filter

Confezione 10 pz. | 10 Pcs Packing



**100607010**



Tipologia Filtro benzina | *Filter type Fuel filter*  
 Attacco tubo Ø 7 mm | *Pipe attack Ø 7 mm*  
 Confezione 10 pz. | *10 Pcs Packing*



**100607040**



**UFI**

Tipologia Filtro gasolio | *Filter type Diesel fuel filter*  
 Codice UFI 2435100 | *UFI part number 2435100*  
 Dimensioni 130x80 mm M16 | *Dimensions 130x80 mm M16*  
 Ape TMP 703 420cc Diesel • Ape Poker 420cc Diesel  
 R.O. 247444 - 438015



**100607050**



**UFI**

Tipologia Filtro gasolio | *Filter type Diesel fuel filter*  
 Codice UFI 2435001 | *UFI part number 2435001*  
 Dimensioni 113,5x81 mm M16 | *Dimensions 113,5x81 mm M16*  
 Ape Car Diesel 420cc (86-'96) • Ape TM P 703 Diesel 420cc ('87-'04) • Ape Poker Diesel 420cc ('93-'97)  
 R.O. 438015



**100607080**



**UFI**

Tipologia Filtro gasolio | *Filter type Diesel fuel filter*  
 Codice UFI 24.H20.04 | *UFI part number 24.H20.04*  
 Dimensioni 150x85 mm M16 | *Dimensions 150x85 mm M16*  
 Ape TM Diesel LCS ('05-'12) • Ape TM P703-P703V Diesel ('87-'04)  
 R.O. 493290



SERBATOI BENZINA E ACCESSORI - FUEL TANKS AND ACCESSORIES

121650030



Tappo serbatoio | Fuel cap  
 Con asta livello carburante | With fuel indicator rod  
 Confezione 5 pz. | 5 Pcs Packing  
 Ape 50 anni '70 - '70's



121650080



Tappo serbatoio | Fuel cap  
 Con asta livello carburante | With fuel indicator rod  
 Ape 50 anni '70 - '70's



121650140

NEW



Tappo serbatoio | Fuel cap  
 Con serratura e chiavi | With lock and keys  
 Diametro esterno calotta Ø72 mm | Shell diameter Ø72 mm  
 Diametro innesto interno Ø43,3 mm | Joint diameter Ø43,3 mm  
 Ape TM 220 ('09-'16) • Ape TM Diesel 420 ('05-'12)  
 R.O. 613726



121650150

NEW



Tappo serbatoio | Fuel cap  
 Con serratura e chiavi, in metallo | With lock and keys, iron made  
 Diametro esterno calotta Ø57 mm | Shell diameter Ø57 mm  
 Diametro innesto interno Ø33 mm | Joint diameter Ø33 mm  
 Ape 50 FL-FL2-FL3 ('89-'99) • Ape P ('80-'85) • Ape TM ('85-'89)  
 R.O. 2705865



## SERBATOI BENZINA E ACCESSORI - FUEL TANKS AND ACCESSORIES

121650160 **NEW**



Tappo serbatoio | *Fuel cap*  
 Con serratura e chiavi, in plastica | *With lock and keys, plastic made*

Diametro esterno calotta Ø48,5 mm | *Shell diameter Ø48,5 mm*

Diametro innesto interno Ø30 mm | *Joint diameter Ø30 mm*

Ape 50 FL-FL2-FL3 ('89-'99) • Ape P ('80-'85) • Ape TM ('85-'89)

R.O. 2705865



121710060



TRASMETTITORE LIVELLO BENZINA | *FUEL GAUGE*

Ape 50 ('89-'17)

R.O. 291530



121710080



TRASMETTITORE LIVELLO BENZINA | *FUEL GAUGE*

Ape 50 2T EU4 ('18-'22)

R.O. 1D002522



## ACCESSORI CARBURATORE - CARBURETOR ACCESSORIES

121680110



SPILO CARBURATORE Triangolare | *FLOAT NEEDLE 3 sided*

Ape 50 ('80-'22)

R.O. 247653



ACCESSORI CARBURATORE - CARBURETOR ACCESSORIES

**121859030**



FASCETTA BANDA PIENA Ø 15-25 mm | CLAMP  
 Ø 15-25 mm  
 Confezione 5 pz. | 5 Pcs Packing



**121859040**



FASCETTA BANDA PIENA Ø 20-32 mm | CLAMP  
 Ø 20-32 mm  
 Confezione 10 pz. | 10 Pcs Packing



**121859050**



FASCETTA BANDA PIENA Ø 32-50 mm | CLAMP  
 Ø 32-50 mm  
 Confezione 10 pz. | 10 Pcs Packing



**121859060**



FASCETTA BANDA PIENA Ø 50-70 mm | CLAMP  
 Ø 50-70 mm  
 Confezione 10 pz. | 10 Pcs Packing





# MOTORE

ENGINE

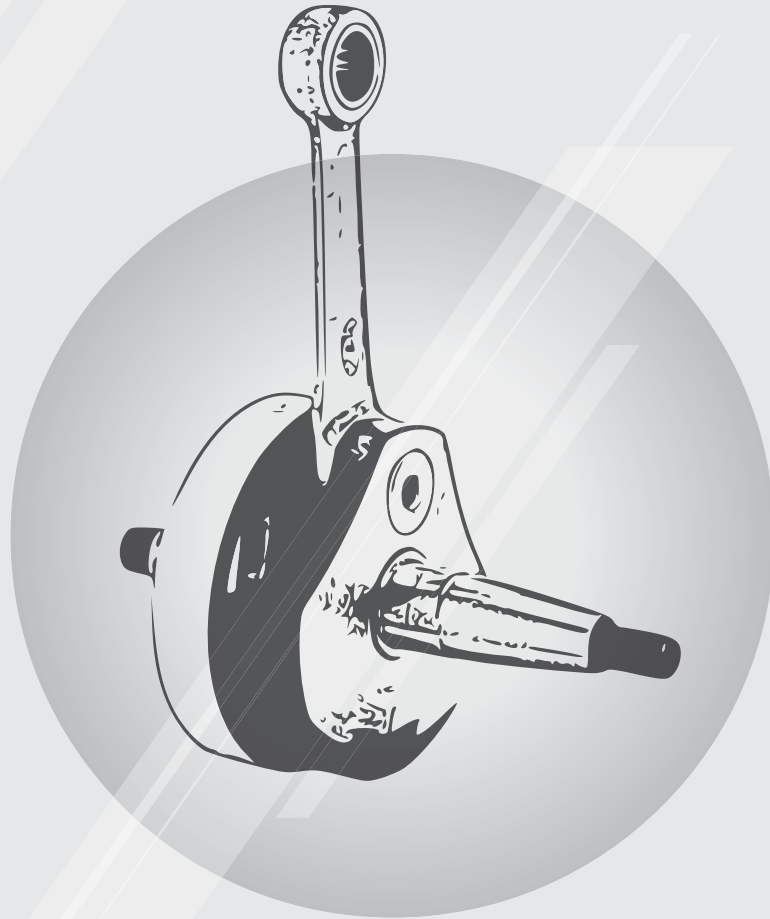

## ALBERI MOTORE - CRANKSHAFTS

100010410



Tipo standard | *Standard type*  
 Spinotto Ø 12 mm | *Pin Ø 12 mm*  
 Gabbia a rulli inclusa | *Roller cage included*  
 Ape 50 ('03-'10)  
 R.O. 8462675

### PRODOTTI CORRELATI | RELATED PRODUCTS



100200770 SKF



100150300



100012017

**NEW**



Tipo standard | *Standard type*  
 Codice fornitore AMT 010 | *Supplier product code AMT 010*  
 Ape Car 220  
 R.O. 152488





## CILINDRI - CYLINDERS

**100080181**

Alesaggio Ø 68 mm | Bore Ø 68 mm  
 Spinotto Ø 18 mm | Piston pin Ø 18 mm  
 Cilindrata 200cc | Displacement 200cc  
 Ape Car P2-P3 ('72-'86) • Ape MP P 501-601  
 ('78-'96) • Ape TM P602 ('82-'83) • Ape TM  
 P703 ('99-'07) • Ape TM ('09-'16)  
 R.O. 828864

## RICAMBI | SPARE PARTS



100090181 - 68 mm



100100180 - 68 mm  
 100010184 - 68,4 mm  
 100100186 - 68,6 mm  
 100100188 - 68,8 mm



100703080  
 100705320

**100080280** **NEW****100080281**

## GRUPPI TERMICI RACING | RACING CYLINDER KITS

Utilizzo esclusivo per uso agonistico, vietato  
 l'uso su strade pubbliche | *Only for racing use,  
 the use on public road is forbidden*  
 Alesaggio Ø 47 mm | Bore Ø 47 mm  
 Spinotto Ø 12 mm | Piston pin Ø 12 mm  
 Tre travasi | Three intake ports  
 Cilindrata 75cc | Displacement 75cc  
 Corsa 43 mm | Stroke 43 mm  
 Inclusa testa cilindro | Cylinder head included  
 Ape 50 ('80-'22)

## RICAMBI | SPARE PARTS



100090280 - 47 mm  
 100090281 - 47 mm  
 100090284 - 47,4 mm  
 100090285 - 47,4 mm  
 100090289 - 47,8 mm



100100281 - 47 mm  
 100100285 - 47,4 mm  
 100100288 - 47,8 mm  
 100100289 - 47,8 mm



-

**100080270** **NEW****100080271**

## GRUPPI TERMICI RACING | RACING CYLINDER KITS

Utilizzo esclusivo per uso agonistico, vietato  
 l'uso su strade pubbliche | *Only for racing use,  
 the use on public road is forbidden*  
 Alesaggio Ø 50 mm | Bore Ø 50 mm  
 Spinotto Ø 12 mm | Piston pin Ø 12 mm  
 Tre travasi | Three intake ports  
 Cilindrata 90cc | Displacement 90cc  
 Corsa 43 mm | Stroke 43 mm  
 Inclusa testa cilindro | Cylinder head included  
 Ape 50 ('80-'22)

## RICAMBI | SPARE PARTS



100090270 - 50 mm  
 100090271 - 50 mm  
 100090275 - 50,4 mm  
 100090278 - 50,8 mm  
 100090279 - 50,8 mm



100100270 - 50 mm  
 100100271 - 50 mm  
 100100274 - 50,4 mm  
 100100275 - 50,4 mm  
 100100278 - 50,8 mm  
 100100279 - 50,8 mm



-



## CILINDRI - CYLINDERS

**100080140** **NEW**



GRUPPI TERMICI RACING | RACING CYLINDER KITS

Utilizzo esclusivo per uso agonistico, vietato l'uso su strade pubbliche | *Only for racing use, the use on public road is forbidden*

Alesaggio Ø 55 mm | Bore Ø 55 mm

Spinotto Ø 12 mm | Piston pin Ø 12 mm

Sei travasi | Six intake ports

Cilindrata 102cc | Displacement 102cc

Corsa 43 mm | Stroke 43 mm

Inclusa testa cilindro | Cylinder head included

Ape 50 ('80-'22)

### RICAMBI | SPARE PARTS



100090140 - 55 mm  
100090141 - 55 mm  
100090145 - 55,4 mm  
100090149 - 55,8 mm



100100140 - 55 mm  
100100141 - 55 mm  
100100145 - 55,4 mm  
100100148 - 55,8 mm  
100100149 - 55,8 mm



-



**100080520** **NEW**



**100080521**



Alesaggio Ø 38,4 mm | Bore Ø 38,4 mm

Spinotto Ø 12 mm | Piston pin Ø 12 mm

Tre travasi | Three intake ports

Cilindrata 50cc | Displacement 50cc

Ape 50 ('80-'22)

### RICAMBI | SPARE PARTS



100090520 - 38,4 mm  
100090521 - 38,4 mm  
100090529 - 39 mm



100100520 - 38,4 mm  
100100521 - 38,4 mm



-



## PISTONI - PISTONS

Applicazioni <i>Applications</i>	Codice RMS <i>RMS Code</i>	Codice a barre <i>Barcode</i>	Diametro <i>Diameter</i>	Spinotto <i>Piston pin</i>	Per kit cilindro <i>For cylinder kit</i>	Codice a barre <i>Barcode</i>
Ape 50 ('80-'22)	100090520		Ø 38,4 mm	Ø 12 mm	100080520	
Ape 50 ('80-'22)	100090521		Ø 38,4 mm	Ø 12 mm	100080521	
Ape 50 ('80-'22)	100090280		Ø 47 mm	Ø 12 mm	100080281	
Ape 50 ('80-'22)	100090281		Ø 47 mm	Ø 12 mm	100080280	
Ape 50 ('80-'22)	100090284		Ø 47,4 mm	Ø 12 mm	100080281	
Ape 50 ('80-'22)	100090285		Ø 47,4 mm	Ø 12 mm	100080280	
Ape 50 ('80-'22)	100090289		Ø 47,8 mm	Ø 12 mm	100080280	
Ape 50 ('80-'22)	100090270		Ø 50 mm	Ø 12 mm	100080270	
Ape 50 ('80-'22)	100090271		Ø 50 mm	Ø 12 mm	100080271	
Ape 50 ('80-'22)	100090275		Ø 50,4 mm	Ø 12 mm	100080270	
Ape 50 ('80-'22)	100090278		Ø 50,8 mm	Ø 12 mm	100080271	
Ape 50 ('80-'22)	100090279		Ø 50,8 mm	Ø 12 mm	100080270	
Ape 50 ('80-'22)	100090140		Ø 55 mm	Ø 12 mm	100080140	
Ape 50 ('80-'22)	100090141		Ø 55 mm	Ø 12 mm	100080141	
Ape 50 ('80-'22)	100090145		Ø 55,4 mm	Ø 12 mm	100080140	
Ape 50 ('80-'22)	100090149		Ø 55,8 mm	Ø 12 mm	100080140	
Ape Car P2-P3 ('72-'86) • Ape MP P 501-601 ('78-'96) • Ape TM P602 ('82-'83) • Ape TM P703 ('99-'07) • Ape TM ('09-'16)	100090181		Ø 68 mm	Ø 18 mm	100080181	
Ape Car P2-P3 ('72-'86) • Ape MP P 501-601 ('78-'96) • Ape TM P602 ('82-'83) • Ape TM P703 ('99-'07) • Ape TM ('09-'16)	100090364		Ø 68,4 mm	Ø 16 mm		
Ape Car P2-P3 ('72-'86) • Ape MP P 501-601 ('78-'96) • Ape TM P602 ('82-'83) • Ape TM P703 ('99-'07) • Ape TM ('09-'16)	100090366		Ø 68,6 mm	Ø 16 mm		
Ape Car P2-P3 ('72-'86) • Ape MP P 501-601 ('78-'96) • Ape TM P602 ('82-'83) • Ape TM P703 ('99-'07) • Ape TM ('09-'16)	100090368		Ø 68,8 mm	Ø 16 mm		

## FASCE ELASTICHE - PISTON RINGS

Applicazioni <i>Applications</i>	Codice RMS <i>RMS Code</i>	Codice a barre <i>Barcode</i>	Dimensioni <i>Dimensions</i>
Ape 50 ('80-'22)	100100521		Ø 38,4 mm X 1,5 mm
Ape 50 ('80-'22)	100100520		Ø 38,4 mm X 1,5 mm
Ape 50 ('80-'22)	100100281		Ø 47 mm X 1,5 mm
Ape 50 ('80-'22)	100100285		Ø 47,4 mm X 1,5 mm
Ape 50 ('80-'22)	100100288		Ø 47,8 mm X 1,5 mm
Ape 50 ('80-'22)	100100289		Ø 47,8 mm X 1,5 mm
Ape 50 ('80-'22)	100100270		Ø 50 mm X 1,5 mm
Ape 50 ('80-'22)	100100271		Ø 50 mm X 1,5 mm
Ape 50 ('80-'22)	100100274		Ø 50,4 mm X 1,5 mm
Ape 50 ('80-'22)	100100275		Ø 50,4 mm X 1,5 mm
Ape 50 ('80-'22)	100100278		Ø 50,8 mm X 1,5 mm
Ape 50 ('80-'22)	100100279		Ø 50,8 mm X 1,5 mm
Ape 50 ('80-'22)	100100140		Ø 55 mm X 1,5 mm
Ape 50 ('80-'22)	100100141		Ø 55 mm X 1,5 mm
Ape 50 ('80-'22)	100100145		Ø 55,4 mm X 1,5 mm
Ape 50 ('80-'22)	100100148		Ø 55,8 mm X 1,5 mm
Ape 50 ('80-'22)	100100149		Ø 55,8 mm X 1,5 mm
Ape Car P2-P3 ('72-'86) • Ape MP P 501-601 ('78-'96) • Ape TM P602 ('82-'83) • Ape TM P703 ('99-'07) • Ape TM ('09-'16)	100100184		Ø 68,4 mm X 2,5 mm
Ape Car P2-P3 ('72-'86) • Ape MP P 501-601 ('78-'96) • Ape TM P602 ('82-'83) • Ape TM P703 ('99-'07) • Ape TM ('09-'16)	100100186		Ø 68,6 mm X 2,5 mm
Ape Car P2-P3 ('72-'86) • Ape MP P 501-601 ('78-'96) • Ape TM P602 ('82-'83) • Ape TM P703 ('99-'07) • Ape TM ('09-'16)	100100188		Ø 68,8 mm X 2,5 mm

## KIT REVISIONE ALBERO MOTORE - CRANKSHAFT REVISION KIT

**100200770**

Ape 50 ('80-'22)

1	Cuscinetto SKF   Bearing SKF	17-47-14 6303 C3
1	Cuscinetto SKF   Bearing SKF	20-47-14 6204 C5
1	Paraolio   Oil seal	22,7-47-717,5
1	Paraolio   Oil seal	20-32-7



## FILTRI OLIO - OIL FILTERS

**100609010****UFI**

Diametro esterno Ø 96 mm | External diameter Ø 96 mm

Altezza 96,5 mm | Height 96,5 mm

Filetto 3/4-16" UNF | Thread 3/4-16" UNF

Ape Calessino 420cc ('07-'12) • Ape Car Diesel 420cc ('86-'96) • Ape MP601 Classic 420cc ('06-'13) • Ape Poker 420cc ('93-'97) • Ape TM Diesel 420cc ('87-'12)

R.O. 830424 • 222721



## SERBATOIO OLIO - OIL TANK

**121730010**

Con indicatore riserva | With reserve indicator

Ape TM602 220cc • Ape TM703-P703V 220cc

• Ape FL2 220cc • Ape TM 220cc • Ape MP

P501-P601 220cc

R.O. 2634496



## ACCESSORI SERBATOI OLIO - OIL TANKS ACCESSORIES

**121856070**



Tappo scarico olio motore | *Engine Oil Cup*  
 M8x8 mm | *M8x8 mm*  
 Confezione 5 Pz. | *5 Pcs Packing*  
 Ape 50 ('80-'22)



**121678010**



Rccordo olio | *Oil pipe connector*  
 Ape RST Mix 50 ('99-'05)  
 R.O. 574362



## PIGNONI MESSA IN MOTO - PINION STARTERS

**100254660**



Z11  
 Ape TM P 50 ('85-'89) • Ape FL-FL2 50 ('89-'95)  
 • Ape FL3 Europa 50 ('96-'99) • Ape RST Mix 50 ('99-'03)  
 R.O. 248293



## MOLLE MESSA IN MOTO - STARTER SPRINGS

**121930060**



Molla messa in moto | *Starter spring*  
 Confezione 5 Pz. | *5 Pcs Packing*  
 Ape 50 ('85-'99)



## PRIGIONIERI MOTORE - ENGINE STUDS

**121858760**

Vite Carter Motore | *Crankcase Bolt*  
 Dimensioni M7 X 90 mm | *Dimensions M7 X 90 mm*  
 Confezione 5 Pz. | *5 Pcs Packing*  
 Ape 50 ('80-'22) • Ape TM P 703 220cc ('84-'07) • Ape Car 200cc ('78-'85)  
 R.O. 015647

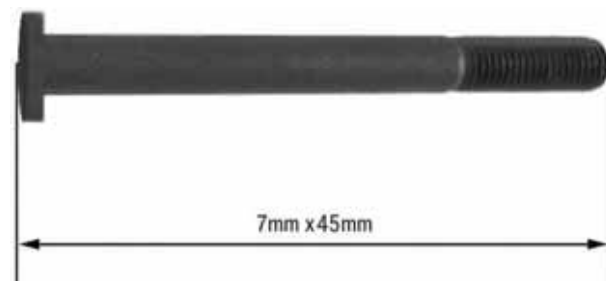
**121860280**

Prigioniero Cilindro Motore | *Cylinder stud*  
 Dimensioni 7 X 35 mm | *Dimensions 7 X 35 mm*  
 Ape 50 ('85-'22)  
 R.O. 000480

**121856130**

Prigioniero Cilindro Motore | *Cylinder stud*  
 Dimensioni 8 X 160 mm | *Dimensions 8 X 160 mm*  
 Confezione 4 Pz. | *4 Pcs Packing*  
 Ape MP 220cc ('78-'96) • Ape TM 220cc ('84-'16) • Ape Car 220cc ('72-'86)  
 R.O. 0160586



## KIT PRIGIONIERI MOTORE - ENGINE STUDS

121860150



Ape 50 ('80-'22)

1	Bullone   Bolt	M7X75 mm
3	Bullone   Bolt	M7X45mm
1	Bullone   Bolt	M7X54mm
8	Rondella piana   Washer	Ø7mm
8	Rondella Grower   Grower washer	Ø7mm
2	Bullone   Bolt	M7X80mm
1	Bullone   Bolt	M7X90mm
8	Dado   Nut	M7X1mm UNI 5587



## CUFFIE MOTORE - CYLINDER COWLINGS

142560180



Ape TM P602 220cc ('82-'83) • Ape 220cc TM  
P703-P703V-FL2 220cc ('84-'05) • Ape TM  
220cc ('09-'15)  
R.O. 231308





# SCARICO

EXHAUST SYSTEM

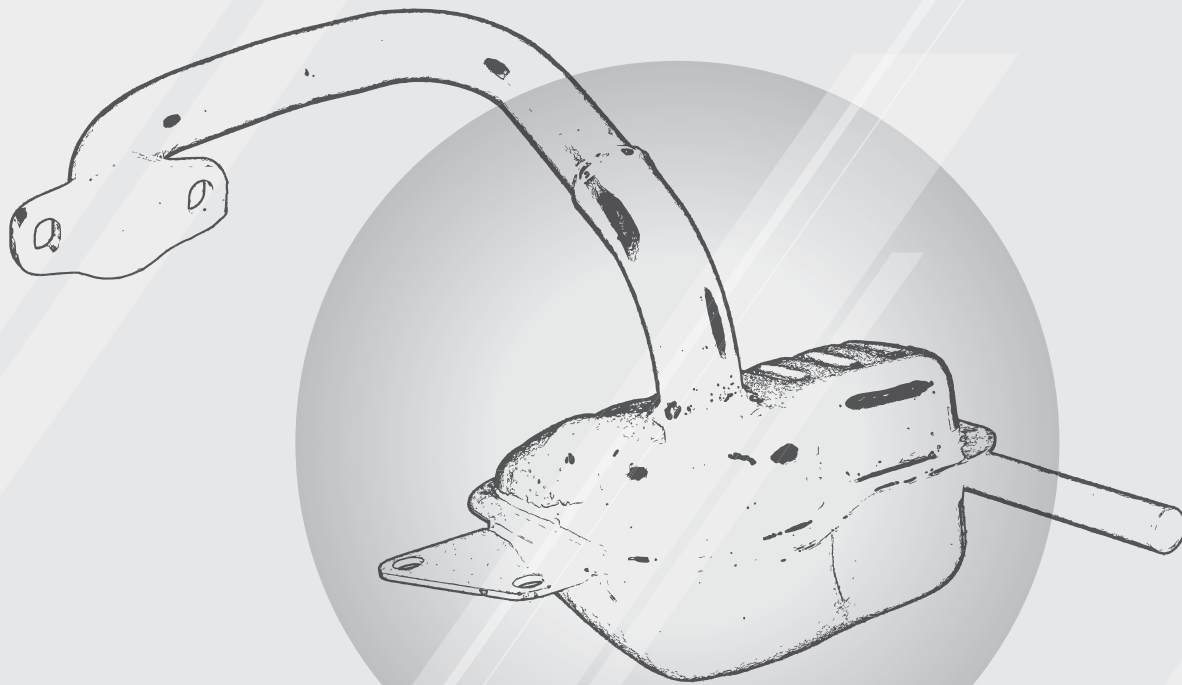

## MARMITTE - TUBI SCARICO - MUFFLERS

**100751090**



Resistente fino a 500°, verniciata nera | 500°

*Heat resistance, black painting*

Ape P 50 ('80-'85)

R.O. 129246



**100751180**



Resistente fino a 500°, verniciata nera | 500°

*Heat resistance, black painting*

Ape FL-FL2 ('89-'95) • Ape FL3 Europa ('96-'99)

• Ape Mix 2T ('98-'08) • Ape P ('80-'85) • Ape

RST Mix ('99-'03) • Ape TM P ('85-'89) • Ape

Web 2T ('01-'08)

R.O. 830452



## ACCESSORI MARMITTE - TUBI DI SCARICO - MUFFLERS ACCESSORIES

**100720010**

CARTUCCIA LANA DI ROCCIA Ø60x170 mm |  
 ROCKWOOL CARTRIDGE Ø60x170 mm

**100720020**

CARTUCCIA LANA DI ROCCIA Ø80x300 mm |  
 ROCKWOOL CARTRIDGE Ø80x300 mm

**100720030**

FOGLIO LANA DI ROCCIA 600x320x30 mm |  
 ROCKWOOL SHEET 600x320x30 mm

**121830130**

SUPPORTO ELASTICO X MARMITTA | RUBBER  
 MUFFLER BRACKET

Ape FL-FL2 ('89-'95) • Ape FL3 Europa ('96-'99)  
 • Ape Mix 2T ('98-'08) • Ape P ('80-'85) • Ape  
 RST Mix ('99-'03) • Ape TM P ('85-'89) • Ape  
 ('09-'15)  
 R.O. 127350





# IMPIANTO FRENANTE

BRAKING SYSTEM



**225120170**



Anteriore | *Front*

Ape 50 P ('80-'85) • Ape 50 TM P ('85-'89)  
 • Ape 50 FL-FL2 ('89-'95) • Ape FL3 Europa ('96-'99)  
 • Ape RST Mix ('99-'05) • Ape Euro2 ('03-'10)  
 R.O. 266506

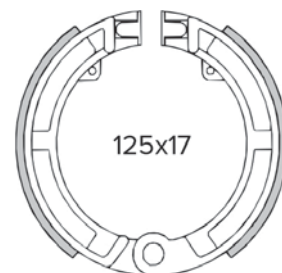

**225120220**



Serie ganasce posteriori (4 pezzi) | *Rear wheels set (4pcs.)*

Ape 50 ('80-'17)  
 R.O. 154998

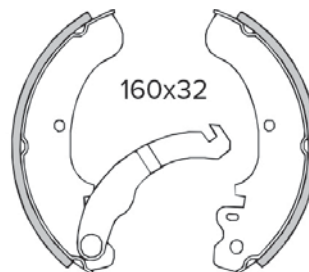

**225120221**



Serie ganasce posteriori (4 pezzi) | *Rear wheels set (4pcs.)*

Ape 50 ('80-'17)  
 R.O. 154998

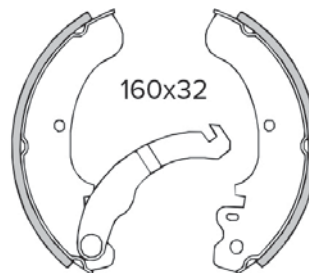

**225120251**



Serie anteriore + posteriore 6 Pezzi | *Front + Rear Set 6 pcs packaging*

Ape Car Diesel 420cc ('86-'96) • Ape Max Diesel 420cc ('86-'96)  
 • Ape MP 501-601 420cc ('78-'96)  
 R.O. 498401



GANASCE FRENO - BRAKE SHOES

225120261



Serie anteriore + posteriore 6 Pezzi | *Front + Rear Set 6 pcs packaging*  
Posteriore | *Rear*

Ape Car P2-P3 220cc ('78-'85) • Ape TM P602 220cc ('82-'83) • Ape TM P703-P703V-FL2 220cc ('84-'02) • Ape TM 220 ('09-'10) • Ape TM P703-P703V Diesel 420cc ('87-'01) • Ape TM Diesel LCS 420cc ('05-'10) • Ape MP 601 Classic 420cc ('06-'07)  
R.O. 154991



ACCESSORI GANASCE FRENO - BRAKE SHOES ACCESSORIES

121950080



Molla ganascia freno Confezione 10 pz. | *Brake shoes clip 10pcs packaging*  
Ape 50 ('80-'99)  
R.O. 000061



ACCESSORI TAMBURI FRENO - BRAKE DRUMS ACCESSORIES

225084010



TAPPO IN ACCIAIO PER TAMBURO ANTERIORE | *INOX REAR DRUM PLUG*  
Diametro Ø 32 mm | *Diameter Ø 32 mm*  
Confezione 5 pz. | *5 Pcs Packing*  
Ape 50 ('80-'22)  
R.O. 126410, 181757



121870613



CAMMA FRENO | *BRAKE CAM*  
Diametro Ø 13 mm | *Diameter Ø 13 mm*  
Ape 50 ('80-'99)  
R.O. 131942, 2661574, 97590, 2/2140



**225140060**



Posteriore | *Rear*  
 Diametro cilindro Ø19 mm | *Cylinder Diameter*  
 Ø19 mm  
 Ape 50 1° serie  
 R.O. 117446



**225140070**



Posteriore | *Rear*  
 Diametro cilindro Ø19 mm | *Cylinder Diameter*  
 Ø19 mm  
 Ape 50 P ('80-'85) • Ape TM P 50 ('85-'89)  
 R.O. 1745292



**225140080**



Posteriore destro | *Rear right*  
 Diametro cilindro Ø25,4 mm | *Cylinder*  
*Diameter* Ø25,4 mm  
 Ape 175 • Ape MP  
 R.O. 076031



**225140090**



Posteriore sinistro | *Rear left*  
 Diametro cilindro Ø25,4 mm | *Cylinder*  
*Diameter* Ø25,4 mm  
 Ape 175 • Ape MP  
 R.O. 076032



**225140100**



Anteriore | *Front*  
 Diametro cilindro Ø22 mm | *Cylinder Diameter*  
 Ø22 mm  
 Ape Car P2-P3 220cc ('72-'86)  
 R.O. 137891





## CILINDRETTI FRENO - BRAKE CYLINDERS

**225140110**

Posteriore | *Rear*  
 Diametro cilindro Ø25,4 mm | *Cylinder*  
*Diameter Ø25,4 mm*  
 Ape Car P2-P3 220cc ('72-'86)  
 R.O. 137894

**225140120**

Anteriore | *Front*  
 Diametro cilindro Ø22 mm | *Cylinder Diameter*  
*Ø22 mm*  
 Ape TM P602 220cc ('82-'83) • Ape TM P703V-  
 FL2 220cc ('84-'05) • Ape TM P703 Diesel  
 420cc ('87-'04) • Ape Car - Max Diesel ('86-'96)  
 R.O. 245194

**225140130**

Posteriore | *Rear*  
 Diametro cilindro Ø25,4 mm | *Cylinder*  
*Diameter Ø25,4 mm*  
 Ape TM P602 220cc ('82-'83) • Ape TM P703V-  
 FL2 220cc ('84-'05) • Ape TM P703 Diesel  
 420cc ('87-'04) • Ape Car - Max Diesel ('86-'96)  
 R.O. 245193

**225140140**

Posteriore | *Rear*  
 Diametro cilindro Ø19 mm | *Cylinder Diameter*  
*Ø19 mm*  
 Ape 50 ('89-'08) • Ape Poker 420cc Diesel/  
 Benzina ('93-'97)  
 R.O. 227549



## CILINDRETTI FRENO - BRAKE CYLINDERS

225140150



Posteriore | Rear

Diametro cilindro Ø19 mm | Cylinder Diameter  
Ø19 mm

Ape 50 FL-FL2 ('89-'95) • Ape FL3 Europa ('96-'99)  
• Ape RST Mix ('99-'05) • Ape 50 ('09-'17)

R.O. 2457652



## CILINDRETTI FRENO - BRAKE CYLINDERS

### SERIE GUARNIZIONI CILINDRETTI FRENO - BRAKE CYLINDERS GASKET SETS

225140010



Per cilindretto freno anteriore 4 Pezzi | For front  
brake cylinder 4 Pcs

Ape MP • Ape Car



225140020



Per cilindretto freno anteriore 4 Pezzi | For front  
brake cylinder 4 Pcs

Ape TM P602 • Ape TM P703



225140030



Per cilindretto freno posteriore 8 Pezzi | For  
rear brake cylinder 8 Pcs

Ape 50



CILINDRETTI FRENO - BRAKE CYLINDERS

225140040



Per cilindretto freno posteriore 8 Pezzi | For rear brake cylinder 8 Pcs

Ape MP • Ape MPR • Ape MPV • Ape 175



225140050



Per cilindretto freno posteriore 8 Pezzi | For rear brake cylinder 8 Pcs

Ape TM P602 • Ape TM P703



POMPE FRENO - BRAKE MASTER CYLINDERS

225130040



Ape 50 FL-FL2 ('89-'95) • Ape FL3 Europa ('96-'99) • Ape RST Mix ('99-'05) • Ape 50 ('09-'17)  
R.O. 249519



225130060



Ape MP 500-550-600 200cc • Ape MP501-601 220cc ('78-'96)  
R.O. 1402516



225130080



Ape Car P2-P3 220cc ('78-'85)  
R.O. 1800365



## POMPE FRENO - BRAKE MASTER CYLINDERS

**225130090**



Ape TM P703 220cc ('84-'07) • Ape TM 220cc ('09-'16) • Ape Max Diesel 420 ('86-'96) • Ape TM Diesel LCS 420c ('05-'12) • Ape TM P703 Diesel ('87-'04)  
R.O. 249520



**225130100**



Ape Car Diesel 420cc ('86-'96)  
R.O. 179379



**225130110**



Ape Poker Benzina/Diesel 420cc ('91-'97)  
R.O. 2651955



**225130130**



Ape TM P602 220cc ('82-'83)  
R.O. 197433



**225130140**



Ape Car P2-P3 220cc ('78-'85)  
R.O. 229217



POMPE FRENO - BRAKE MASTER CYLINDERS

SERIE GUARNIZIONI POMPE FRENO - BRAKE MASTER CYLINDERS GASKET SETS

225130010



4 Pezzi | 4 Pcs  
Ape 50



225130020



Con rondella esagonale 4 Pezzi | *With exagonal washer 4 Pcs*  
Ape 175 • Ape Mp



225130030



3 Pezzi | 3 Pcs  
Ape TM P602-TM P703 220cc





# IMPIANTO ELETTRICO

ELECTRICAL SYSTEM

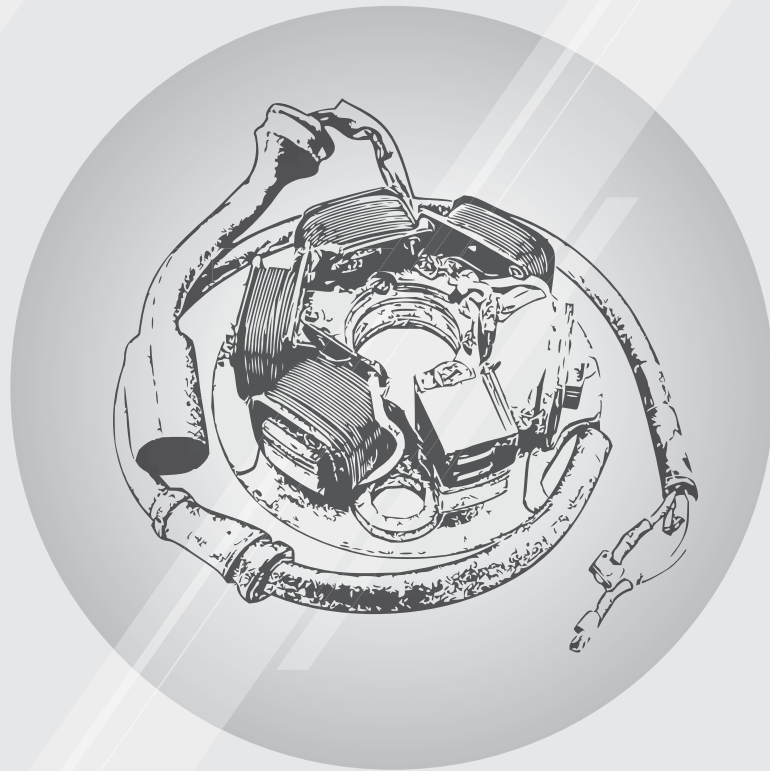

## CANDELETTE - GLOWPLUG

**246210440**



CANDELETTA DIESEL Codice Champion CH260  
 | DIESEL GLOWPLUG Champion product number  
 CH260

Ape TM 420cc ('05-'12) • Ape Calessino 420cc  
 ('07-'12) • Ape MP601 Classic 420cc ('06-'13) •  
 Ape Car-Max 420cc ('86-'96) • Ape Poker 420cc  
 ('93-'97) • Ape TM P703-P703V 420cc ('87-'04)  
 R.O. 438036



## ACCESSORI CANDELE - SPARK PLUGS ACCESSORIES

**246330140**



CAPPUCCIO CANDELA Codice Champion  
 PRO-OU | SPARK PLUG CAP Codice Champion  
 PRO-OU

Piega 90° | 90° spark plug cap  
 Innesto terminale SAE | SAE connector



**246330150**



CAPPUCCIO CANDELA Codice Champion  
 PRO-5M | SPARK PLUG CAP Codice Champion  
 PRO-5M

Piega 90° | 90° spark plug cap  
 Schermata | With resistor  
 Innesto terminale 1 | Connector type 1



**246330160**



CAPPUCCIO CANDELA Codice Champion  
 PRO-5U | SPARK PLUG CAP Codice Champion  
 PRO-5U

Piega 90° | 90° spark plug cap  
 Schermata | With resistor  
 Innesto terminale SAE | SAE connector





## ACCESSORI CANDELE - SPARK PLUGS ACCESSORIES

**121858472**

CAPOCORDA CANDELA | SPARK PLUG CLAMP

Confezione 10 pz. | 10 pcs pack

Applicazioni varie Ape | Various applications

Ape

(R.O. 127966)

**246490010**

CAVO CANDELA | SPARK PLUG CABLE

Rotolo da 10 mt, Ø 7mm | Packing 10/mtrs roll,  
Ø 7mm

Colore Nero | Colour Black

Applicazioni varie Ape | Various applications

Ape

**246490011**

NEW



CAVO CANDELA | SPARK PLUG CABLE

Rotolo da 10 mt, Ø 7mm | Packing 10/mtrs roll,  
Ø 7mm

Colore Blu | Colour Blue

Applicazioni varie Ape | Various applications

Ape

**246490012**

NEW



CAVO CANDELA | SPARK PLUG CABLE

Rotolo da 10 mt, Ø 7mm | Packing 10/mtrs roll,  
Ø 7mm

Colore Rosso | Colour Red

Applicazioni varie Ape | Various applications

Ape



## FANALI COMPLETI - COMPLETE LIGHTS

### FANALI POSTERIORI - REAR LIGHTS

**246420220**



Sinistro | *Left*

Completo, con lampeggiatore e luce del freno |  
*Complete, with indicator and brake light*

Senza lampadine | *Without bulbs*

Con marchio di omologazione E | *With E-mark*

Ape 50 FL-FL2 • Ape 50 FL3 Europa • Ape

Cross

R.O. 261468



**246420230**



Destro | *Right*

Completo, con lampeggiatore e luce del freno |  
*Complete, with indicator and brake light*

Senza lampadine | *Without bulbs*

Con marchio di omologazione E | *With E-mark*

Ape 50 FL-FL2 • Ape 50 FL3 Europa • Ape

Cross

R.O. 261467



**246420250**



Destro | *Right*

Completo, con lampeggiatore e luce del freno |  
*Complete, with indicator and brake light*

Con marchio di omologazione IGM sul vetro |  
*With IGM-mark on the glass*

Ape P 50 • Ape 50 TM P • Ape Car P2-P3 420cc

• Ape MP 500-600 200 • Ape MPV 600 • Ape

MP P501-P601

R.O. 155538



## FANALI COMPLETI - COMPLETE LIGHTS

246420260



Sinistro | Left

Completo, con lampeggiatore e luce del freno |  
Complete, with indicator and brake lightCon marchio di omologazione IGM sul vetro |  
With IGM-mark on the glassApe P 50 • Ape 50 TM P • Ape Car P2-P3 420cc  
• Ape MP 500-600 200 • Ape MPV 600 • Ape  
MP P501-P601  
R.O. 155632

## FRECCHE - BLINKERS

246480498

FRECCIA ANTERIORE SINISTRA (Lente  
arancione) | FRONT INDICATOR LEFT (Orange  
lens)Ape 50 TM P • Ape 50 FL2  
R.O. 233793

246480499

FRECCIA ANTERIORE DESTRA (Lente arancione)  
| FRONT INDICATOR RIGHT (Orange lens)Ape 50 TM P • Ape 50 FL2  
R.O. 233794

## FRECCE - BLINKERS

246480500



FRECCIA ANTERIORE DESTRA (Lente arancione/  
Lente Bianca) | *FRONT INDICATOR RIGHT*  
(Orange lens/White lens)

Ape MP P501-601 220cc ('78-'96)  
R.O. 163090



246480501



FRECCIA ANTERIORE SINISTRA (Lente  
arancione/Lente Bianca) | *FRONT INDICATOR*  
*LEFT* (Orange lens/White lens)

Ape MP P501-601 220cc ('78-'96)  
R.O. 163089



## LENTI FRECCIA - BLINKERS LENSES

246470526



ARANCIO



ANTERIORE DESTRA | *FRONT RIGHT*

Ape 50 TM P • Ape 50 FL2  
R.O. 196338



246470536



ARANCIO



ANTERIORE SINISTRA | *FRONT LEFT*

Ape 50 TM P • Ape 50 FL2  
R.O. 215059



## LENTI FRECCIA - BLINKERS LENSES

**246470546**

ANTERIORE DESTRA (Arancione/Bianco) |  
 FRONT RIGHT (Orange/White)

Ape Car P2-P3 220cc • Ape MP P501-601 220cc  
 R.O. 180004

**246470556**

ANTERIORE SINISTRA (Arancione/Bianco) |  
 FRONT LEFT (Orange/White)

Ape Car P2-P3 220cc • Ape MP P501-601 220cc  
 R.O. 180021

**246470595**

ANTERIORE SINISTRA | FRONT LEFT  
 Con omologazione E-mark | With E-mark  
 Ape 50 ('96-'22)  
 R.O. 294145

**246470605**

ANTERIORE DESTRA | FRONT RIGHT  
 Con omologazione E-mark | With E-mark  
 Ape 50 ('96-'22)  
 R.O. 294146



## LENTI FRECCIA - BLINKERS LENSES

246470655



ARANCIO

ANTERIORE SINISTRA | *FRONT LEFT*

Con omologazione E-mark | *With E-mark*

Ape TM P 602 220cc • Ape TM P 703 220cc

Ape TM Diesel 420cc • Ape TM P 703 420cc

R.O. 213716



246470665



ARANCIO

ANTERIORE DESTRA | *FRONT RIGHT*

Con omologazione E-mark | *With E-mark*

Ape TM P 602 220cc • Ape TM P 703 220cc

Ape TM Diesel 420cc • Ape TM P 703 420cc

R.O. 213717



## LENTI FANALI - COMPLETE LIGHTS LENSES

246470586



LENTE FANALE POSTERIORE | *REAR LENS*

Ape 50 ('89-'22) • Ape Car-Max Benzina/Diesel  
420cc

R.O. 256194



## PULSANTI - BUTTONS

246110500



INTERUTTORE TERGICRISTALLO | *WINDSCREEN  
WIPER SWITCH*

Ape 50 (89-'17)

R.O. 584097



## PULSANTI - BUTTONS

**246130010**PULSANTE CLACSON | *HORN BUTTON*

Ape FL-FL2 ('89-'95) • Ape FL3 Europa ('96-'99)  
 • Ape Mix 2T ('98-'08) • Ape RST Mix ('99-'03) •  
 Ape 50 ('09-'17)  
 R.O. 292364 - 290679

**246130020**PULSANTE CLACSON | *HORN BUTTON*

Ape FL-FL2 ('89-'95) • Ape FL3 Europa ('96-'99)  
 • Ape Mix 2T ('98-'08) • Ape RST Mix ('99-'03) •  
 Ape 50 ('09-'17)  
 R.O. 292364 - 290679

**246135050**PULSANTE AVVIAMENTO | *START BUTTON*

Ape FL-FL2 ('89-'95) • Ape FL3 Europa ('96-'99)  
 • Ape Mix 2T ('98-'08) • Ape RST Mix ('99-'03) •  
 Ape 50 ('09-'17)  
 R.O. 294398

DEVIO LUCI - *LIGHTS SWITCHES***246090280**

Ape FL-FL2 ('89-'95) • Ape FL3 Europa ('96-'99)  
 • Ape Mix 2T ('98-'08) • Ape RST Mix ('99-'03) •  
 Ape 50 ('09-'17)  
 R.O. 294370



## DEVIO LUCI - LIGHTS SWITCHES

246090320



Ape 175-350-400 • Ape MP 500-600  
R.O. 057663



246090330



Ape MP P501-P601 220cc ('78-'96) • Ape  
Classic 400cc E4 ('14-'21) • Ape Calessino 420cc  
( '07-'12) • Ape MP601 Classic 420cc ('06-'13)  
R.O. B073366 - 186454



246091010



GRUPPO DEVIO LUCI E CLACSON | HORN  
CONTROL GROUP  
Ape Poker Benzina/Diesel 420cc ('93-'97)  
R.O. 250229



246091020



GRUPPO DEVIO LUCI E CLACSON | HORN  
CONTROL GROUP  
Ape TM 703-P703V-FL2 220cc ('84-'05) • Ape  
TM P703-P703V Diesel 420cc ('87-'04)  
R.O. 261682





## DEVIO LUCI - LIGHTS SWITCHES

246091030

GRUPPO DEVIO LUCI E CLACSON | HORN  
CONTROL GROUPApe Car P2-P3 220cc ('79-'85) • Ape Car-Max  
Diesel 420cc ('86-'96)  
R.O. 261683

## AVVISATORI ACUSTICI - HORNS

246070100



12V C.C.

Diametro Ø 72 mm | Diameter Ø 72 mm

Colore Grigio | Colour Grey

Fissaggio 2 fori | Fixing 2 holes

Diametro fori Ø 4 mm | Holes diameter Ø 4 mm

Ape P 50('84>) • Ape TM 50 ('85>) • Ape 50 FL2  
( '90>)

Veicoli con batteria - Models with battery

R.O. 216904, 216903, 58144R, 264094



246070130



12V C.C.

Ape TM 703-P703V-FL2 220cc ('84-'05) • Ape

TM P703-P703V Diesel 420cc ('87-'04) • Ape

Car P2-P3 220cc ('79-'85) • Ape Car-Max Diesel

420cc ('86-'96)

R.O. 292695



## INTERRUTTORI - SWITCHES

246140730

INTERRUTTORE RETROMARCIA | REVERSE  
GEAR SWITCHApe TM 220cc (84-'05) • Ape TM P703 220cc  
( '09-'16)

R.O. 252166



## INTERRUTTORI - SWITCHES

**246140110**



INTERRUTTORE STOP | BRAKE LIGHT SWITCH

Ape TM 703-P703V-FL2 220cc ('84-'05) • Ape TM P703-P703V Diesel 420cc ('87-'04) • Ape Car P2-P3 220cc ('79-'85) • Ape Car-Max Diesel 420cc ('86-'96) • Ape Poker Diesel/Benzina ('93-'97)  
R.O. 181637



**246140170**



INTERRUTTORE STOP | BRAKE LIGHT SWITCH

Ape FL-FL2 ('89-'95) • Ape FL3 Europa ('96-'99) • Ape Mix 2T ('98-'08) • Ape RST Mix ('99-'03) • Ape 50 ('09-'17) • Ape Car 220cc ('78-'86) • Ape TM 220cc ('09-'16) • Ape TM P 220cc ('82-'07) • Ape Poker Benzina/Diesel 420cc ('93-'97) • Ape TM Diesel ('05-'12) • Ape TM P703 Diesel 420cc ('87-'04)  
R.O. B023289



**246140180**



INTERRUTTORE STOP | BRAKE LIGHT SWITCH

Ape Car 220cc ('72-'86) • Ape MP P501-601 220cc ('78-'96)  
R.O. 104412



## RELÈ - RELAYS

**246120010**



**246120011**



RELÈ FRECCHE | BLINKERS RELAYS

12V 21W

3 terminali | 3 pins

Ape P 50('80-'85) • Ape TM P50 ('85-'89)

R.O. 163968, 195703



## RELÈ - RELAYS

246120290



RELÈ FRECCE | BLINKERS RELAYS

Monocanale | Single channel

6V 21W

2 terminali | 2 pins

Ape 50

R.O. 154578



246400093



RELÈ AVVIAMENTO | STARTER RELAYS

12V 80A

4 terminali | 4 pins

Ape FL-FL2 ('89-'95) • Ape FL3 Europa ('96-'99)

• Ape Car-Max Diesel 420cc ('86-'96) • Ape

Poker Benzina/Diesel 420cc ('93-'97) • Ape TM

Diesel 420cc ('05-'12) • Ape TM P703 Diesel

420cc ('87-'04)

R.O. 218824



246400111



RELÈ AVVIAMENTO | STARTER RELAYS

12V 80A

4 terminali | 4 pins

Ape 50 ('98-'22) • Ape TM Diesel LCS ('05-'12)

R.O. 58115R



## SENSORI / TERMOSTATI - SENSORS / THERMOSTATS

100120380



PRESSOSTATO OLIO | OIL PRESSURE SENSOR

Ape Car-Max Diesel 420cc ('86-'96) • Ape Poker

Benzina/Diesel 420cc ('93-'97) • Ape TM Diesel

420cc ('05-'12) • Ape TM P703 Diesel 420cc

('87-'04)

R.O. 287887



## FUSIBILI - FUSES

246151001



Kit 10 fusibili lamellari standard assortiti | 10 Pcs  
fuses kit



246151031



Kit 200 fusibili lamellari standard | 200 Pcs  
standard fuses kit



## CENTRALINE - CDI

246010050



246010051



246010582



4 collegamenti | 4 pins

Ape FL-FL2 ('89-'95) • Ape FL3 Europa ('96-'99)  
• Ape Mix 2T ('98-'08) • Ape RST Mix ('99-'03) •  
Ape 50 ('09-'17)  
R.O. 2441285



246010062



246010063



3 collegamenti | 3 pins

Ape 50 TM P ('85-'89)  
R.O. 2441275



## CENTRALINE - CDI

**246010201**

Ape Car P2-P3 220cc • Ape MP P501-601 220cc  
 • Ape TM 220cc ('09-'16) • Ape TM P 220cc  
 ('82-'07)  
 R.O. 2441295



## REGOLATORI DI TENSIONE - REGULATORS

**246030020****246030022**

12V 20A  
 5 collegamenti | 5 pins  
 Ape 50 TM P ('85-'89)  
 R.O. 2308245

**246030040**

12V 34/36W  
 5 collegamenti | 5 pins  
 Ape FL-FL2 ('89-'95) • Ape FL3 Europa ('96-'99)  
 R.O. 2940165

**246030042**

Ape FL-FL2 ('89-'95) • Ape FL3 Europa ('96-'99)  
 R.O. 2940165



**246030260**



Ape Car-Max Diesel 420cc ('86-'96) • Ape TM Diesel 420cc ('05-'12) • Ape TM P703 Diesel 420cc ('87-'04)  
R.O. 2318775



**246030271**



Ape Car 220cc ('78-'86) • Ape TM 220cc ('09-'16) • Ape MP P 501-601 220cc • Ape TM P 220cc ('82-'07)  
R.O. 157714



**246030272** **NEW**



Ape TM 703  
R.O.157714



**246030321**



Ape FL3 Europa ('96-'99) • Ape Mix 2T ('98-'08) • Ape RST Mix ('99-'03) • Ape 50 ('09-'17)  
R.O. 2180605



## MOTORINI D'AVVIAMENTO - STARTER MOTORS

**246390071**

Ape FL-FL2 ('89-'95) • Ape FL3 Europa ('96-'99)  
 • Ape Mix 2T ('98-'08) • Ape RST Mix ('99-'03) •  
 Ape 50 ('09-'17)  
 R.O. 1791665

**246390261**

Ape TM P703V-FL2 220('84-'05) • Ape TM  
 P703-P703V Diesel 420 ('87-'04) • Ape TM D  
 LCS 420 ('05-'07)  
 R.O. 249235



## ANELLI PORTASPAZZOLE - BRUSH HOLDERS

**246350030**

ANELLO PORTASPAZZOLE | BRUSH HOLDER  
 Ape FL-FL2 ('89-'95) • Ape FL3 Europa ('96-'99)  
 • Ape Mix 2T ('98-'08) • Ape RST Mix ('99-'03)  
 R.O. 179555, 291383

**246390440**

SPAZZOLE | BRUSH  
 Ape Car 220cc ('78-'86) • Ape TM 220cc  
 ('09-'16) • Ape MP P 501-601 220cc • Ape TM P  
 220cc ('82-'07)  
 R.O. 159922



## STATORI - STATORS

**246350011**



**246350013**



5 POLI | 5 POLES

3 Fili Fastom - Connettore a 5 attacchi | 3

*Fastom wires - 5 Pins connector*

Ape FL-FL2 ('89-'95) • Ape FL3 Europa ('96-'99)

• Ape Mix 2T ('98-'08) • Ape RST Mix ('99-'03) •

Ape 50 ('09-'17)

R.O. 199500, 497651



**246350063**



6 POLI | 6 POLES

3 Fili Fastom - Connettore a 3 attacchi | 3

*Fastom wires - 3 Pins connector*

Ape 50 TM P ('85-'89)

R.O. 199495



**246350473**



5 POLI | 5 POLES

3 Fili | 3 Wires

Ape FL3 Europa ('96-'99) • Ape Mix 2T ('98-'08)

• Ape RST Mix ('99-'03) • Ape 50 ('09-'17)

R.O. 256309





## ROTORI - ROTORS

**246350312**Ape 50 ('09-'22)  
R.O. 642204

## VOLANI COMPLETI - COMPLETE FLYWHEEL

**246351000**Ape Car 220cc ('78-'86) • Ape TM 220cc ('09-'16) • Ape MP P 501-601 220cc • Ape TM P 220cc ('82-'07)  
R.O. 157715

## ACCESSORI VOLANI, ROTORI E STATORI - FLYWHEEL, ROTORS AND STATORS ACCESSORIES

**121858440**CHIAVETTA VOLANO | FLYWHEEL KEY  
Dimensioni 15,3x6,45x4 mm | Dimensions  
15,3x6,45x4 mm  
Confezione 50 pz. | 50 Pcs Packing  
Ape Car 220cc ('78-'86) • Ape TM 220cc ('09-'16) • Ape MP P 501-601 220cc • Ape TM P 220cc ('82-'07)  
R.O. 000097

## PICK UP - PICK UP

**246170023**Ape FL-FL2 ('89-'95) • Ape FL3 Europa ('96-'99) • Ape Mix 2T ('98-'08) • Ape RST Mix ('99-'03) • Ape 50 ('09-'17)  
R.O. 196549

## QUADRI CHIAVE - KEY SETS MAIN SWITCHES

246050730



Ape Car 220cc ('78-'86) • Ape TM 220cc ('09-'16) • Ape MP P 501-601 220cc • Ape TM P 220cc ('82-'07) • Ape Car-Max Diesel 420cc ('86-'96) • Ape TM Diesel 420cc ('05-'12) • Ape TM P703 Diesel 420cc ('87-'04)  
R.O. 140732



## COMMUTATORI ACCENSIONE - IGNITION SWITCHES

246050670



Ape FL-FL2 ('89-'95) • Ape FL3 Europa ('96-'99) • Ape Mix 2T ('98-'08) • Ape RST Mix ('99-'03) • Ape 50 ('09-'17)  
R.O. 291582



## ACCESSORI CABLAGGI - WIRINGS ACCESSORIES

246490200



GUAINA CABLAGGIO - GRIGIO | *ELECTRIC SHEATH - GREY*



246490201



GUAINA CABLAGGIO - VERDE | *ELECTRIC SHEATH - GREEN*  
Lunghezza 3210 mm | *Length 3210 mm*



## ACCESSORI CABLAGGI - WIRINGS ACCESSORIES

267005000



KIT GUAINA TERMORETRAIBILE IMPERMEABILE  
| WATERPROOF HEAT SHRINKABLE TUBE SET  
Confezione 106 pz. | 106 Pcs Packing



## CONDENSATORI - CONDENSERS

246190020



Dimensioni Ø20x32 mm | Dimensions Ø20x32 mm

Con piastra di fissaggio | With mounting plate  
1 cavo mF 0,32 (giallo) | 1 cable, mF 0,32 (yellow)

Ape 50 • Ape 250  
R.O. 79697



246190040



Con piastra di fissaggio | With mounting plate  
Ape MP 550-600 • Ape MPV 550-600  
R.O. 123828



## CONNETTORI - ELECTRICAL CONNECTORS

246330310



CONNETTORI PREISOLATI (7 Tipi) | PLASTIC COATED CONNECTORS (7 Types)  
Confezione 35 pz. | 35 Pcs Packing



## CONTATTI - PLATINERS

246150030



Ape P 50 ('80-'85) • Ape 250 ('70-'74)  
R.O. 141838



## CONTATTI - PLATINERS

246150040



Ape MP 550-600 • Ape MPV 550-600 • Ape MP  
P 501-601 220cc  
R.O. 118540



## PRESE DI CORRENTE - SOCKETS

121830620



CAPPUCCIO PRESA CORRENTE | RUBBER  
SOCKET

Ape 50  
R.O. 161125



# BATTERIE

BATTERIES

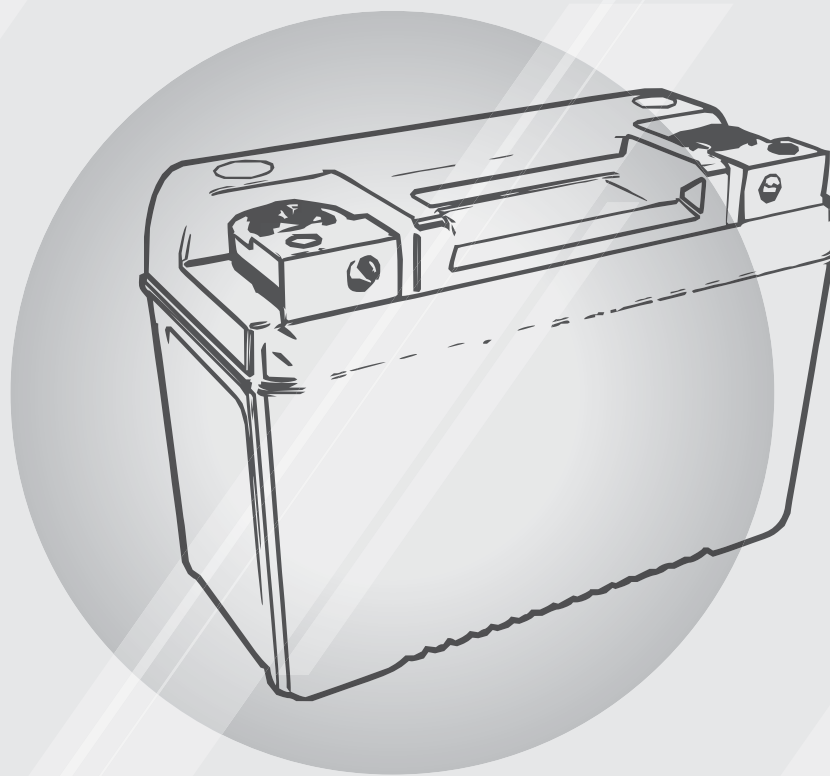

246650195 **NEW**



plug  
play

BATTERIA SLA BB9-B | BATTERY SLA BB9-B

Voltaggio 12 v | Voltage 12 v

CCA 120 A | CCA 120 A

Capacità 9 Ah | Capacity 9 Ah

Dimensioni 135x75x139 mm | Dimensions

135x75x139 mm

Peso 3,10 kg | Weight 3,10 kg

Ape 50



246700010 **NEW**



Caricabatteria BS10 6V/12V | Battery Charger

BS10 6V/12V





The Power you need...



**PLUG AND PLAY SOLUTION**





# TRASMISSIONE

TRANSMISSION



**100221040**



CROCERA INNESTO 1a-2a MARCIA | *1st-2nd GEAR SELECTOR*

Ape Car-Max Diesel 420cc ('86-'96) • Ape Poker Benzina/Diesel 420cc ('93-'97) • Ape TM Diesel 420cc ('05-'12) • Ape TM P703 Diesel 420cc ('87-'04)

R.O. 1681046



**100221050**



CROCERA INNESTO 3a-4a MARCIA | *3rd-4th GEAR SELECTOR*

Ape Car-Max Diesel 420cc ('86-'96) • Ape Poker Benzina/Diesel 420cc ('93-'97) • Ape TM Diesel 420cc ('05-'12) • Ape TM P703 Diesel 420cc ('87-'04)

R.O. 1681056



**100240060**



INGRANAGGIO INVERTITORE | *INVERTER GEAR*

Numero denti: 20/12 | *Teeth number: 20/12*

Ø Albero 20/22 mm | *Ø Shaft 20/22 mm*

Ape Car P2-P3 220cc • Ape MP P501-601 220cc • Ape TM 220cc ('09-'16) • Ape TM P 220cc ('82-'07)

R.O. 169744



**100240080**



INGRANAGGIO SCORREVOLE | *SLIDING GEAR*

Numero denti: 21 | *Teeth number: 21*

Ape Car P2-P3 220cc • Ape MP P501-601 220cc

• Ape TM 220cc ('09-'16) • Ape TM P 220cc ('82-'07)

R.O. 118909

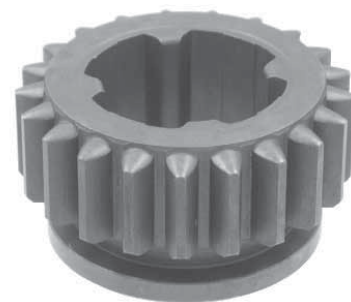



## ACCESSORI TRASMISSIONE - TRANSMISSION ACCESSORIES

100300531 **NEW**

RACCOGLITORE OLIO | OIL CANS

Ape FL-FL2 ('89-'95) • Ape FL3 Europa ('96-'99)  
 • Ape Mix 2T ('98-'08) • Ape RST Mix ('99-'03) •  
 Ape 50 ('09-'17)  
 R.O. 286018

100300532 **NEW**ANELLO ELASTICO CHIUSURA FRIZIONE |  
CLUTCH GROUP CLOSING ELASTIC RING

Ape FL-FL2 ('89-'95) • Ape FL3 Europa ('96-'99)  
 • Ape Mix 2T ('98-'08) • Ape RST Mix ('99-'03) •  
 Ape 50 ('09-'17)  
 R.O. 286019



121830160



121830163



GIUNTO ELASTICO | ELASTIC COUPLING

Ape Car P2-P3 220cc • Ape MP P501-601 220cc  
 • Ape TM 220cc ('09-'16) • Ape TM P 220cc  
 ('82-'07) • Ape TM Diesel 420cc ('05-'12) • Ape  
 TM P703 Diesel 420cc ('87-'04)  
 R.O. 228302



121830170



GIUNTO ELASTICO | ELASTIC COUPLING

Fori fissaggio Ø10 mm | Fixing holes Ø10 mm  
 Ape Poker Benzina/Diesel 420cc ('93-'97)  
 R.O. 226345



121830180



CUFFIA TENUTA OLIO SEMIASSE | *DRIVESHAFT PROTECTION*

Ape FL-FL2 ('89-'95) • Ape FL3 Europa ('96-'99)  
 • Ape Mix 2T ('98-'08) • Ape RST Mix ('99-'03) •  
 Ape 50 ('09-'17) • Ape 250 ('70-'74)  
 R.O.119989



121830190



CUFFIA TENUTA OLIO SEMIASSE | *DRIVESHAFT PROTECTION*

Ape Calessino 200cc ('13-'19) • Ape Car P2-P3  
 220cc • Ape MP P501-601 220cc • Ape TM  
 220cc ('09-'16) • Ape TM P 220cc ('82-'07)  
 R.O.198618



121830250



GIUNTO ELASTICO | *ELASTIC COUPLING*

Fori fissaggio Ø12 mm | *Fixing holes Ø12 mm*

Ape Car-Max Diesel 420cc ('86-'96) • Ape Poker  
 Benzina/Diesel 420cc ('93-'97)  
 R.O. 268253



121859170

NEW



KIT DADI E RONDELLE FRIZIONE/COPPIA  
 PRIMARIA | *KIT NUTS AND CLUTCH WASHERS/  
 PRIMARY TORQUE*

Confezione 20 pz. | *20 Pcs Packing*

Ape FL-FL2 ('89-'95) • Ape FL3 Europa ('96-'99)  
 • Ape Mix 2T ('98-'08) • Ape RST Mix ('99-'03) •  
 Ape 50 ('09-'22)



## ACCESSORI TRASMISSIONE - TRANSMISSION ACCESSORIES

**121859171****NEW**

RONDELLA BLOCCA DADO FRIZIONE | *LOCKING WASHER CLUTCH*

Confezione 20 pz. | *20 Pcs Packing*

Ape FL-FL2 ('89-'95) • Ape FL3 Europa ('96-'99)

• Ape Mix 2T ('98-'08) • Ape RST Mix ('99-'03) •

Ape 50 ('09-'22)

R.O. 244297

**121859172****NEW**

RONDELLA BLOCCA DADO PIGNONE CP.  
PRIMARIA | *LOCKING WASHER PRIMARY GEAR*

Confezione 20 pz. | *20 Pcs Packing*

Ape FL-FL2 ('89-'95) • Ape FL3 Europa ('96-'99)

• Ape Mix 2T ('98-'08) • Ape RST Mix ('99-'03) •

Ape 50 ('09-'22)

R.O. 001821

**121860320****NEW**

DADO FRIZIONE | *CLUTCH NUT*

Ape FL-FL2 ('89-'95) • Ape FL3 Europa ('96-'99)

• Ape Mix 2T ('98-'08) • Ape RST Mix ('99-'03) •

Ape 50 ('09-'22)

R.O. 001821

**121860330****NEW**

DADO PIGNONE | *PRIMARY GEAR NUT*

Ape FL-FL2 ('89-'95) • Ape FL3 Europa ('96-'99)

• Ape Mix 2T ('98-'08) • Ape RST Mix ('99-'03) •

Ape 50 ('09-'22)

R.O. 001821





# CARROZZERIA

BODY WORK

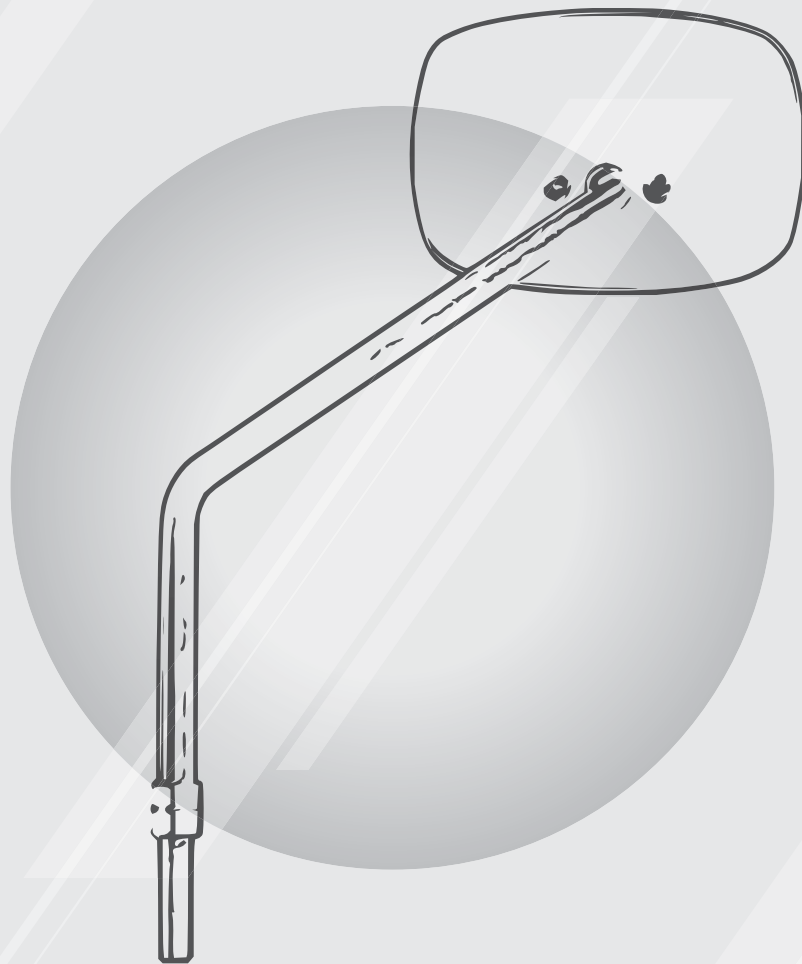

## SPECCHIETTI RETROVISORI - REAR VIEW MIRRORS

### SPECCHIETTI LATO SINISTRO - LEFT REAR MIRRORS

122760010



Passo Asta Ø 8 mm - Vetro convesso | *Thread Shaft Ø 8 mm - Convex glass*

Ape 50 P ('80-'85) • Ape 50 TM P ('85-'89) •

Ape 50 FL-FL2 ('89-'95) • Ape MP P501-P601

220cc ('78-'96)

R.O.182213



122760710



Passo 8 x 1,25 | *Thread 8 x 1,25*

Ape F13 Europa • Ape Mix 2T • Ape Rst Mix •

Ape TM P703 F12 220cc

R.O. 565061



122763000



Passo M10 | *Thread M10*

Ape Calessino

R.O. 1E000267



SPECCHIETTI RETROVISORI - REAR VIEW MIRRORS

122763010



Passo M8 | Thread M8

Ape TM P602 • Ape TM P703-P703V, FL2 • Ape  
TM P703 FL2 • Ape TM P703-P703V Diesel  
R.O. 216896



SPECCHIETTI LATO DESTRO - RIGHT REAR MIRRORS

122770710



Passo 8 x 1,25 | Thread 8 x 1,25

Ape FI3 Europa • Ape Mix 2T • Ape Rst Mix  
R.O. 565062



122773000



Passo M10 | Thread M10

Ape Calessino  
R.O. 1E000268



## SPECCHIETTI RETROVISORI - REAR VIEW MIRRORS

122773010



Passo M8 | Thread M8

Ape TM P602 • Ape TM P703-P703V, FL2 • Ape  
TM P703 FL2 • Ape TM P703-P703V Diesel  
R.O. 216897



## PORTATARGA - PLATE HOLDERS

142700010



PORTATARGA EUROPEO | PLATE HOLDER  
In nylon antiurto predisposto per il montaggio  
su tutte le moto e scooter | Nylon material,  
suitable for all motorcycle and scooter models

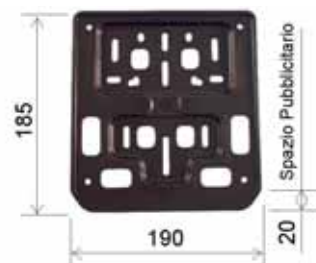

142700040



PORTATARGA EUROPEO | PLATE HOLDER  
Per Ciclomotori e Scooter 50 cc | 50 cc  
applications



142700070 **NEW**



PORTATARGA EUROPEO | PLATE HOLDER  
Per Ciclomotori e Scooter 50 cc | 50 cc  
applications  
Dimensioni 150x130mm | Dimensions  
150x130mm  
Colore Cromato | Colour Chromed





PORTATARGA - PLATE HOLDERS

142700390



PORTATARGA VINTAGE | VINTAGE PLATE  
HOLDER

Dimensioni 170x170 mm | Dimensions 170x170  
mm

Colore Cromato | Colour Chromed

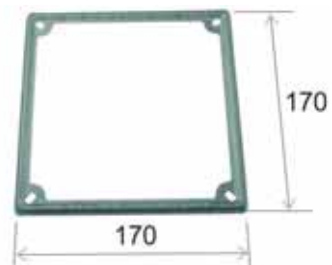

142700400



PORTATARGA VINTAGE | VINTAGE PLATE  
HOLDER

Dimensioni 170x170 mm | Dimensions 170x170  
mm

Colore Nero | Colour Black

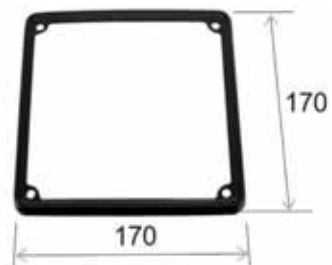

PLASTICHE CARROZZERIA - CHASSIS PLASTICS

142740130



MANIGLIA IN PLASTICA PER PORTA LATERALE |  
HANDLE LATERAL DOOR

Confezione 10 Pz. | 10 Pcs Packing

Ape FL-FL2 ('89-'95) • Ape FL3 Europa ('96-'99)  
• Ape Mix 2T ('98-'08) • Ape RST Mix ('99-'03) •  
Ape 50 ('09-'22)

R.O. 255813



142620060

NEW



Coppia pannelli | Pair of panels

Ape MP 601



## SPAZZOLE TERGICRISTALLO - WIPER BLADES

267200610



SPAZZOLA TERGICRISTALLO | WINDSHIELD  
WIPER

Lunghezza 380 mm | Length 380 mm

Confezione 6 Pz. | 6 Pcs Packing

Ape FL-FL2 ('89-'95) • Ape FL3 Europa ('96-'99)  
• Ape Mix 2T ('98-'08) • Ape RST Mix ('99-'03) •  
Ape P 50 ('80-'85) • Ape 50 ('09-'22) • Ape Car  
P2-P3 220cc • Ape MP P501-601 220cc • Ape  
TM 220cc ('09-'16) • Ape TM P 220cc ('82-'07) •  
Ape Car-Max Diesel 420cc ('86-'96) • Ape Poker  
Benzina/Diesel 420cc ('93-'97) • Ape TM Diesel  
420cc ('05-'12) • Ape TM P703 Diesel 420cc  
( '87-'04)

R.O. 438013



## ACCESSORI CARROZZERIA - BODYPARTS ACCESSORIES

121856101



VITE TESTA CON INSERTO A CROCE PER  
CARROZZERIA | BODYWORK SCREW

Confezione 10 pz. | 10 Pcs Packing

Ape FL-FL2 ('89-'95) • Ape FL3 Europa ('96-'99)  
• Ape Mix 2T ('98-'08) • Ape RST Mix ('99-'03) •  
Ape 50 ('09-'22)

R.O. 298086, 575249

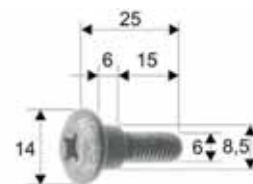

142740140



CINGHIA FERMA PORTIERA | SAFETY BELT FOR  
DOOR

Ape FL-FL2 ('89-'95) • Ape FL3 Europa ('96-'99)  
• Ape Mix 2T ('98-'08) • Ape RST Mix ('99-'03) •  
Ape P 50 ('80-'85) • Ape 50 ('09-'22) • Ape Car  
P2-P3 220cc • Ape MP P501-601 220cc

R.O. 175074



TAPPETINI IN GOMMA - FLOOR MATS

142670160 **NEW**



Ape MP 500-550-600-601 • Ape MP 601  
Francia



142670170 **NEW**



Ape TM P602 • Ape TM P703 • Ape TM P703V •  
Ape TM P703 Manubrio • Ape TM P703 Volante  
• Ape TM P703/P703V FL • Ape TM P703 D LCS  
• Ape TM (2009)



142670190 **NEW**



2 pezzi | 2 pieces  
Ape TM 50-125 • Ape TM P50 • Ape TM P50  
Elestart • Ape TM 50 Francia & Austria





# TELAIO

CHASSIS

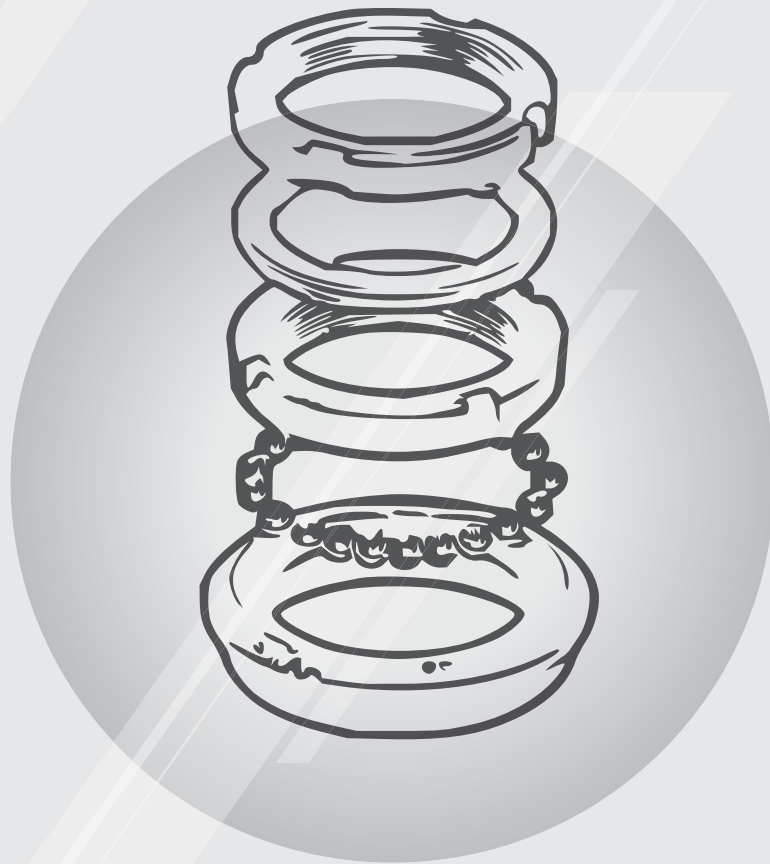

## LEVE - LEVERS

### LEVE FRENO - BRAKE LEVERS

184121070



Ape P ('80-'85) • Ape TM P ('85-'89)  
R.O. 177340



121950010



Molla ritorno leva | *Return spring lever*  
Confezione 5 pz. | *5 Pcs Packing*  
Incluso piastre, bullone e coppiglia | *With plates, nut and split pin*

Vespa PK • Cosa  
R.O. 177072



## COMANDI GAS - THROTTLES HANDLES

184080080



Ape 50 • Ape Mix 2T • Ape Rst Mix • Ape Web  
R.O. 566485



## ACCESSORI COMANDI - CONTROLS ACCESSORIES

121860390



SDOPPIATORE UNIVERSALE Ø 6,25 mm |  
*UNIVERSAL SPLITTER Ø 6,25 mm*



121860400



SDOPPIATORE UNIVERSALE Ø 6,8 mm |  
*UNIVERSAL SPLITTER Ø 6,8 mm*



121860410



SDOPPIATORE UNIVERSALE Ø 6,8 mm |  
*UNIVERSAL SPLITTER Ø 6,8 mm*



MANOPOLE E ACCESSORI - GRIPS AND ACCESSORIES

184160040



Nero | Black

Ape P ('80-'85) • Ape TM P ('85-'89)

R.O. 185256



Estremità chiusa  
Closed end

184160050



Nero | Black

Ape TM P ('85-'89)

R.O. 233072, 233075

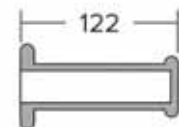

Estremità chiusa  
Closed end

SERIE STERZO - STEERING HEAD BEARING SET

184220030



SUPERIORE | UPPER

Ape FL-FL2 ('89-'95) • Ape FL3 Europa ('96-'99)

• Ape Mix 2T ('98-'08) • Ape RST Mix ('99-'03) •

Ape TM P ('85-'89)

R.O. 493616



184220041



INFERIORE | LOWER

Ape FL-FL2 ('89-'95) • Ape FL3 Europa ('96-'99)

• Ape Mix 2T ('98-'08) • Ape RST Mix ('99-'03) •

Ape TM P ('85-'89)

R.O. 493617



## SERIE STERZO - STEERING HEAD BEARING SET

**184220050**



SUPERIORE | *UPPER*

Ape Car P2-P3 220cc • Ape MP P501-601 220cc  
• Ape Car-Max Diesel 420cc ('86-'96)  
R.O. 153507



**184220080**



SUPERIORE | *UPPER*

Ape TM 220cc ('09-'16) • Ape TM P 220cc ('82-'07)  
• Ape TM Diesel 420cc ('05-'12) • Ape TM P703 Diesel 420cc ('87-'04)  
R.O. 493618



**184220090**



INFERIORE | *LOWER*

Ape TM 220cc ('09-'16) • Ape TM P 220cc ('82-'07)  
• Ape TM Diesel 420cc ('05-'12) • Ape TM P703 Diesel 420cc ('87-'04)  
R.O. 493619



## ACCESSORI SERIE STERZO - STEERING HEAD BEARING SET ACCESSORIES

### GROSSE SFERE - BALL SETS

**484120211**



1 Conf. Grosse sfere 5/32" (Tot. 144 Pz.) | 1 Grs ball set 5/32" (Tot. 144 Pcs)





## ACCESSORI SERIE STERZO - STEERING HEAD BEARING SET ACCESSORIES

**484120261**

1 Conf. Grosse sfere 11/32" (Tot. 144 Pz.) | 1 Grs  
ball set 11/32" (Tot. 144 Pcs)



## CAVI TRASMISSIONE APE - APE TRANSMISSION CABLES

## CAVI TRASMISSIONE GAS - THROTTLE TRANSMISSION CABLES

**163510041**

Dimensioni 1,2x3200 mm | *Dimensions*  
1,2x3200 mm

Confezione 10 Pz. | 10 Pcs Packing

Ape FL-FL2 ('89-'95) • Ape FL3 Europa ('96-'99)  
• Ape P50 ('80-'85) • Ape Tm P ('85-'89)  
R.O. 118307

**163510049**

Dimensioni 1,2x3200 mm | *Dimensions*  
1,2x3200 mm

Confezione 50 Pz. | 50 Pcs Packing

Ape FL-FL2 ('89-'95) • Ape FL3 Europa ('96-'99)  
• Ape P50 ('80-'85) • Ape Tm P ('85-'89)  
R.O. 118307

**163510051**

Dimensioni 1,2x3200 mm | *Dimensions*  
1,2x3200 mm

Confezione 10 Pz. | 10 Pcs Packing

Ape MP P501-601 220cc

**163510059**

Dimensioni 1,2x3200 mm | *Dimensions*  
1,2x3200 mm

Confezione 50 Pz. | 50 Pcs Packing

Ape MP P501-601 220cc



## CAVI TRASMISSIONE APE - APE TRANSMISSION CABLES

**163510060**



Confezione 10 Pz. | 10 Pcs Packing  
Ape MP P501-601 220cc



**163510070**



Confezione 10 Pz. | 10 Pcs Packing  
Ape TM P602 220cc



**163590630**



Con guaina e occhio | *With sleeve and eye*  
Grigio | *Grey*  
Acciaio, zincato | *Steel, galvanized*  
Ape TM P602 Versione manubrio ('82-'83) •  
Ape P703 ('84-'05) • Ape P703 V ('84-'05) • Ape  
P703 FL2 ('84-'05)  
R.O. 177128



## CAVI TRASMISSIONE FRIZIONE - CLUTCH TRANSMISSION CABLES

**163514061**



**163514069\***



Dimensioni 1,9x2800 mm | *Dimensions*  
*1,9x2800 mm*  
Confezione 10 Pz. | 10 Pcs Packing  
\* Confezione 50 pz | *Packaging 50 pcs*  
Ape FL-FL2 ('89-'95) • Ape FL3 Europa ('96-'99)  
• Ape Mix 2T ('98-'08) • Ape RST Mix ('99-'03) •  
Ape P 50 ('80-'85) • Ape Tm P ('85-'89)  
R.O. 118313



**163514090**



Dimensioni 2,5x3000 mm | *Dimensions*  
*2,5x3000 mm*  
Confezione 10 Pz. | 10 Pcs Packing  
Ape Car P2-P3 220cc  
R.O. 136507



## CAVI TRASMISSIONE APE - APE TRANSMISSION CABLES

**163514071****163514079\***

Dimensioni 1,9x3000 mm | *Dimensions*  
 1,9x3000 mm  
 Confezione 10 Pz. | *10 Pcs Packing*  
 \* Confezione 50 pz | *Packaging 50 pcs*  
 Ape TM P 220cc ('82-'83)

**163514101****163514109\***

Confezione 10 Pz. | *10 Pcs Packing*  
 \* Confezione 50 pz | *Packaging 50 pcs*  
 Ape TM P703 220cc ('84-'05) • Ape TM P703 V  
 220cc ('84-'05) • Ape TM P FL2 220cc ('84-'05)  
 • Ape TM P602 220cc ('82-'83)

**163570020**

Ape TM P703 220cc ('84-'05) • Ape TM P703 V  
 220cc ('84-'05) • Ape TM P FL2 220cc ('84-'05)  
 • Ape TM P602 220cc ('82-'83)  
 R.O. 177150

**163570040**

Con guaina e occhio | *With sleeve and eye*  
 Nero | *Black*  
 Acciaio, zincato | *Steel, galvanized*  
 Ape Poker Benzina/Diesel 420cc ('93-'97)  
 R.O. 266494

**163570060**

Con guaina e barilotto | *With sleeve and nipple*  
 Grigio | *Grey*  
 Ape TM Diesel 420cc ('05-'12) • Ape TM P703  
 Diesel 420cc ('87-'04)  
 R.O. 438013, 228715



## CAVI TRASMISSIONE APE - APE TRANSMISSION CABLES

### CAVI TRASMISSIONE CAMBIO - GEAR TRANSMISSION CABLES

**163516031**



**163516039\***



Dimensioni 1,6x3000 mm | *Dimensions*  
1,6x3000 mm

Confezione 10 Pz. | *10 Pcs Packing*

\* Confezione 50 pz | *Packaging 50 pcs*

Ape FL-FL2 ('89-'95) • Ape FL3 Europa ('96-'99)

• Ape P 50 ('80-'85) • Ape TM P ('85-'89)



**163516041**



**163516049\***



Dimensioni 1,6x3000 mm | *Dimensions*  
1,6x3000 mm

Confezione 10 Pz. | *10 Pcs Packing*

\* Confezione 50 pz | *Packaging 50 pcs*

Acciaio, zincato | *Steel, galvanized*

Ape TM P 220cc ('82-'83)



**163516050**



Senza guaina, con occhiello | *No sleeve, with eye*

Confezione 10 Pz. | *10 Pcs Packing*

Ape TM P 220cc ('82-'83) • Ape TM Diesel

420cc ('05-'12) • Ape TM P703 Diesel 420cc

('87-'04)

R.O. 177920



**163580020**



Con guaina e occhiello | *With sleeve and eye*  
Nero | *Black*

Acciaio, zincato | *Steel, galvanized*

Ape TM P703 220cc ('84-'05) • Ape TM P703 V

220cc ('84-'05) • Ape TM P FL2 220cc ('84-'05)

• Ape TM P602 220cc ('82-'83)

R.O. 197097



## CAVI TRASMISSIONE APE - APE TRANSMISSION CABLES

163580040



Con guaina e occhio | *With sleeve and eye*  
 Nero | *Black*  
 Acciaio, zincato | *Steel, galvanized*  
 Ape TM Diesel 420cc ('05-'12) • Ape TM P703  
 Diesel 420cc ('87-'04)  
 R.O. 228712



## CAVI TRASMISSIONE STARTER - STARTER TRANSMISSION CABLES

163512010



Confezione 10 Pz. | *10 Pcs Packing*  
 Ape TM P703 220cc ('84-'05) • Ape TM P703 V  
 220cc ('84-'05) • Ape TM P FL2 220cc ('84-'05)  
 • Ape TM P602 220cc ('82-'83) • Ape MP P501-  
 601 220cc  
 R.O. 214168



163610080



Dimensioni 1615 mm Ø 0,8 mm/5,0 mm |  
*Dimensions 1615 mm Ø 0,8 mm/5,0 mm*  
 Con guaina e barilotto | *With sleeve and nipple*  
 Grigio | *Grey*  
 Acciaio, zincato | *Steel, galvanized*  
 Lunghezza guaina 1540 mm | *Sleeve length*  
 1540 mm  
 Ape P50 ('80-'85)  
 R.O. 118456



163610110



Con guaina e barilotto | *With sleeve and nipple*  
 Grigio | *Grey*  
 Acciaio, zincato | *Steel, galvanized*  
 Ape FL-FL2 ('89-'95) • Ape FL3 Europa ('96-'99)  
 • Ape Mix 2T ('98-'08) • Ape RST Mix ('99-'03)  
 R.O. 194821



**163595190**



Lunghezza cavo 610 mm | *Cable length 610 mm*  
 Con guaina e barilotto | *With sleeve and nipple*  
 Grigio | *Grey*

Acciaio, zincato | *Steel, galvanized*

Lunghezza guaina 510 mm | *Sleeve length 510 mm*

Ape Mix 2T ('98-'08) • Ape RST Mix ('99-'03) •

Ape 50 ('09-'22)

R.O. 567104



**163595120**



Con guaina e barilotto | *With sleeve and nipple*  
 Grigio | *Grey*

Acciaio, zincato | *Steel, galvanized*

Ape 601-602-703 220cc

R.O. 133441



**163595130**



Con guaina e barilotto | *With sleeve and nipple*  
 Grigio | *Grey*

Acciaio, zincato | *Steel, galvanized*

Ape Car P2-P3 220cc • Ape MP P501-601 220cc

•Ape MP P501-601 220cc •Ape TM P703 220cc

('84-'05) • Ape TM P703 V 220cc ('84-'05) • Ape

TM P FL2 220cc ('84-'05) • Ape TM P602 220cc

('82-'83)

R.O. 221891



## CAVI TRASMISSIONE APE - APE TRANSMISSION CABLES

## TRASMISSIONI SDOPPIATORE CARBURATORE - SPLITTER CARBURATOR TRANSMISSIONS

163597290



Lunghezza cavo 900 mm | *Cable length 900 mm*

Con guaina e barilotto | *With sleeve and nipple*  
Grigio | *Grey*

Acciaio, zincato | *Steel, galvanized*

Lunghezza guaina 840 mm | *Sleeve length 840 mm*

Ape 50 ('09-'15) • Ape Mix 50 2T ('98-'08) • Ape  
50 Rst Mix ('99-'03)

R.O. 567103



## TRASMISSIONI RETROMARCIA - REVERSE TRANSMISSIONS

163585000



Dimensioni 940 mm Ø2 mm/6 mm | *Dimensions 940 mm Ø2 mm/6 mm*

Con guaina e 2 ganci | *With sleeve and 2 hooks*

Grigio | *Grey*

Acciaio, zincato | *Steel, galvanized*

Lunghezza guaina 790 mm | *Sleeve length 790 mm*

Ape TM P ('85-'89) • Ape P 50 ('80-'85)

R.O. 117309



163585010



Dimensioni 1270 mm Ø2 mm/6 mm |

*Dimensions 1270 mm Ø2 mm/6 mm*

Con guaina e 2 ganci | *With sleeve and 2 hooks*

Grigio | *Grey*

Acciaio, zincato | *Steel, galvanized*

Lunghezza guaina 670 mm | *Sleeve length 670 mm*

Ape FL-FL2 ('89-'95) • Ape FL3 Europa ('96-'99)

• Ape Mix 2T ('98-'08) • Ape RST Mix ('99-'03) •

Ape 50 ('09-'22)

R.O. 258646



## CAVI TRASMISSIONE APE - APE TRANSMISSION CABLES

**163585030**



Con guaina e occhio | *With sleeve and eye*  
 Grigio | *Grey*  
 Acciaio, zincato | *Steel, galvanized*  
 Ape MP P501-601 220cc  
 R.O. 109426



**163585040**



Con guaina e occhio | *With sleeve and eye*  
 Grigio | *Grey*  
 Acciaio, zincato | *Steel, galvanized*  
 Ape TM P703 220cc ('84-'05) • Ape TM P703 V  
 220cc ('84-'05) • Ape TM P FL2 220cc ('84-'05)  
 • Ape TM P602 220cc ('82-'83)  
 R.O. 266596



**163585050**



Con guaina e occhio | *With sleeve and eye*  
 Grigio | *Grey*  
 Acciaio, zincato | *Steel, galvanized*  
 Ape TM P602 220cc ('82-'83)  
 R.O. 197069



## TRASMISSIONI FRENO A MANO - HANDBRAKE TRANSMISSIONS

**163555460**



Con guaina | *With sleeve*  
 Grigio | *Grey*  
 Acciaio, zincato | *Steel, galvanized*  
 Ape MP P501-601 220cc  
 R.O. 140247





## CAVI TRASMISSIONE APE - APE TRANSMISSION CABLES

**163555470**

Con guaina e occhio | *With sleeve and eye*  
Grigio | *Grey*

Acciaio, zincato | *Steel, galvanized*

Ape TM P703 220cc ('84-'05) • Ape TM P703 V  
220cc ('84-'05) • Ape TM P FL2 220cc ('84-'05)

• Ape TM P602 220cc ('82-'83) • Ape TM P702  
Diesel 420cc ('05-'12) • Ape TM P703 Diesel

420cc ('87-'04)

R.O. 189752

**163555480**

Con guaina | *With sleeve*

Grigio | *Grey*

Acciaio, zincato | *Steel, galvanized*

Ape TM P703 220cc ('84-'05) • Ape TM P703 V  
220cc ('84-'05) • Ape TM P FL2 220cc ('84-'05)

• Ape TM P602 220cc ('82-'83) • Ape TM P702  
Diesel 420cc ('05-'12) • Ape TM P703 Diesel

420cc ('87-'04)

R.O. 214153



## TRASMISSIONI CONTACHILOMETRI - SPEEDOMETER TRANSMISSIONS

**163631080**

Con guaina | *With sleeve*

Ape FL-FL2 ('89-'95) • Ape FL3 Europa ('96-'99)

• Ape Mix 2T ('98-'08) • Ape RST Mix ('99-'03) •

Ape 50 ('09-'22)

R.O. 188636

**163630850**

Con guaina | *With sleeve*

Ape TM P703 220cc ('84-'05) • Ape TM P703 V  
220cc ('84-'05) • Ape TM P FL2 220cc ('84-'05)

• Ape TM P602 220cc ('82-'83)

R.O. 194371



## ACCESSORI CAVI TRASMISSIONE - TRANSMISSION CABLES ACCESSORIES

121860310



SDOPPIATORE | SPLITTER

Ape Mix 2T ('98-'08) • Ape RST Mix ('99-'03) •

Ape 50 ('09-'22)

R.O. 269571



## MORSETTI CAVI - CABLE CLAMPS

121858010



MORSETTO CON VITE LATERALE | CLAMPS

WITH SIDE SCREW

Ø 7x11 - M4

Per cavo frizione Ø 1,9 mm | For clutch cable Ø 1,9 mm

Confezione 10 pz. | 10 Pcs Packing



121858020



MORSETTO CON VITE LATERALE | CLAMPS

WITH SIDE SCREW

Ø 8x12 - M4

Per cavo frizione Ø 2,5 mm | For clutch cable Ø 2,5 mm

Confezione 10 pz. | 10 Pcs Packing



121858030



MORSETTO CON VITE LATERALE | CLAMPS

WITH SIDE SCREW

Ø 12x18 - M5

Per cavo frizione Ø 3 mm | For clutch cable Ø 3 mm

Confezione 10 pz. | 10 Pcs Packing



121858040



MORSETTO CAVO GAS | THROTTLE CABLE

CLAMPS

Ø 5,5x7,3 - M4

Tipo Magura | Magura type

Confezione 10 pz. | 10 Pcs Packing



## MORSETTI CAVI - CABLE CLAMPS

**121858050**MORSETTO CAVO GAS | *THROTTLE CABLE CLAMPS*

Ø 5,5x6 - Filetto 1/8

Super pratic

Confezione 10 pz. | *10 Pcs Packing***121858060**MORSETTO CILINDRICO CAVO GAS | *THROTTLE CABLE CLAMPS*

Ø 4x9

Per carburatore Vespa

Confezione 10 pz. | *10 Pcs Packing***121858080**MORSETTO CAVO CAMBIO | *GEAR CABLE CLAMPS*Lunghezza 16 mm | *Length 16 mm*Esagono 8x16 mm | *Hexagon 8x16 mm*Gambo Ø 6,8 mm | *Stem Ø 6,8 mm*Confezione 10 pz. | *10 Pcs Packing*

Ape MP P501-P601 220cc ('78-'96) • Ape Car-Max Diesel 420cc ('86-'96) • Ape Poker Diesel 420cc ('93-'97)

R.O. 153513



121858130



REGISTRO CAVO Ø 5 MM | ADJUSTING SCREW  
Ø 5 MM

Esagono 8 mm | Hexagon 8 mm

M5x31 mm | M5x31 mm

Confezione 10 pz. | 10 Pcs Packing

Ape FL-FL2 ('89-'95) • Ape FL3 Europa ('96-'99)  
• Ape Mix 2T ('98-'08) • Ape RST Mix ('99-'03) •  
Ape P 50 ('80-'85) • Ape 50 ('09-'22) • Ape Car  
P2-P3 220cc • Ape MP P501-601 220cc • Ape  
TM 220cc ('09-'16) • Ape TM P 220cc ('82-'07)  
• Ape Car-Max Diesel 420cc ('86-'96) • Ape  
Poker Benzina/Diesel 420cc ('93-'97) • Ape TM  
Diesel 420cc ('05-'12) • Ape TM P703 Diesel  
420cc ('87-'04) • Ape Calessino 420cc ('07-'12) •  
Ape Classic 400cc ('14-'17) • Ape MP P501-P601  
220cc ('78-'96) • Ape MP601 Classic 420cc  
( '06-'13)

R.O. 090527 - 020105



121858150



REGISTRO CAVO Ø 8 MM | ADJUSTING SCREW  
Ø 8 MM

Esagono 12 mm | Hexagon 12 mm

M8x40 mm | M8x40 mm

Confezione 10 pz. | 10 Pcs Packing



121858250



REGOLATORE M8 | M8 ADJUSTING SCREW

Confezione 5 pz. | 5 Pcs Packing



121858260



REGOLATORE M5 | M5 ADJUSTING SCREW

Confezione 10 pz. | 10 Pcs Packing



## REGISTRI CAVI - CABLE REGISTERS

121858270



REGOLATORE M6 | M6 ADJUSTING SCREW  
 Confezione 5 pz. | 5 Pcs Packing



121858300



REGOLATORE M10 | M10 ADJUSTING SCREW  
 Confezione 5 pz. | 5 Pcs Packing  
 M10x1.25 | M10x1.25



## GUAINA - OUTER CABLES

## GUAINA CON SPIRALE IN ACCIAIO TONDO (TIPO ITALIA) - OUTER CABLE ROUND WIRE (ITALIAN TYPE)

163530400



Colore Nero | Colour Black  
 Misura 50/mtrs roll | Size 50/mtrs roll  
 Foro interno 2,5 mm | Inside hole 2,5 mm  
 Diametro esterno 4,5 mm | Outside diameter  
 mm 4,5 mm  
 Diametro esterno con rivestimento 5,2 mm |  
 Outside hole with rubber mm 5,2 mm



163530401



Colore Grigio | Colour Gray  
 Misura 50/mtrs roll | Size 50/mtrs roll  
 Foro interno 2,5 mm | Inside hole 2,5 mm  
 Diametro esterno 4,5 mm | Outside diameter  
 mm 4,5 mm  
 Diametro esterno con rivestimento 5,2 mm |  
 Outside hole with rubber mm 5,2 mm



## GUAINA - OUTER CABLES

**163530411**



Colore Grigio millerighe | *Colour Gray grooved*  
 Misura 50/mtrs roll | *Size 50/mtrs roll*  
 Foro interno 2,5 mm | *Inside hole 2,5 mm*  
 Diametro esterno 4,5 mm | *Outside diameter mm 4,5 mm*  
 Diametro esterno con rivestimento 5,2 mm |  
*Outside hole with rubber mm 5,2 mm*



**163530500**



Colore Nero | *Colour Black*  
 Misura 50/mtrs roll | *Size 50/mtrs roll*  
 Foro interno 3 mm | *Inside hole 3 mm*  
 Diametro esterno 5 mm | *Outside diameter mm 5 mm*  
 Diametro esterno con rivestimento 5,8 mm |  
*Outside hole with rubber mm 5,8 mm*



**163530600**



Colore Nero | *Colour Black*  
 Misura 25/mtrs roll | *Size 25/mtrs roll*  
 Foro interno 3,5 mm | *Inside hole 3,5 mm*  
 Diametro esterno 6 mm | *Outside diameter mm 6 mm*  
 Diametro esterno con rivestimento 7 mm |  
*Outside hole with rubber mm 7 mm*



**163530700**



Colore Nero | *Colour Black*  
 Misura 25/mtrs roll | *Size 25/mtrs roll*  
 Foro interno 4,2 mm | *Inside hole 4,2 mm*  
 Diametro esterno 7 mm | *Outside diameter mm 7 mm*  
 Diametro esterno con rivestimento 8 mm |  
*Outside hole with rubber mm 8 mm*



## CAPIGUAINA - CABLE ENDS

**421830201**

CAPOGUAINA Ø 5,5 x 9,5 MM | CABLE ENDS Ø 5,5 x 9,5 MM

Confezione 10 pz. | 10 Pcs Packing

**121858190**

CAPOGUAINA Ø 6 x 10 MM | CABLE ENDS Ø 6 x 10 MM

Confezione 50 pz. | 50 Pcs Packing

**121858200**

CAPOGUAINA Ø 7 x 11 MM | CABLE ENDS Ø 7 x 11 MM

Confezione 50 pz. | 50 Pcs Packing

**421830211**

CAPOGUAINA Ø 5 x 9,5 MM NICHELATA | NICHEL - PLATED CABLE ENDS Ø 5 x 9,5 MM

Confezione 10 pz. | 10 Pcs Packing

**121858210**

BUSSOLA GUAINA Ø 4,5 MM | CABLE END Ø 4,5 MM

Dimensioni 7x9 mm | Dimensions 7x9 mm

Confezione 20 pz. | 20 Pcs Packing



## SERRATURE - LOCKS

### SERRATURE - LOCKS

121790212



Kit serratura completa | *Complete lock*

Ape FL-FL2 ('89-'95) • Ape FL3 Europa ('96-'99)

• Ape TM P ('85'89)

R.O. 258664



121790122



Serratura sterzo - Chiavi in plastica | *Steering lock - 2 plastic keys*

Guida mm 4 | *Size mm 4*

Lunghezza 38 mm | *Length 38 mm*

Ape TM P ('85'89)

R.O. 152096



121790192



Ape TM P ('85'89)

R.O. 152096



## ACCESSORI SERRATURE - LOCKS ACCESSORIES

246050780 **NEW**



PIASTRINA CROMATA SERRATURA NEIMAN  
DBP Ø Bohrloch 4,45 mm | *CHROMED PLATE*  
*NEIMAN LOCK DBP*

Colore Cromato | *Colour Chromed*

Forma Goccia | *Shape Drop*





MOLLE A GAS - SADDLE GAS SPRINGS

121870450



**STABILUS**



Ape FL-FL2 ('89-'95) • Ape FL3 Europa ('96-'99)  
 • Ape Mix 2T ('98-'08) • Ape RST Mix ('99-'03) •  
 Ape P 50 ('80-'85) • Ape 50 ('09-'22) • Ape Car  
 P2-P3 220cc • Ape MP P501-601 220cc • Ape  
 TM 220cc ('09-'16) • Ape TM P 220cc ('82-'07) •  
 Ape Car-Max Diesel 420cc ('86-'96) • Ape Poker  
 Benzina/Diesel 420cc ('93-'97) • Ape TM Diesel  
 420cc ('05-'12) • Ape TM P703 Diesel 420cc  
 ('87-'04) • Ape Car MAX Diesel ('86-'96)

Interasse (mm)  
 Wheelbase (mm) 650

Attacco superiore  
 Upper fastening point

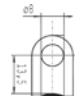

Ø 8mm

Attacco inferiore  
 Lower fastening point



Ø 8mm

Forza (N)  
 Load (N) 300



SELLE - SEATS

142760013

**NEW**



Ape MP 500-550-600-601 • Ape MP 601  
 Francia



142760014

**NEW**



Manubrio | Handlebar  
 Ape TM 703



## SELLE - SEATS

142760015 **NEW**



Volante | *Steering wheel*  
Ape TM 703



142760016 **NEW**



Schienale | *Backrest*  
Ape MP 500-550-600-601 • Ape MP 601  
Francia



142760017 **NEW**



Schienale | *Backrest*  
Ape car



142760018 **NEW**



Schienale, manubrio | *Backrest, handlebar*  
Ape TM P602 • Ape TM P703 • Ape TM P703V  
• Ape TM P703 Manubrio - *Handlebar* • Ape  
TM P703 Volante - *Steering wheel* • Ape TM  
P703/P703V FL • Ape TM P703 D LCS • Ape TM  
(2009)



SELLE - SEATS

142760019 **NEW**



Ape 50 P

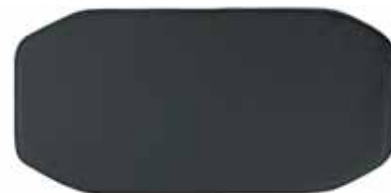

142760020 **NEW**



Ape 50 FL-FL2



142760021 **NEW**



Schienale | *Backrest*

Ape TM 50-125 • Ape TM P50 • Ape TM P50  
Elestart • Ape TM 50 Francia & Austria



142760028 **NEW**



Ape 50 FL • Ape TM P50 Elestart • Ape TM 50  
Francia & Austria



## ACCESSORI SELLE - SEATS ACCESSORIES

142760032 **NEW**



Copertina sella | *Seat cover*  
Ape MP 500-550-600-601 • Ape MP 601  
Francia



142760033 **NEW**



Copertina sella | *Seat cover*  
Ape Car



142760034 **NEW**



Copertina sella manubrio | *Seat cover handlebar*  
Ape TM 703



142760035 **NEW**



Copertina sella volante | *Seat cover steering wheel*  
Ape TM 703



# SOSPENSIONI

S U S P E N S I O N S

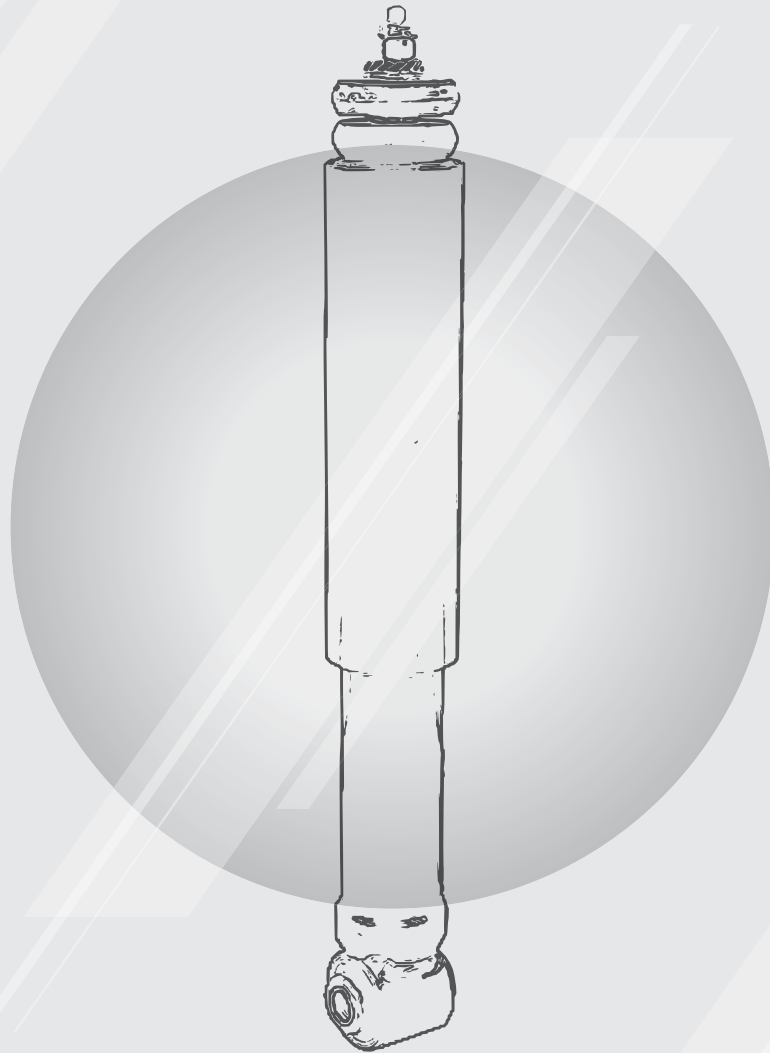

## AMMORTIZZATORI - SHOCK ABSORBERS

**204565002**



Ape 50 ('80-'22)  
R.O. 646464, 2682514

LUNGHEZZA LENGTH (mm)	ATTACCO SUPERIORE UPPER FASTENING POINT			ATTACCO INFERIORE LOWER FASTENING POINT		
	TIPO - TYPE	D (mm)	W (mm)	TIPO - TYPE	D (mm)	W (mm)
403		M10x1,25	-		M10x1,25	-



**204565012**



Ape Calessino 200cc ('13-'21) • Ape Car P2-P3 220cc • Ape Calessino 420cc ('07-'12) • Ape Classic 400cc ('14-'17) • Ape MP P501-P601 220cc ('78-'96)  
R.O. 1364514

LUNGHEZZA LENGTH (mm)	ATTACCO SUPERIORE UPPER FASTENING POINT			ATTACCO INFERIORE LOWER FASTENING POINT		
	TIPO - TYPE	D (mm)	W (mm)	TIPO - TYPE	D (mm)	W (mm)
385		M10x1,25	-		10	40



**204585002**



Ape 50 ('80-'22)  
R.O. 646463, 566502

LUNGHEZZA LENGTH (mm)	ATTACCO SUPERIORE UPPER FASTENING POINT			ATTACCO INFERIORE LOWER FASTENING POINT		
	TIPO - TYPE	D (mm)	W (mm)	TIPO - TYPE	D (mm)	W (mm)
368,5		M10x1,25	-		15,1	4



AMMORTIZZATORI - SHOCK ABSORBERS

**204585012**



Ape Calessino 200cc ('13-'16) • Ape Car P2-P3 220cc ('78-'85) • Ape MP P501-P601 220cc ('78-'96) •  
Ape Calessino 420cc ('07-'12)  
R.O. 566504

LUNGHEZZA LENGTH (mm)	ATTACCO SUPERIORE UPPER FASTENING POINT			ATTACCO INFERIORE LOWER FASTENING POINT		
	TIPO - TYPE	D (mm)	W (mm)	TIPO - TYPE	D (mm)	W (mm)
439		M10x1,25	-		18,1	48



**204585022**



Ape MP P501-P601

LUNGHEZZA LENGTH (mm)	ATTACCO SUPERIORE UPPER FASTENING POINT			ATTACCO INFERIORE LOWER FASTENING POINT		
	TIPO - TYPE	D (mm)	W (mm)	TIPO - TYPE	D (mm)	W (mm)
417		M10x1,25	-		18,1	48



**204585032**



Ape TM P602

LUNGHEZZA LENGTH (mm)	ATTACCO SUPERIORE UPPER FASTENING POINT			ATTACCO INFERIORE LOWER FASTENING POINT		
	TIPO - TYPE	D (mm)	W (mm)	TIPO - TYPE	D (mm)	W (mm)
400		M10x1,25	-		19,1	48



## AMMORTIZZATORI - SHOCK ABSORBERS

**204585042**



Ape TM • Ape TM P703 FL2 • Ape TM P703-P703V, FL2 • Ape CAR - Max diesel • Ape TM Diesel LCS • Ape TM P703-P703V Diesel

LUNGHEZZA LENGTH (mm)	ATTACCO SUPERIORE UPPER FASTENING POINT			ATTACCO INFERIORE LOWER FASTENING POINT		
	TIPO - TYPE	D (mm)	W (mm)	TIPO - TYPE	D (mm)	W (mm)
400		M10x1,25	-		19,1	48



## ACCESSORI AMMORTIZZATORI - SOSPENSIONI - SHOCK ABSORBERS - SUSPENSIONS ACCESSORIES

### KIT PERNO SOSPENSIONE - SUSPENSION PIN KIT

**225180060**



2 Gabbie Ø 12 x 20 x 12 | 2 Cages Ø 12 x 20 x 12  
 2 Rondelle Ø 12 x 23 x 2 | 2 Washer Ø 12 x 23  
 x 2  
 1 Perno Ø 12 x 104 | 1 Pin Ø 12 x 104  
 Ape 50  
 R.O. 016781



**225180070**



2 Gabbie Ø 16 x 22 x 14 | 2 Cages Ø 16 x 22 x 14  
 2 Guarnizioni | 2 Gaskets  
 1 Perno Ø 16 x 71 | 1 Pin Ø 16 x 71  
 Perno per ingrassaggio | With nipple grease  
 Ape  
 R.O. 154676



**225180080**



2 Gabbie Ø 16 x 22 x 14 | 2 Cages Ø 16 x 22 x 14  
 2 Guarnizioni | 2 Gaskets  
 1 perno Ø 16 x 75 | 1 Pin Ø 16 x 75  
 Ape P 50





## ACCESSORI AMMORTIZZATORI - SOSPENSIONI - SHOCK ABSORBERS - SUSPENSIONS ACCESSORIES

**225180090**

2 Gabbie Ø 16 x 22 x 14 | 2 Cages Ø 16 x 22 x 14  
 2 Guarnizioni | 2 Gaskets  
 1 Perno Ø 16 x 75 | 1 Pin Ø 16 x 75  
 Perno per ingrassaggio | With nipple grease  
 Ape P

**225180110**

2 Gabbie Ø 18 x 24 x 13 | 2 Cages Ø 18 x 24 x 13  
 2 Guarnizioni | 2 Gaskets  
 1 Perno Ø 18 x 74 | 1 Pin Ø 18 x 74  
 Perno per ingrassaggio | With nipple grease  
 Ape Mp

**225180130**

2 Gabbie Ø 18 x 24 x 13 | 2 Cages Ø 18 x 24 x 13  
 2 Guarnizioni | 2 Gaskets  
 1 Perno Ø 18 x 84 | 1 Pin Ø 18 x 84  
 Ape Car • Ape 501 • Ape 601 V

**225180140**

2 Gabbie Ø 18 x 24 x 15 | 2 Cages Ø 18 x 24 x 15  
 2 Guarnizioni | 2 Gaskets  
 1 Perno Ø 18 x 91 | 1 Pin Ø 18 x 91  
 Ape TM P 602

**225180150**

2 Gabbie Ø 18 x 24 x 15 | 2 Cages Ø 18 x 24 x 15  
 2 Guarnizioni | 2 Gaskets  
 1 Perno Ø 18 x 91 | 1 Pin Ø 18 x 91  
 Perno per ingrassaggio | With nipple grease  
 Ape TM P 602





# CUSCINETTI

BEARINGS



## CUSCINETTI A SFERE - BALL BEARINGS

### CUSCINETTI RADIALI A SFERE - BALL BEARINGS

**100200200**



Dimensioni 10 - 30 - 9 mm | *Dimensions 10 - 30 - 9 mm*

Codice prodotto 6200 C3 | *Product number 6200 C3*

Gabbia in acciaio | *Steel cage*

Ape 50



**100200090**



Dimensioni 17 - 47 -14 mm | *Dimensions 17 - 47 -14 mm*

Codice prodotto 6303 | *Product number 6303*

Gabbia in acciaio | *Steel cage*



**100200430**



Dimensioni 17 - 47 -14 mm | *Dimensions 17 - 47 -14 mm*

Codice prodotto 6303 C3 | *Product number 6303 C3*

Gabbia in acciaio | *Steel cage*



**100200550**



Dimensioni 17 - 47 -14 mm | *Dimensions 17 - 47 -14 mm*

Codice prodotto 6303 TN9 C3 | *Product number 6303 TN9 C3*

Gabbia in nylon | *Nylon cage*



**100200390**



Dimensioni 20 - 47 -14 mm | *Dimensions 20 - 47 -14 mm*

Codice prodotto 6204 C3 | *Product number 6204 C3*

Gabbia in acciaio | *Steel cage*



## CUSCINETTI A SFERE - BALL BEARINGS

**100200482****NTN**<sup>®</sup>Dimensioni 20 - 47 -14 mm | *Dimensions 20 - 47 -14 mm*Codice prodotto 6204 JR2 C4 | *Product number 6204 JR2 C4*Gabbia in acciaio | *Steel cage***100200630****SKF**Dimensioni 20 - 47 -14 mm | *Dimensions 20 - 47 -14 mm*Codice prodotto 6204 C4 MT | *Product number 6204 C4 MT*Gabbia in acciaio | *Steel cage***100200110****SKF**Dimensioni 20 - 47 -14 mm | *Dimensions 20 - 47 -14 mm*Codice prodotto 6204 C5 | *Product number 6204 C5*Gabbia in acciaio | *Steel cage***100200120****SKF**Dimensioni 20 - 47 -14 mm | *Dimensions 20 - 47 -14 mm*Codice prodotto 6204 TN9 C4 HLHT23 | *Product number 6204 TN9 C4 HLHT23*Gabbia in nylon | *Nylon cage***100200590****SKF**Dimensioni 20 - 47 -14 mm | *Dimensions 20 - 47 -14 mm*Codice prodotto 6204 | *Product number 6204*Gabbia in acciaio | *Steel cage*

## CUSCINETTI A SFERE - BALL BEARINGS

**100200420**



Dimensioni 22 - 50 - 14 mm | *Dimensions 22 - 50 - 14 mm*

Codice prodotto 62/22 | *Product number 62/22*

Gabbia in acciaio | *Steel cage*

Ape Car P2-P3 220cc • Ape TM 220cc ('09-'16) • Ape TM P 220cc ('82-'07) • Ape Car-Max Diesel 420cc ('86-'96) • Ape Poker Benzina/Diesel 420cc ('93-'97) • Ape TM Diesel 420cc ('05-'12) • Ape TM P703 Diesel 420cc ('87-'04) • Ape Calessino 420cc ('07-'12) • Ape Classic 400cc ('14-'17) • Ape MP P501-P601 220cc ('78-'96) • Ape MP601 Classic 420cc ('06-'13)



**100200520**



Dimensioni 25 - 47 - 8 | *Dimensions 25 - 47 - 8*

Codice prodotto 16005 | *Product number 16005*

Applicazione Ingranaggio Frizione | *Application Clutch gear*

Gabbia in acciaio | *Steel cage*

Ape 50

R.O. 007130



**100200170**



Dimensioni 25 - 62 - 17 | *Dimensions 25 - 62 - 17*

Codice prodotto (6305-C5) | *Product number (6305-C5)*

Applicazione Albero Motore lato frizione | *Application For Crankshaft clutch side*

Gabbia in acciaio | *Steel cage*

Ape Car 220cc ('72-'86) • Ape MP P501/P601 220cc ('78-'96) • Ape TM 220cc ('09-'16) • Ape TM P ('82-'07)

R.O. 169809



GABBIE A RULLI - ROLLER CAGES  
**GABBIE A RULLI - ROLLER CAGES**

**100150300**

Modello **DURKOP** | *Model DURKOP*  
 Dimensioni Ø 12x17x13 | *Dimensions Ø 12x17x13*  
 Confezione 5 Pz. | *Packing 5 Pcs*  
 Ape 50  
 R.O. 500501

**100150301**

Modello **KOYO** | *Model KOYO*  
 Dimensioni Ø 12x17x13 | *Dimensions Ø 12x17x13*  
 Confezione 5 Pz. | *Packing 5 Pcs*  
 R.O. 500501

**100150250**

Modello **DURKOP** | *Model DURKOP*  
 Dimensioni Ø 12x17x15 | *Dimensions Ø 12x17x15*  
 Confezione 5 Pz. | *Packing 5 Pcs*  
 Ape 50

**100150450**

Modello **DURKOP** | *Model DURKOP*  
 Dimensioni Ø 16x20x20 | *Dimensions Ø 16x20x20*  
 Confezione 5 Pz. | *Packing 5 Pcs*  
 Ape MP • Ape 175cc • Motori FBM  
 R.O. 500511

**100150453**

Modello | *Model*  
 Dimensioni Ø 16x20x20 | *Dimensions Ø 16x20x20*  
 Confezione 5 Pz. | *Packing 5 Pcs*  
 Ape MP • Ape 175cc • Motori FBM  
 R.O. 500511



**100150500**

Modello **DURKOP** | *Model DURKOP*  
Dimensioni Ø 18x23x20 | *Dimensions Ø*  
*18x23x20*  
Confezione 5 Pz. | *Packing 5 Pcs*  
R.O. 500531





# TENUTA

TIGHT SYSTEM

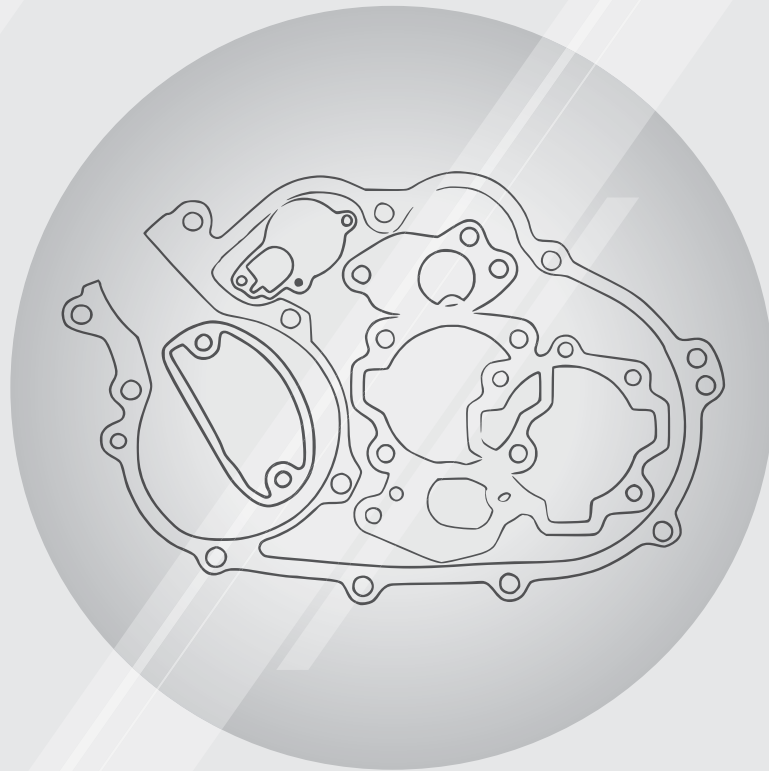

## GUARNIZIONI - GASKETS

### KIT GUARNIZIONI MOTORE COMPLETO - COMPLETE ENGINE GASKET KIT

100686500



Ape P 50 ('80-'85) • Ape TM P 50 ('85-'89)

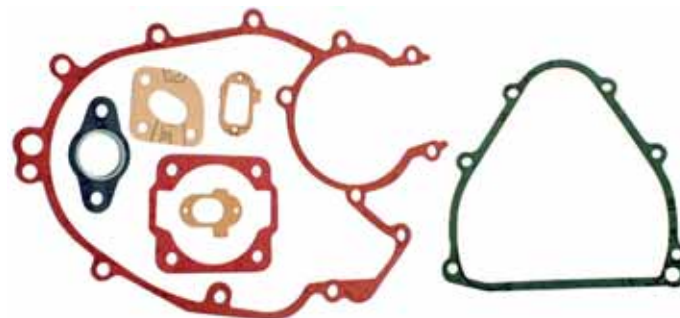

100686530



Ape Car



100686540



Cambio rinforzato | Reinforced gears  
Ape TM 602 220cc • Ape TM 703 220cc



100686520



Ape MP

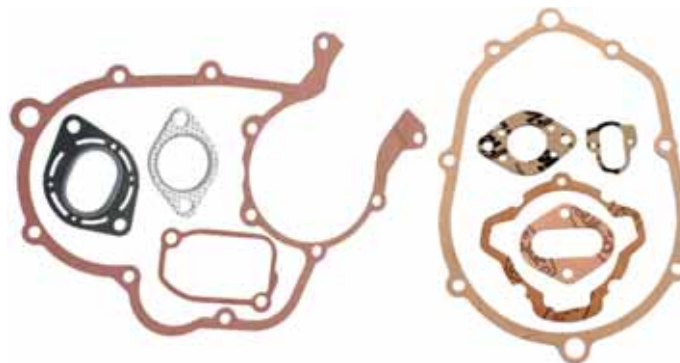

## GUARNIZIONI - GASKETS

## GUARNIZIONE BASE CILINDRO - CYLINDER BASE GASKET

100703080



Confezione 5 Pz. | 5 Pcs Packing

Ape Car P2-P3 220cc • Ape MP P501-601 220cc

• Ape TM 220cc ('09-'16) • Ape TM P 220cc ('82-'07)

R.O. 132365, 873212



## GUARNIZIONE CARTER FRIZIONE - CLUTCH COVER GASKET

100706200



Confezione 5 Pz. | 5 Pcs Packing

Ape FL-FL2 ('89-'95) • Ape FL3 Europa ('96-'99)

• Ape P50 ('80-'85) • Ape TM P ('85-'89)

R.O. 079002



## GUARNIZIONE TAPPO OLIO - OIL CAP GASKET

100708000



Rondella in fibra | Fiber washer

Rondella Ø 8 x 12 x 1 | Washer Ø 8 x 12 x 1

Confezione 10 Pz. | 10 Pcs Packing

Ape FL-FL2 ('89-'95) • Ape FL3 Europa ('96-'99)

• Ape Mix 2T ('98-'08) • Ape RST Mix ('99-'03) •

Ape P 50 ('80-'85) • Ape 50 ('09-'22) • Ape Car

P2-P3 220cc • Ape MP P501-601 220cc • Ape

TM 220cc ('09-'16) • Ape TM P 220cc ('82-'07) •

Ape Car-Max Diesel 420cc ('86-'96) • Ape Poker

Benzina/Diesel 420cc ('93-'97) • Ape TM Diesel

420cc ('05-'12) • Ape TM P703 Diesel 420cc

('87-'04)

R.O. 000397



## GUARNIZIONI - GASKETS

### GUARNIZIONI COLLETTORE ASPIRAZIONE - INTAKE MANIFOLD GASKETS

100703930



Confezione 5 Pz. | 5 Pcs Packing

Ape FL-FL2 ('89-'95) • Ape FL3 Europa ('96-'99)

• Ape Mix 2T ('98-'08) • Ape RST Mix ('99-'03) •

Ape P 50 ('80-'85) • Ape 50 ('09-'22)

R.O. 873214



### GUARNIZIONE SCARICO - EXHAUST GASKET

100705111



Diametro fori prigionieri Ø8 mm | Stud diameter Ø8 mm

Confezione 5 Pz. | 5 Pcs Packing

Ape FL-FL2 ('89-'95) • Ape FL3 Europa ('96-'99)

• Ape Mix 2T ('98-'08) • Ape RST Mix ('99-'03) •

Ape P 50 ('80-'85) • Ape 50 ('09-'22)

R.O. 288837



100705320



Confezione 5 Pz. | 5 Pcs Packing

Ape Car P2-P3 220cc • Ape MP P501-601 220cc

• Ape TM 220cc ('09-'16) • Ape TM P 220cc ('82-'07)

R.O. 288840



### GUARNIZIONI CILINDRETTO FRENO - BRAKE CYLINDER GASKETS

225140010



Anteriore | Front

Kit 4 Pz. | 4 Pcs Kit

Ape MP • Ape Car



## GUARNIZIONI - GASKETS

**225140020**

Anteriore | *Front*  
 Kit 4 Pz. | *4 Pcs Kit*  
 Ape TM P602 • Ape TM P703

**225140030**

Posteriore | *Rear*  
 Kit 8 Pz. | *8 Pcs Kit*  
 Ape 50

**225140040**

Posteriore | *Rear*  
 Kit 8 Pz. | *8 Pcs Kit*  
 Ape MP • Ape MPR • Ape MPV • Ape 175

**225140050**

Posteriore | *Rear*  
 Kit 8 Pz. | *8 Pcs Kit*  
 Ape TM P602 • Ape TM P703



## GUARNIZIONI POMPA FRENO - MASTER BRAKE CYLINDER GASKETS

**225130010**

Ape 50



## GUARNIZIONI - GASKETS

**225130020**



Ape 175 • Ape Mp



**225130030**



Ape TM P602-TM P703 220cc



## PARAOLI - OIL SEALS

**100661700**



Misure 19-32-7 | *Size 19-32-7*

Materiale NBR | *Material NBR*

Tipologia labbro SC | *Lip type SC*

Albero motore lato frizione | *Crankshaft clutch side*

Ape FL3 Europa ('96-'99) • Ape Mix 2T ('98-'08)

• Ape RST Mix ('99-'03) • Ape Tm P 50 ('85-'89)

• Ape 50 ('09-'22)

R.O. 155579, 430390



**100661710**



Misure 19-32-7 | *Size 19-32-7*

Materiale NBR | *Material NBR*

Paraolio Blu | *Blue Oil Seal*

Albero motore lato volano | *Crankshaft flywheel side*

Ape P 50 ('80-85)



## PARAOLI - OIL SEALS

**100662000**

Misure 20-32-7 | *Size 20-32-7*  
 Materiale NBR | *Material NBR*  
 Tipologia labbro SC | *Lip type SC*  
 Albero motore lato volano | *Crankshaft flywheel side*

Ape FL-FL2 ('89-'95) • Ape FL3 Europa ('96-'99)  
 • Ape Mix 2T ('98-'08) • Ape RST Mix ('99-'03) •  
 Ape Tm P 50 ('85-'89) • Ape 50 ('09-'22)  
 R.O. 289306

**100662010**

Misure 20-32-7 | *Size 20-32-7*  
 Materiale Viton | *Material Viton*  
 Tipologia labbro OS | *Lip type OS*  
 Albero motore lato volano | *Crankshaft flywheel side*

**100662430**

Misure 22-32-7 | *Size 22-32-7*  
 Materiale NBR | *Material NBR*  
 Tipologia labbro SC | *Lip type SC*  
 Cuffia semiasse | *Axle shaft hood*  
 Ape Calessino 200cc ('13-'21) • Ape Car P2-P3  
 220cc • Ape TM 220cc ('09-'16) • Ape TM P  
 220cc ('82-'07) • Ape Car-Max Diesel 420cc  
 ('86-'96) • Ape Poker Benzina/Diesel 420cc  
 ('93-'97) • Ape TM Diesel 420cc ('05-'12) • Ape  
 TM P703 Diesel 420cc ('87-'04) • Ape Calessino  
 420cc ('07-'12) • Ape Classic 400cc ('14-'17)  
 • Ape MP P501-P601 220cc ('78-'96) • Ape  
 MP601 Classic 420cc ('06-'13)

**100660125** **NEW**

Misure 22.7-47-7 | *Size 22.7-47-7*  
 Materiale NBR | *Material NBR*  
 Paraolio Blu | *Blue Oil Seal*  
 Albero motore lato frizione | *Crankshaft clutch side*  
 Ape 50



## PARAOLI - OIL SEALS

**100660135** **NEW****CORTECO**

Misure 22.7-47-7 | Size 22.7-47-7

Materiale Viton | Material Viton

Albero motore lato frizione | Crankshaft clutch side

Ape 50

**100662700**

Misure 22.7-47-7/7.5 | Size 22.7-47-7/7.5

Materiale NBR | Material NBR

Tipologia labbro SC | Lip type SC

Albero motore lato frizione | Crankshaft clutch side

Ape FL-FL2 ('89-'95) • Ape FL3 Europa ('96-'99)

• Ape Mix 2T ('98-'08) • Ape RST Mix ('99-'03) •

Ape TM P 50 ('85-'89) • Ape 50 ('09-'22)

R.O. 289305

**100662710**

Misure 22.7-47-7/7.5 | Size 22.7-47-7/7.5

Materiale NBR | Material NBR

Paraolio Blu | Blue Oil Seal

Albero motore lato frizione | Crankshaft clutch side

**100663400**

Misure 24.9-45-5.5/6.5 | Size 24.9-45-5.5/6.5

Materiale NBR | Material NBR

Tipologia labbro HSCRY | Lip type HSCRY

Albero motore lato volano esterno | Crankshaft external flywheel side

Ape MP P501-601 220cc

R.O. 078002





## PARAOLI - OIL SEALS

**100663450**

Misure 24.9-45-5.5/6.5 | Size 24.9-45-5.5/6.5  
 Materiale NBR | Material NBR  
 Tipologia labbro SC | Lip type SC  
 Albero motore lato volano esterno | Crankshaft  
 external flywheel side  
 Ape MP P501-P601 220cc ('78-'96)

**100666095** NEW

Misure 24.9-45-6.5 | Size 24.9-45-6.5  
 Materiale NBR | Material NBR  
 Paraolio Blu | Blue Oil Seal  
 Albero motore lato volano esterno | Crankshaft  
 external flywheel side  
 Ape 500-600

**100666105** NEW

Misure 24.9-45-6.5 | Size 24.9-45-6.5  
 Materiale Viton | Material Viton  
 Albero motore lato volano esterno | Crankshaft  
 external flywheel side  
 Ape 501 ('82>) • Ape TM P602 • Ape TM P703

**100664700**

Misure 27-42-10 | Size 27-42-10  
 Materiale NBR | Material NBR  
 Tipologia labbro SC | Lip type SC  
 Mozzo ruota posteriore | Rear wheel hub  
 Ape FL-FL2 ('89-'95) • Ape FL3 Europa ('96-'99)  
 • Ape Mix 2T ('98-'08) • Ape RST Mix ('99-'03) •  
 Ape Tm P 50 ('85-'89) • Ape 50 ('09-'22)  
 R.O. 118058



## PARAOLI - OIL SEALS

**100664710**



Misure 27-42-10 | *Size 27-42-10*  
 Materiale NBR | *Material NBR*  
 Paraolio Blu | *Blue Oil Seal*  
 Mozzo ruota posteriore | *Rear wheel hub*  
 Ape 50



**100666055** **NEW**



Misure 32-52-5 | *Size 32-52-5*  
 Materiale NBR | *Material NBR*  
 Paraolio Blu | *Blue Oil Seal*  
 Albero motore lato volano | *Crankshaft flywheel side*  
 Ape 500-600



**100666085** **NEW**



Misure 35-47-7 | *Size 35-47-7*  
 Materiale NBR | *Material NBR*  
 Paraolio Blu | *Blue Oil Seal*  
 Ruota posteriore - carter differenziale | *Rear wheel - differential gear cover*  
 Ape 50



# LAMBRETTA

643	<b>MOTORE</b>	ENGINE	MOTOR	MOTEUR
647	<b>IMPIANTO FRENANTE</b>	BRAKING SYSTEM	SISTEMA DE FRENADOS	SYSTÈME DE FREINAGE
649	<b>IMPIANTO ELETTRICO</b>	ELECTRICAL SYSTEM	INSTALACION ELECTRICA	SYSTÈME ÉLECTRIQUE
655	<b>TRASMISSIONE</b>	TRANSMISSION	TRANSMISIÓN	TRANSMISSION
659	<b>CARROZZERIA</b>	BODY WORK	CARROCERIA	CARROSSERIE
663	<b>TELAIO</b>	CHASSIS	CHASIS	CHASSIS
675	<b>SOSPENSIONI</b>	SUSPENSIONS	SUSPENSIONES	SUSPENSIONS
679	<b>CUSCINETTI</b>	BEARINGS	COJINETES	ROULEMENT
681	<b>GOMME</b>	TIRES	NEUMATICOS	PNEUS





# MOTORE

ENGINE

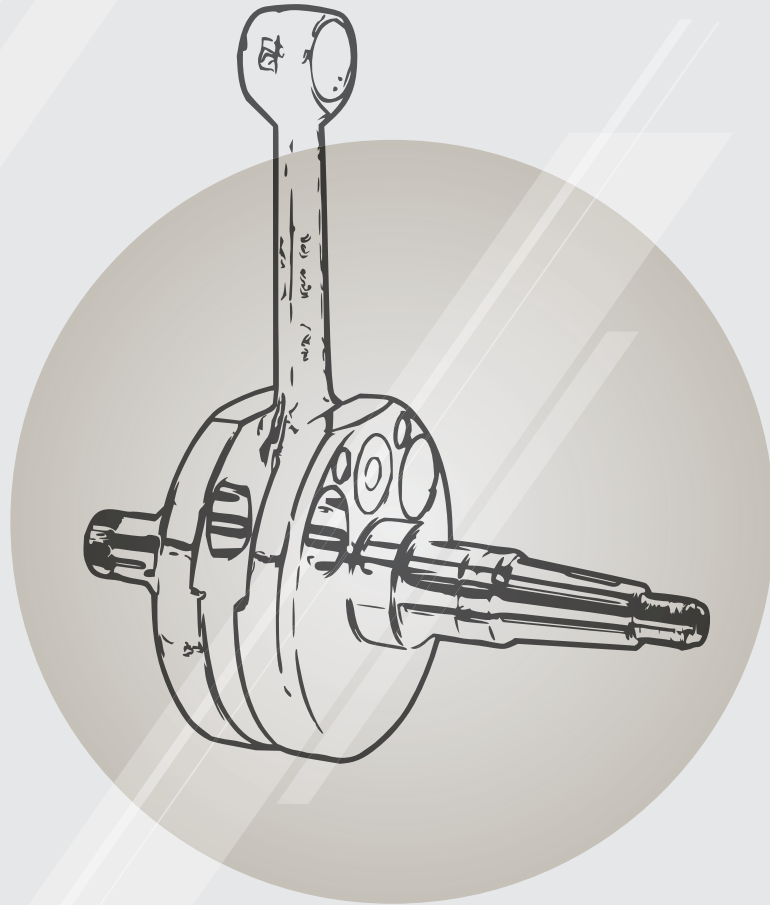

100012021 **NEW**



TIPO STANDARD | STANDARD TYPE

Corsa 58,00 mm | Stroke 58,00 mm

Biella 107,00 mm | Connecting rod 107,00 mm

Cono 21 mm | Cone 21 mm

Spinotto Ø 16 mm | Ø 16 mm pin

Codice fornitore AMT 074 | Supplier code AMT 074

Lambretta LI 125 • Lambretta 125 Special •

Lambretta LI 150 • Lambretta 150 Special •

Lambretta SX

R.O. 19912190



100012022 **NEW**



TIPO STANDARD | STANDARD TYPE

Corsa 58,00 mm | Stroke 58,00 mm

Biella 116,00 mm | Connecting rod 116,00 mm

Cono 21 mm | Cone 21 mm

Spinotto Ø 16 mm | Ø 16 mm pin

Codice fornitore AMT 076 | Supplier code AMT 076

Lambretta TV 175 2°serie/3° serie



## ALBERI MOTORE - CRANKSHAFTS

100012023 **NEW**TIPO STANDARD | *STANDARD TYPE*Corsa 58,00 mm | *Stroke 58,00 mm*Biella 107,00 mm | *Connecting rod 107,00 mm*Cono 21 mm | *Cone 21 mm*Spinotto Ø 16 mm | *Ø 16 mm pin*Codice fornitore AMT 078 | *Supplier code AMT 078*

Lambretta 200 SX

R.O. 19612150

100012024 **NEW**TIPO STANDARD | *STANDARD TYPE*Corsa 58,00 mm | *Stroke 58,00 mm*Biella 107,00 mm | *Connecting rod 107,00 mm*Cono 21 mm | *Cone 21 mm*Spinotto Ø 16 mm | *Ø 16 mm pin*Codice fornitore AMT 080 | *Supplier code AMT 080*

Lambretta 200 DL

R.O. 19612150



**121830033** **NEW**



TAMPONE MOTORE | ENGINE BUFFER

Colore Nero | Colour Black

Rotondo | Round

Lambretta 125 LI • Lambretta 125 LI Special

• Lambretta 125 DL • Lambretta 125 GP •

Lambretta 150 LI • Lambretta 150 LI Special

• Lambretta 150 SX • Lambretta 150 DL •

Lambretta 150 GP • Lambretta 175 TV 2°-3°

serie • Lambretta 200 TV • Lambretta 200 SX •

Lambretta 200 DL • Lambretta 200 GP

R.O. 19010036



**121831033** **NEW**



COPPIA SILENTBLOCK | TWO SILENTBLOCKS

Lambretta LI • Lambretta TV



**121831043** **NEW**



COPPIA SILENTBLOCK | TWO SILENTBLOCKS

Sinistro e destro | Left and right

Per perni di ancoraggio del motore lunghi | For long engine bolts

Lambretta 125 LI 2°-3° serie • Lambretta 125 LI

Special • Lambretta 125 DL • Lambretta 125 GP

• Lambretta 150 LI 2°-3° serie • Lambretta 150

LI Special • Lambretta 150 SX • Lambretta 150

DL • Lambretta 150 GP • Lambretta 175 TV 2°-3°

serie • Lambretta 200 TV • Lambretta 200 SX •

Lambretta 200 DL • Lambretta 200 GP

R.O. 19710030





# IMPIANTO FRENOANTE

BRAKING SYSTEM



225129140



**FERODO**

Spessore 22 mm | *Thickness 22 mm*

Diametro interno Ø 150 mm | *Internal diameter  
Ø 150 mm*

Anteriore e posteriore | *Front and rear*

Lambretta J 100

R.O. 22044040



225129141



**FERODO**

Spessore 25 mm | *Thickness 25 mm*

Diametro interno Ø 152 mm | *Internal diameter  
Ø 152 mm*

Anteriore e posteriore | *Front and rear*

Lambretta DL 125

R.O. 22044040



# IMPIANTO ELETTRICO

ELECTRICAL SYSTEM

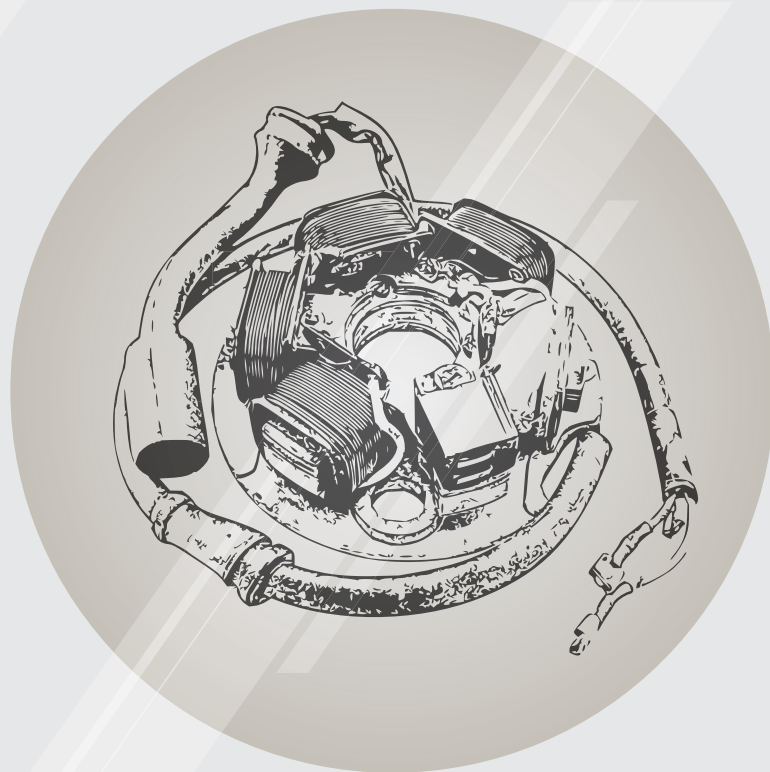

## STATORI - STATORS

246350563 **NEW**



5 bobine, 4 cavi | 5 coils, 4 wires

Lambretta 125 LI • Lambretta 125 LI Special •  
Lambretta 150 LI • Lambretta 150 LI Special  
• Lambretta 150 SX • Lambretta 175 TV 2°-3°  
serie • Lambretta 200 TV • Lambretta 200 SX



## ACCESSORI STATORI - STATORS ACCESSORIES

121858113 **NEW**



KIT PIASTRINA FISSAGGIO CAVI CARTER  
VOLANO | FLYWHEEL FIXING KIT

Lambretta LI • Lambretta DL • Lambretta TV •  
Lambretta GP • Lambretta SX



121858440 **NEW**



CHIAVETTA FRIZIONE | CLUTCH KEY

Dimensioni 6,45x15,3x4,0 mm | Dimensions  
6,45x15,3x4,0 mm

Lambretta 125-150 LI • Lambretta LI Special •  
Lambretta SX • Lambretta DL • Lambretta GP  
• Lambretta 175-200 TV • Lambretta 200 SX •  
Lambretta 200 DL



## ACCESSORI CENTRALINE - CDI ACCESSORIES

121870523 **NEW**



KIT PIASTRINA FISSAGGIO CDI E REGOLATORE  
DI TENSIONE | CDI AND REGULATOR FIXING  
BRACKET KIT

Lambretta GP



## ACCESSORI CANDELE - SPARK PLUGS ACCESSORIES

**246490010**

CAVO CANDELA | SPARK PLUG CABLE  
 Rotolo da 10 mt, Ø 7mm | Packing 10/mtrs roll,  
 Ø 7mm  
 Applicazioni varie | Various applications

**246490011****NEW**

CAVO CANDELA | SPARK PLUG CABLE  
 Rotolo da 10 mt, Ø 7mm | Packing 10/mtrs roll,  
 Ø 7mm  
 Colore Blu | Color Blue  
 Applicazioni varie | Various applications

**246490012****NEW**

CAVO CANDELA | SPARK PLUG CABLE  
 Rotolo da 10 mt, Ø 7mm | Packing 10/mtrs roll,  
 Ø 7mm  
 Colore Rosso | Color Red  
 Applicazioni varie | Various applications



## PORTALAMPADA - HOLDERS FOR BULBS

**246472170**

PORTALAMPADA FANALE ANTERIORE | FRONT  
 LIGHT BULB SOCKET

Portalamпада abbaglianti e anabbaglianti:  
 BA20d | Main and dipped beam socket BA20d

Portalamпада luce di posizione Lampada  
 tubolare | Parking light socket Festoon

Senza lampadine | Without bulbs

Lambretta 125 • Lambretta LI 150 3° serie •  
 Lambretta Special • Lambretta TV 175 2°/3°

Serie • Lambretta SX 200

R.O. 19980070



## PORTALAMPADA - HOLDERS FOR BULBS

246472180



PORTALAMPADA FANALE ANTERIORE | *FRONT LIGHT BULB SOCKET*

Lambretta LI 125 1°/2° serie • Lambretta LI 150 1°/2° serie • Lambretta TV 175 1°/2° serie  
R.O. 15080030



246472090



PORTALAMPADA PER LAMPADINE T10 WB | *HOLDER FOR T10 WB BULBS*

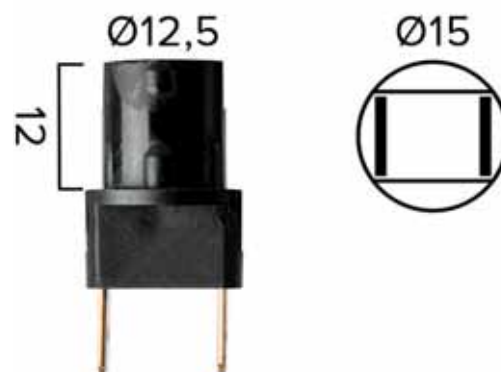

## ACCESSORI CABLAGGI - *WIRINGS ACCESSORIES*

267005000



KIT GUAINA TERMORETRAIBILE IMPERMEABILE (106 Pz) | *WATERPROOF HEAT SHRINKABLE TUBE SET (106 Pcs)*



## CONDENSATORI - *CONDENSERS*

246190110



CONDENSATORE Ø14x35 mm | *CONDENSER Ø14x35 mm*

Capacità mF 0,3 | *Capacity mF 0,3*

Lambretta 125 LI 3°/4° serie • Lambretta 125 DL • Lambretta 125 GP • Lambretta 125 Special • Lambretta 150 LI 3° serie • Lambretta LI 150 Special • Lambretta 150 SX • Lambretta 200 SX • Lambretta TV 175 • Lambretta 200 TV  
R.O. 00840060



## CONNETTORI - ELECTRICAL CONNECTORS

**246330260**

COPRI FASTON FEMMINA 6,3 mm | *FEMALE  
FASTON COVER 6,3 mm*  
Confezione 100 pz. | *100 Pcs Packing*

**246330310**

CONNETTORI PREISOLATI (7 Tipi) | *PLASTIC  
COATED CONNECTORS (7 Types)*  
Confezione 35 pz. | *35 Pcs Packing*



## CONTATTI - PLATINERS

**246150140**

PUNTINE | *CONTACT BREAKER*  
Lambretta LI • Lambretta DL

**246150110**

PUNTINE | *CONTACT BREAKER*  
Lambretta LI • Lambretta DL

**246150220**

PUNTINE | *CONTACT BREAKER*  
Lambretta LI Furgone 175 ('62>)







# TRASMISSIONE

TRANSMISSION

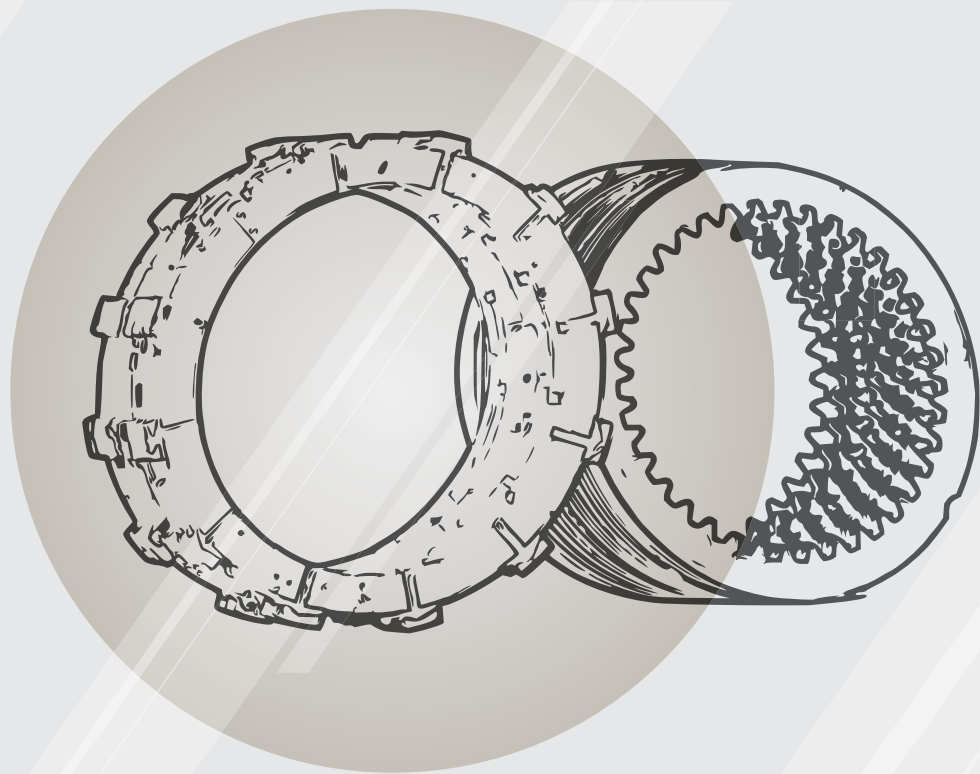

100288032



**FERODO**

Serie dischi frizione condotti e conduttori standard | *Standard friction and steel plates series*

Codice prodotto FCS0545/20 | *Product number FCS0545/20*

Composizione kit | *Kit composition*

4 Dischi conduttori

3 Dischi condotti | *4 Friction plates*

*3 Steel plates*

Lambretta LI-DL 125-150-175-200

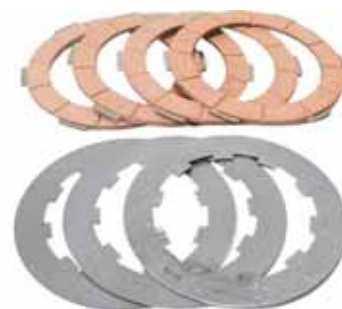

100287558



**FERODO**

Dischi frizione conduttori standard | *Standard friction plates series*

Codice prodotto FCD0545 | *Product number FCD0545*

Composizione kit | *Kit composition*

4 Dischi conduttori | *4 Friction plates*

Lambretta LI-DL 125-150-175-200



100288363



**FERODO**

Serie dischi frizione condotti e conduttori modificata | *Modified friction plates series*

Codice prodotto FCS0545/M | *Product number FCS0545/M*

Composizione kit | *Kit composition*

5 Dischi conduttori

4 Dischi condotti | *5 Friction plates*

*4 Steel plates*

Lambretta LI-DL 125-150-175-200



100288364



**FERODO**

Serie dischi frizione condotti e conduttori modificata | *Modified friction plates series*

Codice prodotto FCS0545/MO | *Product number FCS0545/MO*

Composizione kit | *Kit composition*

5 Dischi conduttori organici

4 Dischi condotti | *5 Organic friction plates*

*4 Steel plates*

Lambretta LI-DL 125-150-175-200



## DISCHI FRIZIONE - CLUTCH DISCS

**100288460****FERODO**Dischi frizione conduttori | *Friction plates series*Codice prodotto FCD0545/0 | *Product number FCD0545/0*Composizione kit | *Kit composition*4 Dischi conduttori organici | *4 Organic friction plates*

Lambretta LI-DL 125-150-175-200

**100288734****FERODO**Serie dischi frizione condotti e conduttori standard | *Standard friction and steel plates series*Codice prodotto FCS0545/2 | *Product number FCS0545/2*Composizione kit | *Kit composition*

4 Dischi conduttori

3 Dischi condotti | *4 Friction plates**3 Steel plates*

Lambretta LI-DL 125-150-175-200





# CARROZZERIA

BODY WORK



## ACCESSORI CARROZZERIA - BODYPARTS ACCESSORIES

142620080 **NEW**



COPRIRUOTA CON TASCA | *WHEEL COVER WITH POCKET*  
3-50-10  
Lambretta 125-150



## TAPPETINI IN GOMMA - FLOOR MATS

142670100



TAPPETINO IN GOMMA | *RUBBER MAT*  
Lambretta LI 3° serie



## TARGHETTE - SCUDI - FREGI - NAMEPLATES - BADGES - EMBLEMS

142720470



ETICHETTA MISCELA 2% | *2% FUEL MIXTURE LABEL*  
Dimensioni 55x10 mm | *Dimensions 55 x 10 mm*  
Confezione 10 Pz. | *10 Pcs Packing*  
R.O. 610054M003

**USARE MISCELA AL 2%**

142720480



ETICHETTA MISCELA 2% | *2% FUEL MIXTURE LABEL*  
Dimensioni 60x20 mm | *Dimensions 60x20 mm*  
Confezione 10 Pz. | *10 Pcs Packing*  
R.O. 610054M00R

**IMPORTANTE  
USARE MISCELA AL 2%**

TARGHETTE - SCUDI - FREGI - NAMEPLATES - BADGES - EMBLEMS

142720490



ETICHETTA MISCELA 5% | 5% FUEL MIXTURE LABEL

Dimensioni 60x20 mm | Dimensions 60x20 mm

Confezione 10 Pz. | 10 Pcs Packing

R.O. 61 0054M001

**IMPORTANTE**  
**USARE MISCELA AL 5%**

142721080



ETICHETTA BENZINA | FUEL LABEL

Dimensioni 60x20 mm | Dimensions 60x20 mm

**BENZINA**

142721230



TARGHETTA NON OSTRUIRE IL FORO ROSSA | RED LABEL

Confezione 4 Pz. | 4 Pcs Packing

R.O. 610176M

**IMPORTANTE**  
**NON OSTRUIRE IL FORO**

142721240



TARGHETTA NON OSTRUIRE IL FORO BLU | BLU LABEL

Confezione 4 Pz. | 4 Pcs Packing

R.O. 610176M0001

**IMPORTANTE**  
**NON OSTRUIRE IL FORO**

142720940



TARGHETTA COFANO LATERALE | SIDE PANEL NAMEPLATE

Dimensioni 212x23 mm | Dimensions 212x23 mm

Fissaggio 5 perni | Fixing 5 pins

Cromo | Chromed

Lambretta LI 3° serie

R.O. 19955051



142700010



PORTATARGA EUROPEO | *PLATE HOLDER*  
In nylon antiurto predisposto per il montaggio  
su tutte le moto e scooter | *Nylon material,*  
*suitable for all motorcycle and scooter models*

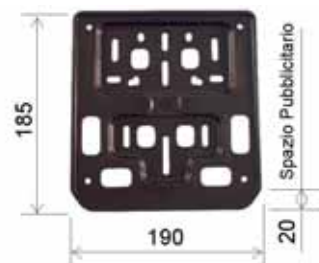

142700040



PORTATARGA EUROPEO | *PLATE HOLDER*  
Per Ciclomotori e Scooter 50 cc | *50 cc*  
*applications*  
Dimensioni 150x155 mm | *Dimensions 150x155*  
*mm*



142700070 **NEW**



PORTATARGA EUROPEO | *PLATE HOLDER*  
Per Ciclomotori e Scooter 50 cc | *50 cc*  
*applications*  
Dimensioni 150x155 mm | *Dimensions 150x155*  
*mm*  
Cromo | *Chromed*



142700390



PORTATARGA VINTAGE | *VINTAGE PLATE*  
*HOLDER*  
Dimensioni 170x170 mm | *Dimensions 170x170*  
*mm*  
Cromo | *Chromed*  
R.O. 610016M

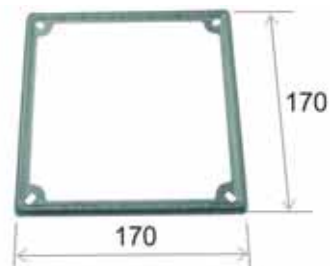

142700400



PORTATARGA VINTAGE | *VINTAGE PLATE*  
*HOLDER*  
Dimensioni 170x170 mm | *Dimensions 170x170*  
*mm*  
Nero | *Black*

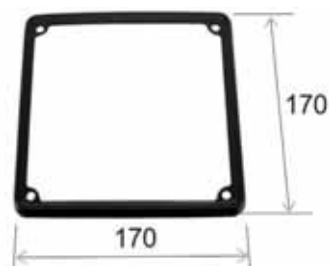



# TELAIO

CHASSIS

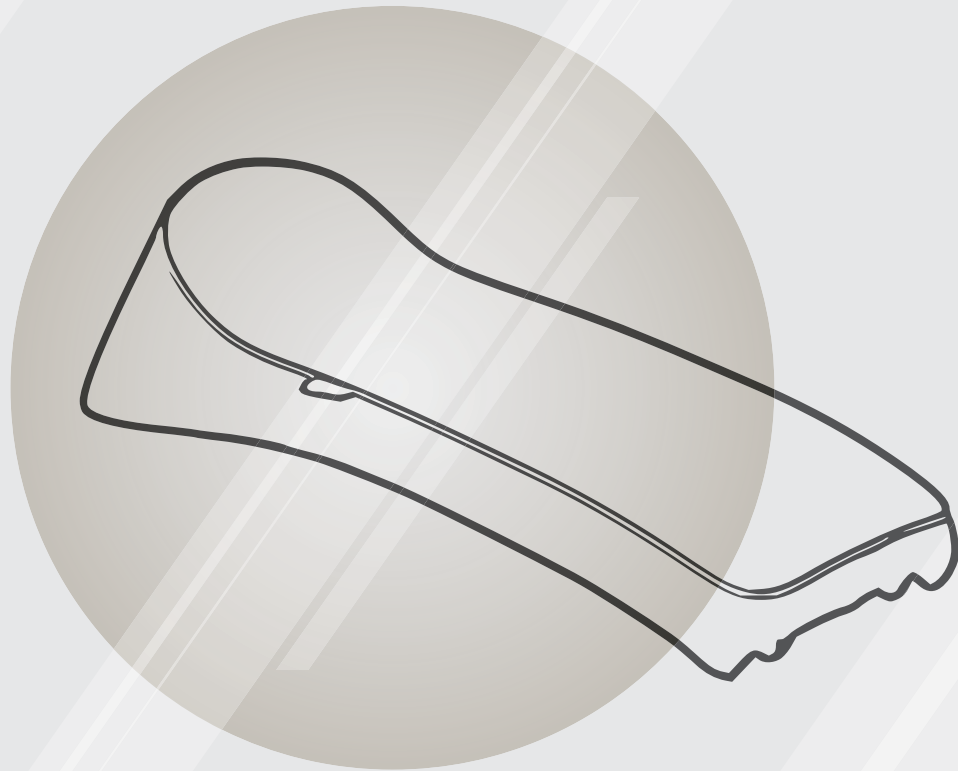

## CAVALLETTI CENTRALI - CENTRAL STANDS

**121610960**



Diametro Ø 16 mm | Diameter Ø 16 mm

Ruota 10" | Wheel 10"

Zincato | Galvanized

Lambretta DL 125-150-200 • Lambretta GP  
125-150-200 • Lambretta LI 125-150 3° serie •  
Lambretta LI Special 125-150 • Lambretta SX  
150-200 3° serie • Lambretta TV 175-200 3°  
Serie

R.O. 19957030



**121611070**



Diametro Ø 16 mm | Diameter Ø 16 mm

Zincato | Galvanized

Lambretta LI 125-150 1°/2° serie • Lambretta TV  
175 1°/2° serie

R.O. 15057010



## CONTACHILOMETRI - SPEEDOMETERS

**163681003**



Scala 80 Km/h | 80 Km/h scale

Lambretta 125-150 2° serie



## CONTACHILOMETRI - SPEEDOMETERS

**163681013**

Scala 100 Km/h | 100 Km/h scale  
 Colore quadrante Verde | Face colour Green  
 Colore cifre Nero | Color numbers Black  
 Collegamento 2,7 mm | Connection 2,7 mm  
 Avvitato | Speedometer cable: bolt-on  
 Rotondo | Round  
 Lambretta LI 2° serie  
 R.O. 00611050

**163681023**

Scala 120 Km/h | 120 Km/h scale  
 Lambretta LI 2° serie

**163681033**

Scala 100 Km/h | 100 Km/h scale  
 Colore quadrante Bianco | Face colour White  
 Colore cifre Nero | Color numbers Black  
 Lambretta LI 3° Serie  
 R.O. 00611060



**163681043**



Scala 120 Km/h | 120 Km/h scale  
 Colore quadrante Bianco | Face colour White  
 Colore cifre Nero | Color numbers Black  
 Lambretta LI 3° Serie  
 R.O. 00611060



**163681053**



Scala 140 Km/h | 140 Km/h scale  
 Colore quadrante Bianco | Face colour White  
 Colore cifre Nero | Color numbers Black  
 Lambretta Li 3° Serie  
 R.O.611125



**163681063**



Scala 100 Km/h | 100 Km/h scale  
 Colore quadrante Bianco | Face colour White  
 Colore cifre Nero | Color numbers Black  
 Collegamento 2,7 mm | Connection 2,7 mm  
 Avvitato | Speedometer cable: bolt-on  
 Lambretta DL 125  
 R.O. 00611123



## CONTACHILOMETRI - SPEEDOMETERS

**163681073**

Scala 120 Km/h | 120 Km/h scale  
 Colore quadrante Bianco | Face colour White  
 Colore cifre Nero | Color numbers Black  
 Collegamento 2,7 mm | Connection 2,7 mm  
 Avvitato | Speedometer cable: bolt-on  
 Lambretta DL 150  
 R.O. 00611123

**163681083**

Scala 140 Km/h | 140 Km/h scale  
 Colore quadrante Bianco | Face colour White  
 Colore cifre Nero | Color numbers Black  
 Collegamento 2,7 mm | Connection 2,7 mm  
 Avvitato | Speedometer cable: bolt-on  
 Lambretta DL 200  
 R.O. 611124



## KIT CAVI TRASMISSIONE - TRANSMISSION CABLES KITS

**KIT TRASMISSIONI COMPLETE LAMBRETTA**

LAMBRETTA COMPLETE TRANSMISSION KIT



Modello Model	CC	Codice RMS RMS Code	Codice a barre Barcode	Tipo Type	Colore Colour
Lambretta DL	125-150-200	<b>163620250</b>		Standard	Nero   Black
Lambretta LI	125-150-200	<b>163620260</b>		Teflon	Grigio   Grey
Lambretta DL	125-150-200	<b>163620270</b>		Teflon	Nero   Black

**121858010**



MORSETTO CON VITE LATERALE | CLAMPS  
WITH SIDE SCREW

Ø 7x11 - M4

Per cavo frizione Ø 1,9 mm | For clutch cable Ø 1,9 mm

Confezione 10 pz. | 10 Pcs Packing



**121858020**



MORSETTO CON VITE LATERALE | CLAMPS  
WITH SIDE SCREW

Ø 8x12 - M4

Per cavo frizione Ø 2,5 mm | For clutch cable Ø 2,5 mm

Confezione 10 pz. | 10 Pcs Packing



**121858030**



MORSETTO CON VITE LATERALE | CLAMPS  
WITH SIDE SCREW

Ø 12x18 - M5

Per cavo frizione Ø 3 mm | For clutch cable Ø 3 mm

Confezione 10 pz. | 10 Pcs Packing



**121858040**



MORSETTO CAVO GAS | THROTTLE CABLE  
CLAMPS

Ø 5,5x7,3 - M4

Tipo Magura | Magura type

Confezione 10 pz. | 10 Pcs Packing



**121858050**



MORSETTO CAVO GAS | THROTTLE CABLE  
CLAMPS

Ø 5,5x6 - Filetto 1/8

Super pratic

Confezione 10 pz. | 10 Pcs Packing



## REGISTRI CAVI - CABLE REGISTERS

121858130



REGISTRO CAVO Ø 5 MM | ADJUSTING SCREW  
 Ø 5 MM  
 Esagono 8 mm | Hexagon 8 mm  
 M5x31 mm | M5x31 mm  
 Confezione 10 pz. | 10 Pcs Packing  
 R.O. 090527, 020105



121858150



REGISTRO CAVO Ø 8 MM | ADJUSTING SCREW  
 Ø 8 MM  
 Esagono 12 mm | Hexagon 12 mm  
 M8x40 mm | M8x40 mm  
 Confezione 10 pz. | 10 Pcs Packing



121858260



REGOLATORE M5 | M5 ADJUSTING SCREW  
 Confezione 10 pz. | 10 Pcs Packing



121858270



REGOLATORE M6 | M6 ADJUSTING SCREW  
 Confezione 5 pz. | 5 Pcs Packing



121858300



REGOLATORE M10 | M10 ADJUSTING SCREW  
 Confezione 5 pz. | 5 Pcs Packing  
 M10x1.25 | M10x1.25



### GUAINA CON SPIRALE IN ACCIAIO TONDO (TIPO ITALIA) - OUTER CABLE ROUND WIRE (ITALIAN TYPE)

**163530400**



Colore Nero | *Colour Black*  
 Misura 50/mtrs roll | *Size 50/mtrs roll*  
 Foro interno 2,5 mm | *Inside hole 2,5 mm*  
 Diametro esterno 4,5 mm | *Outside diameter 4,5 mm*  
 Diametro esterno con rivestimento 5,2 mm | *Outside hole with rubber 5,2 mm*



**163530401**



Colore Grigio | *Colour Grey*  
 Misura 50/mtrs roll | *Size 50/mtrs roll*  
 Foro interno 2,5 mm | *Inside hole 2,5 mm*  
 Diametro esterno 4,5 mm | *Outside diameter 4,5 mm*  
 Diametro esterno con rivestimento 5,2 mm | *Outside hole with rubber 5,2 mm*



**163530411**



Colore Grigio millerighe | *Colour Grey grooved*  
 Misura 50/mtrs roll | *Size 50/mtrs roll*  
 Foro interno 2,5 mm | *Inside hole 2,5 mm*  
 Diametro esterno 4,5 mm | *Outside diameter 4,5 mm*  
 Diametro esterno con rivestimento 5,2 mm | *Outside hole with rubber 5,2 mm*



**163530500**



Colore Nero | *Colour Black*  
 Misura 50/mtrs roll | *Size 50/mtrs roll*  
 Foro interno 3 mm | *Inside hole 3 mm*  
 Diametro esterno 5 mm | *Outside diameter 5 mm*  
 Diametro esterno con rivestimento 5,8 mm | *Outside hole with rubber 5,8 mm*





## GUAINA - OUTER CABLES

**163530600**

Colore Nero | *Colour Black*  
 Misura 25/mtrs roll | *Size 25/mtrs roll*  
 Foro interno 3,5 mm | *Inside hole 3,5 mm*  
 Diametro esterno 6 mm | *Outside diameter 6 mm*  
 Diametro esterno con rivestimento 7 mm | *Outside hole with rubber 7 mm*

**163530700**

Colore Nero | *Colour Black*  
 Misura 25/mtrs roll | *Size 25/mtrs roll*  
 Foro interno 4,2 mm | *Inside hole 4,2 mm*  
 Diametro esterno 7 mm | *Outside diameter 7 mm*  
 Diametro esterno con rivestimento 8 mm | *Outside hole with rubber 8 mm*



## CAPIGUAINA - CABLE ENDS

**421830201**

CAPOGUAINA Ø 5,5 x 9,5 MM | *CABLE ENDS Ø 5,5 x 9,5 MM*  
 Confezione 10 pz. | *10 Pcs Packing*

**121858190**

CAPOGUAINA Ø 6 x 10 MM | *CABLE ENDS Ø 6 x 10 MM*  
 Confezione 50 pz. | *50 Pcs Packing*

**121858200**

CAPOGUAINA Ø 7 x 11 MM | *CABLE ENDS Ø 7 x 11 MM*  
 Confezione 50 pz. | *50 Pcs Packing*



## CAPIGUAINA - CABLE ENDS

**421830211**



CAPOGUAINA Ø 5 x 9,5 MM NICHELATA |  
 NICHEL - PLATED CABLE ENDS Ø 5 x 9,5 MM  
 Confezione 10 pz. | 10 Pcs Packing



**121858210**



BUSSOLA GUAINA Ø 4,5 MM | CABLE END Ø  
 4,5 MM  
 Dimensioni 7x9 mm | Dimensions 7x9 mm  
 Confezione 20 pz. | 20 Pcs Packing



## PEDIVELLE MESSA IN MOTO - KICK STARTER LEVERS

**121530223**



Alluminio | Aluminium  
 Lambretta LI 3° serie



## CERCHI - WHEELRIMS

**225000019**



Colore Grigio | Colour Grey  
 Dimensioni 7x9 mm 2.10 Ø 10" | Dimensions  
 2.10 Ø 10"  
 Lambretta LI 3° serie  
 R.O. 19944034



## SELLE - SEATS

142760050



Scocca in vetroresina | *Fiberglass shell*  
 Rivestimento con due tipi diversi di similpelle e  
 bordino grigio | *Cover with two different types  
 of leatherette and grey piping*  
 Chiusura con magnete | *Closure with magnet*  
 Lambretta LI-Special-GP-DL 125 • Lambretta  
 LI-Special-SX-GP 150 • Lambretta TV 175 •  
 Lambretta TV-SX-GP-DL 200



## ACCESSORI SELLE - SEATS ACCESSORIES

142760095



COPRISELLA ANTERIORE | *FRONT SEAT COVER*  
 Lambretta LD 125-150 ('54-'57)



142760096



COPRISELLA POSTERIORE | *REAR SEAT COVER*  
 Lambretta LD 125-150 ('54-'57)



142760097



COPRISELLA ANTERIORE | *FRONT SEAT COVER*  
 Lambretta 125-150 LI 1°/2°/3° serie



142760098



COPRISELLA POSTERIORE | REAR SEAT COVER

Lambretta 125-150 LI 1°/2°/3° serie



# SOSPENSIONI

S U S P E N S I O N S

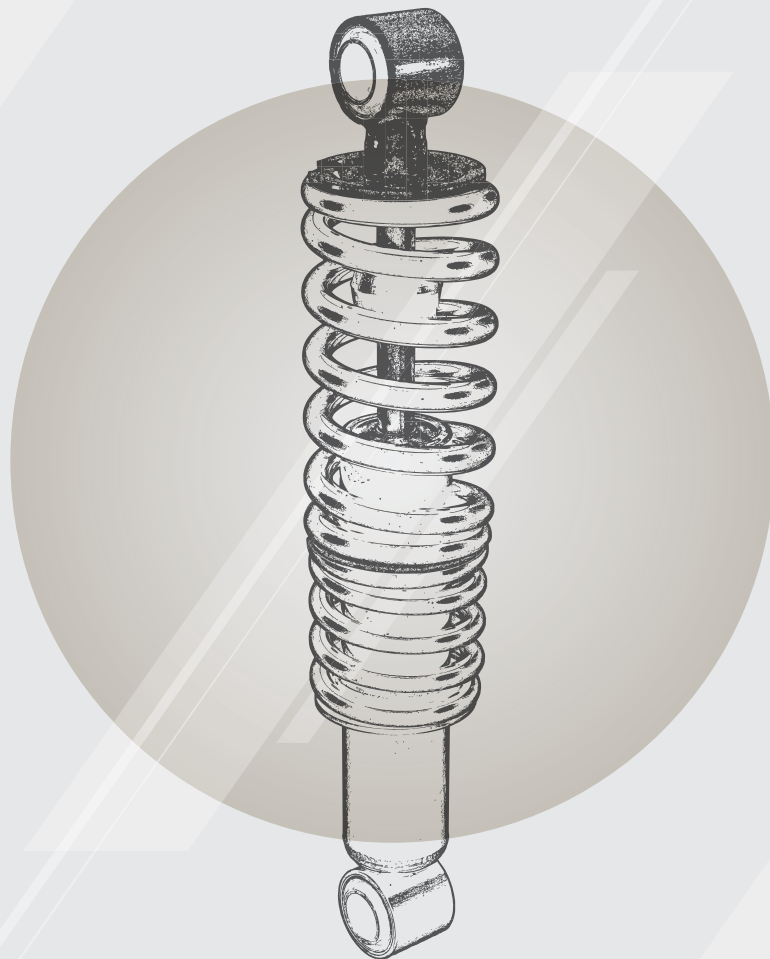

**204560252**



Lambretta LI 125-150-200 3° serie  
R.O. 19958100

LUNGHEZZA LENGTH (mm)	ATTACCO SUPERIORE UPPER FASTENING POINT			ATTACCO INFERIORE LOWER FASTENING POINT		
	TIPO - TYPE	D (mm)	W (mm)	TIPO - TYPE	D (mm)	W (mm)
305		18	33		18	33



**204560262**



Lambretta LI 150 2° serie

LUNGHEZZA LENGTH (mm)	ATTACCO SUPERIORE UPPER FASTENING POINT			ATTACCO INFERIORE LOWER FASTENING POINT		
	TIPO - TYPE	D (mm)	W (mm)	TIPO - TYPE	D (mm)	W (mm)
317		18	33		18	33



**204560292**



Lambretta LI 125-150-200 3° serie  
R.O. 19958100

LUNGHEZZA LENGTH (mm)	ATTACCO SUPERIORE UPPER FASTENING POINT			ATTACCO INFERIORE LOWER FASTENING POINT		
	TIPO - TYPE	D (mm)	W (mm)	TIPO - TYPE	D (mm)	W (mm)
305		18	33		18	33



AMMORTIZZATORI - SHOCK ABSORBERS

204585123



Lambretta LI 125-150-200 3° serie  
R.O. 19060290

LUNGHEZZA LENGTH (mm)	ATTACCO SUPERIORE UPPER FASTENING POINT			ATTACCO INFERIORE LOWER FASTENING POINT		
	TIPO - TYPE	D (mm)	W (mm)	TIPO - TYPE	D (mm)	W (mm)
237		6	22,2		6	22,2



204585133



Lambretta LI 125-150-200 3° serie  
R.O. 19060290

LUNGHEZZA LENGTH (mm)	ATTACCO SUPERIORE UPPER FASTENING POINT			ATTACCO INFERIORE LOWER FASTENING POINT		
	TIPO - TYPE	D (mm)	W (mm)	TIPO - TYPE	D (mm)	W (mm)
237		6	22,2		6	22,2







# CUSCINETTI

BEARINGS



**100200883**



Misure (mm) 25 - 52/56 - 18 | Size (mm) 25 - 52/56 - 18

Ruota posteriore | Rear wheel

Lambretta LI

R.O. 19030050



**100200170**



Misure (mm) 25 - 62 - 17 (6305-C5) | Size (mm) 25 - 62 - 17 (6305-C5)

Albero motore lato frizione | Crankshaft clutch side

Gabbia in acciaio | Steel cage

Lambretta 125 LI • Lambretta 125 Special

• Lambretta 125 GP • Lambretta 125 DL •

Lambretta 150 LI • Lambretta 150 Special

• Lambretta 150 SX • Lambretta 150 GP •

Lambretta 175 TV 2°-3° serie • Lambretta 200

TV • Lambretta 200 SX • Lambretta 200 GP •

Lambretta 200 DL

R.O. 169809 (Piaggio)



G O M M E

T I R E S



997000160



**Continental**

Misura 3.00 - 10 | *Size 3.00 - 10*  
 Battistrada Contitwist | *Tread Contitwist*  
 Cod. Continental 0220014  
 Indice di Carico 50 | *Load Index 50*  
 Indice di velocità M | *Speed Index M*  
 Coperture TL (Tubeless) | *Tyres TL (Tubeless)*



997000310



**Continental**

Misura 3.50 - 10 | *Size 3.50 - 10*  
 Battistrada Contitwist | *Tread Contitwist*  
 Cod. Continental 0240101  
 Indice di Carico 59 | *Load Index 59*  
 Indice di velocità M | *Speed Index M*  
 Coperture TL (Tubeless) | *Tyres TL (Tubeless)*



991100011



**KENDA**

Misura 3.00-10 | *Size 3.00-10*  
 Battistrada Mich 83 | *Tread Mich 83*  
 Pattern K333  
 Indice di Carico 50 | *Load Index 50*  
 Indice di velocità J | *Speed Index J*  
 Coperture TT (Set copertura + camera) | *Tyres TT (Kit tyre and inner tube)*



991100015



**KENDA**

Misura 3.00-10 | *Size 3.00-10*  
 Battistrada Fascia Bianca | *Tread Fascia Bianca*  
 Pattern K333  
 Indice di Carico 50 | *Load Index 50*  
 Indice di velocità J | *Speed Index J*  
 Coperture TL (Tubeless) | *Tyres TL (Tubeless)*



## GOMME - TIRES

991100030 **NEW****KENDA**

Misura 3.00-10 | Size 3.00-10

Pattern K303

Indice di Carico 42 | Load Index 42

Indice di velocità J | Speed Index J

Coperture TT (Set copertura + camera) | Tyres

TT (Kit tyre and inner tube)



K303 A

991100102

**KENDA**

INVERNALE | WINTER

Misura 3.00-10 | Size 3.00-10

Battistrada Mich M+S | Tread Mich M+S

Pattern K701

Indice di Carico 47 | Load Index 47

Indice di velocità L | Speed Index L

Coperture TL (Tubeless) | Tyres TL (Tubeless)

K701  
M+S991100021 **NEW****KENDA**

Misura 3.00-10 | Size 3.00-10

Battistrada - | Tread -

Pattern K711

Indice di Carico 47 | Load Index 47

Indice di velocità L | Speed Index L

Coperture TL (Tubeless) | Tyres TL (Tubeless)



K711

991200102

**KENDA**

INVERNALE | WINTER

Misura 3.50-10 | Size 3.50-10

Battistrada Mich M+S | Tread Mich M+S

Pattern K701

Indice di Carico 56 | Load Index 56

Indice di velocità L | Speed Index L

Coperture TL (Tubeless) | Tyres TL (Tubeless)

K701  
M+S

991200001



### **KENDA**

Misura 3.50-10 | Size 3.50-10

Battistrada Mich 83 | Tread Mich 83

Pattern K333

Indice di Carico 51 | Load Index 51

Indice di velocità J | Speed Index J

Coperture TT (Set copertura + camera) | Tyres

TT (Kit tyre and inner tube)



991200003



### **KENDA**

Misura 3.50-10 | Size 3.50-10

Battistrada Fascia Bianca | Tread Fascia Bianca

Pattern K333

Indice di Carico 51 | Load Index 51

Indice di velocità J | Speed Index J

Coperture TL (Tubeless) | Tyres TL (Tubeless)



991200010 **NEW**



### **KENDA**

Misura 3.50-10 | Size 3.50-10

Battistrada - | Tread -

Pattern K711

Indice di Carico 56 | Load Index 56

Indice di velocità L | Speed Index L

Coperture TL (Tubeless) | Tyres TL (Tubeless)



991200015 **NEW**



### **KENDA**

Misura 3.50-10 | Size 3.50-10

Pattern K303

Indice di Carico 51 | Load Index 51

Indice di velocità J | Speed Index J

Coperture TT (Set copertura + camera) | Tyres

TT (Kit tyre and inner tube)



## GOMME - TIRES

991103001

**DURO**

Misura 3.00-10 | Size 3.00-10

Battistrada Rock | Tread Rock

Pattern HF204A

N° Tele 4

Indice di Carico Non omologata | Load Index

Not homologated

Indice di velocità Non omologata | Speed Index

Not homologated

Coperture TT (Set copertura + camera) | Tyres

TT (Kit tyre and inner tube)

VALVOLE TR87 | VALVES TR87



991203001

**DURO**

Misura 3.50-10 | Size 3.50-10

Battistrada Rock | Tread Rock

Pattern HF204

N° Tele 4

Indice di Carico Non omologata | Load Index

Not homologated

Indice di velocità Non omologata | Speed Index

Not homologated

Coperture TT (Set copertura + camera) | Tyres

TT (Kit tyre and inner tube)

VALVOLE TR87 | VALVES TR87



## CAMERE D'ARIA - TUBES

999100000

**KENDA**

Misura 3.50-8 | Size 3.50-8

Valvola TR 13 | Valve TR 13

Valvola vulcanizzata | Vulcanized valve



999100100



### **KENDA**

Misura 3.50-8 | Size 3.50-8  
 Valvola TR 87 | Valve TR 87  
 Valvola vulcanizzata | Vulcanized valve



999200001



### **KENDA**

Misura 3.00/3.50-10 | Size 3.00/3.50-10  
 Valvola TR 87 | Valve TR 87  
 Valvola vulcanizzata | Vulcanized valve





# CICLOMOTORE-MOPED

689	<b>ASPIRAZIONE</b>	INTAKE SYSTEM	SISTEMA DE ADMISION	SYSTÈME D'ADMISSION
691	<b>ALIMENTAZIONE</b>	FUEL SYSTEM	SISTEMA DE COMBUSTIBLE	SYSTÈME D'ALIMENTATION
699	<b>MOTORE</b>	ENGINE	MOTOR	MOTEUR
707	<b>SCARICO</b>	EXHAUST SYSTEM	SISTEMA DE ESCAPE	SYSTÈME D'ÉCHAPPEMENT
709	<b>IMPIANTO FRENANTE</b>	BRAKING SYSTEM	SISTEMA DE FRENADOS	SYSTÈME DE FREINAGE
711	<b>IMPIANTO ELETTRICO</b>	ELECTRICAL SYSTEM	INSTALACION ELECTRICA	SYSTÈME ÉLECTRIQUE
721	<b>TRASMISSIONE</b>	TRANSMISSION	TRANSMISIÓN	TRANSMISSION
725	<b>CARROZZERIA</b>	BODY WORK	CARROCERIA	CARROSSERIE
731	<b>TELAIO</b>	CHASSIS	CHASIS	CHASSIS
753	<b>CUSCINETTI</b>	BEARINGS	COJINETES	ROULEMENT
757	<b>TENUTA</b>	TIGHT SYSTEM	SISTEMA DE RETENES	SYSTÈME DE JOINTS
759	<b>GOMME</b>	TIRES	NEUMATICOS	PNEUS
765	<b>OFFICINA</b>	WORKSHOP	TALLER	ATELIER





# ASPIRAZIONE

INTAKE SYSTEM



# CICLOMOTORE - MOPED

## FILTRI ARIA - AIR FILTERS

**100602970**



Colore Nero | *Color Black*

Completo di fascetta | *Complete with clamp*

Rete metallica interna | *Internal wire mesh*

Boss • Bravo 3 • Bravo Erre 2 • Ciao • Ciao Euro

1 • Ciao Euro 2 • Ciao Mix Teen • Grillo • Si • Si

FI2 • Si Mix • Superbravo • Superbravo 3

R.O. 1834235



# ALIMENTAZIONE

FUEL SYSTEM

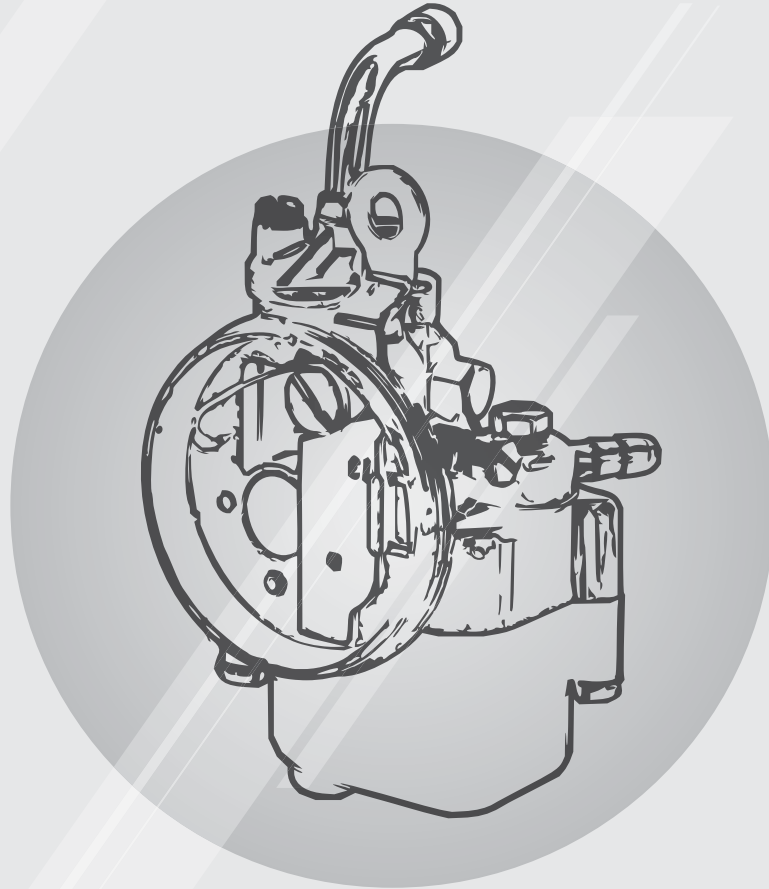

# CICLOMOTORE - MOPED

## CARBURATORI - CARBURETORS

121700039 **NEW**



**DELL'ORTO**

SHA 12-10

Codice Dell'Orto 01821 | *Dell'Orto part number 01821*

Getto massimo 42 | *Main jet 42*

Ciao P • Ciao PX

R.O. 188237

### PRODOTTI CORRELATI | RELATED PRODUCTS



121700001



121700040 **NEW**



**DELL'ORTO**

SHA 12-12

Codice Dell'Orto 01800 | *Dell'Orto part number 01800*

Getto massimo 49 | *Main jet 49*

Si

R.O. 164148

### PRODOTTI CORRELATI | RELATED PRODUCTS



121700001



121700041 **NEW**



**DELL'ORTO**

SHA 12-12

Codice Dell'Orto 02035 | *Dell'Orto part number 02035*

Getto massimo 48 | *Main jet 48*

Ciao P • Ciao PX

R.O. 247287

### PRODOTTI CORRELATI | RELATED PRODUCTS



121700001



CARBURATORI - CARBURETORS

121700042 **NEW**



**DELL'ORTO**

SHA 13-13  
 Codice Dell'Orto 01851 | *Dell'Orto part number 01851*  
 Getto massimo 66 | *Main jet 66*  
 Si

PRODOTTI CORRELATI | RELATED PRODUCTS



121700001



121700043 **NEW**



**DELL'ORTO**

SHA 13-13  
 Codice Dell'Orto 02044 | *Dell'Orto part number 02044*  
 Getto massimo 66 | *Main jet 66*  
 Ciao PX

PRODOTTI CORRELATI | RELATED PRODUCTS



121700001



121700044 **NEW**



**DELL'ORTO**

SHA 13-13  
 Codice Dell'Orto 02046 | *Dell'Orto part number 02046*  
 Getto massimo 66 | *Main jet 66*  
 Ciao

PRODOTTI CORRELATI | RELATED PRODUCTS



121700001



## CARBURATORI - CARBURETORS

121700045 **NEW**



**DELL'ORTO**

SHA 14-12

Codice Dell'Orto 01515 | *Dell'Orto part number 01515*

Getto massimo 57 | *Main jet 57*

Piaggio vari modelli - *various model*

PRODOTTI CORRELATI | *RELATED PRODUCTS*



121700002



121700046 **NEW**



**DELL'ORTO**

SHA 15-15

Codice Dell'Orto 02043 | *Dell'Orto part number 02043*

Getto massimo 68 | *Main jet 68*

Piaggio FMB • Garelli

PRODOTTI CORRELATI | *RELATED PRODUCTS*



121700002



121700047 **NEW**



**DELL'ORTO**

SHA 15-15G

Codice Dell'Orto 02013 | *Dell'Orto part number 02013*

Getto massimo 68 | *Main jet 68*

Garelli

PRODOTTI CORRELATI | *RELATED PRODUCTS*



121700002





RUBINETTI BENZINA - FUEL TAPS

121670080



Si  
R.O. 254724



121670090



Ciao • Ciao PX  
R.O. 143559



121670280



7 mm  
Universale | *Universal*



# CICLOMOTORE - MOPED

## FILTRI CARBURANTE - FUEL FILTERS

**100607000**



FILTRO BENZINA | FUEL FILTER

Attacco tubo Ø 6-8 mm | Pipe attack Ø 6-8 mm

Elemento filtrante in carta | Paper filter

Confezione 10 pz. | 10 Pcs Packing

Applicazioni varie | Various applications



**100607010**



FILTRO BENZINA | FUEL FILTER

Attacco tubo Ø 7 mm | Pipe attack Ø 7 mm

Confezione 10 pz. | 10 Pcs Packing

Applicazioni varie | Various applications



## SERBATOI BENZINA E ACCESSORI - FUEL TANKS AND ACCESSORIES

**121650030**



TAPPO SERBATOIO BENZINA (CON  
GUARNIZIONE) | FUEL CAP (WITH GASKET)

Confezione 5 pz. | 5 Pcs Packing

Ciao P • Ciao PX

R.O. 182356



**121650080**



TAPPO SERBATOIO | FUEL CAP

Ciao ('80-'99) • Grillo ('89-'93)

R.O. 2705865



## ACCESSORI CARBURATORE - CARBURETOR ACCESSORIES

**121680110**



SPILO CARBURATORE Triangolare | FLOAT  
NEEDLE 3 sided

Boss • Bravo • Ciao • Grillo • Si • Superbravo

R.O. 247653



ACCESSORI CARBURATORE - CARBURETOR ACCESSORIES

121830330



TAPPO VASCHETTA CARBURATORE | RUBBER  
 PLUG CARBURATOR CAISING  
 Confezione 5 pz. | 5 Pcs Packing  
 Si • Si FL2 • Si Mix  
 R.O. 050274



121859030



FASCETTA BANDA PIENA Ø 15-25 mm | CLAMP  
 Ø 15-25 mm  
 Confezione 5 pz. | 5 Pcs Packing  
 Applicazioni varie | Various applications



121859040



FASCETTA BANDA PIENA Ø 20-32 mm | CLAMP  
 Ø 20-32 mm  
 Confezione 10 pz. | 10 Pcs Packing  
 Applicazioni varie | Various applications



121859050



FASCETTA BANDA PIENA Ø 32-50 mm | CLAMP  
 Ø 32-50 mm  
 Confezione 10 pz. | 10 Pcs Packing  
 Applicazioni varie | Various applications



121859060



FASCETTA BANDA PIENA Ø 50-70 mm | CLAMP  
 Ø 50-70 mm  
 Confezione 10 pz. | 10 Pcs Packing  
 Applicazioni varie | Various applications





# MOTORE

ENGINE

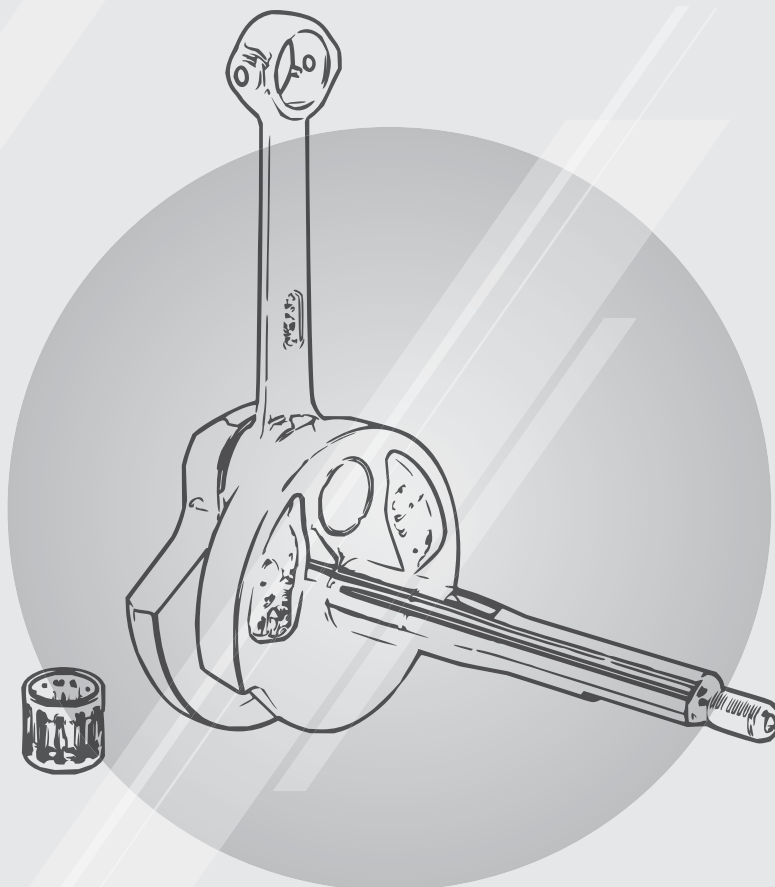

# CICLOMOTORE - MOPED

## ALBERI MOTORE - CRANKSHAFTS

100010210 **NEW**



TIPO STANDARD | STANDARD TYPE

Spinotto Ø 10 mm | Ø 10 mm pin

Gabbia a rulli inclusa | Roller cage included

Corsa 43,00 mm | Stroke 43,00 mm

Ciao • Si D10 • Bravo • Superbravo • Grillo •

Boss

R.O. 184154

### PRODOTTI CORRELATI | RELATED PRODUCTS



100200780 SKF



100150050



100010220 **NEW**



TIPO STANDARD | STANDARD TYPE

Spinotto Ø 12 mm | Ø 12 mm pin

Gabbia a rulli inclusa | Roller cage included

Corsa 43,00 mm | Stroke 43,00 mm

Ciao • Si • Bravo • Superbravo • Grillo • Boss

R.O. 113708

### PRODOTTI CORRELATI | RELATED PRODUCTS



100200780 SKF



100150150



## ALBERI MOTORE - CRANKSHAFTS

100012015

NEW



ANTICIPATO | RACING

Spinotto Ø 10 mm | Ø 10 mm pin

Gabbia a rulli inclusa | Roller cage included

Corsa 43,00 mm | Stroke 43,00 mm

Valvola a disco rotante | Rotating disc valve

Biella: 87,0mm | Connecting rod: 87,0mm

Standard - biella cono 20/20mm, M12

TUNING ROAD - affidabile e per uso quotidiano

| Standard - cone 20 / 20mm, M12

TUNING ROAD - reliable and for everyday use

Codice fornitore AMT 004 | Supplier code

AMT 004

Ciao • Si D10 • Bravo • Superbravo • Grillo • Boss

R.O. 184154



100012016

NEW



ANTICIPATO | RACING

Spinotto Ø 12 mm | Ø 12 mm pin

Gabbia a rulli inclusa | Roller cage included

Corsa 43,00 mm | Stroke 43,00 mm

Valvola a disco rotante | Rotating disc valve

fasatura: 120°/100° a pms | Timing: 120° / 100° at pms

TUNING ROAD - affidabile e per uso quotidiano

| TUNING ROAD - reliable and for everyday use

Codice fornitore AMT 156 | Supplier code

AMT 156

Ciao • Si • Bravo • Superbravo • Grillo • Boss

R.O. 113708



# CICLOMOTORE - MOPED

## ALBERI MOTORE - CRANKSHAFTS

100012018 **NEW**



TIPO STANDARD | *STANDARD TYPE*

Gabbia a rulli inclusa | *Roller cage included*

Codice fornitore AMT 036 | *Supplier code*

AMT 036

Motobecane Mobylette 50cc



100012019 **NEW**



TIPO STANDARD | *STANDARD TYPE*

Gabbia a rulli inclusa | *Roller cage included*

Codice fornitore AMT 040 | *Supplier code*

AMT 040

Peugeot 103-104





## ALBERI MOTORE - CRANKSHAFTS

100012020 **NEW**

TIPO STANDARD | *STANDARD TYPE*  
 Gabbia a rulli inclusa | *Roller cage included*  
 Peugeot 48cc  
 Codice fornitore AMT 100 | *Supplier code*  
 AMT 100

100012026 **NEW**

TIPO STANDARD | *STANDARD TYPE*  
 Gabbia a rulli inclusa | *Roller cage included*  
 Peugeot 103 accensione elettronica - *with*  
*digital ignition*  
 Codice fornitore AMT 214 | *Supplier code*  
 AMT 214



# CICLOMOTORE - MOPED

## CILINDRI EVOK - EVOK CYLINDERS

### MOTORE PIAGGIO CIAO - PIAGGIO ENGINE CIAO

100081270



**EVOX**

Ø38,2 mm  
Spinotto Ø10 mm | Piston pin Ø10 mm  
Ciao

#### RICAMBI | SPARE PARTS



100091274 - 38,4 mm



100101244 - 38,4 mm



100684000



100081240



**EVOX**

Ø38,2 mm  
Spinotto Ø12 mm | Piston pin Ø12 mm  
Ciao

#### RICAMBI | SPARE PARTS



-



-



100684000



100081200



**EVOX**

Ø43 mm  
Spinotto Ø10 mm | Piston pin Ø10 mm  
Utilizzo esclusivo per uso agonistico | *Only for racing use*  
Ciao

#### RICAMBI | SPARE PARTS



-



-



100689640



## TESTE CILINDRO - CYLINDER HEADS

100070120



PER CILINDRO PIAGGIO 100081270 | FOR

PIAGGIO CYLINDER 100081270

Ø38,2 mm

Ciao

R.O. 124533



## PISTONI - FASCE ELASTICHE EVOK - EVOK PISTON - PISTON RINGS

Applicazioni <i>Applications</i>	CC	PISTONI COMPLETI PER CILINDRI RMS <i>PISTONS FOR RMS CYLINDERS</i>			KIT FASCE ELASTICHE PER PISTONI RMS <i>PISTON RINGS FOR RMS PISTONS</i>		
		Ø pistone mm <i>Ø piston mm</i>	Codice RMS <i>RMS Code</i>	Codice a barre <i>Barcode</i>	Ø fasce elastiche mm <i>Ø piston rings mm</i>	Codice RMS <i>RMS Code</i>	Codice a barre <i>Barcode</i>
Motore Piaggio Ciao, Si, Bravo e Grillo 50cc - Spinotto 10 mm   Piaggio Ciao, Si, Bravo and Grillo engine 50cc - Pin 10 mm	50	38,4	100091274		38,4	100101244	

## KIT REVISIONE ALBERO MOTORE - CRANKSHAFT REVISION KIT

100200780



2	Cuscinetti   Bearings SKF	15-35-11
1	Paraolio   Oil seal	15-24-5



Ciao • Si



# CICLOMOTORE - MOPED

## RUOTE LIBERE AVVIAMENTO - STARTER WHEELS

PIAGGIO

525260140



Ruota Libera Z 18 | *Freewheel Z 18*

Ciao • Ciao Mix Teen • Ciao Tre • Si FL2 • Si Mix

• Bravo Erre 2

R.O. 103631



525260120



Ruota Libera Z 16 | *Freewheel Z 16*

Bravo • Si

R.O. 114531



## MOLLE MESSA IN MOTO - STARTER SPRINGS

121890070



KIT MOLLE FRIZIONE | *CLUTCH SPRING KIT*

Confezione 50 Pz | *50 Pcs Packing*

Ciao • Si • Grillo • Bravo Erre 2 • Boxer •

R.O. 121753



## COPRIVENTOLA - FAN COVER

142580240 **NEW**



COPERCHIO VOLANO | *FLYWHEEL COVER*

Ciao • Bravo • Si

R.O. 133658



# SCARICO

EXHAUST SYSTEM

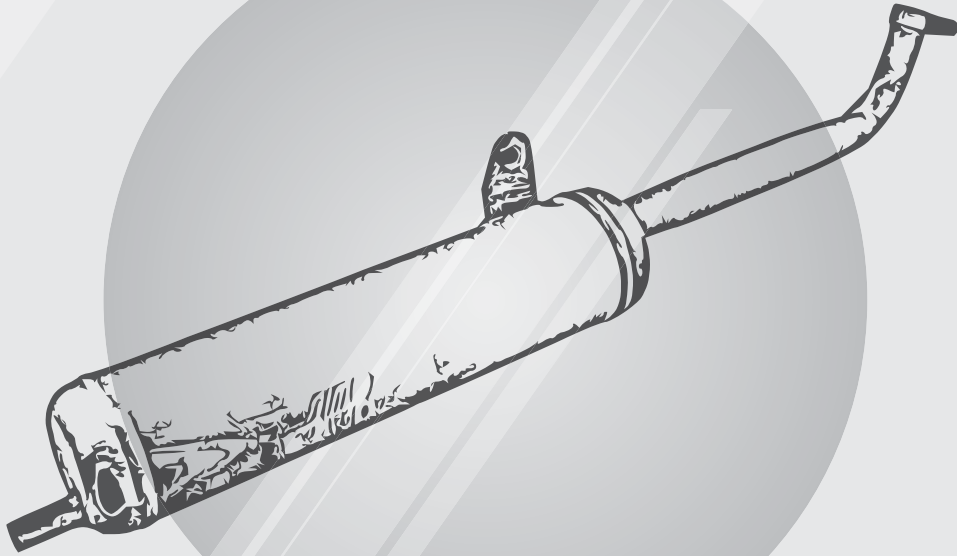

# CICLOMOTORE - MOPED

## MARMITTE - TUBI SCARICO - MUFFLERS

100751110



Ciao ('80-'88)  
R.O. 2472605



100751120



Si ('79-'88)  
R.O. 2144034



## ACCESSORI MARMITTE - TUBI DI SCARICO - MUFFLERS ACCESSORIES

100720010



CARTUCCIA LANA DI ROCCIA Ø60x170 mm |  
ROCKWOOL CATRIDGE Ø60x170 mm



100720020



CARTUCCIA LANA DI ROCCIA Ø80x300 mm |  
ROCKWOOL CATRIDGE Ø80x300 mm



100720030



FOGLIO LANA DI ROCCIA 600x320x30 mm |  
ROCKWOOL SHEET 600x320x30 mm



# IMPIANTO FRENANTE

BRAKING SYSTEM



# CICLOMOTORE - MOPED

## GANASCE FRENO - BRAKE SHOES

225120190



Anteriore | *Front*

Ciao • Si • Bravo • Superbravo • Boxer

Per modelli a cerchi a raggio - *For spoked rims models*

R.O. 114408 - 498427

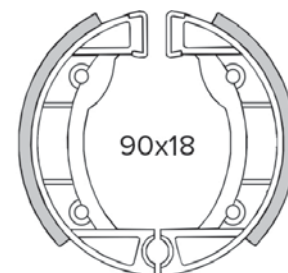

225120200



Anteriore | *Front*

Ciao • Si • Px • Bravo • Superbravo • Grillo •

Boss

Per cerchione in alluminio - *For aluminium rims models*

R.O. 414497

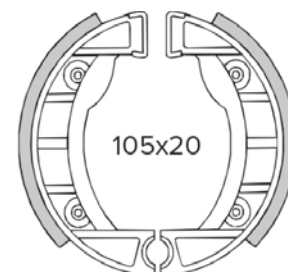

225120230



1 pz. | *1 pc.*

Posteriore | *Rear*

Ciao • Si • Px • Bravo • Superbravo • Grillo •

Boss

R.O. 4145574



## ACCESSORI GANASCE FRENO - BRAKE SHOES ACCESSORIES

121950080



ANELLO GANASCIA | *BRAKE SHOES CLIP*

Bravo • Superbravo

R.O. 000061





# IMPIANTO ELETTRICO

ELECTRICAL SYSTEM



# CICLOMOTORE - MOPED

## ACCESSORI CANDELE - SPARK PLUGS ACCESSORIES

246330040



KIT CAPPuccio CANDELA | SPARK PLUG CAP  
KIT

Confezione 10 pz. | 10 pcs pack

Applicazioni varie | Various applications



246330050



CAPPuccio CANDELA | SPARK PLUG CAP

Confezione 5 pz. | 5 pcs pack

Ciao • Si

R.O. 103936



246330060



CAPPuccio CANDELA | SPARK PLUG CAP

In gomma speciale nera | Special black rubber

Confezione 5 pz. | 5 pcs pack

Ciao • Si |



246330070



CAPPuccio CANDELA | SPARK PLUG CAP

In gomma al silicone | Silicone rubber

Confezione 5 pz. | 5 pcs pack

Colore: rosso-blu | Color: red-blue

Ciao • Si |



246330080



CAPPuccio CANDELA | SPARK PLUG CAP

In gomma al silicone | Silicone rubber

Confezione 5 pz. | 5 pcs pack

Ciao • Si |



**ACCESSORI CANDELE - SPARK PLUGS ACCESSORIES****246330100****CAPPUCCIO CANDELA | SPARK PLUG CAP**In gomma al silicone, schermato | *Sylicone rubber, with resistor*Antiacqua | *Waterproof*Innesto cavo Ø 7 mm | *Ø 7 mm cable connection*Innesto candela Ø 6,2 mm | *Ø 6,2 mm spark plug connections*Confezione 10 pz. | *10 pcs pack*Applicazioni varie | *Various applications***246330110****CAPPUCCIO CANDELA | SPARK PLUG CAP**In gomma al silicone, schermato | *Sylicone rubber, with resistor*Antiacqua | *Waterproof*Innesto cavo Ø 7 mm | *Ø 7 mm cable connection*Innesto candela Ø 4 mm | *Ø 4 mm spark plug connections*Ceramica candela Ø 10 | *Ø 10 spark plug ceramic*Confezione 10 pz. | *10 pcs pack*Applicazioni varie | *Various applications***246330120****CAPPUCCIO CANDELA | SPARK PLUG CAP**In gomma al silicone - schermato | *Sylicone rubber, with resistor*Antiacqua | *Waterproof*Innesto cavo Ø 7 mm | *Ø 7 mm cable connection*Innesto candela Ø 6,2 mm | *Ø 6,2 mm spark plug connections*Ceramica candela Ø 12 | *Ø 12 spark plug ceramic*Confezione 10 pz. | *10 pcs pack*Applicazioni varie | *Various applications*

# CICLOMOTORE - MOPED

## ACCESSORI CANDELE - SPARK PLUGS ACCESSORIES

246330130



CAPPUCCIO CANDELA | SPARK PLUG CAP

In gomma al silicone - schermato | Silicone rubber, with resistor

Antiacqua | Waterproof

Innesto cavo Ø 7 mm | Ø 7 mm cable connection

Innesto candela Ø 4 mm | Ø 4 mm spark plug connections

Ceramica candela Ø 12 | Ø 12 spark plug ceramic

Confezione 10 pz. | 10 pcs pack

Applicazioni varie | Various applications



246330140



CAPPUCCIO CANDELA | SPARK PLUG CAP

Piega 90° | 90° spark plug cap

Innesto terminale SAE | SAE connector

**PRO-0U**



246330150



CAPPUCCIO CANDELA | SPARK PLUG CAP

Piega 90° | 90° spark plug cap

Schermata | With resistor

Innesto terminale 1 | Connector type 1

**PRO-5M**



246490010



CAVO CANDELA | SPARK PLUG CABLE

Rotolo da 10 mt, Ø 7mm | Packing 10/mtrs roll, Ø 7mm

Colore Nero | Colour Black

Ciao • Si |



**ACCESSORI CANDELE - SPARK PLUGS ACCESSORIES****246490011** **NEW**

CAVO CANDELA | SPARK PLUG CABLE  
 Rotolo da 10 mt, Ø 7mm | Packing 10/mtrs roll,  
 Ø 7mm  
 Colore Blu | Colour Blue  
 Applicazioni varie | Various applications

**246490012** **NEW**

CAVO CANDELA | SPARK PLUG CABLE  
 Rotolo da 10 mt, Ø 7mm | Packing 10/mtrs roll,  
 Ø 7mm  
 Colore Rosso | Colour Red  
 Applicazioni varie | Various applications

**FANALI COMPLETI - COMPLETE LIGHTS****FANALI ANTERIORI - FRONT LIGHTS****246410250**

Colore avorio | Ivory colour  
 Ciao Special



# CICLOMOTORE - MOPED

## FANALI COMPLETI - COMPLETE LIGHTS

246410260



Colore grigio | *Grey colour*  
Ciao Special



246410280



Colore nero | *Black colour*  
Si • Si FL2 • Si Mix



246410290



Con Commutatore Luci | *With Light Switch*  
Ciao ('79-'88)  
R.O. 2534935, 290895



## AVVISATORI ACUSTICI - HORNS

246070230



6V C.A.  
Ciao • Si  
R.O. 122232



## RELÈ - RELAYS

246120010



RELÈ FRECCHE | *BLINKERS RELAYS*  
12V 21W  
3 terminali | 3 pins  
Ciao Mix • Si Mix • Si FL2 • Grillo  
R.O. 163968, 195703



246120011



RELÈ FRECCHE | *BLINKERS RELAYS*  
12V 21W  
3 terminali | 3 pins  
Ciao Mix • Si Mix • Si FL2 • Grillo  
R.O. 163968, 195703



## CENTRALINE - CDI

246010062



Si  
R.O. 2441275



# CICLOMOTORE - MOPED

## CENTRALINE - CDI

246010063



Si  
R.O. 2441275



## ACCESSORI CENTRALINE - CDI ACCESSORIES

121830560



CAPPUCCIO BOBINA | COIL CAP

Si  
R.O. 231571



## STATORI - STATORS

246350510 **NEW**



4 POLI | 4 POLES

Ciao Euro 1/2  
R.O. 293814



## VOLANI COMPLETI - COMPLETE FLYWHEEL

246360951



Ciao  
R.O. 1665425, 1218225, 1218235





**ACCESSORI VOLANI, ROTORI E STATORI - FLYWHEEL, ROTORS AND STATORS ACCESSORIES****121858430**

CHIAVETTA VOLANO | FLYWHEEL KEY  
 Confezione 50 pz. | 50 Pcs Packing  
 12,6x5x3 mm  
 Ciao • Si  
 R.O. 000267

**ACCESSORI CABLAGGI - WIRINGS ACCESSORIES****267005000**

KIT GUAINA TERMORETRAIBILE IMPERMEABILE  
 (106 Pz) | WATERPROOF HEAT SHRINKABLE  
 TUBE SET (106 Pcs)

**CONDENSATORI - CONDENSERS****246190050**

Ciao • Si  
 R.O. 102939

**CONNETTORI - ELECTRICAL CONNECTORS****246330260**

COPRI FASTON FEMMINA 6,3 mm | FEMALE  
 FASTON COVER 6,3 mm  
 Confezione 100 pz. | 100 Pcs Packing

**246330310**

CONNETTORI PREISOLATI (7 Tipi) | PLASTIC  
 COATED CONNECTORS (7 Types)  
 Confezione 35 pz. | 35 Pcs Packing



# CICLOMOTORE - MOPED

## CONTATTI - PLATINERS

246150010



Ciao • Si  
R.O. 103133



# TRASMISSIONE





TRANSMISSION



# CICLOMOTORE - MOPED

## CINGHIE DI TRASMISSIONE - TRANSMISSION BELTS

### CINGHIE DI TRASMISSIONE DAYCO - DAYCO TRANSMISSION BELTS

Modello Model	CC	Da From	A To	DAYCO Standard 	DAYCO Confezione Industriale Industrial Packing 	DAYCO Kevlar 	Codice RMS RMS Code 	OEM
<b>PIAGGIO</b>								
Boss (Con variatore/CVT)	50	1988	1989	-	-	-	163730031	122192
Bravo Erre 2 (Con variatore/ CVT)	50	1975	1981	-	-	-	163730051	124593
Bravo Erre 2	50	1975	1981	-	-	-	163730061	130938
Ciao	50	1980	1988	-	-	-	163730071	102905
Ciao Euro1	50	1999	2001	-	-	-	163730071	102905
Ciao Euro2	50	2002	2004	-	-	-	163730071	102905
Ciao Mix Teen	50	1996	2001	-	-	-	163730071	102905
Ciao (Con variatore/CVT)	50	1980	1988	163751210	-	-	-	-
Ciao Euro1 (Con variatore/CVT)	50	1999	2001	163751210	-	-	-	288486
Ciao Mix Teen (Con variatore/ CVT)	50	1996	2001	163751210	-	-	-	288486
Ciao Tre (Con variatore/CVT)	50	1971	1999	163751210	-	-	-	288486
Si (Con variatore/CVT)	50	1979	1988	-	-	-	163730031	122192
Si	50	1979	1988	-	-	-	163730041	124593
Si FI2 (Con variatore/CVT)	50	1991	1997	-	-	-	163730031	122192
Si FI2	50	1991	1997	-	-	-	163730041	124593
Si Mix (Con variatore/CVT)	50	1996	1999	-	-	-	163730031	122192
Si Mix	50	1996	1999	-	-	-	163730041	124593
Superbravo (Con variatore/ CVT)	50	1985	1990	-	-	-	163730051	130937

## PULEGGE - PULLEYS

### SEMIPULEGGE CONDOTTE FISSE - FIXED DRIVEN HALF PULLEY ASSY

100340130



Puleggia Ø90 mm | Pulley Ø90 mm

Ciao • Si • Boxer • Boss • Bravo

R.O. 103049



## ACCESSORI PULEGGE - PULLEYS ACCESSORIES

100410010



KIT RICAMBIO PER PULEGGIA MOTRICE  
VARIATORE | *REPLACEMENT KIT FOR PULLEY*  
Composto da: 8 Rulli, 16 Semigusci | *Composed*  
*by 8 rolls, 16 Half shells*  
Ciao • Si • Boxer • Boss • Bravo  
R.O. 104559, 104560



## ACCESSORI TRASMISSIONE - TRANSMISSION ACCESSORIES

100260120



CAMPANA INTERNA | *INTERNAL DRUM CLUTCH*  
Senza variatore | *Without variator*  
Ciao • Si • Bravo • Boxer • Boss  
R.O. 114943



100360260



SERIE MASSETTE FRIZIONE AVVIAMENTO |  
*STARTER CLUTCH SET WITH AUTOMATIC SPEED*  
Senza variatore | *Without variator*  
3 pezzi | *3 pieces*  
Ciao • Bravo • Si • Boxer • Boss  
R.O. 249813



121858540



RONDELLA SPALLAMENTO MOZZO VARIATORE  
15X28X1,2 mm | *CLUTCH SHOULDER HUB*  
*WASHER 15X28X1,2 mm*  
Confezione 20 pz. | *20 Pcs Packing*  
Ciao • Bravo • Si • Boxer • Boss  
R.O. 131514



# CICLOMOTORE - MOPED

## ACCESSORI TRASMISSIONE - TRANSMISSION ACCESSORIES

121858550



RONDELLA MOZZO VARIATORE 12X24X0,6 mm |  
*CLUTCH HUB WASHER 12X24X0,6 mm*  
Confezione 20 pz. | *20 Pcs Packing*  
Ciao • Bravo • Si • Boxer • Boss  
R.O. 103556



121858560



RONDELLA MOZZO VARIATORE 16X24X0,6 mm |  
*CLUTCH HUB WASHER 16X24X0,6 mm*  
Confezione 20 pz. | *20 Pcs Packing*  
Ciao • Bravo • Si • Boxer • Boss  
R.O. 103557



121858570



BALESTRINO FRIZIONE | *CLUTCH PUSH RING*  
Confezione 20 pz. | *20 Pcs Packing*  
Ciao • Bravo • Si • Boxer • Boss  
R.O. 220441

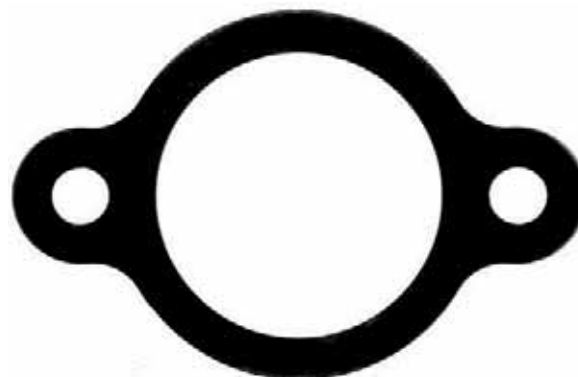

121890070



MOLLA MASSETTA FRIZIONE | *CLUTCH SET*  
*SPRING*  
Confezione 50 pz. | *50 Pcs Packing*  
Ciao • Bravo • Si • Boxer • Boss  
R.O. 121753



# CARROZZERIA

BODY WORK

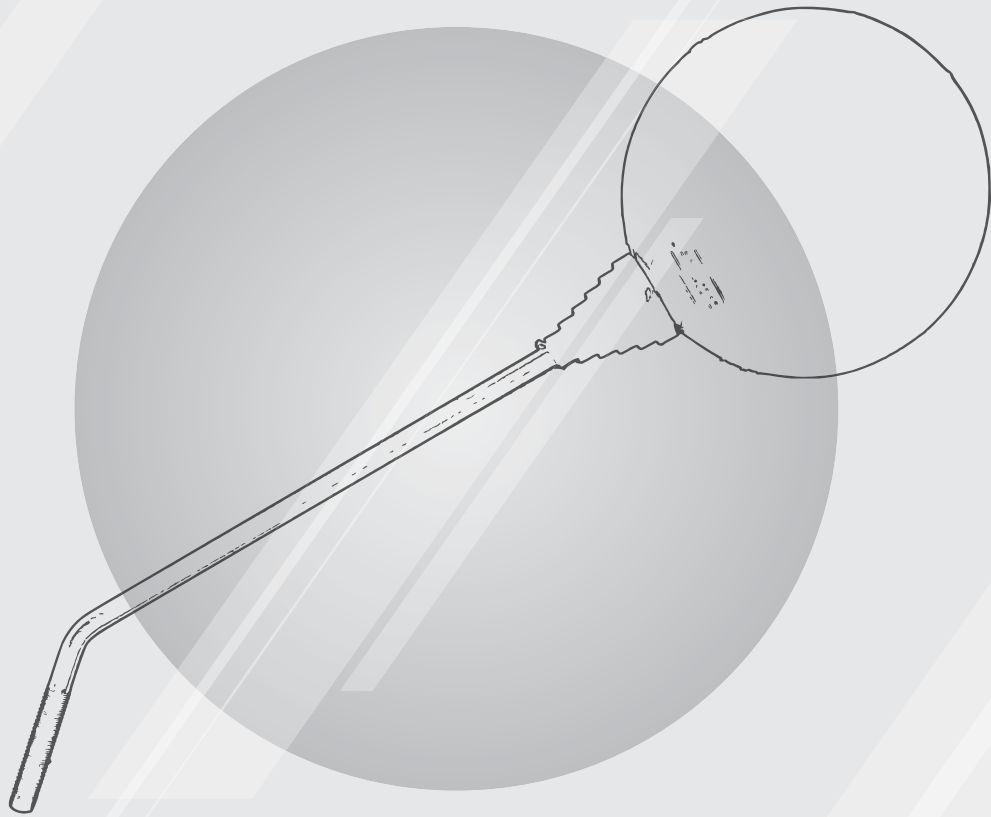

# CICLOMOTORE - MOPED

## SPECCHIETTI RETROVISORI - REAR VIEW MIRRORS

### SPECCHIETTI UNIVERSALI - UNIVERSAL REAR MIRRORS

122761000



Specchio retrovisione destro-sinistro tondo  
con aggancio a fascetta | *Left/right round rear  
mirror with clamp*

Passo 8 mm | *Thread 8 mm*



122760100



Specchio retrovisore destro-sinistro tondo  
con aggancio a fascetta, asta 8mm diametro  
105mm | *Left/right round rear mirror with  
clamp, stem 8mm, diameter 105 mm*

Passo Asta Ø 8 mm - Vetro Ø 105 mm | *Thread  
Shaft Ø 8 mm - Glass Ø 105 mm*



## PARAFANGHI - MUDGUARDS

142680240



PARAFANGO ANTERIORE | *FRONT MUDGUARD*  
Verniciato Nero | *Black Painted*

Si • Si FL ('92>)  
R.O. 267651





TARGHETTE - SCUDI - FREGI - NAMEPLATES - BADGES - EMBLEMS

142721260



TARGHETTA FIANCHETTO LATERALE | *SIDE PANEL NAMEPLATE*

Fissaggio a due perni | *Two pin fixing*  
 Interasse perni 74 mm | *Pin distance 74 mm*  
 Dimensioni 95x22 mm | *Dimensions 95x22 mm*  
 Materiale Alluminio | *Material Aluminium*

Ciao ('80-'88)

R.O. 163966



142721480

NEW



TARGHETTA PIAGGIO | *PIAGGIO LABEL*

Alluminio | *Aluminium*  
 Dimensioni 115x28 mm | *Dimensions 115x28 mm*

Ciao ('80-'88) • Bravo ('75-'90) • Sì ('79-'88)

R.O.182346

PIAGGIO

PORTATARGA - PLATE HOLDERS

142700040



PORTATARGA EUROPEO | *PLATE HOLDER*

Plastica | *Plastic*  
 Per Ciclomotori e Scooter 50 cc | *For scooters and mopeds 50 cc*  
 Colore nero | *Black colour*



142700070

NEW



PORTATARGA EUROPEO | *PLATE HOLDER*

Plastica | *Plastic*  
 Per Ciclomotori e Scooter 50 cc | *For scooters and mopeds 50 cc*  
 Cromato | *Chromed*



# CICLOMOTORE - MOPED

## PLASTICHE CARROZZERIA - CHASSIS PLASTICS

142680420



PARASPRUZZO | *SPLASH GUARD*  
In gomma | *Rubber*  
Confezione 5 Pz. | *5 Pcs Packing*  
Si • Si FL2  
R.O. 269208



142560090



COPPIA COPERTURE LATERALI COPRIMOTORE  
| *COUPLE PROTECTION FRAME*  
Si  
Modelli con variatore - *CVT Models*  
R.O. 497488



142560100



COPPIA COPERTURE LATERALI | *COUPLE COVERS*  
Ciao  
Modelli con variatore - *CVT Models*



142680770



COPPIA COPERTURE LATERALI | *COUPLE COVERS*  
Ciao  
Modelli senza variatore - *No CVT Models*



142560150



COPPIA POGGIPIEDI NERI | *BLACKFLOOR BOARD COUPLE*  
Si • Si FL2  
R.O. 228989



PLASTICHE CARROZZERIA - CHASSIS PLASTICS

142560170



PEDANA | FOOTREST  
 Colore Nero | Black Colour  
 Ciao PX  
 R.O. 188128



142680860

NEW



PEDANA LISCIA | FLAT FOOTREST  
 Ciao



142680870

NEW



DOCETTA COPRIFILI | CABLES HORN COVER  
 Si



ACCESSORI CARROZZERIA - BODYPARTS ACCESSORIES

121858590



VITE FISSAGGIO RAPIDO mm 34 | FAST LOCK  
 SCREW mm 34  
 Confezione 6 pz. | 6 Pcs Packing  
 Si • Si FL • Bravo ('82)  
 R.O. 185818



121858600



VITE FISSAGGIO RAPIDO mm 31 | FAST LOCK  
 SCREW mm 31  
 Confezione 6 pz. | 6 Pcs Packing  
 Ciao • Si  
 R.O. 132871



# CICLOMOTORE - MOPED

## ACCESSORI CARROZZERIA - BODYPARTS ACCESSORIES

121858591 **NEW**



VITE FISSAGGIO RAPIDO mm 27,5 | *FAST LOCK SCREW mm 27,5*

Confezione 6 pz. | *6 Pcs Packing*

Ciao PX

R.O. 188086



121858592 **NEW**



VITE FISSAGGIO RAPIDO mm 23,5 | *FAST LOCK SCREW mm 23,5*

Confezione 6 pz. | *6 Pcs Packing*

Ciao PX

R.O. 191491



121858593 **NEW**



KIT RITEGNI (2 CORTI - 4 LUNGI) PER FIANCATINE (MOLLE INCLUSE) 2 pezzi 23,5mm 4 pezzi 27,5mm | *RETAINERS KIT (2 SHORT - 4 LONG) FOR LATERAL COVER (SPRINGS INCLUDED) 2 pieces 23.5mm 4 pieces 27.5mm*

Ciao PX



121858594 **NEW**



KIT RITEGNI (6 LUNGI) PER FIANCATINE (MOLLE INCLUSE) 6 pezzi 27,5mm | *RETAINERS KIT (6 LONG) FOR LATERAL COVER (SPRINGS INCLUDED) 6 pieces 27.5mm*

Si • Si FL2



121890120



MOLLA RITEGNO FIANCATINE | *PROTECTION FRAME SPRING*

Confezione 25 pz. | *25 Pcs Packing*

Ciao PX • Si • Si FL • Bravo ('82)

R.O. 122957



# TELAIO

CHASSIS

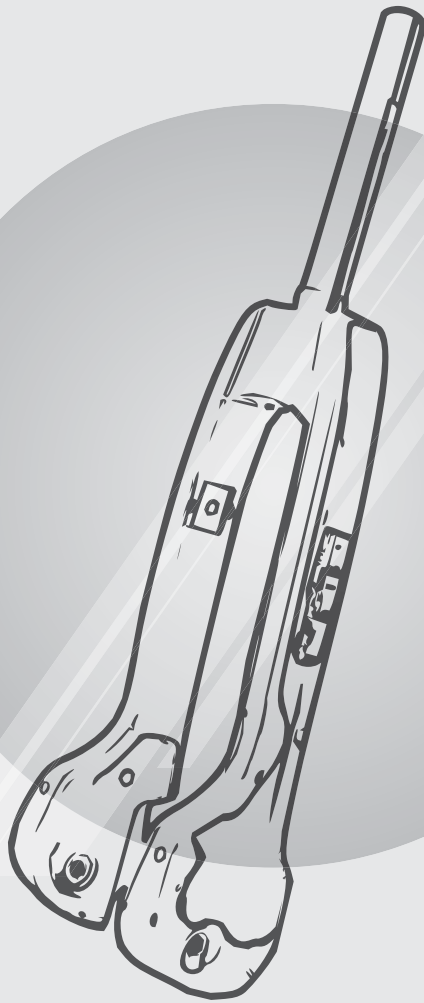

# CICLOMOTORE - MOPED

## LEVE - LEVERS

### LEVE SINISTRE - LEFT HAND LEVERS

184100300



Alluminio | *Aluminum*  
Colore Nero | *Black Colour*  
Ciao • Si FL2  
R.O. 268015



184100310



Alluminio | *Aluminum*  
Colore Nero | *Black Colour*  
Ciao • Si ('88-'92)  
R.O. 228967, 242648



184101060



Alluminio | *Aluminum*  
Colore Grigio | *Grey Colour*  
Ciao SC  
R.O. 156378



184101100



Nylon | *Nylon*  
Colore Nero | *Black Colour*  
Ciao • Si • Garelli  
R.O. 178582



### LEVE DESTRE - RIGHT HAND LEVERS

184120330



Alluminio | *Aluminum*  
Colore Nero | *Black Colour*  
Ciao • Si FL2  
R.O. 268014



**LEVE - LEVERS****184121080**

Alluminio | *Aluminum*  
 Colore Nero | *Black Colour*  
 Ciao • Si ('88-'92)  
 R.O. 228966

**LEVE PER APPLICAZIONI VARIE - VARIOUS APPLICATION LEVERS****184140050**

LEVA ALZAVALVOLA PER DECOMPRESSIONE |  
*DECOMPRESSION VALVE CONTROL LEVER*  
 Confezione 10 Pz. | *10 Pcs Packing*  
 Nylon | *Nylon*  
 Colore Nero | *Black Colour*  
 Ciao • Si  
 R.O. 176946

**184140060**

LEVA ALZAVALVOLA PER DECOMPRESSIONE |  
*DECOMPRESSION VALVE CONTROL LEVER*  
 Confezione 10 Pz. | *10 Pcs Packing*  
 Nylon | *Nylon*  
 Colore Nero | *Black Colour*  
 Ciao • Si  
 Tutti i modelli dal '88 in poi - *all models from*  
*'88 onwards*  
 R.O. 268099

**ACCESSORI LEVE - LEVERS ACCESSORIES****121858170**

BARILOTTO LEVA FRENO AL MANUBRIO |  
*PIVOT PINS FOR BRAKE LEVER*  
 Confezione 10 pz. | *10 Pcs Packing*  
 Ø 10x16 mm, Gambo 7,9 mm | *Stem 7,9 mm*



# CICLOMOTORE - MOPED

## ACCESSORI LEVA - LEVERS ACCESSORIES

121858290



NOTTOLINO PER LEVA | *LEVER RATCHET*

Confezione 10 pz. | *10 Pcs Packing*

Alluminio | *Aluminium*

Ciao • Si • Garelli



121950010



Molla ritorno leva | *Return spring lever*

Ciao • PX • Si • Bravo • Superbravo • Grillo •

Boss

R.O. 177072



## COMANDI PORTALEVA - LEVERS SUPPORTS

184040410



Leva in plastica | *Plastic lever*

Ciao • Si

R.O. 188056



184040430



Leva in alluminio | *Aluminium lever*

Colore Nero | *Black Colour*

Ciao • Si ('88-'92)

R.O. 229004



184040660



Leva in acciaio | *Steel lever*

Colore Grigio | *Grey Colour*

Ciao SC

R.O. 162806





**COMANDI GAS - THROTTLES HANDLES****184080330**

Leva in plastica | *Plastic lever*  
 Colore Nero | *Black Colour*  
 Ciao • Si ('88)  
 R.O. 188057 Ex 178583

**184080350**

Leva in alluminio | *Aluminium lever*  
 Colore Nero | *Black Colour*  
 Ciao • Si ('88-'92)  
 R.O. 228969

**184080520**

2 cavi | *2 cables*

**184080530**

Modello Moped | *Moped model*  
 Corsa massima mm 43 (36 mm/148°) | *Max stroke mm 43 (36 mm/148°)*  
 Monocavo | *Single cable*

**184080650**

Leva in acciaio | *Steel lever*  
 Colore Grigio | *Grey Colour*  
 Ciao SC  
 R.O. 162804



# CICLOMOTORE - MOPED

## COMANDI GAS - THROTTLES HANDLES

184080660



Moto Rally Cafè racer | *Rally Cafè racer*  
Motorcycle  
Corsa massima mm 25 | *Max stroke mm 25*  
Monocavo | *Single cable*  
Manopola Colore Marrone | *Brown Colour*  
Knob



184080670



Moto Modello Lario | *Lario Model*  
Corsa massima mm 25 | *Max stroke mm 25*  
Monocavo | *Single cable*  
Manopola Colore Nero | *Black Colour Knob*



## ACCESSORI COMANDI - CONTROLS ACCESSORIES

121858480



CORSOIO CON VITE | *SLIDING BLOCK WITH*  
*SCREW*  
Ciao • Si  
R.O. 229935



## MANOPOLE E ACCESSORI - GRIPS AND ACCESSORIES

184160040



Nero | *Black*  
Ciao • Si (>'88) • Bravo Erre 2 50 ('75-'81) •  
Bravo 3 ('80-'85)  
R.O. 185256



Estremità chiusa  
*Closed end*

**MANOPOLE E ACCESSORI - GRIPS AND ACCESSORIES****184160050**Nero | *Black*

Ciao • Si ('88 - '92)

R.O. 233072, 233075

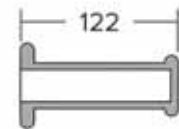
Estremità chiusa  
*Closed end***184160060**Nero | *Black*

Ciao • Si FL

R.O. 267205, 267206

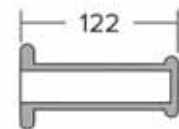
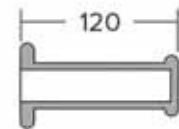
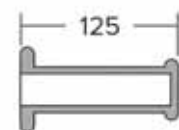
Estremità chiusa  
*Closed end***184160710**Marrone | *Brown*Modello **RETRO** | *Model RETRO*Estremità chiusa  
*Closed end***184160840**Nero | *Black*Modello **VINTAGE** | *Model VINTAGE*Estremità chiusa  
*Closed end*

# CICLOMOTORE - MOPED

## MANOPOLE E ACCESSORI - GRIPS AND ACCESSORIES

184160860



Caffè | *Coffee*

Modello **VINTAGE** | *Model* **VINTAGE**

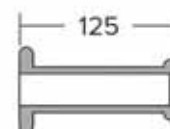

Estremità chiusa  
*Closed end*

184160870



Nero | *Black*

Modello **VINTAGE** | *Model* **VINTAGE**

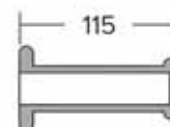

Estremità chiusa  
*Closed end*

184160880



Marrone | *Brown*

Modello **VINTAGE** | *Model* **VINTAGE**

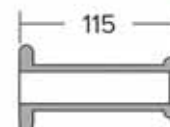

Estremità chiusa  
*Closed end*

184160890



Caffè | *Coffee*

Modello **VINTAGE** | *Model* **VINTAGE**

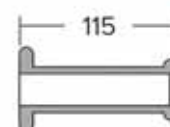

Estremità chiusa  
*Closed end*

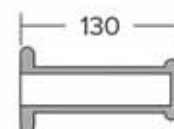
**MANOPOLE E ACCESSORI - GRIPS AND ACCESSORIES****484040020**Spugna Nera | *Black Foam*Estremità chiusa  
*Closed end***CAVALLETTI CENTRALI - CENTRAL STANDS****121610490**Completo di molle e perno | *Complete with  
springs and pin*Nero | *Black*

Si • Si FL

R.O. 185869

**121610500**Completo di molle e perno | *Complete with  
springs and pin*Nero | *Black*

Ciao

R.O. 25523001

**121611030**Nero | *Black*

Ciao 1° serie • Ciao PX

R.O. 10463101



# CICLOMOTORE - MOPED

## ACCESSORI CAVALLETTI - STANDS ACCESSORIES

121890100



COPPIA MOLLE CAVALLETTO | PAIR OF STAND  
SPRINGS

Ciao  
R.O. 139136, 139137



121890110



COPPIA MOLLE CAVALLETTO | PAIR OF STAND  
SPRINGS

Si  
R.O. 164166, 164167



## FORCELLE - FORKS

121570700 **NEW**



Cromata | *Chromed*

Ciao 1° serie • Ciao Mix • Ciao Euro 1/2 • Ciao  
PX • Ciao SC  
R.O. 175853



121570701 **NEW**



Nera | *Black*

Ciao 1° serie • Ciao Mix • Ciao Euro 1/2 • Ciao  
PX • Ciao SC  
R.O. 175853



**SERIE STERZO - STEERING HEAD BEARING SET****184220110**SERIE STERZO COMPLETA | *COMPLETE STEERING SERIES*

Boss ('88-'89) • Bravo 3 ('87-'90) • Bravo Erre 2 ('75-'81) • Grillo ('89-'93) • Si FL2 ('91-'97) • Si Mix ('96-'99) • Si ('79-'88) • Superbravo 3 ('87-'90) • Superbravo ('85-'90)

R.O. 564746

Con Dado Superiore Cod. 18 420 0020 | *With**Open Nut Cod. 18 420 0020*

R.O. 249324

**184220270**SERIE STERZO COMPLETA | *COMPLETE STEERING SERIES*

Boss ('88-'89) • Bravo 3 ('87-'90) • Bravo Erre 2 ('75-'81) • Grillo ('89-'93) • Si FL2 ('91-'97) • Si Mix ('96-'99) • Si ('79-'88) • Superbravo 3 ('87-'90) • Superbravo ('85-'90)

R.O. 564746

**184220570**SERIE CALOTTE STERZO | *STEERING CAPS SERIES*

Ciao

R.O. 814231

**ACCESSORI SERIE STERZO - STEERING HEAD BEARING SET ACCESSORIES****GROSSE SFERE - BALL SETS****484120221**1 Conf. Sfere Grosse 3/16" (Tot. 144 Pz.) | 1 Grs  
*ball set 3/16" (Tot. 144 Pcs)*

# CICLOMOTORE - MOPED

## ACCESSORI SERIE STERZO - STEERING HEAD BEARING SET ACCESSORIES

484120231



1 Conf. Sfere Grosse 1/4" (Tot. 144 Pz.) | 1 Grs  
ball set 1/4" (Tot. 144 Pcs)



## MINUTERIA METALLICA - METAL PARTS

184200020



DADO SUPERIORE STERZO PASSANTE |  
STEERING UPPER NUT  
Confezione 5 Pz. | 5 Pcs Packing  
Si  
R.O. 249324



## KIT CAVI TRASMISSIONE - TRANSMISSION CABLES KITS

### KIT TRASMISSIONI CICLOMOTORI PIAGGIO - TRANSMISSION KIT PIAGGIO MOPED

163620130



Colore grigio | Grey color  
Trasmissione gas | Throttle transmission  
Trasmissione freno anteriore | Front brake  
transmission  
Trasmissione freno posteriore | Rear brake  
transmission  
Trasmissione decompressore | Decompressor  
transmission  
Ciao SC



163620140



Colore grigio | Grey color  
Trasmissione gas | Throttle transmission  
Trasmissione freno anteriore | Front brake  
transmission  
Trasmissione freno posteriore | Rear brake  
transmission  
Trasmissione decompressore | Decompressor  
transmission  
Ciao PX





**KIT CAVI TRASMISSIONE - TRANSMISSION CABLES KITS****163620150**

Colore nero | *Black color*  
 Trasmissione gas | *Throttle transmission*  
 Trasmissione freno anteriore | *Front brake transmission*  
 Trasmissione freno posteriore | *Rear brake transmission*  
 Trasmissione decompressore | *Decompressor transmission*  
 Ciao PX

**163620160**

Colore nero | *Black color*  
 Trasmissione gas | *Throttle transmission*  
 Trasmissione freno anteriore | *Front brake transmission*  
 Trasmissione freno posteriore | *Rear brake transmission*  
 Trasmissione decompressore | *Decompressor transmission*  
 Si

**163631000****NEW**

Colore nero | *Black color*  
 Trasmissione contachilometri | *Speedometer transmission*  
 Ciao Mix Teen ('96-'01) • Ciao Euro 2 ('02-'04) •  
 Si Mix ('96-'99)  
 R.O. 274959

**MORSETTI CAVI - CABLE CLAMPS****121858010**

MORSETTO CON VITE LATERALE | *CLAMPS WITH SIDE SCREW*  
 Ø 7x11 - M4  
 Per cavo frizione Ø 1,9 mm | *For clutch cable Ø 1,9 mm*  
 Confezione 10 pz. | *10 Pcs Packing*



# CICLOMOTORE - MOPED

## MORSETTI CAVI - CABLE CLAMPS

121858020



MORSETTO CON VITE LATERALE | CLAMPS  
WITH SIDE SCREW

Ø 8x12 - M4

Per cavo frizione Ø 2,5 mm | For clutch cable  
Ø 2,5 mm

Confezione 10 pz. | 10 Pcs Packing



121858030



MORSETTO CON VITE LATERALE | CLAMPS  
WITH SIDE SCREW

Ø 12x18 - M5

Per cavo frizione Ø 3 mm | For clutch cable Ø  
3 mm

Confezione 10 pz. | 10 Pcs Packing



121858040



MORSETTO CAVO GAS | THROTTLE CABLE  
CLAMPS

Ø 5,5x7,3 - M4

Tipo Magura | Magura type

Confezione 10 pz. | 10 Pcs Packing



121858050



MORSETTO CAVO GAS | THROTTLE CABLE  
CLAMPS

Ø Esterno 5,5x6 - Ø Interno 2,2

Filetto 1/8 | Ø Outside 5.5x6 - Ø Inside 2.2

Thread 1/8

Super pratic

Confezione 10 pz. | 10 Pcs Packing



**REGISTRI CAVI - CABLE REGISTERS****121858130**REGISTRO CAVO Ø 5 MM | *ADJUSTING SCREW*  
Ø 5 MMEsagono 8 mm | *Hexagon 8 mm*M5x20 mm | *M5x20 mm*Confezione 10 pz. | *10 Pcs Packing*Boss ('88-'89) • Bravo 3 ('87-'90) • Bravo Erre  
2 ('75-'81) • Grillo ('89-'93) • Si FL2 ('91-'97) • Si  
Mix ('96-'99) • Si ('79-'88) • Superbravo 3 ('87-  
'90) • Superbravo ('85-'90)R.O. 020105 / 090527+020105 (gear) / 156400  
(PX) - 090257 (V50/PV/ET3/125/150/Rally) +  
020105 (clutch (PIAGGIO) SF514-1525 (LML)**121858250**REGOLATORE M8 | *M8 ADJUSTING SCREW*  
Confezione 5 pz. | *5 Pcs Packing***121858260**REGOLATORE M5 | *M5 ADJUSTING SCREW*  
Confezione 10 pz. | *10 Pcs Packing***121858300**REGOLATORE M10 | *M10 ADJUSTING SCREW*  
Confezione 5 pz. | *5 Pcs Packing*  
M10x1.25 | *M10x1.25*

# CICLOMOTORE - MOPED

## GUAINA - OUTER CABLES

### GUAINA CON SPIRALE IN ACCIAIO TONDO (TIPO ITALIA) - OUTER CABLE ROUND WIRE (ITALIAN TYPE)

163530400



Colore Nero | *Colour Black*  
Misura 50/mtrs roll | *Size 50/mtrs roll*  
Foro interno 2,5 mm | *Inside hole 2,5 mm*  
Diametro esterno 4,5 mm | *Outside diameter 4,5 mm*  
Diametro esterno con rivestimento 5,2 mm | *Outside hole with rubber 5,2 mm*



163530401



Colore Grigio | *Colour Gray*  
Misura 50/mtrs roll | *Size 50/mtrs roll*  
Foro interno 2,5 mm | *Inside hole 2,5 mm*  
Diametro esterno 4,5 mm | *Outside diameter 4,5 mm*  
Diametro esterno con rivestimento 5,2 mm | *Outside hole with rubber 5,2 mm*



163530411



Colore Grigio millerighe | *Colour Gray grooved*  
Misura 50/mtrs roll | *Size 50/mtrs roll*  
Foro interno 2,5 mm | *Inside hole 2,5 mm*  
Diametro esterno 4,5 mm | *Outside diameter 4,5 mm*  
Diametro esterno con rivestimento 5,2 mm | *Outside hole with rubber 5,2 mm*



163530500



Colore Nero | *Colour Black*  
Misura 50/mtrs roll | *Size 50/mtrs roll*  
Foro interno 3 mm | *Inside hole 3 mm*  
Diametro esterno 5 mm | *Outside diameter 5 mm*  
Diametro esterno con rivestimento 5,8 mm | *Outside hole with rubber 5,8 mm*



**GUAINA - OUTER CABLES****163530600**

Colore Nero | *Colour Black*  
 Misura 25/mtrs roll | *Size 25/mtrs roll*  
 Foro interno 3,5 mm | *Inside hole 3,5 mm*  
 Diametro esterno 6 mm | *Outside diameter 6 mm*  
 Diametro esterno con rivestimento 7 mm |  
*Outside hole with rubber 7 mm*

**163530700**

Colore Nero | *Colour Black*  
 Misura 25/mtrs roll | *Size 25/mtrs roll*  
 Foro interno 4,2 mm | *Inside hole 4,2 mm*  
 Diametro esterno 7 mm | *Outside diameter 7 mm*  
 Diametro esterno con rivestimento 8 mm |  
*Outside hole with rubber 8 mm*

**163530800** **NEW**

Colore Nero | *Colour Black*  
 Misura 50/mtrs roll | *Size 50/mtrs roll*  
 Foro interno 2,5 mm | *Inside hole 2,5 mm*  
 Diametro esterno 4 mm | *Outside diameter 4 mm*  
 Diametro esterno con rivestimento 5 mm |  
*Outside hole with rubber 5 mm*  
 In PVC | *PVC made*

**163530801** **NEW**

Colore Grigia | *Colour Gray*  
 Misura 50/mtrs roll | *Size 50/mtrs roll*  
 Foro interno 2,5 mm | *Inside hole 2,5 mm*  
 Diametro esterno 4 mm | *Outside diameter 4 mm*  
 Diametro esterno con rivestimento 5 mm |  
*Outside hole with rubber 5 mm*  
 In PVC | *PVC made*



# CICLOMOTORE - MOPED

## GUAINE - OUTER CABLES

163530810 **NEW**



Colore Nero | *Colour Black*  
Misura 50/mtrs roll | *Size 50/mtrs roll*  
Foro interno 2,5 mm | *Inside hole 2,5 mm*  
Diametro esterno 5 mm | *Outside diameter 5 mm*  
Diametro esterno con rivestimento 6 mm |  
*Outside hole with rubber 6 mm*  
In PVC | *PVC made*



163530811 **NEW**



Colore Grigia | *Colour Gray*  
Misura 50/mtrs roll | *Size 50/mtrs roll*  
Foro interno 2,5 mm | *Inside hole 2,5 mm*  
Diametro esterno 5 mm | *Outside diameter 5 mm*  
Diametro esterno con rivestimento 6 mm |  
*Outside hole with rubber 6 mm*  
In PVC | *PVC made*



163530820 **NEW**



Colore Nero | *Colour Black*  
Misura 50/mtrs roll | *Size 50/mtrs roll*  
Foro interno 3 mm | *Inside hole 3 mm*  
Diametro esterno 6 mm | *Outside diameter 6 mm*  
Diametro esterno con rivestimento 7 mm |  
*Outside hole with rubber 7 mm*  
In PVC | *PVC made*



163530821 **NEW**



Colore Grigia | *Colour Gray*  
Misura 50/mtrs roll | *Size 50/mtrs roll*  
Foro interno 3 mm | *Inside hole 3 mm*  
Diametro esterno 6 mm | *Outside diameter 6 mm*  
Diametro esterno con rivestimento 7 mm |  
*Outside hole with rubber 7 mm*  
In PVC | *PVC made*



**CAPIGUAINA - CABLE ENDS****421830201**CAPOGUAINA Ø 5,5 x 9,5 MM | *CABLE ENDS* Ø 5,5 x 9,5 MMConfezione 10 pz. | *10 Pcs Packing***121858190**CAPOGUAINA Ø 6 x 10 MM | *CABLE ENDS* Ø 6 x 10 MMConfezione 50 pz. | *50 Pcs Packing***121858200**CAPOGUAINA Ø 7 x 11 MM | *CABLE ENDS* Ø 7 x 11 MMConfezione 50 pz. | *50 Pcs Packing***421830211**CAPOGUAINA Ø 4,5 x 9,5 MM NICHELATA | *NICHEL - PLATED CABLE ENDS* Ø 4,5 x 9,5 MMConfezione 10 pz. | *10 Pcs Packing***121858210**BUSSOLA GUAINA Ø 4,5 MM | *CABLE END* Ø 4,5 MMDimensioni 7x9 mm | *Dimensions 7x9 mm*Confezione 20 pz. | *20 Pcs Packing***PEDALI E PUNTAPIEDI - FOOTRESTS AND PEDALS****121510020**COPPIA PEDALI | *PEDALS PAIR*Tipo originale | *Standard type*

Ciao • Si

R.O. 191643



# CICLOMOTORE - MOPED

## ACCESSORI PEDALI - PEDALS ACCESSORIES

121530300



ASSE PEDALIERA | *CRANKLE SPINDLE*

28 Denti | *28 Teeth*

Ciao

R.O. 562222 - 610348M - 143063



121830120



BUSSOLA PEDALIERA | *AXLE BUSH*

Confezione 10 pz. | *10 Pcs Packing*

Ciao

R.O. 141737



## PEDIVELLE MESSA IN MOTO - KICK STARTER LEVERS

121530210



Coppia pedivelle sinistra-destra | *Left-Right crank levers*

Ciao

R.O. 180888, 180889



421830101



CHIAVELLA Ø9 mm | *PIN Ø 9mm*

Tornita, completa di rondella e dado | *Turned, complete with washer and nut*

Ciao • Si • Bravo • Grillo

R.O. 114219



## ACCESSORI TELAIO - CHASSIS ACCESSORIES

142580170



FLANGIA RUOTA POSTERIORE | *REAR WHEEL FLANGE*

Ciao • Si • Bravo

R.O. 124963





**SELLE - SEATS**

**142760022** **NEW** 



Si



**142760023** **NEW** 



Boxer



**142760024** **NEW** 



Bravo



**142760027** **NEW** 



Si FL



# CICLOMOTORE - MOPED

## SELLE - SEATS

142760089 **NEW**



Monoposto | *Single saddle*

Ciao



142760099 **NEW**



Sella anatomica con scatola attrezzi e serigrafia  
| *Anatomic saddle with toolbox and screen printing*

Puch 50



## ACCESSORI SELLE - SEATS ACCESSORIES

142760036 **NEW**



Copertina sella | *Seat cover*

SI

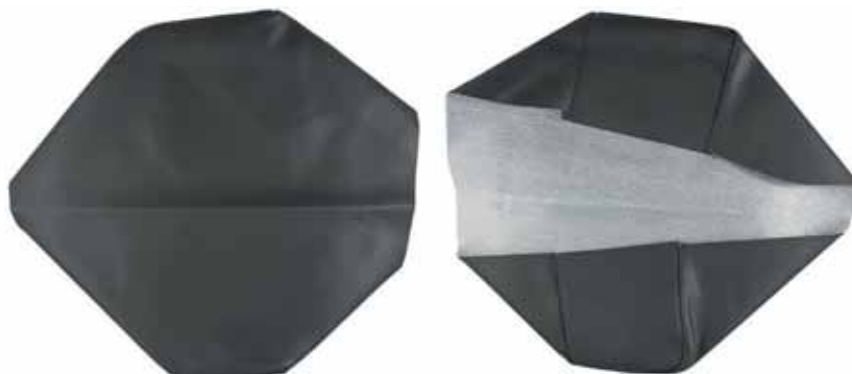

246050770 **NEW**



PIASTRINA CROMATA SERRATURA NEIMAN Ø  
Bohrloch 4,45 mm | *CHROMED PLATE NEIMAN LOCK*

Colore Cromato | *Colour Chromed*

Forma Goccia | *Shape Drop*

Note con scritta NEIMANN dritta | *Notes with straight NEIMANN logo*

Ciao •Ciao Euro1•Ciao Euro2•Ciao Mix

Teen•Ciao Tre Si •Boss•Boxer•Bravo

3•Bravo Erre 2•Si•Si FL2•SI

Mix•Superbravo•Superbravo3



# CUSCINETTI

BEARINGS



# CICLOMOTORE - MOPED

## CUSCINETTI A SFERE - BALL BEARINGS

100200240



Misure (mm) 15 - 35 - 11  
(6202 C3) | Size (mm) 15 - 35 - 11  
(6202 C3)

Asse ruota posteriore e albero motore | *Rear wheel axle and crankshaft*

Gabbia in nylon | *Nylon cage*

Ciao • Si

R.O. 102258



## GABBIE A RULLI - ROLLER CAGES

100151140



Confezione 5 Pz. | *Packing 5 Pcs*  
Misura: Ø 16x22x22 | *Size: Ø 16x22x22*

Campana frizione | *Pulley*

Ciao • Si • Boxer • Boss • Bravo

R.O. 120668



100151270



Confezione 5 Pz. | *Packing 5 Pcs*  
Misura: HK Ø 17x12 | *Size: HK Ø 17x12*  
Mozzo ruota posteriore | *Rear wheel axle*

Ciao • Si • Bravo

R.O. 103696



100151260



Confezione 5 Pz. | *Packing 5 Pcs*  
Misura: BK Ø 09x13x12 | *Size: BK Ø 09x13x12*  
Mozzo ruota posteriore | *Rear wheel axle*

Ciao • Si • Boxer • Boss • Bravo

R.O. 103613



100151000



Confezione 5 Pz. | *Packing 5 Pcs*  
Misura: Ø 12x18x12 | *Size: Ø 12x18x12*  
Carter motore | *Crankcase*  
Asse ruota posteriore | *Wheel axle*  
Mozzo ruota posteriore | *Rear wheel axle*

Bravo

R.O. 224309



## GABBIE A RULLI - ROLLER CAGES

**100151250**Confezione 5 Pz. | *Packing 5 Pcs*Misura: HK Ø 13x19x12 | *Size: HK Ø 13x19x12*Mozzo ruota posteriore | *Rear wheel axle*

Ciao • Si • Boxer • Boss • Bravo

R.O. 103614

**100151280**Confezione 5 Pz. | *Packing 5 Pcs*Misura: HK Ø 14x12 | *Size: HK Ø 14x12*Albero secondario | *Driven shaft*Dispositivo anti rollio | *Anti-roll device*Mozzo ruota posteriore | *Rear wheel axle*

Ciao • Si FL2 Mix • Boss • Bravo 3 • Erre 2 •

Grillo • Superbravo 3

R.O. 122671

**100151230**Confezione 5 Pz. | *Packing 5 Pcs*Misura: HK Ø 20x26x12 | *Size: HK Ø 20x26x12*Mozzo ruota posteriore | *Rear wheel axle*

Ciao • Si • Boxer • Boss • Bravo

R.O. 131509

**100151240**Confezione 5 Pz. | *Packing 5 Pcs*Misura: BK Ø 15x21x12 | *Size: BK Ø 15x21x12*Mozzo ruota posteriore | *Rear wheel axle*

Ciao • Si • Boxer • Boss • Bravo

R.O. 103689

**100150050**Confezione 5 Pz. | *Packing 5 Pcs*

Modello "DURKOP" per spinotto Ø 10x13x14,5 |

*Model for piston pin Ø 10x13x14,5*

Ciao • Si

R.O. 500521



# CICLOMOTORE - MOPED

## GABBIE A RULLI - ROLLER CAGES

100150150



Confezione 5 Pz. | *Packing 5 Pcs*

Modello "**DURKOP**" per spinotto Ø 12x15x15 |

*Model for piston pin Ø 12x15x15*

Ciao • Si • Peugeot



# TENUTA

TIGHT SYSTEM

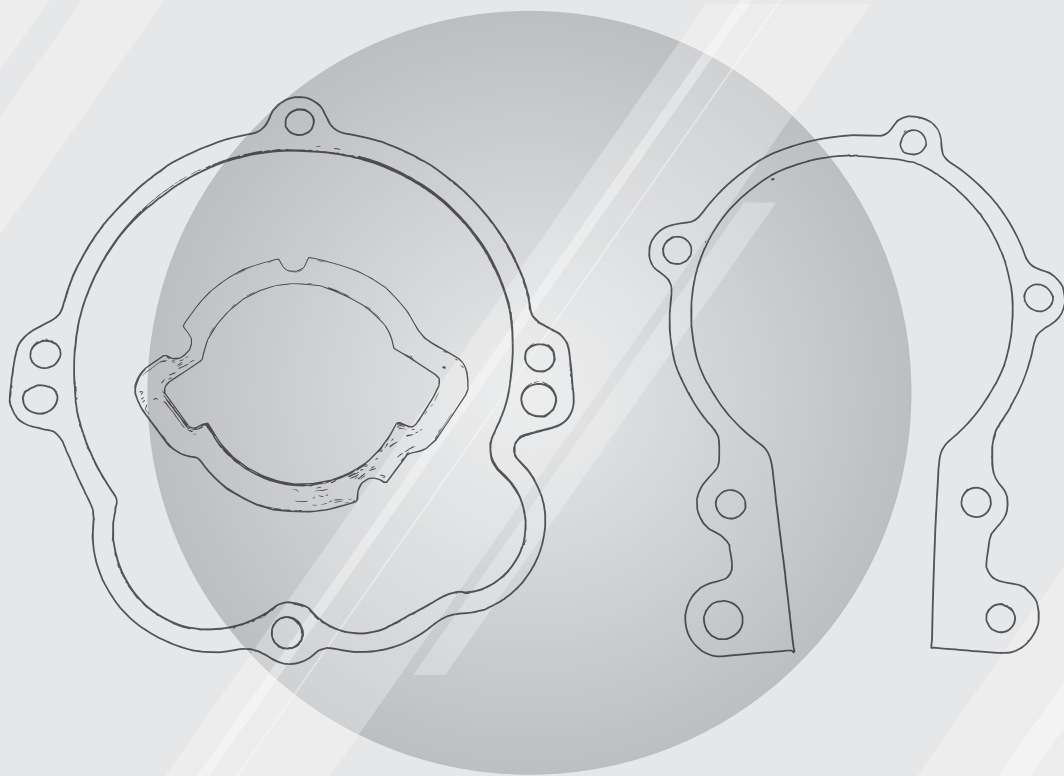

# CICLOMOTORE - MOPED

## GUARNIZIONI - GASKETS

### KIT GUARNIZIONI PIAGGIO

100684000



Ciao • Si • Bravo • Superbravo • Grillo • Boss



100689640



Per cilindro Ø43 MM - 10 008 1200 | For Ø43  
MM cylinder kit - 10 008 1200

Ciao • Si • Bravo • Superbravo • Grillo • Boss



## PAROLI - OIL SEALS

100660400



Misure 15-24-5 | Size 15-24-5

Albero Motore | Crankshaft

Ciao • Si • Bravo • Boss

R.O. 480464



100662550



Misure 22-35-6 | Size 22-35-6

Ruota Posteriore | Rear Wheel

Ciao • Si • Bravo • Superbravo • Grillo • Boss

R.O. 008752





# G O M M E

T I R E S



# CICLOMOTORE - MOPED

GOMME - TIRES

16"

993201001



**KENDA**

Misura 2 $\frac{3}{4}$  16 | Size 2 $\frac{3}{4}$  16  
Battistrada Slick | Tread Slick  
Pattern K327  
Indice di Carico 36 | Load Index 36  
Indice di velocità J | Speed Index J  
Coperture TT (Set copertura + camera) | Tyres  
TT (Kit tyre and inner tube)



997000670



**Continental**

Misura 2.00-16 | Size 2.00-16  
Battistrada KKS 10 | Tread KKS 10  
Cod. Continental 0127400  
Indice di Carico 20 | Load Index 20  
Indice di velocità B | Speed Index B  
Coperture TT (Set copertura + camera) | Tyres  
TT (Kit tyre and inner tube)



997000680



**Continental**

Misura 2 $\frac{1}{4}$  16 | Size 2 $\frac{1}{4}$  16  
Battistrada KKS 10 | Tread KKS 10  
Cod. Continental 0127600  
Indice di Carico 38 | Load Index 38  
Indice di velocità B | Speed Index B  
Coperture TT (Set copertura + camera) | Tyres  
TT (Kit tyre and inner tube)



997000690



**Continental**

Misura 2 $\frac{1}{2}$  16 | Size 2 $\frac{1}{2}$  16  
Battistrada KKS 10 | Tread KKS 10  
Cod. Continental 0127800  
Indice di Carico 42 | Load Index 42  
Indice di velocità B | Speed Index B  
Coperture TT (Set copertura + camera) | Tyres  
TT (Kit tyre and inner tube)



## GOMME - TIRES

997000750

**Continental**Misura 2 $\frac{3}{4}$  16 | Size 2 $\frac{3}{4}$  16

Battistrada KKS 10 | Tread KKS 10

Cod. Continental 0132700

RF

Indice di Carico 46 | Load Index 46

Indice di velocità J | Speed Index J

Coperture TT (Set copertura + camera) | Tyres

TT (Kit tyre and inner tube)



17"

993400001

**KENDA**

Misura 2.00 -17 | Size 2.00 -17

Battistrada Mich | Tread Mich

Pattern K77

Indice di Carico Non omologata | Load Index

Not homologated

Indice di velocità Non omologata | Speed Index

Not homologated

Coperture TT (Set copertura + camera) | Tyres

TT (Kit tyre and inner tube)



993400101

**KENDA**

Misura 2.50 -17 | Size 2.50 -17

Battistrada Off Road | Tread Off Road

Pattern K772A

Indice di Carico Non omologata | Load Index

Not homologated

Indice di velocità Non omologata | Speed Index

Not homologated

Coperture TL (Tubeless) | Tyres TL (Tubeless)



993400010

**KENDA**

Misura 2.25 -17 | Size 2.25 -17

Battistrada 33L | Tread 33L

Pattern K252

Indice di Carico 33 | Load Index 33

Indice di velocità L | Speed Index L

Coperture TL (Tubeless) | Tyres TL (Tubeless)



# CICLOMOTORE - MOPED

## GOMME - TIRES

997000700



**Continental** 

Misura 2.00 - 17 | *Size 2.00 - 17*  
Battistrada KKS 10 | *Tread KKS 10*  
Cod. Continental 0128400  
Indice di Carico 22 | *Load Index 22*  
Indice di velocità B | *Speed Index B*  
Coperture TT (Set copertura + camera) | *Tyres TT (Kit tyre and inner tube)*



997000710



**Continental** 

Misura 2¼ 17 | *Size 2¼ 17*  
Battistrada KKS 10 | *Tread KKS 10*  
Cod. Continental 0128800  
Indice di Carico 39 | *Load Index 39*  
Indice di velocità B | *Speed Index B*  
Coperture TT (Set copertura + camera) | *Tyres TT (Kit tyre and inner tube)*



997000720



**Continental** 

Misura 2½ 17 | *Size 2½ 17*  
Battistrada KKS 10 | *Tread KKS 10*  
Cod. Continental 0129000  
Indice di Carico 43 | *Load Index 43*  
Indice di velocità B | *Speed Index B*  
Coperture TT (Set copertura + camera) | *Tyres TT (Kit tyre and inner tube)*



997000760



**Continental** 

Misura 2¾ 17 | *Size 2¾ 17*  
Battistrada KKS 10 | *Tread KKS 10*  
Cod. Continental 0133100  
RF  
Indice di Carico 47 | *Load Index 47*  
Indice di velocità J | *Speed Index J*  
Coperture TT (Set copertura + camera) | *Tyres TT (Kit tyre and inner tube)*



## GOMME - TIRES

16"

993101003

**DURO**

Misura 2.50-16 | Size 2.50-16

Battistrada Rock | Tread Rock

Pattern HF311

N° Tele 4

Indice di Carico 36 | Load Index 36

Indice di velocità L | Speed Index L

Coperture TL (Tubeless) | Tyres TL (Tubeless)



## CAMERE D'ARIA - TUBES

999600001

**KENDA**

Misura 2.25/2.50-16 | Size 2.25/2.50-16

Valvola TR 6 | Valve TR 6

Valvola vulcanizzata munita di rondella bloccaggio | Vulcanized valve equipped with locking washer



999700001

**KENDA**

Misura 2.75-16 | Size 2.75-16

Valvola TR 4 | Valve TR 4

Valvola vulcanizzata munita di rondella bloccaggio | Vulcanized valve equipped with locking washer



999900001

**KENDA**

Misura 2.00/2.25-17 | Size 2.00/2.25-17

Valvola TR 4 | Valve TR 4

Valvola vulcanizzata munita di rondella bloccaggio | Vulcanized valve equipped with locking washer



# CICLOMOTORE - MOPED

## CAMERE D'ARIA - TUBES

999900101



**KENDA**

Misura 2.25/2.50-17 | Size 2.25/2.50-17

Valvola TR 4 | Valve TR 4

Valvola vulcanizzata munita di rondella bloccaggio | Vulcanized valve equipped with locking washer



999900201



**KENDA**

Misura 2.50/2.75-17 | Size 2.50/2.75-17

Valvola TR 4 | Valve TR 4

Valvola vulcanizzata munita di rondella bloccaggio | Vulcanized valve equipped with locking washer



# OFFICINA

WORKSHOP



# CICLOMOTORE - MOPED

## ATTREZZI E UTENSILI - TOOLS

267000010



ATTREZZO TENDICAVO FRENO FRIZIONE |  
BRAKE AND CLUTCH CABLE TENSIONER TOOL



267000030



LEVA GOMME CICLOMOTORE | MOPED TIRES  
LEVER



267000490



CAVALLETTO BASE MOBILE | MOVABLE STAND  
Portata massima: 250Kg | Maximum Weight:  
250Kg



## MINUTERIA METALLICA - HARDWARE

121856201 **NEW**



TAPPO SCARICO OLIO M8X10mm | OIL DRAIN  
CUP M8X10mm  
Confezione 5 pz. | 5 Pcs Packing  
Applicazioni varie | Various applications  
R.O. 138345



121858590



VITE FISSAGGIO FIANCATINE | SIDE COVER  
FASTNER

Confezione 6 pz. | 6 Pcs Packing  
34 mm | 34 mm

Si • Si FL • Bravo • 82





MINUTERIA METALLICA - HARDWARE

121858591



VITE FISSAGGIO FIANCATINE | *SIDE COVER*  
*FASTNER*  
 Confezione 6 pz. | *6 Pcs Packing*  
 27,5 mm | *27,5 mm*  
 Ciao PX



121858592



VITE FISSAGGIO FIANCATINE | *SIDE COVER*  
*FASTNER*  
 Confezione 6 pz. | *6 Pcs Packing*  
 23,5 mm | *23,5 mm*  
 Ciao PX



121858600



VITE FISSAGGIO FIANCATINE | *SIDE COVER*  
*FASTNER*  
 Confezione 10 pz. | *10 Pcs Packing*  
 Ciao • Si



121890120



MOLLA VITE FISSAGGIO FIANCATINE | *SIDE*  
*COVER FASTNER SPRING*  
 Confezione 25 pz. | *25 Pcs Packing*  
 Ciao PX • Si • Si FL • Bravo • 82



121858594



KIT MOLLA + VITE FIANCATINE | *KIT SIDE*  
*COVER SPRING + FASTNER*  
 Confezione 6 + 6 pz. | *6 + 6 Pcs Packing*  
 34 mm | *34 mm*  
 Si • Si FL2





# GENERICCO

770	<b>TUBAZIONE BENZINA E ACCESSORI</b>	FUEL HOSE AND ACCESSORIES	TUBOS GASOLINA Y ACCESORIOS	TUYAUX ESSENCE ET ACCESSOIRES
773	<b>CANDELE DI ACCENSIONE</b>	SPARK PLUGS	BUJIAS	BOUGIES
774	<b>LAMPADINE</b>	LAMPS	LAMPARAS	AMPOULES
779	<b>ACCESSORI</b>	ACCESSORIES	ACCESORIOS	ACCESSOIRES
782	<b>OFFICINA</b>	WORKSHOP	TALLER	ATELIER



## TUBAZIONE BENZINA - FUEL HOSE

### PVC PLASTIFICATO 63ShA - PLASTIFIED PVC 63ShA



Dimensioni (mm) <i>Dimensions (mm)</i>	Lunghezza (mt) <i>Length (mt)</i>	Applicazione <i>Application</i>	Codice RMS <i>RMS Code</i>	Codice a barre <i>Barcode</i>
Ø 2,2 x 4	5	Tubo miscelatore   <i>Mixer oil hose</i>	121690010	
Ø 2,5 x 5	5	Tubo miscelatore   <i>Mixer oil hose</i>	121690080	
Ø 3 x 5	5	Tubo sfiato benzina   <i>Fuel vent hose</i>	121690020	
Ø 4 x 7	5	Tubo per benzina   <i>Fuel hose</i>	121690030	
Ø 4 x 7	50	Tubo per benzina   <i>Fuel hose</i>	121690039	
Ø 5 x 7	5	Tubo per benzina   <i>Fuel hose</i>	121690090	
Ø 5 x 10	5	Tubo per benzina   <i>Fuel hose</i>	121690040	
Ø 5 x 10	50	Tubo per benzina   <i>Fuel hose</i>	121690049	
Ø 6 x 9	5	Tubo per benzina   <i>Fuel hose</i>	121690050	
Ø 6 x 9	50	Tubo per benzina   <i>Fuel hose</i>	121690059	
Ø 7 x 12	5	Tubo per benzina   <i>Fuel hose</i>	121690060	
Ø 7 x 12	50	Tubo per benzina   <i>Fuel hose</i>	121690069	
Ø 7 x 14	5	Tubo per benzina   <i>Fuel hose</i>	121690070	

**TUBAZIONE BENZINA - FUEL HOSE**

**PVC + 30% PU 65ShA**



Dimensioni (mm) Dimensions (mm)	Lunghezza (mt) Length (mt)	Applicazione Application	Codice RMS RMS Code	Codice a barre Barcode
Ø 4 x 7	5	Specifico per benzina verde ed olio   <i>Specific for unleaded fuel and oil</i>	121690031	
Ø 5 x 7	5	Specifico per benzina verde ed olio   <i>Specific for unleaded fuel and oil</i>	121690091	
Ø 5 x 10	5	Specifico per benzina verde ed olio   <i>Specific for unleaded fuel and oil</i>	121690041	
Ø 6 x 9	5	Specifico per benzina verde ed olio   <i>Specific for unleaded fuel and oil</i>	121690051	
Ø 7 x 12	5	Specifico per benzina verde ed olio   <i>Specific for unleaded fuel and oil</i>	121690061	
Ø 7 x 14	5	Specifico per benzina verde ed olio   <i>Specific for unleaded fuel and oil</i>	121690071	
Ø 6 x 13	5	Specifico per benzina verde ed olio   <i>Specific for unleaded fuel and oil</i>	121690081	

**POLIURETANO - POLYURETHANE**



Dimensioni (mm) Dimensions (mm)	Lunghezza (mt) Length (mt)	Applicazione Application	Codice RMS RMS Code	Codice a barre Barcode
Ø 4 x 7	1	Specifico per benzina verde ed olio   <i>Specific for unleaded fuel and oil</i>	121690100	
Ø 5 x 10	1	Specifico per benzina verde ed olio   <i>Specific for unleaded fuel and oil</i>	121690110	
Ø 6 x 9	1	Specifico per benzina verde ed olio   <i>Specific for unleaded fuel and oil</i>	121690120	
Ø 7 x 12	1	Specifico per benzina verde ed olio   <i>Specific for unleaded fuel and oil</i>	121690130	

**TPR/UML**



Dimensioni (mm) Dimensions (mm)	Lunghezza (mt) Length (mt)	Applicazione Application	Codice RMS RMS Code	Codice a barre Barcode
Ø Interno 6,5	1	Specifico per sistemi ad iniezione   <i>Specific for injection sistem</i>	121690140	
Ø Interno 7,5	1	Specifico per sistemi ad iniezione   <i>Specific for injection sistem</i>	121690150	

**121859010**



COLLARE TUBO BENZINA Ø 10-12 mm | FUEL

CLAMP Ø 10-12 mm

Confezione 5 pz. | 5 Pcs Packing



**121859020**



COLLARE TUBO BENZINA Ø 12-14 mm | FUEL

CLAMP Ø 12-14 mm

Confezione 5 pz. | 5 Pcs Packing



**121860020**



COLLARE TUBO BENZINA Ø 14-16 mm | FUEL

CLAMP Ø 14-16 mm

Confezione 5 pz. | 5 Pcs Packing



**121680060**



RACCORDO RAPIDO TUBO BENZINA Ø 6 mm |

FUEL HOSE QUICK CONNECTOR Ø 6 mm



**121680070**



RACCORDO RAPIDO TUBO BENZINA Ø 8 mm |

FUEL HOSE QUICK CONNECTOR Ø 8 mm



## CANDELE DI ACCENSIONE NGK - NGK SPARK PLUGS

Codice RMS RMS Code	Codice NGK NGK Code	Terminale-Terminal			Codice Champion Champion Code
		1	2	3	
246215210	B5HS	3			OE037 - L86C
246215051	B6HS	3			OE037 - L86C
246215074	B7ES	3			OE079 - N4C
246215054	B7HS	3			L82C
246215078	B8EG	3			OE078 - N3G
246215058	B8ES	3			OE068 - N3C
246215055	B8HS	3			L78C
246215987	B9EG	3			-
246215052	B9ES	3			OE091 - RN2C
246215992	B9HS	3			L77JC4
246215965	B10EG	3			-
246215017	BP6ES	3			OE001 - N9YC
246215080	BP6HS	3			OE007 - L87YC
246215064	BP7ES	3			OE010 - N7YC
246215079	BP8ES	3			OE087 - N6YC
246215022	BPR6ES	3			OE006 - RN9YC
246215068	BPR7ES	3			OE018 - RN7YC
246215036	BPR7HS	3			OE064 - RL82YC
246215019	BPR8ES	3			OE116 - RN6YC

Codice RMS RMS Code	Codice NGK NGK Code	Terminale-Terminal			Codice Champion Champion Code
		1	2	3	
246215081	BR6ES	3			RN5C - CCH123
246215029	BR6HS	3			RL86C - CCH830
246215072	BR6HSA	1			RL86C - CCH830
246215070	BR7ES	3			OE098 - RN4C
246215008	BR7HS	3			OE086 - RL82C
246216023	BR8ECM	2			QN86
246215045	BR8EG	3			OE108 - RN3C
246215009	BR8ES	3			OE108 - RN3C
246215000	BR8HS	3			RL78C
246216039	BR9EG-N-8	2			-
246215020	BR9HS	3			QL77JC4
246215069	BR8HSA	1			L78C
246215063	BR9EG	3			OE091 - RN2C
246215044	BR9EIX	3			-
246215050	BR9ES	3			OE091 - RN2C
246216010	BR10ECMIX	2			QN86
246215023	BR10EG	3			RN57YCC - CCH954
246216014	BR10EIX	3			-
246215082	BR10ES	3			RN1C - RN1C/T10







## CANDELE DI ACCENSIONE CHAMPION - CHAMPION SPARK PLUGS

Codice RMS RMS Code	Barcode	Codice Champion Champion Code
246213010		CCH123 - RN5C
246211580		CCH830 - RL86C
246210460		CCH83321
246210490		CCH84151
246210530		CCH88141
246210550		CCH89021
246210560		CCH89041
246211090		L77JC4
246210200		L78C
246210130		L82C
246211720		OE004 - RN9YCC
246211120		OE007 - L87YC
246211690		OE008 - RN7YCC
246211680		OE018 - RN7YC
246210100		OE037-L86C
246211710		OE048 - RN9YC4





Codice RMS RMS Code	Barcode	Codice Champion Champion Code
246211570		OE064 - RL82YC
246210590		OE068 - N3C
246210340		OE074-N5C
246210360		OE078-N3G
246210230		OE079-N4C
246210430		OE086 - RL82C
246210320		OE087-N6YC
246210270		OE091-RN2C
246211640		OE098 - RN4C
246210600		OE108-RN3C
246211290		QL77JC4
246210310		RL78C
246211590		RL87YC
246210670		RN1C
246211650		RN57YCC - CCH954

## LAMPADINE - LAMPS























### LAMPADINE ALOGENE - HALOGEN LAMPS

BA7s				Volt [V]	Watt [W]		
246510666	<b>NEW</b>		 Germany		6	1,2	
246510676	<b>NEW</b>		 Germany		12	2	











BA9s				Volt [V]	Watt [W]	Note	
246510335					6	4	
246510415					12	4	





  









BA15s				Volt [V]	Watt [W]	Note		
246510215					12	10		
246510235					12	10		
246510195					12	21		
246510205					12	21		
246515075			<b>OSRAM</b>	 <b>E-MARK</b>	12	21		Auto Original Line 7506
246510656			 Germany	 <b>E-MARK</b>	6	10	R10W	
246515113			<b>OSRAM</b>	 <b>E-MARK</b>	12	10	Auto Original Line 5008	
246510646			 Germany	 <b>E-MARK</b>	6	5	R5W	
246515111			<b>OSRAM</b>	 <b>E-MARK</b>	12	5	Auto Original Line 5007	







## LAMPADINE - LAMPS

















BAU15s		Volt [V]	Watt [W]	Note	
246515077	 <b>OSRAM</b>  <b>E-MARK</b>	12	21	Auto Original Line 7507	
246510465		12	21	S25	
246510456	  <b>OSRAM</b>  <b>E-MARK</b>	12	10	RY10W	
246515115	 <b>OSRAM</b>  <b>E-MARK</b>	12	10	Auto Original Line 5009	













BAY15d		Volt [V]	Watt [W]	Note	
246510365		12	21/5	P21/5W	
246515082	 <b>OSRAM</b>  <b>E-MARK</b>	12	21/5	Auto Original Line 7528	





BA20d		Volt [V]	Watt [W]	Note	
246510346	  <b>OSRAM</b>  <b>E-MARK</b>	6	25/25	S1	
246510306	  <b>OSRAM</b> 	12	25/25	S1	
246515166	 <b>OSRAM</b>  <b>E-MARK</b>	12	25/25	Moto Original Line 64326	

BA20d		Volt [V]	Watt [W]	Note	
246510696 <b>NEW</b>	  <b>OSRAM</b> 	12	25/25		



## LAMPADINE - LAMPS













BA20d				Volt [V]	Watt [W]	Note	
246510325				12	45/40	S1	
246510319				12	35/35	S2	
246510351		 Germany		12	35/35	S2	
246510356		 Germany		12	35/35	S2	
246515167					12	35/35	





P26S				Volt [V]	Watt [W]	Note		
246510420				12	15	S2		
246510425				12	15	S2		
246510476		 Germany			6	15	SB25	
246510296		 Germany			12	15	SB25	

P26S				Volt [V]	Watt [W]		
246510686		 Germany		12	15		



















## LAMPADINE - LAMPS





P45T			Volt [V]	Watt [W]	Note	
246510105			12	45/40	R2	

SILURO			Volt [V]	Watt [W]	Note	
246510156			6	5	T11, 35 mm	
246510175			12	5	T11, 39 mm	
246510165			12	10	T11, 39 mm	
246510626			6	10	T11, 40 mm	
246510126			6	15	T11, 42 mm	
246510136			6	18	T15, 44 mm	
246510145			12	15	T11, 44 mm	

W2x4,6d			Volt [V]	Watt [W]	Note	
246515104		<b>OSRAM</b>	12	1,2	Auto Original Line 2721	
246510245			12	1.2	W1,2W T5	
246510275			12	2.3	W2,3W T5	

## LAMPADINE - LAMPS

W2,1x9,5d				Volt [V]	Watt [W]	Note		
246515096		<b>OSRAM</b>			12	16	Auto Original Line 921	
246510265					12	3	W3W, T10	
246510280					12	5	W5W	
246515033		<b>OSRAM</b>			12	5	Cool Blue 2825HCB1 2pz. - 2pcs	
246515091		<b>OSRAM</b>			12	5	Auto Original Line 2825	
246510285					12	5	W5W, T10	
246515093		<b>OSRAM</b>			12	5	Auto Original Line 2827	

H4				Volt [V]	Watt [W]	Note		
246510065					12	35/35	P43T	
246510055					12	60/55	P43T	

## KIT RIPARAZIONE PNEUMATICI - REPAIR KITS FOR TIRES

267200890



GONFIA E RIPARA SPRAY Conf. 200 ml |  
INFLATE AND REPAIR 200 ml

267202027 **NEW**

GONFIA E RIPARA SPRAY Conf. 300 ml |  
INFLATE AND REPAIR 300 ml



267200600



FLACONE 250 ML DI PRODOTTO SIGILLANTE

- Tecnologia gel
  - Facilmente lavabile ad acqua
- 250 ML SEALANT BOTTLE
- Gel technology
  - Washed off with water



567020200



SCATOLA 12 TUBETTI MASTICE 22 cc | PACK 12  
TUBES RUBBER CEMENT 22 cc



## KIT RIPARAZIONE PNEUMATICI - REPAIR KITS FOR TIRES

**567020060**



KIT RIPARAZIONE CAMERA D'ARIA (no Tubeless)

Confezione in blister composto da:

- 5 pezze assortite
- 1 tubetto mastice 10 cc
- 1 raschietto

*INNER TUBE REPAIR KIT*

*Blister packaging with:*

- 5 tyre repair patches
- 1 Rubber cement 10 cc tube
- 1 Scraper



**267020020**



KIT RIPARAZIONE COPERTURA TUBELESS IN SCATOLA COMPOSTO DA:

- 1 tubetto mastice 22 cc
- 2 punteruoli 1 taglierino
- 5 pezzi di pura gomma

*TUBELESS TYRE REPAIR KIT WITH:*

- 1 Tyre rubber cement 22 cc tube
- 2 Awles 1 Cutter
- 5 rubber sticks



**267020030**



STECHE DI GOMMA PER RIPARAZIONE TUBELESS | TYRE REPAIRING RUBBER STICKS



## KIT PRIMO SOCCORSO - FIRST AID KIT

267002060



Conforme DIN13167 - 2014 | *Conforms to  
DIN13167 - 2014*

## Contenuto:

- 1 x rotolo cerotto adesivo
- 4 x bende adesive (10 x 6cm)
- 2 x cerotti resistenti all'acqua confezionati singolarmente (4 x 6,5 cm)
- 2 x cerotti resistenti all'acqua (12 x 2 cm)
- 2 x cerotti resistenti all'acqua confezionati singolarmente (1,9 x 7,2 cm)
- 4 x cerotti resistenti all'acqua confezionati singolarmente (2,5 x 7,2 cm)
- 1 x tampobenda sterile (8 x 10 cm)
- 1 x tampobenda sterile (10 x 12 cm) 1 x fasciatura sterile (ustioni)
- 1 x coperta isotermica d'emergenza 1 x forbici
- 4 x guanti monouso
- 2 x salviettine umidificate confezionate singolarmente 1 x lista del contenuto
- 1 x manuale kit pronto soccorso

*Kit contents:*

- 1 x adhesive plaster tape
- 4 x adhesive plaster bandages (10 x 6cm)
- 2 x water resistant single-packed plasters (4 x 6,5 cm)
- 2 x water resistant plasters (12 x 2 cm)
- 2 x water resistant single-packed plasters (1,9 x 7,2 cm)
- 4 x water resistant single-packed plasters (2,5 x 7,2 cm)
- 1 x first aid bandage roll (8 x 10 cm)
- 1 x first aid bandage roll (10 x 12 cm) 1 x sterile dressing (burns)
- 1 x first aid blanket 1 x scissors
- 4 x disposable gloves
- 2 x single-packed wet wipes 1 x list of contents
- 1 x first aid kit manual



## PRODOTTI OFFICINA - WORKSHOP TOOLS

142740010



MISURINO CENTILITRATO PER MISCELA 2%  
DA 10 CL. | OIL DOSAGE BEAKER 2% - 10 CL.  
Confezione Pz. 10 | 10 Pcs Packing



142740020



MISURINO CENTILITRATO DA 10 CL. DOPPIA  
CENTILITRATURA 2/4% | DOSAGE BEAKER 2/4%  
10 CL.  
Con coperchio | With cap



## FASCETTE IN PLASTICA - PLASTIC CABLE TIES



	Confezione Packing	Dimensioni (mm) Dimensions (mm)	Colore Color	Codice RMS RMS Code	Codice a barre Barcode
	100 pz.   100 pcs	2,5 x 98	Nero   Black	121859120	
	100 pz.   100 pcs	2,6 x 200	Nero   Black	121859130	
	100 pz.   100 pcs	3,5 x 200	Nero   Black	121859140	
	100 pz.   100 pcs	4,5 x 160	Nero   Black	121859150	
	100 pz.   100 pcs	4,5 x 290	Nero   Black	121859160	



PRODOTTI OFFICINA - WORKSHOP TOOLS

267252091 **NEW** 



MOTORBIKE 2T STREET  
1L  
SEMISINTETICO | SEMI SYNTHETIC



267252092 **NEW** 



MOTORBIKE 2T STREET  
20L  
SEMISINTETICO | SEMI SYNTHETIC



267252093 **NEW** 



MOTORBIKE 2T STREET  
60L  
SEMISINTETICO | SEMI SYNTHETIC



267252087 **NEW** 



MOTORBIKE 2T SYNTH STREET RACE  
1L  
100% SINTETICO | 100% SYNTHETIC



267252088 **NEW** 



MOTORBIKE 2T SYNTH STREET RACE  
20L  
100% SINTETICO | 100% SYNTHETIC



267252096 **NEW** 



MOTORBIKE 2T BASIC SCOOTER STREET  
1L  
MINERALE | MINERAL



267252097 **NEW**



**LIQUI  
MOLY**

MOTORBIKE 2T BASIC SCOOTER STREET  
4L  
MINERALE | *MINERAL*



267252098 **NEW**



**LIQUI  
MOLY**

MOTORBIKE 2T BASIC SCOOTER STREET  
60L  
MINERALE | *MINERAL*



267252094 **NEW**



**LIQUI  
MOLY**

MOTORBIKE 2T SEMISYNTH SCOOTER STREET  
500ml  
SEMISINTETICO | *SEMI SYNTHETIC*



267252095 **NEW**



**LIQUI  
MOLY**

MOTORBIKE 2T SEMISYNTH SCOOTER STREET  
1L  
SEMISINTETICO | *SEMI SYNTHETIC*



267252089 **NEW**



**LIQUI  
MOLY**

MOTORBIKE 2T SYNTH SCOOTER STREET RACE  
1L  
100% SINTETICO | *100% SYNTHETIC*



267252090 **NEW**



**LIQUI  
MOLY**

MOTORBIKE 2T SYNTH SCOOTER STREET RACE  
20L  
100% SINTETICO | *100% SYNTHETIC*



PRODOTTI OFFICINA - WORKSHOP TOOLS

267252138 **NEW** 



OLIO MOTORE CLASSIC SAE 30 | CLASSIC  
MOTOR OIL SAE 30 - 1L  
1L  
MINERALE | MINERAL



267252063 **NEW** 



MOTORBIKE HD-CLASSIC SAE 50 STREET  
1L  
MINERALE | MINERAL



267252064 **NEW** 



MOTORBIKE HD-CLASSIC SAE 50 STREET  
4L  
MINERALE | MINERAL



267252112 **NEW** 



MOTORBIKE GEAR OIL 10W-30  
1L  
TECNOLOGIA SINTETICA | SYNTHETIC  
TECHNOLOGY



267252106 **NEW** 



MOTORBIKE GEAR OIL 75W-90  
1L  
100% SINTETICO | 100% SYNTHETIC



267252107 **NEW** 



MOTORBIKE GEAR OIL 75W-90  
500ml  
100% SINTETICO | 100% SYNTHETIC



267252108 **NEW** 

**LIQUI  
MOLY**

MOTORBIKE GEAR OIL 75W-90  
1L  
100% SINTETICO | 100% SYNTHETIC



267252109 **NEW** 

**LIQUI  
MOLY**

MOTORBIKE GEAR OIL 75W-90  
20L  
100% SINTETICO | 100% SYNTHETIC



267252110 **NEW** 

**LIQUI  
MOLY**

MOTORBIKE GEAR OIL 75W-140 (GL5) VS  
60  
100% SINTETICO | 100% SYNTHETIC



267252115 **NEW** 

**LIQUI  
MOLY**

MOTORBIKE GEAR OIL (GL4) 80W-90 SCOOTER  
500ml  
MINERALE | MINERAL



267252114 **NEW** 

**LIQUI  
MOLY**

MOTORBIKE GEAR OIL 80W-90  
150ml  
MINERALE | MINERAL



267252113 **NEW** 

**LIQUI  
MOLY**

MOTORBIKE GEAR OIL (GL4) 80W  
1L  
MINERALE | MINERAL



PRODOTTI OFFICINA - WORKSHOP TOOLS

267252111 **NEW**



**LIQUI  
MOLY**

MOTORBIKE GEAR OIL HD 150  
1L  
100% SINTETICO | 100% SYNTHETIC



267202021 **NEW**



**LIQUI  
MOLY**

MOTORBIKE DETERGENTE FILTRO ARIA |  
MOTORBIKE AIR FILTER CLEANER  
1L



267252135 **NEW**



**LIQUI  
MOLY**

MOTORBIKE OLIO PER FILTRI ARIA |  
MOTORBIKE OIL FOR AIR FILTERS  
500ml



267252136 **NEW**



**LIQUI  
MOLY**

MOTORBIKE OLIO PER FILTRI ARIA |  
MOTORBIKE AIR FILTER OIL  
1L



267252137 **NEW**



**LIQUI  
MOLY**

MOTORBIKE OLIO PER FILTRI ARIA SPRAY |  
MOTORBIKE AIR FILTER OIL SPRAY  
400ml



267202062 **NEW**



**LIQUI  
MOLY**

TANICA PER CAMBIO OLIO 10L | 10L OIL  
CHANGE TANK



267202000 **NEW**



**LIQUI  
MOLY**

### MOTORBIKE MOS2 SHOOTER

20ml

ADDITIVO Per tutti i motori a 2 tempi con lubrificazione separata e a miscela, nonché per i motori a 4 tempi anche con frizione multidisco a bagno d'olio. Adatto anche per l'impiego in trasmissioni e azionamenti finali. Dosaggio: 20 ml (1 tubetto) è sufficiente per 1 l di olio motore. Con motori a 2 tempi: 10 ml per ogni 10 l di miscela di carburante o 20 ml per ogni 1 l di olio per motori a 2 tempi. Testato per catalizzatore.

*ADDITIVE For all 2-stroke engines with separate and mixture lubrication and for all 4-stroke engines also with wet multi-disc clutch. Also suitable for use in transmissions and final drives. Dosage: 20 ml (1 tube) is sufficient for 1 l of motor oil. 2-stroke engines: 10 ml per 10 l of fuel mixture or 20 ml for 1 l of 2-stroke oil. Tested on engines with catalytic converters.*



267202006 **NEW**



**LIQUI  
MOLY**

### MOTORBIKE 2T BIKE-ADDITIVE

250ml

ADDITIVO Adatto per tutti i motori a 2 tempi con miscela o lubrificazione separata. Un dosatore da 25 ml pieno è sufficiente per 5 l di carburante. *ADDITIVE For all 2-cycle engines with mixed or separate lubrication. One filling with the dispenser (25 ml) is sufficient for 5 l fuel or fuel mixture.*



267202007 **NEW**



**LIQUI  
MOLY**

### MOTORBIKE SPEED SHOOTER

80ml

ADDITIVO Per motori a benzina a 2 e 4 tempi (carburatore e iniettori). 80 ml sono sufficienti per max. 10 litri di carburante. Impiego consigliato ad ogni rifornimento! *ADDITIVE For 2-stroke and 4-stroke gasoline engines (aspirated and injection). 80 ml is sufficient for up to 10 liters of fuel. Recommended for use at each refueling.*



PRODOTTI OFFICINA - WORKSHOP TOOLS

267202008 **NEW**



MOTORBIKE SPEED ADDITIVE

150ml

ADDITIVO Da aggiungere al carburante di tutti i motori a benzina a 4 e 2 tempi. Il contenuto della lattina è sufficiente per max. 20 l di carburante. | *ADDITIVE Added to the fuel of all 4-stroke and 2-stroke gasoline engines. Contents of can are sufficient to treat up to 20 liters of fuel.*



267202009 **NEW**



STABILIZZATORE PER BENZINA | FUEL

STABILIZER

250ml

ADDITIVO Adatto a tutti i motori a benzina a 4 e 2 tempi – in particolare per l'impiego preventivo. Testato per turbo e catalizzatore. Un dosatore pieno (25 ml) è sufficiente per 5 l di carburante. | *ADDITIVE Suitable for all 4-stroke and 2-stroke gasoline engines – especially for preventive care. Tested for turbochargers and catalytic converters. Filling the dosage chamber (25 ml) once is sufficient for 5 liters of fuel.*



267202054 **NEW**



OCTANE PLUS

150ml

ADDITIVO Per aumentare il numero di ottano della benzina in veicoli senza filtro per il particolato. | *ADDITIVE For increasing the octane number of gasolines in vehicles without particulate filters.*



267200130



PASTA PER GUARNIZIONI MOTORSIL D ROSSA (60 Gr) | *RED MOTORSIL D GASKET SEALANT (60 Gr)*



267200140



PASTA PER GUARNIZIONI MOTORBLACK  
NERA (60 Gr) | *BLACK MOTORBLACK GASKET  
SEALANT (60 Gr)*



267200160



VERNICE SPRAY NERO OPACO PER MARMITTE  
(400 ml) | *EXHAUSTS MATT BLACK SPRAY  
PAINT (400 ml)*



267200162



VERNICE SPRAY TRASPARENTE PER MARMITTE  
(400 ml) | *EXHAUSTS TRANSPARENT SPRAY  
PAINT (400 ml)*



267200170



FRENAFILETTI FORTE (10 ml) | *THREADLOCKER  
STRONG (10 ml)*



267200400



FRENAFILETTI MEDIO (50 ml) | *MEDIUM  
THREADLOCKER (50 ml)*



267202057 **NEW**



FRENAFILETTI EXTRAFORTE (10 g) |  
*EXTRASTRONG THREADLOCKER (10 g)*





PRODOTTI OFFICINA - WORKSHOP TOOLS

267202056 **NEW**



FRENAFILETTI MEDIO (10 g) | *MEDIUM  
THREADLOCKER (10 g)*



267200310



MASTICE PER GUARNIZIONE (100 ml) | *SEALING  
GASKET CEMENT (100 ml)*



267200840



SPRAY STARTER (200 ml) | *STARTER SPRAY  
(200 ml)*



267202038 **NEW**



STAR FIX (200 ml) | *STAR FIX (200 ml)*



267200420



PULITORE SISTEMA ASPIRAZIONE E  
CARBURATORE (500 ml) | *CARBURETOR  
CLEANER (500 ml)*



267202030 **NEW**



PULITORE CORPI FARFALLATI MOTO (400 ml) |  
*CARBURETOR CLEANER (400 ml)*



267202065 **NEW**



**LIQUI  
MOLY**

PULITORE CORPI FARFALLATI GENERICO  
(300 ml) | *CARBURETOR CLEANER (300 ml)*



267200460



**arexons**

SVITOL PROFESSIONAL SILIKON  
IMPERMEABILIZZANTE LUBRIFICANTE  
(400 ml) | *PROFESSIONAL SVITOL SILIKON  
WATERPROOFING LUBRICANT (400 ml)*



267200480



**arexons**

SVITOL PROFESSIONAL GRASSO LUBRIFICANTE  
AD ALTE PRESTAZIONI PTFE (400 ml) | *SVITOL  
PROFESSIONAL PTFE HIGH PERFORMANCE  
LUBRICATING GREASE (400 ml)*



267202037 **NEW**



**LIQUI  
MOLY**

MULTI-SPRAY PLUS 7 (500 ml) | *MULTI-SPRAY  
PLUS 7 (500 ml)*



267202032 **NEW**



**LIQUI  
MOLY**

SPRAY SILICONICO (300 ml) | *SILICON SPRAY  
(300 ml)*



267200550



**arexons**

RIPARA METALLO (57 gr) | *METAL REPAIRER  
(57 gr)*



PRODOTTI OFFICINA - WORKSHOP TOOLS

267200850



RIPARA PLASTICA (57gr) | *PLASTIC REPAIR*  
(57gr)



267200570



CARBOSILICIUM ACQUA GRANA FINE | *FINE-GRAIN CARBOSILICIUM WATER*  
scatola in metallo, 70 ml | *Metal box, 70 ml*



267200580



GRASSO AL LITIO NLGI 3 (0,85 kg) | *LITHIUM GREASE NLGI 3 (0,85 kg)*



267202028 **NEW**



GRASSO LM 50 LITIO HT (400 g) | *LITHIUM GREASE LM 50 LITIO HT (400g)*



267200640



PULITORE FRENI E METALLI (500 ml) | *MOTORCYCLE BRAKES AND METAL PARTS CLEANER (500 ml)*



267202016 **NEW**



PULITORE FRENI E CATENE (500 ml) | *MOTORCYCLE BRAKES AND CHAINS CLEANER (500 ml)*



267200880



PULITORE CATENA E FRENI | *CHAIN AND BRAKE CLEANER*  
 Confezione 400 ml | *400 ml Packing*



267200650



TURAFALLE METALLICO (25 gr) | *METALLIC SEALING COMPOUND (25 gr)*



267200660



GRASSO CUSCINETTI AL LITIO (500 ml) | *BEARING LITHIUM GREASE (500 ml)*



267200670



GRASSO CUSCINETTI AL LITIO (1000 ml) | *BEARING LITHIUM GREASE (1000 ml)*



267202033 **NEW**



GRASSO PER POLI BATTERIA (50g) | *GREASE FOR BATTERY POLES (50g)*



267202034 **NEW**



GRASSO MULTIUSO (1KG) | *MULTIUSE GREASE (1KG)*



PRODOTTI OFFICINA - WORKSHOP TOOLS

267200710



PASTA MONTAGGIO MARMITTE (80 ml) |  
EXHAUST-MUFFLER SEALANT (80 ml)



267202029 **NEW**



PASTA PER MONTAGGIO PNEUMATICI BIANCA |  
WHITE TIRE ASSEMBLY PASTE



267202036 **NEW**



PASTA PER MONTAGGIO PNEUMATICI NERA |  
BLACK TIRE ASSEMBLY PASTE



267200120



LIQUIDO FRENI DOT 4 (175 ml) | BRAKE FLUID  
DOT 4 (175 ml)



267202035 **NEW**



LIQUIDO FRENI RACING (250 ml) | BRAKE  
FLUID RACING (250 ml)



267202060 **NEW**



LIQUIDO FRENI DOT4 (250 ml) | BRAKE FLUID  
DOT4 (250 ml)



267202063 **NEW**



**LIQUI  
MOLY**

LIQUIDO FRENI DOT5.1 (250ML) | BRAKE FLUID  
DOT5.1 (250ML)



267200950



**arexons**

BOBINA ASCIUGATUTTO - MULTI WIPER 2  
ROTOLI | TWO ROLLS PAPER - MULTI WIPER  
Strappi | Tear  
1000 pz. (500 a rotolo) | 1000 pcs. (500 each  
roll)



267201072 **NEW**



GUANTI SPESSI NERI | THICK BLACK GLOVES  
Taglia M | Size M  
50 Guanti | 50 Gloves



267201073 **NEW**



GUANTI SPESSI NERI | THICK BLACK GLOVES  
Taglia L | Size L  
50 Guanti | 50 Gloves



267201074 **NEW**



GUANTI SPESSI NERI | THICK BLACK GLOVES  
Taglia XL | Size XL  
50 Guanti | 50 Gloves



267201078 **NEW**



GUANTI NITRILE NERI | BLACK NITRILE GLOVES  
Taglia M | Size M  
100 Guanti | 100 Gloves



PRODOTTI OFFICINA - WORKSHOP TOOLS

**267201079** **NEW**



GUANTI NITRILE NERI | *BLACK NITRILE GLOVES*

Taglia L | *Size L*

100 Guanti | *100 Gloves*



**267201080** **NEW**



GUANTI NITRILE NERI | *BLACK NITRILE GLOVES*

Taglia XL | *Size XL*

100 Guanti | *100 Gloves*



**267201081** **NEW**



GUANTI NITRILE AZZURRI | *BLUE NITRILE GLOVES*

Taglia M | *Size M*

100 Guanti | *100 Gloves*



**267201082** **NEW**



GUANTI NITRILE AZZURRI | *BLUE NITRILE GLOVES*

Taglia L | *Size L*

100 Guanti | *100 Gloves*



**267201083** **NEW**



GUANTI NITRILE AZZURRI | *BLUE NITRILE GLOVES*

Taglia XL | *Size XL*

100 Guanti | *100 Gloves*



**267201010**



SVITOL LUBRIFICANTE (500 ml) | *SVITOL LUBRICANT SPRAY (500 ml)*



267201020 **NEW**



SVITOL LUBRIFICANTE (200 ml) | *SVITOL*  
LUBRICANT SPRAY (200 ml)



267200490



SVITOL PROFESSIONAL LUBRIFICANTE AL LITIO  
(400 ml) | *SVITOL PROFESSIONAL LITHIUM*  
LUBRICANT (400 ml)



267200500



SVITOL PROFESSIONAL PULITORE CONTATTI  
(400 ml) | *SVITOL PROFESSIONAL CONTACTS*  
CLEANER (400 ml)



267202022 **NEW**



MOTORBIKE MULTISPRAY (400 ml) |  
*MOTORBIKE MULTISPRAY (400 ml)*



267201040 **NEW**



PASTA LAVAMANI (5 lt) | *SOOTHING HAND*  
CLEANING PASTE (5 lt)



267202039 **NEW**



DETERGENTE RAPIDO PRO (500ml) | *PRO*  
QUICK CLEANER (500ml)





PRODOTTI OFFICINA - WORKSHOP TOOLS

267202040 **NEW**



PASTA LAVAMANI LIQUIDA (500ml) | *LIQUID HANDWASH PASTE (500ml)*



267202041 **NEW**



PASTA LAVAMANI (500ml) | *SOOTHING HAND CLEANING PASTE (500ml)*



267202042 **NEW**



GUANTO INVISIBILE (650ml) | *INVISIBLE GLOVE (650ml)*



267200200



FULCRON CONCENTRATO SUPERPULITORE SGRASSANTE NON TOSSICO (500 ml) | *FULCRON CONDENSED GREASE REMOVER (500 ml)*



267200210



FULCRON CONCENTRATO SUPERPULITORE SGRASSANTE NON TOSSICO (5 Lt.) | *FULCRON CONDENSED GREASE REMOVER (5 Lt.)*



267200990



FULCRON IGIENIZZANTE SUPERFICI 75% ALCOOL ANTI COVID-19 (500 ml) | *FULCRON SURFACES SANITIZER 75% ALCOOL ANTI-COVID 19 (500 ml)*



267201000



FULCRON IGIENIZZANTE SUPERFICI 75%  
ALCOOL ANTI COVID-19 (5 Lt.) | *FULCRON*  
*SURFACES SANITIZER 75% ALCOOL ANTI-*  
*COVID 19 (5 Lt.)*



267202031 **NEW**



SOLVENTE ANTIRUGGINE CERAMICO SHOCK  
(300ml) | *CERAMIC SHOCK ANTI-RUST*  
*SOLVENT (300ml)*



267202043 **NEW**



CONVERTITORE DI RUGGINE XXL (600ml) | *XXL*  
*RUST CONVERTER (600ml)*



267202055 **NEW**



PASTA RAMATA (100g) | *COPPER PASTA (100g)*



267200300



PELLE DI DAINO SINTETICA Pelle di daino  
sintetica Wizzy | *SYNTHETIC LEATHER Wizzy*  
*synthetic leather*  
Confezione 35x40 cm | *Packaging 35x40 cm*



267200360



RINNOVA FANALI (150 gr.) | *HEADLIGHT LENS*  
*CLEANING PASTE (150 gr.)*



PRODOTTI PULIZIA - CLEANING PRODUCTS

267200590



ACQUAZERO (400 ml) | *ACQUAZERO CLEANER (400 ml)*



267200700



SMASH LUCIDA CRUSCOTTI (600 ml) | *DASHBOARD CLEANER (600 ml)*



267200770



CROMATURE BRILLANTI | *CHROME CARE*  
Confezione 150 gr | *150 gr Packing*



267200780



DETERGENTE MOTO | *BIKE DEGREASER*  
Confezione 400 ml | *400 ml Packing*



267202014 **NEW**



DETERGENTE MOTO (1L) | *MOTORBIKE CLEANER (1L)*



267202015 **NEW**



DETERGENTE MOTO (5L) | *MOTORBIKE CLEANER (5L)*



## PRODOTTI PULIZIA - CLEANING PRODUCTS

267201050 **NEW**



WIZZY PANNO ULTRAMICROFIBRA | WIZZY  
ULTRAMICROFIBRE CLOTH  
Dimensione 24 dm<sup>2</sup> | Dimension 24 dm<sup>2</sup>



267202026 **NEW**



SET PANNI PULIZIA VISIERA | VISOR CLEANING  
CLOTH SET



## ATTREZZI E UTENSILI - TOOLS

267000180



CHIAVE CANDELA | SPARK PLUG WRENCH  
Esagonale 13x21 | Hexagonal 13x21  
Confezione Pz. 5 | 5 Pcs Packing



267000190



CHIAVE CANDELA | SPARK PLUG WRENCH  
Confezione Pz. 5 | 5 Pcs Packing



267000240



CHIAVE CANDELA A TUBO CON SPINA | SPARK  
PLUG WRENCH WITH PIN  
Esagonale Ø 16x100 | Hexagonal Ø 16x100  
Confezione Pz. 5 | 5 Pcs Packing



267000250



CHIAVE CANDELA A TUBO CON SPINA | SPARK  
PLUG WRENCH WITH PIN  
Esagonale Ø 16x140 | Hexagonal Ø 16x140  
Confezione Pz. 5 | 5 Pcs Packing



ATTREZZI E UTENSILI - TOOLS

267000260



CHIAVE CANDELA A TUBO CON SPINA | SPARK  
 PLUG WRENCH WITH PIN  
 Esagonale Ø 18x100 | Hexagonal Ø 18x100  
 Confezione Pz. 5 | 5 Pcs Packing



267000270



CHIAVE CANDELA A TUBO CON SPINA | SPARK  
 PLUG WRENCH WITH PIN  
 Esagonale Ø 21x120 | Hexagonal Ø 21x120  
 Confezione Pz. 5 | 5 Pcs Packing



267000200



CHIAVE CANDELA | SPARK PLUG WRENCH  
 Esagonale 13x13x21 | Hexagonal 13x13x21  
 Confezione Pz. 5 | 5 Pcs Packing  
 Vespa 125 ET3



267000210



CHIAVE CANDELA | SPARK PLUG WRENCH  
 Esagonale 11x13x21 | Hexagonal 11x13x21  
 Confezione Pz. 5 | 5 Pcs Packing  
 Vespa 50-90



267000220



CHIAVE CANDELA | SPARK PLUG WRENCH  
 Esagonale 13x11x21 / 22 | Hexagonal 13x11x21  
 / 22  
 Confezione Pz. 5 | 5 Pcs Packing  
 Vespa 125-150 PX • Vespa 125-150 Sprint



## ATTREZZI E UTENSILI - TOOLS

267000230



CHIAVE CANDELA SNODATA PER MOTO |  
 ARTICULATED SPARK PLUG WRENCH  
 Esagonale Ø 21 | Hexagonal Ø 21  
 Lunghezza 230 mm | Length 230 mm  
 Confezione Pz. 5 | 5 Pcs Packing



## MINUTERIA METALLICA - HARDWARE

### RONDELLA PIANA ZINCATA - GALVANIZED WASHER



Codice RMS RMS Code	Dimensioni Dimensions	Quantità Quantity	Codice a barre Barcode
121858810	Ø 5 mm	50 Pz.   50 Pcs	
121858820	Ø 6 mm	50 Pz.   50 Pcs	
121858720	Ø 7 mm	50 Pz.   50 Pcs	
121858830	Ø 8 mm	100 Pz.   100 Pcs	

### DADO ZINCATO - GALVANIZED NUT



Codice RMS RMS Code	Dimensioni Dimensions	Quantità Quantity	Codice a barre Barcode
121858840	M4	10 Pz.   10 Pcs	
121858850	M5	10 Pz.   10 Pcs	
121858860	M6	10 Pz.   10 Pcs	
121858870	M7	10 Pz.   10 Pcs	
121858880	M8	10 Pz.   10 Pcs	

**MINUTERIA METALLICA - HARDWARE**
**RONDELLA GROWER ZINCATA - GROWER GALVANIZED WASHER**

Codice RMS <i>RMS Code</i>	Dimensioni <i>Dimensions</i>	Quantità <i>Quantity</i>	Codice a barre <i>Barcode</i>
121858790	Ø 5 mm	50 Pz.   50 Pcs	
121858800	Ø 6 mm	50 Pz.   50 Pcs	
121858730	Ø 7 mm	50 Pz.   50 Pcs	
121858780	Ø 8 mm	50 Pz.   50 Pcs	
121860070	Ø 10 mm	50 Pz.   50 Pcs	

**VITE TESTA ESAGONALE ZINCATA - GALVANIZED HEXAGONAL SCREW**

Codice RMS <i>RMS Code</i>	Dimensioni <i>Dimensions</i>	Quantità <i>Quantity</i>	Codice a barre <i>Barcode</i>
121858910	M5 x 16 mm	10 Pz.   10 Pcs	
121858920	M5 x 20 mm	10 Pz.   10 Pcs	
121858930	M5 x 25 mm	10 Pz.   10 Pcs	
121858940	M6 x 16 mm	10 Pz.   10 Pcs	
121858950	M6 x 20 mm	10 Pz.   10 Pcs	
121858710	M6 x 22 mm	5 Pz.   5 Pcs	
121858960	M6 x 25 mm	10 Pz.   10 Pcs	
121860080	M7 x 16 mm	10 Pz.   10 Pcs	
121860090	M7 x 20 mm	10 Pz.   10 Pcs	
121860100	M7 x 25 mm	10 Pz.   10 Pcs	
121858970	M8 x 16 mm	10 Pz.   10 Pcs	
121858980	M8 x 20 mm	10 Pz.   10 Pcs	
121858990	M8 x 25 mm	10 Pz.   10 Pcs	
121858900	M10 x 80 mm	10 Pz.   10 Pcs	







Progetto grafico, coordinamento e soluzioni di impaginazione automatizzata:  
Winning Associati S.r.l. / ZERO ONE S.a.s. - Bernareggio (MB)

Il presente stampato è a norma delle leggi sul diritto d'autore e del codice civile.  
È tassativamente vietata la riproduzione di questo catalogo o di parte di esso, con qualsiasi metodo elettronico, meccanico, per mezzo di fotocopie o altro. I diritti sono riservati per tutti i paesi.  
Disegni e dati (descrizioni, caratteristiche, codifiche, ecc.) riportati sul catalogo possono essere soggetti a modifiche e variazioni. RMS S.p.A. si riserva la facoltà di effettuare cambiamenti anche senza preavviso.  
Tutti i riferimenti originali sono di proprietà esclusiva delle case produttrici.

*As for the copyright laws and the civil code laws, it's forbidden the reproduction of this catalogue/price list or any extract of the same with any electronical,mechanical means. No photocopies are allowed and also any microchips, recording or else. The rights are reserved for all the countries in which we sell. Drawing, data (descriptions, characteristics, codes, price and so on) that are described on price lists and catalogues can be subject to changes and modifications. RMS s.p.a. has the right to change any of these conditions without any advanced notice. All the original references are of exclusive property of the producers.*

Per le condizioni generali di vendita consultare il sito [www.rms.it](http://www.rms.it)

**RMS S.p.A.**

Via Macallè 156 - 20831 Seregno (MB) - Tel. +39 0362 27301 - Fax +39 0362 2730270  
[www.rms.it](http://www.rms.it) - [info@rms.it](mailto:info@rms.it)





[www.rms.it](http://www.rms.it)

**RMS S.p.A.**  
Via Macallè 156  
20831 Seregno (MB) - Italy  
Tel. +39 0362 27301  
Fax +39 0362 2730270

SEGUICI SU



CA CLA 0005