



AGGIORNAMENTO

CATALOGO
2024



VESPA | 1

APE | 119

CICLOMOTORE-MOPEL | 131



*La motocicletta più bella è quella
che devi ancora sistemare: la prossima.*

*The best motorcycle you still
have to repair is the next one.*

Ispirato da
Inspired by
Enzo Ferrari

Con passione ed impegno
With dedication and commitment
Team RMS Moto



VESPA

3	ASPIRAZIONE	INTAKE SYSTEM	SISTEMA DE ADMISION	SYSTÈME D'ADMISSION
5	ALIMENTAZIONE	FUEL SYSTEM	SISTEMA DE COMBUSTIBLE	SYSTÈME D'ALIMENTATION
17	MOTORE	ENGINE	MOTOR	MOTEUR
23	SCARICO	EXHAUST SYSTEM	SISTEMA DE ESCAPE	SYSTÈME D'ÉCHAPPEMENT
25	IMPIANTO FRENANTE	BRAKING SYSTEM	SISTEMA DE FRENADOS	SYSTÈME DE FREINAGE
31	IMPIANTO ELETTRICO	ELECTRICAL SYSTEM	INSTALACION ELECTRICA	SYSTÈME ÉLECTRIQUE
42	BATTERIE	BATTERIES	BATERIAS	BATTERIES
43	TRASMISSIONE	TRANSMISSION	TRANSMISIÓN	TRANSMISSION
59	CARROZZERIA	BODY WORK	CARROCERIA	CARROSSERIE
71	TELAIO	CHASSIS	CHASIS	CHASSIS
87	SOSPENSIONI	SUSPENSIONS	SUSPENSIONES	SUSPENSIONS
91	CUSCINETTI	BEARINGS	COJINETES	ROULEMENT
95	TENUTA	TIGHT SYSTEM	SISTEMA DE RETENES	SYSTÈME DE JOINTS
103	ACCESSORI	ACCESSORIES	ACCESORIOS	ACCESSOIRES
107	OFFICINA	WORKSHOP	TALLER	ATELIER

APE

121	ASPIRAZIONE	INTAKE SYSTEM	SISTEMA DE ADMISION	SYSTÈME D'ADMISSION
123	MOTORE	ENGINE	MOTOR	MOTEUR
125	SCARICO	EXHAUST SYSTEM	SISTEMA DE ESCAPE	SYSTÈME D'ÉCHAPPEMENT
127	IMPIANTO FRENANTE	BRAKING SYSTEM	SISTEMA DE FRENADOS	SYSTÈME DE FREINAGE
129	IMPIANTO ELETTRICO	ELECTRICAL SYSTEM	INSTALACION ELECTRICA	SYSTÈME ÉLECTRIQUE

CICLOMOTORE-MOPED

133	ALIMENTAZIONE	FUEL SYSTEM	SISTEMA DE COMBUSTIBLE	SYSTÈME D'ALIMENTATION
135	IMPIANTO ELETTRICO	ELECTRICAL SYSTEM	INSTALACION ELECTRICA	SYSTÈME ÉLECTRIQUE
137	TRASMISSIONE	TRANSMISSION	TRANSMISIÓN	TRANSMISSION
139	CARROZZERIA	BODY WORK	CARROCERIA	CARROSSERIE
143	TELAIO	CHASSIS	CHASIS	CHASSIS
147	GOMME	TIRES	NEUMATICOS	PNEUS
149	OFFICINA	WORKSHOP	TALLER	ATELIER



VESPA

3	ASPIRAZIONE	INTAKE SYSTEM	SISTEMA DE ADMISION	SYSTÈME D'ADMISSION
5	ALIMENTAZIONE	FUEL SYSTEM	SISTEMA DE COMBUSTIBLE	SYSTÈME D'ALIMENTATION
17	MOTORE	ENGINE	MOTOR	MOTEUR
23	SCARICO	EXHAUST SYSTEM	SISTEMA DE ESCAPE	SYSTÈME D'ÉCHAPPEMENT
25	IMPIANTO FRENANTE	BRAKING SYSTEM	SISTEMA DE FRENADOS	SYSTÈME DE FREINAGE
31	IMPIANTO ELETTRICO	ELECTRICAL SYSTEM	INSTALACION ELECTRICA	SYSTÈME ÉLECTRIQUE
42	BATTERIE	BATTERIES	BATERIAS	BATTERIES
43	TRASMISSIONE	TRANSMISSION	TRANSMISIÓN	TRANSMISSION
59	CARROZZERIA	BODY WORK	CARROCERIA	CARROSSERIE
71	TELAIO	CHASSIS	CHASIS	CHASSIS
87	SOSPENSIONI	SUSPENSIONS	SUSPENSIONES	SUSPENSIONS
91	CUSCINETTI	BEARINGS	COJINETES	ROULEMENT
95	TENUTA	TIGHT SYSTEM	SISTEMA DE RETENES	SYSTÈME DE JOINTS
103	ACCESSORI	ACCESSORIES	ACCESORIOS	ACCESSOIRES
107	OFFICINA	WORKSHOP	TALLER	ATELIER





ASPIRAZIONE

INTAKE SYSTEM

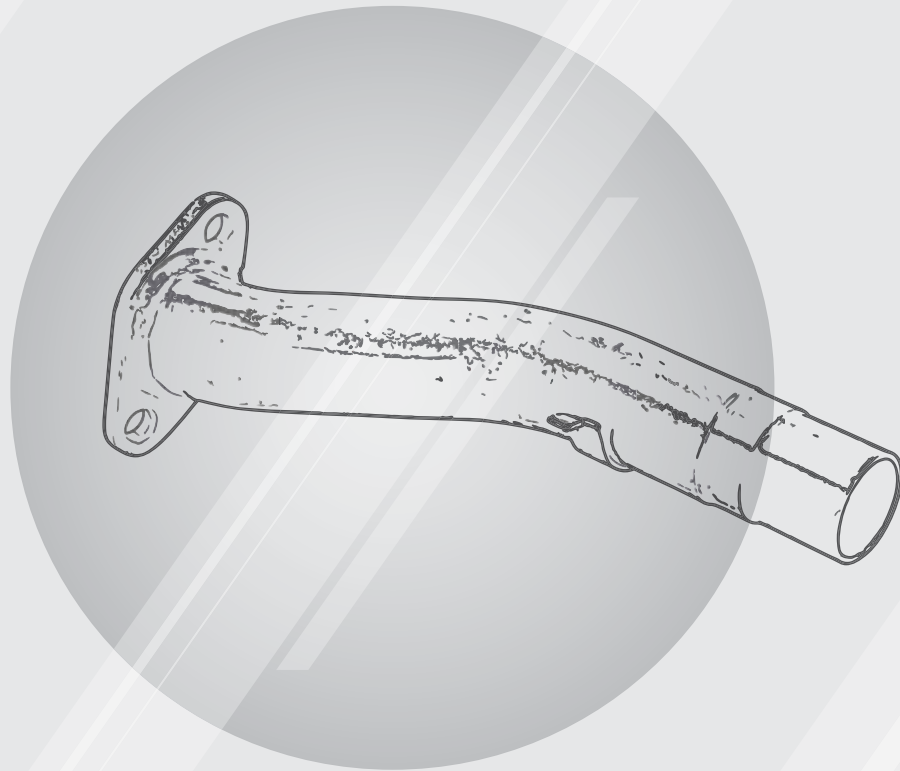

100520171 **NEW**



Collegamento carburatore 19.5 mm | *Outer diameter 19.5 mm*

Numero fori Tre | *Number of holes Three*

Passaggio 16 mm | *Inner diameter 16 mm*

Valvola Disco rotante | *Valve Disc valve*

• VESPA PK 50 XL/FL/HP

R.O. 4308315



ALIMENTAZIONE

FUEL SYSTEM

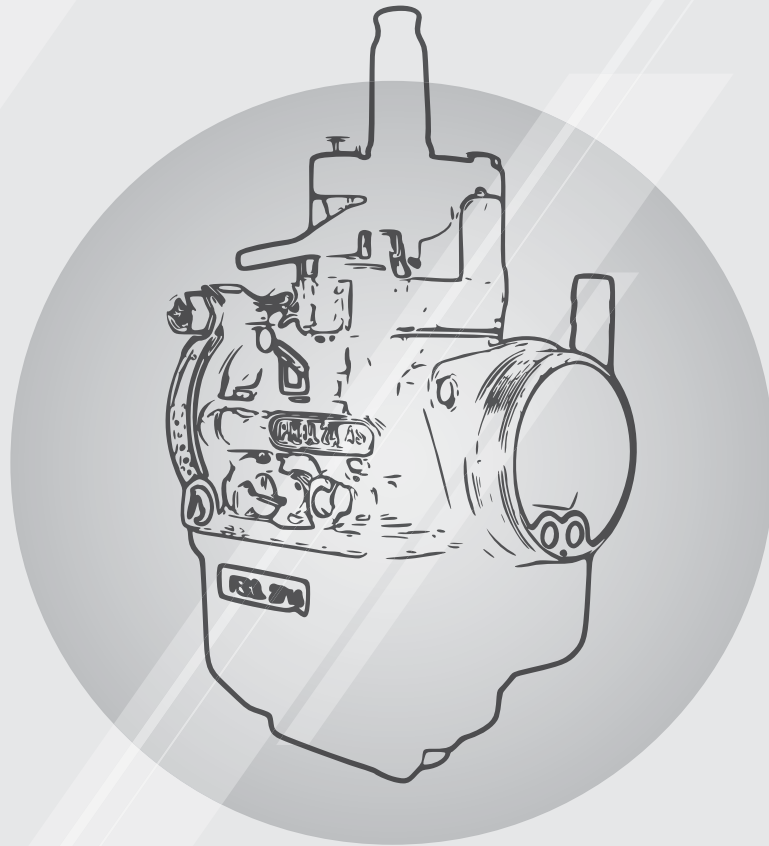

SERBATOI BENZINA E ACCESSORI - FUEL TANKS AND ACCESSORIES

121650183

NEW



Tappo serbatoio benzina | *Fuel tank cap*
Finitura Cromato | *Finishing Chromed*

- VESPA SUPER 150 (1965 - 1979)
- VESPA PX 125 E ARCOBALENO (1983 - 1983)
- VESPA P 125 X (1977 - 1982)
- VESPA P 125 X (1979 - 1983)
- VESPA SPRINT 150 (1965 - 1966)



121730061

NEW



Serbatoio benzina | *Fuel tank*
Materiale Ferro | *Material Iron*
Colore Nero | *Colour Black*

- VESPA PX 125
 - VESPA PX 150
 - VESPA PX 200
- R.O. 2280825



121730083

NEW



Serbatoio benzina | *Fuel tank*
Materiale Ferro | *Material Iron*
Colore Grigio | *Colour Grey*

- VESPA SUPER 150 (1965 - 1979)
- VESPA P 125 X (1977 - 1982)
- VESPA P 125 X (1979 - 1983)
- VESPA SPRINT 150 (1965 - 1966)
- VESPA P 125 X (1977 - 1979)



ACCESSORI CARBURATORE - CARBURETOR ACCESSORIES

121700004

NEW



DELL'ORTO

Guarnizioni carburatore SHBC 19 | *Carburetor gasket SHBC 19*

Codice Dell'Orto 52553 | *Dell'Orto part number 52553*



ACCESSORI CARBURATORE - CARBURETOR ACCESSORIES

121700005 **NEW****DELL'ORTO**Guarnizioni carburatore SHBC 19 | *Carburetor gasket SHBC 19*Codice Dell'Orto 52555 | *Dell'Orto part number 52555*121700007 **NEW****DELL'ORTO**Guarnizioni carburatore 20/24 PX | *Carburetor gasket 20/24 PX*Codice Dell'Orto 52537 | *Dell'Orto part number 52537*121700079 **NEW****DELL'ORTO**Coperchio Vaschetta | *Float Chamber cover*
Diametro spillo galleggiante 45 mm | *Float needle diameter 45 mm*Codice Dell'Orto 1181900 54 | *Dell'Orto part number 1181900 54*121700081 **NEW****DELL'ORTO**Filtro Carburatore SHA | *Carburetor filter SHA*
Materiale Alluminio | *Material Aluminium*
Utilizzo Road | *Use Road*121700086 **NEW****DELL'ORTO**Filtro benzina SHA-SHBH-SHBC | *Gasoline filter SHA-SHBH-SHBC*Codice Dell'Orto 0610900 29 | *Dell'Orto part number 0610900 29*

121700087 **NEW**



DELL'ORTO

Filtro benzina PHBD | Gasoline filter PHBD

Codice Dell'Orto 0336200 29 | Dell'Orto part number 0336200 29



121700088 **NEW**



DELL'ORTO

Filtro benzina SHB 16-16 | Gasoline filter SHB 16-16

Codice Dell'Orto 0621000 29 | Dell'Orto part number 0621000 29



121700089 **NEW**



DELL'ORTO

Galleggiante Ciao | Float Ciao

Codice Dell'Orto 0742001 | Dell'Orto part number 0742001



121700090 **NEW**



DELL'ORTO

Galleggiante | Float

Codice Dell'Orto 0612202 80 | Dell'Orto part number 0612202 80



121700091 **NEW**



DELL'ORTO

Galleggiante | Float

Peso 3.7 gr | Weight 3.7 gr

Codice Dell'Orto 0456700 80 | Dell'Orto part number 0456700 80



ACCESSORI CARBURATORE - CARBURETOR ACCESSORIES

121700218 **NEW** 

DELL'ORTO

Kit Galleggiante | *Float Kit*
 Codice Dell'Orto 5305300 78 | *Dell'Orto part number 5305300 78*



121700220 **NEW** 

DELL'ORTO

Kit getto 100-122 | *Jet kit 100-122*
 Filetto M5 | *Thread M5*
 Codice Dell'Orto 01486 531500 | *Dell'Orto part number 01486 531500*



121700221 **NEW** 

DELL'ORTO

Kit getto 75-98 | *Jet kit 75-98*
 Filetto M5 | *Thread M5*
 Codice Dell'Orto 01486 5314900 | *Dell'Orto part number 01486 5314900*



121700222 **NEW** 

DELL'ORTO

Kit getto 105-128 | *Jet kit 105-128*
 Carburatore SI | *Carburetor SI*
 Codice Dell'Orto 04576 531550 | *Dell'Orto part number 04576 531550*



121700223 **NEW** 

DELL'ORTO

Kit getto 100-122 | *Jet kit 100-122*
 Filetto M6 | *Thread M6*
 Codice Dell'Orto 06413 531530 | *Dell'Orto part number 06413 531530*



121700224 **NEW**



DELL'ORTO

Kit getto 125-148 | *Jet kit 125-148*

Filetto M6 | *Thread M6*

Codice Dell'Orto 06413 531540 | *Dell'Orto part number 06413 531540*



121700225 **NEW**



DELL'ORTO

Kit getto 75-98 | *Jet kit 75-98*

Filetto M6 | *Thread M6*

Codice Dell'Orto 06413 5315200 | *Dell'Orto part number 06413 5315200*



121700227 **NEW**



DELL'ORTO

Molla | *Spring*

Codice Dell'Orto 0741300 61 | *Dell'Orto part number 0741300 61*



121700228 **NEW**



DELL'ORTO

Molla | *Spring*

Codice Dell'Orto 0645500 61 | *Dell'Orto part number 0645500 61*



121700229 **NEW**



DELL'ORTO

Molla | *Spring*

Codice Dell'Orto 0933600 61 | *Dell'Orto part number 0933600 61*



ACCESSORI CARBURATORE - CARBURETOR ACCESSORIES

121700230 **NEW****DELL'ORTO**

Molla | Spring

Codice Dell'Orto 0595100 61 | Dell'Orto part number 0595100 61

121700231 **NEW****DELL'ORTO**

Pipetta SHA | Fuel House connection SHA

Angolo 45° | Corner 45°

Colore Nero | Colour Black

Diametro 6 mm | Diameter 6 mm

Codice Dell'Orto 0924900 38 | Dell'Orto part number 0924900 38

121700234 **NEW****DELL'ORTO**

Pipetta | Fuel House connection

Codice Dell'Orto 0651700 38 | Dell'Orto part number 0651700 38

121700235 **NEW****DELL'ORTO**

Pipetta | Fuel House connection

Codice Dell'Orto 0336400 38 | Dell'Orto part number 0336400 38

121700236 **NEW****DELL'ORTO**

Pipetta | Fuel House connection

Codice Dell'Orto 0810600938 | Dell'Orto part number 0810600938



121700245 **NEW**



DELL'ORTO

Spillo chiusura benzina | *Float needle*

Codice Dell'Orto 1530400 05 | *Dell'Orto part number 1530400 05*



121700246 **NEW**



DELL'ORTO

Spillo chiusura benzina PHBG-FHBB-SHA-SHB | *Float needle PHBG-FHBB-SHA-SHB*

Codice Dell'Orto 0283800 05 | *Dell'Orto part number 0283800 05*



121700247 **NEW**



DELL'ORTO

Spillo chiusura benzina SI | *Float needle SI*
Caratteristiche Molleggiato | *Characteristics Spring loaded*

Diametro 5.2 mm | *Diameter 5.2 mm*

Dimensioni 4x4mm | *Dimension 4x4mm*

Codice Dell'Orto 1220200 05 | *Dell'Orto part number 1220200 05*



121700248 **NEW**



DELL'ORTO

Spillo chiusura benzina SI | *Float needle SI*

Diametro 4.5 mm | *Diameter 4.5 mm*

Dimensioni 3.7x3.7mm | *Dimension 3.7x3.7mm*

Codice Dell'Orto 0455900 05 | *Dell'Orto part number 0455900 05*



121700249 **NEW**



DELL'ORTO

Spillo chiusura benzina | *Float needle*

Codice Dell'Orto 1166800 05 | *Dell'Orto part number 1166800 05*



ACCESSORI CARBURATORE - CARBURETOR ACCESSORIES

121700250 **NEW****DELL'ORTO**Spillo chiusura benzina SPACO-SI | *Float needle SPACO-SI*Caratteristiche Molleggiato | *Characteristics Spring loaded*Diametro 4.5 mm | *Diameter 4.5 mm*Dimensioni 3.7x3.7mm | *Dimension 3.7x3.7mm*Codice Dell'Orto 0808000 05 | *Dell'Orto part number 0808000 05*121700251 **NEW****DELL'ORTO**Spillo chiusura benzina | *Float needle*Codice Dell'Orto 1536000 05 | *Dell'Orto part number 1536000 05*121700256 **NEW****DELL'ORTO**Vaschetta SHA | *Bowl SHA*Codice Dell'Orto 1341200 96 | *Dell'Orto part number 1341200 96*121700257 **NEW****DELL'ORTO**Vaschetta SHA-SHBC | *Bowl SHA-SHBC*Codice Dell'Orto 1350200 96 | *Dell'Orto part number 1350200 96*

121700264 **NEW**



DELL'ORTO

Vite | Screw

Confezione 10 | Pack 10 Pieces

Filetto M4 | Thread M4

Lunghezza 14 mm | Length 14 mm

Codice Dell'Orto 1822600536 | Dell'Orto part number 1822600536



121700265 **NEW**



DELL'ORTO

Vite | Screw

Confezione 10 | Pack 10 Pieces

Filetto M4 | Thread M4

Lunghezza 18 mm | Length 18 mm

Codice Dell'Orto 1183700536 | Dell'Orto part number 1183700536



121700266 **NEW**



DELL'ORTO

Vite | Screw

Confezione 10 | Pack 10 Pieces

Codice Dell'Orto 1370900536 | Dell'Orto part number 1370900536



121701637 **NEW**



DELL'ORTO

Filtro benzina SI | Gasoline filter SI

Codice Dell'Orto 0418700 29 | Dell'Orto part number 0418700 29



ACCESSORI CARBURATORE - CARBURETOR ACCESSORIES

121831093

NEW



Gommini vaschetta carburatore | *Carburettor bowl rubbers*

- VESPA PX 125 E ELESTART (1984 - 1984)
- VESPA PX 125 T5 (1985 - 1985)
- VESPA PX 125 T5 ELESTART (1986 - 1986)
- VESPA PX 200 E FRENO A DISCO (1998 - 2001)
- VESPA PX 200 E ARCOBALENO (1983 - 1984)



121850191

NEW



Vite | *Screw*

Filetto M5 | *Thread M5*

Lunghezza 25 mm | *Lenght 25 mm*

Testa vite Taglio | *Screw Head Slotted*

- VESPA 125 (1951 - 1957)





MOTORE

ENGINE

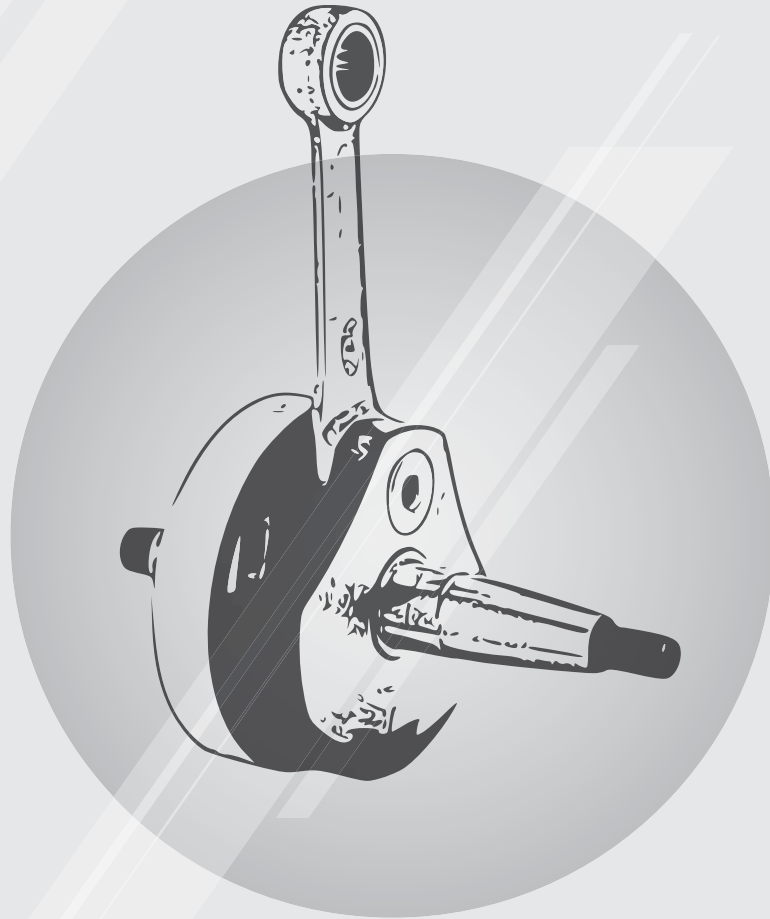

100012035 **NEW**



Tipologia Standard | *Type Standard*
 Valvola Disco rotante | *Valve Disc valve*
 Corsa 57 mm | *Stroke 57 mm*
 Biella 105 mm | *Conrod 105 mm*

- VESPA PX 125-150
- VESPA P 125-150X
- VESPA 1255 GTR 2° serie
- VESPA 125 TS 2° serie
- VESPA 150 SPRINT 2° serie
- COSA 125-150
- R.O. 133154



100012036 **NEW**



Tipologia Anticipato | *Type Advanced*
 Valvola Disco rotante | *Valve Disc valve*
 Corsa 51 mm | *Stroke 51 mm*
 Cono 20 mm | *Cone 20 mm*
 Biella 97 mm | *Conrod 97 mm*

- VESPA 50 SPECIAL (1975 - 1983)
- VESPA ET3 125 (1976 - 1983)
- VESPA PRIMAVERA 125 (1967 - 1983)
- VESPA 50 SPECIAL (1970 - 1972)
- VESPA 50 SPECIAL (1972 - 1975)



KIT REVISIONE ALBERO MOTORE - CRANKSHAFT REVISION KIT

100201540 **NEW**

- VESPA SUPER 150 (1965 - 1979)
- VESPA GS 150 (1958 - 1961)
- VESPA GS 150 (1959 - 1964)

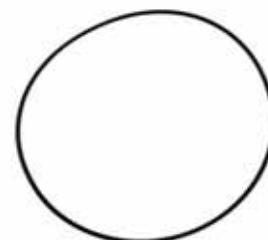

INGRANAGGI AVVIAMENTO - STARTER GEARS

100250394 **NEW**

Diametro 20.5 mm | *Diameter 20.5 mm*
 Numero denti 12 | *Teeth number 12*
 Numero denti innesto 10 | *Engagement teeth number 10*

- VESPA 50 SPECIAL (1975 - 1983)
- VESPA PK 50 S (1982 - 1982)
- VESPA 50 SPECIAL (1972 - 1975)
- VESPA 50 SPECIAL (1970 - 1972)
- VESPA 50 R (1969 - 1971)

R.O. 13249

100250395 **NEW**

Diametro 21.8 mm | *Diameter 21.8 mm*
 Numero denti 12 | *Teeth number 12*
 Numero denti innesto 12 | *Engagement teeth number 12*

- VESPA PX 80 E (1981 - 1997)
- VESPA P 125 X (1977 - 1982)
- VESPA P 125 X (1979 - 1983)
- VESPA P 125 X (1977 - 1979)
- VESPA P 150 X (1978 - 1981)

R.O. 13249



INGRANAGGI AVVIAMENTO - STARTER GEARS

100250396 **NEW**



Diametro 21.8 mm | *Diameter 21.8 mm*

Numero denti 12 | *Teeth number 12*

Numero denti innesto 14 | *Engagement teeth number 14*

- VESPA 150 VBB (1960 - 1962)
- VESPA 125 (1958 - 1958)
- VESPA 125 VNB3T (1961 - 1962)
- VESPA 125 VNB2T (1961 - 1961)
- VESPA 125 VNB1T (1960 - 1960)

R.O. 8902



100250397 **NEW**



Diametro 21.8 mm | *Diameter 21.8 mm*

Numero denti 12 | *Teeth number 12*

Numero denti innesto 13 | *Engagement teeth number 13*

- VESPA SUPER (1965 - 1979)
- VESPA 150 VBB (1960 - 1962)
- VESPA 125 VNB6T (1965 - 1966)
- VESPA 125 (1965 - 1966)
- VESPA 125 (1964 - 1964)

R.O. 13249



100250671 **NEW**



Numero di denti 11 | *Number of teeth*

- VESPA 50 SPECIAL 50 (1975 - 1983)
- VESPA ET3 125 (1976 - 1983)
- VESPA PRIMAVERA 125 (1967 - 1983)
- VESPA PK 50 S (1982 - 1982)
- VESPA 50 R (1969 - 1971)

R.O. 07973



MOLLE MESSA IN MOTO - STARTER SPRINGS

121930071 NEW

Materiale Acciaio | *Material Steel*

- VESPA 50 SPECIAL (1975 - 1983)
- VESPA ET3 125 (1976 - 1983)
- VESPA PRIMAVERA 125 (1967 - 1983)
- VESPA PK 50 S (1982 - 1982)

R.O. 15194



121930072 NEW

Materiale Acciaio | *Material Steel*Altezza 3,1 mm | *Height 3,1 mm*Diametro esterno 42,9 mm | *Outer diameter 42,9 mm*Diametro interno 32,9 mm | *Internal diameter 32,9 mm*

- VESPA 50 SPECIAL (1975 - 1983)
- VESPA ET3 125 (1976 - 1983)
- VESPA PRIMAVERA 125 (1967 - 1983)
- VESPA PK 50 S (1982 - 1982)

R.O. 151743



COPRIVENTOLA - FAN COVERS

142580270 NEW

Materiale Ferro | *Material Iron*Colore Argento cromato | *Colour Chromed silver*

- VESPA 50 SPECIAL (1975 - 1983)
- VESPA ET3 125 (1976 - 1983)
- VESPA PRIMAVERA 125 (1967 - 1983)
- VESPA 50 SPECIAL (1972 - 1975)

R.O. 13365



121831160

NEW



Gommino battuta settore avviamento | *Rubber kickstart lever buffer*

Misure 23,5x24x13,5 mm | *Dimension*

- VESPA PK 50 (1982 - 1989)
- VESPA PK 80 (1984 - 1989)
- VESPA PK 100 (1982 - 1986)
- VESPA PK 125 (1982 - 1989)

R.O. 240753



SCARICO

EXHAUST SYSTEM



100540011 **NEW**



Materiale Alluminio | *Material Aluminium*
Interasse fori 52 mm | *Wheelbase 52 mm*

- VESPA 50 SPECIAL (1975 - 1983)
- VESPA ET3 125 (1976 - 1983)
- VESPA 50 SPECIAL (1970 - 1972)
- VESPA 50 SPECIAL (1972 - 1975)
- VESPA 50 SPECIAL ELESTART (1970 - 1972)

R.O. 740002



IMPIANTO FREMANTE

BRAKING SYSTEM

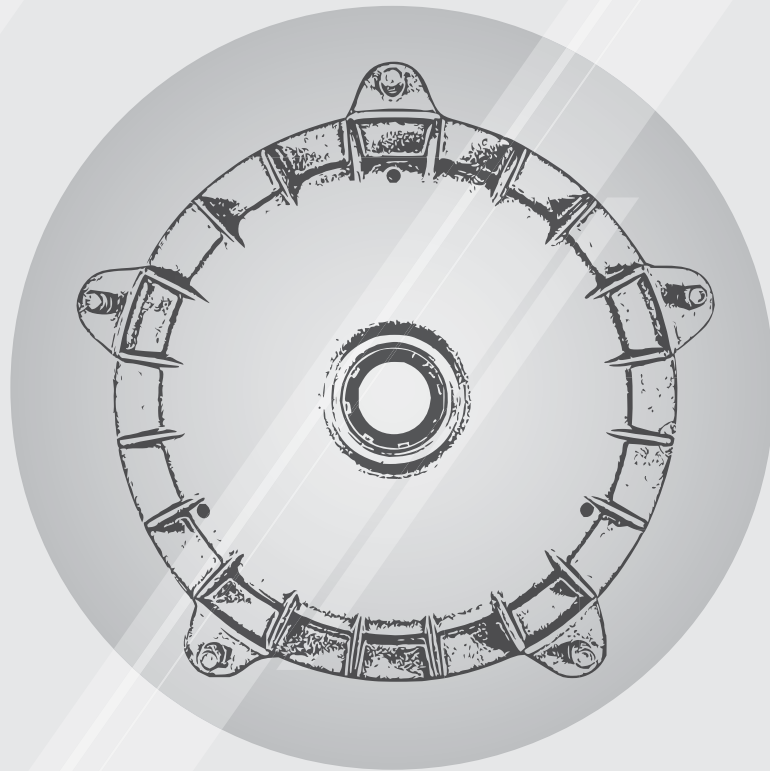

GANASCE FRENO SPORT - SPORT BRAKE SHOES

225120173 **NEW**



EVOX



Materiale Alluminio | *Material Aluminium*

Diametro 125 mm | *Diameter 125 mm*

Spessore 17 mm | *Thickness 17 mm*

Colore Arancione | *Colour Orange*

- VESPA 50 SPECIAL
- VESPA ET3 125 (1976 - 1983)
- VESPA PRIMAVERA 125 (1967 - 1983)



225120183 **NEW**



EVOX



Materiale Alluminio | *Material Aluminium*

Diametro 150 mm | *Diameter 150 mm*

Spessore 24 mm | *Thickness 24 mm*

Colore Arancione | *Colour Orange*

- VESPA 50 SPECIAL
- VESPA ET3 125 (1976 - 1983)
- VESPA PRIMAVERA 125 (1967 - 1983)



225120573 **NEW**



EVOX



Materiale Alluminio | *Material Aluminium*

Diametro 150 mm | *Diameter 150 mm*

Spessore 24 mm | *Thickness 24 mm*

Colore Arancione | *Colour Orange*

- VESPA PX
- R.O.414450



ACCESSORI GANASCE FRENO - BRAKE SHOES ACCESSORIES

121870615 **NEW**



Camma Freno | *Brake cam*

Posizione Anteriore | *Installation point Front*

- VESPA PK 50 S (1982 - 1982)
- VESPA PK 50 (1982 - 1984)
- VESPA PK 125 S (1982 - 1985)
- VESPA PK 100 S (1982 - 1985)
- VESPA PK 50 (1982 - 1984)

R.O. 179568



ACCESSORI GANASCE FRENO - BRAKE SHOES ACCESSORIES

121870616

NEW



Camma Freno | *Brake cam*

Posizione Posteriore | *Installation point Rear*

- VESPA PK 50 S (1982 - 1982)
- VESPA PK 50 (1982 - 1984)
- VESPA PK 125 S (1982 - 1985)
- VESPA PK 100 S (1982 - 1985)
- VESPA PK 50 (1982 - 1984)

R.O. 2159374



121870617

NEW



Camma Freno | *Brake cam*

- VESPA 50 SPECIAL

R.O. 165370



121870618

NEW



Camma Freno | *Brake cam*

Posizione Anteriore | *Installation point Front*

- VESPA 50 N-R-L

R.O. 57945



121870619

NEW



Camma Freno | *Brake cam*

Posizione Posteriore | *Installation point Rear*

- VESPA 50 SPECIAL

R.O. 078366



TAMBURI FRENO - BRAKE DRUMS

225085021 **NEW**



Posizione Posteriore | *Installation point Rear*
Cerchio 10" | *Rim 10"*

Diametro interno 150 mm | *Internal diameter 150 mm*

Materiale Alluminio | *Material Aluminium*

- VESPA PK 50 S (1982 - 1982)
- VESPA PK 50 (1982 - 1984)
- VESPA PK 125 S (1982 - 1985)
- VESPA PK 100 S (1982 - 1985)
- VESPA PK 50 (1982 - 1984)

R.O. 21599



225085022 **NEW**



Posizione Anteriore | *Installation point Front*
Cerchio 10" | *Rim 10"*

Diametro interno 125 mm | *Internal diameter 125 mm*

Materiale Alluminio | *Material Aluminium*

- VESPA PK 50 S (1982 - 1982)
- VESPA PK 50 (1982 - 1984)
- VESPA PK 125 S (1982 - 1985)
- VESPA PK 100 S (1982 - 1985)
- VESPA PK 50 (1982 - 1984)

R.O. 22676



ACCESSORI TAMBURI FRENO - BRAKE DRUMS ACCESSORIES

121870614 **NEW**



Camma Freno | *Brake cam*

Posizione Anteriore | *Installation point Front*

- VESPA ET3 125 (1976 - 1983)
- VESPA PRIMAVERA 125 (1967 - 1983)
- VESPA SS 90 (1965 - 1971)
- VESPA 90 RACER (1971 - 1973)

R.O. 13194



ACCESSORI TAMBURI FRENO - BRAKE DRUMS ACCESSORIES

121831300

NEW



Tappo copri dado tamburo | *Front drum nut cover*

Posizione Anteriore | *Installation point Front*

• VESPA PX





IMPIANTO ELETTRICO

ELECTRICAL SYSTEM

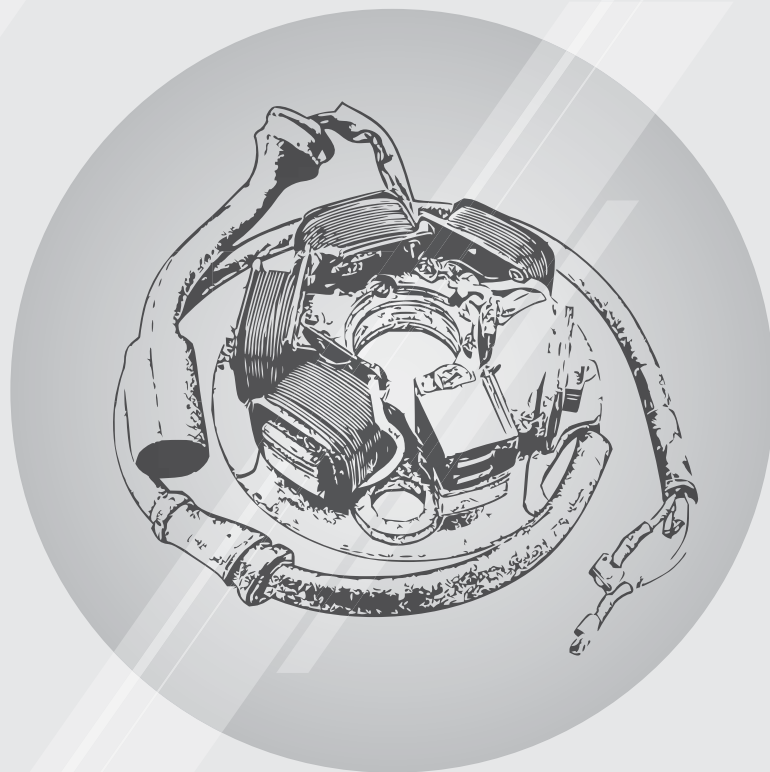

246410099 **NEW**



EVOX



Posizione Anteriore | *Installation point Front*

Luce Led | *Light Led*

Caratteristiche 6500K con convertitore |

Characteristics 6500K with converter

- VESPA 50 SPECIAL (1975 - 1983)
- VESPA 50 SPECIAL (1972 - 1975)
- VESPA 50 SPECIAL (1970 - 1972)
- VESPA 50 SPECIAL ELESTART (1970 - 1972)
- VESPA 50 SPECIAL ELESTART (1972 - 1975)



246410103 **NEW**



EVOX



Posizione Anteriore | *Installation point Front*

Luce Led | *Light Led*

Caratteristiche Con convertitore |

Characteristics With converter

Diametro 112 mm | *Diameter 112 mm*

- VESPA 50 R (1969 - 1971)
- VESPA 50 N (1963 - 1971)
- VESPA 50 L (1966 - 1970)
- VESPA 50 REVIVAL (1991 - 1991)
- VESPA 50 (1963 - 1983)



246410104 **NEW**



EVOX



Posizione Anteriore | *Installation point Front*

Luce Led | *Light Led*

Caratteristiche 6000K con convertitore |

Characteristics 6000K with converter

Diametro 117 mm | *Diameter 117 mm*

- VESPA ET3 125 (1976 - 1983)
- VESPA PRIMAVERA 125 (1967 - 1983)
- VESPA PRIMAVERA 125 (1963 - 1966)



FANALI A LED - LED LIGHTS

246410105 **NEW****EVOX**Posizione Anteriore | *Installation point Front*Luce Led | *Light Led*

Caratteristiche 6000K con convertitore |

*Characteristics 6000K with converter*Diametro 139 mm | *Diameter 139 mm*

- VESPA PK 50 S 50 (1982 - 1982)
- VESPA PK 50 50 (1982 - 1984)
- VESPA PK 125 S 125 (1982 - 1985)
- VESPA PK 100 S 100 (1982 - 1985)
- VESPA PK 50 (1982 - 1984)

246410106 **NEW****EVOX**Posizione Anteriore | *Installation point Front*Luce Led | *Light Led*

Caratteristiche 6000K con convertitore |

*Characteristics 6000K with converter*Diametro 139 mm | *Diameter 139 mm*

- VESPA FL2 HP (1991 - 1997)
- VESPA FL 50 (1990 - 1990)
- VESPA PK 50 HP (1991 - 1999)
- VESPA FL 125 (1989 - 1990)
- VESPA FL2 AUTOMATICA 50 (1990 - 1991)

246410107 **NEW****EVOX**Posizione Anteriore | *Installation point Front*Luce Led | *Light Led*

Caratteristiche 6000K con convertitore |

*Characteristics 6000K with converter*Diametro 148mm | *Diameter 148mm*

- VESPA PX 80 E (1981 - 1997)
- VESPA PX 125 E ARCOBALENO (1983 - 1983)
- VESPA PX 150 E ELESTART (1984 - 1984)
- VESPA PX 150 E (1981 - 1981)
- VESPA PX 125 E ELESTART (1984 - 1984)



FANALI A LED - LED LIGHTS

246410281 **NEW**



EVOX



Posizione Anteriore | *Installation point Front*

Luce Led | *Light Led*

Caratteristiche 6000K con convertitore |

Characteristics 6000K with converter

- SI -FL2



246410291 **NEW**



EVOX



Posizione Anteriore | *Installation point Front*

Luce Led | *Light Led*

Caratteristiche 6000K con convertitore |

Characteristics 6000K with converter

- CIAO



246410108 **NEW**



EVOX



Posizione Posteriore | *Installation point Rear*

Luce Led | *Light Led*

Caratteristiche 12 led con convertitore |

Characteristics 12 led with converter

- VESPA 50 SPECIAL (1975 - 1983)
- VESPA 50 SPECIAL (1970 - 1972)
- VESPA 50 SPECIAL (1972 - 1975)
- VESPA 50 SPECIAL ELESTART (1970 - 1972)
- VESPA 50 SPECIAL ELESTART (1972 - 1975)



FANALI A LED - LED LIGHTS

246420011

NEW

**EVOX**Posizione Posteriore | *Installation point Rear*Luce Led | *Light Led*Caratteristiche 22 led con convertitore |
Characteristics 22 led with converter

- VESPA PRIMAVERA 125 (1967 - 1983)
- VESPA PRIMAVERA 125 (1963 - 1966)



246420181

NEW

**EVOX**Posizione Posteriore | *Installation point Rear*Luce Led | *Light Led*Caratteristiche 27 led con convertitore |
Characteristics 27 led with converter

- VESPA ET3 125 (1976 - 1983)
- VESPA PRIMAVERA 125 (1967 - 1983)



FRECCHE - BLINKERS

246480401

NEW

**EVOX**Posizione Anteriore | *Installation point Front*Luce Led | *Light Led*Colore Corpo Nero | *Frame colour Black*Omologazione No | *Homologation No*

- VESPA FL2 HP
- VESPA FL 50
- VESPA PK 50 XL
- VESPA 125 HP
- VESPA FL 125
- VESPA PK 125 XL



FRECCE - BLINKERS

246480402 **NEW**



EVOX



Posizione Posteriore | *Installation point Rear*

Luce Led | *Light Led*

Colore Corpo Nero | *Frame colour Black*

Omologazione No | *Homologation No*

- VESPA FL2 HP
- VESPA FL 50
- VESPA PK 50 XL
- VESPA 125 HP
- VESPA FL 125
- VESPA PK 125 XL



246480403 **NEW**



EVOX



Posizione Anteriore | *Installation point Front*

Luce Led | *Light Led*

Colore Corpo Nero | *Frame colour Black*

Omologazione No | *Homologation No*

- VESPA PK 50 S (1982 - 1982)
- VESPA PK 50 (1982 - 1984)
- VESPA PK 125 S (1982 - 1985)
- VESPA PK 100 S (1982 - 1985)
- VESPA PK 50 (1982 - 1984)



246480404 **NEW**



EVOX



Posizione Posteriore | *Installation point Rear*

Luce Led | *Light Led*

Colore Corpo Nero | *Frame colour Black*

Omologazione No | *Homologation No*

- VESPA PK 50 S (1982 - 1982)
- VESPA PK 50 (1982 - 1984)
- VESPA PK 125 S (1982 - 1985)
- VESPA PK 100 S (1982 - 1985)
- VESPA PK 50 (1982 - 1984)

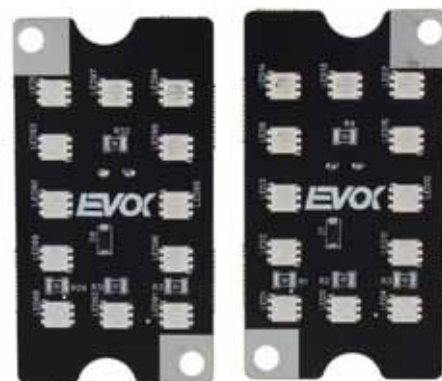

FRECCHE - BLINKERS**246480406** **NEW****EVOX**Posizione Anteriore | *Installation point Front*Luce Led | *Light Led*Colore Corpo Nero | *Frame colour Black*Omologazione No | *Homologation No*

- VESPA PX 80 E (1981 - 1997)
- VESPA PX 125 E ARCOBALENO (1983 - 1983)
- VESPA PX 150 E ELESTART (1984 - 1984)
- VESPA PX 150 E (1981 - 1981)
- VESPA PX 125 E ELESTART (1984 - 1984)

**246480407** **NEW****EVOX**Posizione Posteriore | *Installation point Rear*Luce Led | *Light Led*Colore Corpo Nero | *Frame colour Black*Omologazione No | *Homologation No*

- VESPA PX 80 E (1981 - 1997)
- VESPA PX 125 E ARCOBALENO (1983 - 1983)
- VESPA PX 150 E ELESTART (1984 - 1984)
- VESPA PX 150 E (1981 - 1981)
- VESPA PX 125 E ELESTART (1984 - 1984)

**246480408** **NEW****EVOX**Kit frecce | *Blinkers kit*Posizione Anteriore e posteriore | *Installation point Front and rear*Luce Led | *Light Led*Colore Corpo Nero | *Frame colour Black*Omologazione No | *Homologation No*

- VESPA FL2 HP
- VESPA FL 50
- VESPA PK 50 XL
- VESPA 125 HP
- VESPA FL 125
- VESPA PK 125 XL



FRECCE - BLINKERS

246480409 **NEW**



EVOX



Kit frecce | *Blinkers kit*

Posizione Anteriore e posteriore | *Installation point Front and rear*

Luce Led | *Light Led*

Colore Corpo Nero | *Frame colour Black*

Omologazione No | *Homologation No*

- VESPA PK 50 S (1982 - 1982)
- VESPA PK 50 (1982 - 1984)
- VESPA PK 125 S (1982 - 1985)
- VESPA PK 100 S (1982 - 1985)
- VESPA PK 50 (1982 - 1984)



ACCESSORI FANALI E FRECCHE - LIGHTS AND BLINKERS ACCESSORIES

246410321 **NEW**



Morsetto segestro fanale | *Securing headlight clamp*

- VESPA 50 N-R-L
 - VESPA ET3 125
 - VESPA PRIMAVERA 125
- R.O. 138006



INTERRUTTORI - SWITCHES

246140220 **NEW**



Interruttore stop | *Stop switch*

- VESPA SUPER 150 (1965 - 1979)
 - VESPA 150 VBB (1960 - 1962)
 - VESPA 125 (1958 - 1958)
 - VESPA 125 VNB6T (1965 - 1966)
 - VESPA 125 VNB3T (1961 - 1962)
- R.O. 05531



STATORI - STATORS**246350483 NEW**

- APE TM P703 FL2 (1999 - 2007)
 - APE TM P602 220 (1982 - 1983)
- R.O. 2202343-220235

**246360144 NEW**

- VESPA 50 SPECIAL (1975 - 1983)
 - VESPA 50 SPECIAL (1972 - 1975)
 - VESPA 50 SPECIAL (1970 - 1972)
 - VESPA 50 R (1969 - 1971)
 - VESPA 50 SPECIAL ELESTART (1970 - 1972)
- R.O. 11176

**CABLAGGI - WIRINGS****246490220 NEW**

- VESPA SUPER 150 (1965 - 1979)
 - VESPA 150 (1955 - 1955)
- R.O. 08130



CABLAGGI - WIRINGS

246490260 **NEW**



- VESPA SUPER 150 (1965 - 1979)
 - VESPA 125 VNB3T (1961 - 1962)
 - VESPA 125 VNB4T (1963 - 1963)
 - VESPA 125 (1963 - 1963)
 - VESPA 125 (1961 - 1962)
- R.O. 9348



ACCESSORI CABLAGGI - WIRINGS ACCESSORIES

121831103 **NEW**



Gommino copricavo statore | *Stator cables rubber cover*

- VESPA PK 125 S (1982 - 1985)
- VESPA PK 100 S (1982 - 1985)
- VESPA PK XL 50 (1985 - 1988)
- VESPA PK XL 125 (1986 - 1989)
- VESPA PK XL RUSH 50 (1988 - 1989)



246330363 **NEW**



N° poli 6 | *Numbers of poles 6*

- VESPA PK 125 S (1982 - 1985)
- VESPA PK 100 S (1982 - 1985)
- VESPA PK XL 50 (1985 - 1988)
- VESPA PK XL 125 (1986 - 1989)
- VESPA PK XL RUSH 50 (1988 - 1989)



MORSETTI CAVI - CABLE CLAMPS

121860324 **NEW**



- VESPA 50 SPECIAL 50 (1975 - 1983)
- VESPA PK 50 S (1982 - 1982)
- VESPA 50 SPECIAL (1970 - 1972)
- VESPA 50 SPECIAL (1972 - 1975)



CARICABATTERIE - TESTER - ACCESSORI - *BATTERY CHARGERS - TESTERS - ACCESSORIES*

121830730

NEW



Cinghia batteria | *Retaing strap for battery*

Materiale Gomma | *Material Rubber*

• VESPA PX





TRASMISSIONE

TRANSMISSION

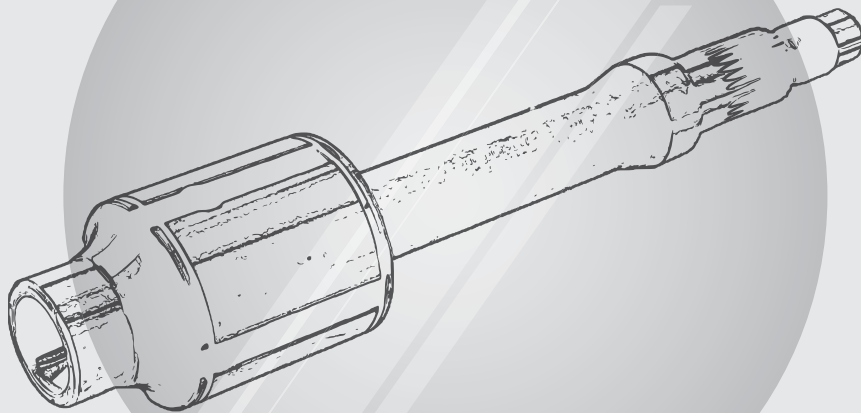

FRIZIONI COMPLETE - COMPLETE CLUTCHES

100290003 **NEW**



EVOX



Numero dischi 4 | *Number of plates 4*

Dischi Condotti 3 | *Driven Plates 3*

Numero Molle 8 | *Springs Number 8*

Peso 715 gr | *Weight 715 gr*

- VESPA 50 SPECIAL (1975 - 1983)
- VESPA ET3 125 (1976 - 1983)
- VESPA PRIMAVERA 125 (1967 - 1983)
- VESPA PK 50 S (1982 - 1982)
- VESPA 50 R (1969 - 1971)



DISCHI FRIZIONE - CLUTCH DISCS

100288800 **NEW**



EVOX

Caratteristiche Dischi sinterizzati |

Characteristics Sintered discs

Numero dischi 4 | *Number of plates 4*

- VESPA 50 SPECIAL (1975 - 1983)
- VESPA ET3 125 (1976 - 1983)
- VESPA PRIMAVERA 125 (1967 - 1983)
- VESPA PK 50 S (1982 - 1982)
- VESPA 50 SPECIAL (1972 - 1975)



COPPIA TRASMISSIONI PRIMARIE - CLUTCH GEAR COUPLE

100240151 **NEW**



EVOX



Campana frizione | *Clutch bell*

Materiale Alluminio | *Material Aluminium*

Primaria 72 denti | *Primary gear 72 teeth*

- VESPA 50 SPECIAL (1975 - 1983)
- VESPA PRIMAVERA 125 (1967 - 1983)
- VESPA PK 50 S (1982 - 1982)
- VESPA 50 SPECIAL (1970 - 1975)



COPPIA TRASMISSIONI PRIMARIE - CLUTCH GEAR COUPLE**100240161** **NEW****EVOX**Campana frizione | *Clutch bell*Materiale Alluminio | *Material Aluminium*Primaria 69 denti | *Primary gear 69 teeth*

- VESPA 50 SPECIAL (1975 - 1983)
- VESPA PRIMAVERA 125 (1967 - 1983)
- VESPA PK 50 S (1982 - 1982)
- VESPA 50 SPECIAL (1970 - 1975)

**KIT CAMBIO E ACCESSORI - GEAR KIT AND ACCESSORIES****100240121** **NEW****CLASSIC**Albero Secondario | *Driven shaft*

- VESPA 50 SPECIAL
- VESPA ET3 125
- VESPA PRIMAVERA 125
- VESPA PK 50 S
- VESPA 50 N-R-LR.O. 182541

**100240122** **NEW****CLASSIC**

Ingranaggio albero multiplo primario |

*Countershaft with primary gear*Denti 22x18x14x10 | *Teeth 22x18x14x10*

- VESPA 50 SPECIAL
 - VESPA ET3 125
 - VESPA PRIMAVERA 125
 - VESPA PK 50 S
 - VESPA 50 N-R-L
- R.O. 112377



100240128 **NEW**



Kit cambio 4 marce | *Four gearbox kit*

- VESPA 50 SPECIAL
- VESPA ET3 125
- VESPA PRIMAVERA 125
- VESPA PK 50 S
- VESPA 50 N-R-L



100240223 **NEW**



Perno ingranaggio multiplo | *Input shaft*

Diametro boccola 13 mm | *Bushing diameter 13 mm*

Diametro lato ruota 15 mm | *Wheel side diameter 15 mm*

Diametro sede cuscinetto 15 mm | *Bearing seat diameter 15 mm*

Lunghezza 121 mm | *Length 121 mm*

- VESPA PX 125 2°serie
 - VESPA PX 150 2°serie
- R.O.174515



100240284 **NEW**



Ingranaggio cambio | *Gear cog*

Denti 57 | *Teeth 57*

Diametro 117 mm | *Diameter 117 mm*

Marcia Prima | *Gear 1st*

- VESPA PX 125 2°serie
 - VESPA PX 150 2°serie
- R.O.152796



KIT CAMBIO E ACCESSORI - GEAR KIT AND ACCESSORIES**100240285** **NEW**Ingranaggio cambio | *Gear cog*Denti 54 | *Teeth 54*Diametro 109.5 mm | *Diameter 109.5 mm*Marcia Seconda | *Gear 2nd*

- VESPA PX 125 2°serie
- VESPA PX 150 2°serie

R.O.152797

**100240286** **NEW**Ingranaggio cambio | *Gear cog*Denti 48 | *Teeth 48*Diametro 102 mm | *Diameter 102 mm*Marcia Terza | *Gear 3rd*

- VESPA PX 125 2°serie
- VESPA PX 150 2°serie

R.O.152798

**100240287** **NEW**Ingranaggio cambio | *Gear cog*Denti 44 | *Teeth 44*Diametro 92.5 mm | *Diameter 92.5 mm*Marcia Quarta | *Gear 4th*

- VESPA PX 125 2°serie
- VESPA PX 150 2°serie

R.O.152799



100220021 **NEW**



EVOX



Crocera Cambio | *Gear Selector*

Altezza 50.2 mm | *Height 50.2 mm*

- VESPA 50 SPECIAL (1975 - 1983)
- VESPA ET3 125 (1976 - 1983)
- VESPA PK 50 S (1982 - 1982)
- VESPA PK 50 (1982 - 1984)
- VESPA SS 50 (1965 - 1971)

R.O. 13490



100240152 **NEW**



EVOX



Pignone campana frizione | *Clutch gear*

Numero denti 23 | *Teeth number 23*

Numero denti primaria 72 | *Primary teeth number*

Denti Dritti | *Teeth Straight*

- VESPA 50 SPECIAL (1975 - 1983)
- VESPA PRIMAVERA 125 (1967 - 1983)
- VESPA PK 50 S (1982 - 1982)
- VESPA 50 SPECIAL (1972 - 1975)
- VESPA 50 SPECIAL (1970 - 1972)



100240153 **NEW**



EVOX



Pignone campana frizione | *Clutch gear*

Numero denti 25 | *Teeth number 25*

Numero denti primaria 72 | *Primary teeth number*

Denti Dritti | *Teeth Straight*

- VESPA 50 SPECIAL (1975 - 1983)
- VESPA PRIMAVERA 125 (1967 - 1983)
- VESPA PK 50 S (1982 - 1982)
- VESPA 50 SPECIAL (1970 - 1972)
- VESPA 50 SPECIAL (1972 - 1975)



KIT CAMBIO E ACCESSORI - GEAR KIT AND ACCESSORIES**100240162****NEW****EVOX**Pignone campana frizione | *Clutch gear*Numero denti 26 | *Teeth number 26*Numero denti primaria 69 | *Primary teeth number*Denti Dritti | *Teeth Straight*

- VESPA 50 SPECIAL (1975 - 1983)
- VESPA PRIMAVERA 125 (1967 - 1983)
- VESPA PK 50 S (1982 - 1982)
- VESPA 50 SPECIAL (1970 - 1972)
- VESPA 50 SPECIAL (1972 - 1975)

**100240163****NEW****EVOX**Pignone campana frizione | *Clutch gear*Numero denti 28 | *Teeth number 28*Numero denti primaria 69 | *Primary teeth number*Denti Dritti | *Teeth Straight*

- VESPA 50 SPECIAL (1975 - 1983)
- VESPA PRIMAVERA 125 (1967 - 1983)
- VESPA PK 50 S (1982 - 1982)
- VESPA 50 SPECIAL (1972 - 1975)
- VESPA 50 SPECIAL (1970 - 1972)

**100240201****NEW**Vite selettore cambio | *Selector screw*Filetto M14 | *Thread M14*Lunghezza 50 mm | *Lenght 50 mm*

- VESPA 50 SPECIAL (1975 - 1983)
- VESPA ET3 125 (1976 - 1983)
- VESPA PRIMAVERA 125 (1967 - 1983)
- VESPA PK 50 S (1982 - 1982)

R.O. 09878



100240202 **NEW**



Vite selettore cambio | *Selector screw*

Filetto M14 | *Thread M14*

Lunghezza 66 mm | *Length 66 mm*

- VESPA FL 50 (1990 - 1990)
- VESPA FL2 HP (1991 - 1997)
- VESPA PK 50 HP (1991 - 1999)
- VESPA FL 125 (1989 - 1990)
- VESPA FL2 AUTOMATICA 50 (1990 - 1991)

R.O. 28656



100240388 **NEW**



Pignone primaria | *Primary driven gear*

Denti elicoidali Z67 | *Helicoidal cogs*

- VESPA SUPER 150 (1965 - 1979)
- VESPA SPRINT 150 (1965 - 1966)
- VESPA RALLY 200 (1972 - 1979)
- VESPA SPRINT - GR - SUPER - RALLY 125 (1965 - 1976)
- VESPA TS 125 (1975 - 1978)

R.O. 77351



100240389 **NEW**



Pignone primaria | *Primary driven gear*

Denti elicoidali Z65 | *Helicoidal cogs*

- VESPA PX 200 E (1977 - 1982)
- VESPA PX 200 E (1983 - 1983)
- VESPA PX 200 E (1982 - 1982)
- VESPA PX 200 E FRENO A DISCO (1998 - 2001)
- VESPA PX 200 E ARCOBALENO (1981 - 1997)

R.O. 11272



KIT CAMBIO E ACCESSORI - GEAR KIT AND ACCESSORIES**121855010****NEW**

Scodellino blocca dado castello frizione |

Locking washer castle clutch nut

- VESPA SUPER 150 (1965 - 1979)
- VESPA PX 80 E (1981 - 1997)
- VESPA PX 125 E ARCOBALENO (1983 - 1983)
- VESPA PX 150 E ELESTART (1984 - 1984)
- VESPA PX 150 E (1981 - 1981)

R.O. 22313

**121856122****NEW**Rondella ondulata leva comando | *Shim selector arm*Diametro esterno 12 mm | *Outer diameter 12 mm*Diametro interno 7.4 mm | *Internal diameter 7.4 mm*Materiale Acciaio zincato | *Material Galvanised steel*Spessore 0.5 mm | *Thickness 0.5 mm*

- VESPA SUPER 150 (1965 - 1979)
- VESPA 50 SPECIAL (1975 - 1983)
- VESPA ET3 125 (1976 - 1983)
- VESPA PRIMAVERA 125 (1967 - 1983)
- VESPA PK 50 S (1982 - 1982)

R.O. 078597

**121859250****NEW**Rondella piatta pignone primaria | *Flat locking washer primary gear*

- VESPA 50 SPECIAL (1975 - 1983)
- VESPA ET3 125 (1976 - 1983)
- VESPA PRIMAVERA 125 (1967 - 1983)
- VESPA PK 50 S (1982 - 1982)
- VESPA 50 SPECIAL (1972 - 1975)

R.O. 001821



100240118 **NEW**



EVOX



Ingranaggio quadruplo | *Input shaft*
Dentatura 3°/ 4° marcia corta | *Teeth 3 Rd / 4 Th short gear*

- VESPA 50 SPECIAL
- VESPA ET3 125
- VESPA PRIMAVERA 125
- VESPA PK 50 S
- VESPA 50 N-R-L



100240119 **NEW**



EVOX



Ingranaggio quadruplo | *Input shaft*
Dentatura 4° marcia corta | *Teeth 4 Th short gear*

- VESPA 50 SPECIAL
- VESPA ET3 125
- VESPA PRIMAVERA 125
- VESPA PK 50 S
- VESPA 50 N-R-L



100240124 **NEW**



Ingranaggio cambio | *Gear Cog*
Dentatura 46 | *Teeth 46*

- VESPA 50 SPECIAL
 - VESPA ET3 125
 - VESPA PRIMAVERA 125
 - VESPA PK 50 S
 - VESPA 50 N-R-L
- R.O. 134906



KIT CAMBIO E ACCESSORI - GEAR KIT AND ACCESSORIES**100240125** **NEW**Ingranaggio cambio | *Gear Cog*Dentatura 50 | *Teeth 50*

- VESPA 50 SPECIAL
- VESPA ET3 125
- VESPA PRIMAVERA 125
- VESPA PK 50 S
- VESPA 50 N-R-L

R.O. 134905

**100240126** **NEW**Ingranaggio cambio | *Gear Cog*Dentatura 54 | *Teeth 54*

- VESPA 50 SPECIAL
- VESPA ET3 125
- VESPA PRIMAVERA 125
- VESPA PK 50 S
- VESPA 50 N-R-L

R.O. 134904

**100240127** **NEW**Ingranaggio cambio | *Gear Cog*Dentatura 58 | *Teeth 58*

- VESPA 50 SPECIAL
- VESPA ET3 125
- VESPA PRIMAVERA 125
- VESPA PK 50 S
- VESPA 50 N-R-L

R.O. 134903



100240384 **NEW**



Pignone frizione | *Shift control*

Denti dritti z26 | *Straight cogs z26*

Denti elicoidali z22 | *Helicoidal cogs z22*

Diametro 96 mm | *Diameter 96 mm*

- VESPA PX 80 E 80 (1981 - 1997)
- VESPA PX 125 E ARCOBALENO 125 (1983 - 1983)
- VESPA PX 150 E ELESTART 150 (1984 - 1984)
- VESPA PX 150 E 150 (1981 - 1981)

R.O. 11306



100240385 **NEW**



Pignone frizione | *Shift control*

Denti dritti z26 | *Straight cogs z26*

Denti elicoidali z20 | *Helicoidal cogs z20*

Diametro 96 mm | *Diameter 96 mm*

- VESPA PX 80 E 80 (1981 - 1997)
- VESPA PX 125 E ARCOBALENO 125 (1983 - 1983)
- VESPA PX 150 E ELESTART 150 (1984 - 1984)
- VESPA PX 150 E 150 (1981 - 1981)

R.O. 17800



100240386 **NEW**



Pignone frizione | *Shift control*

Denti dritti z26 | *Straight cogs z26*

Denti elicoidali z22 | *Helicoidal cogs z22*

Diametro 96 mm | *Diameter 96 mm*

- VESPA PX 80 E 80 (1981 - 1997)
- VESPA PX 125 E ARCOBALENO 125 (1983 - 1983)
- VESPA PX 150 E ELESTART 150 (1984 - 1984)
- VESPA PX 150 E 150 (1981 - 1981)

R.O. 15010



KIT CAMBIO E ACCESSORI - GEAR KIT AND ACCESSORIES**100240387** **NEW**Pignone frizione | *Shift control*Denti dritti z26 | *Straight cogs z26*Denti elicoidali z20 | *Helicoidal cogs z20*Diametro 108 mm | *Diameter 108 mm*

- VESPA PX 125 T5 125 (1985 - 1985)
- VESPA PX 125 T5 ELESTART 125 (1986 - 1986)
- VESPA PX T5 125 (1985 - 1989)

R.O. 24134

**100260231** **NEW**Pignone frizione | *Shift control*Diametro frizione 115 mm | *Clutch diameter 115 mm*Numero denti 20 | *Teeth number 20*

- VESPA PX 125 (2011 - 2017)
- VESPA PX 200 E FRENO A DISCO (1998 - 2001)
- VESPA PX 150 (2011 - 2017)

R.O. 286899

**100260232** **NEW**Pignone frizione | *Shift control*Diametro frizione 115 mm | *Clutch diameter 115 mm*Diametro interno 40 mm | *Internal diameter 40 mm*Numero denti 21 | *Teeth number 21*

- VESPA PX 125 (2011 - 2017)
- VESPA PX 200 E FRENO A DISCO (1998 - 2001)
- VESPA PX 150 (2011 - 2017)

R.O. 28676



100260233 **NEW**



Pignone frizione | *Shift control*
 Diametro frizione 115 mm | *Clutch diameter*
 115 mm

Numero denti 22 | *Teeth number 22*

- VESPA PX 125 (2011 - 2017)
- VESPA PX 200 E FRENO A DISCO (1998 - 2001)
- VESPA PX 150 (2011 - 2017)



100260234 **NEW**



Pignone frizione | *Shift control*
 Diametro frizione 115 mm | *Clutch diameter*
 115 mm

Diametro interno 42 mm | *Internal diameter*
 42 mm

Numero denti 23 | *Teeth number 23*

- VESPA PX 125 (2011 - 2017)
 - VESPA PX 200 E FRENO A DISCO (1998 - 2001)
 - VESPA PX 150 (2011 - 2017)
- R.O. 433547



100300564 **NEW**



Spessore distanziale ingranaggio cambio | *Spacer gear box*

Spessore 1 mm | *Thickness 1 mm*

TUTTI I MODELLI

R.O.111996



KIT CAMBIO E ACCESSORI - GEAR KIT AND ACCESSORIES

100300565 **NEW**

Spessore distanziale ingranaggio cambio |

*Spacer gear box*Spessore 1,1 mm | *Thickness 1,1 mm*

TUTTI I MODELLI

R.O.165418

100300566 **NEW**

Spessore distanziale ingranaggio cambio |

*Spacer gear box*Spessore 1,2 mm | *Thickness 1,2 mm*

TUTTI I MODELLI

R.O.165417

100300567 **NEW**

Spessore distanziale ingranaggio cambio |

*Spacer gear box*Spessore 1,3 mm | *Thickness 1,3 mm*

TUTTI I MODELLI

R.O.156416

100300568 **NEW**

Spessore distanziale ingranaggio cambio |

*Spacer gear box*Spessore 1,4 mm | *Thickness 1,4 mm*

TUTTI I MODELLI

R.O.165415



100300569 **NEW**



Spessore distanziale ingranaggio cambio |

Spacer gear box

Spessore 1,5 mm | *Thickness 1,5 mm*

TUTTI I MODELLI



100300570 **NEW**



Spessore distanziale ingranaggio cambio |

Spacer gear box

Spessore 1,6 mm | *Thickness 1,6 mm*

TUTTI I MODELLI



100300571 **NEW**



Spessore distanziale ingranaggio cambio |

Spacer gear box

Spessore 1,7 mm | *Thickness 1,7 mm*

TUTTI I MODELLI



100300572 **NEW**



Spessore distanziale ingranaggio cambio |

Spacer gear box

Spessore 1,8 mm | *Thickness 1,8 mm*

TUTTI I MODELLI



CARROZZERIA

BODY WORK



PARAFANGHI - MUDGUARDS

142680121 **NEW**



Colore Nero | *Colour Black*
 Materiale Plastica | *Material Plastic*
 • SI 50 (1979 - 1988)
 • SI FL2 50 (1991 - 1997)
 R.O. 924800



PROFILI CARROZZERIA - CHASSIS BEADINGS

142640131 **NEW**



Materiale Alluminio | *Material Aluminium*
 Colore Argento | *Colour Silver*
 • VESPA 50 SPECIAL (1975 - 1983)
 • VESPA ET3 125 (1976 - 1983)
 • VESPA PRIMAVERA 125 (1967 - 1983)
 • VESPA 50 SPECIAL (1972 - 1975)
 • VESPA 50 SPECIAL (1970 - 1972)
 R.O. 070416-15017



142640290 **NEW**



Materiale Alluminio | *Material Aluminium*
 Colore Argento | *Colour Silver*
 • VESPA P 125 X (1977 - 1982)
 • VESPA PX 150 E (1981 - 1981)
 • VESPA PX 150 E ARCOBALENO (1983 - 1983)
 • VESPA P 125 X (1979 - 1983)
 • VESPA P 125 X (1977 - 1979)
 R.O. 14994



TAPPETINI IN GOMMA - FLOOR MATS

142670011

NEW



Materiale Gomma | *Material Rubber*

Colore Nero | *Colour Black*

- VESPA SUPER 150(1965 - 1979)
- VESPA 150 VBB (1960 - 1962)
- VESPA 125 (1965 - 1966)
- VESPA 125 VNB3T (1961 - 1962)
- VESPA 125 VNB6T (1965 - 1966)

R.O. 08507



142670021

NEW



Materiale Gomma | *Material Rubber*

Colore Nero | *Colour Black*

- VESPA PX 125 E ARCOBALENO (1983 - 1983)
- VESPA PX 150 E ELESTART (1984 - 1984)
- VESPA P 125 X (1977 - 1982)
- VESPA PX 125 E ELESTART (1984 - 1984)
- VESPA PX 150 E ARCOBALENO (1983 - 1983)

R.O. 180052-21910



TARGHETTE - SCUDI - FREGI - NAMEPLATES - BADGES - EMBLEMS

142720021

NEW



Materiale Plastica | *Material Plastic*

Colore Blu | *Colour Blue*

Dimensioni 32x37mm | *Dimension 32x37mm*

- VESPA PX 80 E (1981 - 1997)
- VESPA PX 125 E ARCOBALENO (1983 - 1983)
- VESPA PK XL 50 (1985 - 1988)
- VESPA PK XL 125 (1986 - 1989)
- VESPA PK XL RUSH 50 (1988 - 1989)

R.O. 25297



142721120

NEW



Materiale Alluminio | *Material Aluminium*
 Colore Argento | *Colour Silver*
 Dimensioni 135x25mm | *Dimension 135x25mm*
 Punto di installazione Cofano sinistro |
Mounting location Side panel left
 Tipo di fissaggio Autoadesivo | *Fixing system*
Sticker

- VESPA PX 200 E FRENO A DISCO (1998 - 2001)
 - VESPA PX 200 E ELESTART (1981 - 1997)
 - VESPA PX 200 E ELESTART (1981 - 1990)
- R.O. 57579

PX200

142721140

NEW



Materiale Alluminio | *Material Aluminium*
 Colore Nero / Rosso | *Colour Black / Red*
 Interasse perni 105 mm | *Pin distance 105 mm*
 Punto di installazione Cofano sinistro |
Mounting location Side panel left

- VESPA P 125 E (1981 - 1981)
- R.O. 19936

PX 125 E
 lusso

142721160

NEW



Materiale Alluminio | *Material Aluminium*
 Colore Nero / Rosso | *Colour Black / Red*
 Punto di installazione Cofano laterale |
Mounting location Side panel

- VESPA PX 200 E (1982 - 1982)
- R.O. 19936

PX 200 E
 lusso

142721310

NEW



Materiale Alluminio | *Material Aluminium*
 Colore Nero / Cromo | *Colour Black/Chrome*
 Dimensioni 123X15mm | *Dimension 123X15mm*
 • VESPA RALLY 200 (1972 - 1979)

RALLY 200

TARGHETTE - SCUDI - FREGI - NAMEPLATES - BADGES - EMBLEMS

142721320

NEW



Materiale Alluminio | *Material Aluminium*
 Colore Nero / Cromo | *Colour Black/Chrome*
 Punto di installazione Sportellino | *Mounting location Side panel door*

- BRAVO 50 (1975 - 1981)
- R.O. 16396

bravo

142721330

NEW



Materiale Alluminio | *Material Aluminium*
 Colore Nero / Cromo | *Colour Black/Chrome*

- BOXER 50 (1970 - 1972)

boxer2

142721350

NEW



Materiale Alluminio | *Material Aluminium*
 Colore Nero / Cromo | *Colour Black/Chrome*

- APE CAR P2-P3 220 (1978 - 1985)
- APE CAR - MAX DIESEL 420 (1986 - 1996)
- APE CAR P2-VESPA CAR P2-APE CAR P3 220 (1972 - 1986)
- APE CAR 220 (1972 - 1986)

vespacar

142721360

NEW



Materiale Alluminio | *Material Aluminium*
 Colore Nero / Cromo | *Colour Black/Chrome*

- SI 50 (1979 - 1988)
- SI FL2 50 (1991 - 1997)

si

142721380 **NEW**



Materiale Alluminio | *Material Aluminium*
 Colore Nero / Cromo | *Colour Black/Chrome*
 Dimensioni 115x25mm | *Dimension 115x25mm*
 Interasse perni 60 mm | *Pin distance 60 mm*

- VESPA PK 125 S (1982 - 1985)
- VESPA PK 125 S (1982 - 1982)
- VESPA PK 125 ETS (1984 - 1984)
- VESPA PK 125 ETS ELESTART (1984 - 1984)
- VESPA PK 125 S ELESTART (1983 - 1989)

R.O. 19818



142721390 **NEW**



Materiale Alluminio | *Material Aluminium*
 Colore Nero / Cromo | *Colour Black/Chrome*
 Dimensioni 135x32mm | *Dimension 135x32mm*
 Interasse fori 80 mm | *Wheelbase 80 mm*

- VESPA PK 125 S ELESTART (1983 - 1989)
- VESPA PK 125 AVVIAMENTO ELETTRICO (1984 - 1989)
- VESPA PK 125 S ELESTART (1983 - 1983)



142721410 **NEW**



Materiale Alluminio | *Material Aluminium*
 Colore Nero / Cromo | *Colour Black/Chrome*

- VESPA PK AVVIAMENTO ELETTRICO (1984 - 1989)
- VESPA PK 50 SS ELESTART (1983 - 1983)



142721420 **NEW**



Materiale Alluminio | *Material Aluminium*
 Colore Blu | *Colour Blue*

- VESPA SUPER 125 (1966 - 1968)



TARGHETTE - SCUDI - FREGI - NAMEPLATES - BADGES - EMBLEMS

142721451

NEW



Materiale Resina | *Material Resin*

Colore Blu | *Colour Blue*

Tipo di fissaggio Autoadesivo | *Fixing system Sticker*

- VESPA SUPER 150 (1965 - 1979)
- VESPA SPRINT 150 (1965 - 1966)
- VESPA 150 VBB (1960 - 1962)
- VESPA 125 (1958 - 1958)
- VESPA 125 (1965 - 1966)



142721452

NEW



Materiale Alluminio | *Material Aluminium*

Colore Blu | *Colour Blue*

Dimensioni 36x47mm | *Dimension 36x47mm*

Tipo di fissaggio Da incollare | *Fixing system To be glued*

- VESPA SUPER 150 (1965 - 1979)
- VESPA SPRINT 150 (1965 - 1966)
- VESPA 125 (1958 - 1958)
- VESPA 125 (1965 - 1966)
- VESPA 125 (1964 - 1964)

R.O. 02485



142721453

NEW



Materiale Alluminio | *Material Aluminium*

Colore Blu | *Colour Blue*

- VESPA 50 N (1963 - 1971)
- VESPA 50 (1963 - 1967)
- VESPA 50 (1963 - 1966)
- VESPA 50 (1963 - 1983)
- VESPA 50 S (1963 - 1983)



TARGHETTE - SCUDI - FREGI - NAMEPLATES - BADGES - EMBLEMS

142721490 **NEW**



Materiale Alluminio | *Material Aluminium*
 Colore Nero / Grigio | *Colour Black / Grey*
 Dimensioni 115x28mm | *Dimension 115x28mm*
 Tipo di fissaggio Da incollare | *Fixing system To be glued*

- CIAO 50 (1980 - 1988)
 - CIAO 50 (1971 - 1999)
 - CIAO TRE 50 (1971 - 1999)
 - BRAVO 50 (1975 - 1981)
- R.O. 18234



PLASTICHE CARROZZERIA - CHASSIS PLASTICS

142680559 **NEW**



Paraspruzzi | *Mud flap*
 Materiale Plastica | *Material Plastic*
 Colore Nero | *Colour Black*
 Diametro foro 10 mm | *Hole diameter 10 mm*
 Interasse fori 110 mm | *Wheelbase 110 mm*

- VESPA PK 50 S (1982 - 1982)
 - VESPA PK 50 (1982 - 1984)
 - VESPA PK 125 S (1982 - 1985)
 - VESPA PK 100 S (1982 - 1985)
 - VESPA PK 50 (1982 - 1984)
- R.O. 199257



ACCESSORI CARROZZERIA - BODYPARTS ACCESSORIES

121831180 **NEW**



Guarnizione pedale freno | *Gasket for brake pedal*
 Materiale Gomma | *Material Rubber*
 Confezione 10 | *Pack 10 Pieces*
 Diametro 4 mm | *Diameter 4 mm*

- VESPA 50 SPECIAL (1975 - 1983)
 - VESPA 50 SPECIAL (1975 - 1983)
 - VESPA ET3 125 (1976 - 1983)
 - VESPA ET3 125 (1976 - 1983)
 - VESPA PRIMAVERA 125 (1967 - 1983)
- R.O. 9089700



ACCESSORI CARROZZERIA - BODYPARTS ACCESSORIES

121831200

NEW



Tappo chiusura porta ruota di scorta | *Cover
plug wheel holder*

Colore Grigio | *Colour Gray*

Filetto M8 | *Thread M8*

Materiale Plastica | *Material Plastic*

- VESPA 50 SPECIAL (1975 - 1983)
- VESPA ET3 125 (1976 - 1983)
- VESPA PK 50 S (1982 - 1982)
- VESPA PK 50 (1982 - 1984)
- VESPA SS 50 (1965 - 1971)

R.O. 90958



121831230

NEW



Distanziale parafrangente | *Mudguard spacer*

Diametro 18 mm | *Diameter 18 mm*

Materiale Plastica | *Material Plastic*

- VESPA 50 SPECIAL (1975 - 1983)
- VESPA ET3 125 (1976 - 1983)
- VESPA PK 50 S (1982 - 1982)
- VESPA PK 50 (1982 - 1984)
- VESPA SS 50 (1965 - 1971)

R.O. 212795



121831290

NEW



Puntale striscia pedana | *Floor runner end cap*

Materiale Plastica | *Material Plastic*

Caratteristiche Con foro | *Characteristics With
hole*

Confezione 30 | *Pack*

- VESPA PX 125 E ARCOBALENO (1978 - 1983)
- VESPA PX 150 E ELESTART (1978 - 1984)
- VESPA PX 125 E ELESTART (1978 - 1984)
- VESPA PX 150 E ARCOBALENO (1978 - 1983)
- VESPA PX 80 E ARCOBALENO (1983 - 1983)

R.O. 159828



121831295

NEW



Puntale striscia pedana | *Floor runner end cap*

Materiale Plastica | *Material Plastic*

Caratteristiche Senza foro | *Characteristics Without hole*

Without hole

Confezione 30 | *Pack*

• VESPA PX (1983-2016)

R.O. 182174



142600012

NEW



Tassello vite fissaggio nasello | *Peg screw horn cover*

• VESPA PX

• VESPA PK

• VESPA HP

R.O. 157716 - 199190



142680911

NEW



Paracolpi cofani e parafango | *Bonnet and mudguard bumpers*

Materiale Gomma | *Material Rubber*

• VESPA PX 125 E ARCOBALENO (1983 - 1983)

• VESPA PX 150 E ELESTART (1984 - 1984)

• VESPA PX 125 E ELESTART (1984 - 1984)

• VESPA PX 150 E ARCOBALENO (1983 - 1983)

• VESPA PX 80 E ARCOBALENO (1983 - 1983)



142760118

NEW



Copri ruota | *Wheel cover*

Adatto per Pneumatico 3.00-10 | *Fit for 3.00-10 wheel*

• VESPA PX 80 E (1981 - 1997)

• VESPA SPRINT (1965 - 1966)

• VESPA P 125 X (1977 - 1979)

• VESPA P 150 X (1977 - 1979)



ACCESSORI CARROZZERIA - BODYPARTS ACCESSORIES

142760119

NEW



Copri ruota | *Wheel cover*
Adatto per Pneumatico 2.75-9 | *Fit for 2.75-9 wheel*

- VESPA 50 SPECIAL (1970 - 1972)
- VESPA 50 R (1969 - 1971)
- VESPA 50 SPECIAL ELESTART (1970 - 1972)
- VESPA 50 N (1963 - 1971)
- VESPA 50 S (1963 - 1968)



142760120

NEW



Copri ruota | *Wheel cover*
Adatto per Pneumatico 3.50-8 | *Fit for 3.50-8 wheel*

- VESPA SUPER 150 (1965 - 1979)
- VESPA 150 VBB (1960 - 1962)
- VESPA 125 (1958 - 1958)
- VESPA 125 (1951 - 1951)
- VESPA 125 (1952 - 1952)



GOMMINI ANTIVIBRANTI - RUBBER PADS

121831064

NEW



Tappo vaschetta carburatore | *Plug cover carburetor casing*

Materiale Gomma | *Material Rubber*

Confezione 10 | *Pack 10 Pieces*

Colore Nero | *Colour Black*

- VESPA SUPER 150 (1965 - 1979)
- VESPA 50 R (1969 - 1971)
- VESPA PX 80 E (1981 - 1997)
- VESPA PX 125 E ARCOBALENO (1983 - 1983)
- VESPA PX 150 E ELESTART (1984 - 1984)

R.O. 087975



121831190

NEW



Gommini cofano | *Buffer side panel*

Materiale Gomma | *Material Rubber*

Confezione 20 | *Pack 20 Pieces*

Colore Nero | *Colour Black*

- VESPA P 125 X (1977 - 1982)
- VESPA PX 150 E (1981 - 1981)
- VESPA PXE ARCOBALENO 125 (1981 - 1997)
- VESPA P 150 X (1978 - 1981)
- VESPA PX 125 T5 (1985 - 1985)

R.O. 19508



TELAIO

CHASSIS



121856119

NEW



Kit leva freno frizione \ | *Screw kit for brake and clutch lever*

Caratteristiche Vite e rondella | *Characteristics Screw and washer*

Pezzi 5 | *Pieces 5*

- VESPA 50 SPECIAL (1975 - 1983)
- VESPA PRIMAVERA 125 (1967 - 1983)
- VESPA 50 SPECIAL (1972 - 1975)
- VESPA 50 SPECIAL (1970 - 1972)
- VESPA 50 R (1969 - 1971)

R.O. 150235



121856121

NEW



Rondella leva freno e frizione | *Brake and clutch lever washer*

Diametro 12 mm | *Diameter 12 mm*

Punto di installazione Inferiore | *Mounting location Lower*

Spessore 0.4 mm | *Thickness 0.4 mm*

- VESPA 50 SPECIAL (1975 - 1983)
- VESPA 50 SPECIAL (1975 - 1983)
- VESPA 50 SPECIAL (1972 - 1975)
- VESPA 50 SPECIAL (1970 - 1972)

R.O. 97734



121856123

NEW



Rondella elastica leva freno e frizione | *Brake and clutch lever washer*

Diametro 14 mm | *Diameter 14 mm*

Punto di installazione Superiore | *Mounting location Upper*

Spessore 0.5 mm | *Thickness 0.5 mm*

- VESPA 50 SPECIAL (1975 - 1983)
- VESPA 50 SPECIAL (1972 - 1975)
- VESPA 50 SPECIAL (1970 - 1972)
- VESPA 50 R (1969 - 1971)

R.O. 017492



TUBI COMANDO - THROTTLE AND SHIFT CONTROLS**184040880** **NEW****EVOX**Tipologia Tubo Gas | *Type Throttle tube*

- VESPA ET3 125 (1976 - 1983)
- VESPA PK 50 S (1982 - 1982)
- VESPA 50 SPECIAL (1972 - 1975)
- VESPA 50 R (1969 - 1971)
- VESPA 50 L (1966 - 1970)

**ACCESSORI CAVALLETTI - STANDS ACCESSORIES****121830541** **NEW****CLASSIC**Gommino cavalletto centrale | *Buffer center stand*

- VESPA 125 VNB2T
 - VESPA 125 GT
 - VESPA 125 GTR
 - VESPA 150 VBB1T
- R.O. 54146-54147

**121831150** **NEW****CLASSIC**Gommino cavalletto centrale | *Buffer center stand*Materiale Gomma | *Material Rubber*

- VESPA PK 50 S (1982 - 1982)
 - VESPA PK 50 (1982 - 1984)
 - VESPA PK 125 S (1982 - 1985)
 - VESPA PK 100 S (1982 - 1985)
 - VESPA PK 50 (1982 - 1984)
- R.O. 254585 - 216256

**121831310** **NEW****CLASSIC**Piedini cavalletto | *Stand feet*Colore Nero | *Colour Black*Diametro 16 mm | *Diameter 16 mm*

- VESPA 50 SPECIAL
 - VESPA ET3 125 (1976 - 1983)
- R.O. 101957



CONTACHILOMETRI - SPEEDOMETERS

163680183 **NEW**



Scala 160 Km/h | Scale 160 Km/h

Colore Nero | Colour Black

Colore cornice Argento cromato | Ring color
Chromed silver

Colore numeri Bianco | Color number White

Diametro 105 mm | Diameter 105 mm

- VESPA PX 80 E (1981 - 1997)
- VESPA PX 125 E ARCOBALENO (1983 - 1983)
- VESPA PX 150 E ELESTART (1984 - 1984)
- VESPA PX 150 E (1981 - 1981)
- VESPA PX 125 E ELESTART (1984 - 1984)



163680193 **NEW**



Scala 120 Km/h | Scale 120 Km/h

Colore Nero | Colour Black

Colore cornice Nero | Ring color Black
Colore numeri Arancione | Color number
Orange

Diametro 105 mm | Diameter 105 mm

- VESPA PK XL 50 (1985 - 1988)
- VESPA PK XL 125 (1986 - 1989)
- VESPA PK 50 XL RUSH (1988 - 1989)
- VESPA PK XL RUSH (1988 - 1989)
- VESPA PK 50 XL ELESTART (1986 - 1986)



ACCESSORI CONTACHILOMETRI - SPEEDOMETERS ACCESSORIES

163690233 **NEW**



Coppia ingranaggi rinvio | Speedometer
pinions

- VESPA SUPER 150 (1965 - 1979)
- VESPA 50 SPECIAL (1975 - 1983)
- VESPA ET3 125 (1976 - 1983)
- VESPA PRIMAVERA 125 (1967 - 1983)
- VESPA PK 50 S (1982 - 1982)



ACCESSORI CONTACHILOMETRI - SPEEDOMETERS ACCESSORIES**121831220****NEW**

Gommino trasmissione kontakm |
Speedometers cable base plate
 Materiale Gomma | *Material Rubber*

- VESPA P 125 X (1977 - 1982)
- VESPA PX 150 E (1981 - 1981)
- VESPA PXE ARCOBALENO 125 (1981 - 1997)
- VESPA P 150 X (1978 - 1981)
- VESPA PX 125 T5 (1985 - 1985)

R.O. 17412

**121831240****NEW**

Gommino trasmissione kontakm |
Speedometers cable plate
 Materiale Gomma | *Material Rubber*

- VESPA 50 SPECIAL (1975 - 1983)
- VESPA ET3 125 (1976 - 1983)
- VESPA 50 SPECIAL (1970 - 1972)
- VESPA 50 SPECIAL (1972 - 1975)

R.O. 5793

**121859238****NEW**

Dado fissaggio kontakm | *Speedometers nut*

- VESPA 50 SPECIAL (1975 - 1983)
- VESPA ET3 125 (1976 - 1983)
- VESPA PRIMAVERA 125 (1967 - 1983)
- VESPA PK 50 S (1982 - 1982)

R.O. 012113

**CAVI TRASMISSIONE - TRANSMISSION CABLES****163514121****NEW**

Cavo frizione | *Clutch cable*

Confezione 10 | *Pack 10 Pieces*

Confezione 10 | *Pack 10 Pieces*

Dimensioni 1.86X2.20 | *Dimension 1.86X2.20*

Materiale Acciaio Zincato | *Material Steel zinc plated*

Note Senza guaina | *Note Without sleeve*



163514129

NEW



Cavo frizione | *Clutch cable*
 Confezione 25 | *Pack 25 Pieces*
 Confezione 25 | *Pack 25 Pieces*
 Dimensioni 1.86X2.20 | *Dimension 1.86X2.20*
 Materiale Acciaio Zincato | *Material Steel zinc plated*
 Note Senza guaina | *Note Without sleeve*



163631010

NEW



Cavo trasmissione contaKm | *Speedometer transmission cable*

- VESPA 50 SPECIAL (1975 - 1983)
 - VESPA ET3 125 (1976 - 1983)
 - VESPA PRIMAVERA 125 (1967 - 1983)
 - VESPA 50 SPECIAL (1972 - 1975)
- R.O. 07105



163631030

NEW



Cavo trasmissione conta Km | *Speedometer transmission cable*

- VESPA FL 50 (1990 - 1990)
 - VESPA FL2 HP 50 (1991 - 1997)
 - VESPA FL 125 (1989 - 1990)
 - VESPA FL2 AUTOMATICA 50 (1990 - 1991)
- R.O. 26632



163631040

NEW



Cavo trasmissione conta Km | *Speedometer transmission cable*

- VESPA PK 50 (1982 - 1984)
 - VESPA PK XL 50 (1985 - 1988)
 - VESPA PK XL 125 (1986 - 1989)
 - VESPA PK XL RUSH 50 (1988 - 1989)
 - VESPA PK XL PLURIMATIC 50 (1985 - 1990)
- R.O. 19540



CAVI TRASMISSIONE - TRANSMISSION CABLES**163631050** **NEW**Cavo trasmissione conta Km | *Speedometer transmission cable*

- VESPA P 125 X (1977 - 1982)
- VESPA P 125 X (1979 - 1983)
- VESPA P 125 X (1977 - 1979)
- VESPA P 150 X (1978 - 1981)
- VESPA P 150 X (1979 - 1983)

R.O. 17426

**163631060** **NEW**Cavo trasmissione conta Km | *Speedometer transmission cable*

- VESPA PX 150 E ELESTART (1984 - 1984)
- VESPA PX 125 E ELESTART (1984 - 1984)
- VESPA PXE ARCOBALENO (1981 - 1997)
- VESPA PX 80 E ELESTART (1984 - 1984)
- VESPA PX T5 125 (1985 - 1989)

R.O. 17927, 22935

**163631070** **NEW**Cavo trasmissione conta Km | *Speedometer transmission cable*

- VESPA PXE ARCOBALENO 125 (1981 - 1997)
- VESPA PX T5 125 (1985 - 1989)
- COSA CL-CLX 125 (1988 - 1991)
- COSA 2 125 (1991 - 1997)
- COSA 2 200 (1991 - 1997)

R.O. 22935



163631250 **NEW**



Cavo trasmissione conta Km | *Speedometer transmission cable*

- VESPA PX 125 (2011 - 2017)
 - VESPA PX 200 E FRENO A DISCO (1998 - 2001)
 - VESPA PX 30 ANNI 125 (2007 - 2008)
 - VESPA PX 150 E FRENO A DISCO (1998 - 2001)
 - VESPA PX 125 (1998 - 2001)
- R.O. 56379, 60110, 66846



163631900 **NEW**



Cavo trasmissione conta Km | *Speedometer transmission cable*

- VESPA SUPER 150 (1965 - 1979)
 - VESPA SPRINT 150 (1965 - 1966)
 - VESPA SPRINT - GR - SUPER - RALLY 125 (1965 - 1976)
- R.O. 09901



163631910 **NEW**



Cavo trasmissione conta Km | *Speedometer transmission cable*

- VESPA SUPER 150 (1965 - 1979)
- R.O. 09771



163631920 **NEW**



Cavo trasmissione conta Km | *Speedometer transmission cable*

- VESPA SUPER 150 (1965 - 1979)
 - VESPA 125 (1965 - 1966)
 - VESPA 125 VNB6T (1965 - 1966)
 - VESPA 125 (1955 - 1965)
- R.O. 09864



CAVI TRASMISSIONE - TRANSMISSION CABLES**163631930** **NEW**Cavo trasmissione conta Km | *Speedometer transmission cable*

- VESPA SUPER 150 (1965 - 1979)
- VESPA 150 VB1 (1957 - 1958)

**163631940** **NEW**Cavo trasmissione conta Km | *Speedometer transmission cable*

- VESPA GS - SUPER SPORT 150 (1955 - 1965)
- R.O. 05704

**163631941** **NEW**Cavo trasmissione conta Km | *Speedometer transmission cable*

- VESPA GS 160 (1962 - 1964)

**163631950** **NEW**Cavo trasmissione conta Km | *Speedometer transmission cable*

- VESPA SUPER 150 (1965 - 1979)
 - VESPA GS - SUPER SPORT 150 (1955 - 1965)
 - VESPA RALLY 200 (1972 - 1979)
- R.O. 09052

**163631960** **NEW**Cavo trasmissione conta Km | *Speedometer transmission cable*

- VESPA PRIMAVERA 125 (1967 - 1983)
- R.O. 18358



163632120 **NEW**



Cavo trasmissione conta Km | *Speedometer transmission cable*

- VESPA SUPER 150 (1965 - 1979)
- VESPA 125 (1952 - 1952)
- VESPA 125 (1951 - 1951)
- VESPA 125 (1954 - 1955)
- VESPA 125 (1956 - 1957)

R.O. 02115



163632121 **NEW**



Cavo trasmissione conta Km | *Speedometer transmission cable*



163632123 **NEW**



Cavo trasmissione conta Km | *Speedometer transmission cable*



163632130 **NEW**



Cavo trasmissione conta Km | *Speedometer transmission cable*

- VESPA SUPER 150 (1965 - 1979)
- VESPA GS 150 (1958 - 1961)
- VESPA GS 150 (1959 - 1964)

R.O. 02419



163632131 **NEW**



Cavo trasmissione conta Km | *Speedometer transmission cable*

- VESPA SUPER 150 (1965 - 1979)
- VESPA GS - SUPER SPORT 150 (1955 - 1965)
- VESPA GS 150 (1958 - 1961)
- VESPA GS 150 (1959 - 1964)



ACCESSORI CAVI TRASMISSIONE - TRANSMISSION CABLES ACCESSORIES**184040673** **NEW**Bussola cavo gas | *Cable end for throttle*

- VESPA PX 125 E ARCOBALENO (1983 - 1983)
- VESPA PX 150 E ELESTART (1984 - 1984)
- VESPA PX 150 E (1981 - 1981)
- VESPA P 125 X (1977 - 1982)
- VESPA PX 125 E ELESTART (1984 - 1984)

R.O. 139912

**PASSACAVI - GROMMETS****121830410** **NEW**

- VESPA 50 SPECIAL (1975 - 1983)
- VESPA ET3 125 (1976 - 1983)
- VESPA PRIMAVERA 125 (1967 - 1983)
- VESPA 50 SPECIAL (1972 - 1975)

R.O. 07021

**121830830** **NEW**

- VESPA PK 50 S (1982 - 1982)
- VESPA PK 125 S (1982 - 1985)
- VESPA PK 50 (1982 - 1984)
- VESPA PK XL 50 (1985 - 1988)
- VESPA PK XL 125 (1986 - 1989)

R.O. 24107

**121831210** **NEW**Materiale Gomma | *Material Rubber*Confezione 20 | *Pack 20 Pieces*

- VESPA 125 (1951 - 1951)
- VESPA 125 (1952 - 1952)
- VESPA 125 (1952 - 1953)
- VESPA 125 (1953 - 1955)
- VESPA 125 (1955 - 1965)

R.O. 467620



PASSACAVI - GROMMETS

121831211

NEW



Altezza 6.5 mm | Height 6.5 mm

Colore Nero | Colour Black

Diametro esterno 14 mm | Outer diameter 14 mm

Diametro interno 8 mm | Internal diameter 8 mm

Diametro sezione centrale 11 mm | Mid section diameter 11 mm

Materiale Gomma | Material Rubber

- VESPA 50 SPECIAL (1975 - 1983)
- VESPA ET3 125 (1976 - 1983)
- VESPA PRIMAVERA 125 (1967 - 1983)
- VESPA 50 SPECIAL (1972 - 1975)

R.O. 01509



121831250

NEW



Materiale Gomma | Material Rubber

Confezione 10 | Pack 10 Pieces

- VESPA 50 SPECIAL (1975 - 1983)
- VESPA ET3 125 (1976 - 1983)
- VESPA 50 SPECIAL (1972 - 1975)
- VESPA 50 SPECIAL (1970 - 1972)
- VESPA 50 SPECIAL ELESTART (1970 - 1972)

R.O. 4676



SERRATURE - LOCKS

121790733

NEW



- VESPA PK XL 50 (1985 - 1988)
- VESPA PK XL 125 (1986 - 1989)
- VESPA PK XL RUSH 50 (1988 - 1989)
- VESPA PK XL PLURIMATIC 50 (1985 - 1990)



ACCESSORI SERRATURE - LOCKS ACCESSORIES**121870032** **NEW**Chiusura sportello laterale | *Lock sidepanel*

- VESPA PK 125 S (1982 - 1985)
- VESPA PK 100 S (1982 - 1985)
- VESPA PK 50 S (1982 - 1985)
- VESPA PK 80 S (1982 - 1985)
- VESPA PK 125 (1982 - 1985)

R.O. 21526

**ACCESSORI PEDALI - PEDALS ACCESSORIES****121831170** **NEW**Gommino quadrato battuta freno | *Gasket
brake pedal*

- VESPA 50 SPECIAL 2° serie
- VESPA ET3 125 2° serie
- VESPA PRIMAVERA 125 2° serie
- VESPA PX 2° serie

R.O. 194380

**SELLE - SEATS****142760111** **NEW**Colore Bianco | *Colour White*

- VESPA 50 SPECIAL (1975 - 1983)
- VESPA ET3 125 (1976 - 1983)
- VESPA PRIMAVERA 125 (1967 - 1983)
- VESPA 50 SPECIAL (1972 - 1975)



SELLE - SEATS

142760112

NEW



Colore Bianco | Colour White

- VESPA PX 80 E (1981 - 1997)
- VESPA PX 125 E ARCOBALENO (1983 - 1983)
- VESPA PX 150 E ELESTART (1984 - 1984)
- VESPA PX 150 E (1981 - 1981)
- VESPA PX 125 E ELESTART (1984 - 1984)



142760113

NEW



Colore Jeans | Colour Jeans

Caratteristiche Con serratura | Characteristics
With lock

- VESPA ET3 125 (1976 - 1983)
- VESPA 125 (1967 - 1982)



SELLE - SEATS**142760114****NEW**Colore Jeans | *Colour Jeans*Caratteristiche Con levetta | *Characteristics**With lever*

- VESPA ET3 125 (1976 - 1983)
- VESPA 125 (1967 - 1982)

**ACCESSORI SELLE - SEATS ACCESSORIES****142760115****NEW**Copertina Sella | *Seat cover*Colore Jeans | *Colour Jeans*

- VESPA ET3 125 (1976 - 1983)
- VESPA 125 (1967 - 1982)

**142760116****NEW**Maniglia sella rigida | *Rigid seat handle*Materiale Plastica | *Material Plastic*

- VESPA SUPER 150 (1965 - 1979)
- VESPA PX 80 E (1981 - 1997)
- VESPA SPRINT 150 (1965 - 1966)
- VESPA P 125 X (1977 - 1979)
- VESPA P 150 X (1977 - 1979)





SOSPENSIONI

S U S P E N S I O N S

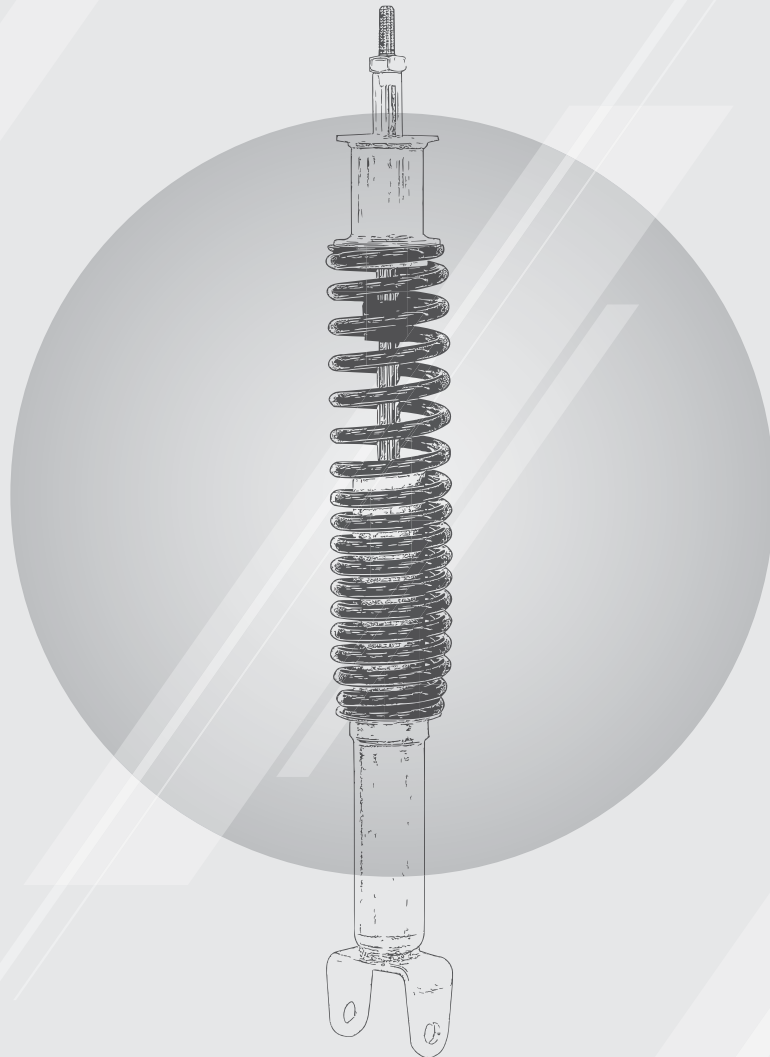

121830351 **NEW**



Boccola silent block ammortizzatore | *Distance tube for shock absorber*

Diametro esterno 15 mm | *Outer diameter 15 mm*

Diametro interno 10 mm | *Internal diameter 10 mm*

Lunghezza 48 mm | *Lenght 48 mm*

• VESPA VARI MODELLI



121831120 **NEW**



Tampone ammortizzatore | *Shock absorber buffer*

Confezione 10 | *Pack 10 Pieces*

Diametro esterno 38 mm | *Outer diameter 38 mm*

Punto di installazione Inferiore | *Mounting location Lower*

• VESPA PK 50 S (1982 - 1982)

• VESPA PK 50 (1982 - 1984)

• VESPA PK 125 S (1982 - 1985)

• VESPA PK 100 S (1982 - 1985)

• VESPA PK 50 (1982 - 1984)

R.O. 178149



121831130 **NEW**



Tampone ammortizzatore | *Shock absorber buffer*

Confezione 10 | *Pack 10 Pieces*

Diametro esterno 31 mm | *Outer diameter 31 mm*

Punto di installazione Superiore | *Mounting location Upper*

• VESPA PK 50 S (1982 - 1982)

• VESPA PK 50 (1982 - 1984)

• VESPA PK 125 S (1982 - 1985)

• VESPA PK 100 S (1982 - 1985)

• VESPA PK 50 (1982 - 1984)

R.O. 178150



ACCESSORI AMMORTIZZATORI - SOSPENSIONI - SHOCK ABSORBERS - SUSPENSIONS ACCESSORIES**142620041****NEW**Copri molleggio | *Hub cover*Materiale Alluminio | *Material Aluminium*Colore Grigio | *Colour Grey*

- VESPA 50 SPECIAL (1975 - 1983)
- VESPA ET3 125 (1976 - 1983)
- VESPA PRIMAVERA 125 (1967 - 1983)
- VESPA 50 SPECIAL (1972 - 1975)
- VESPA 50 SPECIAL (1970 - 1972)

R.O. 07017

**142620043****NEW**Copri molleggio | *Hub cover*Materiale Plastica | *Material Plastic*Colore Grigio | *Colour Grey*

- VESPA PK 50 S (1982 - 1982)
- VESPA PK 50 (1982 - 1984)
- VESPA PK 125 S (1982 - 1985)
- VESPA PK 100 S (1982 - 1985)
- VESPA PK 50 (1982 - 1984)

R.O. 219966





CUSCINETTI

BEARINGS



CUSCINETTI A SFERE - BALL BEARINGS

100200360 **NEW**



Cuscinetto ruota anteriore | *Front wheel bearing*

Diametro interno 12 mm | *Internal diameter 12 mm*

Diametro esterno 32 mm | *Outer diameter 32 mm*

Altezza 10 mm | *Height 10 mm*

- VESPA 50 SPECIAL (1975 - 1983)
- VESPA ET3 125 (1976 - 1983)
- VESPA PRIMAVERA 125 (1967 - 1983)
- VESPA PK 50 S (1982 - 1982)

R.O. 00713



100200370 **NEW**



Diametro interno 15 mm | *Internal diameter 15 mm*

Diametro esterno 35 mm | *Outer diameter 35 mm*

Altezza 11 mm | *Height 11 mm*

- VESPA PK 50 (1982 - 1984)
- VESPA PK XL 125 (1986 - 1989)
- VESPA PK XL RUSH 50 (1988 - 1989)
- VESPA PX 125 E ELESTART (1984 - 1984)
- VESPA PXE ARCOBALENO (1981 - 1997)

R.O. 17761



100200380 **NEW**



Diametro interno 17 mm | *Internal diameter 17 mm*

Diametro esterno 40 mm | *Outer diameter 40 mm*

Altezza 12 mm | *Height 12 mm*



CUSCINETTI A SFERE - BALL BEARINGS

100200950 **NEW**

Diametro interno 25 mm | *Internal diameter*
25 mm

Diametro esterno 47 mm | *Outer diameter*
47 mm

Altezza 12 mm | *Height* 12 mm



CUSCINETTO RULLI - ROLLER BEARINGS

100190030 **NEW**

Cuscinetto albero motore | *Crankshaft*
bearings

Diametro interno 25 mm | *Internal diameter*
25 mm

Diametro esterno 52 mm | *Outer diameter*
52 mm

Altezza 15 mm | *Height* 15 mm

- VESPA PX T5 125 (1985 - 1989)
- VESPA RALLY 200 (1972 - 1979)
- VESPA GS 160 (1962 - 1964)
- VESPA RALLY 180 (1968 - 1972)

R.O. 23572





TENUTA

TIGHT SYSTEM



100692050 **NEW** 

ARTEIN
gaskets

Foglio Guarnizione | *Gasket sheet*
Dimensioni 300x450mm | *Dimension*
300x450mm
Spessore 0.30 mm | *Thickness 0.30 mm*



100692060 **NEW** 

ARTEIN
gaskets

Foglio Guarnizione | *Gasket sheet*
Dimensioni 300x450mm | *Dimension*
300x450mm
Spessore 0.40 mm | *Thickness 0.40 mm*

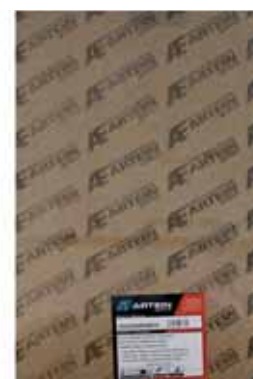

100692070 **NEW** 

ARTEIN
gaskets

Foglio Guarnizione | *Gasket sheet*
Dimensioni 300x450mm | *Dimension*
300x450mm
Spessore 0.50 mm | *Thickness 0.50 mm*



100692080 **NEW** 

ARTEIN
gaskets

Foglio Guarnizione | *Gasket sheet*
Dimensioni 300x450mm | *Dimension*
300x450mm
Spessore 0.80 mm | *Thickness 0.80 mm*



GUARNIZIONI - GASKETS**121831260****NEW**Guarnizione Clacson | *Horn gasket*Colore Grigio | *Colour Grey*Diametro esterno 77 mm | *Outer diameter*
77 mmDiametro interno 54 mm | *Internal diameter*
54 mmKit Clacson | *Kit Klaxon*Numero fori Sei | *Number of holes Six*Spessore 4 mm | *Thickness 4 mm*

- VESPA 50 SPECIAL (1975 - 1983)
- VESPA ET3 125 (1976 - 1983)
- VESPA 50 SPECIAL (1972 - 1975)
- VESPA 50 SPECIAL (1970 - 1972)

R.O. 17409

**121831270****NEW**Guarnizione Clacson | *Horn gasket*Colore Grigio | *Colour Grey*Diametro esterno 73 mm | *Outer diameter*
73 mmDiametro interno 50 mm | *Internal diameter*
50 mmKit Clacson | *Kit Klaxon*Numero fori Quattro | *Number of holes Four*Spessore 4 mm | *Thickness 4 mm*

- VESPA 150 VBB (1960 - 1962)
- VESPA 125 VNB3T (1961 - 1962)
- VESPA 125 VNB6T (1965 - 1966)
- VESPA 125 (1965 - 1966)
- VESPA 125 (1963 - 1963)

R.O. 7061



GUARNIZIONI - GASKETS

121831280

NEW



Guarnizione Clacson | *Horn gasket*

Colore Grigio | *Colour Grey*

Diametro esterno 71 mm | *Outer diameter*
71 mm

Diametro interno 50 mm | *Internal diameter*
50 mm

Kit Clacson | *Kit Klaxon*

Numero fori Quattro | *Number of holes Four*

Spessore 2 mm | *Thickness 2 mm*

• VESPA 125 (1958 - 1959)

• VESPA 125 (1951 - 1951)

R.O. 00303



KIT PARAOLI - OIL SEALS KIT

100640280

NEW



CORTECO

Colore Blu | *Colour Blue*

• VESPA 50 SPECIAL (1975 - 1983)

• VESPA ET3 125 (1976 - 1983)

• VESPA PRIMAVERA 125 (1967 - 1983)

• VESPA PK 50 S (1982 - 1982)



100640285

NEW



CORTECO

Colore Blu | *Colour Blue*

Materiale Viton | *Material*

• VESPA 50 SPECIAL (1975 - 1983)

• VESPA ET3 125 (1976 - 1983)

• VESPA PRIMAVERA 125 (1967 - 1983)

• VESPA PK 50 S (1982 - 1982)



100640290

NEW



CORTECO

Colore Blu | *Colour Blue*

• VESPA PK XL 50 (1985 - 1988)

• VESPA PK 50 XL RUSH (1988 - 1989)

• VESPA PK XL RUSH (1988 - 1989)

• VESPA PK 50 XL ELESTART (1986 - 1986)

• VESPA PK 50 XLS (1986 - 1986)



KIT PARAOLI - OIL SEALS KIT**100640295 NEW****CORTECO**Materiale Viton | *Material*

- VESPA PK XL 50 (1985 - 1988)
- VESPA PK 50 XL RUSH (1988 - 1989)
- VESPA PK XL RUSH 50 (1988 - 1989)
- VESPA PK 50 XL ELESTART (1986 - 1986)
- VESPA PK 50 XLS (1986 - 1986)

**100640300 NEW****CORTECO**Colore Blu | *Colour Blue*

- VESPA PK 125 S (1982 - 1985)
- VESPA PK 125 S (1982 - 1982)
- VESPA PK 125 ETS (1984 - 1984)
- VESPA PK 125 (1982 - 1989)
- VESPA PK 125 ETS ELESTART (1984 - 1984)

**100640310 NEW****CORTECO**Colore Blu | *Colour Blue*

- VESPA PX 80 E (1981 - 1997)
- VESPA PX 125 E ARCOBALENO (1983 - 1983)
- VESPA PX 150 E ELESTART (1984 - 1984)
- VESPA PX 150 E (1981 - 1981)
- VESPA PX 125 E ELESTART (1984 - 1984)

**100640315 NEW****CORTECO**Colore Blu | *Colour Blue*Materiale Viton | *Material*

- VESPA PX 80 E (1981 - 1997)
- VESPA PX 125 E ARCOBALENO (1983 - 1983)
- VESPA PX 150 E ELESTART (1984 - 1984)
- VESPA PX 150 E (1981 - 1981)
- VESPA PX 125 E ELESTART (1984 - 1984)



100640320 **NEW**



CORTECO

Colore Blu | Colour Blue

- VESPA PX 200 E (1977 - 1982)
- VESPA PX 200 E (1983 - 1983)
- VESPA PX 200 E (1982 - 1982)
- VESPA PX 200 E FRENO A DISCO (1998 - 2001)
- VESPA PX 200 E (1981 - 1997)



100640325 **NEW**



CORTECO

Colore Blu | Colour Blue

Materiale Viton | Material Viton

- VESPA PX 200 E (1977 - 1982)
- VESPA PX 200 E (1983 - 1983)
- VESPA PX 200 E (1982 - 1982)
- VESPA PX 200 E FRENO A DISCO (1998 - 2001)
- VESPA PX 200 E (1981 - 1997)



100640330 **NEW**



CORTECO

Colore Blu | Colour Blue

- VESPA PX 125 T5 125 (1985 - 1985)
- VESPA PX 125 T5 ELESTART 125 (1986 - 1986)
- VESPA PX T5 125 (1985 - 1989)



100640335 **NEW**



CORTECO

Colore Blu | Colour Blue

Materiale Viton | Material Viton

- VESPA PX 125 T5 (1985 - 1985)
- VESPA PX 125 T5 ELESTART (1986 - 1986)
- VESPA PX T5 125 (1985 - 1989)



KIT PARAOLI - OIL SEALS KIT**100640340 NEW****CORTECO**Colore Blu | *Colour Blue*

• VESPA RALLY 180

**100640350 NEW****CORTECO**Colore Blu | *Colour Blue*

• VESPA RALLY 200 (1972 - 1979)

**100640380 NEW****CORTECO**Colore Blu | *Colour Blue*

- VESPA SUPER 150 (1965 - 1979)
- VESPA SPRINT 150 (1965 - 1966)
- VESPA 125 VNB6T (1965 - 1966)
- VESPA 125 VNB3T (1961 - 1962)
- VESPA 125 VNB4T (1963 - 1963)

**O-RING - O-RINGS****100706281 NEW**Materiale Gomma | *Material Rubber*Confezione 10 | *Pack 10 Pieces*

- VESPA 50 SPECIAL (1975 - 1983)
- VESPA 50 SPECIAL (1975 - 1983)
- VESPA ET3 125 (1976 - 1983)

R.O. 150579



100706282 **NEW**



Diametro interno 28 mm | *Internal diameter*

28 mm

Diametro esterno 34 mm | *Outer diameter*

34 mm

Spessore 2.5 mm | *Thickness 2.5 mm*

Confezione 10 | *Pack 10 Pieces*

• VESPA 50 SPECIAL (1975 - 1983)

• VESPA 50 SPECIAL (1975 - 1983)

• VESPA ET3 125 (1976 - 1983)

R.O. 93188



ACCESSORI

ACCESSORIES



142800140 **NEW**



FACO



Punto di installazione Posteriore | *Mounting location Rear*

Colore Nero | *Colour Black*

Finitura: verniciato verniciato | *Finishing: Painted Painted*

- VESPA PX 80 E (1981 - 1997)
- VESPA PX 125 E ARCOBALENO (1983 - 1983)
- VESPA PX 150 E ELESTART (1984 - 1984)
- VESPA PX 150 E (1981 - 1981)
- VESPA P 125 X (1977 - 1982)



142800002 **NEW**



Punto di installazione Anteriore | *Mounting location Front*

Colore Nero | *Colour Black*

- VESPA 50 (1967 - 1982)
- VESPA PX 80 E (1981 - 1997)
- VESPA PX 125 E ARCOBALENO (1983 - 1983)
- VESPA PX 150 E ELESTART (1984 - 1984)
- VESPA PX 150 E (1981 - 1981)



142800003 **NEW**



Punto di installazione Anteriore/Posteriore | *Mounting location Front/Rear*

Colore Argento | *Colour Silver*

- VESPA PX 80 E (1981 - 1997)
- VESPA 50 (1967 - 1982)
- VESPA PX 125 E ARCOBALENO (1983 - 1983)
- VESPA PX 150 E ELESTART (1984 - 1984)
- VESPA PX 150 E (1981 - 1981)



PORTAPACCHI - CARRIERS

142800004 **NEW**

Punto di installazione Anteriore | *Mounting location Front*

Colore Nero | *Colour Black*

- VESPA PX 80 E (1981 - 1997)
- VESPA 50 (1967 - 1982)
- VESPA PX 125 E ARCOBALENO (1983 - 1983)
- VESPA PX 150 E ELESTART (1984 - 1984)
- VESPA PX 150 E (1981 - 1981)

142800005 **NEW**

Punto di installazione Anteriore | *Mounting location Front*

Colore Nero | *Colour Black*

- VESPA PX 80 E (1981 - 1997)
- VESPA 50 (1967 - 1982)
- VESPA PX 125 E ARCOBALENO (1983 - 1983)
- VESPA PX 150 E ELESTART (1984 - 1984)
- VESPA PX 150 E (1981 - 1981)





OFFICINA

WORKSHOP

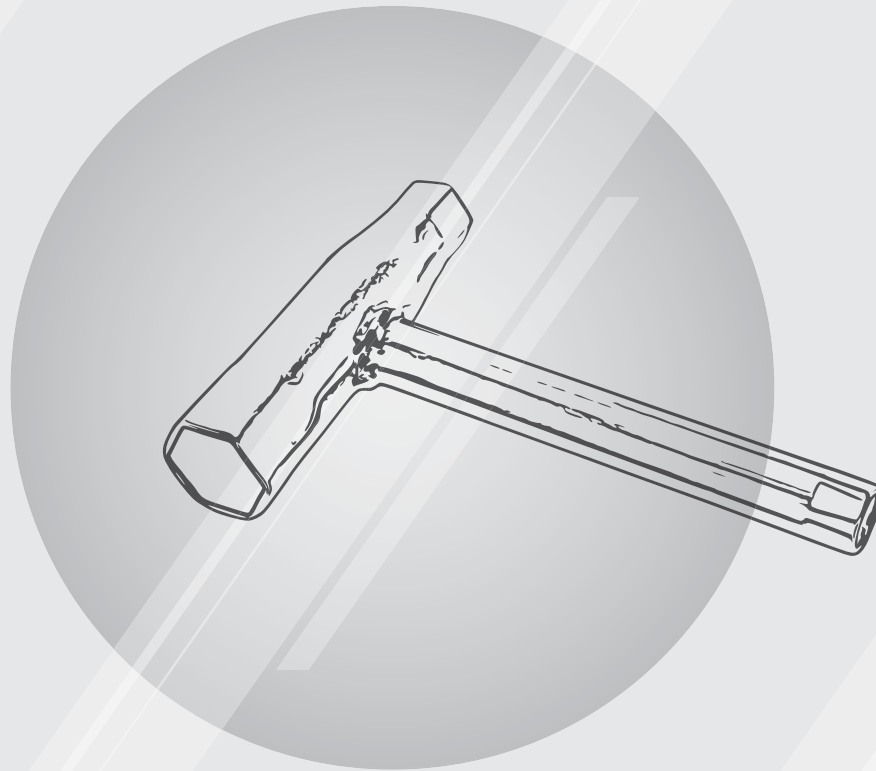

ATTREZZI E UTENSILI - TOOLS

246365004 **NEW**



EVOX



Disco graduato per accensione elettronica
| Ignition timing degree disc for ignition
adjustment

PER TUTTI I MODELLI



MINUTERIA METALLICA - HARDWARE

100220121 **NEW**



Anello seger albero cambio | Cluster circlip
bearing driveshaft

Confezione 50 | Pack 50 Pieces

Diametro 25 mm | Diameter 25 mm

- VESPA 50 SPECIAL (1975 - 1983)
- VESPA ET3 125 (1976 - 1983)
- VESPA PRIMAVERA 125 (1967 - 1983)
- VESPA PK 50 S (1982 - 1982)
- VESPA 50 SPECIAL (1972 - 1975)

R.O. 006625



100220122 **NEW**



Anello seger albero cambio | Cluster circlip
bearing driveshaft

Confezione 50 | Pack 50 Pieces

Diametro 47 mm | Diameter 47 mm

- VESPA 50 SPECIAL (1975 - 1983)
- VESPA ET3 125 (1976 - 1983)
- VESPA PRIMAVERA 125 (1967 - 1983)
- VESPA PK 50 S (1982 - 1982)
- VESPA 50 SPECIAL (1972 - 1975)

R.O. 006647



MINUTERIA METALLICA - HARDWARE

100220123 **NEW**

Anello seger albero cambio | *Cluster circlip
bearing driveshaft*

Confezione 50 | *Pack 50 Pieces*

Diametro 44.5 mm | *Diameter 44.5 mm*

- VESPA 50 SPECIAL (1975 - 1983)
- VESPA ET3 125 (1976 - 1983)
- VESPA PRIMAVERA 125 (1967 - 1983)
- VESPA PK 50 S (1982 - 1982)
- VESPA 50 SPECIAL (1972 - 1975)

R.O. 005901

121530314 **NEW**

Chiodino pedale freno | *Brake pedal securing
pin*

Confezione 100 | *Pack 100 Pieces*

- VESPA SUPER 150 (1965 - 1979)
- VESPA 150 VBB (1960 - 1962)
- VESPA 125 VNB3T (1961 - 1962)
- VESPA 125 VNB6T (1965 - 1966)
- VESPA 125 VNB5T (1964 - 1964)

R.O. S.11502-S.1151

121790183 **NEW**

Rivetti copri serratura bloccasterzo | *Rivet
steering lock cover*

Confezione 100 | *Pack 100 Pieces*

Diametro 3 mm | *Diameter 3 mm*

Lunghezza 10 mm | *Lenght 10 mm*

- VESPA ET3 125 (1976 - 1983)
- VESPA PRIMAVERA 125 (1967 - 1983)
- VESPA 50 R (1969 - 1971)
- VESPA 50 SPECIAL (1970 - 1972)

R.O. 15209



121790191

NEW



Rivetti copri serratura bloccasterzo | *Rivet steering lock cover*

Confezione 100 | *Pack 100 Pieces*

Diametro 2.2 mm | *Diameter 2.2 mm*

Lunghezza 13 mm | *Lenght 13 mm*

- VESPA 50 SPECIAL (1975 - 1983)
 - VESPA 50 (1967 - 1982)
 - VESPA P 125 X (1977 - 1982)
 - VESPA P 125 X (1979 - 1983)
 - VESPA PX 80 E ARCOBALENO (1983 - 1983)
- R.O. 17462



121810251

NEW



Ribattino per puntali striscia pedana | *Rivet for fixing footboard strips*

Confezione 100 | *Pack 100 Pieces*

Diametro 3.5 mm | *Diameter 3.5 mm*

Lunghezza 23 mm | *Lenght 23 mm*

Materiale Alluminio | *Material Aluminium*

- VESPA 50 SPECIAL (1975 - 1983)
- VESPA ET3 125 (1976 - 1983)
- VESPA PRIMAVERA 125 (1967 - 1983)
- VESPA 50 SPECIAL (1970 - 1972)



121810252

NEW



Ribattino per striscia pedana | *Rivet for fixing footboard strips*

Confezione 100 | *Pack 100 Pieces*

Diametro 3 mm | *Diameter 3 mm*

Lunghezza 10 mm | *Lenght 10 mm*

- VESPA 50 SPECIAL (1975 - 1983)
- VESPA ET3 125 (1976 - 1983)
- VESPA PRIMAVERA 125 (1967 - 1983)
- VESPA 50 SPECIAL (1972 - 1975)



MINUTERIA METALLICA - HARDWARE

121680144

NEW



Confezione 20 | Pack 20 Pieces

- VESPA 50 SPECIAL 50 (1975 - 1983)
- VESPA ET3 125 (1976 - 1983)
- VESPA PRIMAVERA 125 125 (1967 - 1983)
- VESPA PK 50 S 50 (1982 - 1982)
- VESPA PX 80 E (1981 - 1997)
- VESPA PX 125
- VESPA PX 150

R.O. 015467



121850369

NEW



Rondella vite fissaggio conta Km | Washer
screw speedometer

Confezione 50 | Pack 50 Pieces

Diametro esterno 15 mm | Outer diameter
15 mm

Diametro interno 5.3 mm | Internal diameter
5.3 mm

Filetto M5 | Thread M5

Finitura Zincato | Finishing Galvanised

Spessore 1 mm | Thickness 1 mm

- VESPA 50 SPECIAL (1975 - 1983)
- VESPA ET3 125 (1976 - 1983)
- VESPA PRIMAVERA 125 (1967 - 1983)
- VESPA PK 50 S (1982 - 1982)
- VESPA 50 SPECIAL (1972 - 1975)

R.O. 00305



121850371

NEW



Kit fissaggio parafrangente | Mounting kit for
fender

Diametro 13 mm | Diameter 13 mm

Filettatura 5 mm | Thread 5 mm

Testa vite Taglio | Screw Head Slotted

- VESPA 50 SPECIAL (1975 - 1983)
- VESPA ET3 125 (1976 - 1983)
- VESPA PRIMAVERA 125 (1967 - 1983)
- VESPA PK 50 S (1982 - 1982)
- VESPA 50 SPECIAL (1970 - 1972)



121858435 **NEW**



Chiavetta perno ingranaggio multiplo |

Woodruff key input shaft

Materiale Acciaio | *Material Steel*

Colore Grigio | *Colour Grey*

Confezione 50 | *Pack 50 Pieces*

Altezza 3 mm | *Height 3 mm*

Larghezza 3 mm | *width 3 mm*

Lunghezza 7 mm | *Lenght 7 mm*

- VESPA 50 SPECIAL (1975 - 1983)
- VESPA ET3 125 (1976 - 1983)
- VESPA PRIMAVERA 125 (1967 - 1983)
- VESPA PK 50 S (1982 - 1982)

R.O. 01175



121858512 **NEW**



Rondella distanziale tubo comando cambio e
manubrio | *Gear tube and handlebar spacer*

Confezione 10 | *Pack 10 Pieces*

Diametro esterno 41.5 mm | *Outer diameter
41.5 mm*

Diametro interno 32 mm | *Internal diameter
32 mm*

Spessore 1 mm | *Thickness 1 mm*

- VESPA 50 SPECIAL (1975 - 1983)
- VESPA ET3 125 (1976 - 1983)
- VESPA PRIMAVERA 125 (1967 - 1983)
- VESPA PK 50 S (1982 - 1982)
- VESPA 50 SPECIAL (1972 - 1975)

R.O. 070858-02029



MINUTERIA METALLICA - HARDWARE

121858513

NEW



Rondella distanziale tubo comando cambio e
acceleratore | *Gear tube and throttle spacer*

Confezione 10 | *Pack 10 Pieces*

Diametro esterno 31 mm | *Outer diameter*
31 mm

Diametro interno 24 mm | *Internal diameter*
24 mm

Spessore 1 mm | *Thickness 1 mm*

- VESPA 50 SPECIAL (1975 - 1983)
- VESPA ET3 125 (1976 - 1983)
- VESPA PRIMAVERA 125 (1967 - 1983)
- VESPA PK 50 S (1982 - 1982)
- VESPA 50 SPECIAL (1972 - 1975)

R.O. 10147



121858881

NEW



Dado cerchio | *Rim nut*

Altezza 6.4 mm | *Height 6.4 mm*

Chiave 11 mm | *AF 11 mm*

Confezione 100 | *Pack 100 Pieces*

Filetto M8 | *Thread M8*

Finitura Zincato | *Finishing Galvanised*

Materiale Acciaio | *Material Steel*

- VESPA SUPER 150 (1965 - 1979)
- VESPA 150 VBB (1960 - 1962)
- VESPA 125 (1958 - 1958)
- VESPA 125 (1965 - 1966)
- VESPA 125 VNB3T (1961 - 1962)

R.O. 012011001



121859226 **NEW**



Rondella ondulata per selettore marce | *Shim selector arm*

Confezione 10 | *Pack 10 Pieces*

Diametro esterno 12.8 mm | *Outer diameter 12.8 mm*

Diametro interno 7.4 mm | *Internal diameter 7.4 mm*

Filetto M7 | *Thread M7*

Finitura Zincato | *Finishing Galvanised*

Materiale Acciaio | *Material Steel*

Spessore 1 mm | *Thickness 1 mm*

- VESPA 50 SPECIAL (1975 - 1983)
- VESPA PRIMAVERA 125 (1967 - 1983)
- VESPA PK 50 S (1982 - 1982)
- VESPA 50 SPECIAL (1972 - 1975)
- VESPA 50 SPECIAL (1970 - 1972)

R.O. 078597



121859229 **NEW**



Rondella parker per ventola di raffreddamento | *Lock washer fanwheel*

Confezione 10 | *Pack 10 Pieces*

Diametro esterno 20 mm | *Outer diameter 20 mm*

Diametro interno 13 mm | *Internal diameter 13 mm*

Filetto M12 | *Thread M12*

Finitura Zincato | *Finishing Galvanised*

Materiale Acciaio | *Material Steel*

R.O. 012555



121859257 **NEW**



Vite ammortizzatore e carter | *Shock absorber and crankcase screw*

Filetto M9 | *Thread M9*

Lunghezza 65 mm | *Lenght 65 mm*

- VESPA ET3 125 (1976 - 1983)
- VESPA PRIMAVERA 125 (1967 - 1983)
- VESPA PRIMAVERA 125 (1963 - 1966)
- VESPA PK 50 (1982 - 1984)

R.O. 014689-1226



MINUTERIA METALLICA - HARDWARE

121858631 **NEW**

Vite ammortizzatore e carter | *Shock absorber and crankcase screw*

Filetto M9 | *Thread M9*

Lunghezza 65 mm | *Lenght 65 mm*

- VESPA ET3 125 (1976 - 1983)
- VESPA PRIMAVERA 125 (1967 - 1983)
- VESPA PRIMAVERA 125 (1963 - 1966)
- VESPA PK 50 (1982 - 1984)

R.O. 014689-1226

121859261 **NEW**

Vite autofilettante a taglio testa piana svasata | *Selftapping pan head screw*

Confezione 100 | *Pack 100 Pieces*

Diametro 2.9 mm | *Diameter 2.9 mm*

Lunghezza 13 mm | *Lenght 13 mm*

Materiale Acciaio Inox | *Material Stainless steel*

- VESPA ET3 125 (1976 - 1983)
- VESPA SPRINT 150 (1965 - 1966)
- VESPA P 125 X (1977 - 1979)
- VESPA P 150 S (1978 - 1984)
- VESPA P 150 X (1977 - 1979)

121859262 **NEW**

Vite autofilettante a croce svasata | *Stainless steel cylindrical cross head self-tapping screw*

Confezione 100 | *Pack 100 Pieces*

Diametro 2.9 mm | *Diameter 2.9 mm*

Lunghezza 13 mm | *Lenght 13 mm*

Materiale Acciaio Inox | *Material Stainless steel*

- VESPA ET3 125 (1976 - 1983)
- VESPA SPRINT 150 (1965 - 1966)
- VESPA P 125 X (1977 - 1979)
- VESPA P 150 X (1977 - 1979)
- VESPA P 150 S (1978 - 1984)



121860050 **NEW**



Dado M9 | *M9 Nut*

Confezione 10 | *Pack 10 Pieces*

Filetto M9 | *Thread M9*

- VESPA ET3 125 (1976 - 1983)
- VESPA PRIMAVERA 125 (1967 - 1983)
- VESPA PRIMAVERA 125 (1963 - 1966)
- VESPA 50 (1967 - 1982)

R.O. 02010



121860060 **NEW**



Confezione 100 | *Pack 100 Pieces*

Diametro 9 mm | *Diameter 9 mm*

- VESPA ET3 125 (1976 - 1983)
- VESPA PRIMAVERA 125 (1967 - 1983)
- VESPA PRIMAVERA 125 (1963 - 1966)
- VESPA PK 50 (1982 - 1984)



121860331 **NEW**



Altezza 6 mm | *Height 6 mm*

Chiave 19 mm | *AF 19 mm*

Confezione 10 | *Pack 10 Pieces*

Filetto M12 X 1,5mm | *Thread*

Finitura Zincato | *Finishing Galvanised*

Materiale Acciaio | *Material Steel*

- VESPA 50 SPECIAL (1975 - 1983)
- VESPA ET3 125 (1976 - 1983)
- VESPA PRIMAVERA 125 (1967 - 1983)
- VESPA PK 50 S (1982 - 1982)

R.O. 00151



MINUTERIA METALLICA - HARDWARE

121860332 **NEW**



Altezza 5 mm | Height 5 mm
 Chiave 17 mm | AF 17 mm
 Confezione 10 | Pack 10 Pieces
 Filetto M10 X 1,5 mm | Thread
 Finitura Zincato | Finishing Galvanised
 Materiale Acciaio | Material Steel

- VESPA 50 SPECIAL (1975 - 1983)
- VESPA ET3 125 (1976 - 1983)
- VESPA PRIMAVERA 125 (1967 - 1983)
- VESPA PK 50 S (1982 - 1982)

R.O. 00150



121860341 **NEW**



Dado per cerchione | Rim nut
 Altezza 15 mm | Height 15 mm
 Altezza asta 8 mm | Shaft height 8 mm
 Altezza spallamento 7 mm | Collar height 7 mm
 Chiave 22 mm | AF 22 mm
 Confezione 20 | Pack 20 Pieces
 Filetto M8 | Thread M8
 Finitura Cromato | Finishing Chromed
 Materiale Acciaio | Material Steel

- VESPA SUPER 150 (1965 - 1979)
- VESPA 150 VBB (1960 - 1962)
- VESPA 125 (1958 - 1958)
- VESPA 125 VNB6T (1965 - 1966)
- VESPA 125 VNB3T (1961 - 1962)

R.O. 00244



121890091 **NEW**



Gancio per molla cavalletto | Dies mounting
 spring main stand
 PER TUTTI I MODELLI
 R.O. 077252-667782



142720849 **NEW**



Microribattino per targhette | *Rivet for badge*

Diametro 1.5 mm | *Diameter 1.5 mm*

Lunghezza 3 mm | *Length 3 mm*

- VESPA SUPER 150 (1965 - 1979)
- VESPA 150 VBB (1960 - 1962)
- VESPA 125 (1958 - 1958)
- VESPA 125 (1965 - 1966)
- VESPA 125 VNB6T (1965 - 1966)



163690091 **NEW**



Vite per ingranaggio conta km | *Speedometer screw drive gear*

MODELLI SMALL FRAME

R.O. 057935



A P E

121	ASPIRAZIONE	INTAKE SYSTEM	SISTEMA DE ADMISION	SYSTÈME D'ADMISSION
123	MOTORE	ENGINE	MOTOR	MOTEUR
125	SCARICO	EXHAUST SYSTEM	SISTEMA DE ESCAPE	SYSTÈME D'ÉCHAPPEMENT
127	IMPIANTO FRENANTE	BRAKING SYSTEM	SISTEMA DE FRENADOS	SYSTÈME DE FREINAGE
129	IMPIANTO ELETTRICO	ELECTRICAL SYSTEM	INSTALACION ELECTRICA	SYSTÈME ÉLECTRIQUE





ASPIRAZIONE

INTAKE SYSTEM

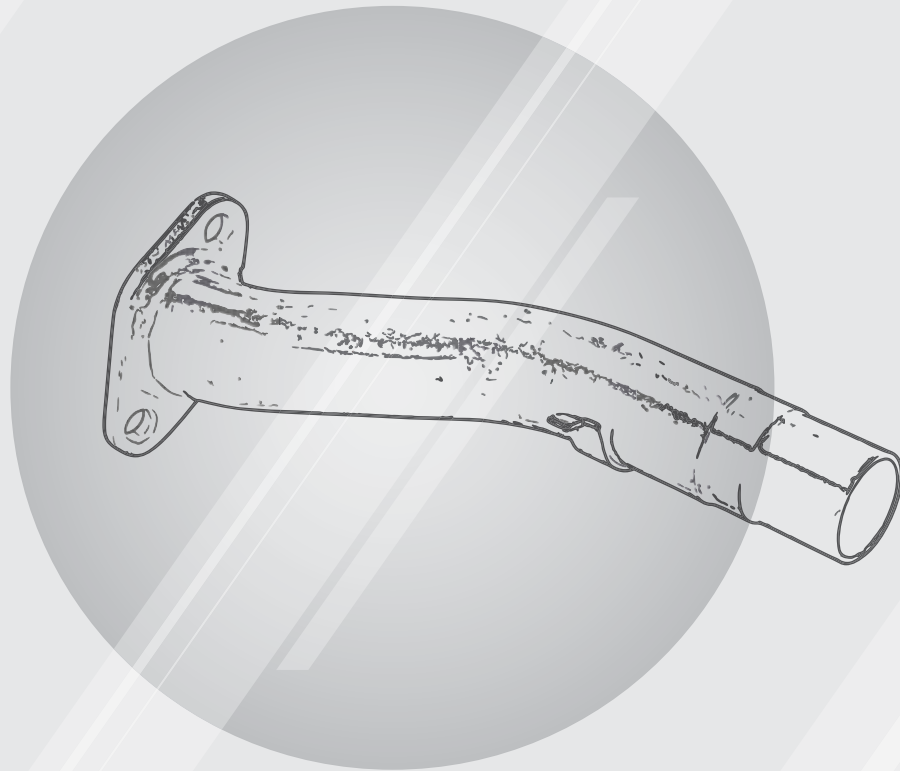

100600620 **NEW****UFI**Materiale Carta | *Material Paper*Utilizzo Road | *Use Road*

- APE CAR P2-P3 220 (1978 - 1985)
- APE TM P602 220 (1982 - 1983)
- APE TM P703 FL2 220 (1999 - 2007)
- APE MP P501-P601 220 (1978 - 1996)
- APE TM P703-P703V 220 (1984 - 2005)

R.O. 43801

100600631 **NEW****NYPSO**Materiale Carta | *Material Paper*Utilizzo Road | *Use Road*

- APE TM 703 420

R.O. 230414

100600640 **NEW****UFI**Materiale Carta | *Material Paper*Utilizzo Road | *Use Road*

- APE POKER BENZINA 420 (1993 - 1993)

R.O. 25499



MOTORE

ENGINE

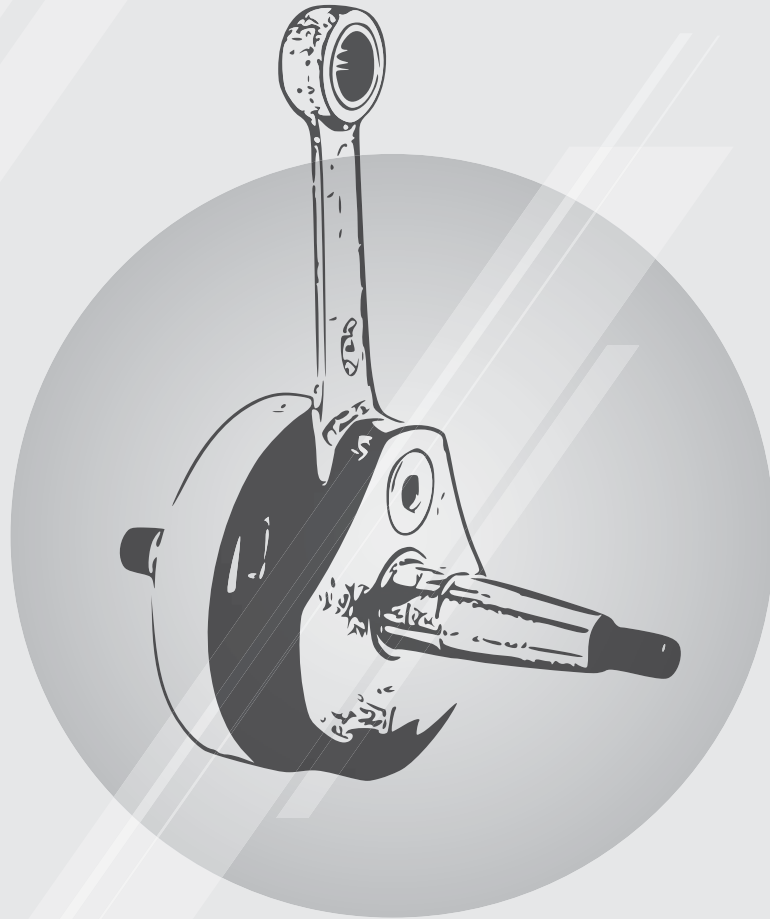

100080182 **NEW**

Tipologia Standard | *Type Standard*
Materiale Ghisa | *Material Cast iron*
Cilindrata 220 cc | *Displacement 220 cc*
Raffreddamento Aria | *Cooling Air*
Alesaggio 68 mm | *Bore 68 mm*
Corsa 60 mm | *Stroke 60 mm*

- APE CAR P2-P3 220 (1978 - 1985)
- APE TM P602 220 (1982 - 1983)
- APE TM P703 FL2 220 (1999 - 2007)
- APE MP P501-P601 220 (1978 - 1996)
- APE TM P703-P703V 220 (1984 - 2005)

R.O. 832349-828864



SCARICO

EXHAUST SYSTEM



100751280 **NEW**



- APE CAR P2-P3 220 (1978 - 1985)
 - APE TM P602 220 (1982 - 1983)
 - APE TM P703 FL2 220 (1999 - 2007)
 - APE MP P501-P601 220 (1978 - 1996)
 - APE CAR P2-VESPA CAR P2-APE CAR P3 220 (1972 - 1986)
- R.O. 24289



IMPIANTO FRENANTE

BRAKING SYSTEM

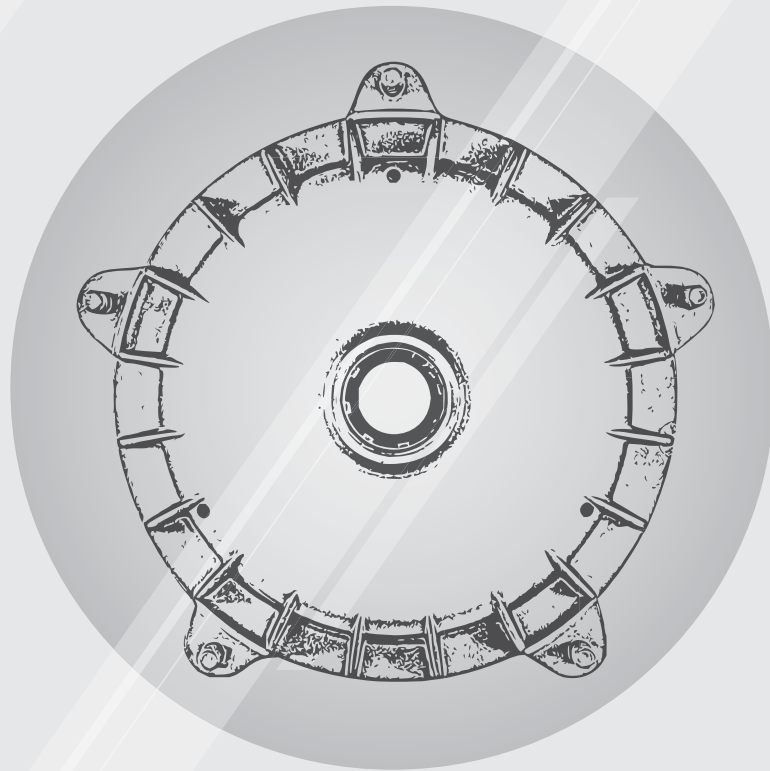

TAMBURI FRENO - BRAKE DRUMS

225088001 **NEW**Posizione Posteriore | *Installation point Rear*

- APE 50 (2009 - 2017)
 - APE 50 (2011 - 2017)
 - APE 50 (1969 - 1975)
 - APE 50 (2009 - 2011)
 - APE 50 (2009 - 2016)
- R.O. 11644



IMPIANTO ELETTRICO

ELECTRICAL SYSTEM

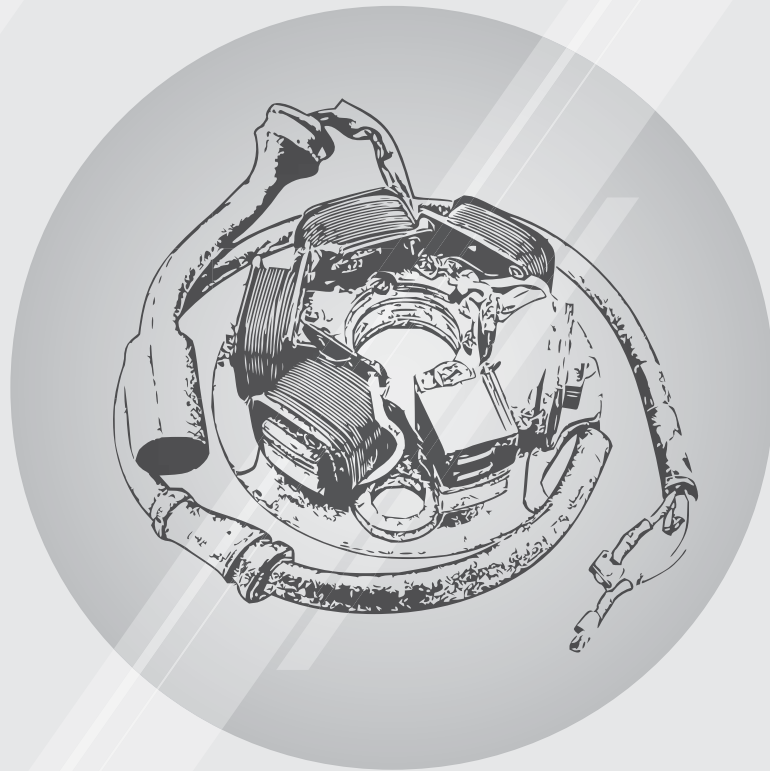

246110010

NEW



- APE FL - FL2 50 (1989 - 1995)
 - APE FL3 EUROPA 50 (1996 - 1999)
 - APE 50 (2009 - 2017)
 - APE MIX 2T 50 (1998 - 2008)
 - APE RST MIX 50 (1999 - 2003)
- R.O. 290682



CICLOMOTORE-MOPED

133	ALIMENTAZIONE	FUEL SYSTEM	SISTEMA DE COMBUSTIBLE	SYSTÈME D'ALIMENTATION
135	IMPIANTO ELETTRICO	ELECTRICAL SYSTEM	INSTALACION ELECTRICA	SYSTÈME ÉLECTRIQUE
137	TRASMISSIONE	TRANSMISSION	TRANSMISIÓN	TRANSMISSION
139	CARROZZERIA	BODY WORK	CARROCERIA	CARROSSERIE
143	TELAIO	CHASSIS	CHASIS	CHASSIS
147	GOMME	TIRES	NEUMATICOS	PNEUS
149	OFFICINA	WORKSHOP	TALLER	ATELIER





ALIMENTAZIONE

FUEL SYSTEM

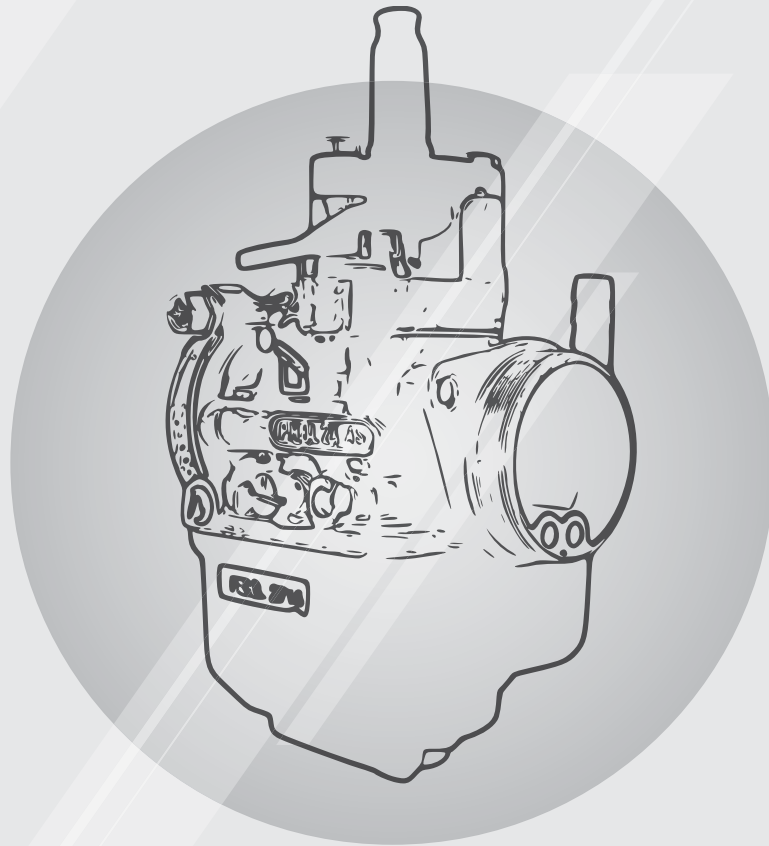

CICLOMOTORE - MOPED

SERBATOI BENZINA E ACCESSORI - FUEL TANKS AND ACCESSORIES

121650150

NEW



Tappo serbatoio | Tank plug

- CIAO 50 (1980 - 1988)
- APE P 50 (1980 - 1985)
- APE FL - FL2 50 (1989 - 1995)
- APE FL3 EUROPA 50 (1996 - 1999)
- APE TM P 50 (1985 - 1989)

R.O. 270586



ACCESSORI CARBURATORE - CARBURETOR ACCESSORIES

121700002

NEW



DELL'ORTO

Guarnizioni Carburatore SHA1 | Carburetor Gasket SHA1

Codice Dell'Orto 52533



121700081

NEW



DELL'ORTO

Filtro Carburatore SHA | Carburetor filter SHA

Materiale Alluminio | Material Aluminium

Utilizzo Road | Use Road



121700231

NEW



DELL'ORTO

Pipetta SHA | Fuel House connection SHA

Angolo 45° | Corner 45°

Colore Nero | Colour Black

Diametro 6 mm | Diameter 6 mm

Codice Dell'Orto 0924900 38 | Dell'Orto part number 0924900 38



IMPIANTO ELETTRICO

ELECTRICAL SYSTEM

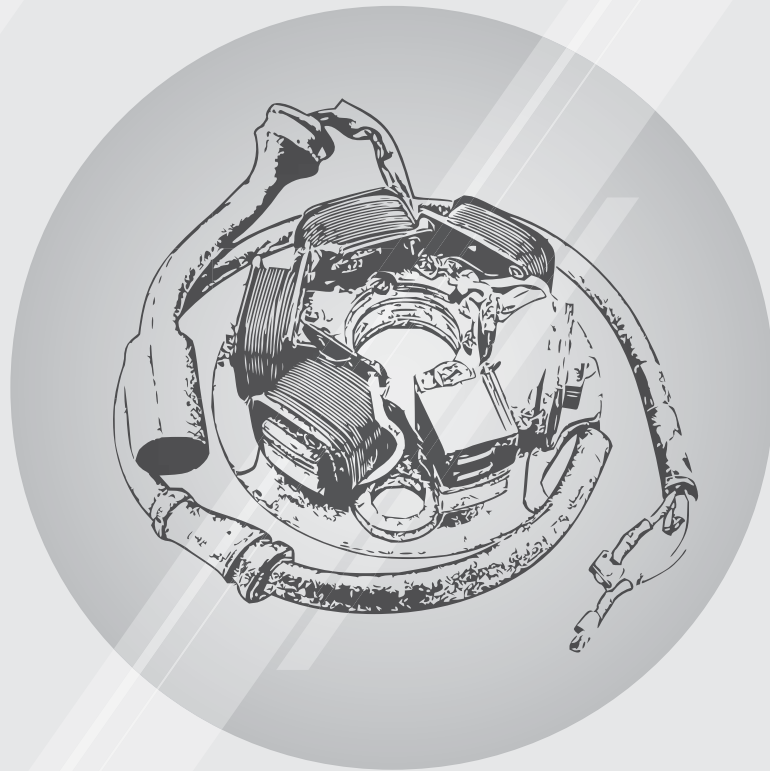

CICLOMOTORE - MOPED

BOBINE - COILS

246010181 **NEW**



Bobina di accensione | *Ignition coil*

- CIAO 50
- SI 50



TRASMISSIONE

TRANSMISSION

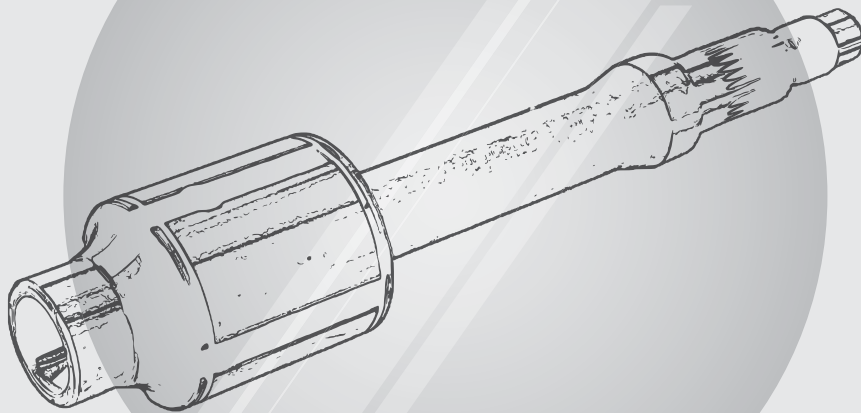

CICLOMOTORE - MOPED

CATENE TRASMISSIONE - TRANSMISSION CHAINS

525240140 **NEW**



Catena di trasmissione | *Transmission chain*

- CIAO 50
- SI 50



ACCESSORI TRASMISSIONE - TRANSMISSION ACCESSORIES

121859195 **NEW**



Dado serraggio gruppo frizione | *Clutch nut*

- CIAO 50
 - SI 50
- R.O. 15229



CARROZZERIA

BODY WORK



CICLOMOTORE - MOPED

PARAFANGHI - MUDGUARDS

142680200 **NEW** 



• CIAO 50 (1980 - 1988)
R.O. 229581



142680210 **NEW** 



• CIAO 50 (1980 - 1988)
R.O. 188095



142680220 **NEW** 



• CIAO 50 (1980 - 1988)
R.O. 229581



142680230 **NEW** 



Paraspruzzo parafango | *Mudguard flap*
• CIAO 50 (1980 - 1988)
R.O. 188095



142680420 **NEW** 



Scatola porta attrezzi | *Tool box*
• SI 50 (1979 - 1988)
• BRAVO ERRE 2 50 (1975 - 1981)
• BRAVO 3 50 (1987 - 1990)
R.O. 26920



PLASTICHE CARROZZERIA - CHASSIS PLASTICS

142560172 **NEW**



Scatola porta attrezzi | *Tool box*
 Materiale Plastica | *Material Plastic*
 Colore Grigio | *Colour Grey*

- CIAO 50 (1980 - 1988)
- CIAO 50 (1971 - 1999)
- CIAO 50 (1971 - 1973)
- SI 50 (1979 - 1988)

R.O. 11043



142680871 **NEW**



Scatola porta attrezzi | *Tool box*
 Materiale Plastica | *Material Plastic*
 Colore Nero | *Colour Black*

- CIAO 50 (1980 - 1988)

R.O. 11043



PLASTICHE CARROZZERIA - CHASSIS PLASTICS

142680920 **NEW**



Fianchetti laterali | *Side cover*
 Materiale Plastica | *Material Plastic*
 Colore Grigio | *Colour Grey*

- CIAO 50 (1971 - 1973)



TARGHETTE - SCUDI - FREGI - NAMEPLATES - BADGES - EMBLEMS

121850010 **NEW**



Mollaetta di fissaggio | *Fixing spring*
 Materiale Acciaio Zincato | *Material Steel zinc plated*

- VESPA 50 50 (1967 - 1982)
- VESPA PK 50 (1982 - 1984)
- VESPA PK XL 50 (1985 - 1988)
- VESPA PK XL 125 (1986 - 1989)
- VESPA PK XL RUSH 50 (1988 - 1989)

R.O. 00810



CICLOMOTORE - MOPED

TARGHETTE - SCUDI - FREGI - NAMEPLATES - BADGES - EMBLEMS

142720040 **NEW**



Materiale Alluminio | *Material Aluminium*

Colore Blu | *Colour Blue*

Dimensioni 26 mm | *Dimensions 26 mm*

Tipo di fissaggio Autoadesivo | *Fixing system*

Sticker

- VESPA SUPER 150 150 (1965 - 1979)
- VESPA ET3 125 (1976 - 1983)
- VESPA PRIMAVERA 125 125 (1967 - 1983)
- VESPA SS 90 90 (1965 - 1971)
- VESPA 50 S 50 (1963 - 1968)

R.O. 15228



TELAIO

CHASSIS



CICLOMOTORE - MOPED

LEVE - LEVERS

184121070

NEW



Colore Nero | *Colour Black*
Materiale Plastica | *Material Plastic*
• CIAO 50 (1980 - 1988)
• APE P 50 (1980 - 1985)
• APE TM P 50 (1985 - 1989)
• SI 50 (1979 - 1988)
• BRAVO ERRE 2 50 (1975 - 1981)
R.O. 17858



KIT CAVI TRASMISSIONE - TRANSMISSION CABLES KITS

16363990

NEW



Cavo trasmissione conta Km | *Speedometer transmission cable*
Colore Nero | *Colour Black*
Lunghezza cavo 835 mm | *Cable length 835 mm*
Lunghezza guaina 805 mm | *Sheat lenght 805 mm*
• CIAO 50 (1980 - 1988)
• CIAO 50 (1971 - 1999)
• CIAO 50 (1971 - 1973)
• CIAO EURO1 50 (1999 - 2001)
• BOXER 50 (1970 - 1972)
R.O. 187423



163631001

NEW



Cavo trasmissione conta Km | *Speedometer transmission cable*
Colore Grigio | *Colour Grey*
Lunghezza cavo 835 mm | *Cable length 835 mm*
Lunghezza guaina 805 mm | *Sheat lenght 805 mm*
• CIAO 50 (1980 - 1988)
• CIAO 50 (1971 - 1999)
• CIAO 50 (1971 - 1973)
• CIAO EURO1 50 (1999 - 2001)
• BOXER 50 (1970 - 1972)
R.O. 187423



PEDALI E PUNTAPIEDI - FOOTRESTS AND PEDALS

421510230

NEW



Utilizzo Urban / City | *Use Urban / City*
Tipologia Pedali Flat | *Pedals Type Flat*
Tipologia tacchette Senza tacchette | *Cleat type Without cleats*

Materiale Composito | *Material Composite*

- CIAO 50 (1980 - 1988)
- CIAO 50 (1971 - 1973)





GOMME

TIRES



CICLOMOTORE - MOPED

GOMME - TIRES

993100001 **NEW**



KENDA

Set pneumatico e camera da 16" (2 X 1/2-16") |
Tyre and tube set 16" (2 X 1/2-16")



OFFICINA

WORKSHOP

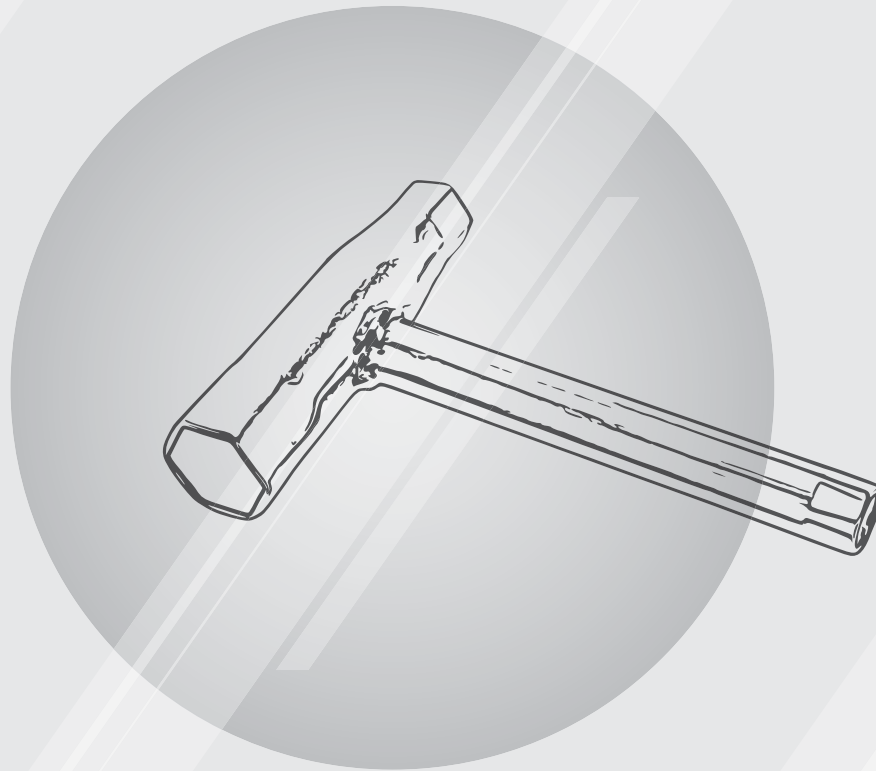

CICLOMOTORE - MOPED

MINUTERIA METALLICA - HARDWARE

100708000 **NEW**



Rondella tappo olio | *oil plug washer*

Materiale Fibra | *Material Textil fiber*

• CIAO

• SI

R.O. 000397



121858530 **NEW**



Rondella albero motore | *Chrankshaft washer*

Materiale Ferro | *Material Iron*

• CIAO 50 (1980 - 1988)

• SI 50 (1979 - 1988)

• GRILLO 50 (1989 - 1993)

• BRAVO ERRE 2 50 (1975 - 1981)

• BRAVO 3 50 (1987 - 1990)

R.O. 10294



121860010 **NEW**



Tappo carico olio | *Oil plug*

Filetto M8 x 10mm | *Thread M8 x 10mm*

Materiale Acciaio Zincato | *Material Steel zinc plated*

• VESPA SUPER 150 150 (1965 - 1979)

• VESPA PX 80 E 80 (1981 - 1997)

• VESPA PX 125 E ARCOBALENO 125 (1983 - 1983)

• VESPA PX 150 E ELESTART 150 (1984 - 1984)

• VESPA PX 150 E 150 (1981 - 1981)

R.O. 03028



121858551 **NEW**



Dado ruota libera | *Rear free wheel nut*

• CIAO 50 (1980 - 1988)

• SI 50 (1979 - 1988)

• GRILLO 50 (1989 - 1993)

• BRAVO ERRE 2 50 (1975 - 1981)



Progetto grafico, coordinamento e soluzioni di impaginazione automatizzata:
Winning Associati S.r.l. / ZERO ONE S.a.s. - Agrate Brianza (MB)

Il presente stampato è a norma delle leggi sul diritto d'autore e del codice civile.
È tassativamente vietata la riproduzione di questo catalogo o di parte di esso, con qualsiasi metodo elettronico, meccanico, per mezzo di fotocopie o altro. I diritti sono riservati per tutti i paesi.
Disegni e dati (descrizioni, caratteristiche, codifiche, ecc.) riportati sul catalogo possono essere soggetti a modifiche e variazioni. RMS S.p.A. si riserva la facoltà di effettuare cambiamenti anche senza preavviso.
Tutti i riferimenti originali sono di proprietà esclusiva delle case produttrici.

As for the copyright laws and the civil code laws, it's forbidden the reproduction of this catalogue/price list or any extract of the same with any electronical,mechanical means. No photocopies are allowed and also any microchips, recording or else. The rights are reserved for all the countries in which we sell. Drawing, data (descriptions, characteristics, codes, price and so on) that are described on price lists and catalogues can be subject to changes and modifications. RMS s.p.a. has the right to change any of these conditions without any advanced notice. All the original references are of exclusive property of the producers.

Per le condizioni generali di vendita consultare il sito www.rms.it

RMS S.p.A.

Via Macallè 156 - 20831 Seregno (MB) - Tel. +39 0362 27301 - Fax +39 0362 2730270
www.rms.it - info@rms.it

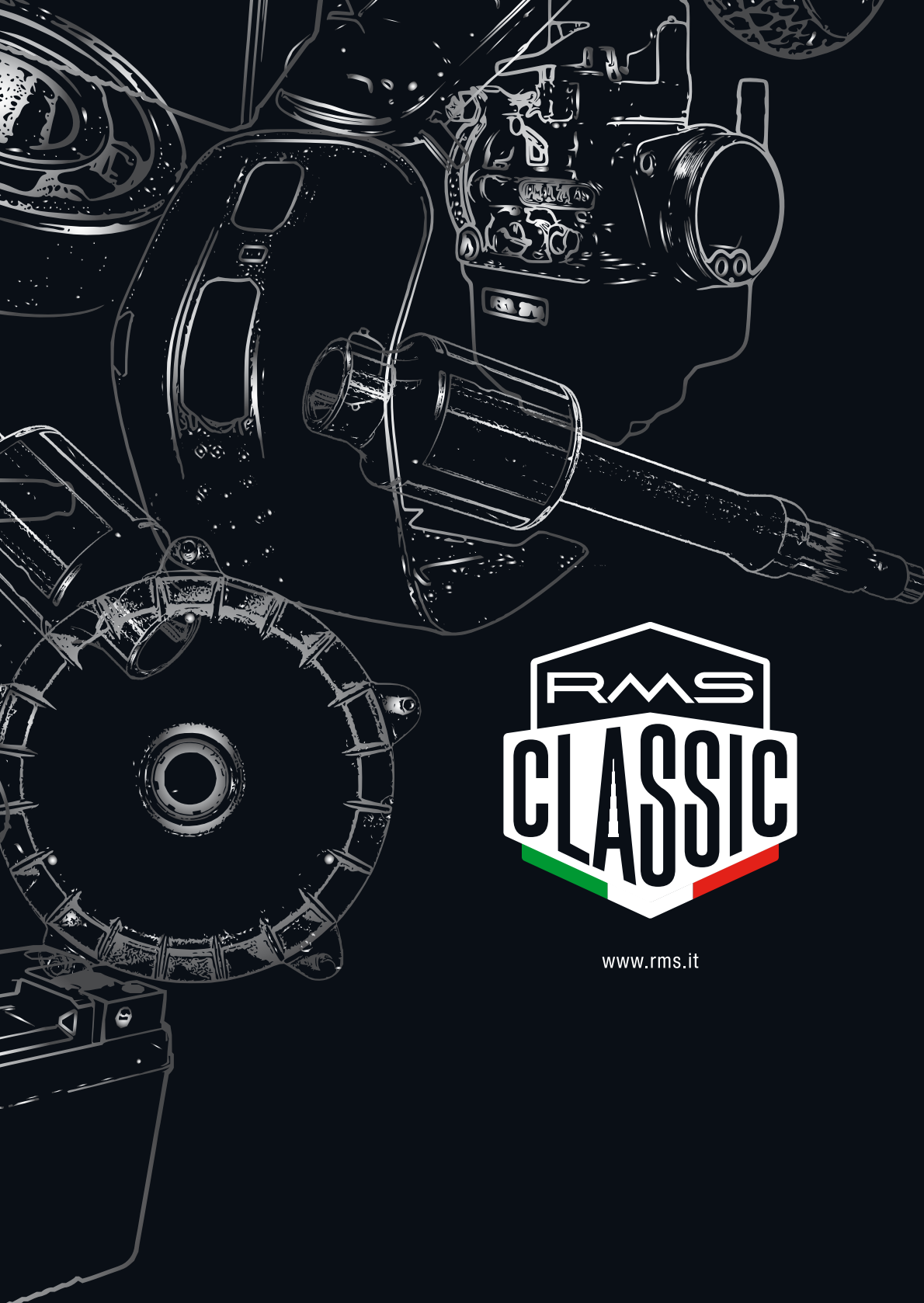

www.rms.it

RMS S.p.A.

Via Macallè 156
20831 Seregno (MB) - Italy
Tel. +39 0362 27301
Fax +39 0362 2730270

SEGUICI SU

