



FERVI

IL CATALOGO

PER I PROFESSIONISTI
DELLA MANUTENZIONE
E RIPARAZIONE

46



MACCHINE UTENSILI E ACCESSORI



UTENSILI DA TAGLIO



ABRASIVI



ATTREZZATURE DA OFFICINA



UTENSILERIA



GENERAL TOOLS



STRUMENTI DI MISURA



- p.004 **TORNI**
- p.064 **MACCHINE LAVORAZIONI MECCANICHE**
- p.103 **MORSE A MACCHINA**
- p.135 **CONTROPUNTE E TORRETTE**
- p.143 **UTENSILI PER TORNITURA E FRESATURA**
- p.221 **PUNTE E FRESE DA EDILIZIA E LEGNO**
- p.250 **LAME A NASTRO E A DISCO**
- p.254 **DISCHI LAMELLARI**
- p.291 **PULITURA**
- p.306 **MOLE E DISCHI DA TAGLIO**
- p.318 **ARREDAMENTO DA OFFICINA**
- p.364 **PRESSE E DIVARICATORI**
- p.394 **CHIAVI DI MANOVRA**
- p.452 **PINZE, MARTELLI, LIME, LEVE E SCALPELLI**
- p.481 **EDILIZIA ED IMBALLAGGIO**
- p.504 **ELETTROUTENSILI**
- p.535 **ATTREZZATURA PER LIQUIDI E FLUIDI**
- p.554 **CALIBRI, TRUSCHINI E RIGHE**
- p.566 **BLOCCHETTI, ANELLI E TAMPONI**
- p.581 **MISURATORI ANALOGICI E DIGITALI**
- p.030 **FRESATRICI**
- p.079 **LAVORAZIONE LAMIERA, FERRI E TUBI**
- p.109 **TAVOLE E DIVISORI**
- p.139 **ACCESSORI BORDO MACCHINA**
- p.165 **INSERTI, BRASATI E BARRETTE**
- p.228 **MASCHI E FILIERE**
- p.276 **RUOTE ABRASIVE**
- p.295 **FINITURA E LUCIDATURA**
- p.342 **MORSE DA BANCO E INCUDINI**
- p.370 **OFFICINA AUTO E MOTO**
- p.412 **CHIAVI A BUSSOLA ED ESTRATTORI**
- p.467 **CUTTER, SBAVATORI E FORBICI**
- p.484 **SERIE DI UTENSILI**
- p.518 **PNEUMATICA**
- p.543 **ILLUMINAZIONE E RISCALDATORI**
- p.560 **COMPARATORI**
- p.569 **ACCESSORI PER LA MISURAZIONE**
- p.590 **BILANCE E DINAMOMETRI**
- p.042 **TRAPANI**
- p.084 **MACCHINE LAVORAZIONE LEGNO**
- p.116 **MANDRINI**
- p.182 **PUNTE E FRESE DA METALLO**
- p.235 **RIPARAZIONE FILETTI**
- p.281 **DISCHI E NASTRI ABRASIVI**
- p.301 **SPAZZOLE A FILO**
- p.346 **MACCHINE PER TRATTAMENTI E FINITURE**
- p.379 **SOLLEVAMENTO E MOVIMENTAZIONE**
- p.437 **GIRAVITI E RIVETTATRICI**
- p.476 **ASSORTIMENTI E FISSAGGIO**
- p.532 **SALDATORI, SVERNICIATORI E PISTOLE TERMOCOLLANTI**
- p.564 **MICROMETRI**
- p.577 **FLESSOMETRI, LIVELLE E GONIOMETRI**



FERVI RISPONDE 
059.767172

1

UFFICIO COMMERCIALE

- Disponibilità e prezzi prodotti
- Gestione ordini
- Informazioni commerciali
- Rivenditori e rappresentanti
- Preventivi
- Info aziendali

2

ASSISTENZA TECNICA

- Informazioni tecniche
- Richiesta di assistenza
- Disponibilità ricambi
- Garanzia
- Preventivi riparazione

5

LINGUA INGLESE

NUMERO VERDE
800 17 25 99

SOLO DALL'ITALIA

www.fervi.com

 info@fervi.com



SEGUICI





PREZZI

TUTTI I PREZZI IN QUESTO CATALOGO SI INTENDONO **NON** COMPRESIVI DI IVA







TORNI

- p. 006  Torni pesanti
- p. 023  Torni paralleli
- p. 028  Torni da banco
- p. 029  Basi per torni

FRESATRICI

- p. 032  Fresatrici veloci
- p. 035  Trapani fresa ad ingranaggi
- p. 039  Trapani fresa a cinghie



TRAPANI

- p. 043  Trapani radiali
- p. 050  Trapani a colonna ad ingranaggi
- p. 052  Trapani a colonna a cinghie
- p. 059  Trapani da banco
- p. 062  Trapani magnetici

MACCHINE LAVORAZIONI MECCANICHE

- p. 065  Seghe a nastro
- p. 071  Mole da banco
- p. 074  Affilatrici
- p. 077  Levigatrici a nastro
- p. 067  Supporti

LAVORAZIONE LAMIERA, FERRI E TUBI

- p. 079  Lavorazione lamiera
- p. 082  Lavorazione ferri e tubi

MACCHINE LAVORAZIONE LEGNO

- p. 084  Torni
- p. 086  Pialle
- p. 089  Seghe circolari e squadratrici
- p. 091  Troncatrici
- p. 094  Seghe a nastro
- p. 098  Levigatrici a nastro
- p. 101  Aspiratori per trucioli











MORSE A MACCHINA

- p. 103  Morse di precisione
- p. 105  Morse a macchina
- p. 108  Parallele per morse



TAVOLE E DIVISORI

- p. 109  Divisori
- p. 112  Tavole
- p. 114  Piani magnetici
- p. 114  Staffaggio

MANDRINI

- p. 117  Mandrini per tornio da metalli
- p. 122  Mandrini per tornio da legno
- p. 123  Mandrini porta punte ed accessori
- p. 126  Mandrini porta pinze
- p. 128  Mandrini combinati porta frese
- p. 129  Mandrini porta frese Weldon
- p. 130  Mandrini porta frese coniche
- p. 131  Maschiatori
- p. 132  Testine per alesare
- p. 133  Smonta mandrini e portaconi

CONTROPUNTE E TORRETTE

- p. 135  Contropunte
- p. 136  Torrette

ACCESSORI BORDO MACCHINA

- p. 139  Refrigerazione
- p. 140  Protezioni
- p. 141  Illuminazione



UTENSILI PER TORNITURA E FRESATURA

- p. 146  Utensili per esterno da tornitura
- p. 152  Utensili per interno da tornitura
- p. 155  Utensili per filettare e troncare
- p. 160  Utensili per fresatura
- p. 164  Accessori utensili



INSERTI, BRASATI E BARRETTE

- p. 168  Inserti per tornitura
- p. 175  Inserti per fresatura
- p. 178  Inserti per filettare
- p. 178  Inserti per troncare
- p. 179  Brasati
- p. 181  Barrette



PUNTE E FRESE DA METALLO

- p. 184  Punta cilindriche
- p. 193  Punta coniche e da centro
- p. 195  Attacco Weldon
- p. 199  Seghe a tazza
- p. 206  Alesatori a macchina
- p. 207  Lamatori
- p. 208  Svasatori, utensili allargafori e a gradino
- p. 210  Frese frontali
- p. 212  Frese rotative in metallo duro
- p. 220  Coltelli stozzatori e creatori



PUNTE E FRESE DA EDILIZIA E LEGNO

- p. 211  Punta cilindriche
- p. 211  Attacco Sds Plus
- p. 222  Seghe a tazza
- p. 223  Utensili diamantati
- p. 226  Punta e seghe a tazza da legno
- p. 227  Frese da legno



MASCHI E FILIERE

- p. 228  Maschi e filiere in serie
- p. 231  Maschi a macchina
- p. 234  Filiere e girafilieri



RIPARAZIONE FILETTI

- p. 237  Serie riparazione filetti
- p. 242  Inserti filettati
- p. 246  Maschi per riparazione filetti
- p. 249  Utensili per riparazione filetti



LAME A NASTRO E A DISCO

- p. 250  Lame a nastro
- p. 251  Lame a disco



DISCHI LAMELLARI

- p. 256  Professional
- p. 260  Performance
- p. 264  Grindflex
- p. 268  Smartflex
- p. 271  Specialty
- p. 275  Fast Lock



RUOTE ABRASIVE

- p. 276  Ruote con gambo
- p. 277  Ruote con foro
- p. 278  Ruote per satinatrici



DISCHI E NASTRI ABRASIVI

- p. 281  Dischi in fibra
- p. 282  Dischi adesivi e velcrati
- p. 286  Rotoli e fogli
- p. 290  Nastri



PULITURA

- p. 291  Surface Conditioning
- p. 293  Nylon abrasivo
- p. 294  Non woven





FINITURA E LUCIDATURA

- p. 295  Feltro e paste abrasive
- p. 297  Sisal, cotone e lana
- p. 300  Spugne e gomme abrasive



SPAZZOLE A FILO



- p. 301  Spazzole con foro
- p. 303  Spazzole con gambo



MOLE E DISCHI DA TAGLIO

- p. 307  Dischi da taglio
- p. 310  Dischi da sbavo
- p. 311  Mole abrasive con foro
- p. 312  Mole abrasive con gambo
- p. 313  Dischi diamantati

**ARREDAMENTO DA
OFFICINA**

- p. 319  Arredamenti modulari
- p. 327  Banchi da lavoro
- p. 329  Armadietti e contenitori
- p. 333  Carrelli portautensili
- p. 337  Cassette e valigette



**MORSE DA BANCO E
INCUDINI**

- p. 342  Morse da banco
- p. 344  Morsetti
- p. 345  Incudini

**MACCHINE PER
TRATTAMENTI E FINITURE**

- p. 348  Sabbiatrici
- p. 355  Lavapezzi
- p. 358  Aspirapolvere aspiraliquidi
- p. 361  Marcatura

**PRESSE E
DIVARICATORI**

- p. 365  Presse idrauliche
- p. 367  Presse manuali
- p. 368  Pompe idrauliche











OFFICINA AUTO E MOTO

- p. 370  Cric a carrello e cavalletti
- p. 372  Gruette e supporti motore
- p. 374  Unità raccogli olio
- p. 375  Argani per auto
- p. 376  Sollevatori da moto e quad
- p. 378  Carrellini sottauto



**SOLLEVAMENTO E
MOVIMENTAZIONE**

- p. 379  Cric idraulici
- p. 380  Carrelli
- p. 383  Paranchi
- p. 384  Accessori per il sollevamento
- p. 387  Argani e tendi cavi
- p. 388  Movimentazione pallet





CHIAVI DI MANOVRA

- p. 394  Chiavi a cricchetto
- p. 395  Chiavi fisse
- p. 396  Chiavi combinate
- p. 398  Chiavi poligonali
- p. 401  Chiavi a tubo
- p. 403  Chiavi esagonali
- p. 405  Chiavi torx
- p. 407  Chiavi a T
- p. 408  Chiavi per filtro
- p. 409  Chiavi dinamometriche









CHIAVI A BUSSOLA ED ESTRATTORI

- p. 412  Leve a cricchetto
- p. 414  Chiavi a bussola
- p. 428  Chiavi a bussola ad impatto
- p. 436  Estrattori







GIRAVITI E RIVETTATRICI

- p. 437  Giraviti a bussola
- p. 439  Giraviti
- p. 443  Giraviti di precisione
- p. 445  Inserti e portainseriti
- p. 450  Rivettatrici a leva

PINZE, MARTELLI, LIME, LEVE E SCALPELLI

- p. 452  Pinze
- p. 456  Pinze grip e a morsetto
- p. 457  Pinze idrauliche e giratubo
- p. 458  Martelli e mazzuoli
- p. 461  Cacciaspine e scalpelli
- p. 464  Lime
- p. 466  Leve

CUTTER, SBAVATORI E FORBICI

- p. 467  Cutter
- p. 469  Sbavatori
- p. 471  Seghetti
- p. 472  Forbici e cesoie
- p. 473  Tagliatubi

ASSORTIMENTI E FISSAGGIO

- p. 476  Punti per fissatrici e chiodatrici
- p. 476  Assortimenti

EDILIZIA ED IMBALLAGGIO

- p. 481  Pistole per prodotti chimici
- p. 482  Cazzuole, spatole e frattoni
- p. 483  Materiale per imballaggio

SERIE DI UTENSILI

- p. 484  Carrelli con utensili
- p. 490  Serie di utensili in termoformati
- p. 499  Valigette con utensili

ELETTROUTENSILI

p. 505



Elettrotensili
a Batteria

p. 513



Elettrotensili
a Filo

PNEUMATICA

p. 518



Fissatrici

p. 520



Avvitatori

p. 523



Smerigliatrici

p. 523



Levigatrici

p. 526



Pistole per soffiaggio
e gonfiaggio

p. 528



Aerografi

p. 531



Avvolgitubo

**SALDATORI, SVERNICIATORI
E PISTOLE TERMOCOLLANTI**

p. 532



Saldatori

p. 533



Sverniciatori

p. 534



Pistole termocollanti

**ATTREZZATURA PER
LIQUIDI E FLUIDI**

p. 535



Oliatori

p. 536



Ingrassatori

p. 537



Spray

p. 540



Taniche

p. 540



Nebulizzatori

p. 541



Pompe di travaso

**ILLUMINAZIONE E
RISCALDATORI**

p. 543



Riscaldatori

p. 544



Faretti LED

p. 545



Lampade

p. 547



Lenti

p. 547



Torçe e lampade
a batteria





p. 551



Avvolgicavo e multiprese



CALIBRI, TRUSCHINI E RIGHE

- p. 554  Calibri digitali
- p. 555  Calibri con comparatore
- p. 555  Calibri vernier
- p. 559  Truschini
- p. 559  Righe digitali



COMPARATORI

- p. 560  Comparatori digitali e analogici
- p. 562  Misuratori di spessore
- p. 563  Centratori



MICROMETRI

- p. 564  Micrometri per esterni
- p. 565  Micrometri per interni



BLOCCHETTI, ANELLI E TAMPONI

- p. 566  Blocchetti di riscontro
- p. 567  Anelli e tamponi



ACCESSORI PER LA MISURAZIONE

- p. 569  Basi magnetiche e supporti
- p. 572  Piani di riscontro
- p. 572  Squadre
- p. 574  Spessimetri e contafiletti



FLESSOMETRI, LIVELLE E GONIOMETRI

- p. 577  Flessometri
- p. 578  Livelle
- p. 580  Goniometri



MISURATORI ANALOGICI E DIGITALI

- p. 581  Endoscopi e Microscopi
- p. 582  Pinze amperometriche e multimetri
- p. 583  Misuratori digitali
- p. 587  Rifrattometri
- p. 588  Durometri



BILANCE E DINAMOMETRI

- p. 590  Bilance
- p. 591  Dinamometri

FERVI

THE SMART COMPANY

Sempre al passo coi tempi in tema d'innovazione per anticipare bisogni e desideri dei nostri clienti. Questa è Fervi: **leader del settore MRO** (Maintenance, Repair and Operations) e partner ideale per ogni **esigenza professionale e hobbistica**, per la costruzione, manutenzione e riparazione di qualunque oggetto.

Smart come filosofia d'impresa, nei rapporti con clienti e fornitori, ma soprattutto nell'offerta di **articoli performanti** attraverso piattaforme sempre più tecnologiche, dinamiche e sicure.

Siamo un'**azienda solida, affidabile e competitiva**, punto di riferimento nello scenario europeo per la ricerca, progettazione, produzione e distribuzione di **macchine utensili e utensileria** conformi ai più alti requisiti di qualità e affidabilità, protagonisti di un mercato che cresce con noi.



FIT FOR YOU

VISION

Offrire **i prodotti più adeguati, più funzionali e sicuri**, ai lavoratori dell'industria e dell'artigianato **per migliorare** concretamente **la produttività e la qualità** del loro lavoro quotidiano.

MISSION

Progettare e produrre, ricercare e selezionare, distribuire macchine utensili e utensileria **con il miglior rapporto qualità-prezzo**, garantendo standard qualitativi di sicurezza e di servizio altamente superiori alla media dei nostri concorrenti diretti. La nostra passione per il **rinnovamento continuo** di prodotti e servizi, il grande rispetto per il lavoro dei nostri clienti e la conoscenza profonda dei bisogni del nostro settore ci identificano come il **partner ideale** per tutti i grandi progetti o piccoli interventi di manutenzione o riparazione quotidiana.

VALUES



**IL CLIENTE AL
CENTRO DI TUTTO**



**MIGLIORAMENTO
CONTINUO**



**TRASPARENZA
NEI COMPORAMENTI**



**SPIRITO
DI SQUADRA**

FERVI GROUP

Machinery and Tools for MRO

GUARDARE AVANTI È NEL DNA DELL'INNOVATORE

La direzione intrapresa e fortemente voluta dal Management è quella della crescita del know-how tecnico e della digital-transformation dei servizi per offrire ai propri clienti un supporto sempre all'avanguardia e in grado di sostenerli nel loro business quotidiano.

Tutto questo è stato possibile unendo saldamente le professionalità e le competenze di tutte le realtà che oggi costituiscono **FERVI GROUP**.

Una sinergia di player di riferimento del settore MRO, pronta a crescere ancora, che oggi getta le basi per un futuro ancora più attento alle evoluzioni del mercato e alla tutela delle risorse e delle persone.



1991

Veprug si evolve nel progetto imprenditoriale a marchio Fervi.

2012

Il primo catalogo Fervi è distribuito in 35.000 copie.

2015



Ampliamento del made in Italy, Ri-flex Abrasives entra nella famiglia Fervi.

1978

Veprug Srl nasce e si afferma come grossista del territorio modenese.

2011



Cambia la proprietà aziendale, l'azienda si consolida nel suo percorso di crescita.

2013

Impatto zero raggiunto, i nuovi uffici Fervi sono autosufficienti sotto il profilo energetico.

Una scelta sempre più completa e affidabile per te.

La strategia di sviluppo adottata dall'azienda ha permesso così di raggiungere una connotazione tale da poter fregiarsi del titolo di primo gruppo italiano del settore MRO, permettendo di essere al fianco dei clienti in ogni situazione.



Fondata nel 1978, propone un'offerta che include macchine utensili, utensileria manuale e abrasivi. Oltre 8600 referenze al servizio dei professionisti della manutenzione e riparazione in ambito industriale, artigianale, automotive e del fai-da-te evoluto.



Dal 1982, produttore Made in Italy di dischi abrasivi lamellari di alta qualità tramite macchine automatiche studiate e realizzate internamente. Gli impianti automatici per la produzione dei dischi lamellari sono venduti in tutto il mondo.



Fondata nel 1949, produce e commercializza strumenti di misura di alta gamma, proposti attraverso agenti locali ed una rete di distributori world wide.



Era il 1952 quando nasceva lo storico distributore spagnolo di Fervi, con sede a Barcellona. La distribuzione avviene in forma diretta ed attraverso la propria rete vendita.



Dal 1973, Rivit è il partner ideale per quanto riguarda la produzione e distribuzione di sistemi di fissaggio, utensili per bulloneria e macchine per la lavorazione e l'assemblaggio della lamiera.



2020

8500+ referenze



2022

8600 referenze



2024

8600+ referenze

2019

Il 100% di Vogel Germany & Co Kg passa al Gruppo Fervi.

2022

Nasce FERVI GROUP: l'identità di ogni azienda è il mattone che costruisce il ponte verso il futuro del settore MRO.

2018

Fervi festeggia i suoi primi 40 anni di attività con l'entrata in borsa e acquisisce il 40% di Sitges Maquinas y Acesorios.

2021

Rivit, azienda italiana specializzata nella fornitura di sistemi di fissaggio, entra far parte della famiglia Fervi.

2023

Fervi ottiene la certificazione ESG rating AA-

UNA PRESENZA CAPILLARE. UNA FIDUCIA INTERNAZIONALE.

La nostra distribuzione e assistenza.

Con oltre **4500 punti vendita in Italia**, una presenza in oltre **50 paesi del Mondo** e con più di **8000 clienti**, Fervi Group ha preso oggi una posizione ben definita: quella di essere sempre più vicino ai propri clienti per garantire loro il sostegno quotidiano allo sviluppo del business.

La via intrapresa dal Gruppo è orientata a una costante espansione commerciale, supportata sempre da un'eccellente assistenza tecnica per garantire l'offerta completa dei prodotti e dei servizi in modo capillare, ovunque.

I nostri tecnici altamente specializzati offrono un supporto ed un efficiente servizio di assistenza interno di riparazione oltre che di consulenza in merito all'installazione ed alla manutenzione delle attrezzature.



FERVI GROUP

Machinery and Tools for MRO

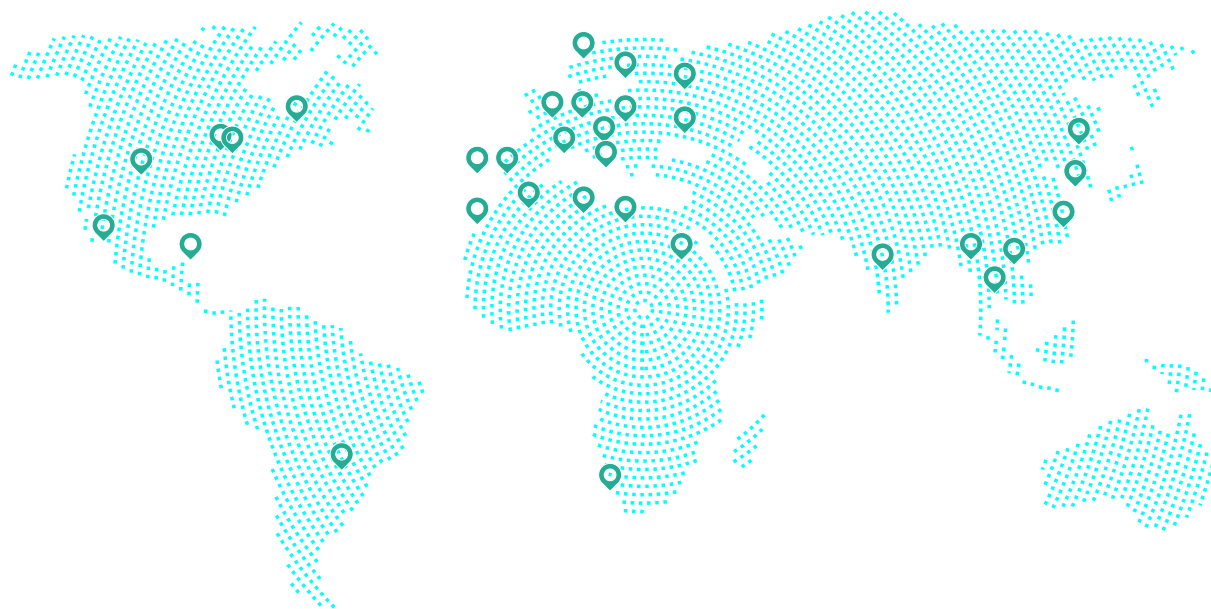

***Un unico indirizzo,
soluzioni personalizzate.***

Il Gruppo si presenta come One-Stop-Shop
in grado di sostenere il business quotidiano
dei propri clienti.

Gestione, organizzazione, metodo.

La qualità secondo Fervi.

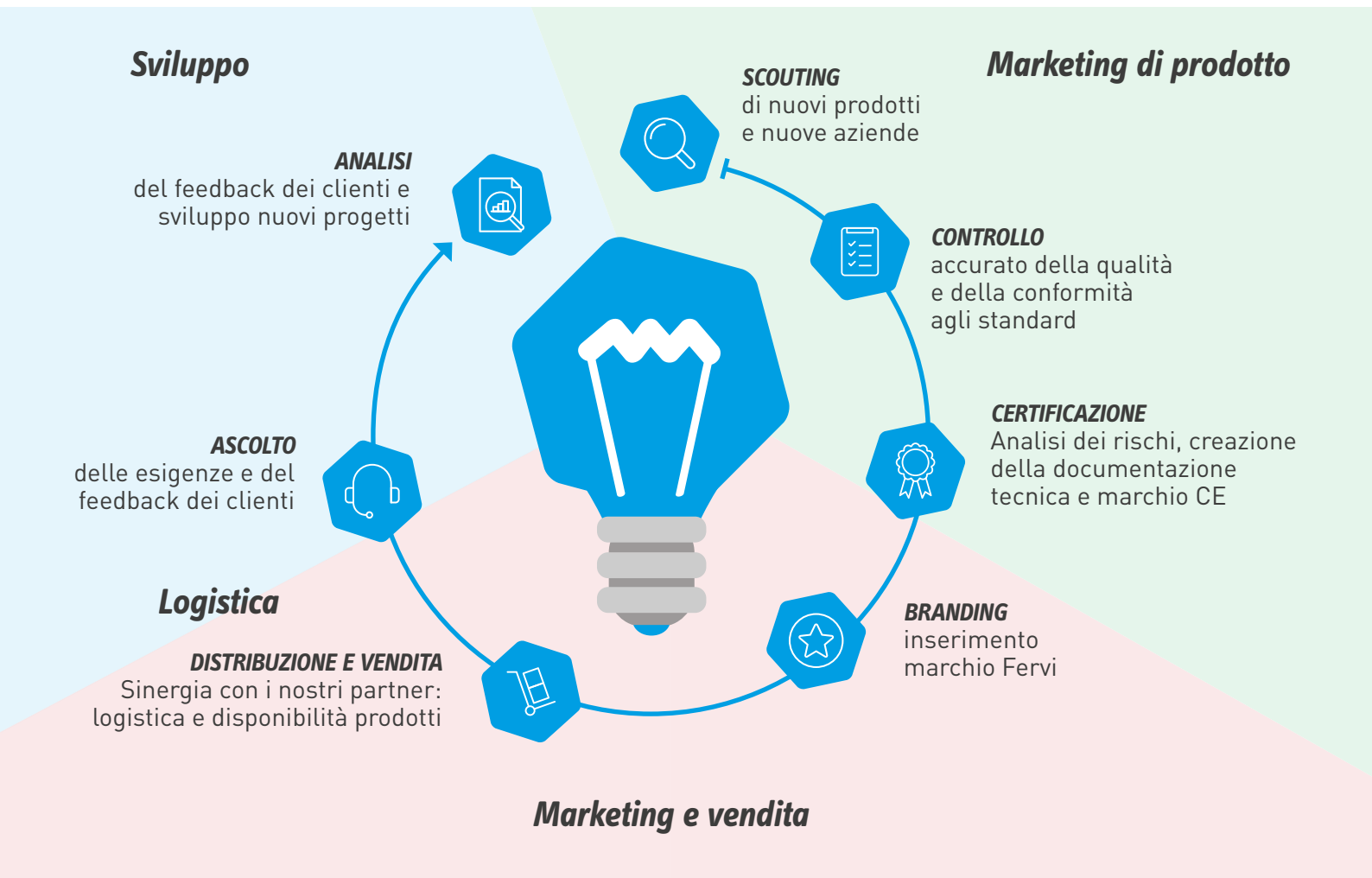

I nostri numeri

Spazi, persone e orizzonti del mondo Fervi.

1+1

SHOWROOM
FISICO E VIRTUALE

8600+

REFERENZE
A CATALOGO

3000+

REFERENZE
DI RICAMBISTICA

10000m²

DI MAGAZZINO

200M

PEZZI SUL MERCATO

3000+

ORDINI OGNI MESE

Le nostre certificazioni.

La nostra qualità

Il senso di responsabilità sociale e commerciale di Fervi è alla base di ogni iniziativa e attività intrapresa dai componenti del Gruppo Fervi e da coloro che ne sono coinvolti.

I nostri collaboratori

La nostra forza primaria, tutelata da processi e dispositivi, certificati secondo i più alti standard. Un ambiente sano e sicuro in cui lavorare per un benessere aziendale forte e consolidato.

I nostri clienti

Ogni prodotto a marchio Fervi è la sintesi di tutto ciò per cui ci impegniamo ogni giorno. Alta qualità, affidabilità e sicurezza sempre garantiti al 100%.

I nostri partner

Chi collabora con le realtà del Gruppo Fervi può sempre contare su una affidabilità finanziaria certificata. Un gesto di fiducia in più per costruire rapporti solidi e produttivi.

L'ambiente di tutti

Abbiamo raggiunto l'autosufficienza energetica, grazie all'installazione di impianti fotovoltaici di ultima generazione.

+ Ecosostenibilità



La nostra attenzione alla sostenibilità ambientale ci ha portato a realizzare un catalogo ecosostenibile, utilizzando carta PEFC più leggera e meno trattata con un obiettivo unico: pensare al nostro pianeta risparmiando, nel nostro piccolo, tanta più CO2 possiamo.



ESG RATING: AA-

FERVI S.P.A



FERVI *plus*

Il servizio ideato da FERVI che ti protegge ancora prima di ricevere il prodotto.

FERVI ha deciso di mettere il cliente ancora più al centro. Alcuni prodotti possono usufruire di questo ulteriore servizio, completamente gratuito ed offerto da FERVI, che permette di avere una serie di Plus di cui non puoi farne a meno.

I Plus del servizio:



Estensione di un anno della garanzia.



Il controllo pre-consegna che aumenta l'attenzione alla qualità.



Un numero dedicato all'assistenza tecnica sui prodotti Fervi.



I tuoi documenti a portata di click, potrai trovarli tutti nel portale dedicato.

Come usufruirne:

E' semplice.

I prodotti segnalati sul catalogo con la scritta Fervi Plus hanno al loro interno una cartolina con un codice che permette di registrarsi ad un'area riservata del sito Fervi.



Registrati al servizio FERVI Plus, pochi passi per ottenere il massimo e stare tranquilli di poter usufruire di un servizio senza eguali.

Inquadra il QR Code e guarda il video tutorial.





FERVI PER LO SPORT



BENVENUTI IN SQUADRA

Costruiremo qualcosa di grande. Insieme.

Supportiamo in ogni appuntamento le realtà sportive nelle quali riconosciamo i nostri stessi valori di senso di appartenenza, il rispetto dell'avversario, la lealtà e l'alta competizione.

WSBK



LBA



IHL



FERVI PER L'UNIVERSITÀ

SKYWARD
Experimental Rocketry



DIGITAL FERVI

Una qualità tutta da condividere

Fervi è sempre più attenta alle piattaforme digitali e social per mostrare al meglio i suoi prodotti e soddisfare le esigenze della community in tempi rapidi, in ogni momento del giorno.



Sito fervi.com – veloce, dinamico, rinnovato nella grafica e costantemente aggiornato con tutte le informazioni tecniche per approfondire la conoscenza di ogni prodotto.

Sezione offerte – Non perdere l'opportunità di scoprire immediatamente le Promozioni che FERVI riserva ai propri clienti. Facile, veloce e visibile con qualunque dispositivo.

Dove Acquistare – È molto semplice trovare un rivenditore in cui acquistare i prodotti sul sito Fervi. Basta inserire la propria posizione e il gioco è fatto.

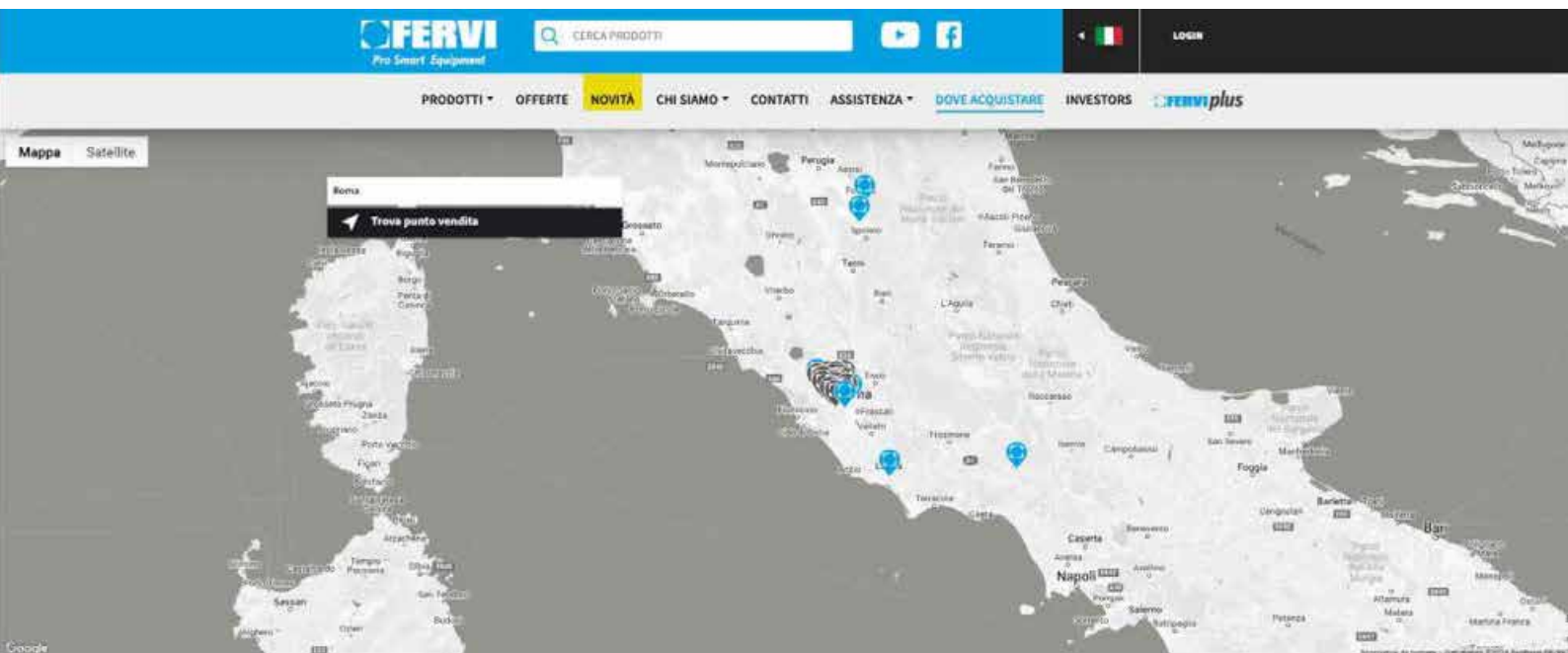

Punti vendita vicino a Roma

Rivenditori Premium



Virtual Show-Room – Il posto ideale per fare un giro virtuale tra gli scaffali e vedere tutti gli strumenti della gamma Fervi.



Inquadra il QR Code con il tuo smartphone o visita fervi.com ed entra nel Virtual Show Room Fervi.

Social – Una pagina Facebook molto attiva grazie alla nostra community ma anche Instagram e Youtube per essere sempre aggiornati e scambiarsi opinioni sul mondo hobbistico e professionale.



FERVI ARREDA

Le soluzioni FERVI per incrementare il rendimento del punto vendita

Pannelli espositivi

Ideale per l'esposizione completa dell'offerta FERVI dedicata al mondo dell'utensileria, degli elettrodomestici e delle piccole macchine utensili.



Vele

Ideali per aree espositive con macchine utensili. La vela identifica l'area FERVI all'interno dell'esposizione.



Gazebo

Ideale per esposizioni indoor di macchine, arredi officina e tutto quanto possa richiedere uno spazio coperto e raccolto.



Copri pallet

In tre diverse dimensioni (3,4,5 pallet) per creare delle isole espositive (80x120) per piccole macchine ed utensileria voluminosa utilizzando i pallet presenti in tutte le Rivendite.

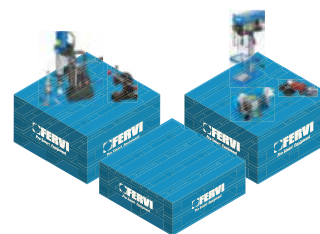

Espositori da Banco

La modalità perfetta per presentare i best runner ai tuoi clienti



Pallbox

Da posizionare di fronte al banco o vicino alla cassa per agevolare l'acquisto



Crea il tuo Showroom

Una proposta esclusiva per i rivenditori autorizzati.

Fervi pensa agli arredi, tu incrementi il fatturato e il rendimento al metro quadro. Oltre 800 clienti hanno deciso di aumentare il proprio business con le soluzioni FERVI Arreda!

Il chilometro azzurro

Siamo orgogliosi di dire che ad oggi, grazie ai nostri clienti sono installati oltre 1000 metri lineari espositivi che permettono una chiara visione dell'offerta e del panorama FERVI in termini di soluzioni espositive.

Lo stadio azzurro

Al chilometro lineare aggiungiamo 1 campo da calcio fatto di Gazebo FERVI installati presso i nostri rivenditori e punto di riferimento. Oggi FERVI aumenta la sua offerta di soluzioni permettendoti la personalizzazione del punto vendita in base alle tue esigenze.





46

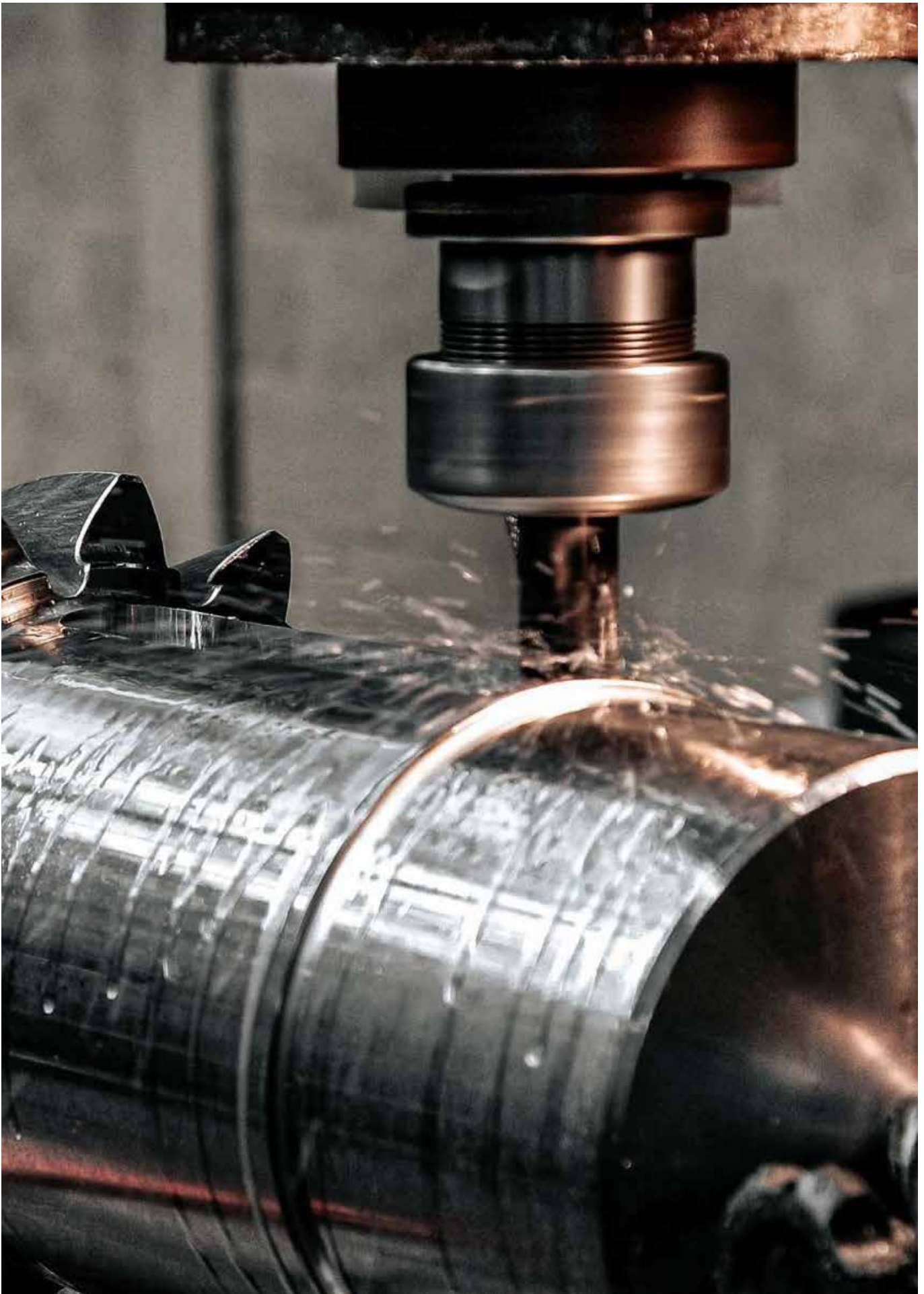





TORNI

- p. 006  Torni pesanti
- p. 023  Torni paralleli
- p. 028  Torni da banco
- p. 029  Basi per torni







FRESATRICI

- p. 032  Fresatrici veloci
- p. 035  Trapani fresa ad ingranaggi
- p. 039  Trapani fresa a cinghie



TRAPANI

- p. 043  Trapani radiali
- p. 050  Trapani a colonna ad ingranaggi
- p. 052  Trapani a colonna a cinghie
- p. 059  Trapani da banco
- p. 062  Trapani magnetici





MACCHINE LAVORAZIONI MECCANICHE

- p. 065  Seghe a nastro
- p. 071  Mole da banco
- p. 074  Affilatrici
- p. 077  Levigatrici a nastro
- p. 067  Supporti



LAVORAZIONE LAMIERA, FERRI E TUBI

- p. 079  Lavorazione lamiera
- p. 082  Lavorazione ferri e tubi



MACCHINE LAVORAZIONE LEGNO

- p. 084  Torni
- p. 086  Pialle
- p. 089  Seghe circolari e squadratrici
- p. 091  Troncatrici
- p. 094  Seghe a nastro
- p. 098  Levigatrici a nastro
- p. 101  Aspiratori per trucioli



MORSE A MACCHINA

- p. 103  Morse di precisione
- p. 105  Morse a macchina
- p. 108  Parallele per morse













TAVOLE E DIVISORI

- p. 109  Divisori
- p. 112  Tavole
- p. 114  Piani magnetici
- p. 114  Staffaggio





MANDRINI

- p. 117  Mandrini per tornio da metalli
- p. 122  Mandrini per tornio da legno
- p. 123  Mandrini porta punte ed accessori
- p. 126  Mandrini porta pinze
- p. 128  Mandrini combinati porta frese
- p. 129  Mandrini porta frese Weldon
- p. 130  Mandrini porta frese coniche
- p. 131  Maschiatori
- p. 132  Testine per alesare
- p. 133  Smonta mandrini e portaconi



CONTROPUNTE E TORRETTE

- p. 135  Contropunte
- p. 136  Torrette



ACCESSORI BORDO MACCHINA

- p. 139  Refrigerazione
- p. 140  Protezioni
- p. 141  Illuminazione

TORNI PROFESSIONALI

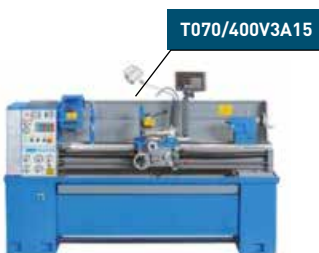
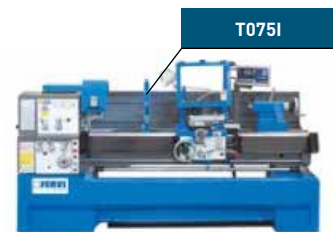
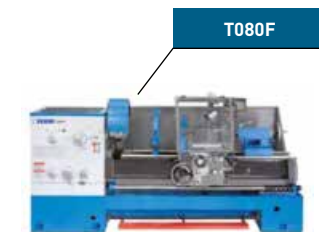
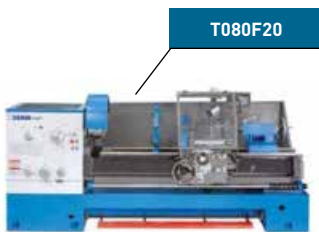
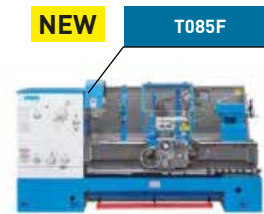
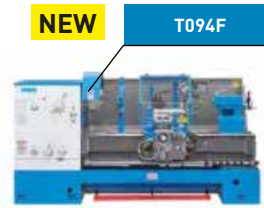
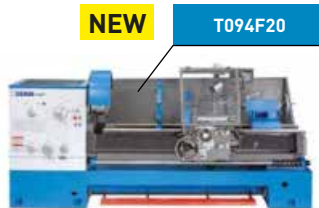
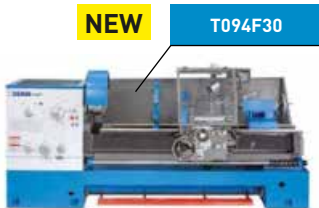
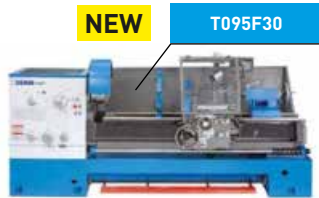



TORNI PROFESSIONALI

Diametro mandrino (mm)

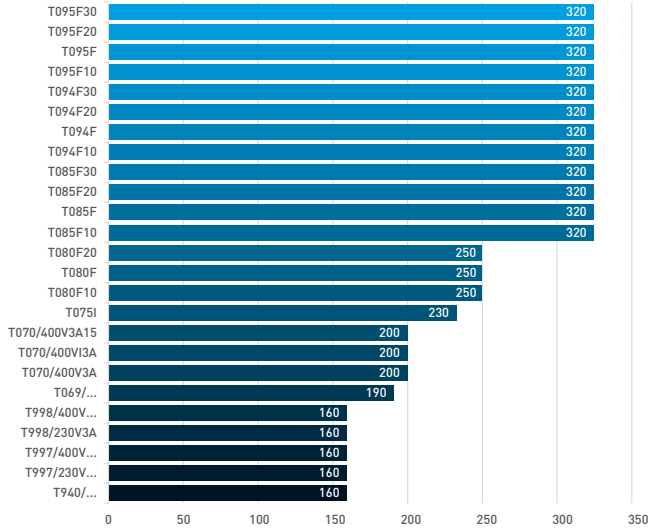

Potenza (W)

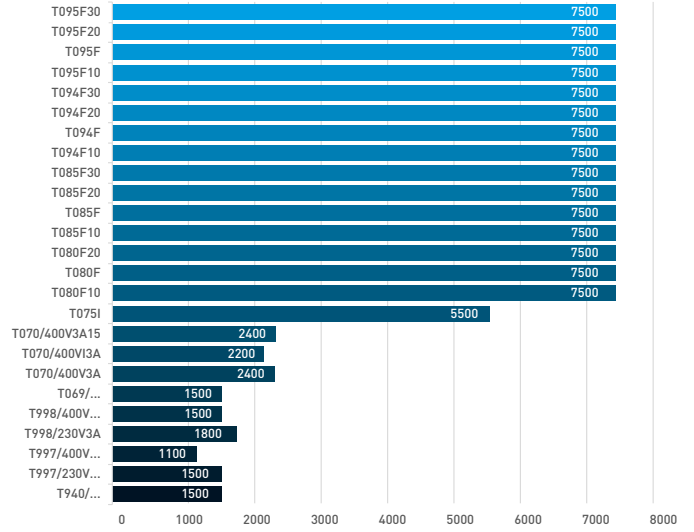

Diametro max sul carro (mm)

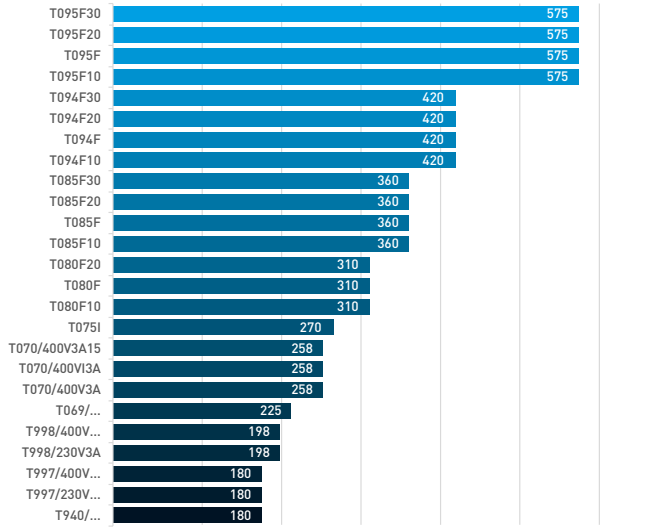

Altezza punte (mm)

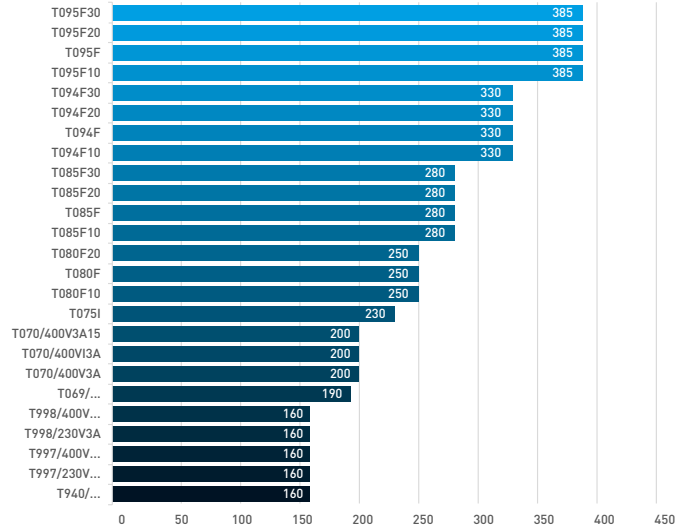

Distanza punte (mm)

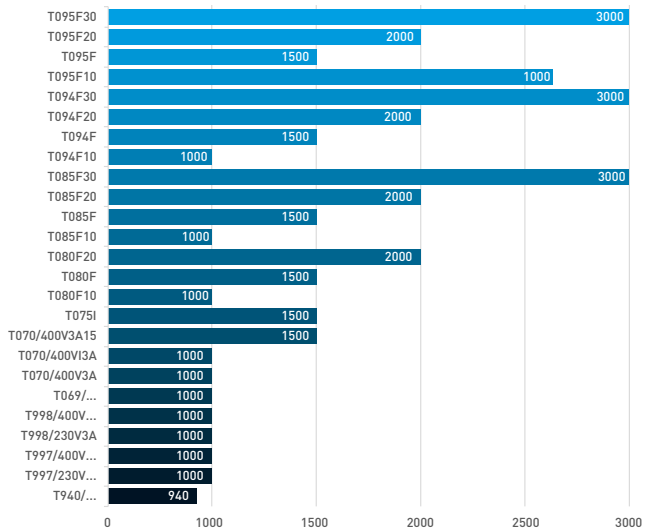

Passaggio barra (mm)

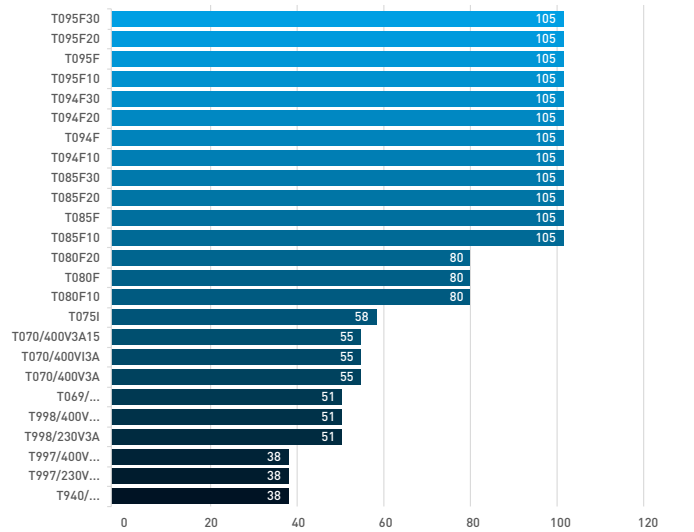

T095Fx
NEW
TORNIO PARALLELO CON FRIZIONE E VISUALIZZATORE

Con frizione meccanica, visualizzatore a 3 assi e scatola ingranaggi semi norton. Dotato di joystick per l'inserimento degli avanzamenti rapidi. Con basamento in monoblocco di ghisa. Disponibile anche in versione 60Hz.

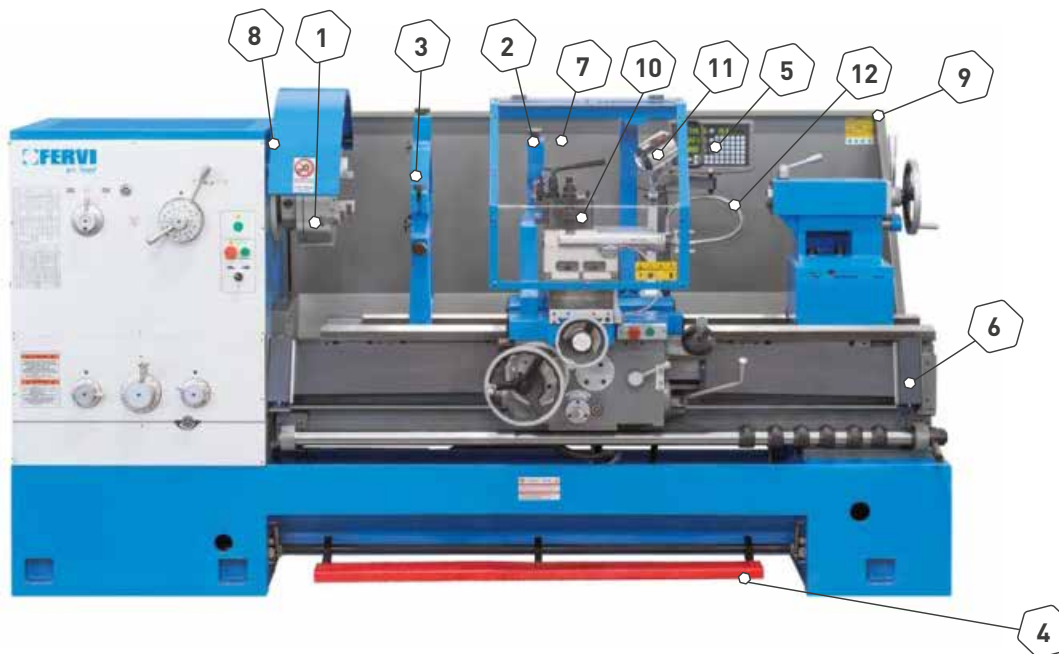

- | | |
|-------------------------------------------------|-------------------------------------|
| 1 Mandrino autocentrante
3+3 Ø 320 mm | 6 Protezione vite madre |
| 2 Lunetta mobile | 7 Protezione torretta |
| 3 Lunetta fissa | 8 Protezione mandrino |
| 4 Freno a pedale | 9 Paraspruzzi posteriore |
| 5 Visualizzatore a 3 assi | 10 Torretta a cambio rapido |
| | 11 Lampada |
| | 12 Sistema di raffreddamento |

ACCESSORI INCLUSI

- Mandrino autocentrante a 3 griffe reversibili Ø 320 mm
- Piattaforma a 4 griffe indipendenti Ø 400 mm
- Flangia Ø 600 mm
- Lunetta mobile
- Lunetta fissa
- Contropunta rotante CM 5
- Comparatore di filettatura
- Protezione vite madre
- Protezione torretta
- Protezione mandrino
- Paraspruzzi posteriore
- Torretta a cambio rapido tipo C
- Lampada a LED
- Sistema di raffreddamento
- Freno a pedale elettro-meccanico
- Carrello contropunta a bloccaggio rapido
- Ingranaggi del carro a bagno d'olio
- Piedini livellanti regolabili

Art.	T095F10 NEW	T095F	T095F20 NEW	T095F30 NEW
Altezza punte	385 mm	385 mm	385 mm	385 mm
Diametro max sul banco	770 mm	770 mm	770 mm	770 mm
Diametro max sul carro	575 mm	575 mm	575 mm	575 mm
Diametro max sull'incavo	1050 mm	1050 mm	1050 mm	1050 mm
Altezza utensile	32 mm	32 mm	32 mm	32 mm
Distanza tra le punte	1000 mm	1500 mm	2000 mm	3000 mm
Passaggio barra	105 mm	105 mm	105 mm	105 mm
Attacco mandrino	Camlock D1-8	Camlock D1-8	Camlock D1-8	Camlock D1-8
Velocità del mandrino	(12) 36 ÷ 1600 rpm	(12) 36 ÷ 1600 rpm	(12) 36 ÷ 1600 rpm	(12) 36 ÷ 1600 rpm
Avanzamenti longitudinali	0,063 ÷ 2,52 mm/giro	0,063 ÷ 2,52 mm/giro	0,063 ÷ 2,52 mm/giro	0,063 ÷ 2,52 mm/giro
Avanzamenti trasversali	0,027 ÷ 1,07 mm/giro	0,027 ÷ 1,07 mm/giro	0,027 ÷ 1,07 mm/giro	0,027 ÷ 1,07 mm/giro
Filettature metriche	(22) 1 ÷ 14 mm	(22) 1 ÷ 14 mm	(22) 1 ÷ 14 mm	(22) 1 ÷ 14 mm
Filettature in pollici	(26) 2 ÷ 28 TPI	(26) 2 ÷ 28 TPI	(26) 2 ÷ 28 TPI	(26) 2 ÷ 28 TPI
Conicità contropunta CM	5	5	5	5
Motore	400V 50/60 Hz 7,5 kW	400V 50 Hz 7,5 kW	400V 50/60 Hz 7,5 kW	400V 50/60 Hz 7,5 kW
Pompa di refrigerazione	400V 50/60 Hz 90 W	400V 50 Hz 90 W	400V 50/60 Hz 90 W	400V 50/60 Hz 90 W
Dimensioni	2500 x 1550 x 1700 mm	3000 x 1550 x 1700 mm	3500 x 1550 x 1700 mm	4500 x 1550 x 1700 mm
Peso netto	3250 Kg	3560 kg	3950 Kg	4050 Kg
€	€ 57900,00	€ 62810,00	€ 64900,00	€ 72900,00



T094Fx FERVIplus
NEW
TORNIO PARALLELO CON FRIZIONE E VISUALIZZATORE

Con frizione meccanica, visualizzatore a 3 assi e scatola ingranaggi semi norton. Dotato di joystick per l'inserimento degli avanzamenti rapidi. Con basamento in monoblocco di ghisa. Disponibile anche in versione 60 Hz.

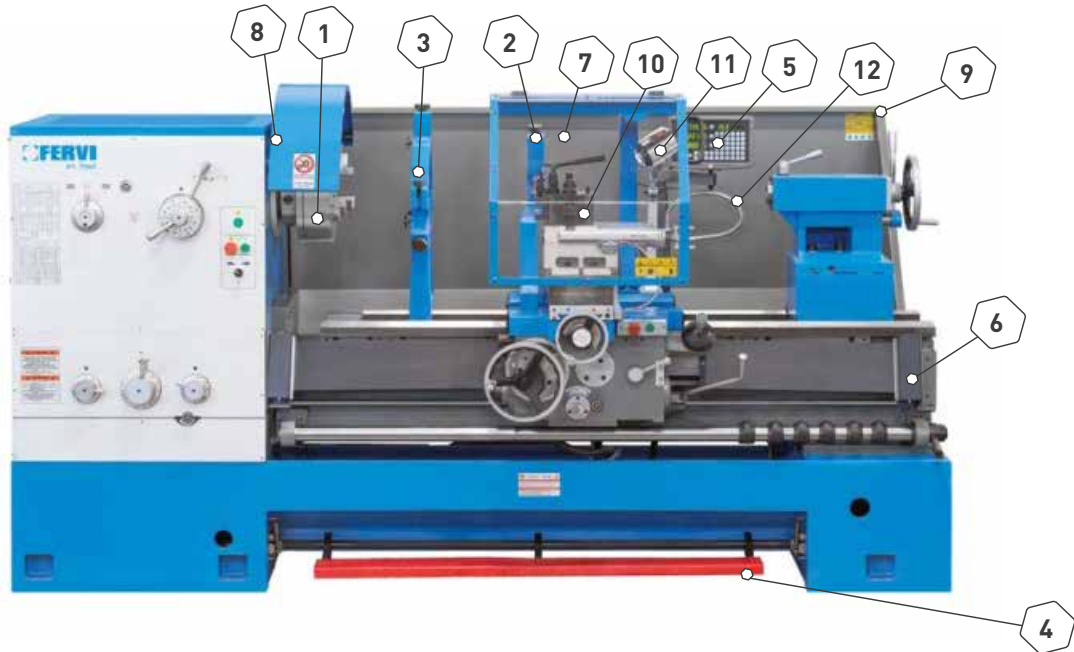
1 Mandrino autocentrante

3+3 Ø 320 mm

2 Lunetta mobile
3 Lunetta fissa
4 Freno a pedale
5 Visualizzatore a 3 assi
6 Protezione vite madre
7 Protezione torretta
8 Protezione mandrino
9 Paraspruzzi posteriore
10 Torretta a cambio rapido
11 Lampada
12 Sistema di raffreddamento
ACCESSORI INCLUSI

- Mandrino autocentrante a 3 griffe reversibili Ø 320 mm
- Piattaforma a 4 griffe indipendenti Ø 400 mm
- Flangia Ø 600 mm
- Lunetta mobile
- Lunetta fissa
- Contropunta rotante CM 5
- Comparatore di filettatura
- Protezione vite madre
- Protezione torretta
- Protezione mandrino
- Paraspruzzi posteriore
- Torretta a cambio rapido tipo C
- Lampada a LED
- Sistema di raffreddamento
- Freno a pedale elettro-meccanico
- Carrello contropunta a bloccaggio rapido
- Ingranaggi del carro a bagno d'olio
- Piedini livellanti regolabili

Art.	T094F10	NEW	T094F	NEW	T094F20	NEW	T094F30	NEW
Altezza punte	330 mm		330 mm		330 mm		330 mm	
Diametro max sul banco	660 mm		660 mm		660 mm		660 mm	
Diametro max sul carro	420 mm		420 mm		420 mm		420 mm	
Diametro max sull'incavo	870 mm		870 mm		870 mm		870 mm	
Altezza utensile	32 mm		32 mm		32 mm		32 mm	
Distanza tra le punte	1000 mm		1500 mm		2000 mm		3000 mm	
Passaggio barra	105 mm		105 mm		105 mm		105 mm	
Attacco mandrino	Camlock D1-8		Camlock D1-8		Camlock D1-8		Camlock D1-8	
Velocità del mandrino	(12) 36 ÷ 1600 rpm		(12) 36 ÷ 1600 rpm		(12) 36 ÷ 1600 rpm		(12) 36 ÷ 1600 rpm	
Avanzamenti longitudinali	0,063 ÷ 2,52 mm/giro		0,063 ÷ 2,52 mm/giro		0,063 ÷ 2,52 mm/giro		0,063 ÷ 2,52 mm/giro	
Avanzamenti trasversali	0,027 ÷ 1,07 mm/giro		0,027 ÷ 1,07 mm/giro		0,027 ÷ 1,07 mm/giro		0,027 ÷ 1,07 mm/giro	
Filettature metriche	(22) 1 ÷ 14 mm		(22) 1 ÷ 14 mm		(22) 1 ÷ 14 mm		(22) 1 ÷ 14 mm	
Filettature in pollici	(26) 2 ÷ 28 TPI		(26) 2 ÷ 28 TPI		(26) 2 ÷ 28 TPI		(26) 2 ÷ 28 TPI	
Conicità contropunta CM	5		5		5		5	
Motore	400V 50 Hz 7,5 kW		400V 50 Hz 7,5 kW		400V 50 Hz 7,5 kW		400V 50 Hz 7,5 kW	
Pompa di refrigerazione	400V 50 Hz 90 W		400V 50 Hz 90 W		400V 50 Hz 90 W		400V 50 Hz 90 W	
Dimensioni	2500 x 1400 x 1600 mm		3000 x 1400 x 1600 mm		3500 x 1400 x 1600 mm		4500 x 1400 x 1600 mm	
Peso netto	3040 Kg		3330 Kg		3700 Kg		3820 Kg	
€	€ 53500,00		€ 56000,00		€ 59000,00		€ 67500,00	



T085Fx
NEW
TORNIO PARALLELO CON FRIZIONE E VISUALIZZATORE

Con frizione meccanica, visualizzatore a 3 assi e scatola ingranaggi semi norton. Dotato di joystick per l'inserimento degli avanzamenti rapidi. Con basamento in monoblocco di ghisa. Disponibile anche in versione 60 Hz.

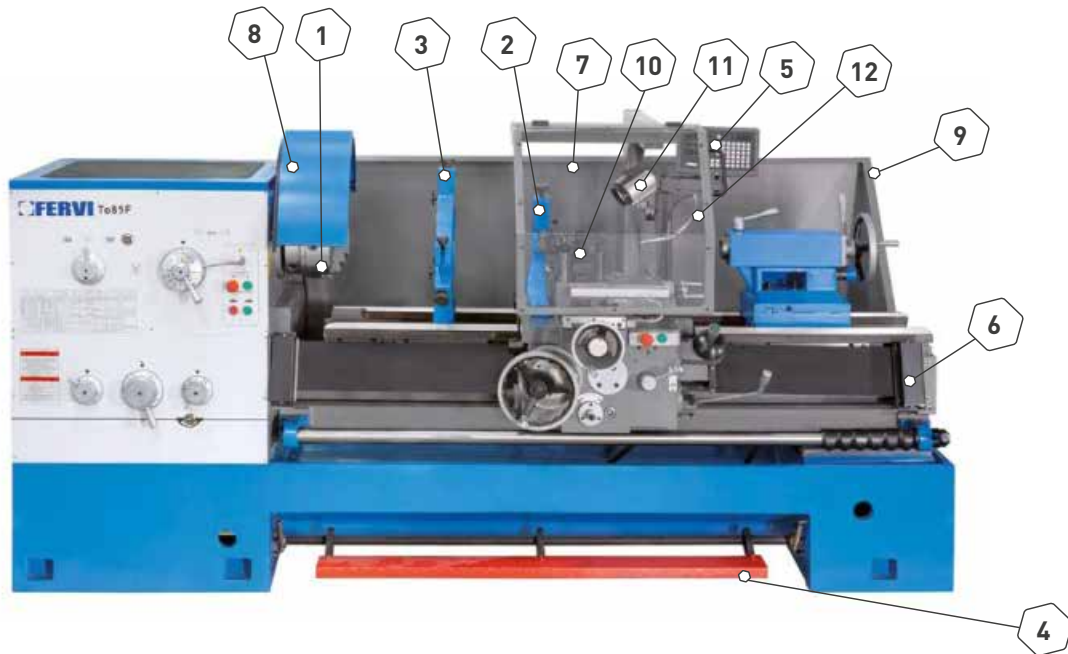
1 Mandrino autocentrante

3+3 Ø 320 mm

2 Lunetta mobile
3 Lunetta fissa
4 Freno a pedale
5 Visualizzatore a 3 assi
6 Protezione vite madre
7 Protezione torretta
8 Protezione mandrino
9 Paraspruzzi posteriore
10 Torretta a cambio rapido
11 Lampada
12 Sistema di raffreddamento
ACCESSORI INCLUSI

- Mandrino autocentrante a 3 griffe reversibili Ø 320 mm
- Piattaforma a 4 griffe indipendenti Ø 400 mm
- Flangia Ø 600 mm
- Lunetta mobile
- Lunetta fissa
- Contropunta rotante CM 5
- Comparatore di filettatura
- Protezione vite madre
- Protezione torretta
- Protezione mandrino
- Paraspruzzi posteriore
- Torretta a cambio rapido tipo C
- Lampada a LED
- Sistema di raffreddamento
- Freno a pedale elettro-meccanico
- Carrello contropunta a bloccaggio rapido
- Ingranaggi del carro a bagno d'olio
- Piedini livellanti regolabili

Art.	T085F10	NEW	T085F	NEW	T085F20	NEW	T085F30	NEW
Altezza punte	280 mm		280 mm		280 mm		280 mm	
Diametro max sul banco	560 mm		560 mm		560 mm		560 mm	
Diametro max sul carro	360 mm		360 mm		360 mm		360 mm	
Diametro max sull'incavo	770 mm		770 mm		770 mm		770 mm	
Altezza utensile	32 mm		32 mm		32 mm		32 mm	
Distanza tra le punte	1000 mm		1500 mm		2000 mm		3000 mm	
Passaggio barra	105 mm		105 mm		105 mm		105 mm	
Attacco mandrino	Camlock D1-8		Camlock D1-8		Camlock D1-8		Camlock D1-8	
Velocità del mandrino	(12) 36 ÷ 1600 rpm		(12) 36 ÷ 1600 rpm		(12) 36 ÷ 1600 rpm		(12) 36 ÷ 1600 rpm	
Avanzamenti longitudinali	0,063 ÷ 2,52 mm/giro		0,063 ÷ 2,52 mm/giro		0,063 ÷ 2,52 mm/giro		0,063 ÷ 2,52 mm/giro	
Avanzamenti trasversali	0,027 ÷ 1,07 mm/giro		0,027 ÷ 1,07 mm/giro		0,027 ÷ 1,07 mm/giro		0,027 ÷ 1,07 mm/giro	
Filettature metriche	(22) 1 ÷ 14 mm		(22) 1 ÷ 14 mm		(22) 1 ÷ 14 mm		(22) 1 ÷ 14 mm	
Filettature in pollici	(26) 2 ÷ 28 TPI		(26) 2 ÷ 28 TPI		(26) 2 ÷ 28 TPI		(26) 2 ÷ 28 TPI	
Conicità contropunta CM	5		5		5		5	
Motore	400V 50/60 Hz 7,5 kW		400V 50 Hz 7,5 kW		400V 50/60 Hz 7,5 kW		400V 50/60 Hz 7,5 kW	
Pompa di refrigerazione	400V 50/60 Hz 90 W		400V 50 Hz 90 W		400V 50/60 Hz 90 W		400V 50/60 Hz 90 W	
Dimensioni	2500 x 1550 x 1700 mm		3000 x 1550 x 1700 mm		3500 x 1550 x 1700 mm		4500 x 1550 x 1700 mm	
Peso netto	3250 Kg		3560 kg		3950 Kg		4050 Kg	
€	€ 51400,00		€ 54000,00		€ 58100,00		€ 65500,00	



T080Fx FERVI plus
NEW
TORNIO PARALLELO CON FRIZIONE E VISUALIZZATORE

Con frizione meccanica, visualizzatore a 3 assi e scatola ingranaggi semi norton. Dotato di joystick per l'inserimento degli avanzamenti rapidi. Con basamento in monoblocco di ghisa. Disponibile anche in versione 60 Hz.

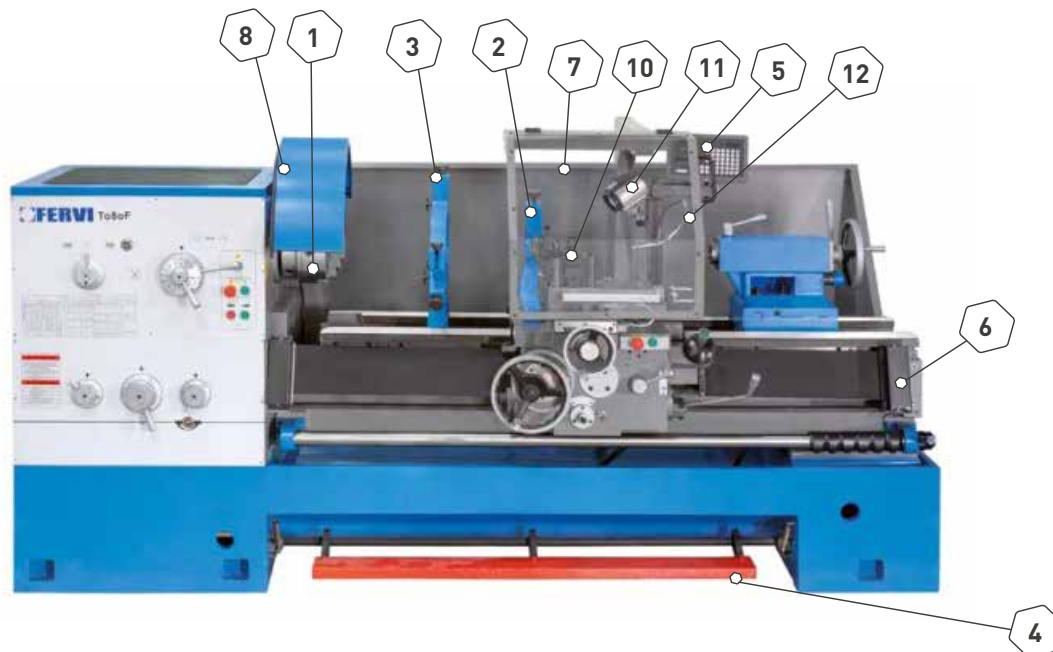

- 1** Mandrino autocentrante
3+3 Ø 250 mm
- 2** Lunetta mobile
- 3** Lunetta fissa
- 4** Freno a pedale
- 5** Visualizzatore a 3 assi

- 6** Protezione vite madre
- 7** Protezione torretta
- 8** Protezione mandrino
- 9** Paraspruzzi posteriore
- 10** Torretta a cambio rapido
- 11** Lampada
- 12** Sistema di raffreddamento

ACCESSORI INCLUSI

- Mandrino autocentrante a 3 griffe reversibili Ø 250 mm
- Piattaforma a 4 griffe indipendenti Ø 320 mm
- Bussola di riduzione CM 7/5
- Flangia menabrida Ø 400 mm
- Lunetta mobile
- Lunetta fissa
- 2 x Contropunta fissa CM 5
- Contropunta rotante CM 5
- Comparatore di filettatura
- Protezione vite madre
- Protezione torretta
- Protezione mandrino
- Paraspruzzi posteriore
- Torretta a cambio rapido tipo C
- Lampada a LED
- Sistema di raffreddamento
- Freno a pedale elettro-meccanico
- Carrello contropunta a bloccaggio rapido
- Ingranaggi del carro a bagno d'olio
- Piedini livellanti regolabili

Art.	T080F10 NEW	T080F	T080F20
Altezza punta	250 mm	250 mm	250 mm
Diametro max sul banco	500 mm	500 mm	500 mm
Diametro max sul carro	310 mm	310 mm	310 mm
Diametro max sull'incavo	720 mm	720 mm	720 mm
Altezza utensile	32 mm	32 mm	32 mm
Distanza tra le punte	1000 mm	1500 mm	2000 mm
Passaggio barra	80 mm	80 mm	80 mm
Attacco mandrino	Camlock D1-8	Camlock D1-8	Camlock D1-8
Velocità del mandrino	(12) 36 ÷ 1600 rpm	(12) 36 ÷ 1600 rpm	(12) 36 ÷ 1600 rpm
Avanzamenti longitudinali	0,063 ÷ 2,52 mm/giro	0,063 ÷ 2,52 mm/giro	0,063 ÷ 2,52 mm/giro
Avanzamenti trasversali	0,027 ÷ 1,07 mm/giro	0,027 ÷ 1,07 mm/giro	0,027 ÷ 1,07 mm/giro
Filettature metriche	(22) 1 ÷ 14 mm	(22) 1 ÷ 14 mm	(22) 1 ÷ 14 mm
Filettature in pollici	(26) 2 ÷ 28 TPI	(26) 2 ÷ 28 TPI	(26) 2 ÷ 28 TPI
Conicità contropunta CM	5	5	5
Motore	400V 50/60 Hz 7,5 kW	400V 50/60 Hz 7,5 kW	400V 50/60 Hz 7,5 kW
Pompa di refrigerazione	400V 50/60 Hz 90 W	400V 50/60 Hz 90 W	400V 50/60 Hz 90 W
Dimensioni	2500 x 1400 x 1500 mm	3000 x 1400 x 1500 mm	3500 x 1400 x 1500 mm
Peso netto	2840 Kg	3080 kg	3320 kg
€	€ 45200,00	€ 50580,00	€ 52730,00



T0751
€ 39370,00
TORNIO PARALLELO CON VISUALIZZATORE ED INVERTER

Visualizzatore a 3 assi con comando di variazione della velocità, scatola ingranaggi semi norton. Con basamento in monoblocco di ghisa. Il Visualizzatore-computer varia la velocità di rotazione in base al diametro tornito.

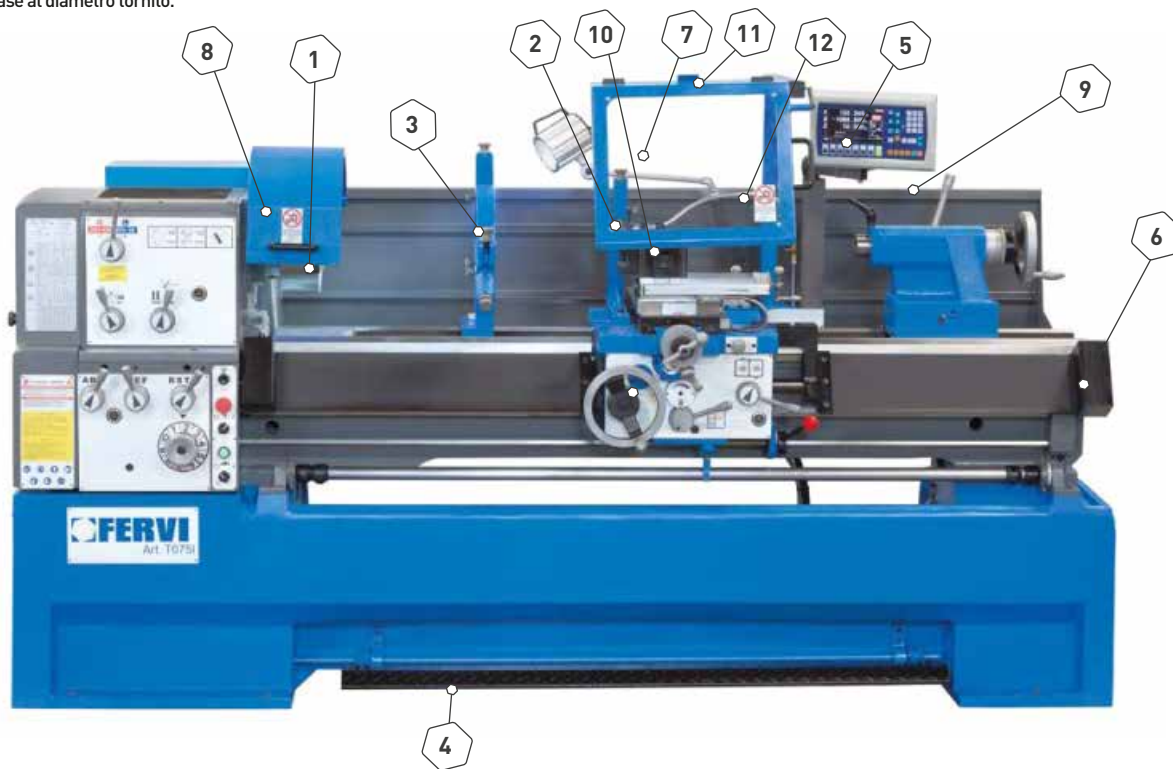

- 1** Mandrino autocentrante 3+3 Ø 250 mm
- 2** Lunetta mobile
- 3** Lunetta fissa
- 4** Freno a pedale
- 5** Visualizzatore a 3 assi
- 6** Protezione vite madre

- 7** Protezione torretta
- 8** Protezione mandrino
- 9** Paraspruzzi posteriore
- 10** Torretta a cambio rapido
- 11** Lampada LED
- 12** Sistema di raffreddamento

Altezza punta	230 mm
Diametro max sul banco	460 mm
Diametro max sul carro	270 mm
Diametro max sull'incavo	690 mm
Altezza utensile	25 mm
Distanza tra le punte	1500 mm
Passaggio barra	58 mm
Attacco mandrino	Camlock D1-6
Conicità passaggio barra CM	6
Velocità variabile del mandrino	[2] 30 ÷ 600 600 ÷ 2000 rpm
Avanzamenti longitudinali	0,014 ÷ 0,784 mm / giro
Avanzamenti trasversali	0,031 ÷ 1,7 mm/giro
Filettature metriche	0,1 ÷ 14 mm
Filettature in pollici	2 ÷ 112 TPI
Conicità contropunta CM	4
Motore	400V 50/60 Hz 5,5 kW
Pompa di refrigerazione	400V 50 Hz 90 W
Peso netto	1970 kg

ACCESSORI INCLUSI

- Mandrino autocentrante 3+3 Ø 250 mm
- Piattaforma a 4 griffe indipendenti Ø 250 mm
- Bussola di riduzione CM 6/4
- Flangia menabrida Ø 350 mm
- Lunetta mobile
- Lunetta fissa
- 2 x Contropunta fissa CM 4
- Contropunta rotante CM 4
- Comparatore di filettatura
- Protezione vite madre
- Protezione torretta
- Protezione mandrino
- Paraspruzzi posteriore
- Torretta a cambio rapido tipo B
- Lampada a LED
- Sistema di raffreddamento
- Freno a pedale elettromeccanico
- Carrello contropunta a bloccaggio rapido
- Ingranaggi del carro a bagno d'olio



T070/400V3A15
€ 17030,00
TORNIO PARALLELO CON VISUALIZZATORE

Con elettrofreno e motore a 2 velocità, visualizzatore a 3 assi e scatola ingranaggi semi norton. Barra di tornitura con frizione registrabile.

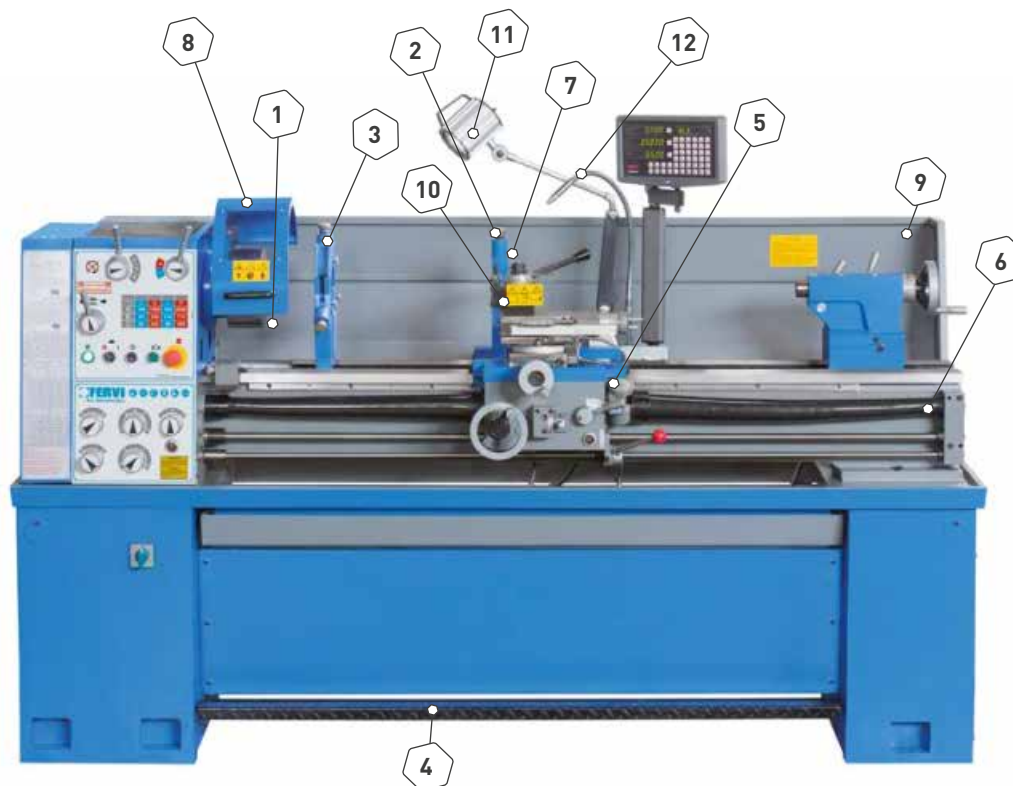

- 1 **Mandrino autocentrante 3+3 Ø 200 mm**
- 2 **Lunetta mobile**
- 3 **Lunetta fissa**
- 4 **Freno a pedale**
- 5 **Comparatore di filettatura**
- 6 **Protezione vite madre**

- 7 **Protezione torretta**
- 8 **Protezione mandrino**
- 9 **Paraspruzzi posteriore**
- 10 **Torretta a cambio rapido T0AB**
- 11 **Lampada**
- 12 **Sistema di raffreddamento**

Altezza punte	200 mm
Diametro max sul banco	400 mm
Diametro max sul carro	258 mm
Altezza utensile	20 mm
Distanza tra le punte	1500 mm
Passaggio barra	55 mm
Passaggio mandrino	50 mm
Attacco mandrino	Camlock D1-5
Conicità passaggio barra CM	6
Velocità del mandrino	(12) 45 ÷ 2000 rpm
Avanzamenti longitudinali	0,06 ÷ 2,78 mm / giro
Avanzamenti trasversali	0,01 ÷ 0,72 mm/giro
Filettature metriche	0,8 ÷ 14 mm
Filettature in pollici	2 ÷ 28 TPI
Conicità contropunta CM	4
Motore	400V 50 Hz 1,5 / 2,4 kW
Dimensioni	2360 x 760 x 1600 h mm
Peso netto	850 kg

ACCESSORI INCLUSI

- Mandrino autocentrante 3+3 Ø 200 mm
- Piattaforma a 4 griffe indipendenti Ø 200 mm
- Bussola di riduzione CM 6/4
- Flangia menabrida Ø 320 mm
- Lunetta mobile
- Lunetta fissa
- 2 x Contropunta fissa CM 4
- Contropunta rotante CM 4
- Comparatore di filettatura
- Protezione vite madre
- Protezione torretta
- Protezione mandrino
- Paraspruzzi posteriore
- Torretta a cambio rapido T0AB
- Lampada a LED
- Sistema di raffreddamento
- Freno a pedale
- Frizione su barra di tornitura
- Carrello contropunta a bloccaggio rapido
- Ingranaggi del carro a bagno d'olio



T070/400VI3A
€ 17480,00
TORNIO PARALLELO CON INVERTER E VISUALIZZATORE

Scatola ingranaggi semi norton e visualizzatore a 3 assi. Barra di tornitura con frizione registrabile e visualizzatore della velocità di rotazione.

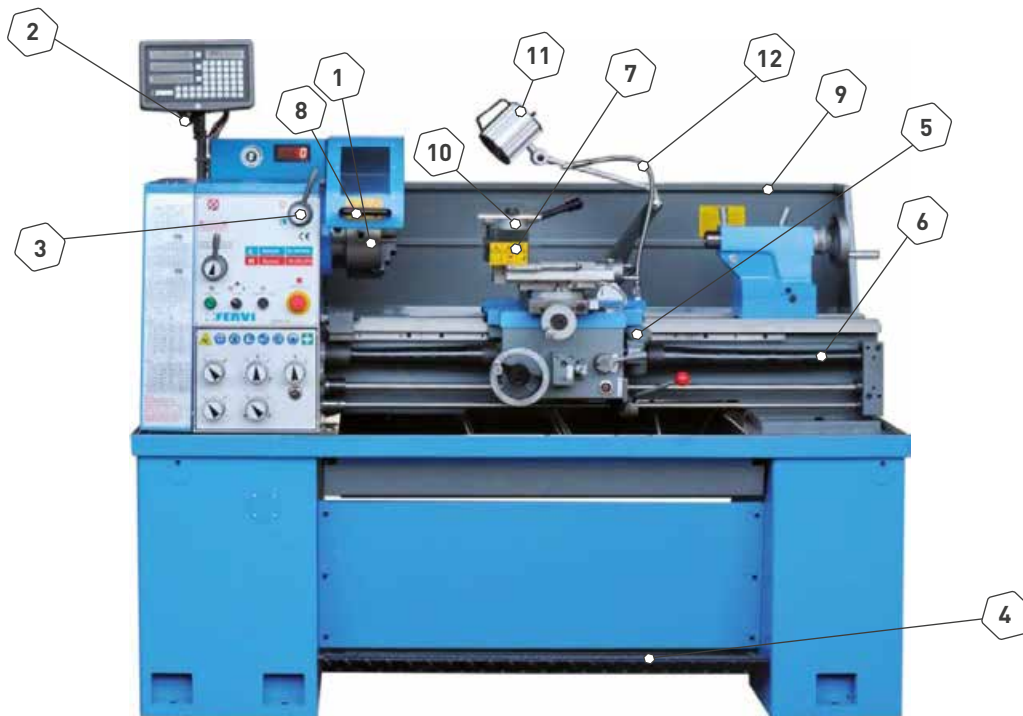

- 1** Mandrino autocentrante 3+3 Ø 200 mm
- 2** Visualizzatore a 3 assi
- 3** Selettore velocità
- 4** Freno a pedale
- 5** Comparatore di filettatura
- 6** Protezione vite madre

- 7** Protezione torretta
- 8** Protezione mandrino
- 9** Paraspruzzi posteriore
- 10** Torretta a cambio rapido T0AB
- 11** Lampada LED
- 12** Sistema di raffreddamento

Altezza punta	200 mm
Diametro max sul banco	400 mm
Diametro max sul carro	258 mm
Diametro max sull'incavo	550 mm
Altezza utensile	20 mm
Distanza tra le punte	1000 mm
Passaggio barra	55 mm
Passaggio mandrino	50 mm
Attacco mandrino	Camlock D1-5
Conicità passaggio barra CM	6
Velocità variabile del mandrino	(2) 50 ÷ 1000 50 ÷ 2000 rpm
Avanzamenti longitudinali	0,06 ÷ 2,78 mm / giro
Avanzamenti trasversali	0,01 ÷ 0,72 mm/giro
Filettature metriche	0,8 ÷ 14 mm
Filettature in pollici	2 ÷ 28 TPI
Conicità contropunta CM	4
Motore	400V 50 Hz 2,2 kW
Dimensioni	1860 x 900 x 1650 h mm
Peso netto	780 kg

ACCESSORI INCLUSI

- Mandrino autocentrante 3+3 Ø 200 mm
- Piattaforma a 4 griffe indipendenti Ø 200 mm
- Bussola di riduzione CM 6/4
- Flangia menabrida Ø 320 mm
- Lunetta mobile
- Lunetta fissa
- 2 x Contropunta fissa CM 4
- Contropunta rotante CM 4
- Comparatore di filettatura
- Protezione vite madre
- Protezione torretta
- Protezione mandrino
- Paraspruzzi posteriore
- Torretta a cambio rapido T0AB
- Lampada
- Sistema di raffreddamento
- Frizione su barra di tornitura
- Freno a pedale
- Carrello contropunta a bloccaggio rapido
- Ingranaggi del carro a bagno d'olio



T070/400V3A FERVIplus
€ 15780,00
TORNIO PARALLELO CON VISUALIZZATORE

Con elettrofreno e motore a 2 velocità, visualizzatore a 3 assi. Barra di tornitura con frizione registrabile.

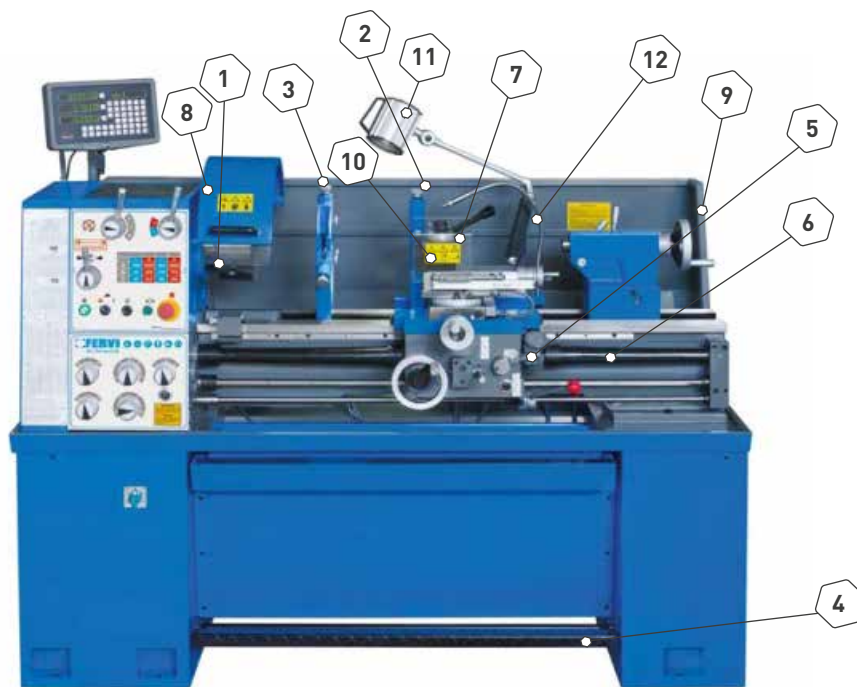

- 1** Mandrino autocentrante 3+3 Ø 200 mm
- 2** Lunetta mobile
- 3** Lunetta fissa
- 4** Freno a pedale
- 5** Comparatore di filettatura
- 6** Protezione vite madre

- 7** Protezione torretta
- 8** Protezione mandrino
- 9** Paraspruzzi posteriore
- 10** Torretta a cambio rapido T0AB
- 11** Lampada LED
- 12** Sistema di raffreddamento

Altezza punte	200 mm
Diametro max sul banco	400 mm
Diametro max sul carro	258 mm
Diametro max sull'incavo	550 mm
Altezza utensile	20 mm
Distanza tra le punte	1000 mm
Passaggio barra	55 mm
Passaggio mandrino	50 mm
Attacco mandrino	Camlock D1-5
Conicità passaggio barra CM	6
Velocità del mandrino	[12] 45 ÷ 2000 rpm
Avanzamenti longitudinali	0,06 ÷ 2,78 mm / giro
Avanzamenti trasversali	0,01 ÷ 0,72 mm/giro
Filettature metriche	0,8 ÷ 14 mm
Filettature in pollici	2 ÷ 28 TPI
Conicità contropunta CM	4
Motore	400V 50 Hz 1,5 / 2,4 kW
Dimensioni	1860 x 800 x 1600 h mm
Peso netto	760 kg

ACCESSORI INCLUSI

- Mandrino autocentrante 3+3 Ø 200 mm
- Piattaforma a 4 griffe indipendenti Ø 200 mm
- Bussola di riduzione CM 6/4
- Flangia menabrida Ø 320 mm
- Lunetta mobile
- Lunetta fissa
- 2 x Contropunta fissa CM 4
- Contropunta rotante CM 4
- Comparatore di filettatura
- Protezione vite madre
- Protezione torretta
- Protezione mandrino
- Paraspruzzi posteriore
- Torretta a cambio rapido T0AB
- Lampada a LED
- Sistema di raffreddamento
- Freno a pedale
- Frizione su barra di tornitura
- Carrello contropunta a bloccaggio rapido
- Ingranaggi del carro a bagno d'olio



T069/400VI3A
€ 14260,00
TORNIO PARALLELO CON INVERTER E VISUALIZZATORE

Scatola ingranaggi semi norton e visualizzatore a 3 assi. Barra di tornitura con frizione registrabile e visualizzatore della velocità di rotazione.

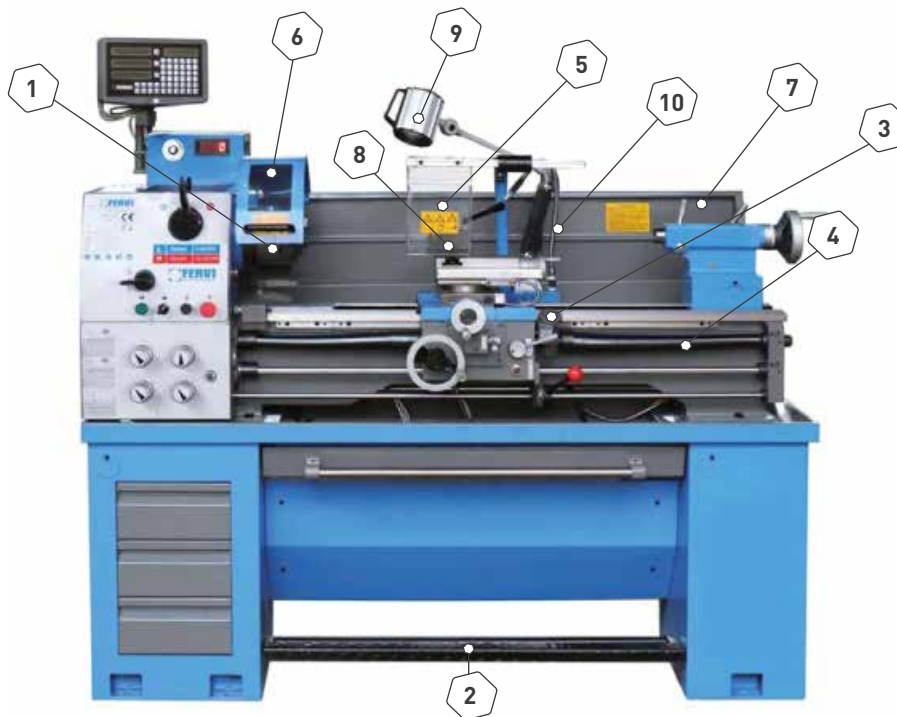

- 1** Mandrino autocentrante 3+3 Ø 200 mm
- 2** Freno a pedale
- 3** Comparatore di filettatura
- 4** Protezione vite madre
- 5** Protezione torretta

- 6** Protezione mandrino
- 7** Paraspruzzi posteriore
- 8** Torretta a cambio rapido TOAE
- 9** Lampada LED
- 10** Sistema di raffreddamento

Altezza punta	190 mm
Diametro max sul banco	380 mm
Diametro max sul carro	225 mm
Diametro max sull'incavo	503 mm
Altezza utensile	20 mm
Distanza tra le punte	1000 mm
Passaggio barra	51 mm
Attacco mandrino	Camlock D1-5
Conicità passaggio barra CM	6
Velocità variabile del mandrino	(2) 70 ÷ 400 50 ÷ 2000 rpm
Avanzamenti longitudinali	0,052 - 1,392 mm / giro
Avanzamenti trasversali	0,014 - 0,380 mm/giro
Filettature metriche	0,4 - 7 mm
Filettature in pollici	4 - 56 TPI
Conicità contropunta CM	4
Motore	400V 50 Hz 1,5 kW
Dimensioni	1820 x 90 x 1650 h mm
Peso netto	645 kg

ACCESSORI INCLUSI

- Mandrino autocentrante 3+3 Ø 200 mm
- Mandrino a 4 griffe indipendenti reversibili Ø 200 mm
- Bussola di riduzione CM 6/4
- Flangia Ø 320 mm
- Lunetta mobile
- Lunetta fissa
- 2 x Contropunta fissa CM 4
- Contropunta rotante CM 4
- Comparatore di filettatura
- Protezione vite madre
- Protezione torretta
- Protezione mandrino
- Paraspruzzi posteriore
- Torretta a cambio rapido TOAE
- Lampada
- Sistema di raffreddamento
- Freno a pedale
- Frizione su barra di tornitura
- Carrello contropunta a bloccaggio rapido
- Ingranaggi del carro a bagno d'olio



T069/400V3A FERVIplus
€ 12870,00
TORNIO PARALLELO CON VISUALIZZATORE

Visualizzatore a 3 assi e scatola ingranaggi semi norton. Barra di tornitura con frizione registrabile.

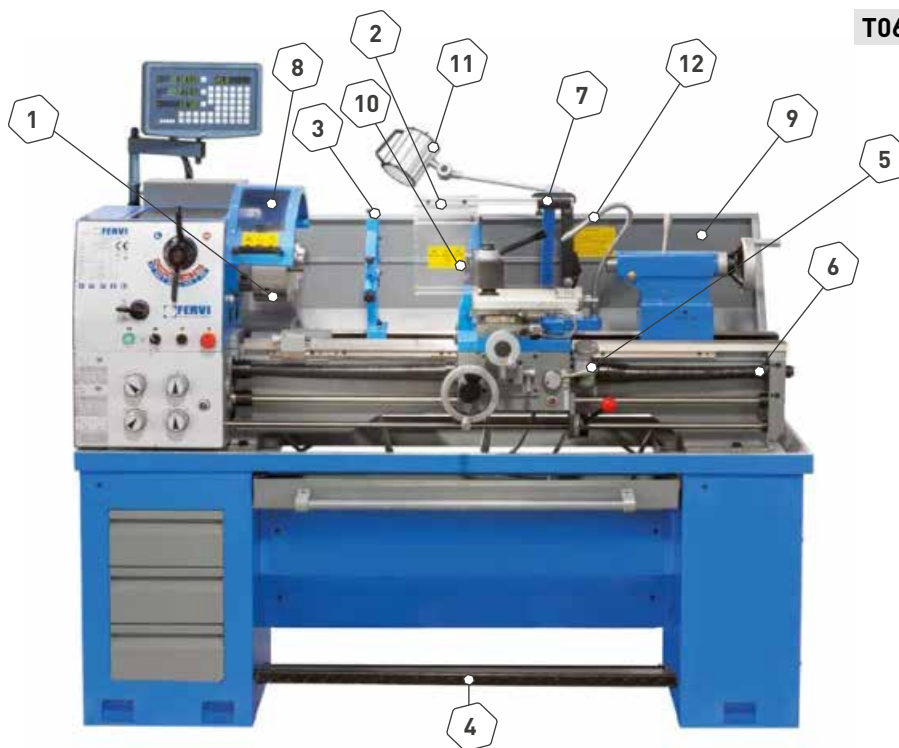
T069/400V € 11730,00
SENZA VISUALIZZATORE

- 1** Mandrino autocentrante 3+3 Ø 200 mm
- 2** Lunetta mobile
- 3** Lunetta fissa
- 4** Freno a pedale
- 5** Comparatore di filettatura
- 6** Protezione vite madre

- 7** Protezione torretta
- 8** Protezione mandrino
- 9** Paraspruzzi posteriore
- 10** Torretta a cambio rapido T0AE
- 11** Lampada LED
- 12** Sistema di raffreddamento

Altezza punta	200 mm
Diametro max sul banco	400 mm
Diametro max sul carro	258 mm
Diametro max sull'incavo	550 mm
Altezza utensile	20 mm
Distanza tra le punte	1000 mm
Passaggio barra	55 mm
Passaggio mandrino	50 mm
Attacco mandrino	Camlock D1-5
Conicità passaggio barra CM	6
Velocità del mandrino	(12) 45 ÷ 2000 rpm
Avanzamenti longitudinali	0,06 ÷ 2,78 mm / giro
Avanzamenti trasversali	0,01 ÷ 0,72 mm/giro
Filettature metriche	0,8 ÷ 14 mm
Filettature in pollici	2 ÷ 28 TPI
Conicità contropunta CM	4
Motore	400V 50 Hz 1,5 / 2,4 kW
Dimensioni	1860 x 800 x 1600 h mm
Peso netto	760 kg

ACCESSORI INCLUSI

- Mandrino autocentrante 3+3 Ø 200 mm
- Mandrino a 4 griffe indipendenti reversibili Ø 200 mm
- Bussola di riduzione CM 6/4
- Flangia menabrida Ø 320 mm
- Lunetta mobile
- Lunetta fissa
- 2 x Contropunta fissa CM 4
- Contropunta rotante CM 4
- Comparatore di filettatura
- Protezione vite madre
- Protezione torretta
- Protezione mandrino
- Paraspruzzi posteriore
- Torretta a cambio rapido T0AE
- Lampada a LED
- Sistema di raffreddamento
- Freno a pedale
- Frizione su barra di tornitura
- Carrello contropunta a bloccaggio rapido
- Ingranaggi del carro a bagno d'olio



T998/400VI3A
€ 13050,00
TORNO PARALLELO CON INVERTER E VISUALIZZATORE

Scatola ingranaggi semi norton e visualizzatore a 3 assi. Barra di tornitura con frizione registrabile e visualizzatore della velocità di rotazione.

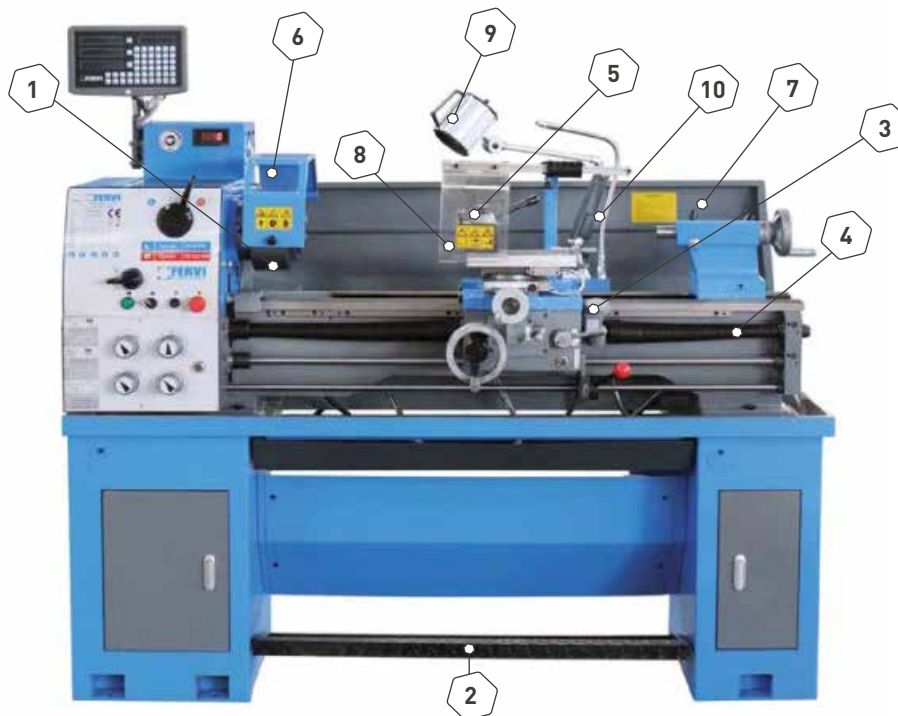
1 Mandrino autocentrante 3+3 Ø 200 mm

2 Freno a pedale

3 Comparatore di filettatura

4 Protezione vite madre

5 Protezione torretta

6 Protezione mandrino

7 Paraspruzzi posteriore

8 Torretta a cambio rapido T0AE

9 Lampada LED

10 Sistema di raffreddamento

Altezza punte	160 mm
Diametro max sul banco	320 mm
Diametro max sul carro	198 mm
Diametro max sull'incavo	470 mm
Altezza utensile	20 mm
Distanza tra le punte	1000 mm
Passaggio barra	51 mm
Attacco mandrino	Camlock D1-5
Conicità passaggio barra CM	5
Velocità variabile del mandrino	(2) 70 ÷ 400 350 ÷ 2000 rpm
Avanzamenti longitudinali	0.052 ÷ 1.392 mm / giro
Avanzamenti trasversali	0.009 ÷ 0.253 mm/giro
Filettature metriche	0,4 ÷ 7 mm
Filettature in pollici	4 ÷ 56 TPI
Conicità contropunta CM	3
Motore	400V 50 Hz 1,5 kW
Dimensioni	1820 x 900 x 1650 h mm
Peso netto	635 kg

ACCESSORI INCLUSI

- Mandrino autocentrante 3+3 Ø 200 mm
- Mandrino a 4 griffe indipendenti reversibili Ø 200 mm
- Bussola di riduzione CM 5/3
- Flangia Ø 250 mm
- Lunetta mobile
- Lunetta fissa
- 2 x Contropunta fissa CM 3
- Contropunta rotante CM 3
- Comparatore di filettatura
- Protezione vite madre
- Protezione torretta
- Protezione mandrino
- Paraspruzzi posteriore
- Torretta a cambio rapido T0AE
- Lampada
- Sistema di raffreddamento
- Frizione su barra di tornitura
- Freno a pedale elettromeccanico
- Carrello contropunta a bloccaggio rapido
- Ingranaggi del carro a bagno d'olio



T998/230V3A & T998/400V3A FERVIplus
€ 11630,00
TORNIO PARALLELO CON VISUALIZZATORE

Visualizzatore a 3 assi, scatola ingranaggi semi norton. Barra di tornitura con frizione registrabile.

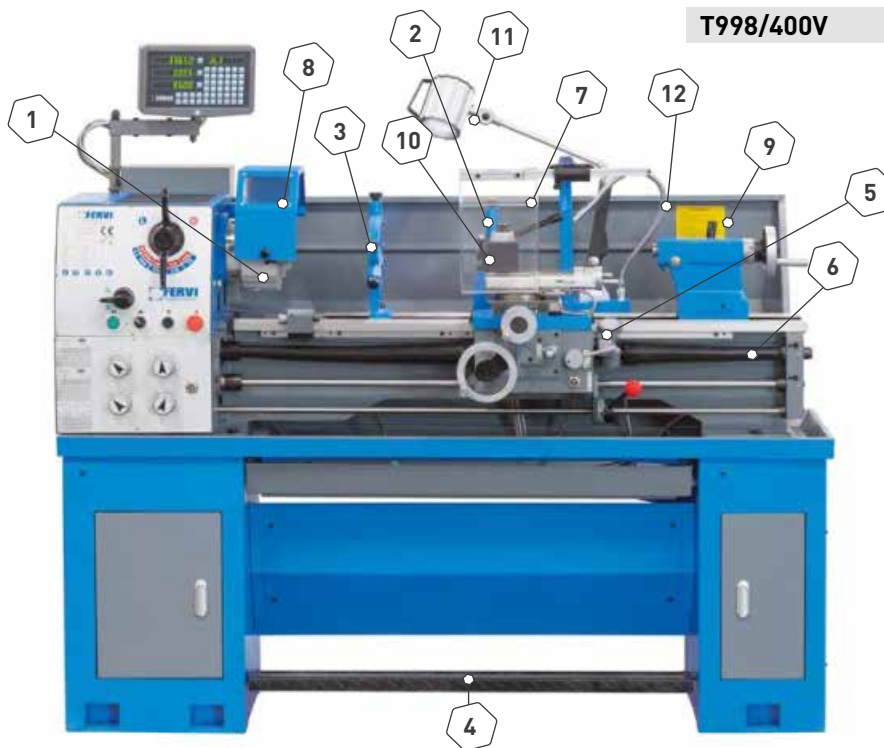
T998/400V
€ 10530,00
SENZA VISUALIZZATORE

- 1** Mandrino autocentrante 3+3 Ø 200 mm
- 2** Lunetta mobile
- 3** Lunetta fissa
- 4** Freno a pedale
- 5** Comparatore di filettatura
- 6** Protezione vite madre

- 7** Protezione torretta
- 8** Protezione mandrino
- 9** Paraspruzzi posteriore
- 10** Torretta a cambio rapido T0AE
- 11** Lampada LED
- 12** Sistema di raffreddamento

Altezza punta	160 mm
Diametro max sul banco	320 mm
Diametro max sul carro	198 mm
Diametro max sull'incavo	470 mm
Altezza utensile	20 mm
Distanza tra le punte	1000 mm
Passaggio barra	51 mm
Attacco mandrino	Camlock D1-5
Conicità passaggio barra CM	5
Velocità del mandrino	(8) 70 ÷ 2000 rpm
Avanzamenti longitudinali	0.052 ÷ 1.392 mm / giro
Avanzamenti trasversali	0.009 ÷ 0.253 mm/giro
Filettature metriche	0,4 ÷ 7 mm
Filettature in pollici	4 ÷ 56 TPI
Conicità contropunta CM	3
Motore	230 V 50 Hz 1,8 kW
Dimensioni	1820 x 800 x 1320 h mm
Peso netto	630 kg

ACCESSORI INCLUSI

- Mandrino autocentrante 3+3 Ø 200 mm
- Mandrino a 4 griffe indipendenti reversibili Ø 200 mm
- Bussola di riduzione CM 5/3
- Flangia menabrida Ø 250 mm
- Lunetta mobile
- Lunetta fissa
- 2 x Contropunta fissa CM 3
- Contropunta rotante CM 3
- Freno a pedale elettromeccanico
- Comparatore di filettatura
- Protezione vite madre
- Protezione torretta
- Protezione mandrino
- Paraspruzzi posteriore
- Torretta a cambio rapido T0AE
- Lampada
- Sistema di raffreddamento
- Frizione su barra di tornitura
- Carrello contropunta a bloccaggio rapido
- Ingranaggi del carro a bagno d'olio



T997/230VI3A

 € 11150,00 **NEW**
TORNIO PARALLELO CON INVERTER E VISUALIZZATORE

Scatola ingranaggi semi norton e visualizzatore a 3 assi. Barra di tornitura con frizione registrabile e visualizzatore della velocità di rotazione.

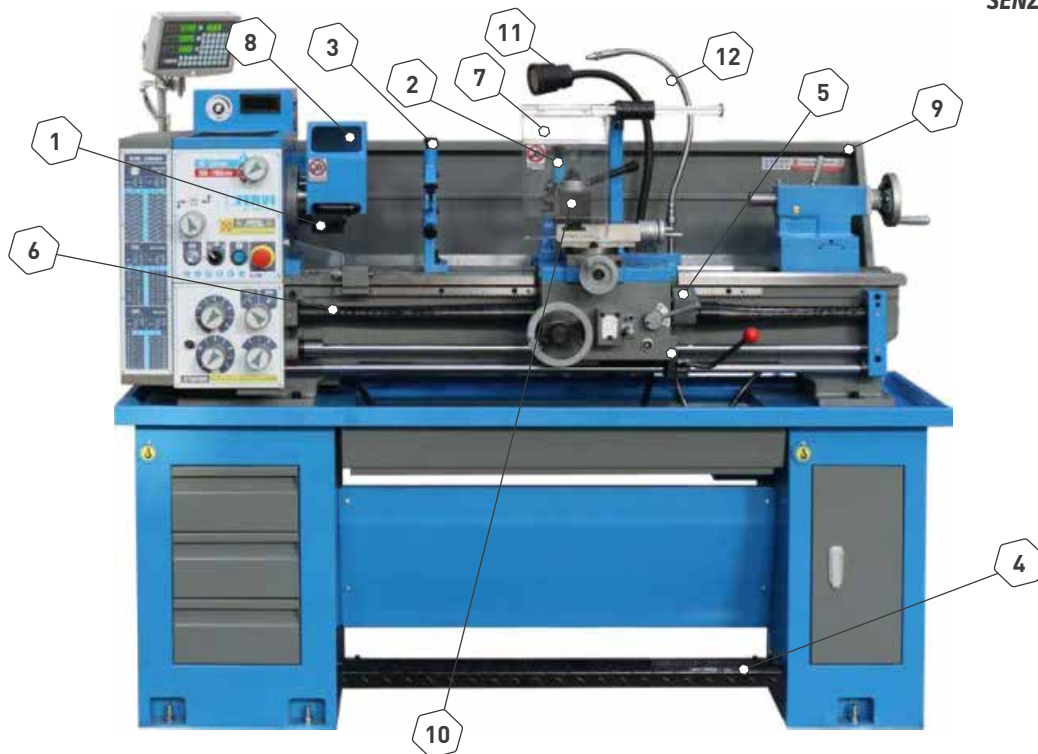
T997/230VI € 10000,00
SENZA VISUALIZZATORE

1 Mandrino autocentrante 3+3 Ø 200 mm

2 Lunetta mobile

3 Lunetta fissa

4 Freno a pedale

5 Comparatore di filettatura

6 Protezione vite madre

7 Protezione torretta

8 Protezione mandrino

9 Paraspruzzi posteriore

10 Torretta a cambio rapido T0AE

11 Lampada LED

12 Sistema di raffreddamento

Altezza punta	160 mm
Diametro max sul banco	320 mm
Diametro max sul carro	180 mm
Altezza utensile	16 mm
Distanza tra le punte	1000 mm
Conicità passaggio barra CM	5
Passaggio barra	38 mm
Attacco mandrino	Camlock D1-4
Velocità del mandrino	(3) 60-1750 rpm
Avanzamenti longitudinali	(40) 0,053 - 1,291 mm/giro
Avanzamenti trasversali	(40) 0,011 - 0,275 mm/giro
Filettature metriche	(32) 0,4 - 7 mm
Filettature in pollici	(36) 4 - 60 TPI
Conicità contropunta CM	3
Motore	230 V 50/60 Hz 1.5 kW
Dimensioni	1850 x 700 x 1550 mm
Peso netto	550 Kg

ACCESSORI INCLUSI

- Mandrino autocentrante 3+3 Ø 160 mm
- Piattaforma a 4 griffe indipendenti Ø 200 mm con perni
- Flangia menabrida Ø 250 mm
- Lunetta mobile
- Lunetta fissa
- Bussola di riduzione CM 5/3
- Contropunta fissa CM 3
- Contropunta fissa CM 5
- Contropunta rotante CM 3
- Freno a pedale elettromeccanico
- Comparatore di filettatura
- Protezione vite madre
- Protezione torretta
- Protezione mandrino
- Paraspruzzi posteriore
- Torretta a cambio rapido T0AE
- Lampada a LED
- Carrello contropunta a bloccaggio rapido
- Sistema di raffreddamento
- Frizione su barra di tornitura
- Ingranaggi del carro a bagno d'olio



T997/400V3A & T997/230V3A
€ 9750,00 NEW
TORNIO PARALLELO CON VISUALIZZATORE

Visualizzatore a 3 assi, scatola ingranaggi semi norton. Barra di tornitura con frizione registrabile.

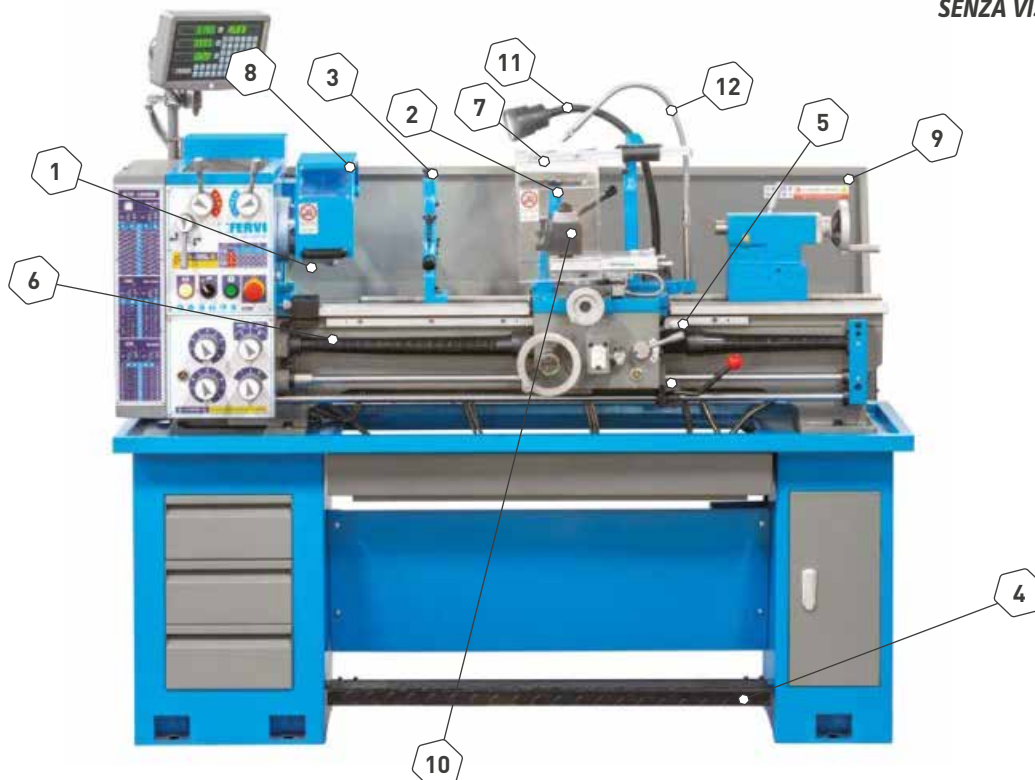
T997/400V & T997/230V € 8600,00
SENZA VISUALIZZATORE

- 1 **Mandrino autocentrante 3+3 Ø 160 mm**
- 2 **Lunetta mobile**
- 3 **Lunetta fissa**
- 4 **Freno a pedale**
- 5 **Comparatore di filettatura**
- 6 **Protezione vite madre**

- 7 **Protezione torretta**
- 8 **Protezione mandrino**
- 9 **Paraspruzzi posteriore**
- 10 **Torretta a cambio rapido T0AE**
- 11 **Lampada LED**
- 12 **Sistema di raffreddamento**

Altezza punta	160 mm
Diametro max sul banco	320 mm
Diametro max sul carro	180 mm
Altezza utensile	16 mm
Distanza tra le punte	1000 mm
Conicità passaggio barra CM	5
Passaggio barra	38 mm
Attacco mandrino	Camlock D1-4
Velocità del mandrino	(18) 75-1800 rpm
Avanzamenti longitudinali	(40) 0,053 - 1,291 mm/giro
Avanzamenti trasversali	(40) 0,011 - 0,275 mm/giro
Filettature metriche	(32) 0,4 - 7 mm
Filettature in pollici	(36) 4 - 60 TPI
Conicità contropunta CM	3
Motore	400 V 50/60 Hz 1.1 kW
Dimensioni	1850 x 700 x 1550 mm
Peso netto	550 Kg

ACCESSORI INCLUSI

- Mandrino autocentrante 3+3 Ø 160 mm
- Piattaforma a 4 griffe indipendenti Ø 200 mm con perni
- Flangia menabrida Ø 250 mm
- Lunetta mobile
- Lunetta fissa
- Bussola di riduzione CM 5/3
- Contropunta fissa CM 3
- Contropunta fissa CM 5
- Contropunta rotante CM 3
- Freno a pedale elettromeccanico
- Comparatore di filettatura
- Protezione vite madre
- Protezione torretta
- Protezione mandrino
- Paraspruzzi posteriore
- Torretta a cambio rapido T0AE
- Lampada a LED
- Carrello contropunta a bloccaggio rapido
- Sistema di raffreddamento
- Frizione su barra di tornitura
- Ingranaggi del carro a bagno d'olio



T940/230VI
€ 9690,00
TORNIO PARALLELO CON INVERTER

Scatola ingranaggi semi norton. Barra di tornitura con frizione registrabile e visualizzatore della velocità di rotazione.

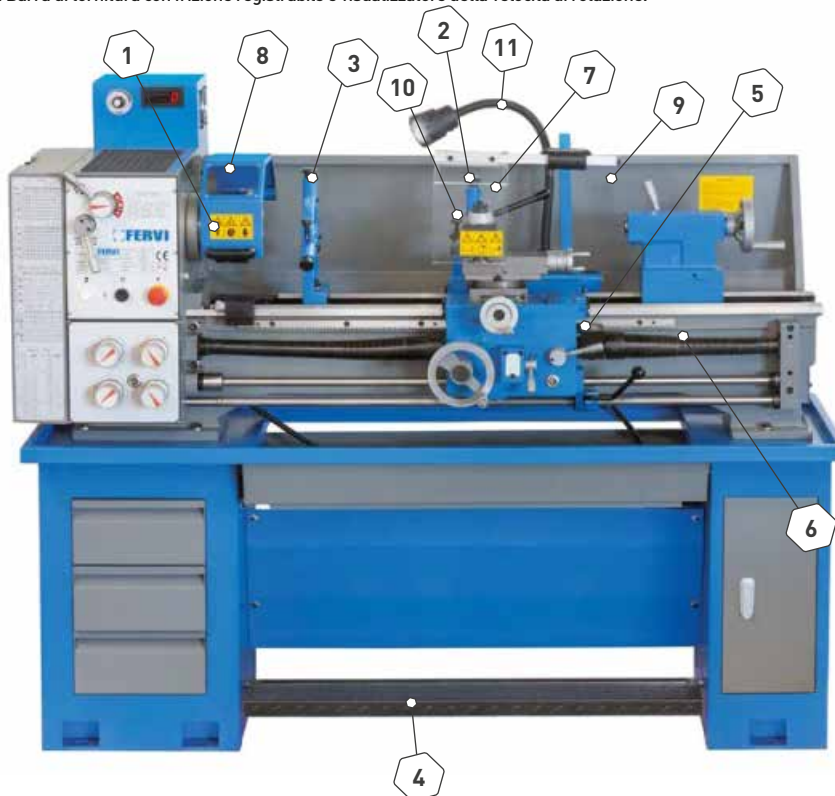

- 1** Mandrino autocentrante 3+3 Ø 160 mm
- 2** Lunetta mobile
- 3** Lunetta fissa
- 4** Freno a pedale
- 5** Comparatore di filettatura

- 6** Protezione vite madre
- 7** Protezione torretta
- 8** Protezione mandrino
- 9** Paraspruzzi posteriore
- 10** Torretta a cambio rapido T0AE
- 11** Lampada

Altezza punte	160 mm
Diametro max sul banco	320 mm
Diametro max sul carro	180 mm
Altezza utensile	16 mm
Distanza tra le punte	940 mm
Conicità passaggio barra CM	5
Passaggio barra	38 mm
Attacco mandrino	Camlock D1-4
Velocità variabile del mandrino	65 ÷ 1750 rpm
Avanzamenti longitudinali	0,053 ÷ 1,291 mm / giro
Avanzamenti trasversali	0,011 ÷ 0,276 mm/giro
Filettature metriche	0,4 ÷ 7 mm
Filettature in pollici	4 ÷ 60 TPI
Conicità contropunta CM	3
Motore	230 V 50/60 Hz 1.5 kW
Dimensioni	1770 x 1400 x 670 mm
Peso netto	525 kg

ACCESSORI INCLUSI

- Mandrino autocentrante 3+3 Ø 160 mm
- Mandrino a 4 griffe indipendenti reversibili Ø 200 mm
- Bussola di riduzione CM 5/3
- Flangia menabrida Ø 240 mm
- Flangia Ø 200 mm
- Lunetta mobile
- Lunetta fissa
- Contropunta fissa CM 3
- Contropunta fissa CM 5
- Contropunta rotante CM 3
- Freno a pedale
- Comparatore di filettatura
- Protezione vite madre
- Protezione torretta
- Protezione mandrino
- Paraspruzzi posteriore
- Torretta a cambio rapido T0AE
- Lampada a LED
- Carrello contropunta a bloccaggio rapido
- Ingranaggi del carro a bagno d'olio

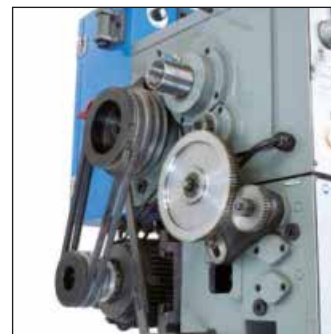

T940/230V
€ 8210,00
TORNIO PARALLELO

Scatola ingranaggi semi norton.

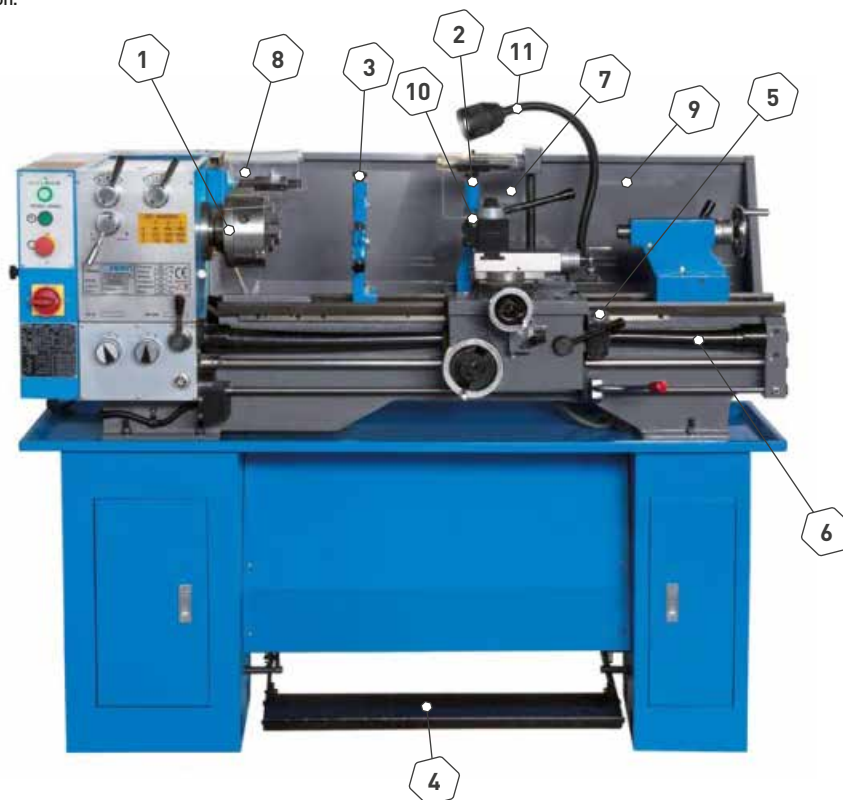
1 Mandrino autocentrante 3+3 Ø 160 mm

2 Lunetta mobile

3 Lunetta fissa

4 Freno a pedale

5 Comparatore di filettatura

6 Protezione vite madre

7 Protezione torretta

8 Protezione mandrino

9 Paraspruzzi posteriore

10 Torretta a cambio rapido T0AE

11 Lampada

Altezza punta	150 mm
Diametro max sul banco	300 mm
Diametro max sull'incavo	480 mm
Diametro max sul carro	173 mm
Altezza utensile	16 mm
Distanza tra le punte	940 mm
Passaggio barra	38 mm
Conicità passaggio barra CM	5
Velocità del mandrino	[9] 64 ÷ 1500 rpm
Avanzamenti longitudinali	0,051 ÷ 0,303 mm / giro
Avanzamenti trasversali	0,051 ÷ 0,303 mm/giro
Filettature metriche	0,5 ÷ 3,5 mm
Filettature in pollici	7,5 ÷ 48 TPI
Conicità contropunta CM	3
Motore	230 V 50 Hz 1,5 kW
Dimensioni	600 x 1600 x 1270 h mm
Peso netto	520 kg

ACCESSORI INCLUSI

- Mandrino autocentrante 3+3 Ø 160 mm
- Mandrino a 4 griffe indipendenti reversibili Ø 200 mm
- Bussola di riduzione CM 5/3
- Flangia menabrida Ø 240 mm
- Flangia Ø 200 mm
- Lunetta mobile
- Lunetta fissa
- Contropunta fissa CM 3
- Contropunta fissa CM 5
- Contropunta rotante CM 3
- Freno a pedale
- Comparatore di filettatura
- Protezione vite madre
- Protezione torretta
- Protezione mandrino
- Paraspruzzi posteriore
- Torretta a cambio rapido T0AE
- Lampada a LED
- Carrello contropunta a bloccaggio rapido
- Ingranaggi del carro a bagno d'olio



TORNI

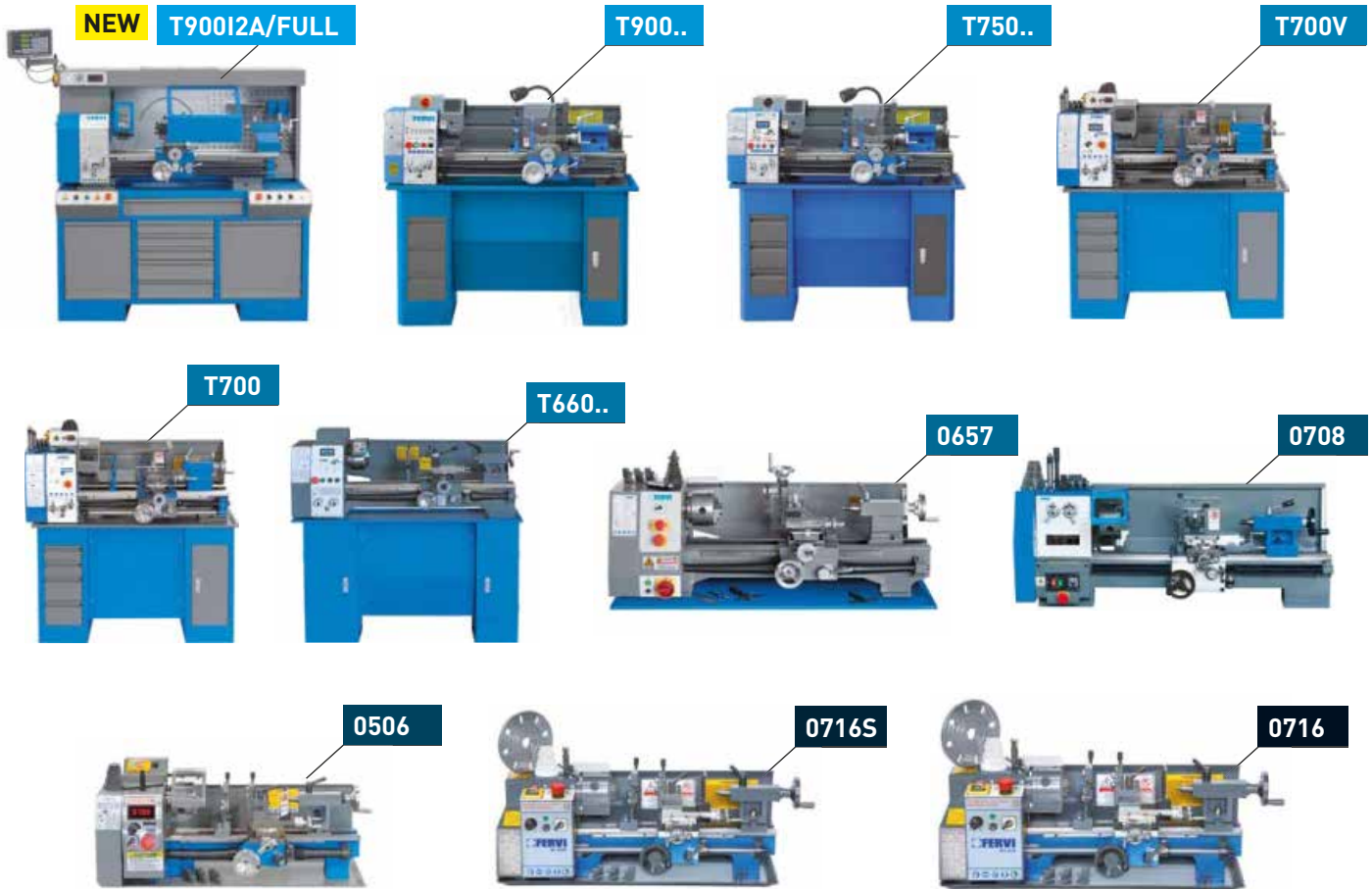

Diametro mandrino (mm)

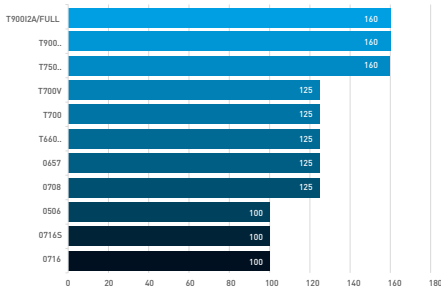

Potenza (W)

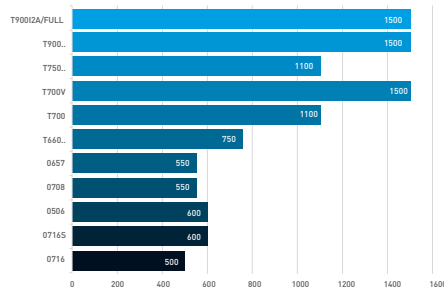

Diametro max sul carro (mm)

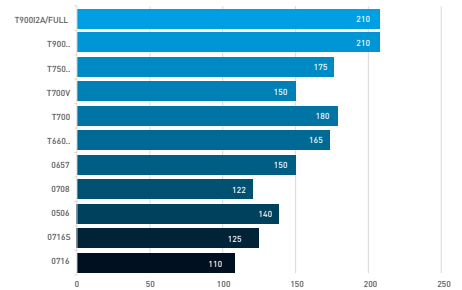

Altezza punte (mm)

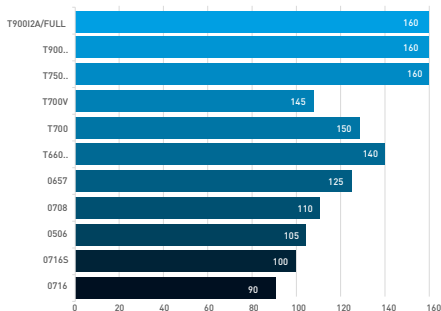

Distanza punte (mm)

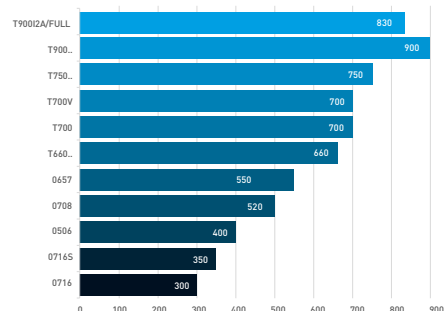

Passaggio barra (mm)

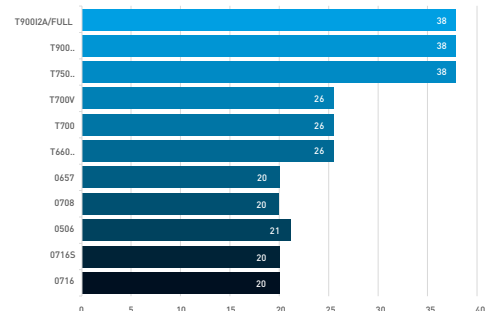

T900I2A/FULL
€ 13170,00 **NEW**
TORNIO PARALLELO CON INVERTER E VISUALIZZATORE

Con scatola ingranaggi semi norton, trasmissione a cinghia, avanzamenti longitudinali, trasversali, barra di tornitura, banco con cassette, armadietto e completo di accessori. Barra di tornitura con frizione registrabile.

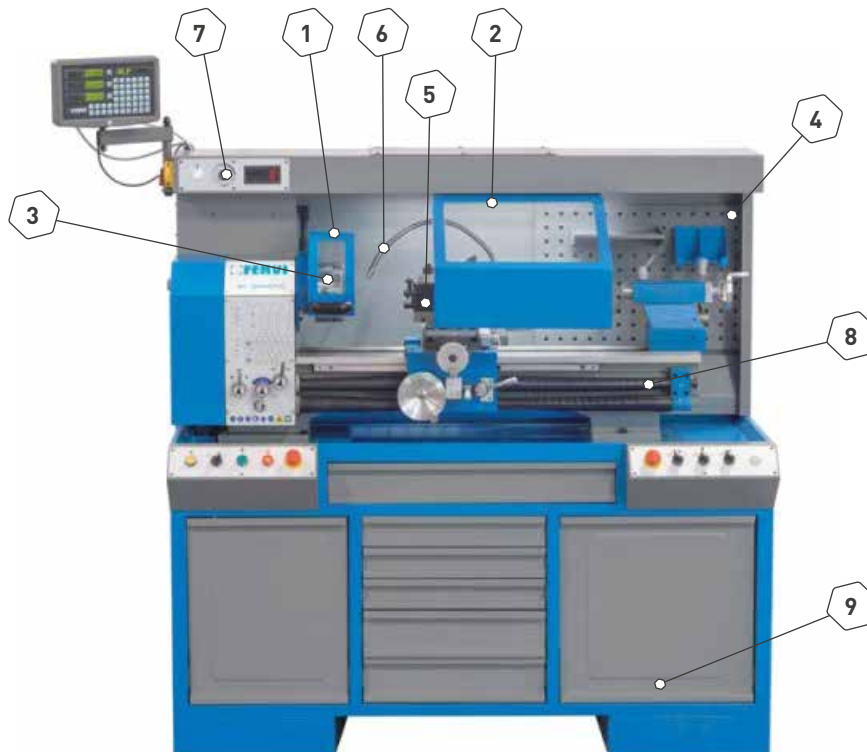
1 Protezione mandrino

2 Protezione torretta

3 Mandrino autocentrante 3+3+3 Ø 160 mm

4 Paraspruzzi posteriore

5 Torretta a cambio rapido T0AE

6 Sistema di raffreddamento

7 Regolatore di velocità

8 Protezione vite madre

9 Alloggio pompa

Altezza punta	160 mm
Diametro max sul banco	320 mm
Diametro max sul carro	210 mm
Altezza utensile	20 mm
Distanza tra le punte	830 mm
Passaggio barra	38 mm
Attacco mandrino	Camlock D1-4
Conicità passaggio barra CM	5
Velocità variabile del mandrino	60 ÷ 1600 rpm
Avanzamenti longitudinali	0,085 ÷ 0,832 mm / giro
Avanzamenti trasversali	0,01 ÷ 0,10 mm/giro
Filettature metriche	(18) 0,2 ÷ 3,5 mm
Filettature in pollici	(21) 8 ÷ 48 TPI
Conicità contropunta CM	3
Motore	230 V 50/60 Hz 1,5 kW
Dimensioni	1550 x 660 x 1790 mm
Peso netto	500 kg

ACCESSORI INCLUSI

- Mandrino autocentrante 3+3+3 Ø 160 mm
- Mandrino a 4 griffe indipendenti reversibili Ø 160 mm
- Flangia menabrida Ø 240 mm
- Flangia per mandrino a 4 griffe Ø 160 mm
- Lunetta mobile
- Lunetta fissa
- Contropunta fissa CM 3
- Contropunta fissa CM 5
- Contropunta rotante CM3
- Mandrino autoserrante con attacco CM 3
- Frizione su barra di tornitura
- Elettrofreno negativo a selettore
- Protezione vite madre
- Protezione torretta scorrevole
- Protezione mandrino con micro di sicurezza
- Paraspruzzi posteriore
- Torretta a cambio rapido T0AE
- Lampada a LED
- Carrello contropunta a bloccaggio rapido
- Impianto di refrigerazione con pompa in cassetto scorrevole
- Cassetti con spugna ed accessori inclusi
- Set 7 Pcs utensili 20 mm con inserti da tornitura



T900I
€ 7750,00
TORNIO PARALLELO CON INVERTER

Con scatola ingranaggi semi norton, trasmissione a cinghia, avanzamenti longitudinali, trasversali, barra di tornitura, banco parzialmente assemblato con 3 cassette e armadietto. Barra di tornitura con frizione registrabile.

ACCESSORI INCLUSI

- Mandrino autocentrante 3+3 Ø 160 mm
- Mandrino a 4 griffe indipendenti reversibili Ø 160 mm
- Flangia menabrida Ø 240 mm
- Flangia per mandrino a 4 griffe Ø 160 mm
- Lunetta mobile
- Lunetta fissa
- Contropunta fissa CM 3
- Contropunta fissa CM 5
- Frizione su barra di tornitura
- Comparatore di filettatura
- Protezione vite madre
- Protezione torretta con micro di sicurezza
- Protezione mandrino con micro di sicurezza
- Paraspruzzi posteriore
- Torretta a cambio rapido T0AE
- Lampada a LED
- Carrello contropunta a bloccaggio rapido e corsa di 75 mm
- Ingranaggi del carro a bagno d'olio

Altezza punte	160 mm
Diametro max sul banco	320 mm
Diametro max sul carro	210 mm
Altezza utensile	16 mm
Distanza tra le punte	900 mm
Passaggio barra	38 mm
Attacco mandrino	Camlock D1-4
Conicità passaggio barra CM	5
Velocità variabile del mandrino	75 + 500 300 ÷ 2000 rpm
Avanzamenti longitudinali	0,07 ÷ 1,0 mm / giro
Avanzamenti trasversali	0,0017 ÷ 0,25 mm/giro
Filettature metriche	(18) 0,2 ÷ 3,5 mm
Filettature in pollici	(21) 8 ÷ 56 TPI
Conicità contropunta CM	3
Motore	230V 50/60 Hz 1.5 kW
Dimensioni	1600 x 750 x 1300 mm
Peso netto	360 kg

T900
€ 6540,00
TORNIO PARALLELO

Con scatola ingranaggi semi norton, cambio velocità a cinghia, avanzamenti longitudinali, trasversali, barra di tornitura, banco parzialmente assemblato con 3 cassette e armadietto. Barra di tornitura con frizione registrabile.

ACCESSORI INCLUSI

- Mandrino autocentrante 3+3 Ø 160 mm
- Mandrino a 4 griffe indipendenti reversibili Ø 160 mm
- Flangia menabrida Ø 240 mm
- Flangia per mandrino a 4 griffe Ø 160 mm
- Lunetta mobile
- Lunetta fissa
- Contropunta fissa CM 3
- Contropunta fissa CM 5
- Frizione su barra di tornitura
- Comparatore di filettatura
- Protezione vite madre
- Protezione torretta con micro di sicurezza
- Protezione mandrino con micro di sicurezza
- Paraspruzzi posteriore
- Torretta a cambio rapido T0AE
- Lampada a LED
- Carrello contropunta a bloccaggio rapido e corsa di 75 mm
- Ingranaggi del carro a bagno d'olio

Altezza punte	160 mm
Diametro max sul banco	320 mm
Diametro max sul carro	210 mm
Altezza utensile	16 mm
Distanza tra le punte	900 mm
Passaggio barra	38 mm
Attacco mandrino	Camlock D1-4
Conicità passaggio barra CM	5
Velocità del mandrino	(6) 125 ÷ 2000 rpm
Avanzamenti longitudinali	0,07 ÷ 1,0 mm / giro
Avanzamenti trasversali	0,0017 ÷ 0,25 mm/giro
Filettature metriche	(18) 0,2 ÷ 3,5 mm
Filettature in pollici	(21) 8 ÷ 56 TPI
Conicità contropunta CM	3
Motore	230 V 50 Hz 1,5 kW
Dimensioni	1600 x 750 x 1300 mm
Peso netto	330 kg



T750I
€ 7020,00
TORNIO PARALLELO CON INVERTER

Con scatola ingranaggi semi norton, trasmissione a cinghia, avanzamenti longitudinali, trasversali, barra di tornitura, banco parzialmente assemblato con 3 cassette e armadietto. Barra di tornitura con frizione registrabile.

ACCESSORI INCLUSI

- Mandrino autocentrante 3+3 Ø 160 mm
- Mandrino a 4 griffe indipendenti reversibili Ø 160 mm
- Flangia menabrida Ø 200 mm
- Flangia per mandrino a 4 griffe Ø 160 mm
- Lunetta mobile
- Lunetta fissa
- Contropunta fissa CM 3
- Contropunta fissa CM 5
- Frizione su barra di tornitura
- Comparatore di filettatura
- Protezione vite madre
- Protezione torretta
- Protezione mandrino
- Paraspruzzi posteriore
- Torretta a cambio rapido TOAE
- Lampada a LED

Altezza punta	160 mm
Diametro max sul banco	290 mm
Diametro max sul carro	175 mm
Altezza utensile	20 mm
Distanza tra le punte	750 mm
Passaggio barra	38 mm
Conicità passaggio barra CM	5
Velocità variabile del mandrino	75 ÷ 500 300 ÷ 2000 rpm
Avanzamenti longitudinali	0,07 ÷ 1,0 mm / giro
Avanzamenti trasversali	0,0017 ÷ 0,25 mm/giro
Filettature metriche	(18) 0,2 ÷ 3,5 mm
Filettature in pollici	(21) 8 ÷ 56 TPI
Conicità contropunta CM	3
Motore	Trifase 230 V 1.1 kW
Alimentazione monofase	230 V 50 / 60 Hz
Dimensioni	1450 x 720 x 1280 mm
Peso netto	310 kg

T750
€ 5830,00
TORNIO PARALLELO

Con scatola ingranaggi semi norton, cambio velocità a cinghia, avanzamenti longitudinali, trasversali, barra di tornitura, banco parzialmente assemblato con 3 cassette e armadietto. Barra di tornitura con frizione registrabile.

ACCESSORI INCLUSI

- Mandrino autocentrante 3+3 Ø 160 mm
- Mandrino a 4 griffe indipendenti reversibili Ø 160 mm
- Flangia menabrida Ø 200 mm
- Flangia per mandrino a 4 griffe Ø 160 mm
- Lunetta mobile
- Lunetta fissa
- Contropunta fissa CM 3
- Contropunta fissa CM 5
- Frizione su barra di tornitura
- Comparatore di filettatura
- Protezione vite madre
- Protezione torretta
- Protezione mandrino
- Paraspruzzi posteriore
- Torretta a cambio rapido TOAE
- Lampada LED
- Carrello contropunta a bloccaggio rapido 75 mm
- Ingranaggi del carro a bagno d'olio

Altezza punta	160 mm
Diametro max sul banco	290 mm
Diametro max sul carro	175 mm
Altezza utensile	20 mm
Distanza tra le punte	750 mm
Passaggio barra	38 mm
Conicità passaggio barra CM	5
Velocità del mandrino	(6) 125 ÷ 2000 rpm
Avanzamenti longitudinali	0,07 ÷ 1,0 mm / giro
Avanzamenti trasversali	0,0017 ÷ 0,25 mm/giro
Filettature metriche	(18) 0,2 ÷ 3,5 mm
Filettature in pollici	(21) 8 ÷ 56 TPI
Conicità contropunta CM	3
Motore	230 V 50 Hz 1,5 kW
Dimensioni	1450 x 720 x 1280 mm
Peso netto	310 kg



T700V
€ 5910,00
TORNIO PARALLELO A VELOCITÀ VARIABILE

Scatola ingranaggi semi norton, cambio a velocità variabile, avanzamenti longitudinali, trasversali, barra di tornitura, banco parzialmente assemblato con 3 cassetti e armadietto. Barra di tornitura con frizione registrabile.

ACCESSORI INCLUSI

- Mandrino autocentrante 3+3 Ø 125 mm
- Mandrino a 4 griffe indipendenti reversibili Ø 125 mm
- Flangia menabrida Ø 200 mm
- Flangia per mandrino a 4 griffe Ø 125 mm
- Lunetta mobile
- Lunetta fissa
- Contropunta fissa CM 2
- Contropunta fissa CM 4
- Frizione su barra di tornitura
- Comparatore di filettatura
- Protezione vite madre
- Protezione torretta
- Protezione mandrino
- Paraspruzzi posteriore
- Torretta fissa per utensili da 12 mm
- Carrello contropunta a bloccaggio rapido
- Ingranaggi del carro a bagno d'olio

Altezza punta	145 mm
Diametro max sul banco	290 mm
Diametro max sul carro	150 mm
Altezza utensile	12 mm
Distanza tra le punte	700 mm
Passaggio barra	26 mm
Conicità passaggio barra CM	4
Velocità variabile del mandrino	50 ÷ 1000 rpm 110 ÷ 2000 rpm
Avanzamenti longitudinali	0,07 ÷ 0,65 mm / giro
Avanzamenti trasversali	0,03 ÷ 0,12 mm/giro
Filettature metriche	0,2 ÷ 3,5 mm
Filettature in pollici	8 ÷ 48 TPI
Conicità contropunta CM	2
Motore	230 V 50 Hz 1,5 kW
Dimensioni	1129 x 690 x 1127 mm
Peso netto	270 kg

T700
€ 5120,00
TORNIO PARALLELO

Con scatola ingranaggi semi norton, cambio velocità a cinghia, avanzamenti longitudinali, trasversali, barra di tornitura, banco parzialmente assemblato con 3 cassetti e armadietto. Barra di tornitura con frizione registrabile.

ACCESSORI INCLUSI

- Mandrino autocentrante 3+3 Ø 125 mm
- Mandrino a 4 griffe indipendenti reversibili Ø 125 mm
- Flangia menabrida Ø 200 mm
- Flangia per mandrino a 4 griffe Ø 125 mm
- Lunetta mobile
- Lunetta fissa
- Contropunta fissa CM 2
- Contropunta fissa CM 4
- Frizione su barra di tornitura
- Comparatore di filettatura
- Protezione vite madre
- Protezione torretta
- Protezione mandrino
- Paraspruzzi posteriore
- Torretta fissa per utensili da 12 mm
- Carrello contropunta a bloccaggio rapido 85 mm
- Ingranaggi del carro a bagno d'olio

Altezza punta	150 mm
Diametro max sul banco	290 mm
Diametro max sul carro	180 mm
Altezza utensile	12 mm
Distanza tra le punte	700 mm
Passaggio barra	26 mm
Conicità passaggio barra CM	4
Velocità del mandrino	(6) 150 ÷ 2000 rpm
Avanzamenti longitudinali	0,085 ÷ 0,832 mm / giro
Avanzamenti trasversali	0,01 ÷ 0,10 mm / giro
Filettature metriche	0,2 ÷ 3,5 mm
Filettature in pollici	8 ÷ 48 TPI
Conicità contropunta CM	2
Motore	230 V 50 Hz 1.1 kW
Dimensioni	1270 x 610 x 1320 mm
Peso netto	270 kg



T660I
€ 6090,00
TORNIO PARALLELO CON INVERTER A VELOCITÀ VARIABILE

Scatola ingranaggi semi norton, banco parzialmente assemblato.

ACCESSORI INCLUSI

- Mandrino autocentrante 3+3 Ø 125 mm
- Mandrino a 4 griffe indipendenti reversibili Ø 160 mm
- Flangia menabrida Ø 200 mm
- Flangia per mandrino a 4 griffe Ø 160 mm
- Lunetta mobile
- Lunetta fissa
- Contropunta fissa CM 2
- Contropunta fissa CM 4
- Contropunta rotante CM 2
- Comparatore di filettatura
- Protezione vite madre
- Protezione torretta
- Protezione mandrino
- Paraspruzzi posteriore
- Torretta a cambio rapido TOAA

Altezza punta	140 mm
Diametro max sul banco	280 mm
Diametro max sul carro	165 mm
Altezza utensile	14 mm
Distanza tra le punte	660 mm
Passaggio barra	26 mm
Conicità passaggio barra CM	4
Velocità variabile del mandrino	100 ÷ 2000 rpm
Avanzamenti longitudinali	0,063 ÷ 0,35 mm / giro
Filettature metriche	0,25 ÷ 3,5 mm
Filettature in pollici	8 ÷ 72 TPI
Conicità contropunta CM	2
Motore	230 V 50/60 Hz 0.75 kW
Dimensioni	1325 x 550 x 1230 mm
Peso netto	216 kg

T660
€ 4550,00
TORNIO PARALLELO

Scatola ingranaggi semi norton e cambio velocità a cinghia, banco parzialmente assemblato.

ACCESSORI INCLUSI

- Mandrino autocentrante 3+3 Ø 125 mm
- Mandrino a 4 griffe indipendenti reversibili Ø 160 mm
- Flangia menabrida Ø 200 mm
- Flangia per mandrino a 4 griffe Ø 160 mm
- Lunetta mobile
- Lunetta fissa
- Contropunta fissa CM 2
- Contropunta fissa CM 4
- Contropunta rotante CM 2
- Comparatore di filettatura
- Protezione vite madre
- Protezione mandrino
- Paraspruzzi posteriore
- Torretta a cambio rapido TOAA

Altezza punta	140 mm
Diametro max sul banco	280 mm
Diametro max sul carro	165 mm
Altezza utensile	14 mm
Distanza tra le punte	660 mm
Passaggio barra	26 mm
Conicità passaggio barra CM	4
Velocità del mandrino	(6) 125 ÷ 2000 rpm
Avanzamenti longitudinali	0,063 ÷ 0,35 mm / giro
Filettature metriche	0,25 ÷ 3,5 mm
Filettature in pollici	8 ÷ 72 TPI
Conicità contropunta CM	2
Motore	230 V 50 Hz 0,75 kW
Dimensioni	1325 x 550 x 1230 mm
Peso netto	216 kg



0657
€ 3130,00
TORNIO PARALLELO

Con dispositivo di fresatura, cambio velocità a cinghia.

ACCESSORI INCLUSI

- Mandrino autocentrante 3+3 Ø 125 mm
- Contropunta fissa CM 2
- Contropunta fissa CM 3
- Protezione vite madre
- Protezione torretta
- Protezione mandrino
- Paraspruzzi posteriore
- Torretta fissa per utensili da 12 mm
- Carrello contropunta a bloccaggio rapido



Altezza punte	125 mm
Diametro max sul banco	250 mm
Diametro max sul carro	150 mm
Altezza utensile	12 mm
Distanza tra le punte	550 mm
Passaggio barra	20 mm
Conicità passaggio barra CM	3
Conicità contropunta CM	2

Velocità del mandrino	(6) 125 ÷ 2000 rpm
Avanzamenti longitudinali	0,1 - 0,2 mm / giro
Filettature metriche	0,4 ÷ 3,5 mm
Filettature in pollici	18 ÷ 44 TPI
Motore	230 V 50 Hz 0,55 kW
Dimensioni	1120 x 480 x 460h mm
Peso netto	145 kg

0708
€ 2560,00
TORNIO PARALLELO

Con cambio di velocità ad ingranaggi, cuscinetti conici dell'albero mandrino, noni registrabili, vite madre protetta e protezione mandrino con microinterruttore.

ACCESSORI INCLUSI

- Mandrino autocentrante 3+3 Ø 125 mm
- Lunetta mobile
- Contropunta fissa CM2
- Contropunta fissa CM3
- Comparatore per filettare
- Protezione vite madre
- Protezione torretta
- Protezione mandrino
- Paraspruzzi posteriore
- Torretta fissa per utensili da 12 mm



Altezza punte	110 mm
Diametro max sul banco	200 mm
Diametro max sul carro	122 mm
Altezza utensile	12 mm
Distanza tra le punte	520 mm
Passaggio barra	20 mm
Conicità passaggio barra CM	3
Velocità del mandrino	(6) 170 ÷ 1950 rpm

Avanzamenti longitudinali	0,04 ÷ 0,20 mm / giro
Filettature metriche	0,25 ÷ 3 mm
Filettature in pollici	8 ÷ 48 TPI
Conicità contropunta CM	2
Motore	230 V 50 Hz 0,55 kW
Dimensioni	1080 x 440 x 400h mm
Peso netto	130 kg

0506
€ 2330,00
TORNIO PARALLELO

Con avanzamenti automatici longitudinale e velocità variabile visualizzata sul display digitale. Ingranaggi in metallo.

ACCESSORI INCLUSI

- Mandrino autocentrante 3+3 Ø 100 mm
- Lunetta mobile
- Lunetta fissa
- Contropunta fissa CM 2
- Contropunta rotante CM 2
- Comparatore per filettare
- Protezione torretta
- Protezione mandrino in metallo
- Protezione vite madre
- Paraspruzzi posteriore
- Torretta fissa per utensili da 10 mm
- Carrello contropunta a bloccaggio rapido



Altezza punte	105 mm
Diametro max sul banco	210 mm
Diametro max sul carro	140 mm
Altezza utensile	10 mm
Distanza tra le punte	400 mm
Passaggio barra	21 mm
Conicità passaggio barra CM	3

Velocità variabile del mandrino	50 ÷ 1100 rpm 100 ÷ 2500 rpm
Avanzamenti longitudinali	0,083 ÷ 0,175 mm / giro
Filettature metriche	(9) 0,5 ÷ 2,5 mm
Conicità contropunta CM	2
Motore	230 V 50 Hz 0,6 kW
Dimensioni	780 x 300 x 340 h mm
Peso netto	49 kg

0716S
€ 2050,00
TORNIO PARALLELO

Con avanzamenti automatici longitudinale e velocità' variabile visualizzata sul display digitale.

ACCESSORI INCLUSI

- Mandrino autocentrante 3+3 Ø 100 mm
- Flangia Ø 160 mm
- Lunetta mobile
- Lunetta fissa
- Contropunta fissa CM 2
- Comparatore per filettare
- Protezione torretta
- Protezione mandrino
- Paraspruzzi posteriore
- Torretta fissa per utensili da 10 mm

Altezza punta	100 mm
Diametro max sul banco	170 mm
Diametro max sul carro	125 mm
Altezza utensile	10 mm
Distanza tra le punte	350 mm
Passaggio barra	20 mm
Conicità passaggio barra CM	3
Velocità variabile del mandrino	(2) 100 ÷ 1100 200 ÷ 2500 rpm
Filettature metriche	0,5 ÷ 2,5 mm
Conicità contropunta CM	2
Motore	230 V 50 60 Hz 0,6 kW
Dimensioni	750 x 245 x 290 h mm
Peso netto	46 kg

0716
€ 1840,00
TORNIO PARALLELO

Con avanzamenti automatici longitudinali e velocità' variabile visualizzata su display digitale.

ACCESSORI INCLUSI

- Mandrino autocentrante 3+3 Ø 100 mm
- Flangia Ø 160 mm
- Lunetta mobile
- Lunetta fissa
- Contropunta fissa CM 2
- Comparatore per filettare
- Protezione torretta
- Protezione mandrino
- Paraspruzzi posteriore
- Torretta fissa per utensili da 10 mm

Altezza punta	90 mm
Diametro max sul banco	170 mm
Diametro max sul carro	110 mm
Altezza utensile	10 mm
Distanza tra le punte	300 mm
Passaggio barra	20 mm
Conicità passaggio barra CM	3
Velocità del mandrino	(2) 100 ÷ 1100 200 ÷ 2500 rpm
Filettature metriche	0,5 ÷ 2,5 mm / giro
Conicità contropunta CM	2
Motore	230 V 50 60 Hz 0,5 kW
Dimensioni	730 x 290 x 280 h mm
Peso netto	40 kg

0657/B
€ 489,00
BANCO PER TORNIO UNIVERSALE

Da assemblare, regolabile in tre posizioni, in caso di misure speciali è possibile forare la lamiera. Dotato di 2 sportelli con 2 mensole. Adatto a torni con distanza punte compresa tra 500 mm e 900 mm

UPGRADE

Dimensioni	90 ÷ 91.5 105 ÷ 106.5 118.5 ÷ 119.5 x 433 x 720h mm
Peso netto	37,5 kg

0710
€ 359,00
BASE PER TORNIO

Base per tornio parzialmente assemblato.



Dimensioni	1050 x 320 x 725h mm
Peso netto	21 kg

0716/B
€ 338,00
BASE PER TORNIO

Completamente in lamiera, chiusura senza chiave, con mensola interna.



Dimensioni	760 x 240 x 680h mm
Interasse fuori	535 x 70 mm
Altezza mensola interna	300 mm
Peso netto	23.50 kg

TRAPANI FRESA

F060/..



F050/..



T047/..



T044/..



T059/28V



T061A



T059/16V



T058



T073



T052/..



T046



TRAPANI FRESA

Capacità di foratura su ghisa con preforo (mm)

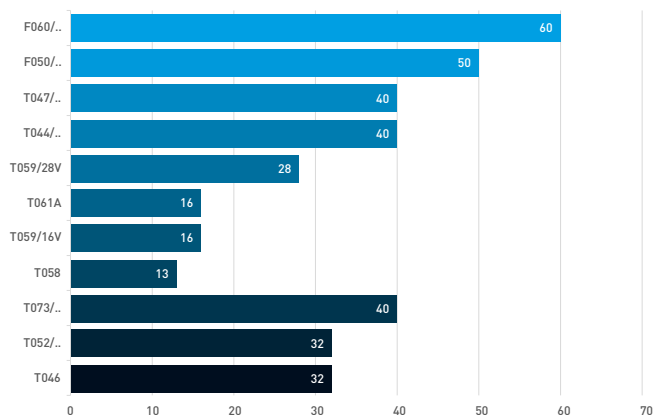

Capacità di fresatura (mm)

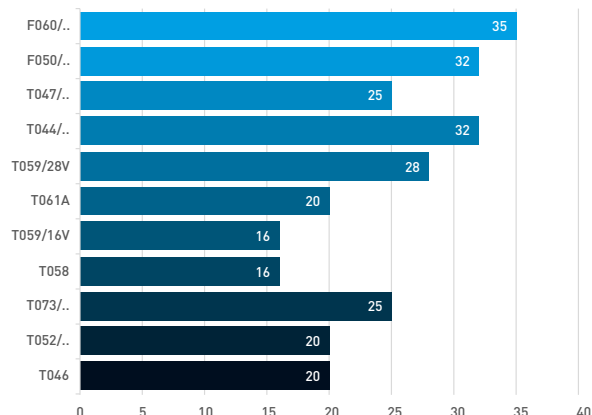

Corsa mandrino (mm)

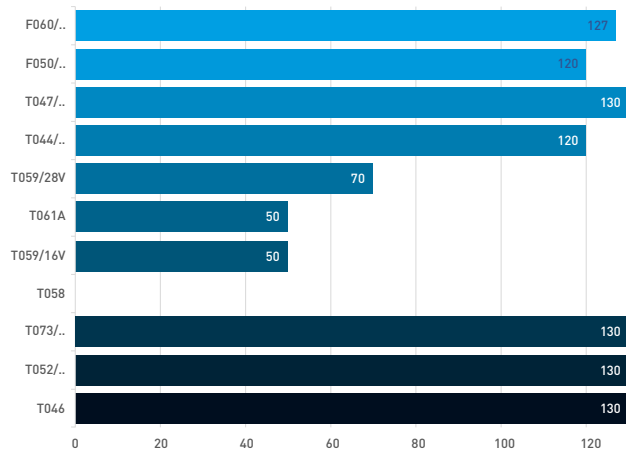

Attacco

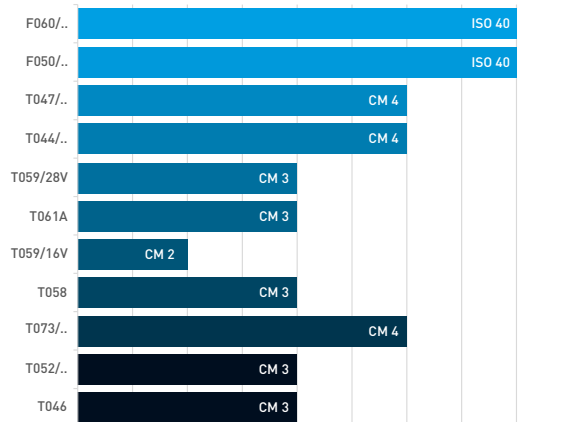

Dimensioni tavola (mm)

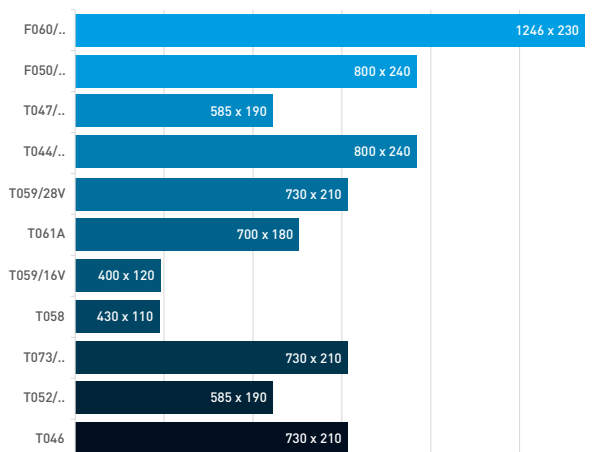

Potenza (W)

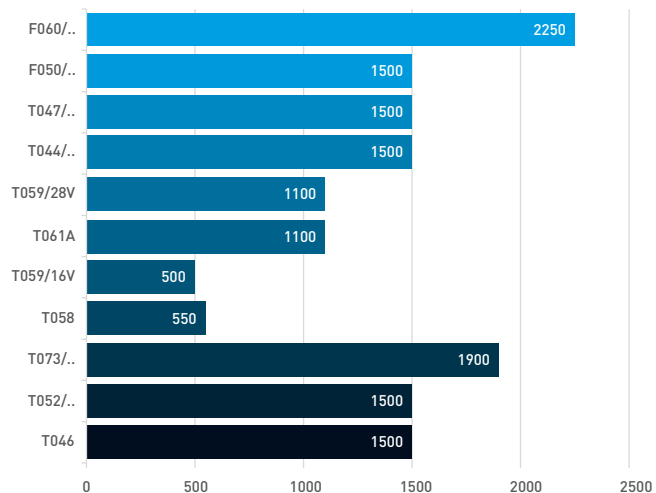

F060I
€ 25920,00
FRESA VERTICALE A TESTA VELOCE CON INVERTER

ISO 40, con discesa automatica, tavola a croce motorizzata su tutti gli assi, visualizzatore a 3 assi e inverter giapponese.

ACCESSORI INCLUSI

- Base con vasca per trucioli
- Impianto di refrigerazione
- Lampada a LED
- Display per la visualizzazione della velocità di rotazione
- Visualizzatore a 3 assi
- Assi motorizzati a velocità variabile con funzione rapido
- Volantini tavola tondi con funzione di folle
- Impianto di lubrificazione delle guide con pompa manuale

Capacità di fresatura con fresa a inserti	100 mm
Capacità di fresatura	35 mm
Capacità di foratura su ghisa con preforo	60 mm
Capacità max di foratura su acciaio con preforo (s235jr)	24 mm
Attacco mandrino	ISO 40 - DIN 2080
Canotto	86 mm
Corsa mandrino	127 mm
Inclinazione testa	± 45°
Rotazione testa verticale	± 90°
Rotazione corpo testa	± 180°
Velocità variabile del mandrino	60 ÷ 3600 rpm
Motore	400 V 50 Hz 2.25 kW
Motore movimentazione tavola	(X,Y) 400V 50 Hz 180 W (Z) 400V 50 Hz 100W
Pompa di refrigerazione	400V 50 Hz 90 W
Velocità di discesa	(3) 0.04 - 0.08 - 0.15 mm/giro
Velocità tangenziale	(X,Y) 42 - 76 - 164 - 262 mm/min (Z) 0 ÷ 457 mm/min
Distanza tra naso macchina e tavola	45 - 395 mm
Distanza asse mandrino - colonna	215-450 mm
Dimensioni tavola	1246 x 230 mm
Spostamento tavola longitudinale	850 mm
Spostamento tavola trasversale	310 mm
Cava	16 mm
Portata max	400 kg
Dimensioni	1680 x 1500 x 2100 h mm
Peso netto	1000 kg

UPGRADE

F060V
€ 22610,00
FRESA VERTICALE CON TESTA VELOCE CON VARIATORE VELOCITÀ MECCANICO

A velocità variabile, ISO 40, con discesa automatica, tavola a croce motorizzata su tutti gli assi, visualizzatore a 3 assi.

ACCESSORI INCLUSI

- Base con vasca per trucioli
- Impianto di refrigerazione
- Lampada a LED
- Indicatore meccanico della velocità
- Visualizzatore a 3 assi
- Assi motorizzati a velocità variabile con funzione rapido
- Volantini tavola tondi con funzione di folle
- Impianto di lubrificazione delle guide con pompa manuale

Capacità di fresatura con fresa a inserti	100 mm
Capacità di fresatura	35 mm
Capacità di foratura su ghisa con preforo	60 mm
Capacità max di foratura su acciaio con preforo (s235jr)	24 mm
Attacco mandrino	ISO 40 - DIN 2080
Canotto	86 mm
Corsa mandrino	127 mm
Inclinazione testa	± 45°
Rotazione testa verticale	± 90°
Rotazione corpo testa	± 180°
Velocità mandrino verticale	(2) 60 ÷ 500 500 ÷ 3600 rpm
Motore	400 V 50 Hz 2.25 kW
Motore movimentazione tavola	(X,Y) 400V 50 Hz 180 W (Z) 400V 50 Hz 100W
Pompa di refrigerazione	400V 50 Hz 90 W
Velocità di discesa	(3) 0.04 - 0.08 - 0.15 mm/giro
Velocità tangenziale	(X,Y) 42 - 76 - 164 - 262 mm/min (Z) 0 ÷ 457 mm/min
Distanza tra naso macchina e tavola	45 - 395 mm
Distanza asse mandrino - colonna	215-450 mm
Dimensione tavola	1246 x 230 mm
Spostamento tavola longitudinale	850 mm
Spostamento tavola trasversale	310 mm
Cava	16 mm
Portata max	400 kg
Dimensioni	1680 x 1500 x 2100 h mm
Peso netto	1000 kg

UPGRADE

F060
€ 20460,00
FRESA A TESTA VELOCE VERTICALE

ISO40, con discesa automatica, tavola a croce motorizzata su tutti gli assi, visualizzatore a 3 assi, cambio a cinghie.

ACCESSORI INCLUSI

- Base con vasca per trucioli
- Impianto di refrigerazione
- Lampada a LED
- Visualizzatore a 3 assi
- Assi motorizzati a velocità variabile con funzione rapido
- Volantini tavola tondi con funzione di folle
- Impianto di lubrificazione delle guide con pompa manuale

Capacità di fresatura con fresa a inserti	100 mm
Capacità di fresatura	35 mm
Capacità di foratura su ghisa con preforo	60 mm
Capacità max di foratura su acciaio con preforo (s235jr)	24 mm
Attacco mandrino	ISO 40 - DIN 2080
Canotto	86 mm
Corsa mandrino	127 mm
Inclinazione testa	± 45°
Rotazione testa verticale	± 90°
Rotazione corpo testa	± 180°
Velocità mandrino verticale	[16] 80 ÷ 650 660 ÷ 5440 rpm
Motore	400 V 50 Hz 2,25 kW
Motore movimentazione tavola	[X,Y] 400V 50 Hz 180 W [Z] 400V 50 Hz 100W
Pompa di refrigerazione	400V 50 Hz 90 W
Velocità di discesa	[3] 0.04 - 0.08 - 0.15 mm/giro
Velocità tangenziale	[X,Y] 42 - 76 - 164 - 262 mm/min [Z] 0 ÷ 457 mm/min
Distanza tra naso macchina e tavola	45 - 395 mm
Distanza asse mandrino - colonna	215-450 mm
Dimensione tavola	1246 x 230 mm
Spostamento tavola longitudinale	850 mm
Spostamento tavola trasversale	310 mm
Cava	16 mm
Portata max	400 kg
Dimensioni	1680 x 1500 x 2100 h mm
Peso netto	1000 kg

F050U
€ 14040,00
FRESA UNIVERSALE A TESTA VELOCE

Fresatura verticale e orizzontale, ISO 40, tavola a croce con un asse motorizzato, visualizzatore a 3 assi. Cambio ad ingranaggi per mandrino verticale e cambio a cinghie per mandrino orizzontale.

ACCESSORI INCLUSI

- Base con vasca per trucioli
- Impianto di refrigerazione
- Lampada a LED
- Visualizzatore a 3 assi
- Morsa a macchina 160 mm
- Mandrino ISO40 con pinze ER32 8 Pz
- Mandrino ISO40 CM 3
- Mandrino a cremagliera 3-16 mm B18
- Albero mandrino ISO40 B18
- 2 mandrini portafresa per asse orizzontale
- 2 tiranti M16 per mandrini ISO40
- Asse longitudinale motorizzato ad ingranaggi con rapido
- Volantini tavola tondi con funzione di folle

Capacità di fresatura con fresa a inserti	100 mm
Capacità di fresatura	32 mm
Capacità di foratura su ghisa con preforo	50 mm
Capacità max di foratura su acciaio con preforo (s235jr)	30 mm
Attacco mandrino	ISO40 DIN2080
Canotto	90 mm
Corsa mandrino	120 mm
Rotazione testa verticale	± 45°
Rotazione corpo testa	± 180°
Velocità mandrino verticale	[8] 115 ÷ 1750 rpm
Velocità mandrino orizzontale	[9] 60 ÷ 1350 rpm
Motore	400 V 50 Hz 0.85 - 1.5 kW
Motore movimentazione tavola	400V 50Hz 0.325 KW
Dimensioni base	510 x 900 mm
Pompa di refrigerazione	400V 50 Hz 0.4 KW
Distanza tra naso macchina e tavola	60 - 360 mm
Distanza asse mandrino - colonna	250 - 650 mm
Dimensioni tavola	800 x 240 mm
Spostamento tavola longitudinale	380 mm
Spostamento tavola trasversale	220 mm
Cava	14 mm
Portata max	300 kg
Dimensioni	1380 x 1200 x 2100 h mm
Peso netto	930 kg



F050I
€ 15460,00
FRESA A TESTA VELOCE CON INVERTER

Inverter giapponese, fresatura verticale, ISO 40, tavola a croce con un asse motorizzato, visualizzatore a 3 assi.

ACCESSORI INCLUSI

- Base con vasca per trucioli
- Impianto di refrigerazione
- Lampada a LED
- Visualizzatore a 3 assi
- Morsa a macchina 160 mm
- Mandrino ISO40 con pinze ER32 8Pz
- Mandrino ISO40 CM3
- Mandrino a cremagliera 3-16 mm B18
- Albero mandrino ISO40 B18
- 2 tiranti M16 per mandrini ISO40
- Asse longitudinale motorizzato ad ingranaggi con rapido
- Volantini tavola tondi con funzione di folle

Capacità di fresatura con fresa a inserti	100 mm
Capacità di fresatura	32 mm
Capacità di foratura su ghisa con preforo	50 mm
Capacità max di foratura su acciaio con preforo (s235jr)	30 mm
Attacco mandrino	ISO40 DIN2080
Canotto	90 mm
Corsa mandrino	120 mm
Rotazione testa verticale	± 180°
Rotazione corpo testa	± 90°
Velocità variabile del mandrino	(2) 100 ÷ 600 350 ÷ 2000 rpm
Motore	400 V 50 Hz 2,2 kW
Motore movimentazione tavola	400V 50Hz 0.325 KW
Dimensioni base	510 x 900 mm
Pompa di refrigerazione	400V 50 Hz 0.4 KW
Distanza asse mandrino - colonna	60 - 360 mm
Distanza naso macchina-tavola	250 - 650 mm
Dimensioni tavola	800 x 240 mm
Spostamento tavola longitudinale	380 mm
Spostamento tavola trasversale	220 mm
Cava	16 mm
Portata max	300 kg
Dimensioni	1380 x 1200 x 2100
Peso netto	930 kg

F050
€ 12880,00
FRESA A TESTA VELOCE

Fresatura verticale, ISO 40, tavola a croce con un asse motorizzato, visualizzatore a 3 assi.

ACCESSORI INCLUSI

- Base con vasca per trucioli
- Impianto di refrigerazione
- Lampada a LED
- Visualizzatore a 3 assi
- Morsa a macchina 160 mm
- Mandrino ISO40 con pinze ER32 8 Pz
- Mandrino ISO40 CM3
- Mandrino a cremagliera 3 - 16 mm B18
- Albero mandrino ISO40 B18
- 2 tiranti M16 per mandrini ISO40
- Asse longitudinale motorizzato ad ingranaggi con rapido
- Volantini tavola tondi con funzione di folle

Capacità di fresatura con fresa a inserti	100 mm
Capacità di fresatura	32 mm
Capacità di foratura su ghisa con preforo	50 mm
Capacità max di foratura su acciaio con preforo (s235jr)	30 mm
Attacco mandrino	ISO40 DIN2080
Canotto	90 mm
Corsa mandrino	120 mm
Rotazione testa verticale	± 45°
Rotazione corpo testa	± 180°
Velocità variabile del mandrino	(8) 115 ÷ 1750 rpm
Motore	400 V 50 Hz 0,85 - 1,5 kW
Motore movimentazione tavola	400V 50Hz 0.325 KW
Dimensioni base	510 x 900 mm
Pompa di refrigerazione	400V 50 Hz 0.4 KW
Distanza tra naso macchina e tavola	60 - 360 mm
Distanza asse mandrino - colonna	250 - 650 mm
Dimensioni tavola	800 x 240 mm
Spostamento tavola longitudinale	380 mm
Spostamento tavola trasversale	220 mm
Cava	14 mm
Portata max	300 kg
Dimensioni	1380 x 1200 x 2100
Peso netto	930 kg



F050B
€ 10550,00 **NEW**
FRESA A TESTA VELOCE

Fresatura verticale, ISO 40, tavola a croce con un asse motorizzato a velocità variabile

ACCESSORI INCLUSI

- Base con vasca per trucioli
- Impianto di refrigerazione
- Lampada a LED
- Mandrino ISO40 con pinze ER32 8 Pz
- Mandrino ISO40 CM 3
- Mandrino a cremagliera 3 - 16 mm B18
- Albero mandrino ISO40 B18
- Tirante M16 per mandrini ISO40
- Asse longitudinale motorizzato a velocità variabile con rapido
- Volantini tavola tondi con funzione di folle

Capacità di fresatura con fresa a inserti	100 mm
Capacità di fresatura	32 mm
Capacità di foratura su ghisa con preforo	50 mm
Capacità max di foratura su acciaio con preforo (s235jr)	30 mm
Attacco mandrino	ISO40 DIN2080
Canotto	90 mm
Corsa mandrino	120 mm
Rotazione testa verticale	± 45°
Rotazione corpo testa	± 180°
Velocità variabile del mandrino	(8) 115 ÷ 1750 rpm
Motore	400 V 50 Hz 0,85 - 1,5 kW
Motore movimentazione tavola	110V 50Hz 300W
Dimensioni base	510 x 900 mm
Pompa di refrigerazione	400 V 50 Hz 40W
Distanza tra naso macchina e tavola	45 - 395 mm
Distanza asse mandrino - colonna	215 - 450 mm
Dimensione tavola	800 x 240 mm
Spostamento tavola longitudinale	380 mm
Spostamento tavola trasversale	220 mm
Cava	14 mm
Portata max	400 Kg
Dimensioni	1680 x 1500 x 2100 h mm
Peso netto	1000 Kg

T047/400VDA
€ 5560,00
TRAPANO FRESA AD INGRANAGGI

Con discesa automatica, inversione di marcia, maschiatura, impianto di refrigerazione.

ACCESSORI INCLUSI

- Mandrino autoserrante 1 ÷ 16 B16
- Mandrino a cremagliera 1 ÷ 13 B16
- Attacco mandrino forato CM 4 B16
- Attacco fresa CM 4 Ø 27 mm
- Bussola di riduzione CM 4/3
- Bussola di riduzione CM 3/2
- Oliatori
- Tirante M16
- Chiavi di servizio

Capacità di foratura su ghisa con preforo	Ø 40 mm
Capacità di foratura su acciaio con preforo	Ø 32 mm
Capacità di fresatura con fresa a inserti	Ø 80 mm
Capacità di fresatura	Ø 25 mm
Capacità di maschiatura	Ø 22 mm
Cono morse	CM 4
Velocità del mandrino	(12) 75 ÷ 3200 rpm
Corsa mandrino	130 mm
Rotazione mandrino	Dx - Sx
Canotto	Ø 76 mm
Colonna	Ø 115 mm
Inclinazione testa	± 60°
Divisione avanzamento verticale manuale	0.02 mm
Velocità di discesa	(3) 0,1 - 0,18 - 0,26 mm/g
Distanza tra naso macchina e tavola	715 mm
Distanza asse mandrino - colonna	260 mm
Dimensioni tavola	585 x 190 mm
Cava tavola	12 mm
Corsa longitudinale	360 mm
Corsa trasversale	250 mm
Spostamento tavola longitudinale	360 mm
Spostamento tavola trasversale	250 mm
Dimensioni base	648 x 412 mm
Cava basamento	14 mm
Motore	400 V 50 Hz 1,1 - 1,5 kW
Dimensioni	740 x 790 x 1960 h mm
Peso netto	365 kg



T047/230V & T047/400V
€ 5210,00
TRAPANO FRESA AD INGRANAGGI

Con inversione di marcia, maschiatura temporizzata, impianto di refrigerazione.

ACCESSORI INCLUSI

- Mandrino autoserrante 1 ÷ 16 B16
- Mandrino a cremagliera 1 ÷ 13 B16
- Attacco mandrino forato CM 4 B16
- Attacco fresa CM 4 Ø 27 mm
- Bussola di riduzione CM 4/3
- Bussola di riduzione CM 3/2
- Oliatori
- Tirante M16
- Chiavi di servizio

Capacità di foratura su ghisa con preforo	Ø 40 mm
Capacità di foratura su acciaio con preforo	Ø 32 mm
Capacità di fresatura con fresa a inserti	Ø 80 mm
Capacità di fresatura con fresa cilindrica	Ø 25 mm
Capacità di maschiatura	Ø 22 mm
Cono morse	CM 4
Velocità del mandrino	(6) 75 ÷ 1600 rpm
Corsa mandrino	130 mm
Rotazione mandrino	Dx - Sx
Canotto	Ø 76 mm
Colonna	Ø 115 mm
Inclinazione testa	± 60°
Divisione avanzamento verticale manuale	0.02 mm
Distanza asse mandrino - colonna	260 mm
Distanza tra naso macchina e tavola	715 mm
Dimensioni tavola	585 x 190 mm
Cava tavola	12 mm
Spostamento tavola longitudinale	360 mm
Spostamento tavola trasversale	250 mm
Dimensioni base	648 x 412 mm
Cava basamento	14 mm
Motore	230 V 50 Hz 1,5 kW
Pompa di refrigerazione	230v 50 Hz 0.4 KW
Dimensioni	740 x 790 x 1960h mm
Peso netto	355 kg

T044/230V & T044/400V
€ 4980,00
TRAPANO FRESA DA BANCO AD INGRANAGGI

Colonna quadra e guide a coda di rondine, inversione di marcia temporizzata, maschiatura.

ACCESSORI INCLUSI

- Mandrino a cremagliera 1 ÷ 13 B16
- Attacco mandrino forato CM 4 B16
- Attacco fresa CM 4 Ø 27 mm
- Bussola di riduzione CM 4/3
- Bussola di riduzione CM 3/2
- Oliatori
- Tirante M16
- Chiavi di servizio

Capacità di foratura su ghisa con preforo	Ø 40 mm
Capacità max di foratura su acciaio con preforo [s235jr]	Ø 45 mm
Capacità di fresatura con fresa a inserti	Ø 80 mm
Capacità di fresatura con fresa cilindrica	Ø 32 mm
Capacità di maschiatura	Ø 22 mm
Cono morse	CM 4
Mandrino	1 - 13 mm B16
Velocità del mandrino	(6) 95 ÷ 1600 rpm
Corsa mandrino	120 mm
Rotazione mandrino	Dx - Sx
Canotto	Ø 75 mm
Inclinazione testa	± 60°
Divisione avanzamento verticale manuale	0,02 mm
Distanza asse mandrino - colonna	240 mm
Distanza max asse mandrino - tavola	460 mm
Dimensione tavola	800 x 240 mm
Cava	14 mm
Spostamento tavola longitudinale	560 mm
Spostamento tavola trasversale	190 mm
Dimensioni base	405 x 630 mm
Motore	230 V 50 Hz 1,5 kW
Peso netto	300 kg



T059/28V
€ 4440,00
TRAPANO FRESA DA BANCO AD INGRANAGGI

A velocità variabile con visualizzatore digitale di velocità mandrino e visualizzatore digitale di profondità.

ACCESSORI INCLUSI

- Mandrino a cremagliera 3 ÷ 13 B16
- Attacco mandrino forato CM 3
- Oliatore
- Tirante M12
- Chiavi di servizio



Capacità max di foratura su acciaio con preforo (s235jr)	Ø 28 mm
Capacità di fresatura con fresa a inserti	Ø 63 mm
Capacità di fresatura con fresa cilindrica	Ø 28 mm
Cono morse	CM 3
Mandrino	3 - 16 mm B16
Velocità del mandrino	100 ÷ 2500 rpm ±10%
Rotazione mandrino	Dx - Sx
Corsa del canotto	70 mm
Canotto	70 mm
Corsa testa	380 mm
Inclinazione testa	±90°
Dimensione tavola	730 x 210 mm
Cava	14 mm
Spostamento tavola longitudinale	190 mm
Spostamento tavola trasversale	440 mm
Motore	230 V 50 Hz 1,1 kW
Peso netto	270 kg

T061A
€ 3460,00
TRAPANO FRESA DA BANCO AD INGRANAGGI

A velocità variabile, con sistema di illuminazione, visualizzatore digitale di velocità mandrino, visualizzatore digitale di profondità.

ACCESSORI INCLUSI

- Mandrino a cremagliera 1 ÷ 16 B16
- Attacco mandrino forato CM 3
- Oliatore
- Tirante M12
- Chiavi di servizio



Capacità max di foratura su acciaio con preforo (s235jr)	Ø 16 mm
Capacità di fresatura con fresa a inserti	Ø 63 mm
Capacità di fresatura con fresa cilindrica	Ø 20 mm
Cono morse	CM 3
Mandrino	1 - 16 mm B16
Velocità variabile del mandrino	I 30 ÷ 1650 rpm ±10% II 2° 40 ÷ 2850 rpm ±10%
Corsa del canotto	50 mm
Rotazione mandrino	Dx - Sx
Canotto	60 mm
Corsa testa	290 mm
Inclinazione testa	±90°
Distanza naso macchina-tavola	350 mm
Dimensione tavola	700 x 180 mm
Cava	12 mm
Spostamento tavola longitudinale	175 mm
Spostamento tavola trasversale	490 mm
Motore	230 V 50 60 Hz 1,1 kW
Peso netto	120 kg



T059/16V
€ 2320,00
TRAPANO FRESA DA BANCO AD INGRANAGGI

A velocità variabile.

ACCESSORI INCLUSI

- Mandrino a cremagliera 1 ÷ 13 B16
- Attacco mandrino forato CM 2 B16
- Oliatore
- Tirante M10
- Chiavi di servizio



Capacità max di foratura su acciaio con preforo (s235jr)	Ø 16 mm
Capacità di fresatura con fresa a inserti	Ø 50 mm
Capacità di fresatura con fresa cilindrica	Ø 16 mm
Cono morse	CM 2
Mandrino	1 - 13 mm B16
Velocità del mandrino	I 100 ÷ 1500 rpm ±10% II 200 ÷ 3000 rpm ±10%
Corsa del canotto	50 mm
Rotazione mandrino	Dx
Corsa testa	210 mm
Inclinazione testa	±90°
Dimensione tavola	400 x 120 mm
Cava	10 mm
Spostamento tavola longitudinale	160 mm
Spostamento tavola trasversale	220 mm
Motore	230 V 50 Hz 500 W
Peso netto	72 kg

T058
€ 1870,00
TRAPANO FRESA DA BANCO AD INGRANAGGI

A velocità variabile.

ACCESSORI INCLUSI

- Mandrino a cremagliera 3 ÷ 16 B16
- Attacco mandrino forato CM 3
- Oliatore
- Tirante M12
- Chiavi di servizio



Capacità max di foratura su acciaio con preforo (s235jr)	Ø 13 mm
Capacità di fresatura con fresa a inserti	Ø 30 mm
Capacità di fresatura con fresa cilindrica	Ø 16 mm
Cono morse	CM 3
Mandrino	3 - 16 mm B16
Velocità del mandrino	I 50 ÷ 1100 rpm ±10% II 120 ÷ 2500 rpm ±10%
Rotazione mandrino	Dx
Corsa testa	210 mm
Inclinazione testa	±45°
Dimensione tavola	430 x 110 mm
Distanza tavola naso macchina	290 mm
Cava	12 mm
Spostamento tavola longitudinale	130 mm
Spostamento tavola trasversale	250 mm
Motore	230 V 50 Hz 0,55 kW
Peso netto	70 kg



T073DA
€ 10470,00
TRAPANO FRESA A COLONNA

Con trasmissione a cinghia, discesa automatica, reversibile, sistema di refrigerazione.

ACCESSORI INCLUSI

- Mandrino a cremagliera 1 ÷ 13 mm B16
- Attacco mandrino CM 4 B16
- Attacco fresa CM 4 Ø 27 mm
- Bussola di riduzione CM 4/3
- Bussola di riduzione CM 3/2
- Impianto di refrigerazione
- Tirante M16
- Chiavi di servizio

Capacità di foratura su ghisa con preforo	40 mm
Capacità max di foratura su acciaio con preforo (s235jr)	32 mm
Capacità di fresatura con fresa a inserti	80 mm
Capacità di fresatura	25 mm
Capacità di maschiatura	24 mm
Cono morse	CM 4
Mandrino	1 - 13 mm B16
Velocità del mandrino	100 - 2200 rpm
Corsa mandrino	90 mm
Rotazione mandrino	Dx - Sx
Canotto	75 mm
Colonna	123 mm
Divisione avanzamento verticale manuale	0,05 mm
Velocità di discesa	(3) 0,05 - 0,1 - 0,2 mm/g
Distanza asse mandrino - colonna	300 mm
Distanza tra naso macchina e tavola	125 ÷ 525 mm
Dimensione tavola	730 x 210 mm
Cava	14 mm
Spostamento tavola longitudinale	480 mm
Spostamento tavola trasversale	220 mm
Dimensioni base	470 x 680 mm
Motore	400 V 50 Hz 1,1 / 1,9 kW
Pompa di refrigerazione	400 V 50 Hz 75 W
Dimensioni	850 x 1100 x 1900h mm
Peso netto	420 kg

T073
€ 8530,00
TRAPANO FRESA A COLONNA

Con trasmissione a cinghia, reversibile, sistema di refrigerazione.

ACCESSORI INCLUSI

- Mandrino a cremagliera 1 ÷ 13 mm B16
- Attacco mandrino CM 4 B16
- Attacco fresa CM 4 Ø 27 mm
- Bussola di riduzione CM 4/3
- Bussola di riduzione CM 3/2
- Impianto di refrigerazione
- Tirante M16
- Chiavi di servizio

Capacità di foratura su ghisa con preforo	40 mm
Capacità max di foratura su acciaio con preforo (s235jr)	32 mm
Capacità di fresatura con fresa a inserti	80 mm
Capacità di fresatura	25 mm
Capacità di maschiatura	24 mm
Cono morse	CM 4
Mandrino	1 - 13 mm B16
Velocità del mandrino	100 ÷ 2200 rpm
Corsa mandrino	130 mm
Rotazione mandrino	Dx - Sx
Canotto	75 mm
Colonna	123 mm
Divisione avanzamento verticale manuale	0,05 mm
Distanza asse mandrino - colonna	300 mm
Distanza tra naso macchina e tavola	125 ÷ 525 mm
Dimensione tavola	730 x 210 mm
Cava	14 mm
Spostamento tavola longitudinale	480 mm
Spostamento tavola trasversale	220 mm
Dimensioni base	470 x 680 mm
Motore	400 V 50 Hz 1,1/1,9 kW
Pompa di refrigerazione	400 V 50 Hz 75 W
Dimensioni	850 x 1100 x 1900h mm
Peso netto	410 kg



T052/400VDA
€ 5040,00
TRAPANO FRESA A COLONNA

Con discesa automatica, scelta senso di rotazione e trasmissione a cinghia.

ACCESSORI INCLUSI

- Mandrino a cremagliera 1 ÷ 16 B16
- Attacco mandrino forato CM 3
- Attacco fresa CM 3 Ø 27 mm
- Bussola di riduzione CM 3/2
- Impianto di refrigerazione
- Oliatori
- Tirante M12
- Chiavi di servizio

Capacità max di foratura su acciaio con preforo (s235jr)	32 mm
Capacità di fresatura con fresa a inserti	80 mm
Capacità di fresatura	20 mm
Cono morse	CM 3
Mandrino	1 - 13 mm B16
Velocità del mandrino	100 ÷ 2080 rpm
Corsa mandrino	130 mm
Rotazione mandrino	Dx - Sx
Canotto	75 mm
Colonna	115 mm
Corsa testa	405 mm
Divisione avanzamento verticale manuale	0,05 mm
Velocità di discesa	0,12 - 0,18 - 0,25 mm/g
Distanza asse mandrino - colonna	197 mm
Distanza tra naso macchina e tavola	600 mm
Dimensione tavola	585 x 190 mm
Cava	12 mm
Spostamento tavola longitudinale	180 mm
Spostamento tavola trasversale	380 mm
Dimensioni base	470 x 670 mm
Motore	400 V 50 Hz 1,5 kW
Pompa di refrigerazione	400v 50 Hz 0.4 KW
Dimensioni	928 x 910 x 1700h mm
Peso netto	310 kg

T052/400V
€ 4330,00
TRAPANO FRESA A COLONNA

Con scelta senso di rotazione e trasmissione a cinghia.

ACCESSORI INCLUSI

- Mandrino a cremagliera 1 ÷ 13 B16
- Attacco mandrino forato CM 3 B16
- Bussola di riduzione CM 3/2
- Impianto di refrigerazione
- Oliatori
- Tirante M12
- Chiavi di servizio

Capacità max di foratura su acciaio con preforo (s235jr)	32 mm
Capacità di fresatura con fresa a inserti	80 mm
Capacità di fresatura	20 mm
Cono morse	CM 3
Mandrino	1 - 13 mm B16
Velocità del mandrino	100 ÷ 2080 rpm
Corsa mandrino	130 mm
Rotazione mandrino	Dx - Sx
Colonna	115 mm
Canotto	75 mm
Corsa testa	405 mm
Divisione avanzamento verticale manuale	0,05 mm
Distanza asse mandrino - colonna	197 mm
Distanza tra naso macchina e tavola	600 mm
Dimensione tavola	585 x 190 mm
Cava	12 mm
Spostamento tavola longitudinale	180 mm
Spostamento tavola trasversale	380 mm
Dimensioni base	470 x 670 mm
Motore	400 V 50 Hz 1,5 kW
Pompa di refrigerazione	400v 50 Hz 0.4 KW
Dimensioni	928 x 910 x 1700h mm
Peso netto	300 kg



T046
€ 3750,00
TRAPANO FRESA DA BANCO

Con scelta senso di rotazione e trasmissione a cinghia.

ACCESSORI INCLUSI

- Mandrino a cremagliera 1 ÷ 13 B16
- Attacco mandrino forato CM 3 B16
- Attacco fresa CM 3 Ø 27 mm
- Bussola di riduzione CM 3/2
- Oliatori
- Tirante M12
- Chiavi di servizio

Capacità max di foratura su acciaio con preforo [s235jr]	32 mm
Capacità di fresatura con fresa a inserti	80 mm
Capacità di fresatura	20 mm
Cono morse	CM 3
Mandrino	1 - 13 mm B16
Velocità del mandrino	100 ÷ 2080 rpm
Corsa mandrino	130 mm
Rotazione mandrino	Dx - Sx
Canotto	75 mm
Colonna	115 mm
Corsa testa	405 mm
Divisione avanzamento verticale manuale	0,05 mm
Distanza asse mandrino - colonna	200 mm
Distanza tra naso macchina e tavola	457 mm
Dimensione tavola	730 x 210 mm
Cava	14 mm
Spostamento tavola longitudinale	175 mm
Spostamento tavola trasversale	500 mm
Motore	230 V 50 Hz 1,5 kW
Dimensioni base	400 x 600 mm
Peso netto	250 kg

0599
€ 421,00
BANCO UNIVERSALE PER TRAPANI FRESA

Con vano porta attrezzi e serratura.



Dimensioni base	415 x 625 x 750h mm
Dimensioni vasca	615 x 820 x 30h mm
Dimensioni fondo vasca	530 x 735 mm
Portata	400 kg
Peso netto	59 kg



TRAPANO RADIALE



Dimensioni tavola (mm)

CM

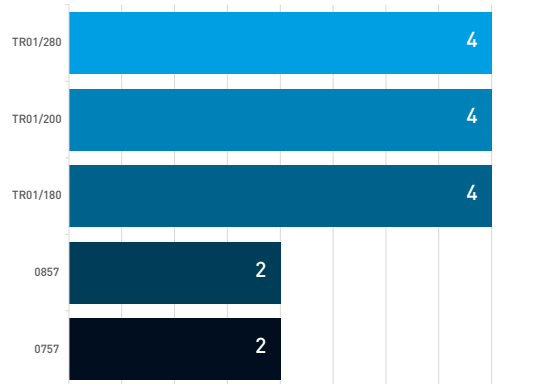
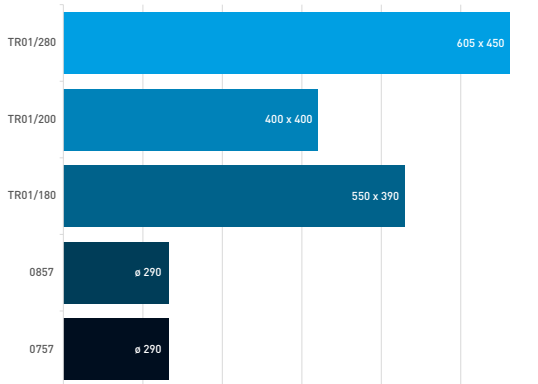

Corsa mandrino (mm)

Diametro colonna (mm)

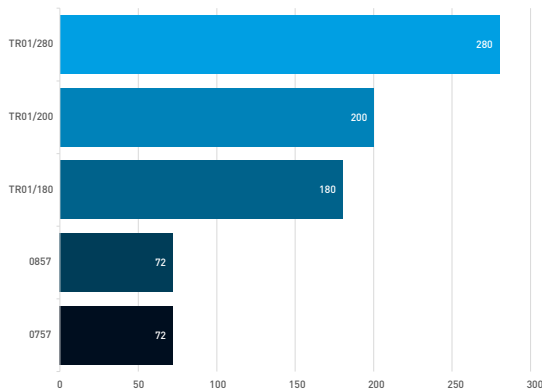
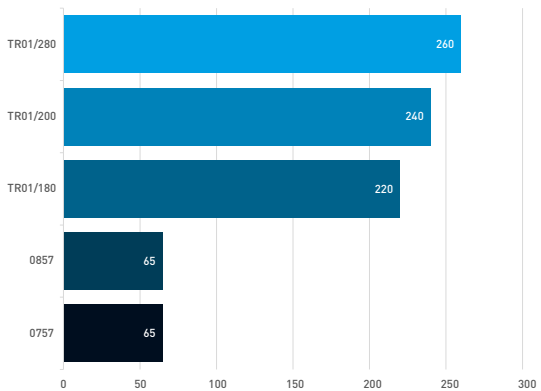

TR01/280

€ 27650,00

TRAPANO RADIALE

Bloccaggio idraulico tra braccio e colonna, discesa automatica, inversione di marcia, sistema di refrigerazione, Dotato di illuminazione Led. Con cambio di velocità ad ingranaggi.

 1 **Salita motorizzata**

 2 **Illuminazione**

 3 **Cubo**

 4 **Discesa automatica**
ACCESSORI INCLUSI

- Mandrino a cremagliera 3 ÷ 13 mm B18
- Attacco mandrino forato CM 4 B18
- Bussola di riduzione CM 4/3
- Bussola di riduzione CM 3/2
- Lampada a LED
- Impianto di refrigerazione
- Cubo base

Capacità di foratura su ghisa con preforo	Ø 50 mm
Capacità max di foratura su acciaio con preforo [s235]r	Ø 40 mm
Capacità di foratura continua	Ø 40 mm
Cono morse	CM 4
Mandrino	
Velocità del mandrino	(12) 40 ÷ 1896 rpm
Corsa mandrino	260 mm
Canotto	Ø 67 mm
Colonna	280 mm
Distanza asse mandrino - colonna	1370 mm
Distanza tra naso macchina e tavola	840 mm
Distanza tra naso macchina e base	1210 mm
Velocità di discesa	(4) 0.13 ÷ 0.54 mm/g
Dimensioni cubo	610 x 460 x 370 mm
Cava	16 mm 20 mm
Dimensioni base	1960 x 800 mm
Motore	400 V 50 Hz 3,0 kW
Motore di sollevamento braccio radiale	400 V 50 Hz 0,75 kW
Pompa di refrigerazione	400 V 50 Hz 90 W
Dimensioni	2050 x 820 x 2480 mm
Peso netto	2100 kg



TR01/200
€ 19150,00
TRAPANO RADIALE

Discesa automatica, inversione di marcia, sistema di refrigerazione, dotato di illuminazione Led. Con cambio di velocità ad ingranaggi.

- 1** Salita motorizzata
- 2** Illuminazione
- 3** Cubo
- 4** Discesa automatica

ACCESSORI INCLUSI

- Mandrino a cremagliera 3 ÷ 13 mm B18
- Attacco mandrino forato CM 4 B18
- Bussola di riduzione CM 4/3
- Bussola di riduzione CM 3/2
- Lampada a LED
- Impianto di refrigerazione
- Cubo base

Capacità di foratura su ghisa con preforo	50 mm
Capacità max di foratura su acciaio con preforo (s235jr)	40 mm
Capacità di foratura continua	36 mm
Cono morse	CM 4
Mandrino	3 ÷ 13 mm B18
Velocità del mandrino	(6) 75 ÷ 1220 rpm
Corsa mandrino	240 mm
Canotto	70 mm
Colonna	200 mm
Distanza asse mandrino - colonna	1020 mm
Distanza tra naso macchina e tavola	860 mm
Distanza tra naso macchina e base	1210 mm
Velocità di discesa	(3) 0,1 - 0,16 - 0,25 mm/g
Dimensioni cubo	400 x 400 x 350 mm
Cava	18 mm
Dimensioni base	1370 x 700 mm
Motore	400 V 50 Hz 1,5 kW
Motore di sollevamento braccio radiale	400 V 50 Hz 0,75 kW
Pompa di refrigerazione	400 V 50 Hz 90 W
Dimensioni	1760 x 770 x 2100h mm
Peso netto	1250 kg



TR01/180 FERVIplus
€ 12290,00
TRAPANO RADIALE

Discesa automatica, inversione di marcia, sistema di refrigerazione, dotato di illuminazione Led. Con cambio di velocità ad ingranaggi.

- 1 **Illuminazione**
- 2 **Cubo**
- 3 **Discesa automatica**

ACCESSORI INCLUSI

- Mandrino a cremagliera 3 ÷ 16 mm B16
- Attacco mandrino forato CM 4 B16
- Bussola di riduzione CM 4/3
- Lampada a LED
- Impianto di refrigerazione
- Cubo base

Capacità di foratura su ghisa con preforo	40 mm
Capacità max di foratura su acciaio con preforo (s235jr)	32 mm
Capacità di foratura continua	28 mm
Cono morse	CM 4
Mandrino	3 ÷ 16 mm B16
Velocità del mandrino	(6) 75 ÷ 1220 rpm
Corsa mandrino	220 mm
Canotto	65 mm
Colonna	180 mm
Distanza asse mandrino - colonna	350 ÷ 870 mm
Distanza tra naso macchina e tavola	0 ÷ 640 mm
Distanza tra naso macchina e base	310 ÷ 980 mm
Velocità di discesa	(3) 0,1 - 0,16 - 0,25 mm/g
Dimensioni cubo	550 x 390 x 350 mm
Cava	18 mm
Dimensioni base	1300 x 650 mm
Motore	400 V 50 Hz 1,5 kW
Motore di sollevamento braccio radiale	400V 50 Hz 0,55 kW
Pompa di refrigerazione	400V 50 Hz 0,40 kW
Dimensioni	1400 x 650 x 1900 h mm
Peso netto	1050 kg



0857
€ 1010,00
TRAPANO A COLONNA RADIALE CON TRASMISSIONE A CINGHIA

Tavola girevole e inclinabile con doppio braccio, testa inclinabile, impianto elettrico con circuito separato a 24V per i comandi bordo macchina.

ACCESSORI INCLUSI

- Mandrino Autoserrante 1 - 16 mm B16
- Attacco mandrino CM 2



Capacità di foratura su ghisa con preforo	Ø 20 mm
Capacità max di foratura su acciaio con preforo (s235jr)	Ø 16 mm
Capacità di foratura continua	Ø 12 mm
Cono morse	CM 2
Mandrino	1 - 16 mm B16
Velocità del mandrino	(12) 300 ÷ 2550 rpm
Corsa mandrino	65 mm
Canotto	Ø 40 mm
Colonna	Ø 72 mm
Spostamento radiale	280 mm
Inclinazione testa	90° Sx ; 45° Dx
Altezza	1600 mm
Distanza asse mandrino - colonna	375 mm
Distanza tra naso macchina e base	1290 mm
Dimensioni tavola	Ø 290 mm
Motore	230 V 50 Hz 0,375 kW
Dimensioni	950 x 300 x 1600 mm
Peso netto	60 kg

0757
€ 768,00
TRAPANO DA BANCO RADIALE CON TRASMISSIONE A CINGHIA

Tavola girevole e inclinabile con doppio braccio, testa inclinabile, impianto elettrico con circuito separato a 24V per i comandi bordo macchina.

ACCESSORI INCLUSI

- Mandrino Autoserrante 1 - 16 mm B16
- Attacco mandrino CM 2



Capacità di foratura su ghisa con preforo	Ø 20 mm
Capacità max di foratura su acciaio con preforo (s235jr)	Ø 16 mm
Capacità di foratura continua	Ø 12 mm
Cono morse	CM 2
Mandrino	1 - 16 mm B16
Velocità del mandrino	(12) 300 ÷ 2550 rpm
Corsa mandrino	65 mm
Canotto	Ø 40 mm
Colonna	Ø 72 mm
Spostamento radiale	280 mm
Inclinazione testa	90° Sx ; 45° Dx
Altezza	810 mm
Distanza asse mandrino - colonna	375 mm
Distanza tra naso macchina e base	505 mm
Dimensioni tavola	Ø 290 mm
Inclinazione tavola	± 45°
Motore	230 V 50 Hz 0,375 kW
Dimensioni	950 x 300 x 810h mm
Peso netto	46 kg





TRAPANI A COLONNA

T145



T066



T062



T041/..



T072...



T032DA



T032



T071



0252/...



0754/...



0752CM3



0752



0186



TRAPANI A COLONNA

CM

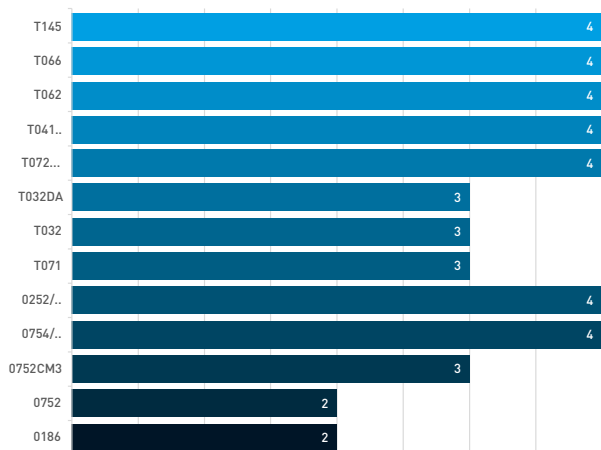

Corsa mandrino (mm)

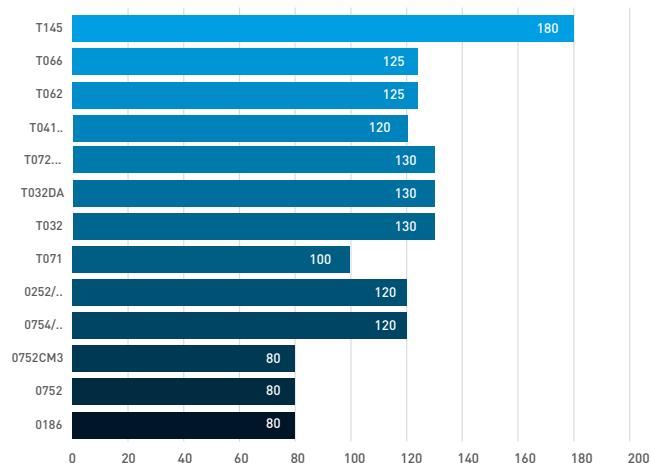

Diametro colonna (mm)

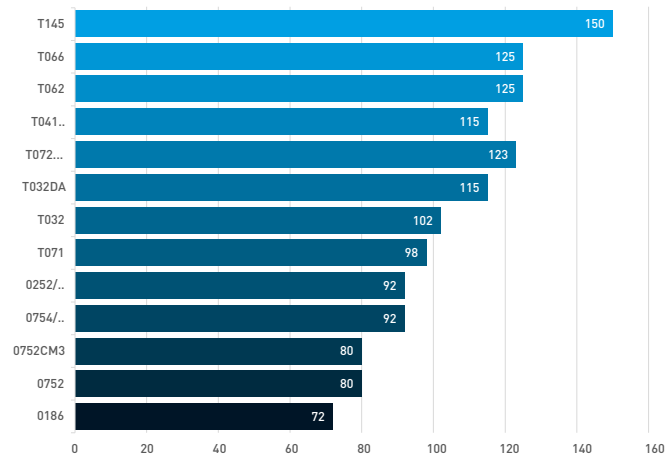

Dimensioni tavola (mm)

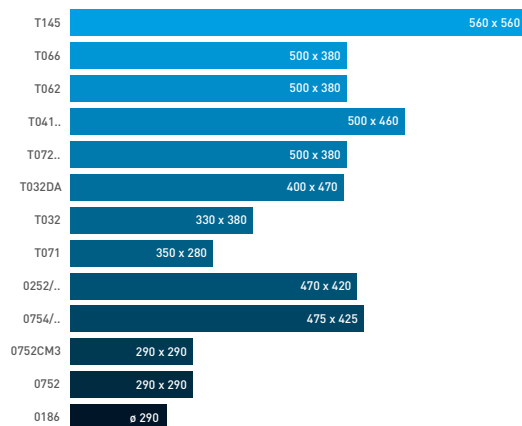

T145
€ 9330,00
TRAPANO AD INGRANAGGI

Discesa automatica, inversione di marcia, sistema di refrigerazione e illuminazione, tavola parzialmente girevole.

- 1** Motore ad induzione
- 2** Leva cambio
- 3** Protezione mandrino
- 4** Pompa di refrigerazione

ACCESSORI INCLUSI

- Mandrino a cremagliera 1 ÷ 13 mm B16
- Attacco mandrino CM 4 B16
- Bussola di riduzione CM 4/3
- Bussola di riduzione CM 3/2

Capacità di foratura su ghisa con preforo	Ø 45 mm
Capacità max di foratura su acciaio con preforo (s235jr)	Ø 40 mm
Capacità di foratura continua	Ø 35 mm
Cono morse	CM 4
Mandrino	1 ÷ 13 mm B16
Velocità del mandrino	(18) 50 ÷ 1450 rpm
Corsa mandrino	180 mm
Rotazione mandrino	Dx - Sx
Canotto	Ø 75 mm
Colonna	Ø 150 mm
Velocità di discesa	(2) 0,1 - 0,20 mm/g
Distanza asse mandrino - colonna	350 mm
Distanza tra naso macchina e tavola	780 mm
Distanza tra naso macchina e base	1320 mm
Dimensione tavola	560 x 560 mm
Cava	18 mm
Inclinazione tavola	±90°
Dimensioni base	500 x 730 mm
Motore	400 V 50 Hz 1,5 / 2,4 kW
Pompa di refrigerazione	400 V 50 Hz 40 W
Dimensioni	935 x 530 x 2280 mm
Peso netto	550 kg

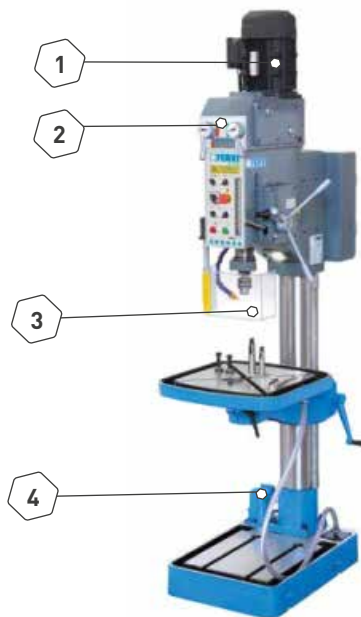
T066
€ 6320,00
TRAPANO AD INGRANAGGI

Discesa automatica, inversione di marcia, sistema di refrigerazione, tavola reversibile con morsa di 145 mm, dotato di illuminazione.

- 1** Motore ad induzione
- 2** Leva cambio
- 3** Protezione mandrino
- 4** Pompa di refrigerazione

ACCESSORI INCLUSI

- Mandrino a cremagliera 1 ÷ 13 B16
- Attacco mandrino CM 4 B16
- Bussola di riduzione CM 4/3
- Bussola di riduzione CM 3/2



Capacità di foratura su ghisa con preforo	Ø 40 mm
Capacità max di foratura su acciaio con preforo (s235jr)	Ø 35 mm
Capacità di foratura continua	Ø 30 mm
Cono morse	CM 4
Mandrino	1 ÷ 13 mm B16
Velocità del mandrino	(12) 75 ÷ 3200 rpm
Corsa mandrino	125 mm
Rotazione mandrino	Dx - Sx
Canotto	Ø 75 mm
Colonna	Ø 125 mm
Velocità di discesa	(3) 0,1 - 0,18 - 0,26 mm/g
Distanza asse mandrino - colonna	320 mm
Distanza tra naso macchina e tavola	80-680 mm
Distanza tra naso macchina e base	1140 mm
Dimensione tavola	500 x 380 mm
Cava	14 mm
Inclinazione tavola	±90°
Morsa	125 mm
Dimensioni base	470 x 670 mm
Motore	400 V 50 Hz 1,1/1,5 kW
Pompa di refrigerazione	400 V 50 Hz 75 W
Dimensioni	500 x 750 x 2000 mm
Peso netto	400 kg

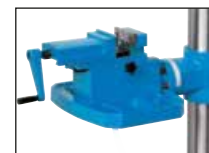
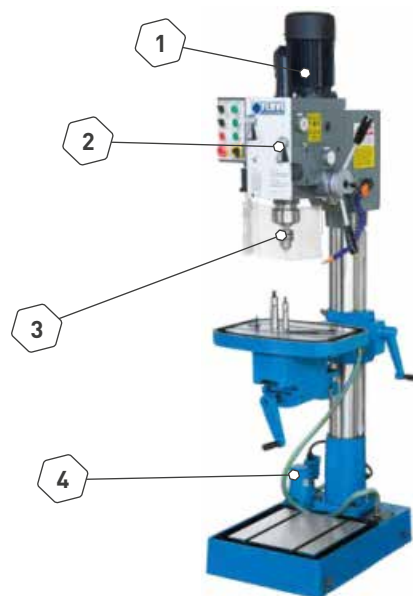

T062 FERVIplus
€ 5310,00
TRAPANO AD INGRANAGGI

Inversione di marcia, tavola inclinabile con morsa di 145 mm. Dotato di illuminazione.

- 1 **Motore ad induzione**
- 2 **Leva cambio**
- 3 **Protezione mandrino**
- 4 **Tavola ribaltabile con morsa incorporata**

ACCESSORI INCLUSI

- Mandrino a cremagliera 1 ÷ 13 B16
- Attacco mandrino forato CM 4
- Bussola di riduzione CM 4/3

Capacità di foratura su ghisa con preforo	Ø 40 mm
Capacità max di foratura su acciaio con preforo [s235jr]	Ø 35 mm
Capacità di foratura continua	Ø 30 mm
Cono morse	CM 4
Mandrino	1 ÷ 13 mm B16
Velocità del mandrino	(12) 75 ÷ 3200 rpm
Corsa mandrino	125 mm
Rotazione mandrino	Dx - Sx
Canotto	Ø 75 mm
Colonna	Ø 125 mm
Distanza asse mandrino - colonna	320 mm
Distanza tra naso macchina e tavola	80 ÷ 680 mm
Distanza tra naso macchina e base	1140 mm
Dimensioni tavola	500 x 380 mm
Cava	14 mm
Inclinazione tavola	±90°
Morsa	125 mm
Dimensioni base	460 x 650 mm
Motore	400 V 50 Hz 1,1/1,5 kW
Dimensioni	500 x 750 x 2000 mm
Peso netto	350 kg

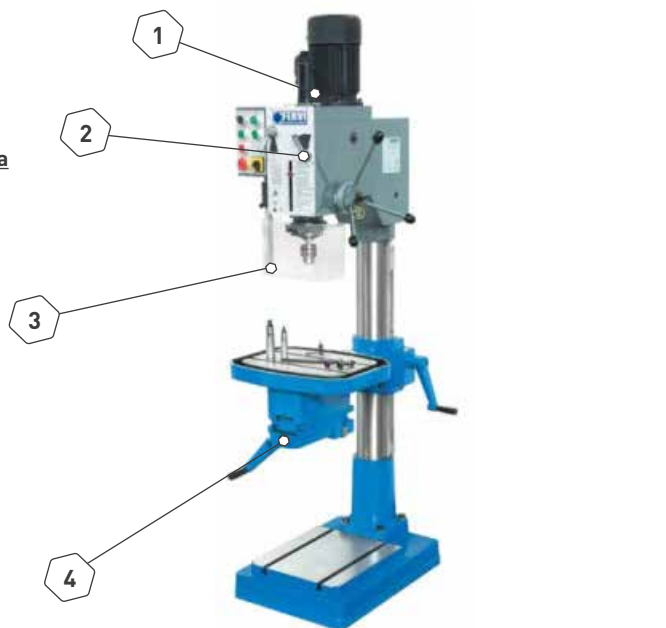
T041DA
€ 5200,00
TRAPANO AD INGRANAGGI

Inversione di marcia, maschiatura temporizzata, discesa automatica e impianto di refrigerazione, tavola girevole.

- 1 **Motore ad induzione**
- 2 **Leva cambio**
- 3 **Protezione mandrino**
- 4 **Pompa di refrigerazione**

ACCESSORI INCLUSI

- Mandrino autoserrante 1 ÷ 16 B16
- Attacco mandrino forato CM 4 B16
- Bussola di riduzione CM 4/3

Capacità di foratura su ghisa con preforo	Ø 40 mm
Capacità max di foratura su acciaio con preforo [s235jr]	Ø 35 mm
Capacità di foratura continua	Ø 30 mm
Capacità di maschiatura	22 mm
Cono morse	CM 4
Mandrino	1 ÷ 16 B16
Velocità del mandrino	(12) 75 ÷ 3200 rpm
Corsa mandrino	120 mm
Rotazione mandrino	Dx - Sx
Inclinazione testa	±60°
Canotto	Ø 76 mm
Colonna	Ø 115 mm
Velocità di discesa	(3) 0,1 - 0,18 - 0,26 mm/g
Distanza asse mandrino - colonna	297 mm
Distanza tra naso macchina e tavola	715 mm
Distanza tra naso macchina e base	1180 mm
Dimensione tavola	500 x 460 mm
Cava	14 mm
Dimensioni base	470 x 670 mm
Motore	400 V 50 Hz 1,1/1,5 kW
Dimensioni	700 x 480 x 1850 mm
Peso netto	340 kg

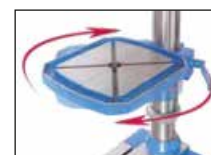
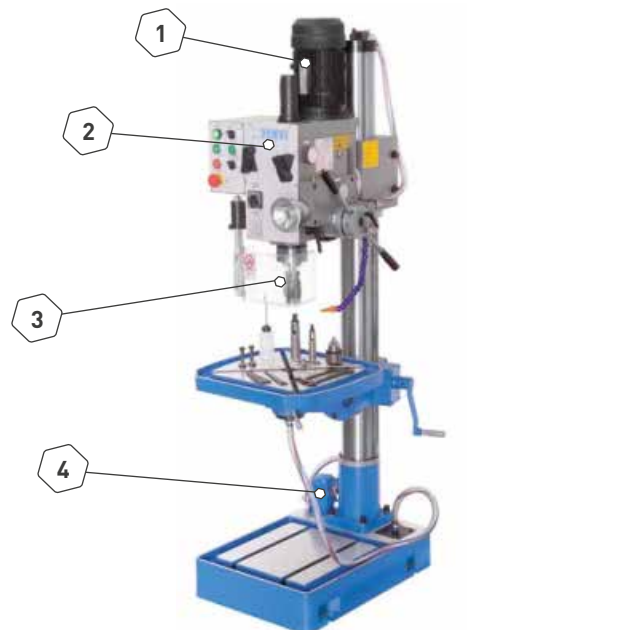

T041
€ 4850,00
TRAPANO AD INGRANAGGI

Inversione di marcia, testa inclinabile e maschiatura temporizzata, tavola parzialmente girevole

- 1** Motore ad induzione
- 2** Leva cambio
- 3** Protezione mandrino

ACCESSORI INCLUSI

- Mandrino autoserrante 1 ÷ 16 B16
- Attacco mandrino forato CM 4 B16
- Bussola di riduzione CM 4/3
- Bussola di riduzione CM 3/2

Capacità di foratura su ghisa con preforo	Ø 40 mm
Capacità max di foratura su acciaio con preforo (s235jr)	Ø 35 mm
Capacità di foratura continua	Ø 30 mm
Capacità di maschiatura	22 mm
Cono morse	CM 4
Mandrino	1 ÷ 16 B16
Velocità del mandrino	(12) 75 ÷ 3200 rpm
Corsa mandrino	120 mm
Rotazione mandrino	Dx - Sx
Inclinazione testa	±60°
Canotto	Ø 76 mm
Colonna	Ø 115 mm
Distanza asse mandrino - colonna	297 mm
Distanza tra naso macchina e tavola	715 mm
Distanza tra naso macchina e base	1180 mm
Dimensione tavola	500 x 460 mm
Cava	14 mm
Dimensioni base	650 x 450 x 80 mm
Motore	400 V 50 Hz 1,1/1,5 kW
Dimensioni	700 x 480 x 1820 mm
Peso netto	330 kg

T072DA
€ 8770,00
TRAPANO A COLONNA CON TRASMISSIONE A CINGHIA

Discesa automatica, inversione di marcia, sistema di refrigerazione, tavola reversibile con morsa di 140 mm.

- 1** Motore ad induzione
- 2** Protezione mandrino
- 3** Tavola ribaltabile con morsa incorporata

ACCESSORI INCLUSI

- Mandrino a cremagliera 1 ÷ 13 mm B16
- Attacco mandrino CM 4 B16
- Bussola di riduzione CM 4/3
- Bussola di riduzione CM 3/2

Capacità di foratura su ghisa con preforo	Ø 38 mm
Capacità max di foratura su acciaio con preforo (s235jr)	Ø 32 mm
Capacità di foratura continua	Ø 28 mm
Cono morse	CM 4
Mandrino	1 ÷ 13 B16
Velocità del mandrino	100 ÷ 2200 rpm
Corsa mandrino	130 mm
Canotto	75 mm
Colonna	123 mm
Divisione avanzamento verticale manuale	0,05 mm
Velocità di discesa	(3) 0,05 - 0,1 - 0,2 mm/g
Distanza tra naso macchina e tavola	300 mm
Distanza tra naso macchina e base	1220 mm
Dimensione tavola	500 x 380 mm
Cava	14 mm
Inclinazione tavola	±90°
Morsa	125 mm
Dimensioni base	460 x 670 mm
Motore	400 V 50 Hz 1,1/1,9 kW
Pompa di refrigerazione	400 V 50 Hz 75 W
Dimensioni	700 x 1100 x 1900 mm
Peso netto	385 kg



T072 FERVIplus
€ 7090,00
TRAPANO A COLONNA CON TRASMISSIONE A CINGHIA

Inversione di marcia, tavola reversibile con morsa da 140 mm, sistema di refrigerazione.

- 1 **Motore ad induzione**
- 2 **Protezione mandrino**
- 3 **Tavola ribaltabile con morsa incorporata**

ACCESSORI INCLUSI

- Mandrino a cremagliera 1 ÷ 13 mm B16
- Attacco mandrino CM 4 B16
- Bussola di riduzione CM 3/2
- Bussola di riduzione CM 4/3

Capacità di foratura su ghisa con preforo	Ø 38 mm
Capacità di foratura su acciaio con preforo	Ø 32 mm
Capacità di foratura continua	Ø 28 mm
Cono morse	CM 4
Mandrino	1 ÷ 13 mm B16
Velocità del mandrino	100 - 2200 rpm
Corsa mandrino	130 mm
Canotto	75 mm
Colonna	123 mm
Divisione avanzamento verticale manuale	0,05 mm
Distanza asse mandrino - colonna	300 mm
Distanza tra naso macchina e tavola	50 ÷ 800 mm
Distanza tra naso macchina e base	1220 mm
Dimensione tavola	500 x 380 mm
Cava	14 mm
Inclinazione tavola	±90°
Morsa	125 mm
Dimensioni base	610 x 670 mm
Motore	400 V 50 Hz 1,1 - 1,9 kW
Pompa di refrigerazione	400 V 50 Hz 75 W
Dimensioni	700 x 1100 x 1900 mm
Peso netto	375 kg

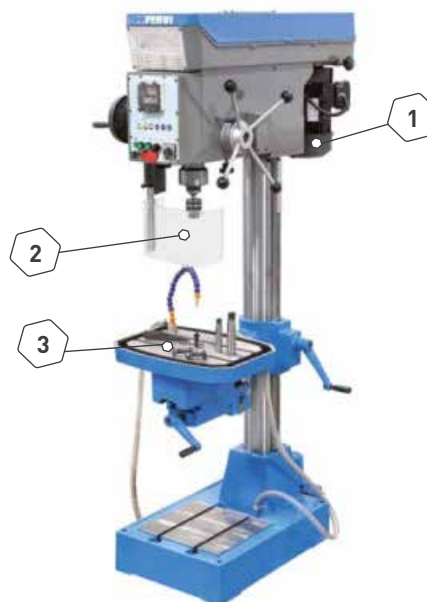
T032DA
€ 4220,00
TRAPANO A COLONNA CON TRASMISSIONE A CINGHIA

Con discesa automatica, sistema di refrigerazione, tavola parzialmente girevole, con morsa da 125 mm.

- 1 **Motore ad induzione**
- 2 **Protezione mandrino**
- 3 **Morsa inclusa**
- 4 **Leva sollevamento tavola**

ACCESSORI INCLUSI

- Mandrino a cremagliera 1 ÷ 16 B18
- Attacco mandrino CM 3
- Bussola di riduzione CM 3/2

Capacità di foratura su ghisa con preforo	Ø 31,75 mm
Capacità max di foratura su acciaio con preforo (s235jr)	Ø 31,75 mm
Capacità di foratura continua	Ø 25 mm
Cono morse	CM 3
Mandrino	1 ÷ 16 B18
Velocità del mandrino	(8) 160 ÷ 2200 rpm
Corsa mandrino	130 mm
Colonna	Ø 115 mm
Velocità di discesa	0,1-0,16-0,26 mm/giro
Distanza asse mandrino - colonna	223 mm
Distanza tra naso macchina e tavola	696 mm
Distanza tra naso macchina e base	1135 mm
Dimensioni tavola	400 x 470 mm
Corsa tavola	510 mm
Cava	14 mm
Dimensioni base	400 x 310 mm
Motore	400 V 50 Hz 0,85 kW / 1,1 kW
Pompa di refrigerazione	400 V 50 Hz 40 W
Dimensioni	900 x 545 x 1765 mm
Peso netto	340 kg

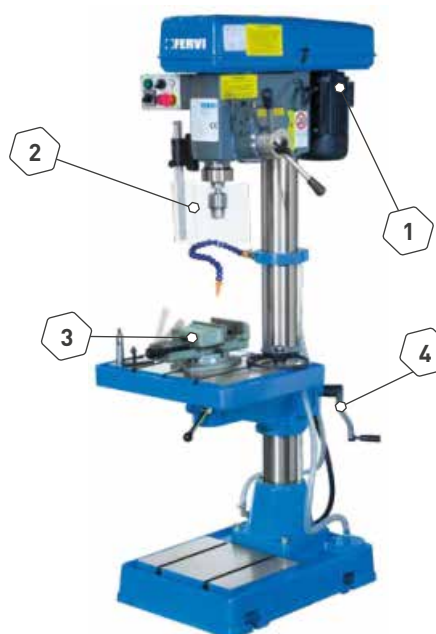

T032
€ 3350,00
TRAPANO A COLONNA CON TRASMISSIONE A CINGHIA

Tavola parzialmente girevole, con morsa da 125 mm.

- 1** Motore ad induzione
- 2** Protezione mandrino
- 3** Morsa inclusa
- 4** Leva sollevamento tavola

ACCESSORI INCLUSI

- Mandrino a cremagliera 1 ÷ 16 B18
- Attacco mandrino CM 3
- Bussola di riduzione CM 3/2

Capacità di foratura su ghisa con preforo	Ø 31,75 mm
Capacità max di foratura su acciaio con preforo [s235jr]	Ø 31,75 mm
Cono morse	CM 3
Capacità di foratura continua	Ø 25 mm
Mandrino	1 ÷ 16 B18
Velocità del mandrino	[9] 160 ÷ 1880 rpm
Corsa mandrino	130 mm
Colonna	Ø 102 mm
Distanza asse mandrino - colonna	230 mm
Distanza tra naso macchina e tavola	700 mm
Distanza tra naso macchina e base	1175 mm
Dimensioni tavola	330 x 380 mm
Corsa tavola	670 mm
Cava	14 mm
Dimensioni base	300 x 325 mm
Motore	400V 50Hz 1,5 kW
Dimensioni	900 x 430 x 1760 mm
Peso netto	280 kg

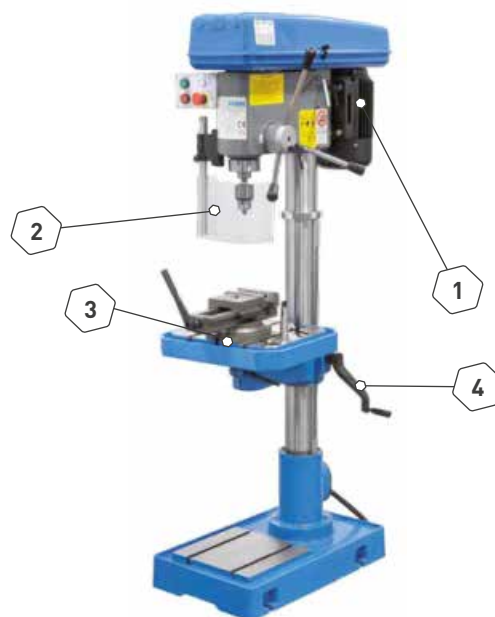
T071
€ 3480,00
TRAPANO A COLONNA CON TRASMISSIONE A CINGHIA

Inversione di marcia, funzione di maschiatura, tavola reversibile con morsa da 120 mm.

- 1** Motore ad induzione
- 2** Protezione mandrino
- 3** Tavola ribaltabile con morsa
- 4** Leva sollevamento tavola

ACCESSORI INCLUSI

- Mandrino a cremagliera 1 ÷ 16 mm B18
- Attacco mandrino CM 3 B18
- Bussola di riduzione CM 3/2
- Bussola di riduzione CM 2/1

Capacità di foratura su ghisa con preforo	Ø 30 mm
Capacità max di foratura su acciaio con preforo [s235jr]	Ø 28 mm
Capacità di foratura continua	Ø 25 mm
Cono morse	CM 3
Mandrino	1 ÷ 16 mm B18
Velocità del mandrino	[16] 127 ÷ 2380 rpm
Corsa mandrino	100 mm
Canotto	Ø 62 mm
Colonna	Ø 98 mm
Distanza asse mandrino - colonna	203 mm
Distanza tra naso macchina e tavola	145-895 mm
Distanza tra naso macchina e base	1200 mm
Dimensione tavola	350 x 280 mm
Cava	12 mm
Inclinazione tavola	±90°
Morsa	90 mm
Dimensioni base	410 x 560 mm
Motore	400 V 50 Hz 0,5 / 1 kW
Dimensioni	530 x 820 x 1700 mm
Peso netto	200 kg



0252/230V & 0252/400V
€ 2060,00
TRAPANO A COLONNA CON TRASMISSIONE A CINGHIA

Misuratore digitale di profondità, tavola reversibile con morsa integrata scorrevole, nuovo tendicinghia, luce a Led integrata.

- 1 **Illuminazione**
- 2 **Leva sollevamento tavola**
- 3 **Testa in fusione**
- 4 **Tavola inclinabile con morsa integrata**

ACCESSORI INCLUSI

- Mandrino autoserrante 1 - 16 mm B18
- Attacco mandrino CM 4

Capacità di foratura su ghisa con preforo	Ø 32 mm
Capacità max di foratura su acciaio con preforo (s235jr)	Ø 28 mm
Capacità di foratura continua	Ø 20 mm
Cono morse	CM 4
Mandrino	1 - 16 mm B18
Velocità del mandrino	(12) 150 ÷ 2450 rpm
Corsa mandrino	120 mm
Canotto	Ø 62 mm
Colonna	Ø 92 mm
Altezza	1720 mm
Distanza asse mandrino - colonna	255 mm
Distanza naso macchina-tavola	700 mm
Dimensioni tavola	460 x 425 mm
Distanza naso macchina-base	1220 mm
Cava	14 mm
Morsa	210 x 165 mm
Motore	230 V 50 Hz 1,5 kW
Peso netto	135 kg

0754/230V & 0754/400V
€ 1780,00
TRAPANO A COLONNA CON TRASMISSIONE A CINGHIA

Tavola inclinabile Impianto elettrico con circuito separato a 24V per i comandi bordo macchina.

- 1 **Motore ad induzione**
- 2 **Leva sollevamento tavola**
- 3 **Testa in fusione**
- 4 **Tavola inclinabile**

ACCESSORI INCLUSI

- Mandrino autoserrante 5 - 20 mm B22
- Attacco mandrino CM 4

Capacità di foratura su ghisa con preforo	Ø 32 mm
Capacità max di foratura su acciaio con preforo (s235jr)	Ø 28 mm
Capacità di foratura continua	Ø 20 mm
Cono morse	CM 4
Mandrino	5 - 20 mm B22
Velocità del mandrino	(12) 150 ÷ 2450 rpm
Corsa mandrino	120 mm
Canotto	Ø 62 mm
Colonna	Ø 92 mm
Altezza	1710 mm
Distanza asse mandrino - colonna	260 mm
Dimensioni tavola	460 x 425 mm
Cava	14 mm
Inclinazione tavola	± 45°
Motore	230 V 50 Hz 1,5 kW
Peso netto	125 kg



0752CM3
€ 1110,00
TRAPANO A COLONNA CON TRASMISSIONE A CINGHIA

Tavola girevole ed inclinabile. Impianto elettrico con circuito separato a 24V per i comandi bordo macchina.

ACCESSORI INCLUSI

- Mandrino autoserrante 1 - 16 mm B18
- Cavaconi
- Attacco mandrino CM 3
- Brugole



Capacità di foratura su ghisa con preforo	Ø 25 mm
Capacità max di foratura su acciaio con preforo (s235jr)	Ø 20 mm
Capacità di foratura continua	Ø 16 mm
Cono morse	CM 3
Mandrino	1 - 16 mm B18
Velocità del mandrino	(16) 220 ÷ 2840 rpm
Corsa mandrino	80 mm
Canotto	Ø 47 mm
Colonna	Ø 80 mm
Altezza	1630 mm
Distanza asse mandrino - colonna	175 mm
Distanza tra naso macchina e tavola	420 mm
Distanza tra naso macchina e base	1190 mm
Dimensioni tavola	290 x 290 mm
Cava	16 mm
Inclinazione tavola	± 45°
Tavola girevole	Si
Dimensioni base	460 x 275 mm
Motore	230 V 50 Hz 0,75 kW
Dimensioni	300 X 630 X 1630h mm
Peso netto	62 kg

0752
€ 1040,00
VERSIONE CM2 Ø 16 mm

0186
€ 922,00
TRAPANO A COLONNA CON TRASMISSIONE A CINGHIA

Tavola girevole e inclinabile. Impianto elettrico con circuito separato a 24V per i comandi bordo macchina.

ACCESSORI INCLUSI

- Mandrino autoserrante 1 - 16 mm B16
- Attacco mandrino CM 2



Capacità di foratura su ghisa con preforo	Ø 20 mm
Capacità max di foratura su acciaio con preforo (s235jr)	Ø 16 mm
Capacità di foratura continua	Ø 12 mm
Cono morse	CM 2
Mandrino	1 - 16 mm B16
Velocità del mandrino	(12) 280 ÷ 2380 rpm
Corsa mandrino	80 mm
Canotto	Ø 40 mm
Colonna	Ø 72 mm
Altezza	1580 mm
Distanza asse mandrino - colonna	160 mm
Distanza tra naso macchina e base	1110 mm
Dimensioni tavola	Ø 290 mm
Inclinazione tavola	± 45°
Motore	230 V 50 Hz 0,65 kW
Peso netto	50 kg





TRAPANI DA BANCO



CM

Corsa mandrino (mm)

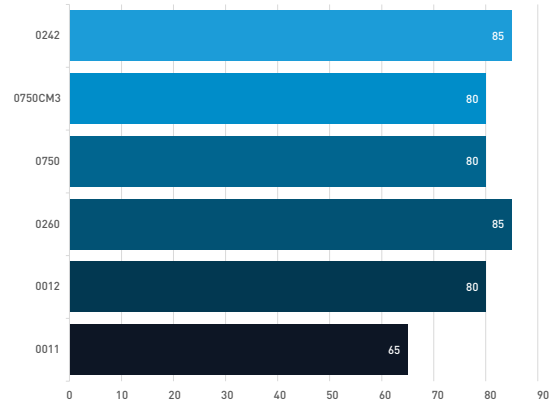

Diametro colonna (mm)

Dimensioni tavola (mm)

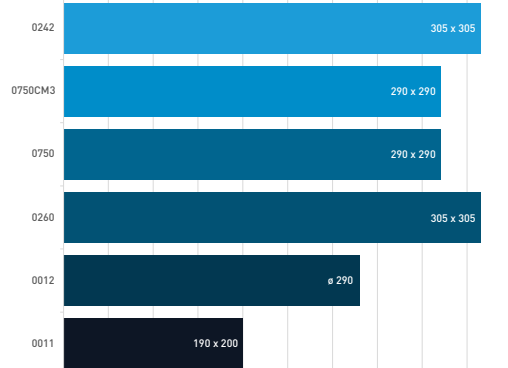
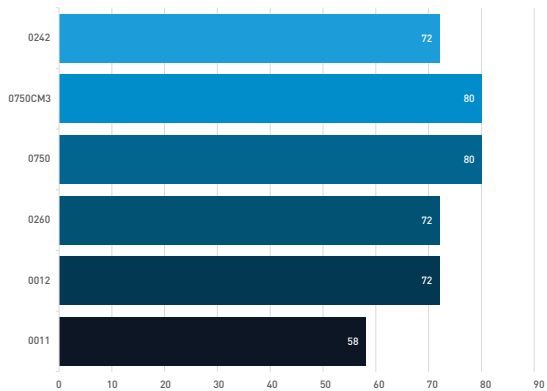

0242
€ 992,00
TRAPANO DA BANCO CON TRASMISSIONE A CINGHIA

Misuratore digitale di profondità, nuovo tendicinghia, luce a Led integrata, tavola girevole ed inclinabile. Impianto elettrico con circuito separato a 24V per i comandi bordo macchina.

- 1 **Motore ad induzione**
- 2 **Leva sollevamento tavola**
- 3 **Illuminazione**
- 4 **Tavola inclinabile**

ACCESSORI INCLUSI

- Mandrino autoserrante 1 - 16 mm B18
- Attacco mandrino CM 2

Capacità di foratura su ghisa con preforo	Ø 25 mm
Capacità max di foratura su acciaio con preforo [s235jr]	Ø 20 mm
Capacità di foratura continua	Ø 16 mm
Cono morse	CM 2
Mandrino	1 - 16 mm B18
Velocità del mandrino	(16) 180 ÷ 2770 rpm
Corsa mandrino	85 mm
Canotto	Ø 47 mm
Colonna	Ø 72 mm
Altezza	990 mm
Distanza asse mandrino - colonna	180 mm
Distanza naso macchina-tavola	420 mm
Distanza naso macchina-base	600 mm
Dimensioni tavola	305 x 305 mm
Cava	16 mm
Inclinazione tavola	± 45°
Motore	230 V 50 Hz 0,75 kW
Peso netto	60 kg

0750CM3
€ 985,00
TRAPANO DA BANCO CON TRASMISSIONE A CINGHIA

Tavola girevole ed inclinabile. Impianto elettrico con circuito separato a 24V per i comandi bordo macchina.

- 1 **Motore ad induzione**
- 2 **Leva sollevamento tavola**
- 3 **Tavola inclinabile**

ACCESSORI INCLUSI

- Mandrino autoserrante 1 - 16 mm B18
- Attacco mandrino CM 3
- Cavaconi
- Brugole

Capacità di foratura su ghisa con preforo	Ø 25 mm
Capacità max di foratura su acciaio con preforo [s235jr]	Ø 20 mm
Capacità di foratura continua	Ø 16 mm
Cono morse	CM 3
Mandrino	1 - 16 mm B18
Velocità del mandrino	(16) 220 ÷ 2840 rpm
Corsa mandrino	80 mm
Canotto	Ø 47 mm
Colonna	Ø 80 mm
Altezza	990 mm
Distanza asse mandrino - colonna	175 mm
Distanza naso macchina-tavola	420 mm
Distanza tra naso macchina e base	600 mm
Dimensioni tavola	290 x 290 mm
Cava	14 mm
Inclinazione tavola	± 45°
Tavola girevole	Si
Dimensioni base	460 x 275 mm
Motore	230 V 50 Hz 0,75 kW
Dimensioni	300 X 630 X 990h mm
Peso netto	57 kg

0750
€ 929,00
VERSIONE CM2 Ø 16 mm

0260
€ 875,00
TRAPANO DA BANCO CON TRASMISSIONE A CINGHIA

Misuratore digitale di profondità, nuovo tendicinghia, luce a Led integrata, tavola girevole ed inclinabile. Impianto elettrico con circuito separato a 24V per i comandi bordo macchina.

- 1 **Motore ad induzione**
- 2 **Leva sollevamento tavola**
- 3 **Illuminazione**
- 4 **Tavola inclinabile e girevole**

ACCESSORI INCLUSI

- Mandrino autoserrante 1 - 13 mm B16
- Attacco mandrino CM 2

Capacità di foratura su ghisa con preforo	Ø 20 mm
Capacità max di foratura su acciaio con preforo (s235jr)	Ø 16 mm
Capacità di foratura continua	Ø 12 mm
Cono morse	CM 2
Mandrino	1 - 13 mm B16
Velocità del mandrino	(16) 180 ÷ 2770 rpm
Corsa mandrino	85 mm
Canotto	Ø 40 mm
Colonna	Ø 72 mm
Altezza	980 mm
Distanza asse mandrino - colonna	160 mm
Distanza naso macchina-tavola	435 mm
Distanza naso macchina-base	625 mm
Dimensioni tavola	305 x 305 mm
Cava	16 mm
Inclinazione tavola	± 45°
Motore	230 V 50 Hz 0,55 kW
Peso netto	50 kg

0012
€ 682,00
TRAPANO DA BANCO CON TRASMISSIONE A CINGHIA

Tavola girevole e inclinabile. Impianto elettrico con circuito separato a 24V per i comandi bordo macchina.

- 1 **Motore ad induzione**
- 2 **Leva sollevamento tavola**
- 3 **Testa in fusione**
- 4 **Tavola inclinabile e girevole**

ACCESSORI INCLUSI

- Mandrino Autoserrante 1 - 16 mm B16
- Attacco mandrino CM 2

Capacità di foratura su ghisa con preforo	Ø 20 mm
Capacità max di foratura su acciaio con preforo (s235jr)	Ø 16 mm
Capacità di foratura continua	Ø 12 mm
Mandrino	1 - 16 mm B16
Velocità del mandrino	(12) 280 ÷ 2380 rpm
Corsa mandrino	80 mm
Canotto	Ø 40 mm
Colonna	Ø 72 mm
Altezza	990 mm
Distanza asse mandrino - colonna	160 mm
Distanza tra naso macchina e tavola	435 mm
Distanza tra naso macchina e base	650 mm
Dimensioni tavola	Ø 290 mm
Motore	230 V 50 Hz 0,65 kW
Peso netto	48 kg



0011

€ 505,00

TRAPANO DA BANCO CON TRASMISSIONE A CINGHIA

Spostamento verticale a cremagliera della tavola, tavola inclinabile. Impianto elettrico con circuito separato a 24V per i comandi bordo macchina.

ACCESSORI INCLUSI

- Mandrino autoserrante 1 - 13 mm B16



Capacità di foratura su ghisa con preforo	Ø 13 mm
Capacità max di foratura su acciaio con preforo (s235jr)	Ø 10 mm
Mandrino	1 - 13 mm B16
Velocità del mandrino	(5) 620 ÷ 2620 rpm
Corsa mandrino	65 mm
Canotto	Ø 40 mm
Colonna	Ø 58 mm
Altezza	690 mm
Distanza asse mandrino - colonna	130 mm
Distanza tra naso macchina e base	330 mm
Dimensione tavola	190 x 200 mm
Inclinazione tavola	± 45°
Motore	230 V 50 Hz 0,375 kW
Dimensioni	315 x 530 x 690h mm
Peso netto	25 kg



0518/20
€ 893,00
TRAPANO MAGNETICO

Con raffreddamento a liquido per frese a carotare fino a Ø 20 mm con attacco weldon Ø 19.05 mm e punte cilindriche fino a Ø 20 mm con codolo ridotto a Ø 13 mm.



Capacità di foratura continua	Ø 20 mm
Mandrino a cremagliera	Ø 13 mm
Albero	Weldon Ø 19,05 mm
Corsa mandrino	165 mm
Capacità max. di lavoro	Ø 20 mm
Forza magnetica max.	8500 N
Velocità del mandrino	650 rpm
Motore	230 V 50 Hz 0.9 kW
Dimensioni	300 x 260 x 450 mm
Valigetta	442 x 395 x 175 mm
Peso netto	15 kg

0518/30
€ 1220,00
TRAPANO MAGNETICO

Con raffreddamento a liquido per frese a carotare fino a Ø 30 mm con attacco weldon Ø 19.05 mm e punte cilindriche fino a Ø 20 mm con codolo ridotto a Ø 13 - 16 mm.

Capacità di foratura continua	Ø 20 mm
Mandrino a cremagliera	Ø 16 mm
Albero	Weldon Ø 19,05 mm
Corsa mandrino	175 mm
Capacità max. di lavoro	Ø 30 mm
Forza magnetica max.	11000 N
Velocità del mandrino	450 rpm
Dimensioni base	170 x 90 mm
Motore	230 V 50 Hz 1.1 kW
Dimensioni	360 x 280 x 490 mm
Valigetta	527 x 472 x 242 mm
Peso netto	23 kg

0518/50
€ 1670,00
TRAPANO MAGNETICO

Con raffreddamento a liquido per frese a carotare fino a Ø 50 mm con attacco weldon Ø 19.05 mm, punte con attacco conico cm 3 e punte cilindriche fino a Ø 20 mm con codolo ridotto a Ø 13 - 16 mm.

Capacità di foratura continua	Ø 20 mm
Mandrino a cremagliera	Ø 16 mm
Cono albero CM	3
Albero	Weldon Ø 19,05 mm
Corsa mandrino	220 mm
Capacità max. di lavoro	Ø 50 mm
Forza magnetica max.	15000 N
Velocità del mandrino	400 - 600 rpm
Dimensioni base	205 x 110 mm
Motore	230 V 50 Hz 1.5 kW
Dimensioni	400 x 310 x 475 mm
Valigetta	587 x 489 x 265 mm
Peso netto	35 kg



0518/38M
€ 1370,00
TRAPANO/MASCHIATORE MAGNETICO

Con raffreddamento a liquido per frese a carotare fino a \varnothing 38 mm con attacco weldon \varnothing 19.05 mm e punte coniche fino a \varnothing 20 mm. Capacità di maschiatura M4 - M16.

Capacità di foratura continua	\varnothing 20 mm
Cono albero CM	2
Albero	Weldon \varnothing 19,05 mm
Corsa mandrino	180 mm
Capacità max. di lavoro	\varnothing 38 mm
Capacità di maschiatura	M4 ÷ M16
Forza magnetica max.	12000 N
Velocità del mandrino	0 ÷ 500 0 ÷ 800 rpm
Motore	230 V 50 Hz 1,05 kW
Dimensioni base	205 x 105 mm
Dimensioni	280 x 320 x 510h mm
Peso netto	20 kg

0518/55H
€ 1720,00
TRAPANO MAGNETICO ORIZZONTALE

Per frese a carotare fino a \varnothing 55 mm con attacco weldon \varnothing 19.05 mm.

Albero	Weldon \varnothing 19,05 mm
Corsa mandrino	55 mm
Capacità max. di lavoro	\varnothing 55 mm
Forza magnetica max.	15500 N
Velocità del mandrino	640 rpm
Motore	230 V 50 Hz 1,9 kW
Dimensioni base	165 x 80 mm
Dimensioni	290 x 170 x 185 h mm
Valigetta	400 x 335 x 165 mm
Peso netto	8.5 kg

0518/80
€ 2150,00
TRAPANO MAGNETICO

Con raffreddamento a liquido per frese a carotare fino a \varnothing 80 mm con attacco weldon \varnothing 19.05 mm, punte con attacco conico cm 3 e punte cilindriche fino a \varnothing 20 mm con codolo ridotto a \varnothing 13 - 16 mm.

Capacità di foratura continua	\varnothing 20 mm
Cono albero CM	3
Albero	Weldon \varnothing 19,05 mm
Corsa mandrino	280 mm
Forza magnetica max.	20000 N
Velocità del mandrino	230 ÷ 770 rpm
Motore	230 V 50 Hz 1.8 kW
Dimensioni base	215 x 110 mm
Dimensioni	290 x 410 x 550h mm
Peso netto	35 kg



SEGATRICI A NASTRO

NEW
0230
0273
0692/230V

0692/400V
0255
0362
0132

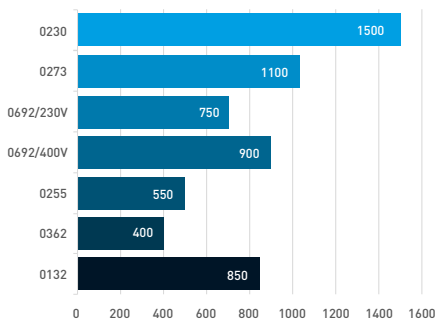

Potenza (kW)

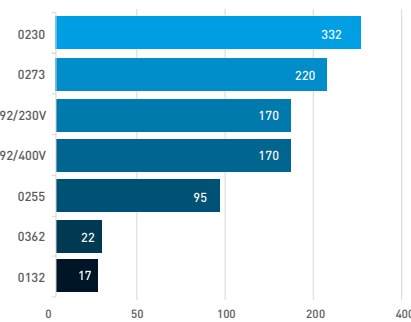

Peso netto (Kg)

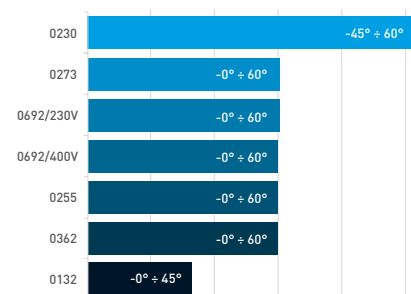

Angolo di taglio



Capacità di taglio 90°

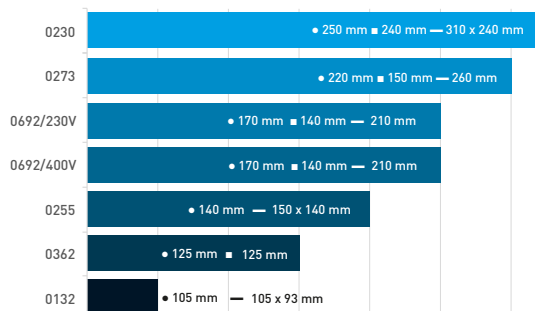

Capacità di taglio 45°

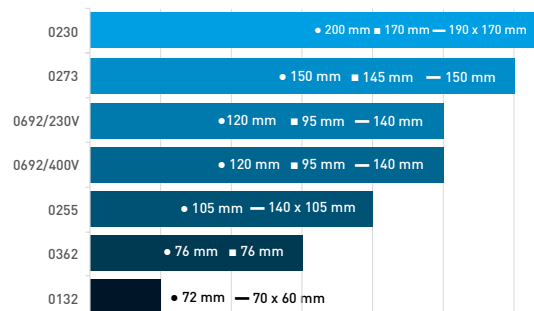

0230

 € 5850,00 **NEW**
SEGATRICE A NASTRO CON DISCESA MANUALE E IDRAULICA

Con strumento di regolazione tensione lama, sistema di refrigerazione, morsa rapida.

ACCESSORI INCLUSI

- Strumento di regolazione tensione lama
- Pompa refrigerante
- Morsa rapida



Dimensioni lama	2715 x 27 x 0,9 mm
Motore	400V 50 Hz 0.75 / 1,5 kW
Velocità di taglio	36 - 72 m/min
Angolo di taglio	-45° ÷ 60°
Capacità di taglio a 90°	• 250 mm ■ 240 mm — 310 x 240 mm
Capacità di taglio a 45°	• 200 mm ■ 170 mm — 190 x 170 mm
Ganasce	145 x 120h mm
Corsa laterale	380 mm
Apertura morsa	306 mm
Dimensioni	1500 x 670 x 1520 mm
Peso netto	332 Kg

0273

€ 4300,00

SEGATRICE A NASTRO CON DISCESA MANUALE E IDRAULICA

Con strumento di regolazione tensione lama, sistema di refrigerazione, morsa rapida.

ACCESSORI INCLUSI

- Strumento di regolazione tensione lama
- Pompa refrigerante
- Morsa rapida



Dimensioni lama	2450 x 27 x 0,9 mm
Motore trifase	400V 50 HZ 0,59 / 1,1 kW
Velocità di taglio	36 - 72 m/min
Angolo di taglio	0° ÷ 60°
Capacità di taglio a 90°	• 220 mm ■ 150 mm — 260 mm
Capacità di taglio a 45°	• 150 mm ■ 145 mm — 150 mm
Ganasce	150 x 120 h mm
Apertura morsa	260 mm
Dimensioni	1720 x 880 x 1810 h mm
Peso netto	220 kg



0692/230V & 0692/400V
€ 3400,00
SEGATRICE A NASTRO CON DISCESA MANUALE E IDRAULICA

Con strumento di regolazione tensione lama, sistema di refrigerazione, morsa rapida.

ACCESSORI INCLUSI

- Strumento di regolazione tensione lama
- Pompa refrigerante
- Morsa rapida



Dimensioni lama	2100 x 20 x 0,9 mm
Motore	230V 50 Hz 0,75 kW 400V 50 HZ 0,55 / 0,9 kW
Velocità di taglio	65 m/min
Angolo di taglio	0° ÷ 60°
Capacità di taglio a 90°	• 170 mm ■ 140 mm — 210 mm
Capacità di taglio a 45°	• 120 mm ■ 95 mm — 140 mm
Apertura morsa	260 mm
Dimensioni	1500 x 800 x 1620 h mm
Peso netto	170 kg

0255
€ 1790,00
SEGATRICE A NASTRO PER METALLI

Con sistema di refrigerazione, morsa rapida, basamento con vano portautensili.

ACCESSORI INCLUSI

- Strumento di regolazione tensione lama
- Pompa refrigerante
- Morsa rapida



Dimensioni lama	1735 x 13 x 0,65 mm
Motore	230 V 50 Hz 0,55 kW
Angolo di taglio	0 ÷ 60°
Velocità di taglio	34 m / min
Capacità di taglio a 90°	— 150 x 140 mm • 140 mm
Capacità di taglio a 45°	— 140 x 105 mm • 105 mm
Dimensioni base	470 x 700 mm
Dimensioni	530 x 1000 x 1260h mm
Peso netto	95 kg



0362

€ 864,00

SEGATRICE A NASTRO ELETTRONICA DA BANCO

Con motore inverter.



Dimensioni lama	1435 x 12,7 x 0,65 mm
Motore	230 V 50 60 Hz 0,4 kW
Velocità di taglio	35 ÷ 80 m/min
Angolo di taglio	0° ÷ 60°
Capacità di taglio a 90°	• 125 mm ■ 125 mm
Capacità di taglio a 45°	• 76 mm ■ 76 mm
Dimensioni	700 x 360 x 450h mm
Peso netto	22 kg

0132

€ 544,00

SEGATRICE A NASTRO

Da banco, trasportabile, a due velocità di taglio.



Dimensioni lama	1335 x 12,7 x 0,65 mm
Velocità	(2) 60 80 m / min
Angolo di taglio	0° ÷ 45°
Motore	230 V 50 Hz 0,850 kW
Capacità di taglio a 90°	• 105 mm — 105 x 93 mm
Capacità di taglio a 45°	• 72 mm — 70 x 60 mm
Peso netto	17 kg

0522

€ 286,00

SUPPORTO PIEGHEVOLE PER MACCHINE PORTATILI

Telaio robusto e resistente, altezza regolabile.



Portata	150 kg
Dimensioni piano	820 x 460 mm
Altezza tavola	600 - 715 - 745 - 770 - 795 - 820 mm
Distanza rulli	870 - 1070 - 1350 mm
Altezza rulli	37 ÷ 470 mm
Peso netto	17 kg

0133

€ 161,00

CAVALLETTO A RULLO

Diametro albero del rullo	Ø 52 x 350 mm
Altezza	690 / 1200 mm
Portata max	800 kg
Peso netto	15 kg

R003/09
€ 508,00
RULLIERA A PANTOGRAFO

Portata	130 kg
Diametro dei rulli	50 mm
Lunghezza	485 ÷ 1400 mm
Altezza	610 ÷ 950 mm
Ingombro	1460 x 660 x 950 h mm
Peso netto	31 kg

R001-
RULLIERA REGOLABILE IN ALTEZZA

Con piedini a regolazione indipendente dell'altezza.



Art.	€	Dimensioni	Distanza rulli	Dimensioni rulli	Altezza	Portata max	Peso netto
R001/04	€ 382,00	1000 x 460 mm	260 mm	Ø 60 x 360 mm M12	580 / 1030 mm	400 kg	23 kg
R001/07	€ 537,00	2000 x 450 mm	250 mm	Ø 60 x 360 mm M12	590 / 1050 mm	400 kg	37 kg

0642
€ 375,00
TRONCATRICE VELOCE

Per il taglio a secco di metalli, con carter di protezione disco.

Motore	230 V 50 Hz 2 kW
Dimensioni disco	355 x 3.0 x 25.4 mm
Velocità disco	3800 rpm
Angolo di taglio	± 45°
Capacità di taglio	■ 100 x 100 mm - ■ 200 x 40 mm - o 100 mm
Apertura morsa	155 mm - 190 mm - 230 mm
Peso netto	19 kg



0565
€ 189,00
SMERIGLIATRICE AD ALBERO FLESSIBILE

Con variatore di velocità a pedale.



Mandrino di precisione con chiave	0 - 4 mm
Velocità variabile	500 ÷ 22000 rpm
Lunghezza albero flessibile	900 mm
Motore	230 V 50 Hz 185 W

0568
€ 63,40
MINI SMERIGLIATRICE CON UTENSILI

Supporto da banco ed albero flessibile.



Mandrino di precisione con chiave	Ø 3 mm
Velocità variabile	8000 ÷ 32500 rpm
Lunghezza albero flessibile	1000 mm
Altezza supporto	650 mm
Capacità morsetto	65 mm
Motore	230 V 50 Hz 135 W

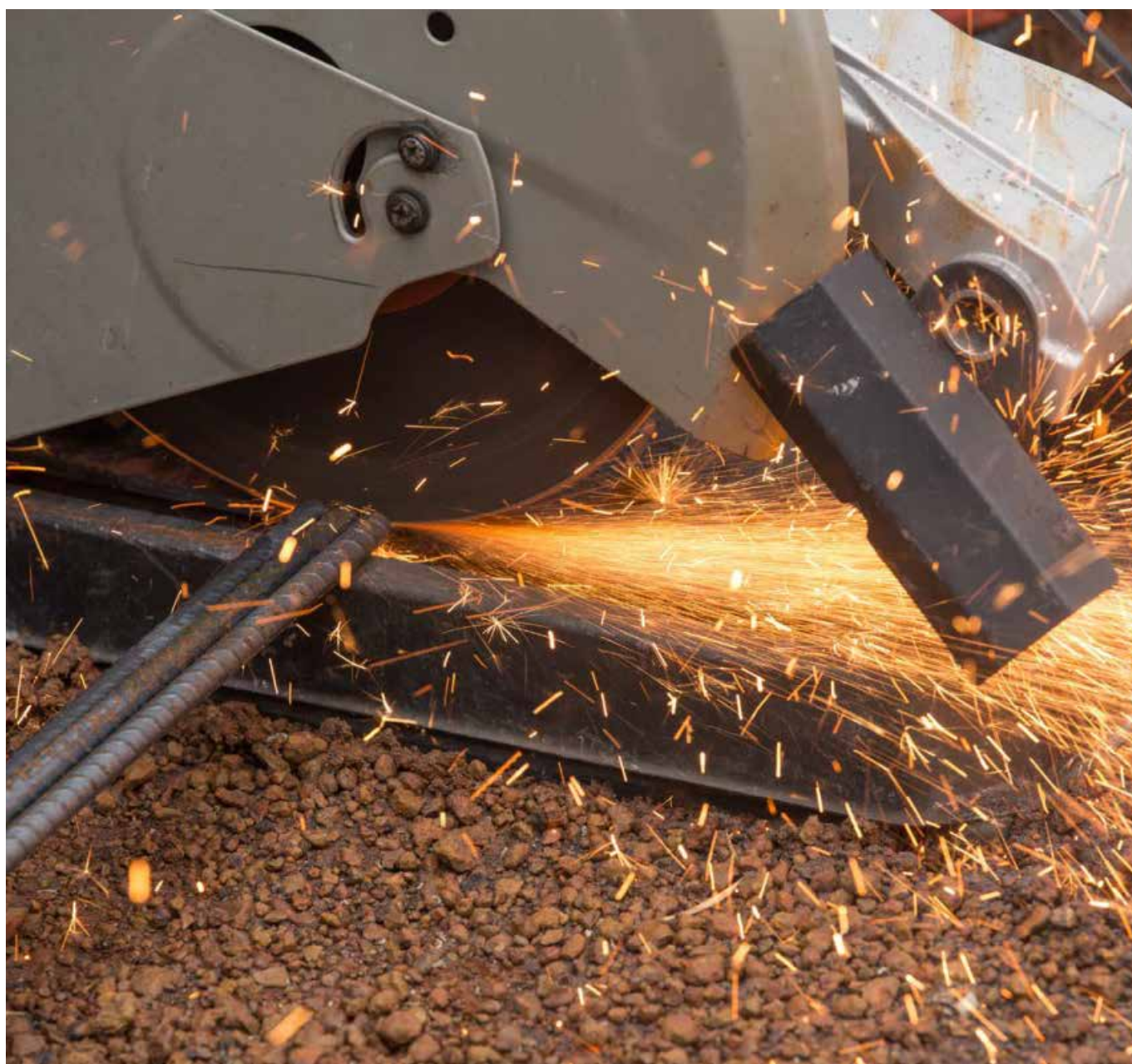

SMERIGLIATRICI

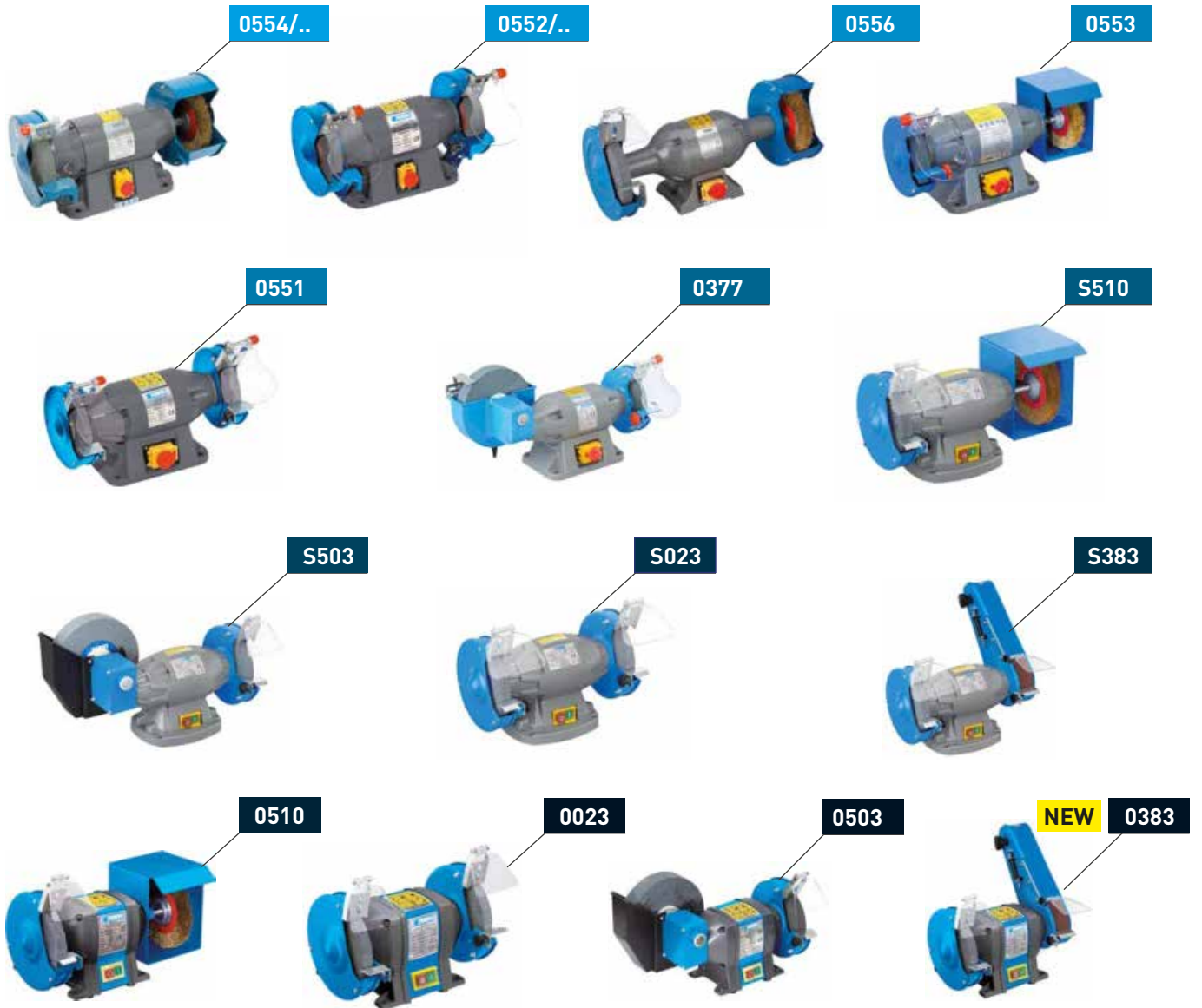

Potenza (kW)

Peso (Kg)

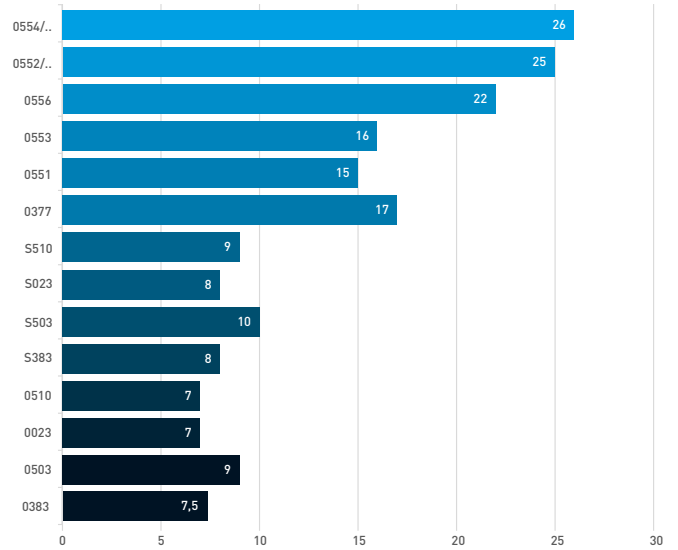
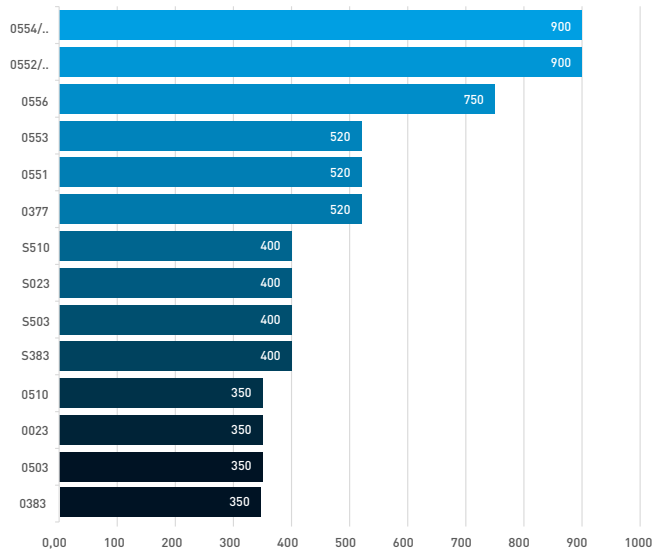

0554 & 0554/400V
€ 382,00
SMERIGLIATRICE COMBINATA PROFESSIONALE

Schermo di protezione mola. Squadretta per appoggio pezzo.



Spazzola	2950 rpm - Ø 200 x 25 x 20 mm
Mola a secco	2950 rpm - Ø 200 x 25 x 20 mm GR36
Motore	230V 50 Hz 0,9 kW 400V 50 Hz 0,9 kW
Tipo di utilizzo	S2 - 10 min
Peso netto	26 kg

0552 & 0552/400V
€ 351,00
SMERIGLIATRICE DA BANCO PROFESSIONALE

Schermi di protezione mole. Squadretta per appoggio pezzo.



Mola a secco	2950 rpm - Ø 200 x 25 x 20 mm GR36 - GR80
Motore	230V 50Hz 0,9 kW 400V 50 Hz 0,9 kW
Tipo di utilizzo	S2 - 10 min
Peso netto	25 kg

0556
€ 277,00
SMERIGLIATRICE COMBINATA PROFESSIONALE CON ALBERI LUNGI

Smerigliatrice combinata professionale con alberi lunghi.



Spazzola	2950 rpm - Ø 200 x 25 x 20 mm
Mola a secco	2950 rpm - Ø 200 x 25 x 20 mm GR36
Motore	230 V 50 Hz 0,75 kW
Tipo di utilizzo	S2 - 10 min
Interasse mole	510 mm
Peso netto	22 kg

0553
€ 239,00
SMERIGLIATRICE COMBINATA PROFESSIONALE

Robusta e affidabile, dispositivi di protezione mole, squadretta appoggio pezzi.



Spazzola	2950 rpm - Ø 150 x 20 x 16 mm
Mola a secco	2950 rpm - Ø 150 x 20 x 16 mm GR36
Motore	230 V 50 Hz 0,52 kW
Tipo di utilizzo	S2 - 10 min
Dimensioni	440 x 170 x 225 mm
Peso netto	16 kg

0551
€ 223,00
SMERIGLIATRICE DA BANCO PROFESSIONALE

Mola a secco	2950 rpm - Ø 150 x 20 x 16 mm GR36 - GR80
Motore	230 V 50 Hz 0,52 kW
Tipo di utilizzo	S2 - 10 min
Dimensioni	440 x 170 x 225 mm
Peso netto	15 kg

0377
€ 277,00
SMERIGLIATRICE COMBINATA

Mola a secco	2950 rpm - Ø 150 x 20 x 16 mm GR80
Mola ad acqua	130 rpm - Ø 200 x 40 x 20 mm GR80
Motore	230 V 50 Hz 0,52 kW
Tipo di utilizzo	S2 - 10 min
Peso netto	17 kg

S503
€ 172,00
SMERIGLIATRICE COMBINATA DA BANCO

Con mola ad acqua e mola a secco.



Mola a secco	2950 rpm - Ø 150 x 20 x 16 mm GR80
Mola ad acqua	130 rpm - Ø 200 x 40 x 20 mm GR80
Motore	230 V 50 Hz 0,40 kW
Tipo di utilizzo	S2 - 10 min
Peso netto	10 kg

S510
€ 167,00
SMERIGLIATRICE COMBINATA DA BANCO

Con mola e spazzola.



Spazzola	2950 rpm - Ø 150 x 20 x 16 mm
Mola a secco	2950 rpm - Ø 150 x 20 x 16 mm GR36
Motore	230 V 50 Hz 0,40 kW
Tipo di utilizzo	S2 - 10 min
Peso netto	9 kg

S023
€ 150,00
SMERIGLIATRICE DA BANCO

Con due mole di grana differenziata.



Mola a secco	2950 rpm - Ø 150 x 20 x 16 mm GR36 - GR80
Motore	230 V 50 Hz 0,40 kW
Tipo di utilizzo	S2 - 10 min
Peso netto	8 kg

S383
€ 190,00
SMERIGLIATRICE DA BANCO CON LEVIGATRICE

Mola a secco	2950 rpm Ø 150 x 20 x 16 mm GR36
Nastro	50 x 686 mm GR100
Motore	230 V 50 Hz 0,40 kW
Tipo di utilizzo	S2 - 10 min
Peso netto	8 kg

0510
€ 122,00
SMERIGLIATRICE COMBINATA DA BANCO

Con mola e spazzola. Squadretta per appoggio pezzi. Fori per il fissaggio sul banco.



Spazzola	2950 rpm - Ø 150 x 20 x 12,7 mm
Mola a secco	2950 rpm - Ø 150 x 20 x 12,7 mm GR36
Motore	230 V 50 Hz 0,35 kW
Tipo di utilizzo	S2 - 10 min
Peso netto	7 kg

0023
€ 110,00
SMERIGLIATRICE DA BANCO

Schermi di protezione mole. Squadretta per appoggio pezzo.



Mola a secco	2950 rpm - Ø 150 x 20 x 12,7 mm GR36 - GR80
Motore	230 V 50 Hz 0,35 kW
Tipo di utilizzo	S2 - 10 min
Peso netto	7 kg



0503
€ 125,00
SMERIGLIATRICE COMBINATA DA BANCO

Con mola ad acqua e mola a secco.



Mola a secco	2950 rpm - Ø 150 x 20 x 12,7 mm GR80
Mola ad acqua	130 rpm - Ø 200 x 40 x 20 mm GR80
Motore	230 V 50 Hz 0,35 kW
Tipo di utilizzo	S2 - 10 min
Peso netto	9 kg

0383
€ 152,00 **NEW**
SMERIGLIATRICE DA BANCO CON LEVIGATRICE

Mola a secco	2950 rpm Ø150 X 20 X Ø12.7 mm GR36
Nastro	50 x 686 mm GR100
Motore	230 V 50Hz 0,35kW
Tipo di utilizzo	S2 - 10 min
Peso netto	7,5 kg

0555
€ 139,00
SUPPORTO PER SMERIGLIATRICI

Altezza	760 mm
Colonna	Ø 75 mm
Dimensioni tavola	320 x 210 mm
Peso netto	13,5 kg

0106
€ 107,00
SUPPORTO PER SMERIGLIATRICI

Di tipo leggero.



Altezza	760 mm
Colonna	Ø 75 mm
Dimensioni tavola	320 x 210 mm
Peso netto	11 kg

0316
€ 198,00
AFFILCATENE PER MOTOSEGA

Con leva avanzamento catena. Schermo di protezione mola.



Mola rosa	Ø 145 x 4,7 x 22,3 mm Ø 145 x 3,2 x 22,3 mm
Affilatura	+30° / -35°
Per catene	1/4" - 3/25" - 3/8" - 404" - 3/4"
Motore	230 V 50 Hz 0,23 kW
Peso netto	5 kg

0502
€ 92,60
AFFILCATENE PER MOTOSEGA

Con leva avanzamento catena. Schermo di protezione mola.



Mola rosa	Ø 100 x 4,5 x 10 mm
Affilatura	+35° / -35°
Per catene	1/4" - 0,325" / 3/8" - 0,404"
Motore	230 V 50 Hz 0,25 kW
Velocità	7500 rpm
Tipo di utilizzo	intermittente S2

A003/32
€ 3230,00
AFFILATRICE PER PUNTE ELICOIDALI

Con pinze ER per le punte e dispositivo inclinazione dei taglienti, assottigliamento del nocciolo per una maggiore precisione. Possibilità di affilare punte in metallo duro con mola opzionale.



Capacità di affilatura	3 ÷ 32 mm
Inclinazione punta	95° ÷ 135° / 85° ÷ 140°
Velocità	4400 rpm
Motore	230 V 50 Hz 250 W
Dimensioni	400 x 260 x 300 mm
Peso netto	36 kg

A003/13A
€ 894,00
AFFILATRICE PER PUNTE ELICOIDALI

Con pinze ER per le punte e dispositivo inclinazione dei taglienti, assottigliamento del nocciolo per una maggiore precisione. Possibilità di affilare punte in metallo duro con mola opzionale.



Capacità di affilatura	3 ÷ 13 mm
Inclinazione punta	95° ÷ 135°
Velocità	4400 rpm
Motore	230 V 50 Hz 120 W
Dimensioni	320 x 180 x 190 mm
Peso netto	8,5 kg

A0132A

€ 1260,00

AFFILATRICE PER PUNTE ELICOIDALI



Capacità di affilatura	3 ÷ 20 mm
Inclinazione punta	90° ÷ 140°
Velocità	7000 rpm
Motore	230 V 50 Hz 0,6 kW
Dimensioni	500 x 230 x 250 mm
Peso netto	21 kg

A004/14

€ 1680,00

AFFILATRICE PER FRESE

Con pinze ER, adatta per affilare frese a 2, 3 e 4 taglienti. Possibilità di affilare frese in metallo duro con mola opzionale.



Capacità di affilatura	4 ÷ 14 mm
Velocità	4400 rpm
Motore	230 V 50 Hz 200 W
Dimensioni	350 x 230 x 240 mm
Peso netto	12,6 kg

A004/20

€ 2460,00

AFFILATRICE PER FRESE

Con pinze ER, adatta per affilare frese a 2, 3 e 4 taglienti. Possibilità di affilare frese in metallo duro con mola opzionale.



Capacità di affilatura	4 ÷ 20 mm
Velocità	4400 rpm
Motore	230 V 50 Hz 200 W
Dimensioni	350 x 230 x 240 mm
Peso netto	16 kg

0804

€ 639,00

AFFILATRICE MANUALE PER DISCHI



Capacità di affilatura	Ø 80 ÷ 700 mm
Velocità	2850 rpm
Motore	230 V 50 Hz 0,25 kW
Peso netto	29 kg

A003/32CBN € 271,00
MOLA IN CBN

Per punte elicoidali in HSS da 13,1 a 32 mm.



Dimensioni 125 x 20 x 19 mm

A003/32SDC € 271,00
MOLA IN SDC

Per punte elicoidali in metallo duro da 13,1 mm a 32 mm.



Dimensioni 125 x 20 x 19 mm

A003/13ACBN € 148,00
MOLA IN CBN

Per punte elicoidali in HSS da 3 a 13 mm.



Dimensioni 78,50 x 10 x 12,7 mm

A003/13ASDC € 148,00
MOLA IN SDC

Per punte elicoidali in metallo duro da 3 a 13 mm.



Dimensioni 78,50 x 10 x 12,7 mm

A013/26M € 193,00
MOLA DIAMANTATA

In CBN per punte elicoidali in HSS.



Dimensioni 85,3 x 22,8 x 25 mm

A0132A/MR € 24,00
MOLA ROSA

Filetto m8, ø 40 x 38 mm interno ø 26 mm.

A0132A/MB € 24,00
MOLA BIANCA

Filetto M8, ø 40 x 38 mm interno ø 26 mm.

0804/MD € 122,00
MOLA DIAMANTATA

125 x 10 x F32 x 8 mm.



Dimensioni 125 x 10 x 8 x 32 mm

A059/M € 13,00
SET MOLE

A004/14CBN € 168,00
MOLA IN CBN

Per frese in HSS da 4 a 14 mm.

A004/14SDC € 168,00
MOLA IN SDC

Per frese in metallo duro da 4 a 14 mm.

A004/20CBN € 335,00
SERIE DI 2 MOLE IN CBN

Per frese in HSS da 4 a 20 mm.

A004/20SDC € 335,00
SERIE DI 2 MOLE IN SDC

Per frese in metallo duro da 4 a 20 mm.



0691/400V
€ 2820,00
LEVIGATRICE A NASTRO INCLINABILE

I rulli gommati e cuscinetti di supporto in grafite offrono una coppia uniforme per tutta la durata dell'utilizzo e garantiscono l'assetto del nastro, che può essere eventualmente corretto con l'utilizzo dell'apposita manopola di regolazione. Il nastro è facilmente sostituibile tramite il meccanismo di serraggio rapido evitando inutili sprechi di tempo. La levigatrice può inclinarsi velocemente grazie alla leva di fissaggio rapido consentendo di compiere lavorazioni complesse in tutta comodità.



Dimensioni nastro	2000 x 150 mm
Velocità	(2) 18 / 37 mm/sec
Motore trifase	400 V 50 Hz 4 kW
Peso netto	110 kg

0701
€ 1740,00 NEW
LEVIGATRICE A NASTRO INCLINABILE

I rulli gommati e cuscinetti di supporto in grafite offrono una coppia uniforme per tutta la durata dell'utilizzo e garantiscono l'assetto del nastro, che può essere eventualmente corretto con l'utilizzo dell'apposita manopola di regolazione. Il nastro è facilmente sostituibile tramite il meccanismo di serraggio rapido evitando inutili sprechi di tempo. La levigatrice può inclinarsi velocemente grazie alla leva di fissaggio rapido consentendo di compiere lavorazioni complesse in tutta comodità.



Dimensioni nastro	2000 x 150 mm GR80
Velocità	(2) 15 / 30 mm/sec
Motore	400 V 50 Hz 1,8kW / 2,4kW
Dimensioni	1000 x 540 x 610h mm
Peso netto	84 Kg

0667/100
€ 1560,00 NEW
LEVIGATRICE A NASTRO INCLINABILE

Con banco, per lavorazioni orizzontali e verticali



Dimensioni nastro	1000 x 100 mm
Velocità	(2) 9 / 18 m/sec
Motore trifase	400 V 50 Hz 1,8 - 1,3 kW
Dimensioni	690 x 525 x 960h mm
Peso netto	70 kg



0667/150

 € 1950,00 **NEW**
LEVIGATRICE A NASTRO INCLINABILE

Con banco, per lavorazioni orizzontali e verticali

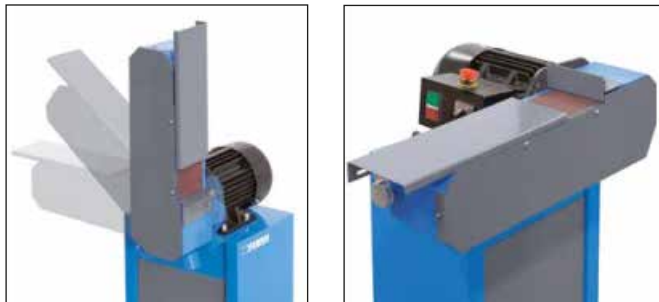

Dimensioni nastro	1500 x 120 mm
Velocità	(2) 9 / 18 m/sec
Motore trifase	400 V 50 Hz 0,85 / 1,1 kW
Dimensioni	790 x 580 x 960h mm
Peso netto	85 kg

0662

€ 775,00

LEVIGATRICE A NASTRO INCLINABILE CON BANCO

Banco da assemblare.

Dimensioni nastro	1219 x 152 mm
Diametro disco	Ø 230 mm
Dimensioni piano di lavoro	330 x 152 mm
Velocità nastro	330 m/min
Velocità disco	1400 m/min
Dimensioni	710 x 510 x 1000h mm
Motore	230 V 50 Hz 0,75 kW
Peso netto	54 kg



0560
€ 771,00
SMUSSATRICE DA BANCO

SPUN13P € 10,40
INSERTO DI RICAMBIO

Smusso	45° 0 - 5 mm
Velocità	2800 rpm
Motore	230 V 50 Hz 0,25 kW
Dimensione piani	2 - 400 x 50 mm
Dimensioni fresa	Ø 80 mm - Z 8
Inserto	SPUN13P
Peso netto	21 kg

0022
€ 792,00
SMUSSATRICE PORTATILE

SPUN13P € 10,40
INSERTO DI RICAMBIO

Smusso	15° - 45° 0 - 5 mm
Velocità	2950 rpm
Motore	230 V 50 Hz 0,25 kW
Dimensioni piani	2 - 200 x 50 mm
Dimensioni fresa	Ø 80 mm - Z 8
Inserto	SPUN13P
Peso netto	11,5 kg

0285/75 FERVIplus
€ 5610,00
CALANDRA MOTORIZZATA

A 3 rulli in acciaio con durezza 52HRC, barriera di arresto di emergenza a filo con micro di sicurezza a 3 funzioni, comandi mobili con doppio pedale avanti/indietro e pulsante a fungo di arresto di emergenza.



Lunghezza utile	1300 mm
Spessore max	1.5 mm
Diametro dei rulli	75 mm
Motore trifase	400 V 50 Hz 0.75 kW
Peso netto	375 kg

0334/0750
€ 4180,00
CALANDRA CESOIA PIEGATRICE

Macchina versatile e robusta, adatta per la produzione di prototipi.



Lunghezza utile	750 mm
Max spessore di taglio, di piegatura e di calandratura	1,0 mm
Angolo di piegatura	90°
Ø min. di calandratura	44 mm
Dimensioni	980 x 370 x 550 mm
Peso netto	260 kg

0334/1000
€ 4660,00
CALANDRA CESOIA PIEGATRICE

Macchina versatile e robusta, adatta per la produzione di prototipi.



Lunghezza utile	1000 mm
Max spessore di taglio, di piegatura e di calandratura	1,0 mm
Angolo di piegatura	90°
Ø min. di calandratura	48 mm
Dimensioni	1335 x 455 x 620 mm
Peso netto	317 kg

C022/100
€ 2790,00
CALANDRA

A 3 rulli, rullo centrale smontabile per creazione tubi completi.

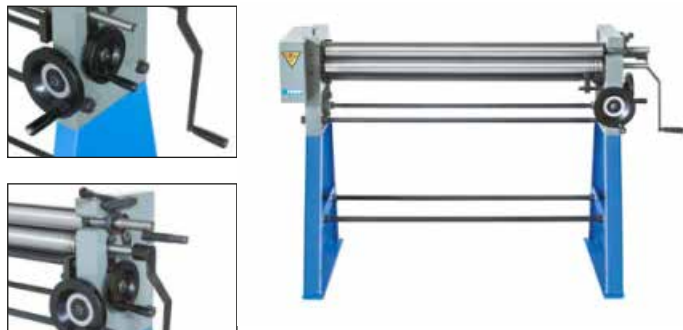

Lunghezza massima	1000 mm
Spessore max	2 mm
Diametro dei rulli	60 mm
Peso netto	200 kg

0776
€ 1270,00
CALANDRA MANUALE

A 3 rulli, con banco dotato di un ripiano, rullo centrale smontabile per creazione tubi completi.



Lunghezza massima	1000 mm
Spessore max	0,8 mm
Diametro dei rulli	50 mm
Peso netto	105 kg

0776/610
€ 555,00
CALANDRA MANUALE

A 3 rulli, da banco, rullo centrale smontabile per creazione tubi completi.



Lunghezza massima	610 mm
Spessore max	0.8 mm
Diametro dei rulli	38 mm
Peso netto	37 kg

0235
€ 264,00
MINI CALANDRA

Dotata di 3 rulli, morsa non inclusa.



Lunghezza massima	300 mm
Spessore max	2,5 mm
Diametro dei rulli	30 mm
Peso netto	10 kg

P008/102
€ 3190,00
PIEGATRICE PER LAMIERA

Elevate prestazioni grazie al coltello segmentato ed estraibile, struttura robusta e affidabile.



Utile max	1020 mm
Max. spessore piegatura su lamiera ferrosa	2 mm
Max angolo di piegatura	135°
Peso netto	334 kg



**0775**

€ 1760,00

PIEGATRICE PER LAMIERA

Utile max	1000 mm
Max. spessore piegatura su lamiera ferrosa	1,2 mm
Max angolo di piegatura	140°
Peso netto	130 kg

0483

€ 273,00

MINI PIEGATRICE

Lama intercambiabile, profondità massima di piegatura lato manico 50 mm, morsa non inclusa.



Lavoro utile	270 mm
Max. spessore piegatura su lamiera ferrosa	2,5 mm
Peso netto	10 kg

T034/105

€ 2730,00

CESOIA PER LAMIERA CON BANCO

Con goniometro integrato, fine corsa di taglio regolabile e banco in kit di montaggio



Lunghezza utile	1050 mm
Max. spessore taglio su lamiera ferrosa	1,25 mm
Capacità di taglio con regolazione	0 ÷ 500 mm
Dimensioni	1290 x 1300 x 1080 mm
Peso netto	220 kg

T034/065

€ 1570,00

CESOIA PER LAMIERA DA BANCO

Con goniometro integrato e fine corsa di taglio regolabile



Lunghezza utile	650 mm
Max. spessore taglio su lamiera ferrosa	1,5 mm
Capacità di taglio con regolazione	0 ÷ 500 mm
Dimensioni	890 x 1300 x 450 mm
Peso netto	145 kg

0773-**CESOIA A LEVA****0773/10L**

€ 122,00

SERIE LAME**0773/05L**

€ 93,10

SERIE LAME

Art.	€	Dimensioni	Dimensioni base	Lunghezza leva	Lungh. lama	Taglio piatto	Taglio lamiera	Tondo	Peso netto
0773/05	€ 187,00	290 x 120 x 240 mm	240 x 90 mm	410 mm	130 mm	38 x 3 mm	0,5 ÷ 3 mm	Ø 6 mm	10 kg
0773/10	€ 272,00	420 x 120 x 390 mm	400 x 90 mm	800 mm	250 mm	70 x 3 mm	0,5 ÷ 3 mm	Ø 6 mm	19 kg

0892
€ 540,00
MINI CESOIA - PIEGATRICE

Lama intercambiabile, morsa non inclusa.



Lavoro utile	200 mm
Max. spessore taglio su lamiera ferrosa	1 mm
Max. spessore piegatura su lamiera ferrosa	1 mm
Peso netto	17 kg

C076/30 FERVI plus
€ 4440,00
CURVAPROFILATI MOTORIZZATA A 3 RULLI

Orizzontale e verticale per pieni, tubi e profilati.



Diametro albero dei rulli	30 mm
Diametro rullo superiore	148 mm
Diametro dei rulli inferiori	148 mm
Velocità di rotazione	4,8 ÷ 7,2 m/min
Motore trifase	400 V 50 Hz 1,1 kW
Dimensioni	620 x 1100 x 1360 mm
Peso netto	230 kg

0197
€ 640,00
PIEGATRICE UNIVERSALE

Per piegatura a freddo, con finecorsa per velocizzare e standardizzare i lavori in serie, con manico ergonomico.



Tondino	Acciaio, Rame 16 mm Ferro battuto 12 mm Alluminio 18 mm
Piatto	30 x 8 mm
Quadro	Acciaio, Rame 13 x 13 mm Ferro battuto 10 x 10 mm Alluminio 15 x 15 mm
Peso netto	22 kg

0668
€ 1510,00
FORNO PER FUCINAZIONE

Facile da usare, accensione rapida, nessuna emissione nociva. Retro smontabile per scaldare le barre di ferro al centro, isolamento camera in fibra ceramica, completo di regolatore, valvola di non ritorno e termocoppia.



Temperatura di esercizio	1300 °C ÷ 1400 °C
Capacità max. di lavoro	Ø 70 mm / ■ 50 mm
Alimentazione	G.P.L.
Consumo	0,05 - 1,5 kg / h
Dimensioni interne	280 x 210 x 100h mm
Dimensioni esterne	400 x 260 x 250h mm
Peso netto	25 kg

0721
€ 362,00
CURVAFERRI E PIEGAFERRI MANUALE

Per piegatura a freddo, con finecorsa per velocizzare e standardizzare i lavori in serie. Leva regolabile in lunghezza, con rulli per tondini e piatti già inclusi per effettuare diversi raggi di curvatura. Possibilità di creare sia pieghe secche che curvature ed utilizzo con tubi.



Diametro dei rulli	2x Ø 24, 30, 37, 43, 49, 62, 75 mm
Tondino	Acciaio, Alluminio, Rame Ø16 mm Inox Ø14 mm
Piatto	10 x 50 mm Spigolo 6 x 50 mm
Quadro	14 x 14 mm
Tubo tondo	G 3/4"
Lunghezza leva	1000 mm Max
Peso netto	30 kg

0102
€ 373,00
PIEGAFERRI

Per piegatura a freddo e a caldo. Con finecorsa per velocizzare e standardizzare i lavori in serie ed impugnatura ergonomica.



Tondino	A freddo 22 mm A caldo 27 mm
Quadro	A freddo 20 mm A caldo 25 mm
Piatto	Acciaio 100 x 8 mm Rame 100 x 15 mm
Peso netto	30 kg

0113 € 362,00

CURVAFERRI

Per curvatura a freddo. Con ferma pezzo ed impugnatura ergonomica.



Ferro dolce	A freddo
Tondino	10 mm
Piatto	10 x 30 mm
Quadro	10 mm
Matrici	80 mm 125 mm 200 mm
Peso netto	25 kg

0722 € 1450,00

CURVATUBI MANUALE

Per piegatura a freddo, per tubi di grandi dimensioni, con sistema che evita lo schiacciamento, per la realizzazione di curve semplici o complesse, con indicazione dell'angolo di piega, leva inclusa. Funzionamento a cricchetto per esercitare la massima forza.

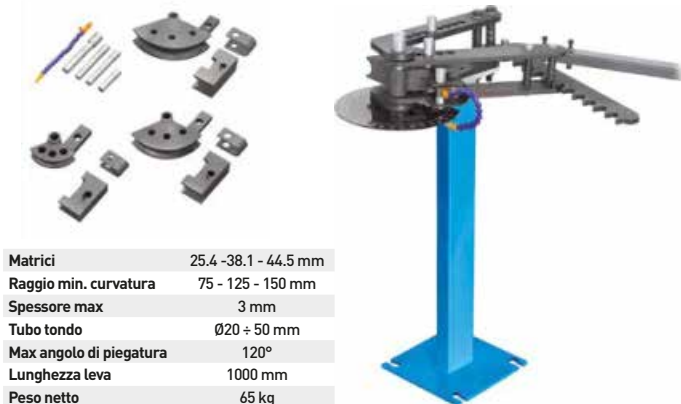

Matrici	25.4 - 38.1 - 44.5 mm
Raggio min. curvatura	75 - 125 - 150 mm
Spessore max	3 mm
Tubo tondo	Ø20 ÷ 50 mm
Max angolo di piegatura	120°
Lunghezza leva	1000 mm
Peso netto	65 kg

0723 € 422,00

CURVATUBI MANUALE PORTATILE

Per piegatura a freddo, con sistema che evita lo schiacciamento, per la realizzazione di curve semplici o complesse.



Matrici	8
Tubo tondo	3/8" - 1/2" - 9/16" - 5/8" - 3/4" - 7/8"
Tubo quadro	3/4" - 1"
Spessore	0.8 ÷ 1.2 mm
Max angolo di piegatura	180°
Lunghezza leva	420 ÷ 600 mm
Peso netto	25 kg

0893 € 601,00

CURVATUBI IDRAULICO 1 1/2" - 2"

Con pompa a 2 velocità.



Matrici	1/2" 3/4" 1" 1-1/4" 1-1/2" 2" gas
Forza	10 tons N
Corsa pistone	250 mm
Peso netto	48 kg

0719 € 1200,00

CURVATUBI MANUALE

Per piegatura a freddo, con sistema che evita lo schiacciamento, per la realizzazione di curve semplici o complesse, con finecorsa per velocizzare e standardizzare i lavori in serie.



Matrici	14 - 16 - 18 - 20 - 22 - 25 mm
Raggio min. curvatura	4x Ø tubo, 56-100 mm
Spessore max	2 mm
Tubo tondo	acciaio, alluminio, rame Ø25 mm inox Ø22 mm
Quadro	20 x 20 mm
Peso netto	46 kg

0292-
CURVATUBO PER TUBI IN RAME

Art.	€	Misure
0292	€ 18,20	Ø 8 - 10 - 12 mm
0292/14	€ 17,50	Ø 14 mm
0292/16	€ 19,80	Ø 16 mm

0758
€ 1400,00
TORNIO DA LEGNO

Con testa girevole, trasmissione a cinghia con pulegge a velocità variabile e banco in ghisa.

ACCESSORI INCLUSI

- Contropunta rotante CM 2
- Trascinatore 4 punte CM 2
- Platorello Ø 150 mm
- Espulsore
- Chiavi di servizio



Distanza tra le punte	1100 mm
Altezza punte	185 mm
Diametro massimo tornitura	370 mm
Filetto	1" - 8 TPI
Contropunta	CM 2
Motore	230 V 50 Hz 0,75 kW
Velocità del mandrino	500 ÷ 2000 rpm
Peso netto	120 kg

0751
€ 933,00
TORNIO DA LEGNO

Con testa girevole, trasmissione a cinghia con pulegge a velocità variabile e banco in lamiera.

ACCESSORI INCLUSI

- Contropunta rotante CM 2
- Trascinatore 4 punte CM 2
- Platorello Ø150 mm
- Espulsore
- Chiave di servizio

Distanza tra le punte	900 mm
Altezza punte	155 mm
Diametro massimo tornitura	310 mm
Filetto	1" - 8 TPI
Contropunta	CM 2
Motore	230 V 50 Hz 0,37 kW
Velocità del mandrino	500 ÷ 2000 rpm
Peso netto	75 kg

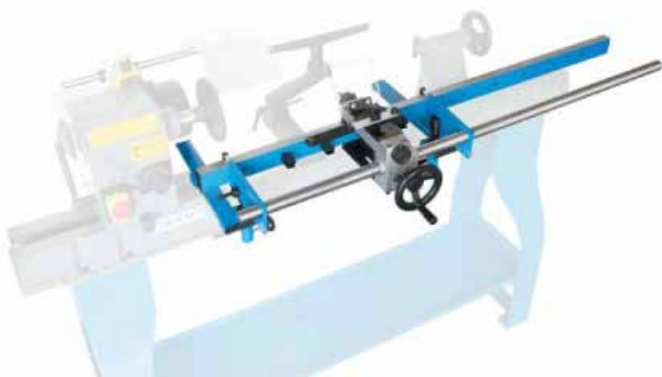
0758/C
€ 407,00
COPIA PER TORNIO LEGNO

Distanza tra le punte	1000 mm
-----------------------	---------

0648
€ 1100,00
TORNIO DA LEGNO CON COPIA

Con leva per regolare la velocità e zona di lavorazione protetta con riparo mobile interbloccato in plexiglass.



Distanza tra le punte	1000 mm
Altezza punte	175 mm
Diametro massimo tornitura	350 mm
Filetto	1" - 8 TPI
Contropunta	CM 2
Motore	230 V 50 Hz 0,75 kW
Velocità del mandrino	500 ÷ 2000 rpm
Dimensioni	1400 x 500 x 1300h mm
Peso netto	68 kg

0497-
TORNIO DA LEGNO

Con cambio velocità cinghia, contropunta in ghisa con sistema di bloccaggio, carrello scorrevole poggia utensile.

ACCESSORI INCLUSI

- Contropunta rotante CM 2
- Trascinatore 4 punte CM 2
- Platorello Ø 80 mm
- Espulsore
- Chiavi di servizio



Art.	€	Distanza tra le punte	Altezza punte	Diametro massimo tornitura	Motore	Velocità del mandrino	Filetto	Contropunta	Peso netto
0497/250	€ 680,00	457 mm	125 mm	250 mm	230 V 50 Hz 0.37 kW	(S) 700 - 3000 rpm	1" - 8 TPI	CM 2	33 kg
0497/300	€ 756,00	457 mm	150 mm	300 mm	230 V 50 Hz 0.55 kW	(S) 700 - 3000 rpm	1" - 8 TPI	CM 2	33 kg



0498 FERVIplus
€ 10280,00
COMBINATA DA LEGNO & LAVORAZIONI

Sega circolare, squadratrice, incisore, toupie, pialla a filo, pialla spessore, cavatrice e carteggiatrice a rullo a 1500rpm. La macchina può essere divisa velocemente (sei bulloni) in due parti per entrare attraverso piccole aperture.



Dimensioni ingombro	1880 x 1500 x 1050 mm
Altezza piani	840 mm
Motore monofase	3 x 230 V 50 Hz 2.2 kW
Peso	445 kg
Dimensioni imballo	1600 x 1300 x 1010 mm

SEGA CIRCOLARE

Dimensioni tavola principale	1045 x 800 mm
Dimensioni lama	254 x 3,2 x 30 mm 24 Z
Velocità lama	4050 rpm
Altezza di taglio	65 mm 90° - 45 mm 45°

PIALLA FILO SPESSORE

Dimensioni piani	1285 x 310 mm
Sezione albero	Ø 75 mm
Diametro aspirazione	Ø 100 mm
Lame	3
Capacità pialla filo	310 x 5 mm
Capacità spessore	310 x 180 mm
Giri albero	4000 rpm

SQUADRATRICE

Capacità di taglio con squadratrice	1370 mm
Tavola scorrevole	1500 x 840 mm
INCISORE	
Dimensioni lama	Ø 80 x 3,2 x 20 mm 8 Z
Velocità lama	6300 rpm

CAVATRICE

Dimensioni piani	150 x 365 mm
Corsa verticale	0 ÷ 80 mm
Corsa longitudinale	0 ÷ 85 mm
Corsa trasversale	0 ÷ 140 mm
Giri albero	4000 rpm

TOUPIE

Sezione albero	Ø 30 mm
Corsa albero	130 mm
Giri albero	1500 / 4000 / 6000 rpm

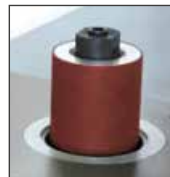
CARTEGGIATRICE A RULLO

Dimensioni	Ø 100 x 100h mm
Giri albero	1500 rpm



0499

€ 3070,00

PIALLA FILO SPESSORE

Da 310 mm con predisposizione al montaggio della cavatrice.



Dimensioni ingombro	1290 x 550 x 1000 mm
Altezza piani	810 mm
Dimensioni piani	310 x 1285 mm
Sezione albero	Ø 75 mm
Lama	3
Capacità spessore	310 x 2,5 x 180h mm
Giri albero	4000 rpm
Motore	230 V 50 Hz 2.2 kW
Peso netto	179 kg

0749

€ 2280,00

PIALLA FILO SPESSORE

Con piani in ghisa.



Dimensioni	1050 x 485 x 800h mm
Altezza piani	810 mm
Dimensioni piani	1050 x 250 mm
Albero	Ø 75 mm
Lama	N° 3
Capacità pialla filo	250 x 2 mm
Capacità spessore	250 x 1,2 180h mm
Giri albero	4000 rpm
Motore	230 V - 50 Hz - 1,5 kW
Peso netto	155 kg

0517A

€ 952,00

PIALLA SPESSORE

Con piano di lavoro in granito.



Dimensioni	710 x 640 x 400 mm
Dimensioni piano di lavoro	330 x 238 mm
Albero	Ø 51.5 mm
Lama	2
Capacità spessore	330 x 2,4 x 152 mm
Giri albero	8500 rpm
Motore	230 V 50 Hz 1.5 kW
Peso netto	35 kg



0686/200
€ 650,00
PIALLA FILO SPESSORE

Con piani in alluminio.



Dimensioni	770 x 430 x 450h mm
Altezza piani	360 mm
Dimensioni piani	737 x 210 mm
Albero	Ø 50 mm
Lama	N° 2
Capacità pialla filo	204 x 2 mm
Capacità spessore	204 x 2 x 120h mm
Giri albero	8000 rpm
Motore	230 V 50 Hz 1,25 kW
Peso netto	25 kg

0749/M
€ 516,00
CAVATRICE

Con piani in ghisa.



Mandrino	Ø 16 mm
Dimensioni tavola	370 x 150 mm
Corsa verticale	0 - 80 mm
Corsa laterale	0 - 140 mm
Interasse fori	3 x 165 mm
Peso netto	26 kg

0749/MC
€ 140,00
MANDRINO WESTCOTT

Capacità	16 mm
Attacco femmina	M20 x 1,5 Sx / Left
Misure	Ø 55 x 68,5 mm

M057/16
€ 143,00
MANDRINO "WESTCOTT"

Capacità	16 mm
Attacco femmina	B18
Misure	Ø 60 x 65 mm

0697
€ 63,10
SERIE CALIBRI MAGNETICI UNIVERSALI

Per coltelli pialla con alberi	Ø 75 ÷ 125 mm
--------------------------------	---------------

0499/C
€ 92,20
SERIE COLTELLI

Per pialla filo spessore.



Misure	310 x 30 x 3 mm
--------	-----------------

0749/C
€ 71,40
SERIE COLTELLI

Per pialla filo spessore.



Misure	250 x 30 x 3 mm
--------	-----------------

0517/59
€ 67,30
SERIE COLTELLI

Per pialla filo spessore.



Misure	335 x 12 x 1.5 mm
--------	-------------------

0686/200C
€ 42,40
SERIE COLTELLI

Per pialla filo spessore.



Misure	210 x 22 x 2 mm
--------	-----------------

0559

€ 1710,00

2 IN 1 TOUPIE E CARTEGGIATRICE A RULLO

Per fresatura e foratura su legno, levigatura montando carta abrasiva.



Motore	230V 50Hz 1,5kW
Giri albero	1500 / 4000 / 6000 rpm
Diametro albero	30 mm
Corsa albero	105 mm
Diametro massimo fresa	160 mm
Piani in ghisa	600 x 400 mm
Piano scorrevole in ghisa	400 x 250 mm
Corsa del carrello	700 mm
Altezza piani	850 mm
Dimensioni	74 x 66 x 98 cm
Livello pressione acustica posto operatore	85.3 ± 2.94 dB(A)
Livello potenza acustica	98.3 ± 2.94 dB(A)
Peso netto	110 kg

0559/T € 174,00

RULLO PER CARTEGGIARE

Nastro abrasivo non incluso.

0504 FERVIplus

€ 6500,00

SEGA CIRCOLARE QUADRATRICE INCISORE TOUPIE CARTEGGIATRICE

Carrello a squadrare, incidere, toupie e carteggiatrice a 1500rpm.

Altezza piani	840 mm
Dimensioni ingombro	1670 x 1200 x 1050 mm
SEGA CIRCOLARE	
Dimensioni tavola principale	1045 x 800 mm
Dimensioni lama	Ø 254 x 3.2 x 30 mm 24 Z
Velocità lama	4050 rpm
Altezza di taglio	65 mm 90° - 45 mm 45°
SQUADRATRICE	
Capacità di taglio con squadratrice	1070 mm
Tavola scorrevole	1200 x 840 mm
INCISORE	
Dimensioni lama	Ø 80 x 3.2 x 20 mm 8 Z
Velocità lama	6300 rpm
TOUPIE	
Sezione albero	Ø 30 mm
Corsa albero	130 mm
Giri albero	1500 / 4000 / 6000 rpm
CARTEGGIATRICE A RULLO	
Dimensioni	Ø 100 x 100h mm
Giri albero	1500 rpm
Motore	2 x 230 V 50 Hz 2.2 kW
Peso netto	250 kg

0665

€ 3560,00

SEGA CIRCOLARE QUADRATRICE PARZIALMENTE MONTATA

Lama	250 x 3 x 30 mm Z 40
Velocità lama	2800 rpm
Dimensioni tavola principale	800 x 560 mm
Dimensioni allungamento tavola	800 x 305 mm
Altezza tavola	860 mm
Taglio a 45°	60 mm
Taglio a 90°	75 mm
Tavola scorrevole	500 x 600 mm
Dimensioni ingombro	1860 x 2030 x 1070h mm
Motore	230 V 50 Hz 2,2 kW
Capacità di taglio con squadratrice	1460 mm
Peso netto	230 kg



0656/254
€ 2960,00
SEGA CIRCOLARE SQUADRATRICE

Da 254 mm, parzialmente montata.



Dimensioni lama	254 x 30 x 3,2 mm 40 Z
Velocità lama	4000 rpm
Dimensioni tavola principale	790 x 350 mm
Dimensioni allungamento tavola	350 x 350 mm
Altezza tavola	850 mm
Capacità di taglio a 90°	80 mm
Capacità di taglio a 45°	56 mm
Tavola scorrevole	1320 x 238 mm
Motore	230 V 50 Hz 2,2 kW
Capacità di taglio con squadratrice	1250 mm
Peso netto	150 kg

0656/310
€ 3410,00
SEGA CIRCOLARE SQUADRATRICE

Da 310 mm, parzialmente montata.



Dimensioni lama	315 x 30 x 3,2 mm 40 Z
Velocità lama	4000 rpm
Dimensioni tavola principale	790 x 350 mm
Dimensioni allungamento tavola	350 x 350 mm
Altezza tavola	850 mm
Capacità di taglio a 90°	100 mm
Capacità di taglio a 45°	70 mm
Tavola scorrevole	1320 x 238 mm
Motore	230 V 50 Hz 2,2 kW
Capacità di taglio con squadratrice	1400 mm
Peso netto	175 kg

0280
€ 1090,00
BANCO SEGA

Professionale, dotato di lama con riporto in metallo duro con protezioni lama, guida-pezzo, tavola mobile, ruote per lo spostamento.

Dimensioni tavola	800 x 550 mm
Prolunga tavola	800 x 550 mm
Altezza tavola	810 mm
Spessore lamiera	2 mm
Capacità di taglio a 90°	90 mm
Capacità di taglio a 45°	50 mm
Dimensioni lama	315 x 3 x 30 mm Z 36
Inclinazione lama	45°
Corsa piano scorrevole	1160 mm
Dim. piano scorrevole	230 x 230 mm
Velocità motore	2800 rpm
Motore	230 V 50 Hz 2,2 kW
Peso netto	60 kg



0871
€ 677,00
TRONCATRICE RADIALE PER LEGNO

Dotata di indicatore laser della linea di taglio.



Disco	Ø 305 x 30 x 3,2 mm Z 40
Taglio massimo 0° - 90°	340 x 100 mm
Taglio massimo 45° - 90°	240 x 100 mm
Spostamento radiale	215 mm
Motore	230 V 50 Hz 2 kW
Velocità motore	4500 rpm
Peso netto	25 kg

0870/250
€ 477,00
TRONCATRICE PER LEGNO

Con tavola supplementare superiore per funzionamento come sega da banco.



Disco	Ø 250 x 30 x 2,5 mm Z 36
Taglio massimo 0° - 90°	75 x 130 mm
Taglio massimo 45° - 45°	75 x 50 mm
Taglio massimo 45° - 90°	75 x 90 mm
Taglio massimo 0° - 45°	50 x 130 mm
Taglio massimo tavola superiore	40 mm
Motore	230 V 50 Hz 1,8 kW
Velocità motore	4500 rpm
Velocità periferica disco	59 m/s
Peso netto	15,5 kg

0365
€ 274,00
SUPPORTO UNIVERSALE PER TRONCATRICE PORTATILE

Pieghevole.

Altezza tavola	945 mm
Altezza prolunghe	1030 - 1180 mm
Lunghezza supporto	1360 mm
Lunghezza bracci estensibili	1360 - 3040 mm
Misure morsetti	505 x 35 x 90 mm
Dimensioni	1620 x 825 x 1075h mm
Portata	220 kg
Peso netto	17,5 kg



SEGHE A NASTRO PER LEGNO

0764/455



0764



0509/340



0509/305



0509/245



0855



FC94/350



FC94/245



0302/305



0302/245



0302/200



0717A





SEGHE A NASTRO PER LEGNO

Dimensioni tavola (mm)

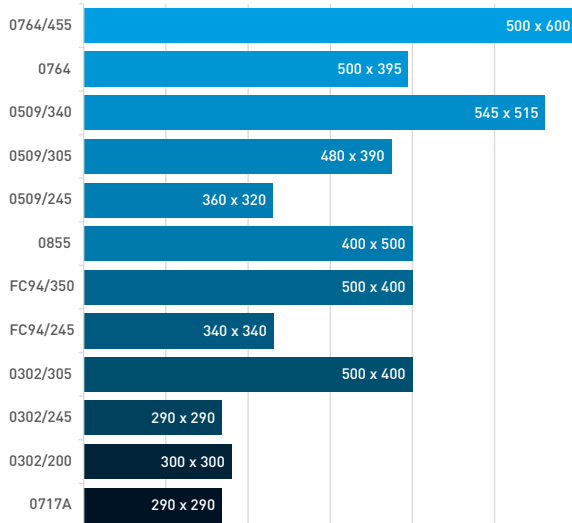

Capacità di taglio (mm)

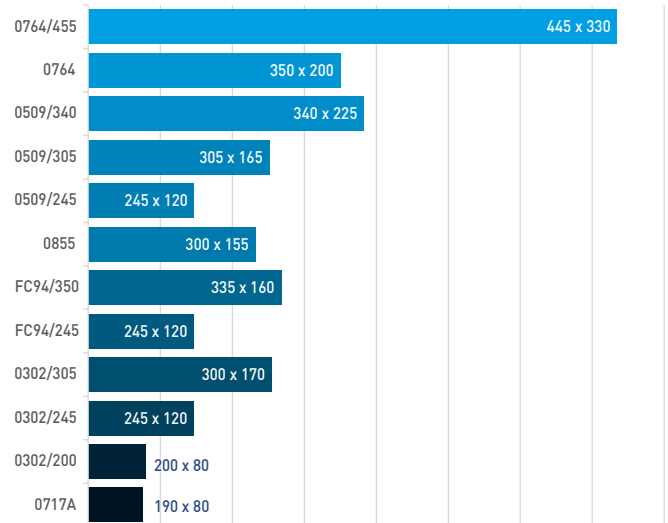

Potenza (W)

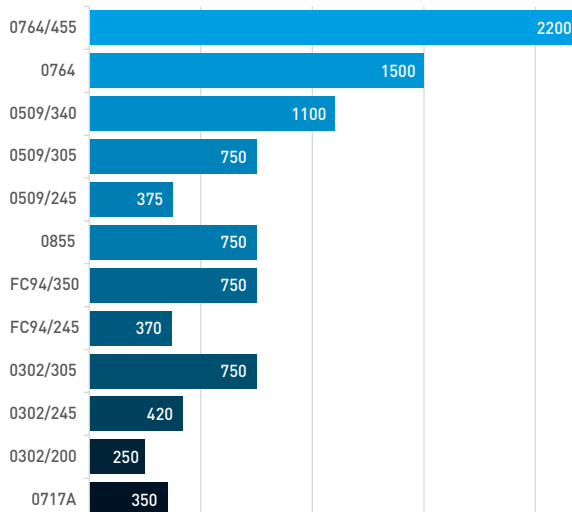

Inclinazione tavola

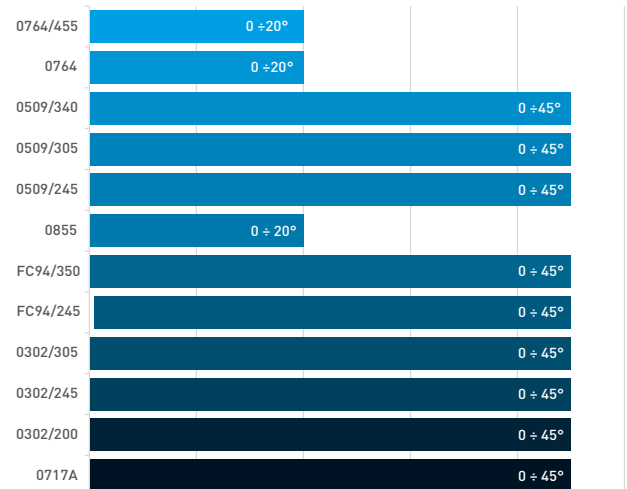

Dimensioni lama

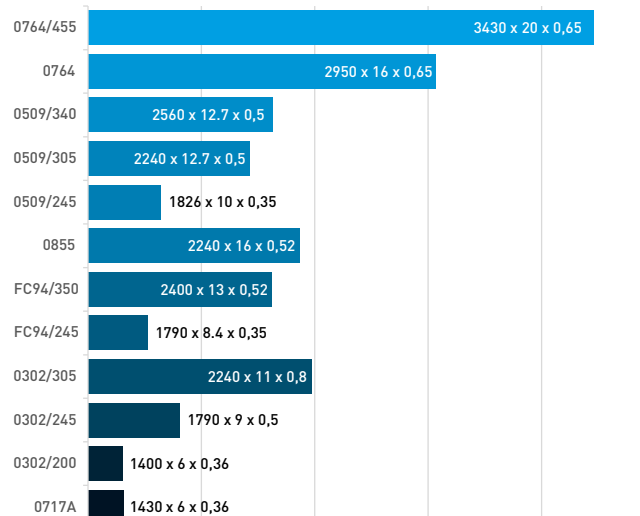

0764/455
€ 2770,00
SEGA A NASTRO PER LEGNO

Con tavola di lavoro orientabile e goniometro per alta precisione. Dispositivo di protezione lama.



Volano	Ø 455 mm
Capacità di taglio	445 x 330h mm
Lama	3430 x 20 x 0,65 mm T4
Dimensioni tavola	500 x 600 x 40h mm
Velocità di taglio	10 m/s
Inclinazione tavola	0 ÷ 20°
Altezza tavola	950 mm
Dimensioni	1000 x 900 x 1860h mm
Motore	230 V 50 Hz 2,2 kW
Peso netto	200 kg

0764
€ 1850,00
SEGA A NASTRO PER LEGNO

Con tavola di lavoro orientabile e goniometro per alta precisione. Dispositivo di protezione lama.



Volano	Ø 405 mm
Capacità di taglio	350 x 200h mm
Lama	2950 x 16 x 0,65 mm T4
Dimensioni tavola	500 x 395 mm
Velocità di taglio	10 m/s
Inclinazione tavola	0 ÷ 20°
Altezza tavola	995 mm
Motore	230 V 50 Hz 1,5 kW
Dimensioni	750 x 650 x 1710 h mm
Peso netto	130 kg

0509/340
€ 1570,00
SEGA A NASTRO PER LEGNO

Con accessorio per tagli circolari, lampada a Led e cassetto raccogli segatura.



Volano	Ø 347 mm
Capacità di taglio	340 x 225 mm
Lama	2560 x 12.7 x 0.5 mm T4
Dimensioni tavola	545 x 515 mm
Velocità di taglio	6-12 m/s
Inclinazione tavola	0-45°
Altezza tavola	1010 mm
Motore	230 V 50 Hz 1.1 kW
Dimensioni	900 x 670 x 1720 h mm
Peso netto	70 kg

0509/305
€ 1360,00
SEGA A NASTRO PER LEGNO

Con accessorio per tagli circolari, lampada a Led e cassetto raccogli segatura.



Volano	Ø 314 mm
Capacità di taglio	305 x 165 mm
Lama	2240 x 12.7 x 0.5 mm T4
Dimensioni tavola	480 x 390 mm
Velocità di taglio	6-12 m/s
Inclinazione tavola	0 ÷ 45°
Altezza tavola	990 mm
Motore	230 V 50 Hz 0.75 kW
Dimensioni	700 x 600 x 1585 h mm
Peso netto	62 kg

0509/245
€ 887,00
SEGA A NASTRO PER LEGNO

Con accessorio per tagli circolari, lampada a Led e cassetto raccogli segatura.



Volano	Ø 254 mm
Capacità di taglio	245 x 100 mm
Lama	1826 x 10 x 0.35 mm T6
Dimensioni tavola	360 x 320 mm
Velocità di taglio	6.7 ÷ 13.3 m/s
Inclinazione tavola	0 ÷ 45°
Altezza tavola	925 mm
Motore	230V 50Hz 0.375kW
Dimensioni	750 x 480 x 1420 mm
Peso netto	37 kg



0855
€ 1130,00
SEGA A NASTRO PER LEGNO

Volano	Ø 315 mm
Lama	2240 x 16 x 0,52 mm T4
Capacità di taglio	300 x 155 mm
Dimensioni tavola	400 x 500 mm
Velocità di taglio	6 - 12 m/s 370 - 800 rpm
Inclinazione tavola	0 ÷ 20°
Altezza tavola	1010 mm
Motore	230 V 50 Hz 0,75 kW
Dimensioni	650 x 650 x 1610 h mm
Peso netto	75 kg

FC94/350
€ 1370,00
SEGA A NASTRO PER LEGNO

Volano	Ø 350 mm
Capacità di taglio	335 x 160 mm
Lama	2400 x 13 x 0,52 mm T4
Dimensione tavola	500 x 400 mm
Velocità di taglio	10 ÷ 12 m/s
Inclinazione tavola	0 ÷ 45°
Altezza tavola	1015 mm
Motore	230 V 50 Hz 0,75 kW
Dimensioni	730 x 620 x 1540 h mm
Peso netto	79 kg

FC94/245
€ 691,00
SEGA A NASTRO PER LEGNO

Volano	Ø 255 mm
Capacità di taglio	245 x 120 mm
Lama	1790 x 8,4 x 0,35 mm T6
Dimensioni tavola	340 x 340 mm
Velocità di taglio	11 ÷ 16 m/s
Inclinazione tavola	0 ÷ 45°
Altezza tavola	1000 mm
Motore	230 V 50 Hz 0,37 kW
Dimensioni	420 x 250 x 800 h mm
Peso netto	29 kg



**0302/305****€ 856,00****SEGA A NASTRO PER LEGNO**

Con tavola in alluminio, per tagliare pezzi con sezioni rettangolari, circolari e curvilinee. Dispositivo di protezione lama.



Volano	ø 315 mm
Capacità di taglio	300 x 170 mm
Lama	2240 x 11 x 0.8 mm T6
Dimensioni tavola	500 x 400 mm
Velocità di taglio	6 ÷ 12 m/s
Inclinazione tavola	0° ÷ 45°
Altezza tavola	960 mm
Motore	230 V 50 Hz 0.75 kW
Dimensioni	800 x 500 x 1580 h mm
Peso netto	58 kg

0302/245**€ 562,00****SEGA A NASTRO PER LEGNO**

Con tavola in alluminio, per tagliare pezzi con sezioni rettangolari, circolari e curvilinee. Dispositivo di protezione lama.



Volano	Ø 255 mm
Capacità di taglio	245 x 120 mm
Lama	1790 x 9 x 0.5 mm T6
Dimensioni tavola	290 x 290 mm
Velocità di taglio	11 ÷ 16 m/s
Inclinazione tavola	0° ÷ 45°
Altezza tavola	1000 mm
Motore	230 V 50 Hz 0.42 kW
Dimensioni	600 x 400 x 1480 h mm
Peso netto	28 kg

0302/200**€ 384,00****SEGA A NASTRO PER LEGNO**

Con tavola orientabile in acciaio. Taglio pezzi con sezioni circolari e rettangolari. Dispositivo di protezione lama.



Volano	Ø 210 mm
Capacità di taglio	200 x 80h mm
Lama	1400 x 6 x 0,36 mm T6
Dimensioni tavola	300 x 300 mm
Velocità di taglio	15 m/s
Inclinazione tavola	0 ÷ 45°
Dimensioni	450 x 390 x 680 h mm
Motore	230 V 50 Hz 0.25 kW
Peso netto	17 kg

0717A**€ 366,00****SEGA A NASTRO PER LEGNO**

Con tavola di lavoro orientabile e goniometro per alta precisione. Dispositivo di protezione lama.



Volano	Ø 200 mm
Lama	1430 x 6 x 0,36 mm T6
Capacità di taglio	190 x 80h mm
Dimensioni tavola	290 x 290 mm
Velocità di taglio	13,7 m/s
Inclinazione tavola	0 ÷ 45°
Motore	230 V 50 Hz 0.35 kW
Dimensioni	430 x 355 x 665 h mm
Peso netto	17 kg

0523
€ 469,00
LEVIGATRICE A NASTRO DA BANCO INCLINABILE

Utilizzabile con nastro in orizzontale o verticale. Con supporto ferma pezzo, nastro e disco abrasivi. Tavola di lavoro inclinabile in fusione di alluminio. Rullo trainato in alluminio su cuscinetti. Basamento pesante adatto a lavori gravosi. Da utilizzarsi esclusivamente per la lavorazione del legno e materiali plastici.



Dimensioni	530 x 430 x 330 mm
Motore	230V 50Hz 375 W
Nastro	914 x 100 mm
Velocità nastro	336 m/min
Grana nastro	80
Diametro disco	Ø 150 mm
Grana disco	80
Velocità di rotazione	1850 rpm
Inclinazione tavola	0 ÷ 45°
Dimensioni tavola	176 x 136 mm
Peso netto	19.5 kg

0505
€ 313,00
LEVIGATRICE A NASTRO DA BANCO INCLINABILE

Utilizzabile con nastro in orizzontale o verticale. Con supporto ferma pezzo, nastro e disco abrasivi. Tavola di lavoro inclinabile in fusione di alluminio. Rullo trainato in alluminio su cuscinetti. Da utilizzarsi esclusivamente per la lavorazione del legno e materiali plastici.



Dimensioni	460 x 380 x 270h mm
Motore	230V 50 Hz 500 W
Nastro	914 x 100 mm
Velocità nastro	420 m/min
Grana nastro	80
Diametro disco	Ø 150 mm



Grana disco	80
Velocità di rotazione	2850 rpm
Inclinazione tavola	0 ÷ 45°
Dimensioni tavola	225 x 155 mm
Peso netto	18 kg

0564
€ 319,00
LEVIGATRICE A NASTRO DA BANCO INCLINABILE

Utilizzabile con nastro in orizzontale o verticale. Con supporto ferma pezzo, nastro e disco abrasivi. Tavola di lavoro inclinabile in estruso di alluminio. Sistema rapido di cambio del nastro. Rullo trainato in plastica su cuscinetti. Da utilizzarsi esclusivamente per la lavorazione del legno e materiali plastici.



Dimensioni	470 x 360 x 290 mm
Motore	230V 50 Hz 370 W
Nastro	914 x 100 mm
Velocità nastro	450 m/min
Grana nastro	80
Diametro disco	Ø 150 mm
Grana disco	80
Velocità di rotazione	2980 rpm
Inclinazione tavola	0 ÷ 45°
Dimensioni tavola	226 x 160 mm
Peso netto	16,5 kg



0138
€ 650,00
LEVIGATRICE A NASTRO VERTICALE E DISCO

Con piani di lavoro inclinabili.



Dimensioni	630 x 370 x 495h mm
Nastro	25 x 1075 mm
Velocità nastro	8,5 m/s
Diametro disco	200 mm
Motore	230 V 50 Hz 0,45 kW 1450 rpm
Dimensioni tavola nastro	180 x 150 mm
Dimensione tavola disco	250 x 120 mm
Peso netto	26 kg

0765
€ 286,00
SEGGETTO A LAMA VIBRANTE A VELOCITA' VARIABILE

Piano inclinabile, struttura robusta, adatto al taglio di balsa e compensati.

0753/L € 5,40
SERIE LAME
0753/A € 15,60
ADATTATORE LAMA

Capacità di taglio	400 x 50h mm
Lunghezza lama	125 mm
Oscillazioni	800 ÷ 1400 rpm
Dimensioni piano	410 x 250 mm
Inclinazione tavola	0 ÷ 45° sx
Dimensioni base	230 x 390 mm
Motore	230 V 50 Hz 0,12 kW
Temperatura di esercizio	da -5°C a +50°C
Peso netto	14 kg

0144
€ 516,00
SEGGETTO A LAMA VIBRANTE A VELOCITÀ VARIABILE

Con lampada Led. Piano inclinabile, struttura robusta, adatto al taglio di balsa, compensati, legni leggermente più duri, plastica e metalli non ferrosi.

0753/L € 5,40
SERIE LAME
0753/A € 15,60
ADATTATORE LAMA

Capacità di taglio	457 x 50h mm
Lunghezza lama	127 mm
Oscillazioni	550 ÷ 1650 rpm
Dimensioni piano	480 x 250 mm
Inclinazione tavola	0 ÷ 45° sx
Dimensioni base	220 x 420 mm
Motore	230 V 50 Hz 0,12 kW
Peso netto	16 kg

0720
€ 64,50
TAGLIA CORNICE

Con regolazione profondità di taglio, leva selezione angoli.

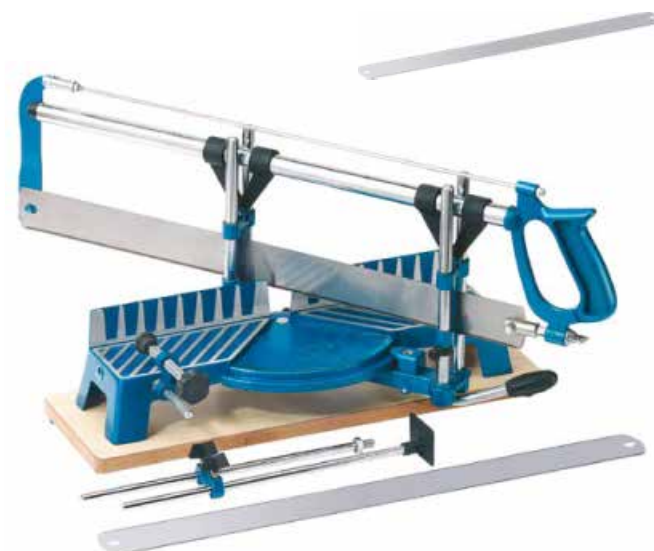
0720/L € 10,10
LAMA

Altezza di taglio	110 mm
Larghezza di taglio	120 mm
Inclinazione di taglio	0° ± 45°
Base	400 x 80 mm
Dimensioni lama	550 x 45 mm
Peso netto	4 kg

S015
€ 129,00
SPACCALEGNA MANUALE

A pedale per spaccare la legna da camino in piccoli pezzi per accendere il fuoco.



Capacità di lavoro	Ø 254 x 460 mm
Forza di spinta	1,2 ton
Dimensioni lama	100 x 80h mm
Peso netto	8,5 kg

S009
€ 1610,00
SPACCALEGNA VERTICALE

Da 7 tonnellate con cuneo a croce.



Capacità di lavoro in altezza	120 ÷ 540 mm
Capacità di lavoro	Ø 50 ÷ 320 mm
Forza di spinta	7 ton
Motore	230 V 50 Hz 3 kW
Giri motore a vuoto	2950 rpm
Peso netto	120 kg



0496
€ 850,00
ASPIRATORE PER TRUCIOLI CARRELLATO

Diametro aspirazione	3 x Ø 100 mm
Portata d'aria	3900 m ³ / h
Motore	230 V 50 Hz 2.2 kW
Filtro in tessuto	Ø 510 mm
Dimensioni	1450 x 800 x 2000 mm
Peso netto	48 kg

0759
€ 734,00
ASPIRATORE PER TRUCIOLI CARRELLATO

Parzialmente assemblato.



Diametro aspirazione	2 x Ø 100 mm
Portata d'aria	2500 m ³ / h
Capacità filtrante	5 micron
Filtro in tessuto	Ø 510 mm
Velocità motore	2950 rpm
Depressione	1,95 kPa
Motore	230 V 50 Hz 1.5 kW
Dimensioni	840 x 560 x 1800 h mm
Peso netto	40 kg

0756
€ 439,00
ASPIRATORE PER TRUCIOLI CARRELLATO

Parzialmente assemblato.



Diametro aspirazione	100 mm
Portata d'aria	850 m ³ / h
Capacità filtrante	5 micron
Filtro in tessuto	Ø 370 mm
Velocità motore	2950 rpm
Depressione	1,08 kPa
Motore	230 V 50 Hz 0.75 kW
Dimensioni	500 x 600 x 1700 h mm
Peso netto	23 kg

0507
€ 325,00
ASPIRATORE PER TRUCIOLI CARRELLATO

Parzialmente assemblato.



Diametro aspirazione	100 mm
Portata d'aria	900 m ³ / h
Capacità filtrante	5 micron
Filtro in tessuto	Ø 320 mm
Velocità motore	2840 rpm
Depressione	0,70 kPa
Motore	230 V 50 Hz 0.55 kW
Dimensioni	500 x 600 x 1700 h mm
Peso netto	18 kg

0495
€ 438,00
ASPIRATORE PORTATILE CARRELLATO

Con ruote per seghe a nastro e troncatrici per legno.



Diametro aspirazione	100 mm
Portata d'aria	830 m ³ / h
Filtro in tessuto	Ø 380 mm
Motore	230 V 50 Hz 0.75 kW
Dimensioni	395 x 325 x 350 mm
Peso netto	14 kg

0759/F € 31,90
SACCO FILTRAGGIO

Dimensioni Ø 510 mm x 855h mm

0759/S € 58,80
SERIE SACCHI IN PLASTICA

10 Pcs

Dimensioni Ø 510 mm x 855h mm

0756/F € 25,80
SACCO FILTRAGGIO

Dimensioni Ø 370 mm x 590h mm

0756/S € 48,50
SERIE SACCHI IN PLASTICA

10 Pcs

Dimensioni Ø 370 mm x 590h mm

0756/T € 44,60
TUBO SNODATO ESTENSIBILE

Con anima in metallo.

 Lunghezza massima 2 m
 Diametro 100 mm

0756/Y € 22,00
RACCORDO A Y

Diametro 100 mm

0507/Y € 5,50
RACCORDO A Y

 Dimensioni 150 x 110 x 170h mm
 Diametro aspirazione 2 x Ø 35 mm
 Diametro 100 mm

0507/14 € 26,00
SERIE SACCHI IN PLASTICA

10 Pcs

Dimensioni Ø 330 mm x 500h mm

0507/15 € 48,20
SACCO FILTRAGGIO

Dimensioni Ø 320 mm x 590h mm

0507/07 € 28,60
TUBO SNODATO

Con anima in metallo.

 Lunghezza 2 m mm
 Diametro 100 mm

0507/4R € 9,20
RACCORDO DI RIDUZIONE A 4 DIAMETRI

Riduzione da tubo di 100 mm a: 70 mm 50 mm 40 mm 35 mm.



Diametro 100 mm

0495/24 € 20,60
SACCO FILTRAGGIO

Dimensioni Ø380 mm x 530h mm

M011-
MORSA DI PRECISIONE

Adatte per lavori dove sono richiesti precisione, affidabilità, reperibilità e bloccaggio sicuro. Indicata per lavori di fresatura di precisione e rettifica sia su macchine manuali che centri di lavoro CNC. Superfici di scorrimento rettificate. Dotate di ganasce prismatiche discendenti all'atto del serraggio. Con elementi di fissaggio e chiavi di regolazione. Precisione 0,02 mm e durezza 57-62 HRC.

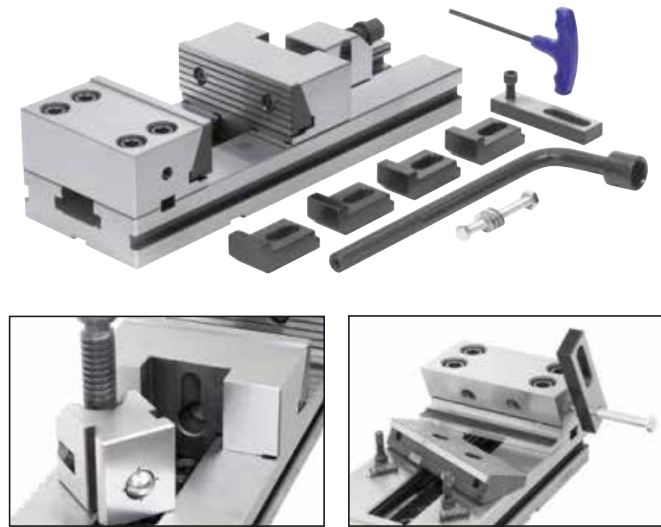
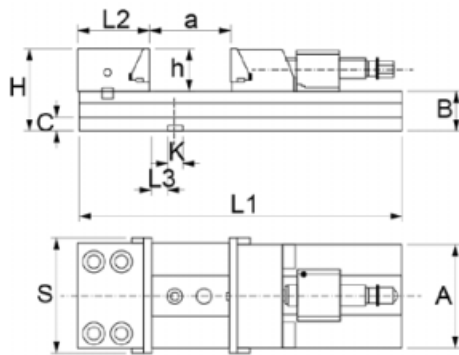

Art.	€	Dimensioni ganasca	S	A	B	C	H	L1	L2	L3	h	K h7	a	Peso netto
M011/125/150	€ 1160,00	125 x 50h mm	125 mm	125 mm	40 mm	15 mm	90 mm	350 mm	80 mm	25,6 mm	50 mm	16 mm	150 mm	19 kg
M011/150/210	€ 1340,00	150 x 60h mm	150 mm	150 mm	50 mm	20 mm	110 mm	435 mm	93 mm	25,6 mm	60 mm	16 mm	210 mm	35 kg
M011/150/300	€ 1670,00	150 x 60h mm	150 mm	150 mm	50 mm	20 mm	110 mm	525 mm	93 mm	25,6 mm	60 mm	16 mm	300 mm	35 kg

M028-
MORSA DI PRECISIONE

Adatte per lavori dove sono richiesti precisione, affidabilità, reperibilità e bloccaggio sicuro. Indicata per lavori di fresatura di precisione e rettifica sia su macchine manuali che centri di lavoro CNC. Superfici di scorrimento rettificate. Dotate di ganasce prismatiche discendenti all'atto del serraggio. Con elementi di fissaggio e chiavi di regolazione. Precisione 0,02 mm e durezza 57-62 HRC.

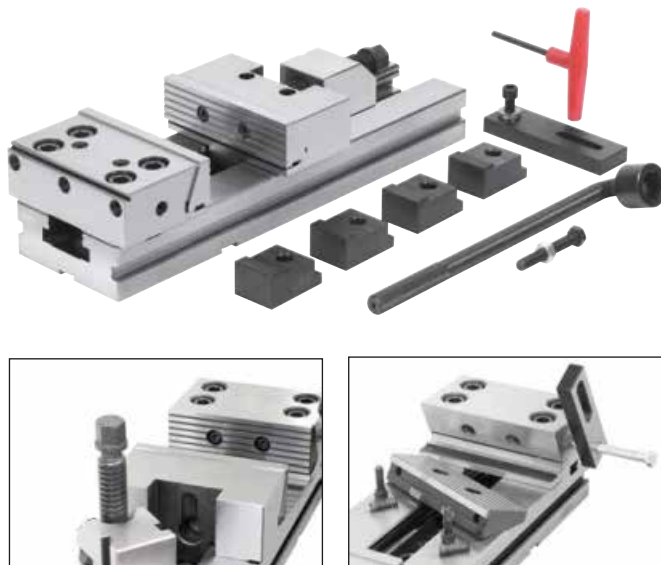
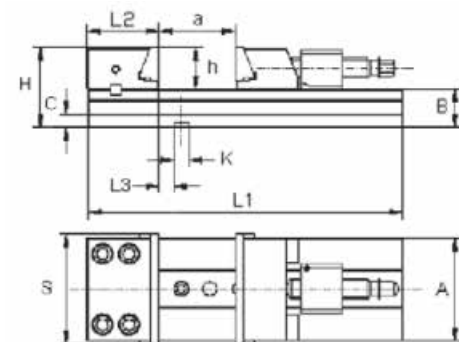

Art.	€	Dimensioni ganasca	S	A	B	C	H	L1	L2	L3	h	K h7	a	Peso netto
M028/100/100	€ 835,00	100 x 30h mm	100 mm	75 mm	35 mm	15 mm	65 mm	270 mm	77,9 mm	25,6 mm	30 mm	16 mm	100 mm	7 kg
M028/125/150	€ 907,00	125 x 40h mm	125 mm	95 mm	40 mm	15 mm	80 mm	345 mm	77,9 mm	25,6 mm	40 mm	16 mm	150 mm	13 kg
M028/150/200	€ 1080,00	150 x 50h mm	150 mm	125 mm	50 mm	20 mm	100 mm	420 mm	89,4 mm	25,6 mm	50 mm	16 mm	200 mm	26 kg
M028/150/300	€ 1160,00	150 x 50h mm	150 mm	125 mm	50 mm	20 mm	100 mm	520 mm	89,4 mm	25,6 mm	50 mm	16 mm	300 mm	30 kg
M028/150/400	€ 1340,00	150 x 50h mm	150 mm	125 mm	50 mm	20 mm	100 mm	620 mm	89,4 mm	25,6 mm	50 mm	16 mm	400 mm	34 kg
M028/175/200	€ 1340,00	175 x 60h mm	175 mm	145 mm	58 mm	20 mm	118 mm	455 mm	96,9 mm	25,6 mm	60 mm	16 mm	200 mm	40 kg
M028/175/300	€ 1380,00	175 x 60h mm	175 mm	145 mm	58 mm	20 mm	118 mm	555 mm	96,9 mm	25,6 mm	60 mm	16 mm	300 mm	43 kg
M028/175/400	€ 1550,00	175 x 60h mm	175 mm	145 mm	58 mm	20 mm	118 mm	655 mm	96,9 mm	25,6 mm	60 mm	16 mm	400 mm	50 kg
M028/175/500	€ 1730,00	175 x 60h mm	175 mm	145 mm	58 mm	20 mm	118 mm	755 mm	96,9 mm	25,6 mm	60 mm	16 mm	500 mm	50 kg
M028/200/300	€ 2080,00	200 x 65h mm	200 mm	170 mm	70 mm	26 mm	135 mm	595 mm	113,4 mm	25,6 mm	65 mm	16 mm	300 mm	69 kg
M028/200/400	€ 2140,00	200 x 65h mm	200 mm	170 mm	70 mm	26 mm	135 mm	695 mm	113,4 mm	25,6 mm	65 mm	16 mm	400 mm	74 kg
M028/200/500	€ 2580,00	200 x 65h mm	200 mm	170 mm	70 mm	26 mm	135 mm	795 mm	113,4 mm	25,6 mm	65 mm	16 mm	500 mm	79 kg
M028/200/600	€ 2840,00	200 x 65h mm	200 mm	170 mm	70 mm	26 mm	135 mm	895 mm	113,4 mm	25,6 mm	65 mm	16 mm	600 mm	84 kg

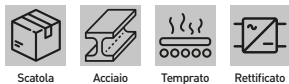
M011-xG
GANASCE DI RICAMBIO

Art.	€	Descrizione	Dimensioni ganascia
M011/125GP	€ 249,00	Ganascia prismatica	125 x 40h mm
M011/125GR	€ 418,00	Coppia ganasce rigate	125 x 40h mm
M011/150GP	€ 300,00	Ganascia prismatica	150 x 45h mm
M011/150GR	€ 447,00	Coppia ganasce rigate	150 x 45h mm

M028-xG
GANASCE PRISMATICHE DI RICAMBIO



Art.	€	Dimensioni
M028/100GP	€ 239,00	100 x 24,5h mm
M028M029/125GP	€ 250,00	125 x 32h mm
M028M029/150GP	€ 270,00	150 x 40h mm
M028/175GP	€ 300,00	175 x 43h mm
M028/200GP	€ 332,00	200 x 53h mm

M028-xGR
COPPIA GANASCE RIGATE DI RICAMBIO

Art.	€	Dimensioni ganascia
M028/100GR	€ 239,00	100 x 30h mm
M028/125GR	€ 250,00	125 x 40h mm
M028/150GR	€ 270,00	150 x 50h mm
M028/175GR	€ 300,00	175 x 60h mm
M028/200GR	€ 332,00	200 x 65h mm

M061
€ 469,00
MORSA DI PRECISIONE CON BARRA SENO

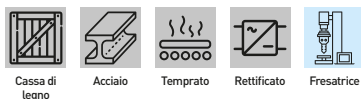
Con chiusura a vite, barra seno ad apertura longitudinale. Accoppiamenti rettificati con alta precisione. Precisione indicata su parallelismo e quadratura. Ideale per lavori di rettifica, elettroerosione, fresatura e nei sistemi di misurazione.



Lunghezza morsa	235 mm
Dimensioni ganascia	88 x 40 h mm
Interasse dei perni	100 mm
Apertura	120 mm
Precisione	0,005 mm
Inclinazione	0° ÷ 45°
Peso netto	12,5 kg

M012-
MORSA DI PRECISIONE

A chiusura rapida, accoppiamenti rettificati con alta precisione. Precisione indicata su parallelismo e quadratura. Ideale per lavori di rettifica, elettroerosione, fresatura e nei sistemi di misurazione.

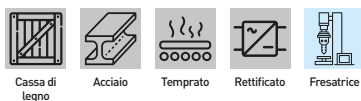

Art.	€	Dimensioni	Apertura	Altezza ganascia	Precisione
M012/038	€ 94,10	38 x 105 x 45h mm	44 mm	25 mm	0,005 mm
M012/050	€ 98,30	50 x 140 x 50h mm	65 mm	25 mm	0,005 mm
M012/080	€ 238,00	73 x 190 x 67h mm	110 mm	35 mm	0,005 mm
M012/100	€ 332,00	100 x 245 x 90h mm	125 mm	45 mm	0,005 mm

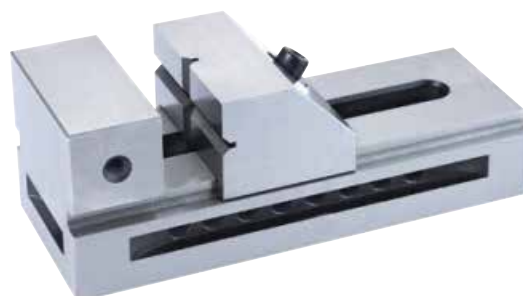

M023-
MORSA A MACCHINA CON BASE GIREVOLE 360°

Con ganasce intercambiabili in acciaio temprate e rettificate. Parti di scorrimento rettificate. Vite completamente coperta. Con manovella.



Art.	€	Ganasce	Apertura	Dimensioni	Dimensioni base	Interasse fori	Cava	Peso netto
M023/100	€ 234,00	100 x 35 mm	80 mm	310 x 165 x 130h mm	215 x 165 mm	195 mm	14 mm	11 kg
M023/125	€ 279,00	125 x 40 mm	100 mm	355 x 190 x 127h mm	215 x 165 mm	195 mm	14 mm	15 kg
M023/160	€ 377,00	160 x 50 mm	125 mm	422 x 235 x 162h mm	300 x 235 mm	275 mm	18 mm	30 kg
M023/200	€ 475,00	200 x 61 mm	160 mm	490 x 270 x 175h mm	360 x 280 mm	315 mm	18 mm	47 kg

M014-
MORSA A MACCHINA CON BASE GIREVOLE 360°

Con ganasce intercambiabili in acciaio temprate e rettificate. Parti di scorrimento rettificate. Vite completamente coperta. Con manovella.



Art.	€	Ganasce	Apertura	Dimensioni	Dimensioni base	Interasse fori	Cava	Peso netto
M014/080	€ 115,00	80 x 30 mm	60 mm	195 x 110 x 91h mm	110 x 154 mm	130 mm	14 mm	4,5 kg
M014/100	€ 150,00	100 x 35 mm	75 mm	242 x 129 x 106h mm	135 x 186 mm	160 mm	14 mm	9 kg
M014/125	€ 208,00	125 x 40 mm	95 mm	285 x 166 x 126h mm	166 x 210 mm	185 mm	14 mm	14 kg
M014/160	€ 290,00	160 x 52 mm	120 mm	390 x 218 x 166h mm	218 x 275 mm	245 mm	18 mm	28 kg
M014/200	€ 394,00	200 x 63 mm	150 mm	440 x 239 x 183h mm	239 x 315 mm	275 mm	18 mm	40 kg

M024-
MORSA A MACCHINA CON BASE GIREVOLE 360°

Con ganasce intercambiabili in acciaio temprate e rettificate. Parti di scorrimento rettificate. Vite scoperte. Con manovella e viti fissaggio.

M024/250

Art.	€	Ganasce	Apertura	Dimensioni	Dimensioni base	Interasse fori	Cava	Peso netto
M024/136	€ 202,00	136 x 32 mm	170 mm	375 x 162 x 123h mm	223 x 165 mm	200 mm	14 mm	14 kg
M024/160	€ 291,00	160 x 50 mm	180 mm	402 x 182 x 142h mm	252 x 182 mm	225 mm	14 mm	23 kg
M024/200	€ 383,00	200 x 63 mm	220 mm	470 x 234 x 172h mm	290 x 222 mm	260 mm	18 mm	33 kg
M024/250	€ 556,00	250 x 45 mm	320 mm	612 x 280 x 186h mm	290 x 270 mm	245 mm	18 mm	50 kg

M530-
MORSA A MACCHINA INCLINABILE CON BASE GIREVOLE 360°

Con ganasce intercambiabili in acciaio temprate e rettificate. Parti di scorrimento rettificate. Vite completamente coperta. Con manovella e viti fissaggio.



Art.	€	Ganasce	Apertura	Inclinazione	Dimensioni	Dimensioni base	Interasse fori	Cava	Peso netto
M530/100	€ 349,00	100 x 32 mm	90 mm	0° - 90°	325 x 180 x 150h mm	250 x 180 mm	230 mm	14 mm	15 kg
M530/125	€ 415,00	125 x 40 mm	100 mm	0° - 90°	360 x 206 x 165h mm	290 x 226 mm	260 mm	18 mm	24 kg
M530/160	€ 508,00	160 x 50 mm	125 mm	0° - 90°	443 x 270 x 194h mm	325 x 250 mm	300 mm	18 mm	35 kg

M017-
NEW
MORSA DA TRAPANO SERIE PESANTE

Dotata di ganasce prismatiche, con protezione vite dalle infiltrazioni di polvere e altri residui.



Art.	€	Ganasce	Altezza ganascia	Apertura	Dimensioni base	Peso netto
M017/080	€ 82,00	80 mm	25 mm	87 mm	185 x 155 mm	4,3 Kg
M017/100	€ 95,00	100 mm	32 mm	100 mm	230 x 200 mm	7,8 Kg

M027-
MORSA TRAPANO

Dotata di guide raschietate per una maggiore precisione e un miglior scorrimento.

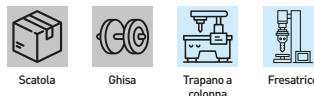

Art.	€	Ganasce	Apertura	Dimensioni base	Peso netto
M027/100	€ 173,00	100 x 40 mm	100 mm	290 x 170 mm	8 kg
M027/140	€ 244,00	140 x 50 mm	140 mm	375 x 230 mm	12 kg
M027/200	€ 395,00	200 x 60 mm	200 mm	485 x 295 mm	25 kg

M016-
NEW
MORSA A MACCHINA ORIZZONTALE - VERTICALE

Dotata di una ganascia prismatica ed una liscia, lunghezza complessiva costante grazie alle vite inserita nell'impugnatura. Rettificata su 3 posizioni in modo da poterla fissare in posizione orizzontale, verticale e laterale.

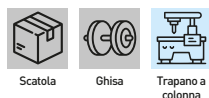

Art.	€	Ganasce	Altezza ganascia	Apertura	Dimensioni base	Peso netto
M016/075	€ 120,00	75 mm	30 mm	70 mm	150 x 142 mm	3 Kg
M016/100	€ 140,00	100 mm	30 mm	95 mm	175 x 160 mm	4,3 Kg

M001-
MORSA TRAPANO

Dotata di una ganascia prismatica ed una ganascia liscia. Lunghezza complessiva costante grazie alla vite inserita nell'impugnatura.



Art.	€	Ganasce	Apertura	Dimensioni base	Peso netto
M001/100	€ 65,20	100 mm	80 mm	182 x 156 mm	4 kg
M001/120	€ 80,00	120 mm	110 mm	200 x 175 mm	5 kg
M001/150	€ 100,00	150 mm	135 mm	230 x 195 mm	7 kg

0142-
MORSA TRAPANO

Dotata di una ganascia prismatica ed una ganascia liscia.



Art.	€	Ganasce	Apertura	Dimensioni base	Peso netto
0142/75	€ 22,50	75 X 24 mm	55 mm	123 x 115 mm	1,5 kg
0142/100	€ 31,90	100 x 25,5 mm	85 mm	160 x 155 mm	2,5 kg
0142/125	€ 39,70	125 x 30 mm	100 mm	182 x 182 mm	4 kg

0698/100
€ 101,00
MORSA INCLINABILE

Ideale per forare con qualsiasi angolo di attacco.



Scatola



Ghisa

 Trapano a
colonna

Ganasce	105 x 47 mm
Apertura	105 mm
Inclinazione	0°-15°-30°-45°-60°-75°-90°
Base	192 x 185 mm
Interasse fori	160 mm
Dimensioni	192 x 185 x 115h mm
Peso netto	8 kg

M034/120
€ 312,00
MORSA TRAPANO A SERRAGGIO RAPIDO

Con ganasca prismatica e base girevole.



Scatola



Ghisa

 Trapano a
colonna

Ganasce	120 x 40 mm
Apertura	120 mm
Dimensioni base	220 x 130 mm
Cava	14 mm
Peso netto	7 kg

0188-
MORSA A CROCE

Utile per eseguire lavorazioni di foratura o maschiatura di precisione grazie al movimento longitudinale e laterale senza rimuovere il pezzo dalla morsa.

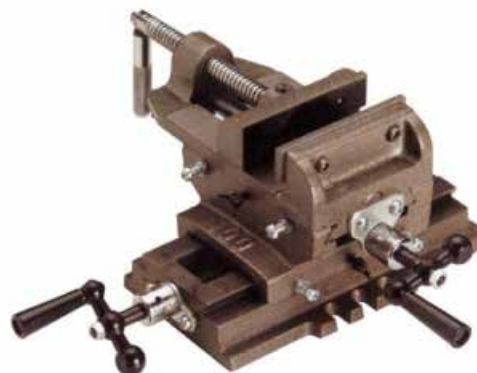

Scatola



Ghisa

 Trapano a
colonna

Art.	€	Ganasce	Apertura	Dimensioni base	Altezza	Corsa longitudinale	Corsa trasversale	Peso netto
0188/100	€ 94,70	100 x 25 mm	90 mm	240 x 140 mm	140 mm	130 mm	110 mm	7,5 kg
0188/125	€ 134,00	125 x 40 mm	110 mm	255 x 160 mm	150 mm	170 mm	130 mm	13 kg
0188/150	€ 169,00	150 x 40 mm	145 mm	280 x 170 mm	160 mm	160 mm	180 mm	14,5 kg

0188-xG
MORSA A CROCE CON GIREVOLE

Utile per eseguire lavorazioni di foratura o maschiatura di precisione grazie al movimento longitudinale e laterale senza rimuovere il pezzo dalla morsa. Dotata di base girevole.



Scatola



Ghisa

 Trapano a
colonna

Art.	€	Ganasce	Apertura	Dimensioni base	Altezza	Corsa longitudinale	Corsa trasversale	Cava	Peso netto
0188/100G	€ 160,00	100 X 25 mm	90 mm	210 x 150 mm	175 mm	130 mm	110 mm	18 mm	11,5 kg
0188/125G	€ 181,00	125 X 40 mm	120 mm	230 x 175 mm	180 mm	150 mm	120 mm	20 mm	14,5 kg
0188/150G	€ 206,00	150 X 45 mm	150 mm	235 x 195 mm	190 mm	170 mm	115 mm	20 mm	19,5 kg

0766-

NEW

SET PARALLELE MAGNETICHE

Rettificato a coppie. Utilizzati come spessori del pezzo in un'ampia varietà di operazioni di lavorazione, garantendo il bloccaggio parallelo. Grazie all'attacco magnetico si ha una riduzione dei tempi di serraggio.

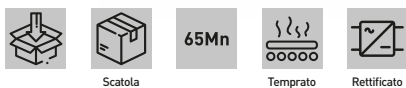

Art.	€	Dimensioni	Durezza	Precisione
0766/090	€ 175,00	90 x 2,5 x (15-22-25-30-32) mm	HRC 60	± 0,005 mm
0766/125	€ 184,00	125 x 2,5 x (15-30-35-37-39) mm	HRC 60	± 0,005 mm
0766/150	€ 215,00	150 x 2,5 x (25-35-40-45-47) mm	HRC 60	± 0,005 mm

P014

€ 349,00

SERIE PARALLELE

Rettificato a coppie. Utilizzati come spessori del pezzo in un'ampia varietà di operazioni di lavorazione, garantendo il bloccaggio parallelo.



Dimensioni	150 x 10 x (14-16-18-20-22-24-26-28-30-32-35-40-45-50) mm
Durezza	HRC 60
Precisione	± 0,005 mm

P015

€ 190,00

SERIE PARALLELE

Rettificato a coppie. Utilizzati come spessori del pezzo in un'ampia varietà di operazioni di lavorazione, garantendo il bloccaggio parallelo.



Dimensioni	160 x 4 x (10-14-18-22-26-30-34-38-42) mm
Durezza	HRC 60
Precisione	± 0,005 mm

P017

€ 134,00

SERIE PARALLELE

Rettificato a coppie. Utilizzati come spessori del pezzo in un'ampia varietà di operazioni di lavorazione, garantendo il bloccaggio parallelo.



Dimensioni	150 x 8 x (14-16-20-24-30-32-36-40-44) mm
Durezza	HRC 45
Precisione	± 0,005 mm

**D023**

€ 2030,00

DIVISORE RAPIDO A SCATTI ORIZZONTALE E VERTICALE

Permette di avere varie tipologie di divisioni in base al tipo di disco montato. La divisione viene effettuata automaticamente tramite la leva di avanzamento. Completo di staffe di bloccaggio.

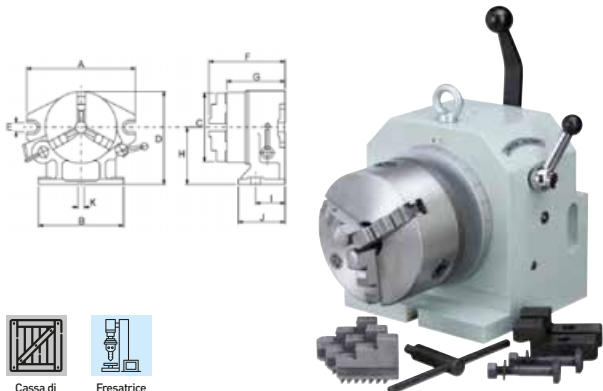

Cassa di legno



Fresatrice

Divisioni	2 - 3 - 4 - 6 - 8 - 12 - 24
A	230 mm
B	230 mm
C	160 mm
D	236 mm
E	18 mm
F	320 mm
G	285 mm
H	125 mm
I	- mm
J	210 mm
K	18 mm
Foro	30 mm
Portata max orizzontale	50 kg
Portata max verticale	10 kg
Peso netto	66,5 kg

D003

€ 1590,00

DIVISORE ORIZZONTALE VERTICALE A SCATTI RAPIDO

Permette di avere varie tipologie di divisioni in base al tipo di disco montato. La divisione viene effettuata automaticamente tramite la leva di avanzamento. Possibilità di divisione manuale di grado in grado 0° - 360°.

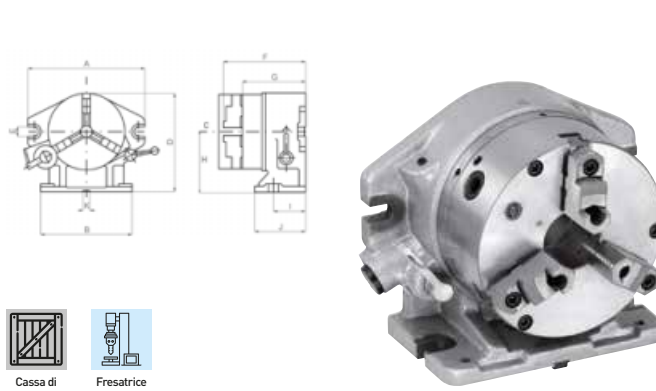

Cassa di legno



Fresatrice

Divisioni	2 - 3 - 4 - 6 - 8 - 12 - 24
A	310 mm
B	255 mm
C	210 mm
D	259,25 mm
E	18 mm
F	214 mm
G	171,5 mm
H	149,25 mm
I	80 mm
J	130 mm
K	16 mm
Foro	62 mm
Portata max orizzontale	50 kg
Portata max verticale	10 kg
Peso netto	52 kg

T016/100

€ 473,00

TAVOLA GIREVOLE BASCULANTE

Per posizionamenti precisi sia di rotazione che di inclinazione grazie alle graduazioni presenti sul volantino e leva bloccaggio inclinazione. Completo di staffe di bloccaggio.



Scatola



Fresatrice

A	143 mm
B	130 mm
C	105 mm
D	102 mm
d	18 mm
H	68 mm
Rotazione	360°
Inclinazione tavola	90°
Rapporto	1:36
Cave	4 x 6,35 mm 5/16"
Altezza in orizzontale	102 mm
Peso netto	5 kg

T017/100

€ 676,00

TAVOLA GIREVOLE BASCULANTE CON MANDRINO

Per posizionamenti precisi sia di rotazione che di inclinazione grazie alle graduazioni presenti sul volantino e leva bloccaggio inclinazione. Completo di staffe di bloccaggio.

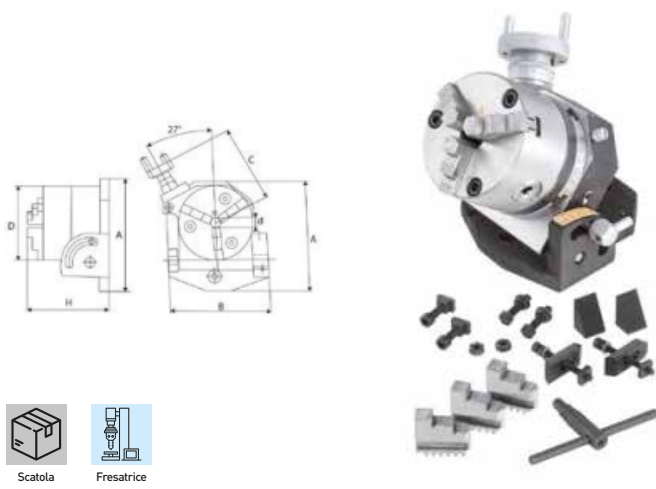

Scatola



Fresatrice

Mandrino	100 mm
A	143 mm
B	130 mm
C	105 mm
D	100 mm
d	20 mm
H	160 mm
Rotazione	360°
Inclinazione tavola	90°
Rapporto	1:36
Cave	4 x 8 mm
Altezza in orizzontale	102 mm
Peso netto	11 kg

T001-

TAVOLA A DIVIDERE BASCULANTE 0° ÷ 90°

Dotata di regolazione micrometrica ed ingranaggi a bagno d'olio.

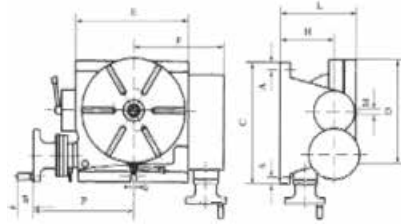

Art.	€	A	B	C	D	E	F	G	H	L	CM	Rapporto	Cave	Portata max orizzontale	Portata max verticale	Peso netto
T001/250	€ 2720,00	14 mm	40 mm	310 mm	250 mm	252 mm	199 mm	14 mm	140 mm	205 mm	3	1:90	6/12 N° / mm	200 kg	100 kg	78 kg
T001/320	€ 2980,00	16 mm	40 mm	380 mm	320 mm	322 mm	241 mm	18 mm	185 mm	257 mm	4	1:90	6/14 N° / mm	250 kg	125 kg	133 kg

D005-

DISCHI DIVISORI PER TAVOLA A DIVIDERE



Art.	€	Per tavole	Rapporto	Fori nei dischi	Foro	Esterno
D005	€ 245,00	T001/250 - 320, T002/160 - 320	1:90	A: 34-37-38-39-41-43-44-50-52-56-6, B: 46-47-49-51-53-54-57-58-59-62-64	38 mm	130 mm
D005/400	€ 274,00	T002/400	1:90	A: 34-37-38-39-41-43-44-50-52-56-61, B: 46-47-49-51-53-54-57-58-59-62-64	53 mm	170 mm
D005/500	€ 363,00	T012/500 T012/630	1:120	A: 33-34-37-38-39-41-43-44-50-52-56-61, B: 46-47-49-51-53-54-57-58-59-62-63-64	53 mm	170 mm

T002-

TAVOLA A DIVIDERE ORIZZONTALE VERTICALE

Dotata di regolazione micrometrica ed ingranaggi a bagno d'olio.

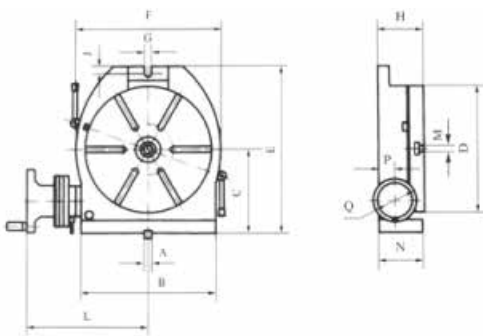

Art.	€	A	B	C	D	E	F	G	H	J	L	N	P	Q	CM	Rapporto	Cave	Portata max orizzontale	Portata max verticale	Peso netto
T002/160	€ 844,00	12 mm	186 mm	125 mm	160 mm	242 mm	196 mm	12 mm	85 mm	12 mm	194 mm	82 mm	37 mm	125 mm	2	1:90	4/10 N° / mm	100 kg	50 kg	23 kg
T002/200	€ 984,00	14 mm	208 mm	150 mm	200 mm	285 mm	236 mm	14 mm	100 mm	15 mm	211 mm	99 mm	48 mm	125 mm	3	1:90	4/12 N° / mm	150 kg	75 kg	30 kg
T002/250	€ 1040,00	14 mm	253 mm	170 mm	250 mm	328 mm	286 mm	14 mm	110 mm	16 mm	241 mm	106 mm	48 mm	125 mm	4	1:90	6/12 N° / mm	200 kg	100 kg	44 kg
T002/320	€ 1680,00	18 mm	321 mm	210 mm	320 mm	410 mm	360 mm	18 mm	120 mm	16 mm	273 mm	118 mm	48 mm	125 mm	4	1:90	6/14 N° / mm	250 kg	125 kg	75 kg
T002/400	€ 2340,00	18 mm	400 mm	260 mm	400 mm	525 mm	450 mm	18 mm	150 mm	16 mm	337 mm	145 mm	70 mm	160 mm	4	1:90	6/14 N° / mm	300 kg	150 kg	174 kg

**C054** € 249,00**CONTROPUNTA REGOLABILE IN ALTEZZA**

Cassa di legno



Fresatrice

Per tavole	T002/160
Altezza punta	95 - 150 mm
Peso netto	9 kg

C051 € 328,00**CONTROPUNTA REGOLABILE IN ALTEZZA**

Cassa di legno



Fresatrice

Per tavole	T001/250 - T002/200 - T002/250
CM	2
Altezza punta	140 - 180 mm
Peso netto	18 kg

C052 € 425,00**CONTROPUNTA REGOLABILE IN ALTEZZA**

Cassa di legno



Fresatrice

Per tavole	T002/320 - T001/320
CM	2
Altezza punta	180 - 224 mm
Peso netto	20 kg

D004-**DIVISORE UNIVERSALE COMPLETO DI MANDRINO, CONTROPUNTA E DISCHI DIVISORI**

Consente all'operatore di eseguire rotazioni angolari esattamente determinate, ad esempio richieste per le divisioni di una circonferenza in un certo numero di parti uguali.

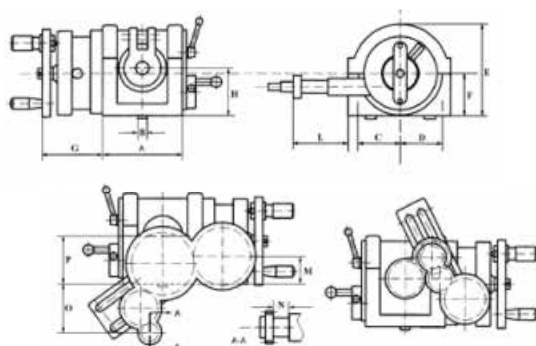

Cassa di legno



Fresatrice

Art.	€	A	B	C	D	E	F	G	H	L	CM	N	P	Mandrino	Rapporto	Portata	Fori nei dischi	Peso netto
D004/125L	€ 2960,00	209 mm	18 mm	116 mm	98 mm	224 mm	117 mm	120 mm	125 mm	103 mm	4	34,5 mm	100 mm	Ø 160 mm	1:40	130 kg	24 - 25 - 28 - 30 - 34 - 37 - 38 - 39 - 41 - 42 - 43 - 46 - 47 - 49 - 51 - 53 - 54 - 57 - 58 - 59 - 62 - 66	119 kg
D004/160L	€ 3310,00	209 mm	18 mm	116 mm	98 mm	259 mm	152 mm	120 mm	160 mm	103 mm	4	34,5 mm	100 mm	Ø 200 mm	1:40	130 kg	24 - 25 - 28 - 30 - 34 - 37 - 38 - 39 - 41 - 42 - 43 - 46 - 47 - 49 - 51 - 53 - 54 - 57 - 58 - 59 - 62 - 66	125 kg

D006-**DIVISORE SEMI UNIVERSALE COMPLETO DI CONTROPUNTA E DISCHI DIVISORI**

Mandrino non incluso, dotato di vite senza fine temprata e rettificata e di cuscinetti a rulli conici di precisione. Consente all'operatore di eseguire rotazioni angolari esattamente determinate, ad esempio richieste per le divisioni di una circonferenza in un certo numero di parti uguali.

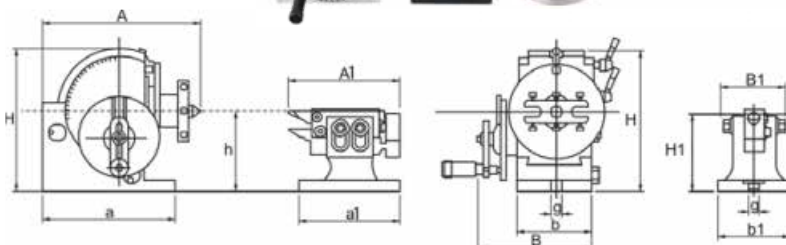

Scatola



Fresatrice

Art.	€	A	B	H	h	a	b	G	A1	B1	H1	h1	a1	b1	Mandrino adattabile	g1	Foro	CM	Rapporto	Inclinazione testa	Fori nei dischi	Peso netto
D006/100	€ 914,00	193 mm	131 mm	173 mm	100 mm	166 mm	90 mm	16 mm	175 mm	87 mm	102 mm	100 mm	130 mm	82 mm	Ø 125 mm	16 mm	Ø 18 mm	2	1:40	-10° - 90°	15-16-17-18-19-20-21-23-27-29-31-33-37-39-41-43-47-49	16 kg
D006/128	€ 1490,00	242 mm	168 mm	220 mm	128 mm	206 mm	113 mm	16 mm	183 mm	87 mm	137 mm	128 mm	158 mm	110 mm	Ø 160 mm	16 mm	Ø 20 mm	3	1:40	-10° - 90°	15-16-17-18-19-20-21-23-27-29-31-33-37-39-41-43-47-49	30 kg

T013

€ 1320,00

TAVOLA A CROCE

Con canaline per refrigerante. Graduazione registrabile del volantino.



A	210 mm
B	730 mm
C	315 mm
D	395 mm
E	240 mm
F	300 mm
Cava	14 mm
Altezza	155 mm
Spostamenti	160 x 360 mm
Divisione	0,05 mm
Peso netto	70 kg

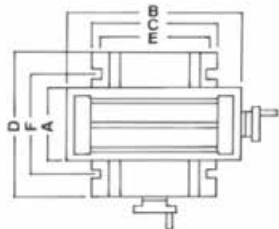

T014G

€ 1120,00

TAVOLA A CROCE GIREVOLE

Dotata di base girevole. Con canaline per refrigerante. Graduazione registrabile del volantino.



A	240 mm
B	600 mm
C	280 mm
D	340 mm
E	260 mm
F	250 mm
Cava	12 mm
Altezza	160 mm
Spostamenti	155 x 370 mm
Divisione	0,02 mm
Peso netto	60 kg

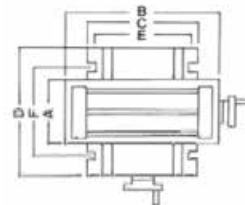

T015

€ 590,00

TAVOLA A CROCE

Con graduazione registrabile del volantino. Dotata di lardone conico con vite in testa e guide raschiate per una maggiore precisione e un miglior scorrimento.



A	100 mm
B	185 mm
C	130 mm
D	170 mm
E	104 mm
F	103 mm
Cava	10 mm
Altezza	100 mm
Spostamenti	50 x 80 mm
Divisione	0,01 mm
Peso netto	10 kg

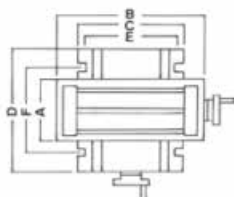

T015/E

€ 314,00

TAVOLA A CROCE

Con graduazione registrabile del volantino.

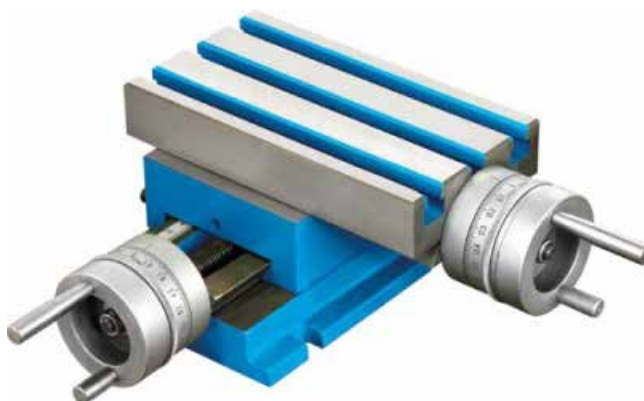

A	100 mm
b	185 mm
C	130 mm
D	173 mm
E	102 mm
F	100 mm
Cava	10 mm
Altezza	104 mm
Spostamenti	50 x 80 mm
Divisione	0,01 mm
Peso netto	10 kg

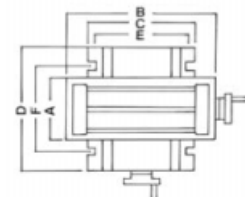

**T008**

€ 365,00

TAVOLA A CROCE

Scatola



Ghisa



Fresatrice

A	153 mm
B	475 mm
C	200 mm
D	270 mm
Cava	16 mm
Interasse cava	75 mm
Altezza	130 mm
Spostamenti	120 x 325 mm
Interasse fori base	162 mm
Peso netto	23 kg

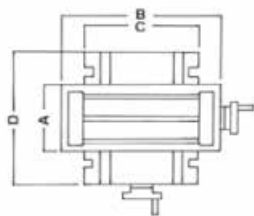
**T018/350**

€ 173,00

TAVOLA A CROCE

Con scala millimetrata fissa per i movimenti della tavola longitudinali.



Scatola



Alluminio



Fresatrice



Trapano a colonna

A	100 mm
B	350 mm
C	160 mm
D	190 mm
Altezza	120 mm
Cava	8 mm
Interasse cava	36 mm
Spostamenti	177 x 50 mm
Divisione	0,05 mm
Dimensioni ingombro	415 x 255 mm
Peso netto	6 kg

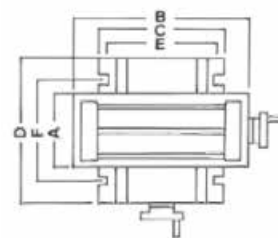
**T018/330**

€ 92,40

TAVOLA A CROCE

Con scala millimetrata fissa per i movimenti della tavola longitudinali.



Scatola



Alluminio



Fresatrice



Trapano a colonna

A	95 mm
B	330 mm
C	125 mm
D	145 mm
Altezza	82 mm
Cava	8 mm
Interasse cava	36 mm
Spostamenti	190 x 65 mm
Divisione	0,05 mm
Dimensioni ingombro	395 x 210 mm
Peso netto	2,5 kg

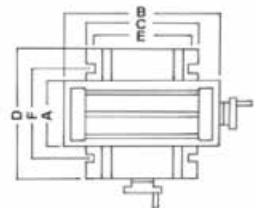
**T004-****TAVOLA BASCULANTE**

Con regolazione dell'inclinazione su entrambi i lati.

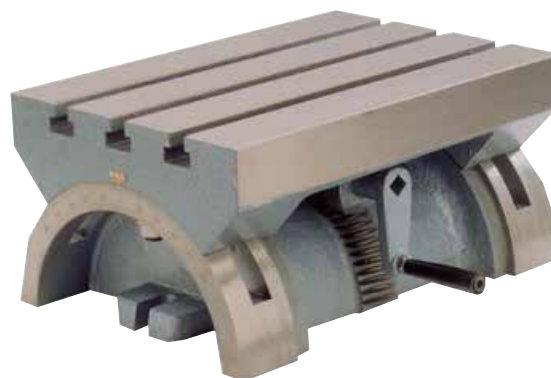

Cassa di legno



Ghisa



Fresatrice

Art.	€	Dimensioni	Cava	Inclinazione	Peso netto
T004/250	€ 430,00	255 x 180 x 135h mm	12 mm	± 36°	15 kg
T004/380	€ 653,00	380 x 250 x 180h mm	16 mm	± 36°	45 kg
T004/600	€ 1110,00	610 x 305 x 253h mm	16 mm	± 36°	105 kg

P077-
PIANO MAGNETICO PERMANENTE

Cassa di legno Acciaio

Art.	€	Dimensioni	Forza magnetica	Passo polarità	Peso netto
P077/1525	€ 760,00	250 x 150 x 60 mm	180 N/cm ²	3 + 12 mm	17 Kg
P077/1530	€ 905,00	300 x 150 x 60 mm	180 N/cm ²	3 + 12 mm	20 Kg
P077/2040	€ 1600,00	400 x 200 x 60 mm	180 N/cm ²	3 + 12 mm	37 Kg
P077/3050	€ 3020,00	500 x 300 x 60 mm	180 N/cm ²	3 + 12 mm	65 Kg
P077/3060	€ 3620,00	600 x 300 x 60 mm	180 N/cm ²	3 + 12 mm	80 Kg

P078-
PIANO MAGNETICO PERMANENTE

Con polarità fitta. Permette la lavorazione di pezzi di piccole dimensioni e di basso spessore grazie al passo fine.



Cassa di legno Acciaio

Art.	€	Dimensioni	Forza magnetica	Passo polarità	Peso netto
P078/1525	€ 495,00	250 x 150 x 48 mm	120 N/cm ²	0,5 + 1,5 mm	16 Kg
P078/1530	€ 586,00	300 x 150 x 48 mm	120 N/cm ²	0,5 + 1,5 mm	17 Kg
P078/1535	€ 658,00	350 x 150 x 48 mm	120 N/cm ²	0,5 + 1,5 mm	20 Kg
P078/1540	€ 736,00	400 x 150 x 51 mm	120 N/cm ²	0,5 + 1,5 mm	24 Kg
P078/1545	€ 857,00	450 x 150 x 51 mm	120 N/cm ²	0,5 + 1,5 mm	27 Kg
P078/2045	€ 1210,00	450 x 200 x 51 mm	120 N/cm ²	0,5 + 1,5 mm	38 Kg
P078/2050	€ 1330,00	500 x 200 x 58 mm	120 N/cm ²	0,5 + 1,5 mm	57 Kg
P078/2060	€ 1570,00	600 x 200 x 58 mm	120 N/cm ²	0,5 + 1,5 mm	55 Kg

P079-
PIANO MAGNETICO CON BARRA SENO

Scatola Acciaio

Art.	€	Dimensioni	Forza magnetica	Passo polarità	Inclinazione	Peso netto
P079/1515	€ 966,00	150 x 150 x 86 mm	120 N/cm ²	0,5 + 1,5 mm	0° - 60°	17 Kg
P079/1530	€ 1330,00	150 x 300 x 86 mm	120 N/cm ²	0,5 + 1,5 mm	0° - 60°	32 Kg

K001-
KIT STAFFAGGIO

Composte da: 24 tiranti, 6 dadi a T, 6 dadi bassi, 4 manicotti giunzione, 6 staffe semplici, 12 appoggi gradinati, pratico supporto da parete.



58 Pcs Scatola Acciaio

Art.	€	Cava	Filetto
K001/12	€ 125,00	12 mm	M10
K001/14	€ 139,00	14 mm	M12
K001/16	€ 162,00	16 mm	M14
K001/18	€ 203,00	18 mm	M16

K002-
SET STAFFAGGIO

Composto da 2 appoggi gradinati, 2 tiranti e 2 bulloni con testa a T e dadi flangiati. Per fissare gli elementi da fresare su tavole.



6 Pcs Appendibile Acciaio Zincata

Art.	€	2 Cunei di blocco	2 Staffe	2 Tiranti a T con dado	Cava
K002/08	€ 33,70	25 x 25 x 42 mm	90 x 25 x 12 mm	M6 x 100 mm	8 mm
K002/10	€ 36,00	25 x 25 x 42 mm	100 x 25 x 15 mm	M8 x 100 mm	10 mm
K002/12	€ 39,50	25 x 25 x 42 mm	100 x 25 x 15 mm	M10 x 100 mm	12 mm
K002/14	€ 46,40	25 x 25 x 42 mm	100 x 31 x 19 mm	M12 x 100 mm	14 mm





NUOVA GAMMA MANDRINI FERVI



CARATTERISTICHE PRINCIPALI

La nuova linea di mandrini è compatibile con tutti i torni Fervi.

Incisione a laser con logo, modello e numero max giri.

Corpo unico intercambiabile, bilanciato ed equilibrato, in ghisa sferoidale pesante con ottima rigidità, che permette un'ottima tolleranza di presa.

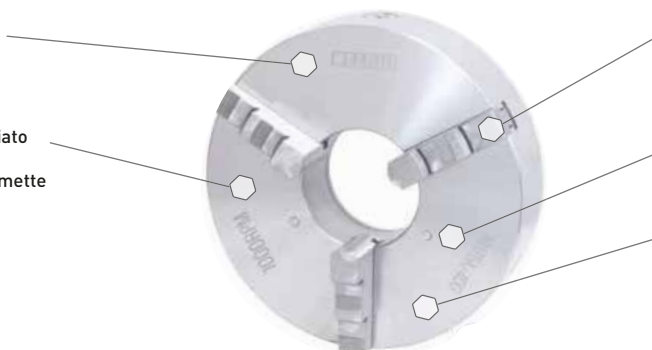

Resistenti griffe in acciaio temprato, rinvenuto e rettificato.

Pratico ingrassatore/i per lubrificare le varie parti.

La nuova gamma di mandrini Fervi consente l'intercambiabilità tra articoli di pari misura e con lo stesso numero di griffe.

ATTACCO A FLANGIA

Questa gamma di mandrini è concepita per il fissaggio mediante flangia. Per l'accoppiamento del mandrino con la flangia, può rendersi necessaria una lavorazione meccanica. Possono essere applicati anche su altri organi meccanici (quali tavole a dividere o divisori), previo aggiustamenti meccanici.



ATTACCO CAMLOCK INTEGRATO

Gli attacchi Camlock consentono un più rapido cambio e soprattutto evitano lo svitamento accidentale del mandrino. Non necessita di nessuna lavorazione preliminare per il montaggio sulla macchina.



GUIDA ALLA SCELTA DEL MANDRINO

La scelta del mandrino è legata alla tipologia di lavorazione che si desidera eseguire.

MANDRINO A 3 GRIFFE (AUTOCENTRANTE)



Consentono di bloccare, centrando, pezzi circolari pieni oppure tubolari, poligonali con numero di lati divisibile per 3, mediante griffe dritte o rovesce.

MANDRINO A 4 GRIFFE (AUTOCENTRANTE)



Vengono utilizzati per il fissaggio di pezzi circolari pieni oppure tubolari, a sezione irregolare o poligonale con un numero di lati divisibile per 4, mediante griffe dritte o rovesce.

MANDRINO A GRIFFE INDIPENDENTI



In questa tipologia di mandrini ogni griffa è dotata di movimento indipendente al fine di poter fissare il pezzo con il suo asse fuori centro nel caso di particolari tipi di lavorazione.

IN BASE AL TORNIO



ALTEZZA PUNTE

Questo parametro indica l'altezza tra il centro del mandrino e il banco del tornio. L'altezza punta determina il raggio massimo lavorabile sul banco. Moltiplicando il valore per 2 avremo il diametro massimo lavorabile sul banco.

PASSAGGIO BARRA

È il diametro del foro passante presente sul tornio per poter permettere di infilare barre di lunghe dimensioni da tornire infilandole e bloccandole tra le ganasce del mandrino.

TIPOLOGIA DI ATTACCO CAMLOCK

Determinato dal diametro dei perni della flangia del testa del tornio oppure se disponibili dai dati tecnici della macchina.

M075A-
NEW
MANDRINO AUTOCENTRANTE DI PRECISIONE 3+3+3 GRIFFE

A guida singola. Griffe integrali, serraggio concentrico, dotato di: 1 serie composta da 3 griffe per interni, 1 serie composta da 3 griffe per esterni e 1 serie composta da 3 griffe tenere e chiave di serraggio. Con copertura posteriore in metallo per Ø250 mm, Ø320 mm e Ø400 mm.

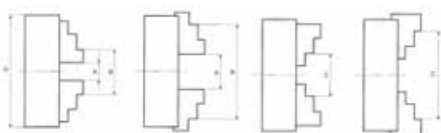
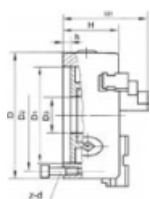

Scatola



Cassa di legno



Ghisa



Tornio

Art.	€	D1	D2	D3	H1	H	h	z-d	Quadro chiave	A - A1	B - B1	C - C1	Peso netto
M075A/080	€ 249,00	55 mm	66 mm	16 mm	66 mm	50 mm	4 mm	3-M6	8 mm	2 - 22 mm	25 - 70 mm	22 - 63 mm	1,9 kg
M075A/100	€ 274,00	72 mm	84 mm	22 mm	74,5 mm	55 mm	4 mm	3-M8	8 mm	2 - 30 mm	30 - 90 mm	30 - 80 mm	3,2 kg
M075A/125	€ 295,00	95 mm	108 mm	30 mm	84 mm	58 mm	4 mm	3-M8	10 mm	2,5 - 40 mm	38 - 125 mm	38 - 110 mm	5 kg
M075A/160	€ 380,00	130 mm	142 mm	45 mm	95 mm	65 mm	5 mm	3-M8	10 mm	3 - 55 mm	50 - 160 mm	55 - 145 mm	8,8 kg
M075A/200	€ 543,00	165 mm	180 mm	65 mm	109 mm	75 mm	6 mm	3-M10	12 mm	4 - 85 mm	65 - 200 mm	65 - 200 mm	15,5 kg
M075A/250	€ 660,00	206 mm	226 mm	80 mm	120 mm	80 mm	5 mm	3-M12	12 mm	6 - 110 mm	80 - 250 mm	90 - 250 mm	25,7 kg
M075A/320	€ 1120,00	270 mm	290 mm	100 mm	143,5 mm	95 mm	11 mm	3-M16	13 mm	11,5 - 145 mm	95 - 320 mm	110 - 320 mm	47,5 kg
M075A/400	€ 1690,00	340 mm	368 mm	145 mm	155 mm	101,5 mm	7 mm	3-M16	14 mm	15 - 210 mm	120 - 400 mm	120 - 400 mm	71 kg

M076A-
NEW
MANDRINO AUTOCENTRANTE DI PRECISIONE 4+4+4 GRIFFE

A guida singola. Griffe integrali, serraggio concentrico, dotato di: 1 serie composta da 4 griffe per interni, 1 serie composta da 4 griffe per esterni e 1 serie composta da 4 griffe tenere e chiave di serraggio.

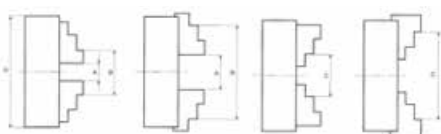
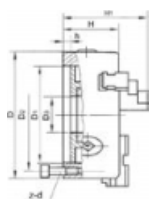

Scatola



Cassa di legno



Ghisa



Tornio

Art.	€	D1	D2	D3	H1	H	h	z-d	Quadro chiave	A - A1	B - B1	C - C1	Peso netto
M076A/080	€ 276,00	55 mm	66 mm	16 mm	66 mm	50 mm	4 mm	3-M6	8 mm	2 - 22 mm	25 - 70 mm	22 - 63 mm	2,1 kg
M076A/100	€ 290,00	72 mm	84 mm	22 mm	75 mm	55 mm	4 mm	3-M8	8 mm	2 - 30 mm	30 - 90 mm	30 - 80 mm	3,63 kg
M076A/125	€ 318,00	95 mm	108 mm	30 mm	84 mm	58 mm	4,5 mm	3-M8	10 mm	2,5 - 40 mm	38 - 125 mm	38 - 110 mm	5,9 kg
M076A/160	€ 420,00	130 mm	142 mm	45 mm	95 mm	65 mm	5 mm	3-M8	10 mm	3 - 55 mm	50 - 160 mm	55 - 145 mm	9,7 kg
M076A/200	€ 694,00	165 mm	180 mm	65 mm	113 mm	75 mm	6 mm	3-M10	12 mm	4 - 85 mm	65 - 200 mm	65 - 200 mm	20,3 kg
M076A/250	€ 890,00	206 mm	226 mm	80 mm	124 mm	80 mm	5 mm	3-M12	12 mm	6 - 110 mm	80 - 250 mm	90 - 250 mm	28,3 kg
M076A/320	€ 1480,00	270 mm	290 mm	100 mm	148,5 mm	95 mm	11 mm	3-M16	13 mm	11,5 - 145 mm	95 - 320 mm	110 - 320 mm	67 kg
M076A/400	€ 2130,00	340 mm	368 mm	145 mm	155 mm	101,5 mm	7 mm	3-M16	14 mm	15 - 210 mm	120 - 400 mm	120 - 400 mm	94 kg

M049A-
NEW
MANDRINO A 3+3 GRIFFE AUTOCENTRANTE DI PRECISIONE

A guida singola. Griffe integrali, serraggio concentrico, dotato di 1 serie composta da 3 griffe per interni, 1 serie composta da 3 griffe per esterni e chiave di serraggio. Copertura posteriore in metallo per i mandrini Ø250, Ø320 mm e Ø400 mm.

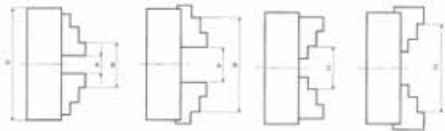
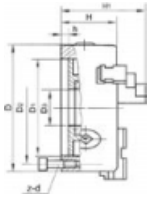

Art.	€	D1	D2	D3	H1	H	h	z-d	Quadro chiave	A - A1	B - B1	C - C1	Peso netto
M049A/080	€ 179,00	55 mm	66 mm	16 mm	66 mm	50 mm	4 mm	3-M6	8 mm	2 - 22 mm	25 - 70 mm	22 - 63 mm	1,71 kg
M049A/100	€ 189,00	72 mm	84 mm	22 mm	74,5 mm	55 mm	4 mm	3-M8	8 mm	2 - 30 mm	30 - 90 mm	30 - 80 mm	2,94 kg
M049A/125	€ 209,00	95 mm	108 mm	30 mm	84 mm	58 mm	5 mm	3-M8	10 mm	2,5 - 40 mm	38 - 125 mm	38 - 110 mm	4,74 kg
M049A/160	€ 279,00	130 mm	142 mm	45 mm	95 mm	65 mm	6 mm	3-M8	10 mm	3 - 55 mm	50 - 160 mm	55 - 145 mm	8,1 kg
M049A/200	€ 385,00	165 mm	180 mm	65 mm	114 mm	75 mm	6,5 mm	3-M10	12 mm	4 - 85 mm	65 - 200 mm	65 - 200 mm	14,42 kg
M049A/250	€ 449,00	206 mm	226 mm	80 mm	125 mm	80 mm	5 mm	3-M12	12 mm	6 - 110 mm	80 - 250 mm	90 - 250 mm	25,6 kg
M049A/320	€ 819,00	270 mm	290 mm	100 mm	143,5 mm	95 mm	11 mm	3-M16	13 mm	11,5 - 145 mm	95 - 320 mm	110 - 320 mm	47,4 kg
M049A/400	€ 1260,00	340 mm	368 mm	145 mm	155 mm	104 mm	6 mm	3-M16	14 mm	15 - 210 mm	120 - 400 mm	120 - 400 mm	78 kg

M449A-
NEW
MANDRINO A 4+4 GRIFFE AUTOCENTRANTE DI PRECISIONE

A guida singola. Griffe integrali, serraggio concentrico, dotato di 1 serie composta da 4 griffe per interni, 1 serie composta da 4 griffe per esterni e chiave di serraggio. Copertura posteriore in metallo per le misure Ø250 mm, Ø300 mm e Ø400 mm.

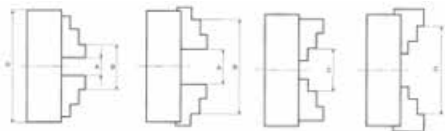
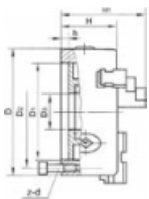

Art.	€	D1	D2	D3	H1	H	h	z-d	Quadro chiave	A - A1	B - B1	C - C1	Peso netto
M449A/080	€ 192,00	55 mm	66 mm	16 mm	66 mm	50 mm	4 mm	3-M6	8 mm	2 - 22 mm	25 - 70 mm	22 - 63 mm	1,8 kg
M449A/100	€ 202,00	72 mm	84 mm	22 mm	75 mm	55 mm	4 mm	3-M8	8 mm	2,5 - 30 mm	30 - 90 mm	30 - 80 mm	3,1 kg
M449A/125	€ 225,00	95 mm	108 mm	30 mm	84 mm	58 mm	4 mm	3-M8	10 mm	2,5 - 40 mm	38 - 125 mm	38 - 110 mm	4,9 kg
M449A/160	€ 315,00	130 mm	142 mm	45 mm	95 mm	65 mm	5 mm	3-M8	10 mm	3 - 55 mm	50 - 160 mm	55 - 145 mm	8,6 kg
M449A/200	€ 435,00	165 mm	180 mm	65 mm	113 mm	75 mm	6 mm	3-M10	12 mm	4 - 85 mm	65 - 200 mm	65 - 200 mm	15,3 kg
M449A/250	€ 575,00	206 mm	226 mm	80 mm	124 mm	80 mm	5 mm	3-M12	12 mm	6 - 110 mm	80 - 250 mm	90 - 250 mm	27,2 kg
M449A/320	€ 990,00	270 mm	290 mm	100 mm	148,5 mm	95 mm	11 mm	3-M16	13 mm	11,5 - 145 mm	95 - 320 mm	110 - 320 mm	52,3 kg
M449A/400	€ 1590,00	340 mm	368 mm	145 mm	155 mm	101,5 mm	7 mm	3-M16	14 mm	15 - 210 mm	120 - 400 mm	120 - 400 mm	78,1 kg



**M078A-****NEW****MANDRINO A 3+3 GRIFFE AUTOCENTRANTE DI PRECISIONE CAMLOCK**

A guida singola. Griffe integrali, serraggio concentrico, dotato di 1 serie composta da 3 griffe per interni, 1 serie composta da 3 griffe per esterni e chiave di serraggio.

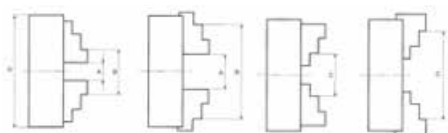
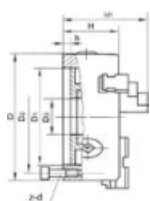

Scatola



Cassa di legno



Ghisa



Tornio



Art.	€	D1	D2	D3	H1	H	h	z-d	Quadro chiave	A - A1	B - B1	C - C1	Peso netto
M078A/160/D1-4	€ 313,00	63,513 mm	82,6 mm	40 mm	100,5 mm	71 mm	13 mm	3-M10	10 mm	3 - 55 mm	50 - 160 mm	55 - 145 mm	10,6 kg
M078A/200/D1-4	€ 440,00	63,513 mm	82,6 mm	50 mm	124 mm	86 mm	13 mm	3-M10	12 mm	4 - 85 mm	65 - 200 mm	65 - 200 mm	17 kg
M078A/200/D1-5	€ 440,00	82,563 mm	104,8 mm	50 mm	124 mm	86 mm	15 mm	6-M12	12 mm	4 - 85 mm	65 - 200 mm	65 - 200 mm	20,1 kg
M078A/250/D1-5	€ 567,00	82,563 mm	104,8 mm	70 mm	139 mm	95 mm	15 mm	6-M12	12 mm	6 - 110 mm	80 - 250 mm	90 - 250 mm	32 kg
M078A/250/D1-6	€ 567,00	106,375 mm	133,4 mm	80 mm	142 mm	98 mm	16 mm	6-M16	12 mm	6 - 110 mm	80 - 250 mm	90 - 250 mm	32 kg
M078A/250/D1-8	€ 567,00	139,719 mm	171,4 mm	80 mm	142 mm	98 mm	18 mm	6-M20	12 mm	6 - 110 mm	80 - 250 mm	90 - 250 mm	32 kg
M078A/320/D1-6	€ 1160,00	106,375 mm	133,4 mm	102 mm	158 mm	103,5 mm	16 mm	6-M16	13 mm	11,5-145mm	95-320mm	110-320mm	51 kg
M078A/320/D1-8	€ 1160,00	139,719 mm	171,4 mm	102 mm	158 mm	103,5 mm	18 mm	6-M20	13 mm	11,5-145mm	95-320mm	110-320mm	51 kg
M078A/400/D1-8	€ 1900,00	139,719 mm	171,4 mm	130 mm	173 mm	118 mm	18 mm	6-M20	14 mm	15-210mm	120-400mm	120-400mm	82 kg

M079A-**NEW****MANDRINO A 4+4 GRIFFE AUTOCENTRANTE DI PRECISIONE CAMLOCK**

A guida singola. Griffe integrali, serraggio concentrico, dotato di 1 serie composta da 4 griffe per interni, 1 serie composta da 4 griffe per esterni e chiave di serraggio.

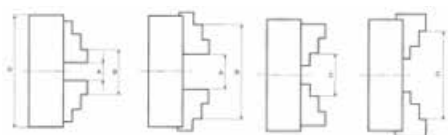
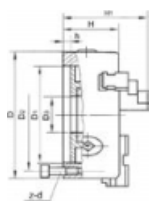

Scatola



Cassa di legno



Ghisa



Tornio



Art.	€	D1	D2	D3	H1	H	h	z-d	Quadro chiave	A - A1	B - B1	C - C1	Peso netto
M079A/160/D1-4	€ 365,00	63,513 mm	82,6 mm	40 mm	100,5 mm	71 mm	13 mm	3-M10	10 mm	3 - 55 mm	50 - 160 mm	55 - 145 mm	11 kg
M079A/200/D1-4	€ 501,00	63,513 mm	82,6 mm	50 mm	124 mm	86 mm	13 mm	3-M10	12 mm	4 - 85 mm	65 - 200 mm	65 - 200 mm	19 kg
M079A/200/D1-5	€ 501,00	82,563 mm	104,8 mm	50 mm	124 mm	86 mm	15 mm	6-M12	12 mm	4 - 85 mm	65 - 200 mm	65 - 200 mm	19 kg
M079A/250/D1-5	€ 630,00	82,563 mm	104,8 mm	70 mm	139 mm	95 mm	15 mm	6-M12	12 mm	6 - 110 mm	80 - 250 mm	90 - 250 mm	35 kg
M079A/250/D1-6	€ 630,00	106,375 mm	133,4 mm	80 mm	142 mm	98 mm	16 mm	6-M16	12 mm	6 - 110 mm	80 - 250 mm	90 - 250 mm	35 kg
M079A/250/D1-8	€ 630,00	139,719 mm	171,4 mm	80 mm	142 mm	98 mm	18 mm	6-M20	12 mm	6 - 110 mm	80 - 250 mm	90 - 250 mm	35 kg
M079A/320/D1-6	€ 1250,00	106,375 mm	133,4 mm	102 mm	158 mm	103,5 mm	16 mm	6-M16	13 mm	11,5-145mm	95-320mm	110-320mm	56 kg
M079A/320/D1-8	€ 1250,00	139,719 mm	171,4 mm	102 mm	158 mm	103,5 mm	18 mm	6-M20	13 mm	11,5-145mm	95-320mm	110-320mm	56 kg
M079A/400/D1-8	€ 2040,00	139,719 mm	171,4 mm	130 mm	173 mm	118 mm	18 mm	6-M20	14 mm	15-210mm	120-400mm	120-400mm	90 kg

M005A-
NEW
MANDRINO A 3 GRIFFE REVERSIBILI AUTOCENTRANTE DI PRECISIONE

A Guida singola, dotato serie 3 griffe dure interne - esterne reversibili, chiave di serraggio e viti fissaggio griffe. Copertura posteriore in plastica per la misura Ø200.

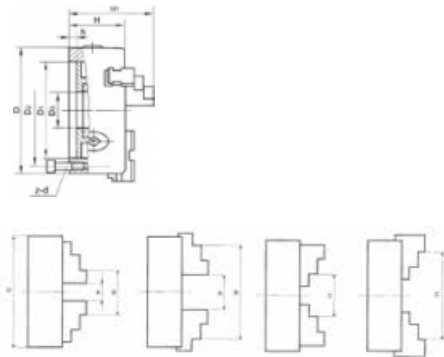

Art.	€	D1	D2	D3	H1	H	h	z-d	Quadro chiave	A - A1	B - B1	C - C1	Peso netto
M005A/200	€ 384,00	165 mm	180 mm	65 mm	122 mm	75 mm	5 mm	3-M10	12 mm	4 - 85 mm	65 - 200 mm	65 - 200 mm	14 kg
M005A/250	€ 449,00	206 mm	226 mm	80 mm	136 mm	80 mm	5 mm	3-M12	12 mm	6 - 110 mm	80 - 250 mm	90 - 250 mm	23,4 kg
M005A/320	€ 725,00	270 mm	290 mm	100 mm	153,5 mm	95 mm	11 mm	3-M16	13 mm	11,5 - 145 mm	95 - 320 mm	110 - 320 mm	42,4 kg
M005A/400	€ 1170,00	340 mm	368 mm	145 mm	175 mm	101,5 mm	7 mm	3-M16	14 mm	15 - 210 mm	120 - 400 mm	120 - 400 mm	71 kg
M005A/500	€ 1990,00	440 mm	465 mm	210 mm	197 mm	115 mm	7 mm	6-M16	17 mm	25 - 280 mm	150 - 500 mm	150 - 500 mm	119 kg
M005A/630	€ 5590,00	560 mm	595 mm	280 mm	218 mm	135 mm	8 mm	6-M16	19 mm	50 - 350 mm	170 - 630 mm	170 - 630 mm	208 kg

P444A-
NEW
PIATTAFORMA A 4 GRIFFE INDIPENDENTI

Con comando a vite, attacco a flangia, griffe a guida semplice reversibili per presa interna ed esterna. Dotato di chiave per griffe e viti di fissaggio.

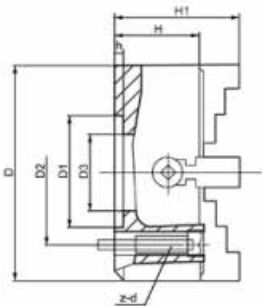

Art.	€	D	D1	D2	D3	H1	H	h	z-d	Quadro chiave	Peso netto
P444A/125	€ 192,00	125 mm	95 mm	108 mm	30 mm	78 mm	56 mm	6 mm	4-M8	7 mm	4,8kg
P444A/160	€ 244,00	160 mm	65 mm	95 mm	55 mm	103 mm	75 mm	5 mm	4-M10	10 mm	10 kg
P444A/200	€ 322,00	200 mm	80 mm	112 mm	70 mm	119 mm	80 mm	6 mm	4-M10	10 mm	14,5 kg
P444A/250	€ 410,00	250 mm	110 mm	130 mm	100 mm	131 mm	90 mm	6 mm	4-M12	12 mm	23 kg
P444A/320	€ 689,00	320 mm	140 mm	165 mm	115 mm	152 mm	102 mm	16 mm	4-M16	14 mm	43 kg
P444A/400	€ 919,00	400 mm	160 mm	185 mm	125 mm	157 mm	110 mm	13 mm	4-M16	14 mm	71 kg

M049A-xST
NEW
SERIE 3 GRIFFE TENERE INTEGRALI

Per mandrini autocentranti a guida semplice.



Art.	€	Mandrino
M049A/080ST	€ 83,00	Ø 80 mm
M049A/100ST	€ 88,00	Ø 100 mm
M049A/125ST	€ 99,00	Ø 125 mm
M049A/160ST	€ 110,00	Ø 160 mm

M049A-xGBD
NEW
SERIE 3 GRIFFE TENERE CON BASI DURE

Con base in acciaio temprato, per mandrino autocentrante a guida semplice.



Art.	€	Mandrino
M049A/200GBD	€ 187,00	Ø 200 mm
M049A/250GBD	€ 247,00	Ø 250 mm
M049A/320GBD	€ 385,00	Ø 320 mm
M049A/400GBD	€ 485,00	Ø 400 mm

M449A-xST
NEW
SERIE 4 GRIFFE TENERE INTEGRALI

Per mandrini autocentranti a guida semplice.



Art.	€	Mandrino
M449A/080ST	€ 98,00	Ø 80 mm
M449A/100ST	€ 106,00	Ø 100 mm
M449A/125ST	€ 119,00	Ø 125 mm
M449A/160ST	€ 139,00	Ø 160 mm

M449A-xGBD
NEW
SERIE 4 GRIFFE TENERE CON BASI DURE

Con base in acciaio temprato, per mandrino autocentrante a guida semplice.



Art.	€	Mandrino
M449A/200GBD	€ 286,00	Ø 200 mm
M449A/250GBD	€ 350,00	Ø 250 mm
M449A/320GBD	€ 590,00	Ø 320 mm
M449A/400GBD	€ 710,00	Ø 400 mm

2622x
MORSETTO TENERO PER MANDRINI

Applicabile su griffe dure.



Art.	€	Ø	Interasse fori
M075/160T	€ 27,30	160 mm	38,1 mm
M075/200T	€ 30,20	200 mm	44,50 mm
M075/250T	€ 32,60	250 mm	54 mm
M075/315T	€ 40,80	315 mm	63,5 mm
262206R	€ 83,00	400 mm	76,2 mm
262207R	€ 115,00	500 - 630 mm	76,2 mm

FD0x-
NEW
FLANGIA CON PERNI

Camlock DIN 55029 a cono corto con lato mandrino grezzo.



Art.	€	Cam lock Tipo	Misura	Spessore	Perni
FD04/125	€ 120,00	4"	Ø 125 mm	26 mm	Ø 15,9 mm
FD04/160	€ 167,00	4"	Ø 160 mm	26 mm	Ø 15,9 mm
FD04/200	€ 215,00	4"	Ø 200 mm	28 mm	Ø 15,9 mm
FD05/200	€ 215,00	5"	Ø 200 mm	30 mm	Ø 19 mm
FD05/250	€ 295,00	5"	Ø 250 mm	30 mm	Ø 19 mm
FD06/250	€ 302,00	6"	Ø 250 mm	30 mm	Ø 22 mm
FD06/380	€ 402,00	6"	Ø 400 mm	30 mm	Ø 22 mm
FD08/250	€ 305,00	8"	Ø 250 mm	30 mm	Ø 25,4 mm
FD08/320	€ 350,00	8"	Ø 320 mm	30 mm	Ø 25,4 mm
FD08/380	€ 533,00	8"	Ø 400 mm	30 mm	Ø 25,4 mm
FD08/500	€ 613,00	8"	Ø 500 mm	36 mm	Ø 25,4 mm
FD11/320	€ 371,00	11"	Ø 320 mm	45 mm	Ø 30,0 mm
FD11/400	€ 510,00	11"	Ø 400 mm	30 mm	Ø 30,0 mm
FD11/500	€ 653,00	11"	Ø 500 mm	36 mm	Ø 30 mm

0563-
CHIAVE PER MANDRINO

Per mandrini, con molla di sicurezza.



Art.	€	Quadro chiave	Dimensioni
0563/08	€ 13,10	8 mm	61 x 120 mm
0563/10	€ 16,60	10 mm	120 x 210 mm
0563/12	€ 19,50	12 mm	155 x 300 mm
0563/13	€ 22,10	13 mm	120 x 300 mm
0563/14	€ 25,60	14 mm	130 x 350 mm
0563/17	€ 29,10	17 mm	130 x 400 mm
0563/19	€ 32,60	19 mm	200 x 500 mm

0751/A4

€ 134,00

MANDRINO PER TORNIO



Scatola Acciaio

Autocentrante 4 griffe reversibili

Ø 125 mm

Filetto

1" - 8 TPI

Foro

Ø 22 mm

0751/P

€ 71,70

MANDRINO PER TORNIO



Scatola Acciaio

4 griffe reversibili indipendenti

Ø 150 mm

Filetto

1" - 8 TPI

Foro

Ø 22 mm

0425-

MANDRINO AUTOCENTRANTE A 4 GRIFFE

Per tornio da legno



Scatola Acciaio

Art.	€	Ø	Capacità di serraggio	Filetto
0425/100	€ 210,00	95 mm	Int. 32 - 45 mm - Ext. 68 - 85 mm	1" - 8 TPI
0425/125	€ 238,00	125 mm	Int. 50 - 70 mm - Ext. 85 - 110 mm	1" - 8 TPI e M33 x 3,5



M051-
MANDRINO AUTOSERRANTE DI PRECISIONE

Per uso industriale, anche nelle più severe condizioni di utilizzo. Parti di scorrimento interamente temprate e rettificate. Durezza griffe mandrino HRC58.

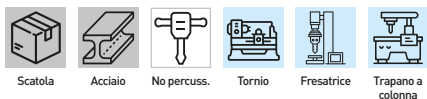

Art.	€	Capacità	Attacco DIN	Dimensioni
M051/08	€ 60,80	0,5 ÷ 8 mm	B 12	Ø 39 x 80 mm
M051/10	€ 60,80	1 ÷ 10 mm	B 12	Ø 44.5 x 82 mm
M051/13	€ 71,40	1 ÷ 13 mm	B 16	Ø 49.5 x 91 mm
M051/16	€ 86,10	1 ÷ 16 mm	B 18	Ø 54 x 102.5 mm
M051/20	€ 111,00	1 ÷ 20 mm	B 22	Ø 59 x 119 mm

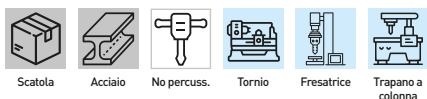
M042-
MANDRINO AUTOSERRANTE PROFESSIONALE

Art.	€	Capacità	Attacco DIN	Dimensioni
M042/08	€ 51,10	0.5 ÷ 8 mm	B12	Ø 36 x 71 mm
M042/10	€ 52,30	1 ÷ 10 mm	B12	Ø 39 x 80 mm
M042/13	€ 59,90	1 ÷ 13 mm	B16	Ø 41 x 87 mm
M042/16	€ 72,10	3 ÷ 16 mm	B18	Ø 49 x 98 mm
M042/20	€ 96,00	5 ÷ 20 mm	B22	Ø 53 x 106 mm

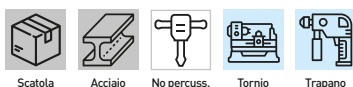
M052-
MANDRINO CON SERRAGGIO A CREMAGLIERA

Art.	€	Capacità	Attacco DIN	Dimensioni
M052/10	€ 16,10	1 ÷ 10 mm	B12	Ø 43 x 57 mm
M052/13	€ 21,20	1 ÷ 13 mm	B16	Ø 53 x 65 mm
M052/16	€ 25,40	3 ÷ 16 mm	B18	Ø 53 x 74 mm
M052/20	€ 38,40	5 ÷ 20 mm	B22	Ø 64 x 83 mm

M080/13
€ 20,90
MANDRINO AUTOSERRANTE CON GHIERA DI BLOCCAGGIO

Per l'utilizzo a doppia rotazione e percussione. Chiusura rapida senza chiave con bloccaggio radiale, mediante rotazione del corpo mandrino. Corpo rivestito in materiale sintetico e parti operanti in acciaio. Con vite di fissaggio sinistra.

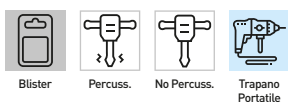

Capacità	Attacco
2 ÷ 13 mm	1/20 UNF

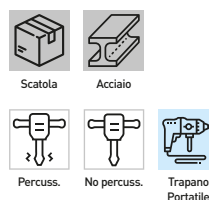
M081-
MANDRINO CON SERRAGGIO A CREMAGLIERA

Art.	€	Capacità	Attacco
M081/13	€ 11,10	1÷13 mm	1/2" 20 UNF
M081/13A	€ 11,10	1÷13 mm	3/8" 24 UNF

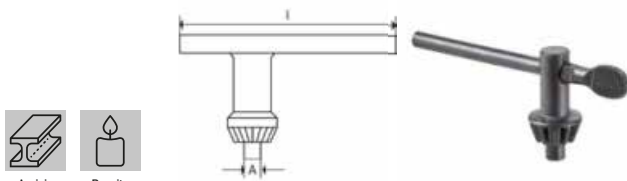

0711-
CHIAVE SERRAGGIO MANDRINO A CREMAGLIERA

Art.	€	L	A
0711/06	€ 1,51	56 mm	5 mm
0711/10	€ 1,74	56 mm	5 mm
0711/13	€ 2,15	80 mm	6 mm
0711/16	€ 2,56	90 mm	7 mm
0711/20	€ 4,07	120 mm	8 mm

1-xB
NEW
MANDRINO PORTA PUNTE

 DIN 2080. Corpo mandrino bilanciato, con asola di estrazione per utensili.
 Equilibratura 12.000 rpm.

Art.	€	ISO	CM	D	L
1/1B40	€ 100,00	40	1	25 mm	50 mm
1/2B40	€ 100,00	40	2	32 mm	50 mm
1/3B40	€ 100,00	40	3	40 mm	65 mm
1/4B40	€ 109,00	40	4	48 mm	95 mm
1/1B50	€ 161,00	50	1	25 mm	45 mm
1/2B50	€ 161,00	50	2	32 mm	60 mm
1/3B50	€ 161,00	50	3	40 mm	65 mm
1/4B50	€ 180,00	50	4	48 mm	70 mm
1/5B50	€ 216,00	50	5	63 mm	100 mm

1-xA
MANDRINO PORTA PUNTE

 DIN 69871/A, corpo mandrino bilanciato, con asola di estrazione per utensili.
 Equilibratura 12.000 rpm.

Art.	€	ISO	CM	D	L
1/1A40	€ 105,00	40	1	25 mm	45 mm
1/2A40	€ 105,00	40	2	32 mm	60 mm
1/3A40	€ 105,00	40	3	40 mm	75 mm
1/4A40	€ 105,00	40	4	50 mm	98 mm
1/2A50	€ 211,00	50	2	32 mm	40 mm
1/3A50	€ 211,00	50	3	40 mm	50 mm
1/4A50	€ 211,00	50	4	48 mm	95 mm
1/5A50	€ 211,00	50	5	63 mm	110 mm

1-xD
MANDRINO PORTA PUNTE

 MAS-403 BT, corpo mandrino bilanciato, con asola di estrazione per utensili.
 Equilibratura 12.000 rpm.

Art.	€	BT	CM	D	L
1/1D40	€ 149,00	40	1	25 mm	45 mm
1/2D40	€ 149,00	40	2	32 mm	60 mm
1/3D40	€ 149,00	40	3	40 mm	75 mm
1/4D40	€ 149,00	40	4	50 mm	98 mm
1/2D50	€ 154,00	50	2	32 mm	40 mm
1/3D50	€ 154,00	50	3	40 mm	75 mm
1/4D50	€ 171,00	50	4	50 mm	80 mm
1/5D50	€ 202,00	50	5	63 mm	110 mm

ST45-xL
RIDUZIONE PROLUNGATA CONO MORSE

Per il montaggio di utensili con gambo conico morse.

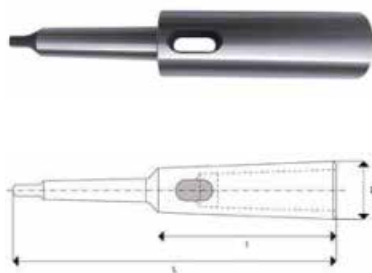

Art.	€	CM Esterno	CM Interno	L	l	D
ST45/2/1L	€ 19,50	2	1	160 mm	85 mm	20 mm
ST45/2/2L	€ 23,80	2	2	175 mm	90 mm	30 mm
ST45/2/3L	€ 27,10	2	3	196 mm	121 mm	36 mm
ST45/3/1L	€ 25,60	3	1	175 mm	81 mm	20 mm
ST45/3/2L	€ 27,10	3	2	194 mm	100 mm	30 mm
ST45/3/3L	€ 38,10	3	3	215 mm	121 mm	36 mm
ST45/3/4L	€ 48,80	3	4	240 mm	146 mm	48 mm
ST45/4/1L	€ 39,60	4	1	200 mm	82,5 mm	20 mm
ST45/4/2L	€ 40,80	4	2	215 mm	97,5 mm	30 mm
ST45/4/3L	€ 49,40	4	3	240 mm	122,5 mm	36 mm
ST45/4/4L	€ 54,90	4	4	265 mm	147,5 mm	48 mm
ST45/4/5L	€ 78,70	4	5	300 mm	182,5 mm	63 mm
ST45/5/1L	€ 64,10	5	1	232 mm	82,5 mm	20 mm
ST45/5/2L	€ 65,20	5	2	247 mm	97,5 mm	30 mm
ST45/5/3L	€ 65,20	5	3	268 mm	118,5 mm	36 mm
ST45/5/4L	€ 73,80	5	4	300 mm	150,5 mm	48 mm
ST45/5/5L	€ 108,00	5	5	335 mm	185,5 mm	63 mm
ST45/5/6L	€ 185,00	5	6	396 mm	247 mm	82 mm

A001-
ATTACCO PER MANDRINO

Per mandrini con attacco conico.



Art.	€	CM	Attacco DIN
A001/2/12	€ 9,90	2	B12
A001/2/16	€ 11,20	2	B16
A001/2/18	€ 11,60	2	B18
A001/3/12	€ 17,30	3	B12
A001/3/16	€ 17,30	3	B16
A001/3/18	€ 17,30	3	B18
A001/3/22	€ 17,30	3	B22
A001/4/16	€ 20,90	4	B16
A001/4/18	€ 20,90	4	B18
A001/4/22	€ 20,90	4	B22

ST45-
BUSSOLA DI RIDUZIONE

Per il montaggio di utensili con gambo conico morse.



Art.	€	CM Esterno	CM Interno
ST45/2/1	€ 12,40	2	1
ST45/3/1	€ 15,10	3	1
ST45/3/2	€ 16,10	3	2
ST45/4/1	€ 20,90	4	1
ST45/4/2	€ 20,90	4	2
ST45/4/3	€ 20,90	4	3
ST45/5/3	€ 33,30	5	3
ST45/5/4	€ 33,30	5	4

E002-
ESTRATTORI PER CONO MORSE

Per estrazione coni.



Art.	€	CM
E002/12	€ 8,60	1-2
E002/3	€ 8,60	3
E002/4	€ 12,40	4

3-CM

PORTA PINZA

DIN 228/A, per il montaggio di utensili con gambo cilindrico su pinze DIN 6499 (ER).
Fornito con ghiera di serraggio.

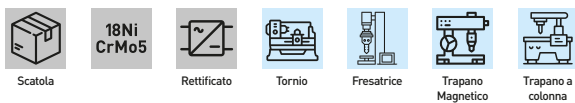

Art.	€	Pinze	D	L	L1	F	A
3/CM2	€ 96,50	ER 32	50 mm	135 mm	60 mm	M 10	3 / 20 mm
3/CM3	€ 96,50	ER 32	50 mm	146 mm	60 mm	M 12	3 / 20 mm
3/CM4	€ 108,00	ER 32	50 mm	166 mm	58 mm	M 16	3 / 20 mm

3/B/40

€ 112,00

PORTA PINZA

DIN 2080, per il montaggio di utensili con gambo cilindrico su pinze DIN 6499 (ER).
Fornito con ghiera di serraggio.

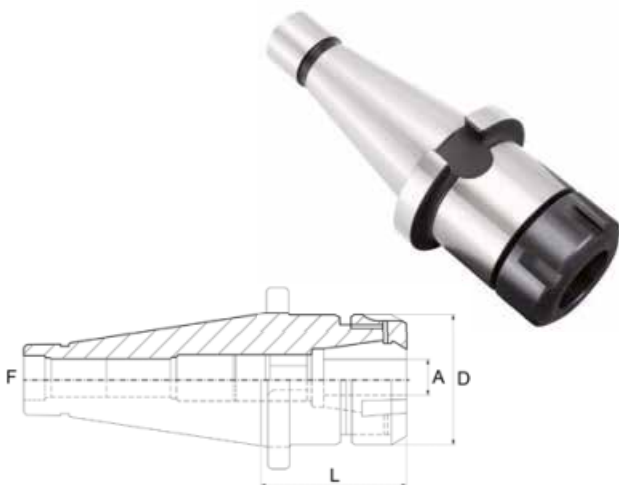

Pinze	ER 32
A	3/20 mm
D	50 mm
L	65 mm
F	M 16
Equilibratura rpm	2000

3A40-

PORTA PINZA

DIN 69871/A, per il montaggio di utensili con gambo cilindrico su pinze DIN 6499 (ER).
Fornito con ghiera di serraggio. Equilibratura 12.000 rpm.



Art.	€	Pinze	A	D	L	F
3A40/16	€ 77,10	ER 16	1 / 10 mm	28 mm	100 mm	M 16
3A40/20	€ 77,10	ER 20	2 / 13 mm	34 mm	100 mm	M 16
3A40/25	€ 77,10	ER 25	2 / 16 mm	42 mm	100 mm	M 16
3/A/40	€ 122,00	ER 32	3/20 mm	50 mm	72 mm	M 16

3D40-

PORTA PINZA

MAS-403 BT, per il montaggio di utensili con gambo cilindrico su pinze DIN 6499 (ER).
Fornito con ghiera di serraggio. Equilibratura 12.000 rpm.

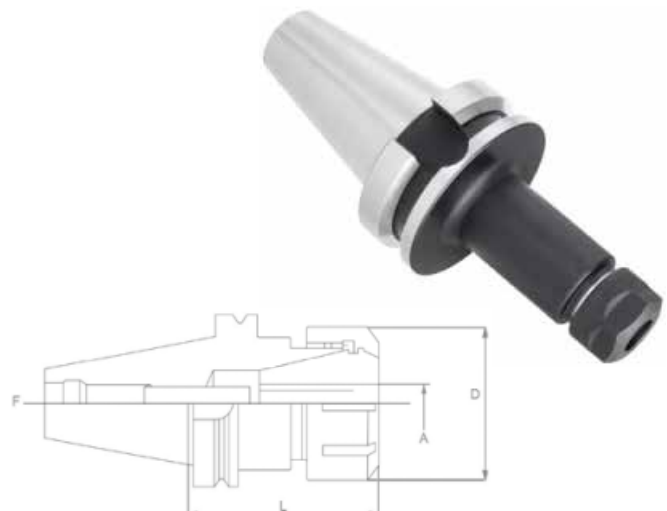

Art.	€	Pinze	A	D	L	F
3D40/16	€ 77,10	ER 16	1 / 10 mm	28 mm	100 mm	M 16
3D40/20	€ 77,10	ER 20	2 / 13 mm	34 mm	100 mm	M 16
3D40/25	€ 77,10	ER 25	2 / 16 mm	42 mm	100 mm	M 16
3/D/40	€ 122,00	ER 32	3/20 mm	50 mm	63 mm	M 16

PR16/10P
€ 95,10
SERIE PINZE

ER16 DIN 6499/B, utilizzabili con mandrini portapinze.

Misure Ø 1-2-3-4-5-6-7-8-9-10 mm

PR20/12P
€ 106,00
SERIE PINZE

ER20 DIN 6499/B, utilizzabili con mandrini portapinze.

Misure Ø 2-3-4-5-6-7-8-9-10-11-12-13 mm

PR25/15P
€ 139,00
SERIE PINZE

ER25 DIN 6499/B, utilizzabili con mandrini portapinze.

Misure Ø 2-3-4-5-6-7-8-9-10-11-12-13-14-15-16 mm

P032/7P
€ 128,00
SERIE PINZE

ER32 DIN 6499/B, utilizzabili con mandrini portapinze.



Misure 4-6-8-10-12-16-20 mm

P032-
PINZA

ER32 DIN 6499/B utilizzabile con mandrini portapinze.

P032/18P
€ 269,00
SERIE PINZE

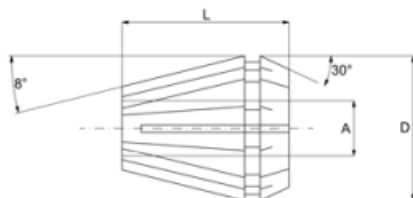
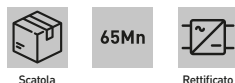
ER32 DIN 6499/B, utilizzabili con mandrini portapinze.

Misure 3-4-5-6-7-8-9-10-11-12-13-14-15-16-17-18-19-20 mm

Art.	€	Capacità A	D	L
P032/03	€ 15,70	2-3 mm	33 mm	40 mm
P032/04	€ 15,70	3-4 mm	33 mm	40 mm
P032/05	€ 15,70	4-5 mm	33 mm	40 mm
P032/06	€ 15,70	5-6 mm	33 mm	40 mm
P032/07	€ 15,70	6-7 mm	33 mm	40 mm
P032/08	€ 15,70	7-8 mm	33 mm	40 mm
P032/09	€ 15,70	8-9 mm	33 mm	40 mm
P032/10	€ 15,70	9-10 mm	33 mm	40 mm
P032/11	€ 15,70	10-11 mm	33 mm	40 mm
P032/12	€ 15,70	11-12 mm	33 mm	40 mm
P032/13	€ 15,70	12-13 mm	33 mm	40 mm
P032/14	€ 15,70	13-14 mm	33 mm	40 mm
P032/15	€ 15,70	14-15 mm	33 mm	40 mm
P032/16	€ 15,70	15-16 mm	33 mm	40 mm
P032/17	€ 15,70	16-17 mm	33 mm	40 mm
P032/18	€ 15,70	17-18 mm	33 mm	40 mm
P032/19	€ 15,70	18-19 mm	33 mm	40 mm
P032/20	€ 15,70	19-20 mm	33 mm	40 mm

G0x
GHIERA DI RICAMBIO

ER DIN 6499.



Art.	€	Pinza
G016	€ 10,30	ER16
G020	€ 11,30	ER20
G025	€ 15,50	ER25
G032	€ 38,80	ER32

CHERx
CHIAVE PER GHIERE

ER DIN 6499.



Art.	€
CHER25	€ 16,60
CHER32	€ 21,10



16-CM
MANDRINO CONO MORSE COMBINATO

DIN 228/A per frese cilindriche frontali secondo norma DIN 481, per frese con scanalatura longitudinale DIN 1880 e per frese ad inserti DIN 1830. Fornito con vite a croce, anello di trascinamento e chiavetta.

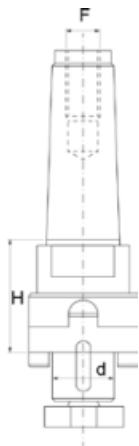

Art.	€	d - h6	CM	F	H
16/CM3	€ 102,00	16 mm	3	M 12	40 mm
16/CM4	€ 102,00	16 mm	4	M 16	55 mm
22/CM3	€ 102,00	22 mm	3	M 12	50 mm
22/CM4	€ 102,00	22 mm	4	M 16	55 mm
27/CM3	€ 102,00	27 mm	3	M 12	50 mm
27/CM4	€ 102,00	27 mm	4	M 16	55 mm

16Ax
MANDRINO PORTA FRESE COMBINATO

DIN 69871/A, corpo mandrino bilanciato, per frese cilindriche frontali secondo norma DIN 481, per frese con scanalatura longitudinale DIN 1880 e per frese ad inserti DIN 1830. Fornito con vite a croce, anello di trascinamento e chiavetta. Equilibratura 12.000 rpm.

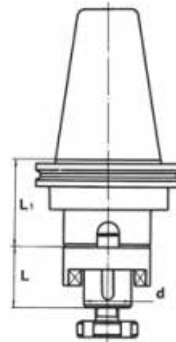

Art.	€	ISO	d-h6	L	L1	Equilibratura rpm
16A40	€ 119,00	40	16 mm	27 mm	35 mm	12000
22A40	€ 119,00	40	22 mm	31 mm	41 mm	12000
27A40	€ 119,00	40	27 mm	33 mm	41 mm	12000
32A40	€ 132,00	40	32 mm	38 mm	45 mm	12000
16A50	€ 165,00	50	16 mm	27 mm	35 mm	12000
22A50	€ 165,00	50	22 mm	31 mm	35 mm	12000
27A50	€ 165,00	50	27 mm	33 mm	35 mm	12000
32A50	€ 176,00	50	32 mm	38 mm	40 mm	12000
40A50	€ 192,00	50	40 mm	41 mm	40 mm	12000

16-B
MANDRINO PORTA FRESE COMBINATO

DIN 2080, corpo mandrino bilanciato, per frese cilindriche frontali secondo norma DIN 481, per frese con scanalatura longitudinale DIN 1880 e per frese ad inserti DIN 1830. Fornito con vite a croce, anello di trascinamento e chiavetta. Equilibratura 2.000 rpm.

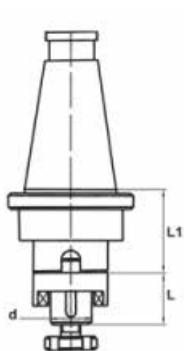

Art.	€	ISO	d - h6	L	L1
16/B40	€ 131,00	40	16 mm	27 mm	35 mm
22/B40	€ 131,00	40	22 mm	31 mm	39 mm
27/B40	€ 131,00	40	27 mm	33 mm	40 mm
32/B40	€ 131,00	40	32 mm	38 mm	40 mm
16/B50	€ 158,00	50	16 mm	27 mm	35 mm
22/B50	€ 158,00	50	22 mm	31 mm	35 mm
27/B50	€ 158,00	50	27 mm	33 mm	35 mm
32/B50	€ 169,00	50	32 mm	38 mm	40 mm
40/B50	€ 182,00	50	40 mm	41 mm	40 mm

16-D
MANDRINO PORTA FRESE COMBINATO

MAS-403 BT, corpo mandrino bilanciato, per frese cilindriche frontali secondo norma DIN 481, per frese con scanalatura longitudinale DIN 1880 e per frese ad inserti DIN 1830. Fornito con vite a croce, anello di trascinamento e chiavetta. Equilibratura 12.000 rpm.

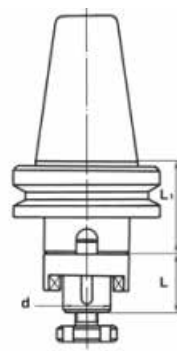

Art.	€	BT	d - h6	L	L1
16/D40	€ 119,00	40	16 mm	27 mm	35 mm
22/D40	€ 119,00	40	22 mm	31 mm	35 mm
27/D40	€ 119,00	40	27 mm	33 mm	35 mm
32/D40	€ 132,00	40	32 mm	38 mm	40 mm
16/D50	€ 166,00	50	16 mm	27 mm	35 mm
22/D50	€ 166,00	50	22 mm	31 mm	35 mm
27/D50	€ 177,00	50	27 mm	33 mm	35 mm
32/D50	€ 177,00	50	32 mm	38 mm	40 mm
40/D50	€ 189,00	50	40 mm	41 mm	40 mm

M004-
MANDRINO CON LUBRIFICAZIONE INTERNA PER FRESE A CAROTARE AD ATTACCO WELDON

Con sistema per la lubrificazione della fresa dall'interno durante la foratura.

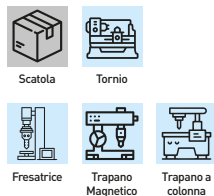

Art.	€	CM	Lunghezza totale	Attacco femmina
M004/2	€ 194,00	2	170,5 mm	Weldom 19,05 mm
M004/3	€ 194,00	3	190,5 mm	Weldom 19,05 mm

4-
MANDRINO PORTA FRESE TIPO WELDON

DIN 69871/A, corpo mandrino bilanciato, per frese (Weldon) secondo norma DIN 1835 B e DIN 6535 HB. Fornito con vite di serraggio. Equilibratura 12.000 rpm.

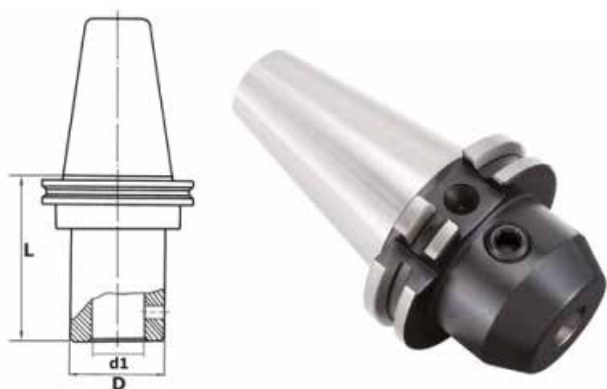

Art.	€	ISO	d1 - h6	D	L
4/06A40	€ 96,50	40	6 mm	25 mm	60 mm
4/08A40	€ 96,50	40	8 mm	28 mm	60 mm
4/10A40	€ 96,50	40	10 mm	35 mm	50 mm
4/12A40	€ 96,50	40	12 mm	42 mm	60 mm
4/14A40	€ 96,50	40	14 mm	42 mm	70 mm
4/16A40	€ 96,50	40	16 mm	48 mm	70 mm
4/18A40	€ 96,50	40	18 mm	48 mm	70 mm
4/20A40	€ 96,50	40	20 mm	52 mm	63 mm
4/25A40	€ 96,50	40	25 mm	40 mm	100 mm
4/32A40	€ 96,50	40	32 mm	72 mm	100 mm
4/06A50	€ 133,00	50	6 mm	25 mm	65 mm
4/08A50	€ 133,00	50	8 mm	28 mm	65 mm
4/10A50	€ 133,00	50	10 mm	35 mm	70 mm
4/12A50	€ 133,00	50	12 mm	42 mm	75 mm
4/14A50	€ 133,00	50	14 mm	42 mm	75 mm
4/16A50	€ 133,00	50	16 mm	48 mm	80 mm
4/18A50	€ 133,00	50	18 mm	48 mm	80 mm
4/20A50	€ 133,00	50	20 mm	52 mm	80 mm
4/25A50	€ 140,00	50	25 mm	65 mm	100 mm
4/32A50	€ 140,00	50	32 mm	72 mm	105 mm
4/40A50	€ 153,00	50	40 mm	80 mm	120 mm

4-xB
MANDRINO PORTAFRESE TIPO WELDON

DIN 2080, corpo mandrino bilanciato, per frese (Weldon) secondo norma DIN 1835 B e DIN 6535 HB. Fornito con vite di serraggio. Equilibratura 2.000 rpm.

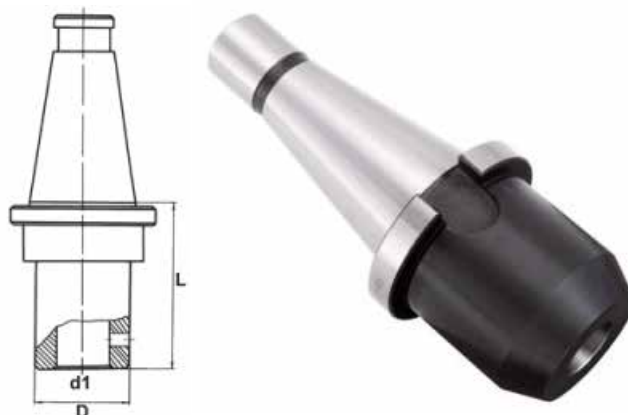

Art.	€	ISO	d1 - h6	D	L
4/06B40	€ 129,00	40	6 mm	25 mm	50 mm
4/08B40	€ 129,00	40	8 mm	28 mm	50 mm
4/10B40	€ 129,00	40	10 mm	35 mm	50 mm
4/12B40	€ 129,00	40	12 mm	42 mm	50 mm
4/16B40	€ 129,00	40	16 mm	48 mm	63 mm
4/18B40	€ 129,00	40	18 mm	48 mm	50 mm
4/20B40	€ 129,00	40	20 mm	52 mm	63 mm
4/25B40	€ 129,00	40	25 mm	65 mm	100 mm
4/32B40	€ 129,00	40	32 mm	72 mm	80 mm
4/06B50	€ 140,00	50	6 mm	25 mm	50 mm
4/08B50	€ 140,00	50	8 mm	28 mm	50 mm
4/10B50	€ 140,00	50	10 mm	35 mm	50 mm
4/12B50	€ 140,00	50	12 mm	42 mm	50 mm
4/16B50	€ 140,00	50	16 mm	48 mm	50 mm
4/20B50	€ 154,00	50	20 mm	52 mm	63 mm
4/25B50	€ 154,00	50	25 mm	65 mm	80 mm
4/32B50	€ 154,00	50	32 mm	72 mm	80 mm
4/40B50	€ 166,00	50	40 mm	90 mm	90 mm

4-xD
MANDRINO PORTA FRESE TIPO WELDON

MAS-403 BT, corpo mandrino bilanciato, per frese (Weldon) secondo norma DIN 1835 B e DIN 6535 HB. Fornito con vite di serraggio. Equilibratura 12.000 rpm.

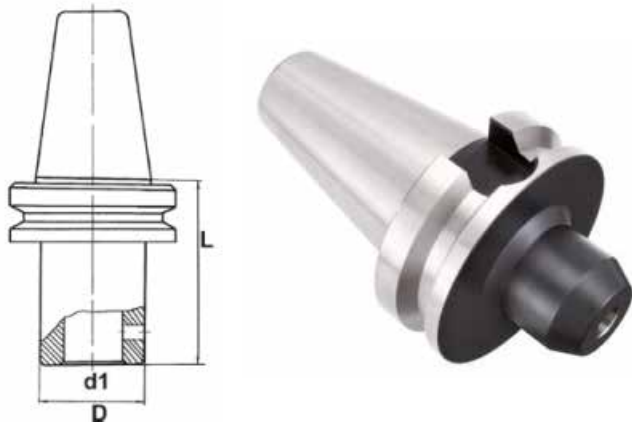

Art.	€	BT	d1 - h6	D	L
4/06D40	€ 105,00	40	6 mm	25 mm	60 mm
4/08D40	€ 105,00	40	8 mm	28 mm	60 mm
4/10D40	€ 105,00	40	10 mm	35 mm	60 mm
4/12D40	€ 105,00	40	12 mm	42 mm	70 mm
4/14D40	€ 105,00	40	14 mm	42 mm	70 mm
4/16D40	€ 105,00	40	16 mm	48 mm	70 mm
4/18D40	€ 105,00	40	18 mm	48 mm	70 mm
4/20D40	€ 105,00	40	20 mm	52 mm	75 mm
4/25D40	€ 105,00	40	25 mm	63 mm	100 mm
4/32D40	€ 105,00	40	32 mm	72 mm	100 mm
4/06D50	€ 138,00	50	6 mm	25 mm	65 mm
4/08D50	€ 138,00	50	8 mm	28 mm	65 mm
4/10D50	€ 138,00	50	10 mm	35 mm	70 mm
4/12D50	€ 138,00	50	12 mm	42 mm	75 mm
4/14D50	€ 138,00	50	14 mm	42 mm	75 mm
4/16D50	€ 138,00	50	16 mm	48 mm	80 mm
4/18D50	€ 138,00	50	18 mm	48 mm	80 mm
4/20D50	€ 138,00	50	20 mm	52 mm	80 mm
4/25D50	€ 154,00	50	25 mm	65 mm	100 mm
4/32D50	€ 154,00	50	32 mm	72 mm	105 mm
4/40D50	€ 154,00	50	40 mm	80 mm	120 mm

2-xA
MANDRINO PORTA FRESE A GAMBO CONICO

DIN 69871/A, corpo mandrino bilanciato. Equilibratura 12.000 rpm.



Art.	€	ISO	CM	D	L
2/1A40	€ 133,00	40	1	25 mm	45 mm
2/2A40	€ 133,00	40	2	32 mm	60 mm
2/3A40	€ 133,00	40	3	40 mm	75 mm
2/4A40	€ 133,00	40	4	50 mm	98 mm
2/2A50	€ 165,00	50	2	32 mm	40 mm
2/3A50	€ 165,00	50	3	40 mm	50 mm
2/4A50	€ 187,00	50	4	50 mm	80 mm
2/5A50	€ 221,00	50	5	63 mm	110 mm

2-xB
MANDRINO PORTA FRESE A GAMBO CONICO

DIN 2080, corpo mandrino bilanciato. Equilibratura 2.000 rpm.

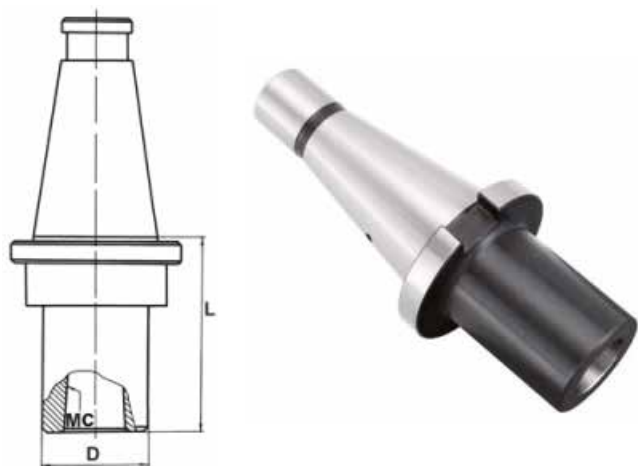

Art.	€	ISO	CM	D	L
2/1B40	€ 127,00	40	1	25 mm	15 mm
2/2B40	€ 127,00	40	2	32 mm	30 mm
2/3B40	€ 127,00	40	3	40 mm	64 mm
2/4B40	€ 142,00	40	4	50 mm	94 mm
2/2B50	€ 171,00	50	2	32 mm	20 mm
2/3B50	€ 171,00	50	3	40 mm	30 mm
2/4B50	€ 187,00	50	4	50 mm	65 mm
2/5B50	€ 203,00	50	5	63 mm	105 mm

**2-xD****MANDRINO PORTA FRESA A GAMBO CONICO**

MAS-403 BT, corpo mandrino bilanciato. Equilibratura 12.000 rpm.



Art.	€	BT	CM	D	L
2/1D40	€ 127,00	40	1	25 mm	45 mm
2/2D40	€ 127,00	40	2	32 mm	60 mm
2/3D40	€ 127,00	40	3	40 mm	75 mm
2/4D40	€ 133,00	40	4	50 mm	98 mm
2/2D50	€ 169,00	50	2	32 mm	40 mm
2/3D50	€ 169,00	50	3	40 mm	75 mm
2/4D50	€ 196,00	50	4	50 mm	80 mm
2/5D50	€ 223,00	50	5	63 mm	110 mm

TIPAx**CODOLINO**

DIN 69871/A.



Art.	€	ISO
TIPA40	€ 19,60	40
TIPA50	€ 20,90	50

**TIPDx****CODOLINO**

MAS-403 BT.



Art.	€	ISO
TIPD40	€ 19,60	40
TIPD50	€ 20,90	50

**M059-****MASCHIATORE A FRIZIONE REGISTRABILE CON INVERSIONE**

Il dispositivo di sicurezza regolabile con frizione riduce la possibilità di rottura del maschio durante l'esecuzione della filettatura. Invertitore di rotazione incorporato, subito attivo al cambio del dispositivo di avanzamento. Frizione regolabile in 4 posizioni. Dotato di 2 pinze flessibili e chiavi per utilizzo.

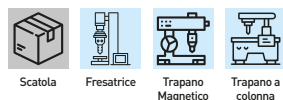

Art.	€	Campo maschiatura	Dimensioni senza CM	CM	DIN
M059/07	€ 528,00	M 2 - 7	Ø 55 x 130h mm	2	B16
M059/12	€ 605,00	M 5 - 12	Ø 75 x 162h mm	3	B16
M059/20	€ 740,00	M 8 - 20	Ø 91 x 204h mm	4	B22

**M060-****MASCHIATORE CON BUSSOLE**

Grazie alla compensazione si riduce sensibilmente la possibilità di rottura del maschio durante l'operazione di filettatura. Possibilità di regolazione dell'intensità della compensazione. Dotato di 7 bussole con attacco Ø 19 mm. Bussole per quadro: N°1 3,5x2,7 mm - N°1 4,5x3,4 mm - N°2 6x4,9 mm - N°1 8x6,2 mm - N°1 10x8 mm - N°1=9x7 mm.

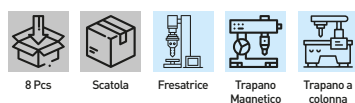

Art.	€	Campo maschiatura	Lunghezza mandrino con e senza bussola	CM
M060/2	€ 487,00	M 3 - 12	213 - 175 - Ø 46 mm	2
M060/3	€ 487,00	M 3 - 12	228 - 190 - Ø 46 mm	3
M060/4	€ 521,00	M 3 - 12	253 - 215 - Ø 46 mm	4



T021-
TESTINA PER ALESARE CENTESIMALE CON AVANZAMENTO AUTOMATICO

Per correggere lievemente l'assialità e il diametro dei fori. Può funzionare in modo automatico e manuale.



Tornio



Fresatrice

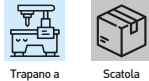

Trapano a colonna



Scatola



40 Cr



Rettificato

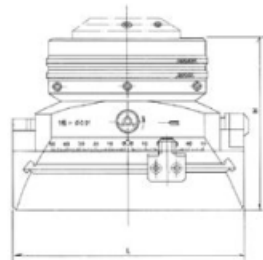
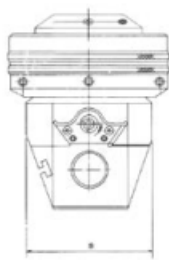

Art.	€
T021/030	€ 2070,00
T021/030CM3	€ 2070,00
T021/050	€ 2410,00
T021/100	€ 2790,00
T021/100/50	€ 2790,00

	T021/030 T021/030CM3	T021/050	T021/100 T021/100/50
Diametro max di spianatura e foratura	150 mm	350 mm	450 mm
Max spostamento della slitta	± 15 mm	± 25 mm	± 50 mm
Avanzamento fine	0,005 mm	0,005 mm	0,005 mm
Avanzamento manuale per giro	2 mm	3 mm	3 mm
Avanzamento automatico per giro	0,02-0,04-0,06 0,08-0,10-0,12 mm	0,03-0,06-0,09 0,12-0,15-0,18 mm	0,03-0,06-0,09 0,12-0,15-0,18 mm
Diametro dei fori della testina	18 mm	22 mm	22 mm
Diametro della testina	90 mm	120 mm	168 mm
Altezza della testina senza attacco (H)	87,5 mm	118 mm	118 mm
Peso della testina senza attacco	2,9 kg	6,1 kg	7,8 kg
Lunghezza della testa (L)	75 mm	105 mm	160 mm
Larghezza della testa (B)	70 mm	90 mm	90 mm
Foro pinze	4 - 8 - 12 mm	8 - 10 - 12 - 14 mm	8 - 10 - 12 - 14 mm
Accessori in dotazione	1 - 2 - 6	1 - 2 - 3 - 4 - 5	1 - 2 - 3 - 4 - 5
Foro prolunga per utensile	Ø 6 mm	Ø 10 mm	Ø 10 mm

T010-
TESTINA PER ALESARE CENTESIMALE

Kit utensili non compreso, per correggere lievemente l'assialità e il diametro dei fori.

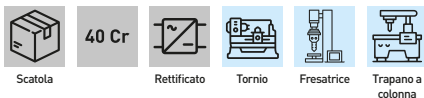

Art.	€	Corpo testina	Attacco	Bareni	Spostamento	A
T010/5003	€ 290,00	Ø 50 mm	CM/MT3-DIN228A	Ø 12 mm	15 mm	75 mm
T010/5004	€ 290,00	Ø 50 mm	CM/MT4-DIN228A	Ø 12 mm	15 mm	75 mm
T010/5040	€ 290,00	Ø 50 mm	ISO 40-DIN2080	Ø 12 mm	15 mm	81 mm
T010/7540	€ 331,00	Ø 75 mm	ISO 40-DIN2080	Ø 18 mm	25 mm	99 mm

B001-
SET UTENSILI PER TESTE ALESARE

Per le varie lavorazioni di alesatura.



Art.	€	Adattabile	Stelo	Lunghezza	Vite	Inserito (non incluso)
B001/12	€ 134,00	T010/50	12 Ø mm	60 mm	KV250	TCMT110204N
B001/18	€ 134,00	T010/75	18 Ø mm	99 mm	KV250	TCMT110204N



S007-
SMONTA MANDRINO INCLINABILE

DIN 2080, DIN 69871/A e MAS BT-TC, consente l'orientamento dei portautensili sugli assi verticali e orizzontali per facilitare il montaggio degli utensili. Il cono dei portautensili è protetto da due anelli O-Ring opportunamente posizionati. Cono in acciaio, leve di manovra in materiale termoplastico, base da fissare al banco di lavoro con 4 viti.



Scatola



Acciaio

Art.	€	Dimensioni	Base	Conicità
S007/30	€ 245,00	230 x h150 mm	Ø 150 mm	ISO 30 DIN 2080 - SK30 DIN 69871 - BT30 - CAT30 - HSK50A - CAPTO C5
S007/40	€ 249,00	235 x h155 mm	Ø 150 mm	ISO 40 DIN 2080 - SK40 DIN 69871 - BT40 - CAT40 - HSK63A - CAPTO C6
S007/50	€ 279,00	265 x h200 mm	Ø 180 mm	ISO 50 DIN 2080 - SK50 DIN 69871 - BT50 - CAT50 - HSK100A - CAPTO C10

S014-
SMONTA MANDRINO

Dotato di postazione verticale e orizzontale. Base con 4 fori di staffaggio per poterlo fissare al banco di lavoro.



Cassa di legno

Art.	€	Mandrino
S014/40BT	€ 86,10	BT 40 ISO 40
S014/40DIN	€ 86,10	DIN 69871.40 ISO 40
S014/50BT	€ 195,00	BT 50 ISO 50
S014/50DIN	€ 195,00	DIN 69871.50 ISO 50

P450A
€ 490,00 NEW
CARRELLO PORTACONI

Dotato di pareti fessurate con l'inserimento di telai portaboccole, maniglia per il trasporto. Fornito in kit di montaggio con 20 portaconi.



Scatola

Dimensioni	1080 x 656 x 830h mm
Conicità	ISO 50

P440A
€ 469,00 NEW
CARRELLO PORTACONI

Dotato di pareti fessurate con l'inserimento di telai portaboccole, maniglia per il trasporto. Fornito in kit di montaggio con 28 portaconi.



Scatola

Dimensioni	1080 x 656 x 830h mm
Conicità	ISO 40

P350A
€ 192,00 NEW
SUPPORTI PORTACONI DA BANCO

Telaio posizionabile su banco da lavoro o sugli armadi, predisposto per l'inserimento delle boccole portautensili su tre file. Fornito in kit di montaggio con 15 portaconi.



Scatola

Dimensioni	620 x 453 x 350h mm
Conicità	ISO 50

P340A
€ 190,00 NEW
SUPPORTI PORTACONI DA BANCO

Telaio posizionabile su banco da lavoro o sugli armadi, predisposto per l'inserimento delle boccole portautensili su tre file. Fornito in kit di montaggio con 21 portaconi.



Scatola

Dimensioni	620 x 453 x 350h mm
Conicità	ISO 40

PC50A € 40,80 **NEW**

MENSOLE PORTACONI

Dotato di maniglie per la movimentazione. Fornito con 5 portaconi.



Scatola

Dimensioni 620 x 140 x 90h mm
Conicità ISO 50

PC40A € 40,80 **NEW**

MENSOLE PORTACONI

Dotato di maniglie per la movimentazione. Fornito con 7 portaconi.



Scatola

Dimensioni 620 x 145 x 65h mm
Conicità ISO 40

PC50A/R € 33,40 **NEW**

BOCCOLE PORTACONO

Fissaggio mediante perno.



10 Pcs



Scatola

Plastic

Dimensioni 140 x 105 mm
Conicità ISO 50

PC40A/R € 30,30 **NEW**

SERIE DI 10 BOCCOLE PORTACONO

Fissaggio mediante perno.



10 Pcs



Scatola

Plastic

Dimensioni 140 x 80 mm
Conicità ISO 40

P4ACS € 10,50 **NEW**

COPPIA SUPPORTI MENSOLA

Per carrello.



Acciaio





C046-

CONTROPUNTA ROTANTE

Utilizzate principalmente nei torni con l'obiettivo di stabilizzare i pezzi lunghi e sottili, più soggetti alla flessione o all'oscillazione incontrollata causate dalle forze generate durante la lavorazione.

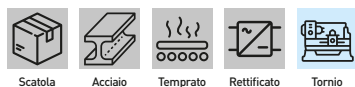

Art.	€	CM	Cuspide	Corpo	Lunghezza	Max rpm	Portata max
C046/2	€ 78,70	2	60° - max Ø21 mm	Ø 45 mm	152 mm	2500 g/min	50 kg
C046/3	€ 95,50	3	60° - max Ø27 mm	Ø 53 mm	180 mm	2500 g/min	75 kg
C046/4	€ 101,00	4	60° - max Ø29 mm	Ø 63 mm	218 mm	2000 g/min	150 kg
C046/5	€ 139,00	5	60° - max Ø37 mm	Ø 80 mm	276 mm	2000 g/min	200 kg

C050-

SET CONTROPUNTA GIREVOLE

Utilizzate principalmente nei torni con l'obiettivo di stabilizzare i pezzi lunghi e sottili, più soggetti alla flessione o all'oscillazione incontrollata causate dalle forze generate durante la lavorazione. Completo di 7 inserti intercambiabili ed estrattore per gli inserti.

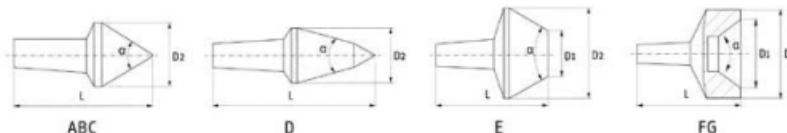

Art.	€	CM	A	B	C	D	E	F	G
C050/2	€ 190,00	2	L2 39 mm - D2-D3 16 mm - α 60° mm	L2 35,5 mm - D2-D3 16 mm - α 75° mm	L2 33 mm - D2-D3 16 mm - α 90° mm	L2 46 mm - D2-D3 16 mm - α 60° mm	L2 40 mm - D2-D3 25 mm / 10 mm - α 60° mm	L2 36 mm - D2-D3 16 mm / 10 mm - α 60° mm	L2 39 mm - D2-D3 20 mm / 16 mm - α 60° mm
C050/3	€ 213,00	3	L2 48 mm - D2-D3 20 mm - α 60° mm	L2 43,5 mm - D2-D3 20 mm - α 75° mm	L2 40,5 mm - D2-D3 20 mm - α 90° mm	L2 56 mm - D2-D3 18 mm - α 60° mm	L2 50 mm - D2-D3 35 mm / 15 mm - α 60° mm	L2 42 mm - D2-D3 22 mm / 18 mm - α 60° mm	L2 48 mm - D2-D3 35 mm / 30 mm - α 60° mm
C050/4	€ 309,00	4	L2 61,5 mm - D2-D3 28 mm - α 60° mm	L2 55,5 mm - D2-D3 28 mm - α 75° mm	L2 51,5 mm - D2-D3 28 mm - α 90° mm	L2 73 mm - D2-D3 26 mm - α 60° mm	L2 61,5 mm - D2-D3 55 mm / 30 mm - α 60° mm	L2 55 mm - D2-D3 40 mm / 35 mm - α 60° mm	L2 60 mm - D2-D3 55 mm / 48 mm - α 60° mm

C055-

CONTROPUNTA ROTANTE PER TUBI

Per tornitura e rettifica di tubi e corpi cavi.



Art.	€	CM	Ø	Lunghezza	Max rpm	Portata max
C055/3	€ 227,00	3	60° - 30 ÷ 100 mm	170 mm	2500 g/min	200 kg
C055/4	€ 321,00	4	60° - 40 ÷ 160 mm	230 mm	1600 g/min	350 kg
C055/5	€ 450,00	5	60° - 66 ÷ 200 mm	290 mm	1500 g/min	350 kg

C053-

CONTROPUNTA FISSA CON CUSPIDE IN METALLO DURO

Utilizzate principalmente nei torni con l'obiettivo di stabilizzare i pezzi lunghi e sottili, più soggetti alla flessione o all'oscillazione incontrollata causate dalle forze generate durante la lavorazione.



Art.	€	CM	Cuspide in metallo duro max	Lunghezza
C053/2	€ 20,60	2	60° - max Ø 8 mm	100 mm
C053/3	€ 22,80	3	60° - max Ø 11 mm	125 mm
C053/4	€ 33,70	4	60° - max Ø 13 mm	160 mm
C053/5	€ 52,20	5	60° - max Ø 17 mm	200 mm

COME SCEGLIERE LA TORRETTA

ALTEZZA PUNTE TORNIO	TORRETTA TIPO
90 mm	A0
120 mm	A1
140 mm	A
150 - 200 mm	E
200 - 250 mm	B
250 - 350 mm	C

0688
€ 215,00
APPARECCHIO UNIVERSALE A FRESARE PER TORNIO

Permette di effettuare una lavorazione superficiale sul pezzo staffato con l'utilizzo del mandrino del tornio come portautensile. Fissaggio mediante adattamento meccanico rispetto alla macchina in cui deve essere applicato.

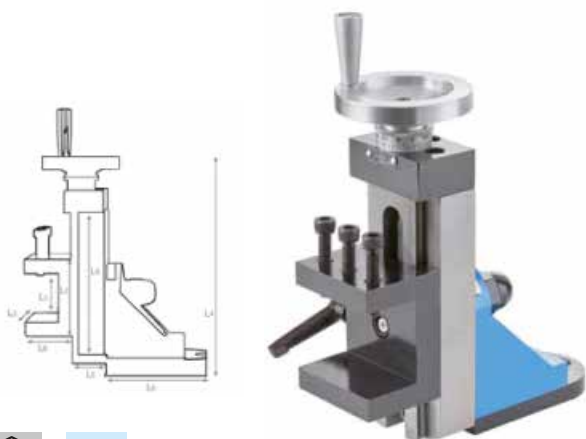

L1	52 mm
L2	80 mm
L3	65 mm
L4	220 mm
L5	37 mm
L6	110 mm
L8	46 mm
L9	150 mm

T00x
TORRETTA PORTA UTENSILI A CAMBIO RAPIDO

Con dentatura di attacco temprata e rettificata. Agendo su di un perno eccentrico, il portautensile viene bloccato sulla dentatura del corpo. Permette una riproducibilità di 40 posizioni angolari possibili del portautensile. Questa precisione viene mantenuta anche dopo innumerevoli cambi dell'utensile. Composto da: 1 torretta portautensili, 3 portautensili a sede piana, 1 portautensile a sede prismatica.

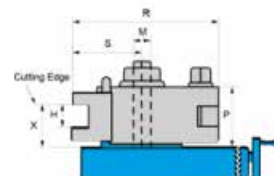

Art.	€	R max	S max	P	H	X min
T00A	€ 877,00	100 mm	54 mm	48 mm	16 mm	30 mm
T00B	€ 1120,00	150 mm	75 mm	71 mm	25 mm	37 mm
T00C	€ 1790,00	202 mm	105 mm	102 mm	32 mm	47 mm
T00E	€ 926,00	125 mm	68 mm	60 mm	20 mm	35 mm

T00x-D
PORTA UTENSILI A SEDE PIANA

Tipo D dotato di vite per la regolazione dell'altezza e 3 viti di serraggio.

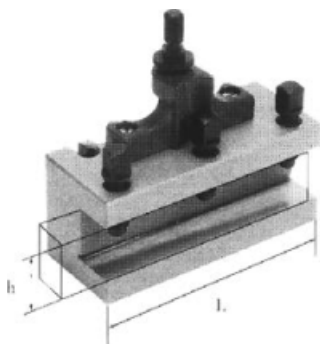

Art.	€	L	h
T00A/D	€ 124,00	80 mm	16 mm
T00B/D	€ 185,00	120 mm	25 mm
T00C/D	€ 286,00	150 mm	32 mm
T00E/D	€ 167,00	100 mm	20 mm

T00x-B
PORTA UTENSILI A SEDE PRISMATICA

Tipo B dotato di vite per la regolazione dell'altezza e 3 viti di serraggio dello stelo.

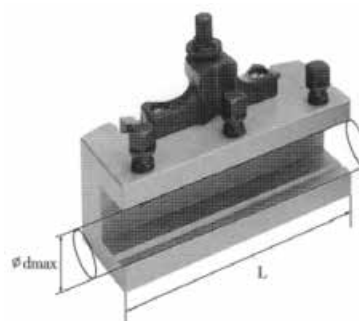

Art.	€	L	d max
T00A/B	€ 129,00	80 mm	20 mm
T00B/B	€ 191,00	130 mm	32 mm
T00C/B	€ 283,00	160 mm	32 mm
T00E/B	€ 185,00	100 mm	30 mm



T00x-S

PORTA UTENSILI PER BUSSOLA

Tipo S, adatto per l'alloggiamento di bussole a cono morse cod. C40142, e per l'alloggiamento diretto di barre di tornitura. Dotato di vite di regolazione e 2 viti di bloccaggio.

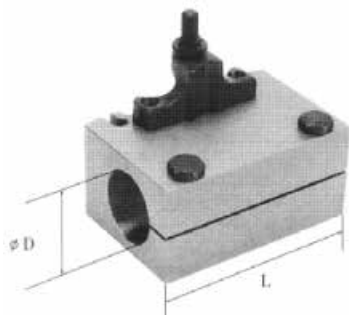

Art.	€	L	D
T00A/S	€ 142,00	80 mm	30 mm
T00B/S	€ 235,00	120 mm	40 mm
T00C/S	€ 331,00	150 mm	40 mm
T00E/S	€ 191,00	100 mm	30 mm

T00x-LC

BUSSOLA A CONO MORSE

Per l'alloggiamento di utensili con attacco CM.

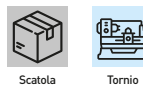
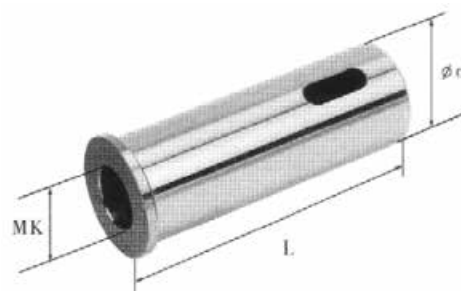

Art.	€	L	d	CM
T00AE/LCM1	€ 41,30	80 mm	30 mm	1
T00AE/LCM2	€ 41,30	95 mm	30 mm	2
T00BC/LCM2	€ 44,70	105 mm	36 mm	2
T00BC/LCM3	€ 44,70	120 mm	40 mm	3
T00BC/LCM4	€ 68,80	150 mm	40 mm	4

T0Ax

TORRETTA A CAMBIO RAPIDO

Per cambi utensili rapidi grazie alla leva di blocco/sblocco. Composizione del set: - 1 torretta portautensili - 4 portautensili a sede piana.



Art.	€	Lunghezza	Larghezza	Altezza utile	Foro	Altezza utensile
T0AA	€ 293,00	57 mm	64 mm	56 mm	14,4 mm	14 mm
T0AB	€ 493,00	95 mm	85 mm	76 mm	19,9 mm	20 mm
T0AC	€ 635,00	100 mm	100 mm	92 mm	22,22 mm	25 mm
T0AE	€ 372,00	76,5 mm	76,5 mm	90 mm	16,5 mm	20 mm

T0Ax-D

PORTAUTENSILI A SEDE PIANA

A cambio rapido con sede piana dotato di vite per la regolazione dell'altezza e 4 viti di serraggio.



Art.	€	Lunghezza	Larghezza	Altezza	Altezza utensile
T0AA/D	€ 67,50	76 mm	25,5 mm	38 mm	14 mm
T0AB/D	€ 94,50	108 mm	35 mm	54 mm	20 mm
T0AC/D	€ 111,00	125 mm	40 mm	63 mm	25 mm
T0AE/D	€ 80,90	89 mm	29 mm	45 mm	20 mm

T00Ax

NEW

TORRETTA A CAMBIO RAPIDO

Per cambi utensili rapidi grazie al perno di blocco/sblocco. Composizione del set: - 1 torretta portautensili - 3 portautensili a sede piana.



Art.	€	Lunghezza	Larghezza	Altezza	Foro	Altezza utensile
T00A0	€ 131,00	60 mm	50 mm	30 mm	10 mm	12 mm
T00A0L	€ 156,00	60 mm	50 mm	40 mm	10 mm	12 mm
T00A1R	€ 173,00	68 mm	68 mm	47 mm	10 mm	19 mm

T00Ax-PP

PORTAUTENSILI A SEDE PIANA

A cambio rapido con sede piana dotato di vite per la regolazione dell'altezza e 2 viti di serraggio.



Art.	€	Lunghezza	Larghezza	Altezza	Altezza utensile
T00A0/PP	€ 40,90	50 mm	22 mm	24 mm	12 mm
T00A1R/PP	€ 41,90	66 mm	27 mm	46 mm	19 mm

T00A1
€ 281,00
TORRETTA A CAMBIO RAPIDO

Per cambi utensili rapidi grazie al perno di blocco/sblocco. Composizione del set: - 1 torretta portautensili - 3 portautensili a sede piana.

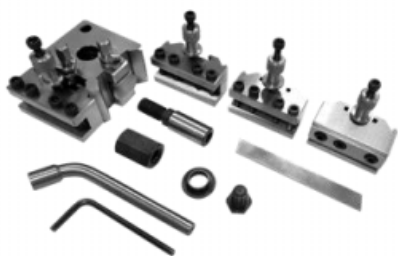

Scatola



Tornio

Lunghezza	57 mm
Larghezza	57 mm
Altezza	37 mm
Foro	16 mm
Altezza utensile	14 mm

T00A1/LR
€ 8,00 NEW
UTENSILE LAMA

Per lavorazioni di troncatura. Per portalama T00A1/PL.

HSS M2

Taglio



Tornio

Lunghezza	101,6 mm
Altezza	12,7 mm
Spessore	2,38 mm

T00A1/SP
€ 54,00 NEW
PORTAUTENSILE SEDE PRISMATICA

A cambio rapido. Dotato di vite di regolazione dell'altezza e 4 viti di serraggio.



Scatola



Tornio

Lunghezza	58 mm
Larghezza	28,5 mm
Altezza	25 mm
Altezza utensile	12 mm

T00A1/PP
€ 56,60
PORTAUTENSILI A SEDE PIANA

A cambio rapido con sede piana dotato di vite per la regolazione dell'altezza e 4 viti di serraggio.



Scatola



Tornio

Lunghezza	58 mm
Larghezza	28,5 mm
Altezza	25 mm
Altezza utensile	12 mm

T00A1/PL
€ 60,00 NEW
PORTAUTENSILE PORTALAMA

A cambio rapido. Dotato di vite di regolazione dell'altezza e 3 viti di serraggio lama.



Scatola



Tornio

Lunghezza	58 mm
Larghezza	30,5 mm
Altezza	25 mm
Altezza utensile	13 mm



**M038**

€ 740,00

AVANZAMENTO AUTOMATICO PER TAVOLE A CROCE

Per asse X, posizione del motore orizzontale, tavola con avanzamento tramite potenziometro regolabile per spostamenti e pulsante per movimenti rapido, inoltre la rotazione del motore è sia in senso orario che antiorario.



Scatola



Fresatrice



Velocità di rotazione	0 ÷ 200 rpm
Coppia max	5,1 Nm
Motore	230 V 50 Hz 0,1 kW
Peso netto	6 kg

**P018-****KIT DI REFRIGERAZIONE PER MACCHINE UTENSILI**

Per permettere di avere la refrigerazione su macchine quali torni, trapani a colonna, frese non dotate di impianto.



Scatola



Tornio



Fresatrice



Trapano a colonna

Art.	€	Alimentazione	Capacità serbatoio	Portata pompa
P018/230V	€ 385,00	230V - 50Hz - 40W	10 l	22 l/min
P018/400V	€ 385,00	400V - 50Hz - 40W	10 l	22 l/min

**T999/3A**

€ 1650,00

KIT DI VISUALIZZAZIONE TORNIO

Dotato di visualizzatore a 3 assi, righe di misurazione e cavi di connessione.



Scatola



Righe Trasversale 335 mm | Long. torretta 235 mm | Long. carro 1170 mm

0715-**SUPPORTO ANTIVIBRANTE**

NBR

Scatola

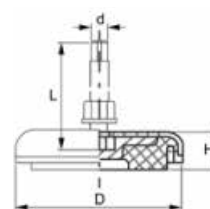

Art.	€	D	d	L	H	Portata
0715/0080	€ 30,50	40 mm	M5	40 mm	15 mm	80 Kg
0715/0400	€ 42,70	80 mm	M10	95 mm	25 mm	400 Kg
0715/1100	€ 60,90	120 mm	M12	125 mm	33 mm	1100 Kg
0715/2000	€ 73,10	160 mm	M16	145 mm	35 mm	2000 Kg

T200

€ 18,90

TUBO COMPONENTE SNODABILE PER LIQUIDI REFRIGERANTI

Adatto per liquidi e aria, resistente alle vibrazioni, diametro interno di 6 mm e attacco di 1/4". Completamente ermetico, diametro interno costante in qualsiasi posizione, inalterabile agli agenti chimici normali. Composizione del set: n. 20 segmenti, n.1 ugello: foro Ø1,5 mm, n.1 ugello: foro Ø3 mm, n.1 ugello: foro Ø7 mm, n.1 raccordo: 1/8", n.1 raccordo: 1/4", n.1 ugello a spatola.



26 Pcs



Tornio



Fresatrice



Trapano a colonna



Lunghezza totale	330 mm
Diametro tubo	6 mm - 1/4"

T201

€ 20,60

TUBO COMPONENTE SNODABILE PER LIQUIDI REFRIGERANTI

Adatto per liquidi e aria, resistente alle vibrazioni, diametro interno di 12 mm e attacco di 1/2". Completamente ermetico, diametro interno costante in qualsiasi posizione, inalterabile agli agenti chimici normali. Composizione del set: n.12 segmenti, n.1 ugello - foro: Ø6 mm, n.1 ugello - foro: Ø9.5 mm, n.1 ugello - foro: Ø12,5 mm, n.1 raccordo: 1/2", n.1 raccordo: 3/8", n.1 ugello a spatola.



18 Pcs



Tornio



Fresatrice



Trapano a colonna



Lunghezza totale	320 mm
Diametro tubo	12 mm - 1/2"

T202
€ 62,70 NEW
KIT TUBO COMPONENTE SNODABILE PER LIQUIDI REFRIGERANTI

Adatto per liquidi e aria ed inalterabile agli agenti chimici normali, diametro interno di 6 mm e attacco 1/4". Composto da: n.1 pinza montaggio tubi, n.1 raccordo a Y, n.2 raccordi: 1/8", n.2 raccordi: 1/4", n.1 rubinetto con raccordo 1/4", n.1 rubinetto con attacco tubo, n.6 ugelli (2pcs 1/16", 2pcs 1/8" e 2pcs 1/4"), n.3 ugelli a spatola, n.2 ugelli a spatola con fori, n.3 ugelli a 90°, n.1 ugello a 90° con fori, n.6 tubi l=150 mm composto da 10 segmenti l'uno.

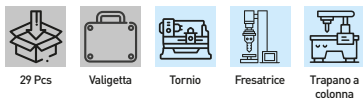

Diametro tubo

6 mm - 1/4"

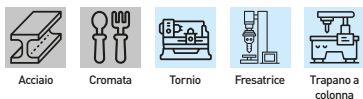
T338-
TUBO SNODATO IN METALLO CROMATO PER LIQUIDI REFRIGERANTI

Art.	€	Lunghezza totale	Filetto
T338/500	€ 19,50	500 mm	3/8"
T338/600	€ 21,60	600 mm	3/8"

Tx
PROTEZIONE PER TORNIO CON SCHERMO IN LEXAN E STRUTTURA IN ACCIAIO

Art.	€	Dimensioni
T400	€ 204,00	Ø 400 x 200 mm
T500	€ 217,00	Ø 500 x 220 mm
T600	€ 236,00	Ø 600 x 280 mm

P100/250
€ 136,00
PROTEZIONE ANTINFORTUNISTICA PER MACCHINE UTENSILI

Regolabile in altezza con microinterruttore di sicurezza.



Stelo	400 mm
Schermo	150x250 H x L mm

T203
€ 89,90 NEW
KIT TUBO COMPONENTE SNODABILE PER LIQUIDI REFRIGERANTI

Adatto per liquidi e aria ed inalterabile agli agenti chimici normali, diametro interno di 12 mm e attacco 1/2". Composto da: n.1 pinza montaggio tubi, n.1 raccordo a Y, n.2 raccordi: 1/2", n.2 raccordi: 3/8", n.1 rubinetto con attacco tubo, n.1 rubinetto con raccordo 1/2", n.1 attacco snodato da 1/2", n.6 ugelli (2pcs con foro Ø6 mm, 2pcs con foro Ø9,5 mm e 2pcs con foro Ø12,5 mm), n.3 ugelli a 90°, n.3 ugelli a 90° con fori, n.6 tubi l=160 mm composti da 7 segmenti l'uno.

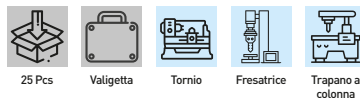

Diametro tubo

12 mm - 1/2"

S100
€ 63,80
PROTEZIONE REGOLABILE PER MOLA CON SCHERMO IN LEXAN

Dimensioni

110 x 120 mm

Mx
ATTACCO UNIVERSALE PER TORNIO CON MICROINTERRUTTORE DI SICUREZZA

Art.	€	Stelo	Lunghezza
M400	€ 257,00	Ø 30 mm	350 mm
M500	€ 266,00	Ø 30 mm	400 mm
M600	€ 277,00	Ø 30 mm	450 mm

P101-
PROTEZIONE ANTINFORTUNISTICA PER MACCHINE UTENSILI

Con microinterruttore di sicurezza e schermo in lexan.

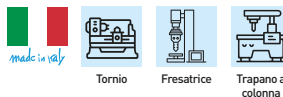
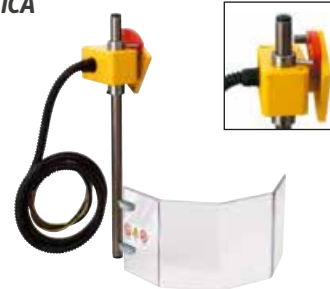

Art.	€	Stelo	Schermo
P101/300	€ 439,00	400L mm	150 x 350 H x L mm
P101/350	€ 462,00	500L mm	150 x 400 H x L mm
P101/400	€ 476,00	600L mm	200 x 500 H x L mm

**0531A****€ 168,00****LAMPADA A LED PER MACCHINE UTENSILI**

Snodato, senza trasformatore.

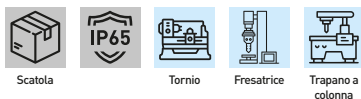

Alimentazione	24 V 13 W AC/DC
Flusso luminoso	1800 lm
Temperatura colore	6500 K
Numero dei LED	9
Altezza	110 mm
Diametro	125 mm
Snodi	1

**0532A****€ 204,00****LAMPADA A LED PER MACCHINE UTENSILI**

Snodato, senza trasformatore.

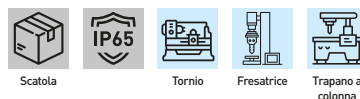

Alimentazione	24 V 13 W AC/DC
Flusso luminoso	1800 lm
Temperatura colore	6500 K
Numero dei LED	9
Altezza	890 mm
Diametro	125 mm
Snodi	3

**0532A/230V****€ 223,00****LAMPADA A LED PER MACCHINE UTENSILI**

Snodato, con trasformatore.

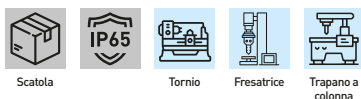

Alimentazione	230 V 50 Hz 13 W
Flusso luminoso	1800 lm
Temperatura colore	6500 K
Numero dei LED	9
Altezza	900 mm
Diametro	125 mm
Snodi	3

**0371****€ 178,00****LAMPADA A LED PER MACCHINE UTENSILI**

Snodato, senza trasformatore.

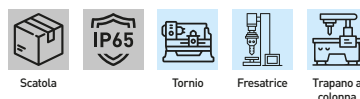

Alimentazione	24V 10W
Flusso luminoso	1200 lm
Temperatura colore	6500 K
Altezza snodo	110 mm
Diametro	110 mm
Snodi	1

**0537A****€ 123,00****LAMPADA A LED PER MACCHINE UTENSILI**

Snodato, senza trasformatore.

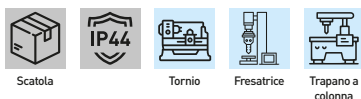

Alimentazione	24V 7W
Flusso luminoso	700 lm
Temperatura colore	6500 K
Numero dei LED	7
Altezza	100 mm
Diametro	90 mm
Snodi	1

**0538A****€ 153,00****LAMPADA A LED PER MACCHINE UTENSILI**

Snodato, senza trasformatore.

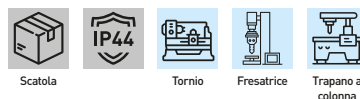

Alimentazione	24V 7W
Flusso luminoso	700 lm
Temperatura colore	6500 K
Numero dei LED	7
Altezza	650 mm
Diametro	90 mm
Snodi	3

**0536****€ 83,70****LAMPADA ALOGENA PER MACCHINE UTENSILI**

Flessibile, con trasformatore e base magnetica.

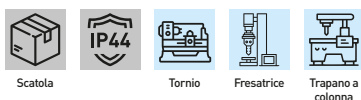

Altezza massima	620 mm
Completa di trasformatore	230 V / 12 V 25 W

**0536A****€ 156,00****LAMPADA A LED PER MACCHINE UTENSILI**

Flessibile, con trasformatore e base magnetica.

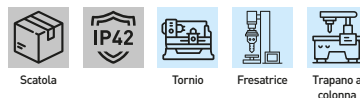

Alimentazione	230V / 5W
Altezza	600 mm
Diametro	60 mm
Snodi	1
Luminosità	500 lm - 6400 K



UTENSILI PER TORNITURA E FRESATURA

- p. 146 Utensili per esterno da tornitura
- p. 152 Utensili per interno da tornitura
- p. 155 Utensili per filettare e troncare
- p. 160 Utensili per fresatura
- p. 164 Accessori utensili

INSERTI, BRASATI E BARRETTE

- p. 168 Inserti per tornitura
- p. 175 Inserti per fresatura
- p. 178 Inserti per filettare
- p. 178 Inserti per troncare
- p. 179 Brasati
- p. 181 Barrette

PUNTE E FRESE DA METALLO

- p. 184 Punta cilindriche
- p. 193 Punta coniche e da centro
- p. 195 Attacco Weldon
- p. 199 Seghe a tazza
- p. 206 Alesatori a macchina
- p. 207 Lamatori
- p. 208 Svasatori, utensili allargafori e a gradino
- p. 210 Frese frontali
- p. 212 Frese rotative in metallo duro
- p. 220 Coltelli stozzatori e creatori

PUNTE E FRESE DA EDILIZIA E LEGNO

- p. 221 Punta cilindriche
- p. 221 Attacco Sds Plus
- p. 222 Seghe a tazza
- p. 223 Utensili diamantati
- p. 226 Punta e seghe a tazza da legno
- p. 227 Frese da legno

MASCHI E FILIERE

- p. 228 Maschi e filiere in serie
- p. 231 Maschi a macchina
- p. 234 Filiere e girafilieri

RIPARAZIONE FILETTI

- p. 237 Serie riparazione filetti
- p. 242 Inserti filettati
- p. 246 Maschi per riparazione filetti
- p. 249 Utensili per riparazione filetti



LAME A NASTRO E A DISCO

- p. 250 Lame a nastro
- p. 251 Lame a disco

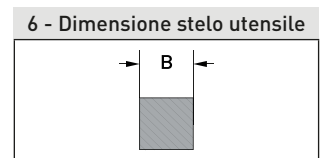
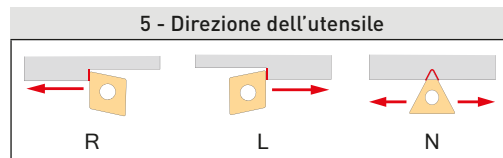
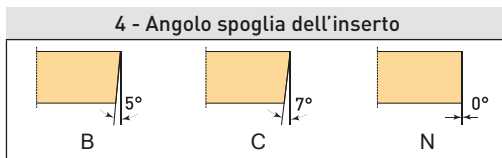
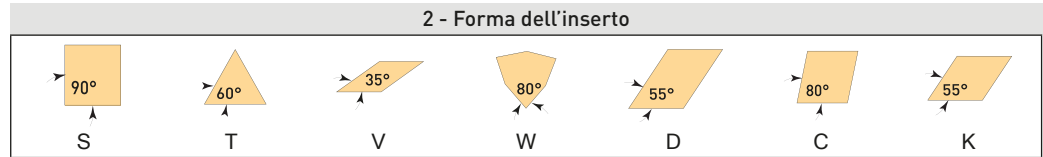
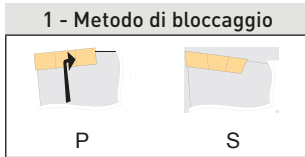
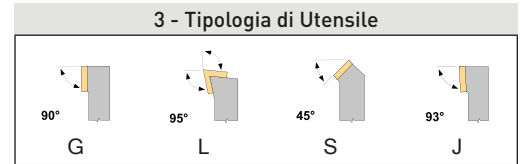

IDENTIFICAZIONE UTENSILI PER TORNITURA PER LAVORAZIONE ESTERNA

S	T	G	C	R	16
1	2	3	4	5	6



IDENTIFICAZIONE UTENSILI PER TORNITURA PER LAVORAZIONE INTERNA

S	S	S	C	R	16
1	2	3	4	5	6

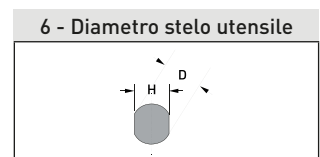
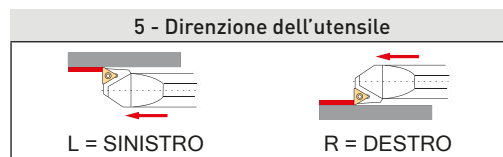
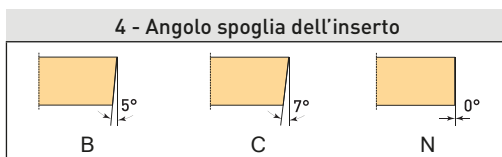
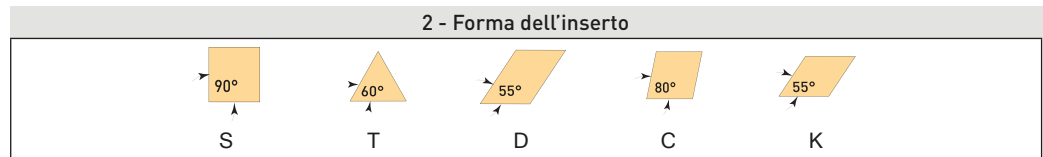
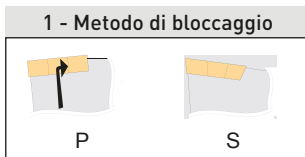
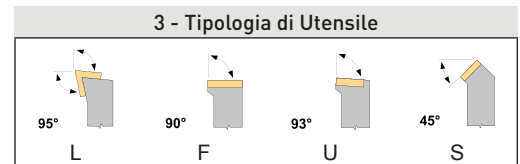

SCelta DELLA FORMA INSERTO IN BASE AL TIPO DI LAVORAZIONE DA ESEGUIRE

Tornitura esterna	S	T	C	K	D
Tornitura Assiale / Sfacciatura	○	○	●	○	○
Profilatura	-	○	-	○	●
Sfacciatura	●	○	○	○	○
Tornitura a tuffo	-	○	-	-	-

Tornitura interna	S	T	C	K	D
Tornitura Assiale / Sfacciatura	○	●	○	-	○
Profilatura	-	○	-	○	●
Sfacciatura	-	○	●	-	○

Legenda
 ● Forma consigliata
 ○ Forma possibile
 - Non utilizzabile

VALORI CONSIGLIATI VELOCITA' DI TAGLIO Vt (m/min) PER TORNITURA

Materiale da lavorare		Tornitura Esterna		Tornitura Interna		Utensile di Forma	Troncatura	Filettatura con utensile
		Sgrossatura	Finitura	Sgrossatura	Finitura			
P	Acciaio Rm < 600 N/mm ²	100*	150*	70*	100*	50*	95*	25*
	Acc. Rm 600 – 100 N/mm ²	95*	120*	50*	95*	30*	70*	18*
	Acc. Rm 1000 – 1200 N/mm ²	65*	80*	40*	65*	25*	55*	15*
M	Acciaio Inossidabile	60*	70*	35*	60*	20*	50*	15*
K	Ghisa HB < 180	90*	100*	65*	90*	30*	80*	15*
	Ghisa HB > 180	60*	70*	40*	60*	20*	55*	12*
N	Ottone/Bronzo	165*	260*	80*	160*	40*	100*	25*
	Rame	220*	350*	100*	220*	80*	200*	25*
	Alluminio	300*	650*	200*	400*	150*	300*	35*

* = Valori per utensili saldobrasati, per utensili a fissaggio meccanico il valore riportato può essere maggiorato del 15%

VALORI CONSIGLIATI DELL'AVANZAMENTO a (mm/giro) PER TORNITURA

Materiale da lavorare		Tornitura Esterna		Tornitura Interna		Utensile di Forma	Troncatura
		Sgrossatura	Finitura	Sgrossatura	Finitura		
P	Acciaio Rm < 600 N/mm ²	0.1 – 0.4*	0.05 – 0.2*	0.05 – 0.3*	0.05 – 0.2*	0.02 – 0.05*	0.05 – 0.1*
	Acc. Rm 600 – 100 N/mm ²	0.1 – 0.4*	0.05 – 0.15*	0.05 – 0.3*	0.05 – 0.1*	0.02 – 0.05*	0.05 – 0.1*
	Acc. Rm 1000 – 1200 N/mm ²	0.1 – 0.4*	0.05 – 0.15*	0.05 – 0.3*	0.05 – 0.1*	0.02 – 0.05*	0.05*
M	Acciaio Inossidabile	0.1 – 0.4*	0.05 – 0.15*	0.05 – 0.3*	0.05 – 0.1*	0.02 – 0.05*	0.02 – 0.05*
K	Ghisa HB < 180	0.1 – 0.6*	0.05 – 0.2*	0.05 – 0.6*	0.05 – 0.2*	0.02 – 0.05*	0.05 – 0.1*
	Ghisa HB > 180	0.1 – 0.8*	0.05 – 0.25*	0.05 – 0.5*	0.05 – 0.2*	0.02 – 0.05*	0.02 – 0.05*
N	Ottone/Bronzo	0.1 – 0.8*	0.05 – 0.25*	0.05 – 0.6*	0.05 – 0.2*	0.02 – 0.1*	0.05 – 0.2*
	Rame	0.1 – 0.6*	0.05 – 0.25*	0.05 – 0.5*	0.05 – 0.25*	0.02 – 0.05*	0.05 – 0.1*
	Alluminio	0.1 – 0.8*	0.05 – 0.25*	0.05 – 0.4*	0.05 – 0.2*	0.02 – 0.2*	0.05 – 0.3*

* = Valori per utensili saldobrasati, per utensili a fissaggio meccanico il valore riportato può essere maggiorato del 15%

VALORI CONSIGLIATI DELL'AVANZAMENTO a (mm/giro) PER TORNITURA

Profondità di passata		Ø particolare					
Sgrossatura	0.5 - 10	fino a 25	25 - 70	50 - 75	75 - 100	100 - 150	150 - 300
Finitura	0.2 - 20						
Troncatura	Pari allo spessore dell'insero troncatore						

PRINCIPALI FORMULE TORNITURA

- $V_t = (n \times \pi \times D) \div 1000$
- $n = (V_t \times 1000) \div (\pi \times D)$
- $V_f = n \times F_z$

Legenda

V_t : Velocità di taglio in metri al minuto. E' la velocità periferica con cui il tagliente asporta il materiale. (m/min)

n : Velocità di rotazione del mandrino in giri al minuto (gir/min)

D : Diametro del pezzo da lavorare in millimetri (mm)

F_z : Avanzamento dell'utensile (per dente) ad ogni giro in millimetri (mm/giro)

V_f : Velocità di avanzamento dell'utensile in millimetri al minuto (mm/min)

π : il suo valore è di 3.14



TIPOLOGIA UTENSILI PER TORNITURA ESTERNA

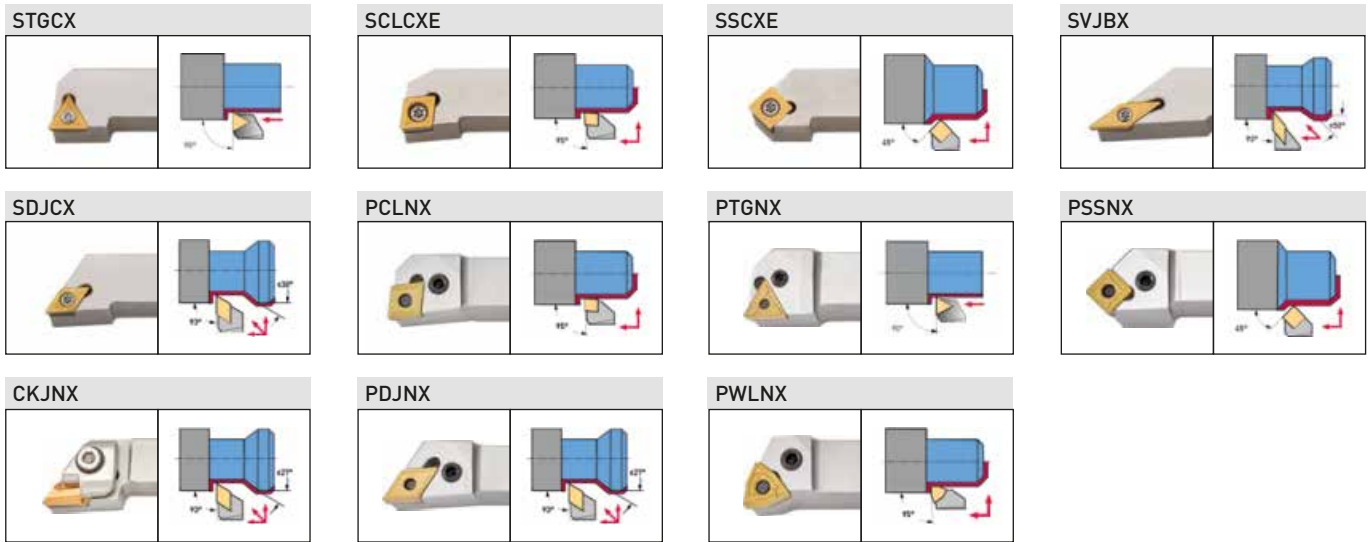

TIPOLOGIA UTENSILI PER TORNITURA INTERNA

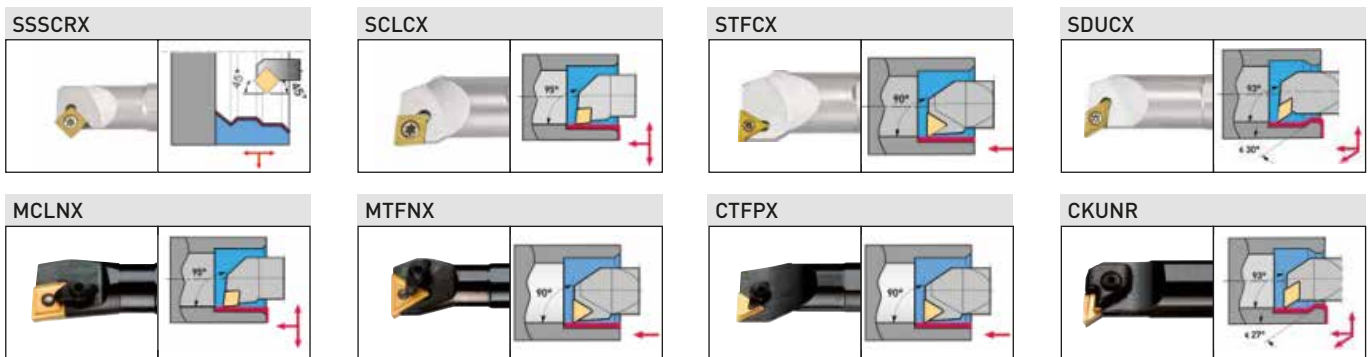

TIPOLOGIA UTENSILI PER FILETTATURA

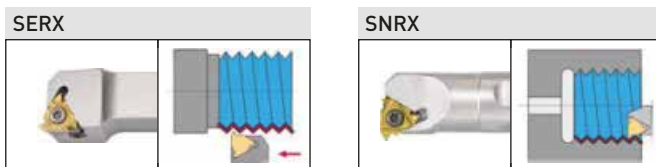

TIPOLOGIA UTENSILI PER ESECUZIONE GOLE E TRONCATURA

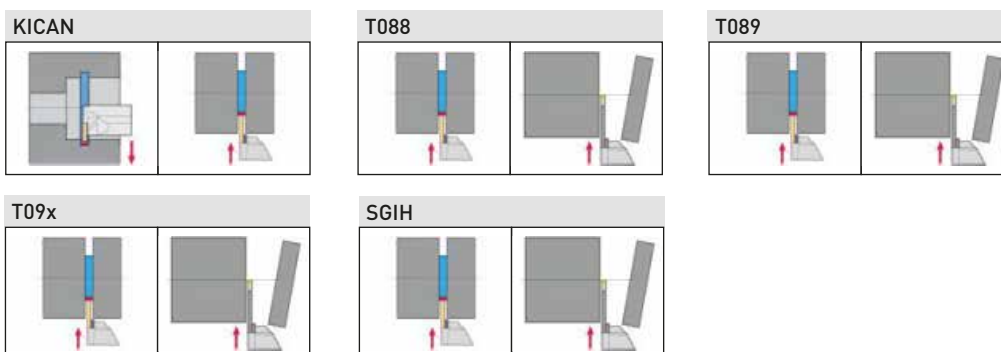

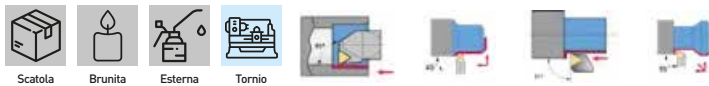

B007-
NEW
SET 5 UTENSILI AD INSERITO

Inserti inclusi, utile per avere un set che permette di eseguire la maggior parte di operazioni di tornitura con torni di piccole dimensioni.

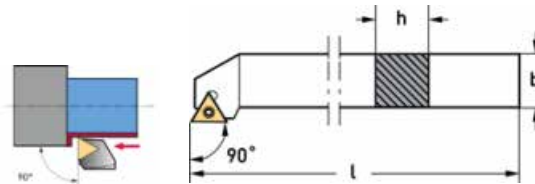

Art.	€	Stelo ut. est. / Inserto	Stelo ut. int. / Inserto	Lunghezza	Vite
B007/10	€ 113,00	10 mm / TCMT110204...	8 mm / TCMT090204...	Ext: 63 mm / Int: 100 mm	KV250
B007/12	€ 120,00	12 mm / TCMT110204...	10 mm / TCMT110204...	Ext: 88 mm / Int: 125 mm	KV250
B007/16	€ 148,00	16 mm / TCMT16T304...	12 mm / TCMT110204...	Ext: 100 mm / Int: 150 mm	Ext: KV400 / Int: KV250
B007/20	€ 199,00	20 mm / TCMT16T304...	16 mm / TCMT110204...	Ext: 115 mm / Int: 200 mm	Ext: KV400 / Int: KV250
B007/25	€ 249,00	25 mm / TCMT16T304...	20 mm / TCMT110204...	Ext: 150 mm / Int: 250 mm	Ext: KV400 / Int: KV250
B007/32	€ 339,00	32 mm / TCMT16T304...	25 mm / TCMT16T304...	Ext: 170 mm / Int: 250 mm	KV400

KITSTGXC
NEW
UTENSILE PER ESTERNO CON INSERTI

Art.	€	Utensili per esterno	Inserti	b	h	l
KITSTGCR16	€ 117,00	STGCR16/11	TCMT110204N x 10 Pcs	16 mm	16 mm	100 mm
KITSTGCR20	€ 149,00	STGCR20	TCMT16T304N x 10 Pcs	20 mm	20 mm	125 mm
KITSTGCR25	€ 173,00	STGCR25	TCMT16T304N x 10 Pcs	25 mm	25 mm	150 mm

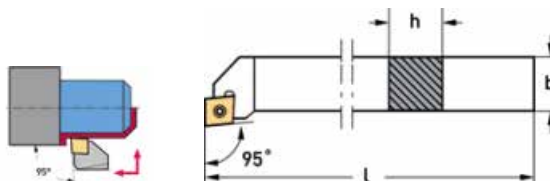
KITSCLCXE
NEW
UTENSILE PER ESTERNO CON INSERTI

Art.	€	Utensili per esterno	Inserti	b	h	l
KITSCLCR12E	€ 148,00	SCLCR12E	CCMT09T304N x 10 Pcs	12 mm	12 mm	80 mm
KITSCLCR16E	€ 148,00	SCLCR16E	CCMT09T304N x 10 Pcs	16 mm	16 mm	100 mm
KITSCLCR20E	€ 175,00	SCLCR20E	CCMT120408N x 10 Pcs	20 mm	20 mm	125 mm
KITSCLCR25E	€ 183,00	SCLCR25E	CCMT120408N x 10 Pcs	25 mm	25 mm	150 mm

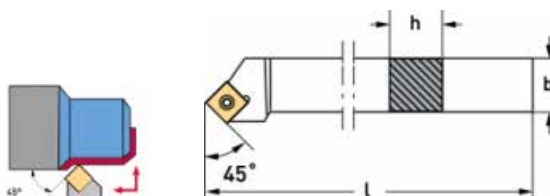
KITSSSCXE
NEW
UTENSILE PER ESTERNO CON INSERTI

Art.	€	Utensili per esterno	Inserti	b	h	l
KITSSSCR20E	€ 167,00	SSSCR20E	SCMT120408N x 10 Pcs	20 mm	20 mm	125 mm
KITSSSCR25E	€ 181,00	SSSCR25E	SCMT120408N x 10 Pcs	25 mm	25 mm	150 mm



KITSVJBX

NEW

UTENSILE PER ESTERNO CON INSERTI

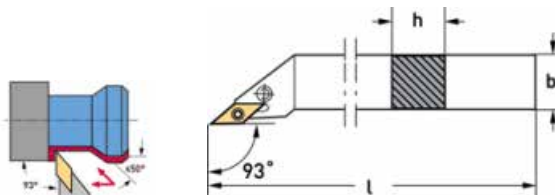

Art.	€	Utensili per esterno	Inserti	b	h	l
KITSVJBR20	€ 184,00	SVJBR20	VBMT160404N x 10 Pcs	20 mm	20 mm	125 mm
KITSVJBR25	€ 199,00	SVJBR25	VBMT160404N x 10 Pcs	25 mm	25 mm	150 mm

KITSDJCX

NEW

UTENSILE PER ESTERNO CON INSERTI

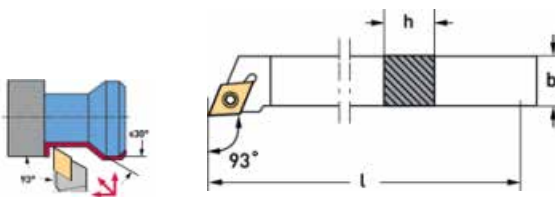

Art.	€	Utensili per esterno	Inserti	b	h	l
KITSDJCR10	€ 101,00	SDJCR10	DCMT070204N x 10 Pcs	10 mm	10 mm	70 mm
KITSDJCR12	€ 113,00	SDJCR12	DCMT070204N x 10 Pcs	12 mm	12 mm	80 mm
KITSDJCR16	€ 119,00	SDJCR16	DCMT070204N x 10 Pcs	16 mm	16 mm	100 mm
KITSDJCR20	€ 149,00	SDJCR20	DCMT11T304N x 10 Pcs	20 mm	20 mm	125 mm
KITSDJCR25	€ 163,00	SDJCR25	DCMT11T304N x 10 Pcs	25 mm	25 mm	150 mm

KITPCLNX

NEW

UTENSILE PER ESTERNO CON INSERTI

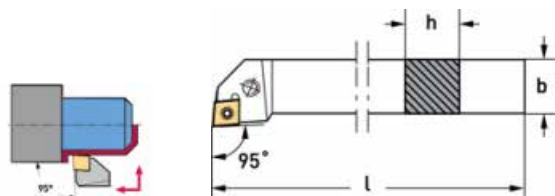

Art.	€	Utensili per esterno	Inserti	b	h	l
KITPCLNR16	€ 133,00	PCLNR16	CNMG120404N x 10 Pcs	16 mm	16 mm	100 mm
KITPCLNR20	€ 146,00	PCLNR20	CNMG120404N x 10 Pcs	20 mm	20 mm	125 mm
KITPCLNR25	€ 156,00	PCLNR25	CNMG120404N x 10 Pcs	25 mm	25 mm	150 mm

KITPTGNX

NEW

UTENSILE PER ESTERNO CON INSERTI

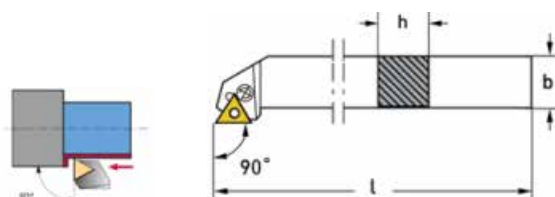

Art.	€	Utensili per esterno	Inserti	b	h	l
KITPTGNR16	€ 140,00	PTGNR16	TNMG160404N x 10 Pcs	16 mm	16 mm	100 mm
KITPTGNR20	€ 149,00	PTGNR20	TNMG160404N x 10 Pcs	20 mm	20 mm	125 mm
KITPTGNR25	€ 163,00	PTGNR25	TNMG160404N x 10 Pcs	25 mm	25 mm	150 mm

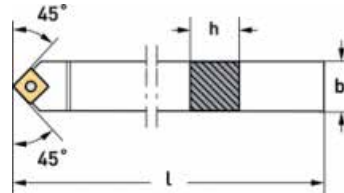
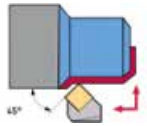
KITPSSNX
NEW
UTENSILE PER ESTERNO CON INSERTI

Art.	€	Utensili per esterno	Inserti	b	h	l
KITPSSNR16	€ 150,00	PSSNR16	SNMG120404F15 x 10 Pcs	16 mm	16 mm	100 mm
KITPSSNR20	€ 160,00	PSSNR20	SNMG120404F15 x 10 Pcs	20 mm	20 mm	125 mm
KITPSSNR25	€ 173,00	PSSNR25	SNMG120404F15 x 10 Pcs	25 mm	25 mm	150 mm

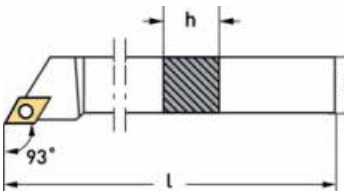
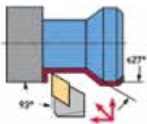
KITCKJ
NEW
UTENSILE PER ESTERNO CON INSERTI

Art.	€	Utensili per esterno	Inserti	b	h	l
KITCKJ16	€ 169,00	CKJNR16	KNUX160405RN x 10 Pcs	20 mm	16 mm	100 mm
KITCKJ20	€ 179,00	CKJNR20	KNUX160405RN x 10 Pcs	20 mm	20 mm	125 mm
KITCKJ25	€ 181,00	CKJNR25	KNUX160405RN x 10 Pcs	25 mm	25 mm	150 mm

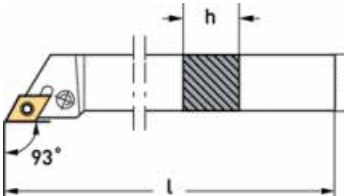
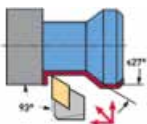
KITPDJNX
NEW
UTENSILE PER ESTERNO CON INSERTI

Art.	€	Utensili per esterno	Inserti	b	h	l
KITPDJNR20	€ 190,00	PDJNR20	DNMG150608N x 10 Pcs	20 mm	20 mm	125 mm
KITPDJNR25	€ 202,00	PDJNR25	DNMG150608N x 10 Pcs	25 mm	25 mm	150 mm

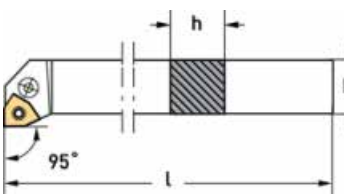
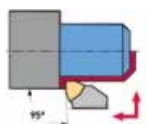
KITPWLNX
NEW
UTENSILE PER ESTERNO CON INSERTI

Art.	€	Utensili per esterno	Inserti	b	h	l
KITPWLNR20	€ 169,00	PWLNR20	WNMG080408N x 10 Pcs	20 mm	20 mm	125 mm
KITPWLNR25	€ 181,00	PWLNR25	WNMG080408N x 10 Pcs	25 mm	25 mm	150 mm



STGCX

UTENSILE PER ESTERNO 90°

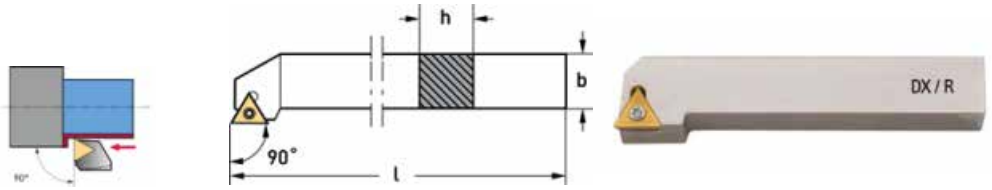

Art.	€	Lato	b	h	l	Vite	Bussola	Base	Insero (non incluso)
STGCR16/11	€ 46,00	Dx/R	16 mm	16 mm	100 mm	KV250	-----	-----	TCMT1102...
STGCL16/11	€ 46,00	Sx/L	16 mm	16 mm	100 mm	KV250	-----	-----	TCMT1102...
STGCR20	€ 52,00	Dx/R	20 mm	20 mm	125 mm	KV350	BU3550	BSTG16	TCMT16T3...
STGCL20	€ 52,00	Sx/L	20 mm	20 mm	125 mm	KV350	BU3550	BSTG16	TCMT16T3...
STGCR25	€ 63,80	Dx/R	25 mm	25 mm	150 mm	KV350	BU3550	BSTG16	TCMT16T3...
STGCL25	€ 63,80	Sx/L	25 mm	25 mm	150 mm	KV350	BU3550	BSTG16	TCMT16T3...

SCLCXE

UTENSILE PER ESTERNO 95°

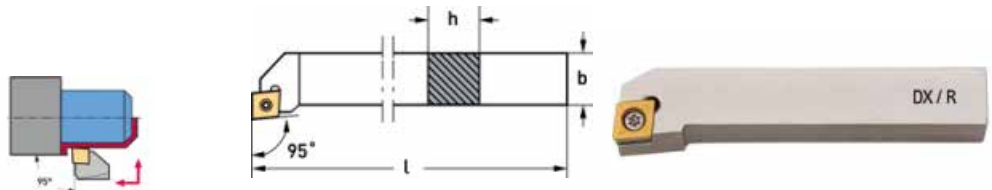

Art.	€	Lato	b	h	l	Vite	Bussola	Base	Insero (non incluso)
SCLCR12E	€ 39,40	Dx/R	12 mm	12 mm	80 mm	KV350	-----	-----	CCMT09T3...
SCLCL12E	€ 39,40	Sx/L	12 mm	12 mm	80 mm	KV350	-----	-----	CCMT09T3...
SCLCR16E	€ 47,60	Dx/R	16 mm	16 mm	100 mm	KV350	BU3550	BSCL09	CCMT09T3...
SCLCL16E	€ 47,60	Sx/L	16 mm	16 mm	100 mm	KV350	BU3550	BSCL09	CCMT09T3...
SCLCR20E	€ 53,20	Dx/R	20 mm	20 mm	125 mm	KV401	BU4560	BSCL12	CCMT1204...
SCLCL20E	€ 53,20	Sx/L	20 mm	20 mm	125 mm	KV401	BU4560	BSCL12	CCMT1204...
SCLCR25E	€ 63,80	Dx/R	25 mm	25 mm	150 mm	KV401	BU4560	BSCL12	CCMT1204...
SCLCL25E	€ 63,80	Sx/L	25 mm	25 mm	150 mm	KV401	BU4560	BSCL12	CCMT1204...

SSSCXE

UTENSILE PER ESTERNO 45°

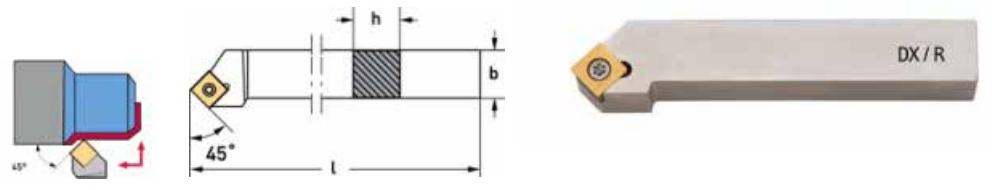

Art.	€	Lato	b	h	l	Vite	Bussola	Base	Insero (non incluso)
SSSCR20E	€ 52,00	Dx/R	20 mm	20 mm	125 mm	KV400	BU4560	BSSS12	SCMT1204...
SSSCL20E	€ 52,00	Sx/L	20 mm	20 mm	125 mm	KV400	BU4560	BSSS12	SCMT1204...
SSSCR25E	€ 67,00	Dx/R	25 mm	25 mm	150 mm	KV450	BU4560	BSSS12	SCMT1204...
SSSCL25E	€ 67,00	Sx/L	25 mm	25 mm	150 mm	KV450	BU4560	BSSS12	SCMT1204...

SVJBX

UTENSILE PER ESTERNO 93°

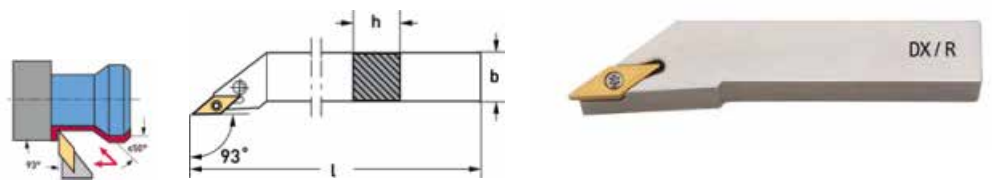

Art.	€	Lato	b	h	l	Vite	Bussola	Base	Insero (non incluso)
SVJBR20	€ 52,00	Dx/R	20 mm	20 mm	125 mm	KV350	BU3550	BSVJ16	VBMT1604...
SVJBL20	€ 52,00	Sx/L	20 mm	20 mm	125 mm	KV350	BU3550	BSVJ16	VBMT1604...
SVJBR25	€ 67,00	Dx/R	25 mm	25 mm	150 mm	KV350	BU3550	BSVJ16	VBMT1604...
SVJBL25	€ 67,00	Sx/L	25 mm	25 mm	150 mm	KV350	BU3550	BSVJ16	VBMT1604...

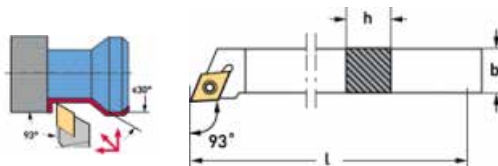
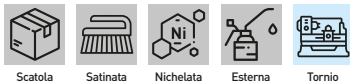
SDJCX
UTENSILE PER ESTERNO 93°

Art.	€	Lato	b	h	l	Vite	Bussola	Base	Inserto (non incluso)
SDJCR10	€ 29,90	Dx/R	10 mm	10 mm	70 mm	KV250	-----	-----	DCMT0702...
SDJCR12	€ 43,10	Dx/R	12 mm	12 mm	80 mm	KV250	-----	-----	DCMT0702...
SDJCR16	€ 49,60	Dx/R	16 mm	16 mm	100 mm	KV250	-----	-----	DCMT0702...
SDJCR20	€ 56,10	Dx/R	20 mm	20 mm	125 mm	KV350	BU3550	BSDJ11	DCMT11T3...
SDJCL20	€ 56,10	Sx/L	20 mm	20 mm	125 mm	KV350	BU3550	BSDJ11	DCMT11T3...
SDJCR25	€ 71,10	Dx/R	25 mm	25 mm	150 mm	KV350	BU3550	BSDJ11	DCMT11T3...
SDJCL25	€ 71,10	Sx/L	25 mm	25 mm	150 mm	KV350	BU3550	BSDJ11	DCMT11T3...

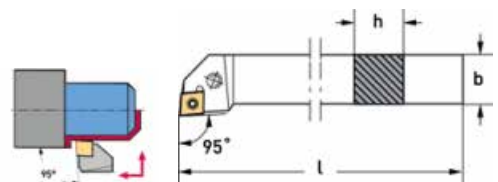
PCLNX
UTENSILE PER ESTERNO 95°

Art.	€	Lato	b	h	l	Ricambi	Inserto (non incluso)
PCLNR16	€ 43,20	Dx/R	16 mm	16 mm	100 mm	RICAPCLN	CNMG1204...
PCLNR20	€ 56,50	Dx/R	20 mm	20 mm	125 mm	RICAPCLN	CNMG1204...
PCLNL20	€ 56,50	Sx/L	20 mm	20 mm	125 mm	RICAPCLN	CNMG1204...
PCLNR25	€ 67,00	Dx/R	25 mm	25 mm	150 mm	RICAPCLN	CNMG1204...
PCLNL25	€ 67,00	Sx/L	25 mm	25 mm	150 mm	RICAPCLN	CNMG1204...

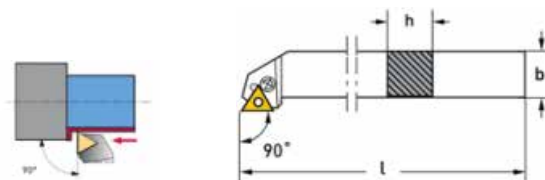
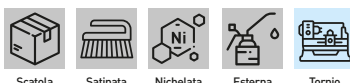
PTGNX
UTENSILE PER ESTERNO 90°

Art.	€	Lato	b	h	l	Ricambi	Inserto (non incluso)
PTGNR16	€ 43,20	Dx/R	16 mm	16 mm	100 mm	RICAPTGN	TNMG1604...
PTGNR20	€ 52,70	Dx/R	20 mm	20 mm	125 mm	RICAPTGN	TNMG1604...
PTGNL20	€ 52,70	Sx/L	20 mm	20 mm	125 mm	RICAPTGN	TNMG1604...
PTGNR25	€ 67,00	Dx/R	25 mm	25 mm	150 mm	RICAPTGN	TNMG1604...
PTGNL25	€ 67,00	Sx/L	25 mm	25 mm	150 mm	RICAPTGN	TNMG1604...

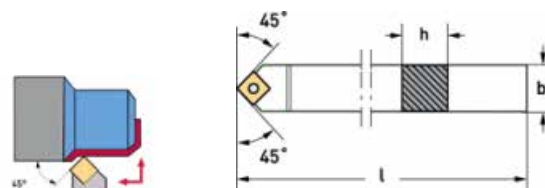
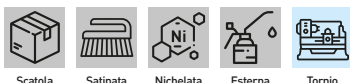
PSSNX
UTENSILE PER ESTERNO 45°

Art.	€	Lato	b	h	l	Ricambi	Inserto (non incluso)
PSSNR16	€ 43,20	Dx/R	16 mm	16 mm	100 mm	RICAPSSN	SNMG1204...
PSSNR20	€ 53,20	Dx/R	20 mm	20 mm	125 mm	RICAPSSN	SNMG1204...
PSSNL20	€ 53,20	Sx/L	20 mm	20 mm	125 mm	RICAPSSN	SNMG1204...
PSSNR25	€ 67,00	Dx/R	25 mm	25 mm	150 mm	RICAPSSN	SNMG1204...
PSSNL25	€ 67,00	Sx/L	25 mm	25 mm	150 mm	RICAPSSN	SNMG1204...



CKJNX

UTENSILE PER ESTERNO 93°

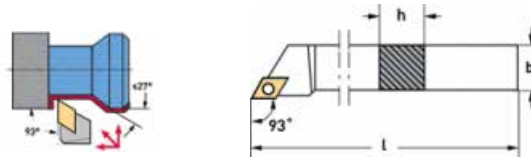

Art.	€	Lato	b	h	l	Staffa	Vite	Base	Inserto (non incluso)
CKJNL20	€ 63,80	Sx/L	20 mm	20 mm	125 mm	STAFCKJNL	VITECKJN	BASECKJNL	KNUX160405L...
CKJNL25	€ 74,10	Sx/L	25 mm	25 mm	150 mm	STAFCKJNL	VITECKJN	BASECKJNL	KNUX160405L...
CKJNR16	€ 52,70	Dx/R	20 mm	16 mm	100 mm	STAFCKJNR	VITECKJN	BASECKJNR	KNUX160405R...
CKJNR20	€ 63,80	Dx/R	20 mm	20 mm	125 mm	STAFCKJNR	VITECKJN	BASECKJNR	KNUX160405R...
CKJNR25	€ 74,10	Dx/R	25 mm	25 mm	150 mm	STAFCKJNR	VITECKJN	BASECKJNR	KNUX160405R...

PDJNX

UTENSILE PER ESTERNO 93°

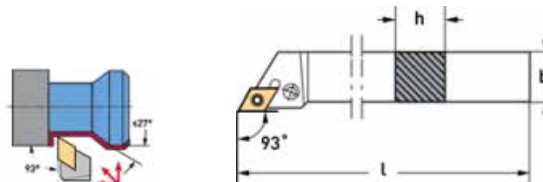

Art.	€	Lato	b	l	h	Ricambi	Inserto (non incluso)
PDJNR20	€ 54,60	Dx/R	20 mm	20 mm	125 mm	PDJNRKIT	DNMG1506...
PDJNR25	€ 67,00	Dx/R	25 mm	25 mm	150 mm	PDJNRKIT	DNMG1506...
PDJNL25	€ 67,00	Sx/L	25 mm	25 mm	150 mm	PDJNRKIT	DNMG1506...

PWLNx

UTENSILE PER ESTERNO 95°

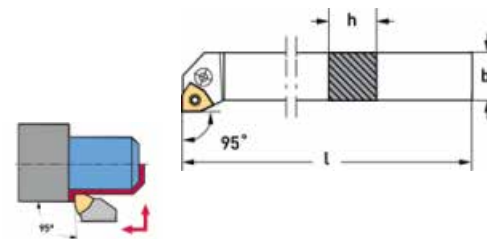

Art.	€	Lato	b	h	l	Ricambi	Inserto (non incluso)
PWLN20	€ 54,60	Dx/R	20 mm	20 mm	125 mm	PWLNKIT	WNMG0804...
PWLN25	€ 67,00	Dx/R	25 mm	25 mm	150 mm	PWLNKIT	WNMG0804...
PWLN25	€ 67,00	Sx/L	25 mm	25 mm	150 mm	PWLNKIT	WNMG0804...

G007-

PORTA GODRONI COMPLETO DI N° 3 COPPIE DI GODRONI, TAGLIO A DIAMANTE

A forma di rombo 45° per l'esecuzione di zigrinature per deformazione in tornitura. Dotato di 2 ruote di ricambio passo 0.8 mm.



Art.	€	Stelo	Passo
G007/16	€ 76,70	16 mm	0,8 - 1,2 - 1,8 mm
G007/20	€ 77,80	20 mm	0,8 - 1,2 - 1,8 mm

KISCLCR

€ 238,00

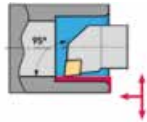
SET UTENSILI PER INTERNO 95°

Utensili per interno	SCLCR08; SCLCR10; SCLCR12; SCLCR16
Inserti	CCMT060204N x 10 Pz
Chiave torx	T7 x 2 Pz
Vite	T7 x 2,5 mm x 4 Pz

KISTCMT

€ 281,00

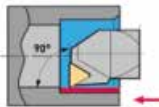
SET UTENSILI PER INTERNO 90°

Utensili per interno	STFCR08; STFCR10; STFCR12; STFCR16; STFCR20
Inserti	TCMT110204N x 10 Pz
Chiave torx	T8 x 2 Pz
Vite	T8 x 2,5 mm x 5 Pz

KISTFCR

€ 222,00

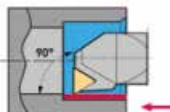
SET UTENSILI PER INTERNO BLOCCAGGIO A VITE 90°

Utensili per interno	STFCR08, STFCR10, STFCR12, STFCR16, STFCR20
Inserto (non incluso)	TCMT110204...
Chiave torx	T8 x 2 Pz
Vite	T8 x 2,5 mm x 5 Pz

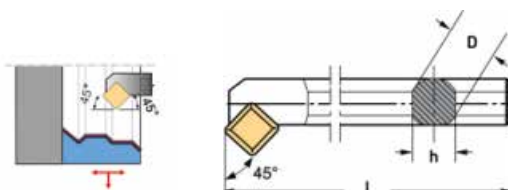
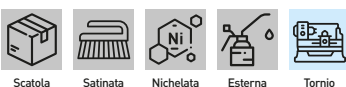
SSSCRX
UTENSILI PER INTERNO 45°

Art.	€	D	h	l	Vite	Inserto (non incluso)
SSSCR16	€ 51,10	16 mm	15 mm	200 mm	KV400	SCMT09T3...
SSSCR20	€ 56,90	20 mm	18 mm	250 mm	KV400	SCMT09T3...
SSSCR25	€ 67,00	25 mm	22.5 mm	300 mm	KV400	SCMT09T3...



SCLCX

UTENSILE PER INTERNO 95°

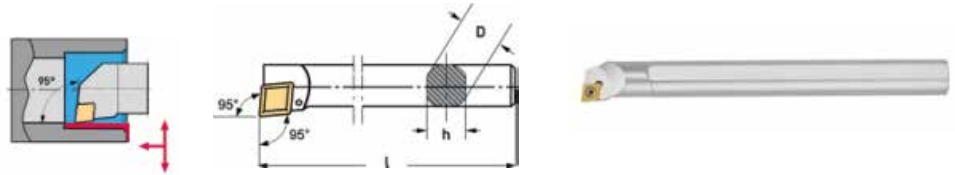

Art.	€	Lato	D	h	l	Vite	Inserto (non incluso)
SCLCR08	€ 60,60	Dx/R	8 mm	7 mm	125 mm	KV250	CCMT0602...
SCLCL08	€ 60,60	Sx/L	8 mm	7 mm	125 mm	KV250	CCMT0602...
SCLCR10	€ 60,60	Dx/R	10 mm	9 mm	140 mm	KV250	CCMT0602...
SCLCL10	€ 60,60	Sx/L	10 mm	9 mm	140 mm	KV250	CCMT0602...
SCLCR12	€ 60,60	Dx/R	12 mm	11 mm	160 mm	KV250	CCMT0602...
SCLCL12	€ 60,60	Sx/L	12 mm	11 mm	160 mm	KV250	CCMT0602...
SCLCR16	€ 68,70	Dx/R	16 mm	14,5 mm	180 mm	KV400	CCMT09T3...
SCLCL16	€ 68,70	Sx/L	16 mm	14,5 mm	180 mm	KV400	CCMT09T3...
SCLCR20	€ 68,70	Dx/R	20 mm	18 mm	200 mm	KV400	CCMT09T3...
SCLCL20	€ 68,70	Sx/L	20 mm	18 mm	200 mm	KV400	CCMT09T3...
SCLCR25	€ 76,70	Dx/R	25 mm	22,5 mm	250 mm	KV400	CCMT09T3...
SCLCL25	€ 76,70	Sx/L	25 mm	22,5 mm	250 mm	KV400	CCMT09T3...
SCLCR32	€ 108,00	Dx/R	32 mm	29 mm	300 mm	KV400	CCMT09T3...
SCLCL32	€ 108,00	Sx/L	32 mm	29 mm	300 mm	KV400	CCMT09T3...

STFCX

UTENSILE PER INTERNO 90°

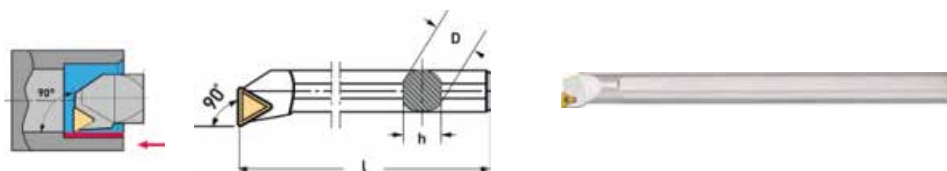
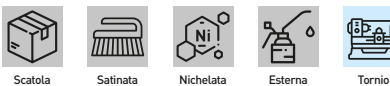

Art.	€	Lato	D	h	l	Vite	Inserto (non incluso)
STFCR08	€ 60,60	Dx/R	8 mm	7 mm	125 mm	KV250	TCMT1102...
STFCL08	€ 60,60	Sx/L	8 mm	7 mm	125 mm	KV250	TCMT1102...
STFCR10	€ 60,60	Dx/R	10 mm	9 mm	150 mm	KV250	TCMT1102...
STFCL10	€ 60,60	Sx/L	10 mm	9 mm	150 mm	KV250	TCMT1102...
STFCR12	€ 60,60	Dx/R	12 mm	11 mm	150 mm	KV250	TCMT1102...
STFCL12	€ 60,60	Sx/L	12 mm	11 mm	150 mm	KV250	TCMT1102...
STFCR16	€ 68,70	Dx/R	16 mm	14,5 mm	200 mm	KV250	TCMT1102...
STFCL16	€ 68,70	Sx/L	16 mm	14,5 mm	200 mm	KV250	TCMT1102...
STFCR20	€ 68,70	Dx/R	20 mm	18,5 mm	250 mm	KV250	TCMT1102...
STFCL20	€ 68,70	Sx/L	20 mm	18,5 mm	200 mm	KV250	TCMT1102...
STFCR25	€ 76,70	Dx/R	25 mm	22,5 mm	250 mm	KV350	TCMT16T3...
STFCL25	€ 76,70	Sx/L	25 mm	22,5 mm	250 mm	KV350	TCMT16T3...
STFCR32	€ 108,00	Dx/R	32 mm	29 mm	300 mm	KV350	TCMT16T3...
STFCL32	€ 108,00	Sx/L	32 mm	29 mm	300 mm	KV350	TCMT16T3...

SDUCX

UTENSILE PER INTERNO 93°

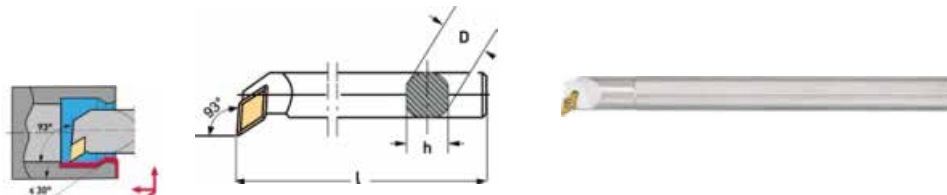
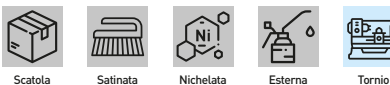

Art.	€	Lato	D	h	l	Vite	Inserto (non incluso)
SDUCR10	€ 60,60	Dx/R	10 mm	9 mm	140 mm	KV250	DCMT0702...
SDUCL10	€ 60,60	Sx/L	10 mm	9 mm	140 mm	KV250	DCMT0702...
SDUCR12	€ 60,60	Dx/R	12 mm	11 mm	160 mm	KV250	DCMT0702...
SDUCL12	€ 60,60	Sx/L	12 mm	11 mm	160 mm	KV250	DCMT0702...
SDUCR16	€ 68,70	Dx/R	16 mm	15 mm	180 mm	KV250	DCMT0702...
SDUCL16	€ 68,70	Sx/L	16 mm	15 mm	180 mm	KV250	DCMT0702...
SDUCR20	€ 68,70	Dx/R	20 mm	18 mm	200 mm	KV350	DCMT11T3...
SDUCL20	€ 68,70	Sx/L	20 mm	18 mm	200 mm	KV350	DCMT11T3...
SDUCR25	€ 76,70	Dx/R	25 mm	23 mm	250 mm	KV350	DCMT11T3...
SDUCL25	€ 76,70	Sx/L	25 mm	23 mm	250 mm	KV350	DCMT11T3...
SDUCR32	€ 108,00	Dx/R	32 mm	30 mm	300 mm	KV350	DCMT11T3...
SDUCL32	€ 108,00	Sx/L	32 mm	30 mm	300 mm	KV350	DCMT11T3...

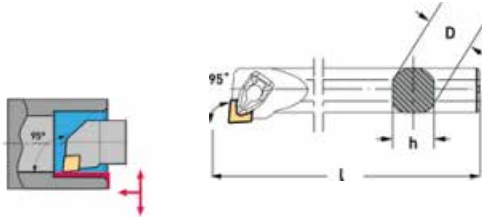
MCLNX
UTENSILE PER INTERNO 95°

Art.	€	Lato	D	h	l	Staffa	Base	Inserto (non incluso)
MCLNR16	€ 78,90	Dx/R	16 mm	15 mm	210 mm	CTMTMC16/20	-----	CNMG1204...
MCLNL16	€ 78,90	Sx/L	16 mm	15 mm	210 mm	CTMTMC16/20	-----	CNMG1204...
MCLNR20	€ 86,90	Dx/R	20 mm	18 mm	255 mm	CTMTMC16/20	-----	CNMG1204...
MCLNL20	€ 86,90	Sx/L	20 mm	18 mm	255 mm	CTMTMC16/20	-----	CNMG1204...
MCLNR25	€ 110,00	Dx/R	25 mm	23 mm	300 mm	CTMTMC25/32	MCLNBASE25/32	CNMG1204...
MCLNL25	€ 110,00	Sx/L	25 mm	23 mm	300 mm	CTMTMC25/32	MCLNBASE25/32	CNMG1204...
MCLNR32	€ 134,00	Dx/R	32 mm	30 mm	355 mm	CTMTMC25/32	MCLNBASE25/32	CNMG1204...
MCLNL32	€ 134,00	Sx/L	32 mm	30 mm	355 mm	CTMTMC25/32	MCLNBASE25/32	CNMG1204...

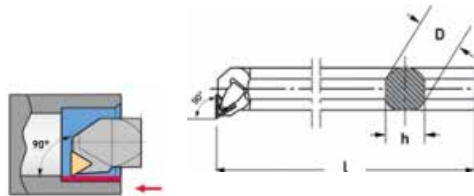
MTFNX
UTENSILE PER INTERNO 90°

Art.	€	Lato	D	h	l	Staffa	Base	Inserto (non incluso)
MTFNR16	€ 77,80	Dx/R	16 mm	15 mm	210 mm	CTMTMC16/20	-----	TNMG1604...
MTFNL16	€ 77,80	Sx/L	16 mm	15 mm	210 mm	CTMTMC16/20	-----	TNMG1604...
MTFNR20	€ 86,90	Dx/R	20 mm	18 mm	255 mm	CTMTMC16/20	-----	TNMG1604...
MTFNL20	€ 86,90	Sx/L	20 mm	18 mm	255 mm	CTMTMC16/20	-----	TNMG1604...
MTFNR25	€ 110,00	Dx/R	25 mm	23 mm	300 mm	CTMTMC25/32	MTFNBASE25/32	TNMG1604...
MTFNL25	€ 110,00	Sx/L	25 mm	23 mm	300 mm	CTMTMC25/32	MTFNBASE25/32	TNMG1604...
MTFNR32	€ 134,00	Dx/R	32 mm	30 mm	355 mm	CTMTMC25/32	MTFNBASE25/32	TNMG1604...
MTFNL32	€ 134,00	Sx/L	32 mm	30 mm	355 mm	CTMTMC25/32	MTFNBASE25/32	TNMG1604...

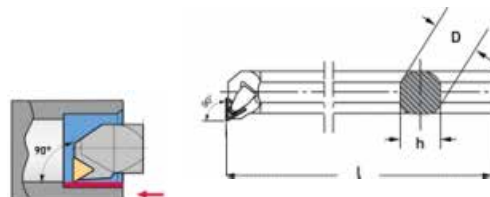
CTFPX
UTENSILE PER INTERNO 90°

Art.	€	Lato	D	h	l	Staffa	Base	Inserto (non incluso)
CTFPR12	€ 66,40	Dx/R	12 mm	11 mm	150 mm	CTFP10/12	-----	TPMR1103...
CTFPL12	€ 66,40	Sx/L	12 mm	11 mm	150 mm	CTFP10/12	-----	TPMR1103...
CTFPR16	€ 76,70	Dx/R	16 mm	15 mm	210 mm	CTMTMC16/20	-----	TPMR1103...
CTFPL16	€ 76,70	Sx/L	16 mm	15 mm	210 mm	CTMTMC16/20	-----	TPMR1103...
CTFPR20	€ 86,90	Dx/R	20 mm	18 mm	255 mm	CTMTMC16/20	-----	TPMR1603...
CTFPL20	€ 86,90	Sx/L	20 mm	18 mm	255 mm	CTMTMC16/20	-----	TPMR1603...
CTFPR25	€ 107,00	Dx/R	25 mm	23 mm	300 mm	CTMTMC25/32	CTFPBASE25/32	TPMR1603...
CTFPL25	€ 107,00	Sx/L	25 mm	23 mm	300 mm	CTMTMC25/32	CTFPBASE25/32	TPMR1603...
CTFPR32	€ 134,00	Dx/R	32 mm	30 mm	355 mm	CTMTMC25/32	CTFPBASE25/32	TPMR1603...
CTFPL32	€ 134,00	Sx/L	32 mm	30 mm	355 mm	CTMTMC25/32	CTFPBASE25/32	TPMR1603...



CKUNR

UTENSILE PER INTERNO 93°

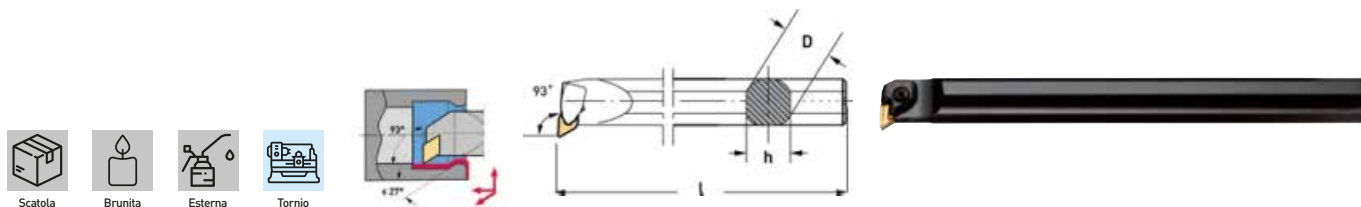

Art.	€	Lato	D	h	l	Staffa	Vite	Base	Inserto (non incluso)
CKUNR25	€ 175,00	Dx/R	25 mm	23 mm	300 mm	STAFCKJNR	VITECKJN	BASECKJNR	KNUX1604...
CKUNR32	€ 200,00	Dx/R	32 mm	30 mm	350 mm	STAFCKJNR	VITECKJN	BASECKJNR	KNUX1604...
CKUNR40	€ 210,00	Dx/R	40 mm	37 mm	400 mm	STAFCKJNR	VITECKJN	BASECKJNR	KNUX1604...

KISER

KIT FILETTATURA PER ESTERNO

Composto dall'utensile per filettatura esterna (1 Pz), vite di ricambio M3.5 X 12 mm (1 Pz), chiave esagonale 2,5 mm (1 Pz), chiave torx T15 (1 Pz) ed inserti assortiti: AG55 - AG60; - ISO 0,8 - 1,00 - 1,25 - 1,50 - 1,75 - 2,00 - 2,50 - 3,00 mm (1 Pz ciascuno).

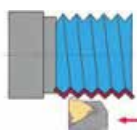

Art.	€	Utensili per esterno	Inserto	Chiave torx	Vite	b	l	h
KISER	€ 188,00	SER20	16ER...	T15	M3,5 x 12 mm	20 mm	20 mm	125 mm
KISER25	€ 247,00	SER25	16ER...	T15	M3,5 x 12 mm	25 mm	25 mm	150 mm

KISNR

KIT FILETTATURA PER INTERNO

Composto dall'utensile per filettatura interna (1 Pz), vite di ricambio M3.5 X 12 mm (1 Pz), chiave esagonale 2,5 mm (1 Pz), chiave torx T15 (1 Pz) ed inserti assortiti: AG55 - AG60; - ISO 0,8 - 1,00 - 1,25 - 1,50 - 1,75 - 2,00 - 2,50 - 3,00 mm (1 Pz ciascuno).

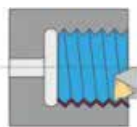

Art.	€	Utensili per interno	Inserto	Chiave torx	Vite	D	h	l
KISNR	€ 216,00	SNR20	16IR...	T15	M3,5 x 12 mm	20 mm	18 mm	200 mm
KISNR25	€ 258,00	SNR25	16IR...	T15	M3,5 x 12 mm	25 mm	23 mm	200 mm

KICAN

€ 242,00

SET PER CANALINI ESTERNI ED INTERNI

Composto dall'utensile per canalini esterni: 20 x 20 mm (1 Pz), l'utensile per canalini interni: ø 20 mm (1 Pz), vite di ricambio M4 x 12 mm (2 Pz), chiave torx: T15 (1 Pz) ed inserti per scanalatura 16 mm rivestiti al TIN: 165110134 (2 Pz), 165130134 (2 Pz), 165160134 (2 Pz), 165185134 (1 Pz), 165215134 (1 Pz), 165265134 (1 Pz), 165315134 (1 Pz).

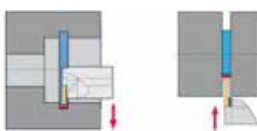



SERX

UTENSILE FILETTARE ESTERNO FISSAGGIO A VITE

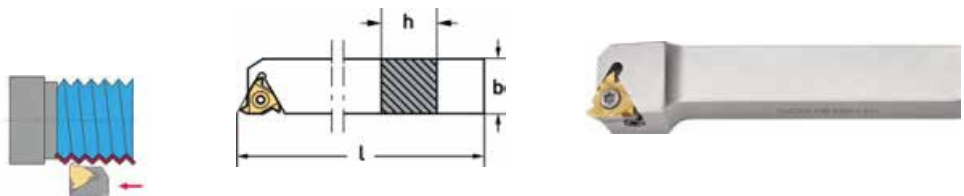

Art.	€	b	h	l	Base	Bussola	Vite	Inserto (non incluso)
SER16	€ 57,50	16 mm	16 mm	100 mm	-----	-----	KV350	16ER...
SER20	€ 73,90	20 mm	20 mm	125 mm	BSER16	BU3550	KV350	16ER...
SER25	€ 85,40	25 mm	25 mm	150 mm	BSER16	BU3550	KV350	16ER...

SNRX

UTENSILE FILETTARE INTERNO FISSAGGIO A VITE

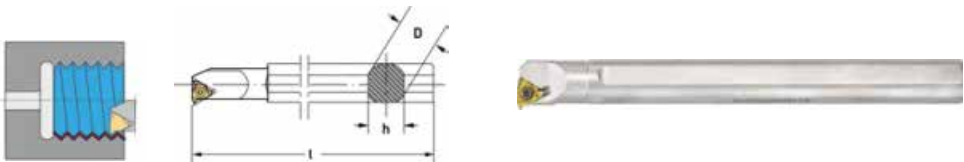

Art.	€	D	h	l	Base	Vite	Bussola	Inserto (non incluso)
SNR12	€ 57,50	12 mm	11 mm	150 mm	-----	KV250	-----	11IR...
SNR16	€ 67,10	16 mm	15 mm	170 mm	-----	KV350	-----	16IR...
SNR20	€ 81,30	20 mm	18 mm	200 mm	BSNR16	KV350	BU3550	16IR...
SNR25	€ 101,00	25 mm	23 mm	300 mm	BSNR16	KV350	BU3550	16IR...

T088

€ 104,00

SET DA TAGLIO

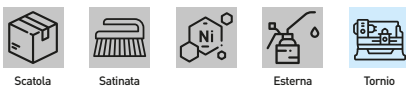
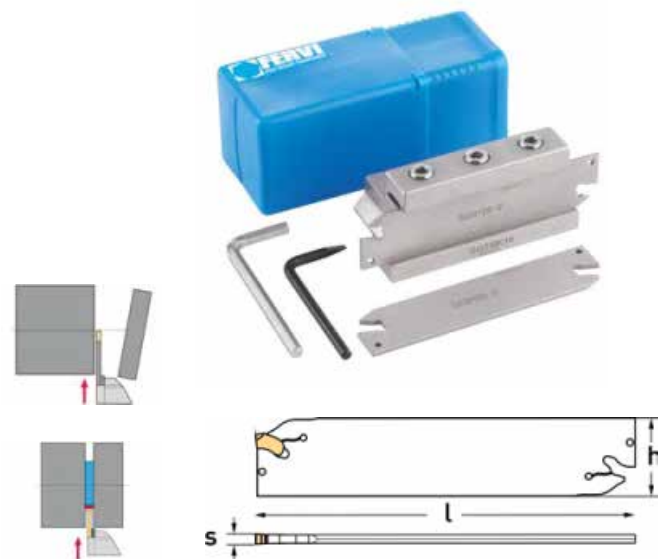

Contenuto del set	1 Pz SGTBK16 - 1 Pz SGIH26/2 - 1 Pz SGIH26/3
S	2 - 3 mm
h	25.75 mm
l	109 mm
Inserto (non incluso)	GCMX2N - GCMX3N

T089

€ 72,80

SET DA TAGLIO

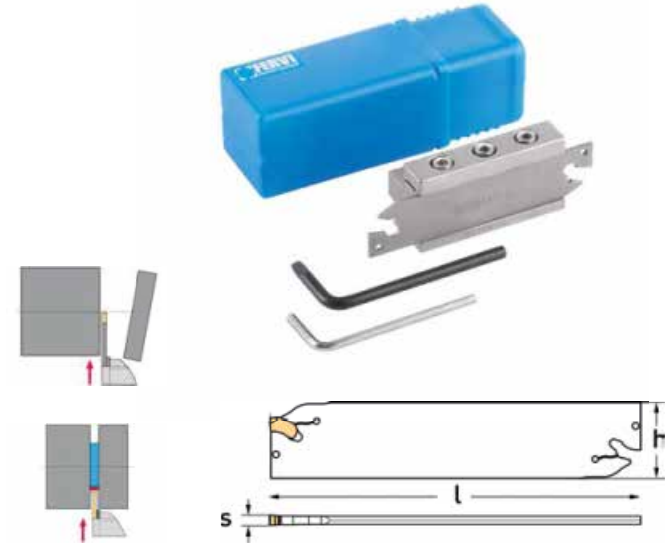

Contenuto del set	1 Pz SGIH19/2 - 1 Pz SGTBK10
S	2 mm
h	19.5 mm
l	85 mm
Inserto (non incluso)	GCMX2N



T09X

SET DA TAGLIO

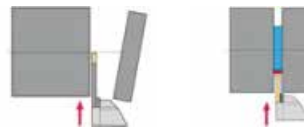

Art.	€	Contenuto del set	S	h	l	Inserto (non incluso)
T090	€ 171,00	1 Pz SGIH32/3 - 1 Pz SGIH32/4 - 1 Pz SGIH32/5 - 1 Pz SGTBK25	3 - 4 - 5 mm	31,75 mm	150 - 160 mm	GCMX3N - GCMX4N - GCMX5N
T091	€ 125,00	1 Pz SGIH26/2 - 1 Pz SGIH26/3 - 1 Pz SGTBK20	2 - 3 mm	25,75 mm	109 mm	GCMX2N - GCMX3N

SGIH

UTENSILE PER TAGLIO ESTERNO - LAMA

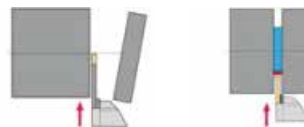
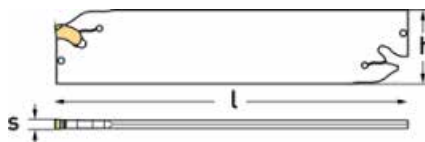

Art.	€	S	h	l	Inserto (non incluso)
SGIH26/2	€ 34,70	2 mm	25.75 mm	109 mm	GCMX2N...
SGIH26/3	€ 34,70	3 mm	25.75 mm	109 mm	GCMX3N...
SGIH32/3	€ 34,70	3 mm	31.75 mm	150 mm	GCMX3N...
SGIH32/4	€ 34,70	4 mm	31 mm	150 mm	GCMX4N...
SGIH32/5	€ 34,70	5 mm	31.75 mm	150 mm	GCMX5N...
SGIH19/2	€ 27,80	2 mm	19.5 mm	85 mm	GCMX2N...

SGTBK

UTENSILE PER TAGLIO ESTERNO - BLOCCO PORTA LAMA



Art.	€	Stelo	Dimensioni	Lama
SGTBK10	€ 46,00	10 x 10 mm	56 x 25 x 30 mm	19 mm
SGTBK16	€ 49,90	16 x 16 mm	87 x 38 x 33 mm	26 mm
SGTBK20	€ 54,90	20 x 20 mm	100 x 38 x 45h mm	26 mm
SGTBK25	€ 68,60	25 x 25 mm	110 x 49 x 48h mm	32 mm

TIPOLOGIA UTENSILI FRESATURA FERVI

Fresatura di spallamenti

Fresatura che genera 2 facce contemporaneamente ottenendo uno spallamento di 90°.

Spianatura

Fresatura che permette di rendere piana una superficie grezza.

Fresatura ad alti avanzamenti

Fresatura di spianatura con utensili che permettono alte velocità di avanzamento (fino a 4 mm/dente).

Copiatura

Combinazione di fresatura discorde e concorde, richiede molti impegni e disimpegni sfavorevoli nel taglio.

Fresatura di Cave

Fresatura per l'esecuzione di una cava o una sede.

Smussatura

Fresatura per l'esecuzione di smussi su fori o contornature.

PRINCIPALI FORMULE FRESATURA

- $V_t = (D_{cap} \times n \times \pi) \div 1000$
- $n = (V_t \times 1000) \div (\pi \times D_{cap})$
- $F_z = V_f \div (n \times Z_c)$
- $V_f = F_z \times n \times Z_c$

LEGENDA

D_{cap} : Diametro di taglio alla profondità di taglio effettiva a_p (mm)
 F_z : Avanzamento per dente (mm/dente)
 Z_c : Numero di denti effettivi della fresa
 V_f : Avanzamento tavola (mm/min)
 F_n : Avanzamento per giro (mm/giro)
 a_p : Profondità di taglio (mm)
 V_t : Velocità di taglio (m/min)
 n : Velocità di rotazione mandrino (mm/min)
 π : il suo valore è di 3.14





TIPOLOGIA UTENSILI FRESATURA FERVI

FRESA 90°

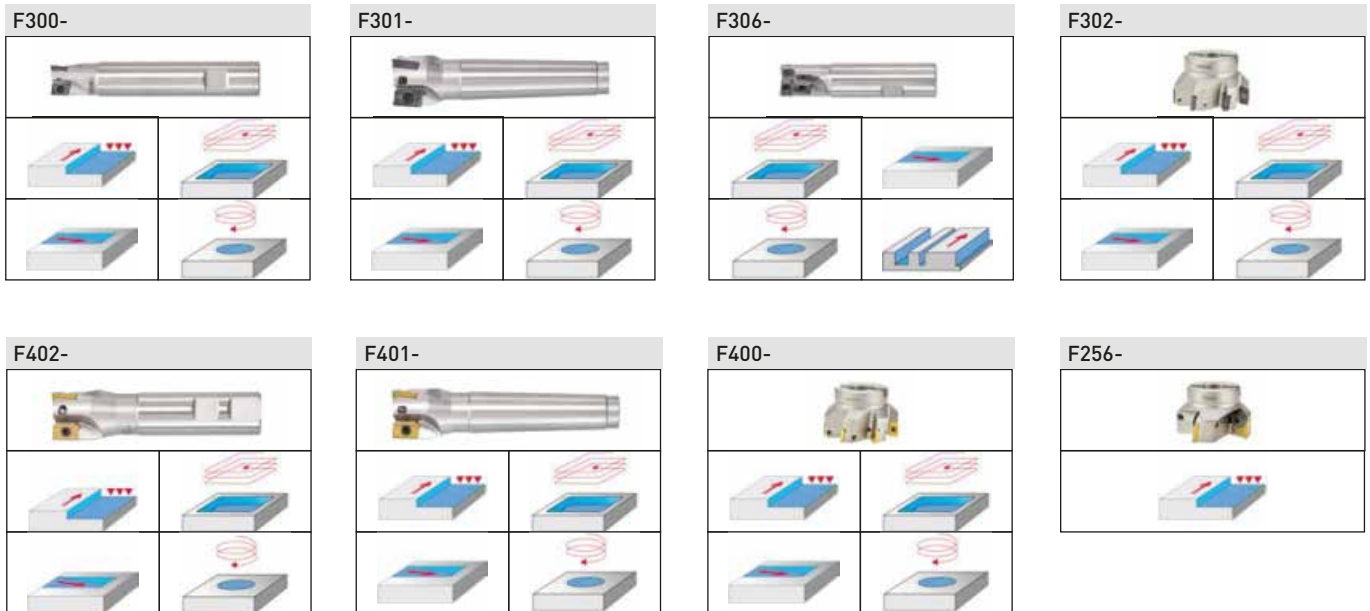

FRESA 45°

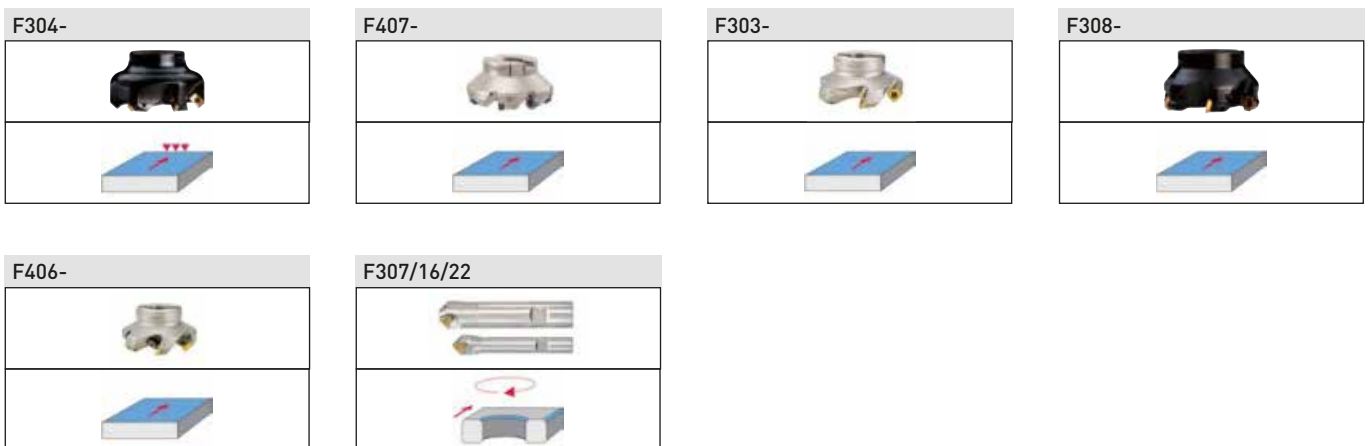

FRESA PER CONTORNATURA E SPIANATURA INSERTO TONDO

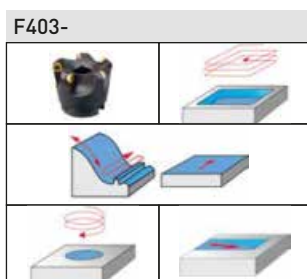

F300-
FRESA A INSERTO

Con codolo cilindrico.

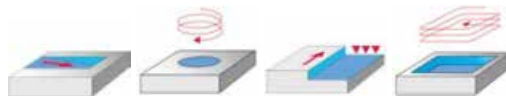
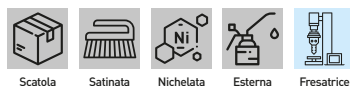

Art.	€	D	d	Z	L1	L2	Viti	Inserto (non incluso)
F300/12	€ 39,40	12 mm	12 mm	1	27 mm	120 mm	KV250	APKT1003...
F300/14	€ 39,40	14 mm	12 mm	1	27 mm	120 mm	KV250	APKT1003...
F300/16	€ 46,80	16 mm	16 mm	2	27 mm	120 mm	KV250	APKT1003...
F300/18	€ 52,20	18 mm	16 mm	2	27 mm	120 mm	KV250	APKT1003...
F300/20	€ 56,00	20 mm	20 mm	3	27 mm	120 mm	KV250	APKT1003...
F300/22	€ 56,00	22 mm	20 mm	3	27 mm	120 mm	KV250	APKT1003...
F300/25	€ 67,00	25 mm	20 mm	4	27 mm	120 mm	KV250	APKT1003...
F300/25/16	€ 67,00	25 mm	20 mm	2	44 mm	120 mm	KV400	APKT1604...
F300/25/16L	€ 77,90	25 mm	20 mm	2	44 mm	200 mm	KV400	APKT1604...
F300/32/16	€ 77,90	32 mm	25 mm	3	50 mm	120 mm	KV400	APKT1604...
F300/32/16L	€ 108,00	32 mm	32 mm	3	55 mm	200 mm	KV400	APKT1604...

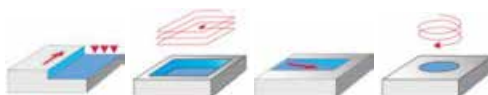
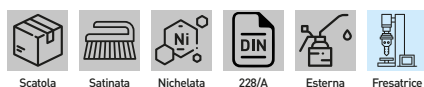
F301-
FRESA A INSERTO

Art.	€	D	CM	Z	L1	L2	Viti	Inserto (non incluso)
F301/25	€ 69,40	25 mm	3	2	40 mm	125 mm	KV400	APKT1604...
F301/32	€ 74,10	32 mm	3	3	40 mm	125 mm	KV400	APKT1604...
F301/40	€ 94,60	40 mm	3	4	35 mm	125 mm	KV400	APKT1604...
F301/32CM4	€ 94,60	32 mm	4	3	45 mm	150 mm	KV400	APKT1604...
F301/40CM4	€ 101,00	40 mm	4	4	40 mm	150 mm	KV400	APKT1604...

F306-
FRESA A INSERTO

Con taglio frontale forante per esecuzione di cave, con attacco cilindrico. Permette di realizzare cave dal pieno.

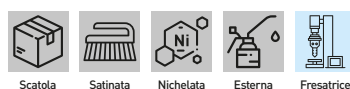

Art.	€	D	d	Z	L1	L2	Viti	Inserto (non incluso)
F306/20	€ 86,40	20 mm	20 mm	3	18 mm	90 mm	KV250	APKT1003...
F306/25	€ 105,00	25 mm	25 mm	3	18 mm	100 mm	KV250	APKT1003...

F302-
FRESA A INSERTO

Con attacco a manicotto.

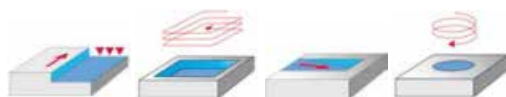

Art.	€	D	L	d	Z	Viti	Inserto (non incluso)
F302/040	€ 152,00	40 mm	40 mm	16 mm	4	KV400	APKT1604...
F302/050	€ 158,00	50 mm	45 mm	22 mm	4	KV400	APKT1604...
F302/063	€ 166,00	63 mm	50 mm	22 mm	6	KV400	APKT1604...
F302/080	€ 196,00	80 mm	50 mm	27 mm	7	KV400	APKT1604...
F302/100	€ 244,00	100 mm	50 mm	32 mm	8	KV400	APKT1604...



F304-

FRESA PER RECUPERO INSERTO

Con attacco a manicotto.

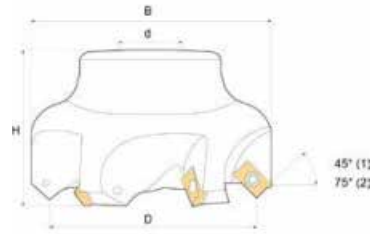

Art.	€	D	H	B	d	Z	Viti	Inserto (non incluso)
F304/063	€ 281,00	63 mm	42 mm	71.2 mm	22 mm	6	KV250	APKT1003...
F304/080	€ 228,00	80 mm	47 mm	84 mm	27 mm	5	KV400	APKT1604...

F402-

FRESA PER SPALLAMENTI

Con codolo cilindrico.

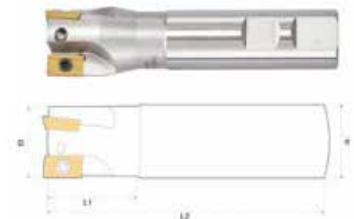

Art.	€	D	d	Z	L1	L2	Viti	Inserto (non incluso)
F402/25	€ 56,50	25 mm	20 mm	2	35 mm	110 mm	KV400	ADLT1503...
F402/32	€ 71,10	32 mm	25 mm	3	35 mm	120 mm	KV400	ADLT1503...
F402/25L	€ 77,00	25 mm	25 mm	2	35 mm	200 mm	KV400	ADLT1503...
F402/32L	€ 98,70	32 mm	25 mm	3	35 mm	200 mm	KV400	ADLT1503...

F401-

FRESA PER SPALLAMENTI



Art.	€	D	CM	Z	L1	L2	Viti	Inserto (non incluso)
F401/25	€ 68,30	25 mm	3	2	44 mm	130 mm	KV400	ADLT1503...
F401/32	€ 83,40	32 mm	3	3	44 mm	130 mm	KV400	ADLT1503...
F401/40	€ 91,40	40 mm	3	4	44 mm	130 mm	KV400	ADLT1503...
F401/40CM4	€ 107,00	40 mm	4	4	44 mm	153 mm	KV400	ADLT1503...

F400-

FRESA PER SPALLAMENTI

Con attacco a manicotto, consigliato l'utilizzo su macchine con potenze medie

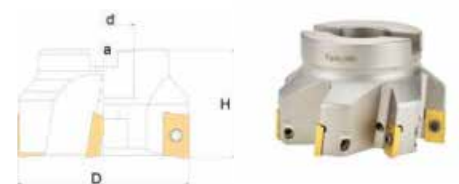

Art.	€	D	H	a	d	Z	Viti	Inserto (non incluso)
F400/040	€ 97,90	40 mm	40 mm	8,4 mm	16 mm	4	KV400	ADLT1503...
F400/050	€ 131,00	50 mm	40 mm	10,4 mm	22 mm	5	KV400	ADLT1503...
F400/063	€ 150,00	63 mm	40 mm	10,4 mm	22 mm	6	KV400	ADLT1503...
F400/080	€ 192,00	80 mm	50 mm	12,4 mm	27 mm	7	KV400	ADLT1503...
F400/100	€ 236,00	100 mm	50 mm	14,4 mm	32 mm	8	KV400	ADLT1503...

F256-
FRESA PER SPALLAMENTI

Con attacco a manicotto, consigliato l'utilizzo su macchine con potenze medie.

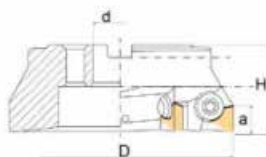

Art.	€	D	H	a	d	Z	Vite	Inserto (non incluso)
F256/040	€ 154,00	40 mm	40 mm	16 mm	16 mm	3	F256/644	TPKN1603...
F256/050	€ 159,00	50 mm	40 mm	16 mm	22 mm	3	F256/644	TPKN1603...
F256/063	€ 172,00	63 mm	40 mm	16 mm	22 mm	3	F256/644	TPKN1603...
F256/080	€ 176,00	80 mm	50 mm	22 mm	27 mm	4	F256/648	TPKN2204...
F256/100	€ 228,00	100 mm	50 mm	22 mm	32 mm	5	F256/648	TPKN2204...

F407-
FRESA A INSERTI NEGATIVI PER SPIANATURA

Con attacco a manicotto, consigliato l'utilizzo su macchine con potenze medio/alte.

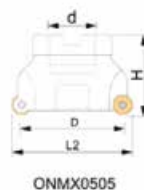

Art.	€	D	H	L2	d	Z	Viti	Inserto (non incluso)
F407/050	€ 129,00	50	40	63	22	4	KV401	ONMX1205... - SNMX1205...
F407/100	€ 258,00	100	50	113	32	8	KV401	ONMX1205... - SNMX1205...

F303-
FRESA A INSERTO

Con attacco a manicotto, consigliato l'utilizzo su macchine con potenze medie.

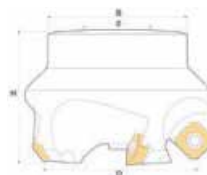

Art.	€	D	H	B	d	Z	Viti	Inserto (non incluso)
F303/040	€ 121,00	40 mm	45 mm	53 mm	16 mm	3	KV500	SEHX1204... / SEHT1204...
F303/050	€ 135,00	50 mm	48 mm	60 mm	22 mm	4	KV500	SEHX1204... / SEHT1204...
F303/063	€ 159,00	63 mm	50 mm	76 mm	22 mm	5	KV500	SEHX1204... / SEHT1204...
F303/080	€ 190,00	80 mm	50 mm	93 mm	27 mm	5	KV500	SEHX1204... / SEHT1204...
F303/100	€ 224,00	100 mm	50 mm	113 mm	32 mm	6	KV500	SEHX1204... / SEHT1204...
F303/125	€ 329,00	125 mm	60 mm	138 mm	40 mm	7	KV500	SEHX1204... / SEHT1204...

F308-
FRESA A INSERTI PER SPIANATURA

Con attacco a manicotto, grazie alla geometria molto positiva si ottengono ottime superfici lavorate.

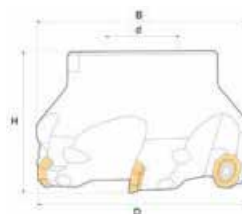

Art.	€	D	H	L2	d	Z	Viti	Inserto (non incluso)
F308/063	€ 226,00	63 mm	40 mm	68 mm	22 mm	5	KV400	OFEX05T3...
F308/080	€ 291,00	80 mm	50 mm	86 mm	27 mm	6	KV400	OFEX05T3...
F308/100	€ 371,00	100 mm	50 mm	106 mm	32 mm	7	KV400	OFEX05T3...



F406-

FRESA PER SPIANATURA

Con attacco a manicotto, consigliato l'utilizzo su macchine con potenze ridotte.

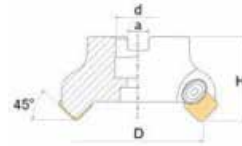
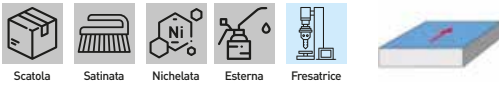

Art.	€	D	H	a	d	Z	Vite	Sottopiacchetta	Inserto (non incluso)
F406/40	€ 154,00	40 mm	48 mm	8,4 mm	16 mm	3	VT00440	WSSP	SEKN1203...
F406/50	€ 161,00	50 mm	48 mm	10,4 mm	22 mm	4	VT00440	WSSP	SEKN1203...
F406/63	€ 172,00	63 mm	48 mm	12,4 mm	22 mm	5	VT00440	WSSP	SEKN1203...
F406/80	€ 198,00	80 mm	50 mm	14,4 mm	27 mm	5	VT00440	WSSP	SEKN1203...
F406/100	€ 255,00	100 mm	50 mm	16,4 mm	32 mm	6	VT00440	WSSP	SEKN1203...

F307/16/22

€ 154,00

SERIE SVASATORI A INSERTO

Con codolo cilindrico, per lavorazioni di sbavatura di fori, asole e tasche, per la fresatura di bordi piastra.



D	16 / 22 mm
d	12 / 20 mm
L1	7 mm
L2	90 / 100 mm
Z	1 / 2
Viti	KV250
Inserto (non incluso)	TCMT1102

F403-

FRESA PER SPIANATURA

Con attacco a manicotto.

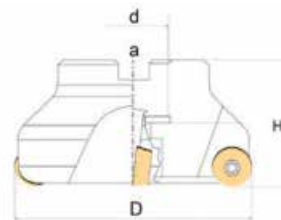
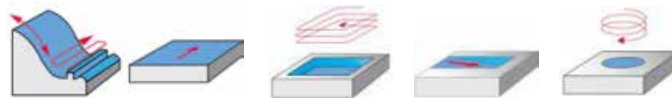

Art.	€	D	H	a	d	Z	Viti	Inserto (non incluso)
F403/40	€ 105,00	40 mm	40 mm	8,4 mm	16 mm	3	KV400	RPMT1204...
F403/50	€ 135,00	50 mm	40 mm	10,4 mm	22 mm	4	KV400	RPMT1204...
F403/63	€ 163,00	63 mm	40 mm	10,4 mm	22 mm	5	KV400	RPMT1204...
F403/80	€ 192,00	80 mm	50 mm	12,4 mm	27 mm	6	KV400	RPMT1204...
F403/100	€ 228,00	100 mm	50 mm	14,4 mm	32 mm	6	KV400	RPMT1204...



BSTG16 € 25,80
SET 5 BASI 16
MM



BU3550 € 25,80
SET 5
BUSSOLE



BSCL09 € 25,80
SET 5 BASI 9
MM



BSCL12 € 25,80
SET 5 BASI 12
MM

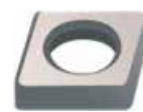

BU4560 € 25,80
SET 5
BUSSOLE



BSSS12 € 25,80
5 BASI
QUADRATE 12
MM



BSVJ16 € 25,80
SET 5 BASI 16
MM

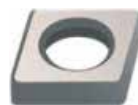

BSDJ11 € 28,90
5 BASI
ROMBOIDALI
11 MM

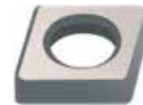

BU4050 € 28,40
SET 5
BUSSOLE



RICAPCLN € 17,40
STAFFA BASE
VITE



RICAPTGN € 16,20
SET BASE
STAFFA VITE



RICAPSSN € 17,40
STAFFA BASE
STAFFA VITE



STAFCKJNR € 20,50
STAFFA
UTENSILE DX



STAFCKJNL € 20,50
STAFFA
UTENSILE SX



BASECKJNR € 11,90
BASE
UTENSILE DX



BASECKJNL € 11,90
BASE
UTENSILE SX



VITECKJN € 4,81
VITE UTENSILE



PDJNRKIT € 20,00
KIT RICAMBI



PWLNRRKIT € 16,70
SET BASE
STAFFA VITE



MCLNBASE25/32 € 20,30
BASE



CTMTMC16/20 € 25,00
STAFFA DI
RICAMBIO PER
16 - 20



CTMTMC25/32 € 25,00
STAFFA DI
RICAMBIO PER
25 - 32



MTFNBASE25/32 € 17,20
BASE



CTFP10/12 € 25,00
STAFFA



CTFPBASE25/32 € 17,20
BASE
Di ricambio per
25 - 32.



BSER16 € 34,10
SET 5 BASI
TRIANGOLARI
16 MM



VT00440 € 21,80
5 VITI PER
FRESA



BSNR16 € 34,10
SET 5 BASI
16 mm.



F256/648 € 13,10
VITI FRESA
080/125



KVX
SET 10 VITI



F256/644 € 7,40
VITI FRESA
040/063



WSSP € 8,90
SOTTOPLACCHETTA



Art.	€	Vite
KV200	€ 21,40	T8 / M2
KV250	€ 21,40	T8 / M2,5
KV300	€ 21,40	T15 / M3
KV350	€ 21,40	T15 / M3,5
KV400	€ 21,40	T15 / M4
KV401	€ 21,40	T20 / M4
KV450	€ 21,40	T15 / M4,5
KV500	€ 21,40	T20 / M5

IDENTIFICAZIONE INSERTI TORNITURA E FRESATURA

C	N	M	G	12	04	08
1	2	3	4	5	6	7

1 - Forma dell'inserto

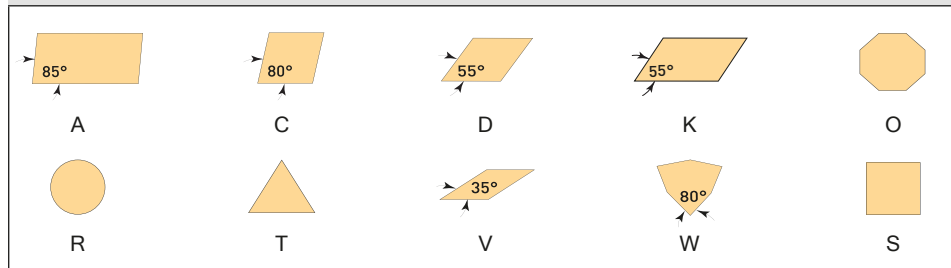

2 - Spoglia inferiore

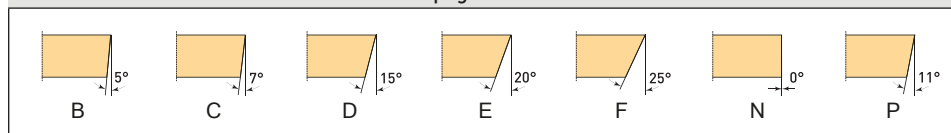

4 - Tipo inserto

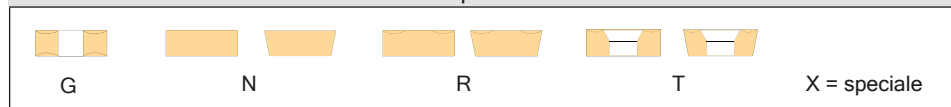

5 - Lunghezza tagliente

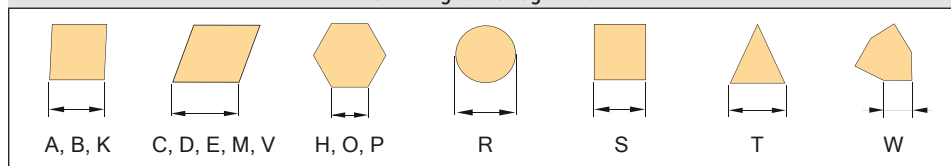

7 - Raggio

	04	r 0,4
	08	r 0,8
	12	r 1,2
	10	r 1,0

3 - Tolleranza

	m	s	d
E	0,025	0,025	0,025
H	0,013	0,025	0,013
L	0,025	0,025	0,05 - 0,13
K	0,013	0,025	0,05 - 0,13
M	0,08	0,13	0,05 - 0,13
U	0,13 - 0,38	0,13 - 0,13	0,08 - 0,25

6 - Spessore

02	2,38 mm		
03	3,18 mm		
T3	3,97 mm		
04	4,76 mm		
05	5,56 mm		
06	6,35 mm		

CLASSIFICAZIONE ISO MATERIALI

ISO P ACCIAIO	ISO M ACCIAIO INOX	ISO K GHISA
Acciaio al piombo e da cementazione bonifica e da costruzione	Acciai ferritici Cr, austenitici, martensitici Cr, acciai duplex	Ghisa grigia, temprata, sferoidale, ghisa CGI, ferro sinterizzato

CARATTERISTICHE DEI GRADI DEGLI INSERTI

Grado	Rivest.	Condizione di lavoro	Refrigerante	
N	CVD	Stabile/Normale	X	
134	PVD	Stabile/Normale		X
234	PVD	Stabile/Normale		X
25	PVD	Stabile		X
20A	PVD	Stabile/Normale	X	X
F15	CVD	Stabile	X	X
F25	CVD	Stabile/Normale	X	X
M25	CVD	Stabile/Normale	X	X
M35	CVD	Normale/Interrotto	X	X

	Descrizione
	Rivestimento
CVD	Sono caratterizzati da un'elevata resistenza all'usura e un'eccellente adesione al metallo duro. Nella tornitura generale sono applicati negli acciai inossidabili e nei campi ISO P,M,K.
PVD	Aumentano la resistenza all'usura grazie alla loro durezza. Le loro tensioni di compressione contribuiscono ad aumentare la tenacità del tagliente e la resistenza alla formazione di cricche a pettine.
Condizione di lavoro	
Stabile	Tipologia di taglio in cui l'inserto ha una condizione di lavoro omogenea.
Normale	Tipologia di taglio in cui l'inserto può avere una condizione di interruzione/ripresa di taglio.
Interrotto	Tipologia di taglio in cui l'inserto avrà durante la lavorazione varie interruzioni/ripresе di taglio.

IDENTIFICAZIONE INSERTI PER FILETTATURA

16	E	R	175	ISO
A1	A2	A3	A4	A5

A3 - Direzione di taglio	
R	Destro
L	Sinistro

A5 - Profilo filetto	
ISO	Filetto Metrico 60°
W	Filettatura Whitworth 55°
AG60	Profilo 60° (Filettatura Libera) 0,5 - 3 mm
AG55	Profilo 55° (Filettatura Libera) 28 - 11 TPI

A1 - Lunghezza tagliente	
l	d
11	6,35
16	9,525
22	12,7

A2 - Filettatura	
E	I
Esterna	Interna

A4 - Passo filetto	
mm	Filetti/Pollice
$\frac{A4}{100}$ (0,5 - 3 mm)	(28 - 11 TPI)

GUIDA ALLA SCELTA DELL'INSERTO

Tipo inserto	Materiali			Campo di utilizzo			Tipo lavorazione	
	P	M	K	Finitura	Media	Sgrossatura	Tornitura	Fresatura
CCMTx	●	●	○	✓			✓	
CCMTxA	●	○	○	✓			✓	
CNMGx	●	●	○	✓	✓		✓	
CNMGxF15	●	●	○	✓			✓	
CNMGxF25	○	●	○	✓			✓	
CNMGxM25	●	●	○		✓		✓	
CNMGxM35	○	●	○		✓		✓	
DCMTx	●	●	○	✓			✓	
DCMTxA	●	●	○	✓			✓	
DNMGx	●	●	○		✓		✓	
DNMGxM25	●	●	○		✓		✓	
DNMGxM35	○	●	○		✓		✓	
KNUx	●	●	○	✓			✓	
SCMTx	●	●	○	✓			✓	
SCMTxA1	●	●	○	✓			✓	
SCMTxA2	●	●	○	✓	✓		✓	
SCMTxA3	●	●	○	✓	✓		✓	
SNMGxF15	●	●	○	✓			✓	
SNMGxF25	○	●	○	✓			✓	
SNMGxM25	●	●	○		✓		✓	
SNMGxM35	○	●	○		✓		✓	
SPMRx	●	●	○	✓			✓	
TCMTx	●	●	○	✓	✓		✓	
TCMTxA	●	○	○	✓			✓	
WNMGx	●	●	○		✓		✓	
WNMGxM25	●	●	○		✓		✓	
WNMGxM35	○	●	○		✓		✓	



Tipo inserto	Materiali			Campo di utilizzo			Tipo lavorazione	
	P	M	K	Finitura	Media	Sgrossatura	Tornitura	Fresatura
TNMGx	●	●	○	✓			✓	
TNMGxF15	●	●	○	✓			✓	
TNMGxF25	●	●	○	✓			✓	
TNMGxM25	●	●	○		✓		✓	
TNMGxM35	○	●	○		✓		✓	
TPMRx	●	●	○	✓			✓	
VBMTx	○	●	○	✓			✓	
VBMTxA	●	●	○	✓	✓		✓	
ADLTx	●	●	○		✓	✓		✓
ADLTxA	●	●	○		✓	✓		✓
ADLTxA1	●	●	○		✓	✓		✓
APKTx	○	●	○		✓			✓
OFEXx	●	●	○	✓	✓			✓
OFEXxA	●	●	○	✓	✓			✓
ONMXxA	●	●	○	✓	✓			✓
RDHTx	●	●	○		✓	✓		✓
RPMTx	●	●	○		✓	✓		✓
SEHTx	●	●	○	✓	✓			✓
SEHTxA	○	●	○	✓	✓			✓
SEKNx	●	●	○		✓	✓		✓
SEHXx	○	●	○		✓	✓		✓
SEHXxA	●	○	○		✓	✓		✓
SNMXx	●	●	○	✓	✓			✓
SPKNx	●	○	○		✓	✓		✓
TPKNx	●	○	○		✓	✓		✓
GCMX	●	●	○				✓	
GCMXA	●	●	○				✓	

Legenda

- Applicazione Consigliata
- Applicazione Possibile
- ✓ Campo di applicazione consigliato

CCMTX
INSERTI PER TORNITURA

Positiva.

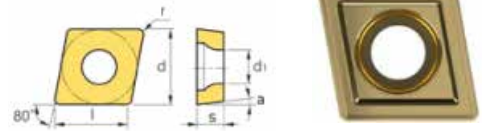

Art.	€	Dimensioni	d	l	S	r	d1	a°	Pack
CCMT060204N	€ 7,60	6 mm	6.35 mm	6.30 mm	2.38 mm	0.40 mm	2.80 mm	7°	10
CCMT09T304N	€ 8,70	9 mm	9.52 mm	9.70 mm	3.97 mm	0.40 mm	4.40 mm	7°	10
CCMT09T308N	€ 8,70	9 mm	9.52 mm	9.70 mm	3.97 mm	0.80 mm	4.40 mm	7°	10
CCMT120408N	€ 11,60	12 mm	12.70 mm	12.90 mm	4.76 mm	0.80 mm	5.50 mm	7°	10

CCMTXA
INSERTI PER TORNITURA

Positiva.

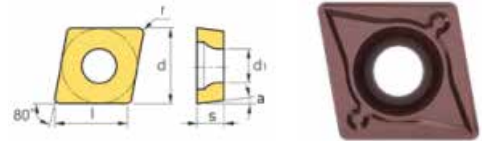

Art.	€	Dimensioni	d	l	S	r	d1	a°	Pack
CCMT06020420A	€ 7,90	6 mm	6.35 mm	6.30 mm	2.38 mm	0.40 mm	2.80 mm	7°	10
CCMT09T30420A	€ 9,20	9 mm	9.52 mm	9.70 mm	3.97 mm	0.40 mm	4.40 mm	7°	10
CCMT09T30820A	€ 9,20	9 mm	9.52 mm	9.70 mm	3.97 mm	0.80 mm	4.40 mm	7°	10
CCMT12040820A	€ 12,10	12 mm	12.70 mm	12.90 mm	4.76 mm	0.80 mm	5.50 mm	7°	10

CNMGX
INSERTI PER TORNITURA

Negativa.

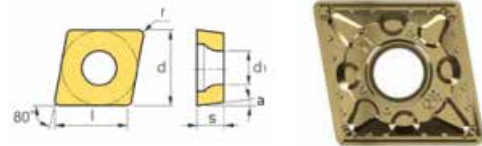
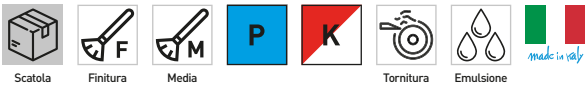

Art.	€	Dimensioni	d	l	S	r	d1	a°	Pack
CNMG120404N	€ 9,70	12 mm	12.70 mm	12.90 mm	4.76 mm	0.40 mm	5.16 mm	-	10
CNMG120408N	€ 9,70	12 mm	12.70 mm	12.90 mm	4.76 mm	0.80 mm	5.16 mm	-	10

CNMGXF15
INSERTO PER TORNITURA

Negativa.

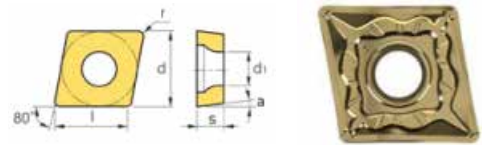

Art.	€	Dimensioni	d	l	S	r	d1	a°	Pack
CNMG120404F15	€ 10,20	12 mm	12.70 mm	12.90 mm	4.76 mm	0.40 mm	5.16 mm	-	10

CNMGXF25
INSERTO PER TORNITURA

Negativa.

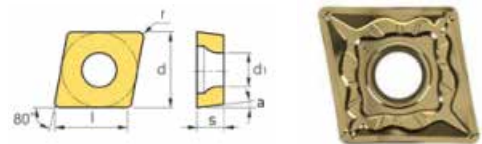

Art.	€	Dimensioni	d	l	S	r	d1	a°	Pack
CNMG120404F25	€ 10,20	12 mm	12.70 mm	12.90 mm	4.76 mm	0.40 mm	5.16 mm	-	10



CNMGXM25

INSERTO PER TORNITURA

Negativa.

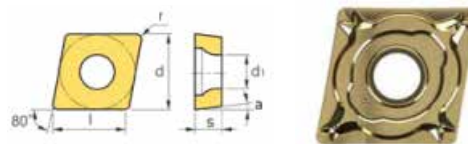

Art.	€	Dimensioni	d	l	S	r	d1	a°	Pack
CNMG120408M25	€ 10,20	12 mm	12.70 mm	12.90 mm	4.76 mm	0.80 mm	5.16 mm	-	10

CNMGXM35

INSERTO PER TORNITURA

Negativa.

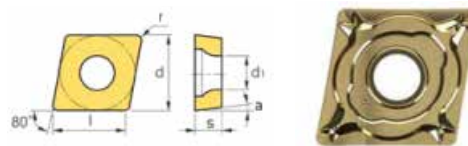

Art.	€	Dimensioni	d	l	S	r	d1	a°	Pack
CNMG120408M35	€ 10,20	12 mm	12.70 mm	12.90 mm	4.76 mm	0.80 mm	5.16 mm	-	10

DCMTX

INSERTI PER TORNITURA

Positiva.

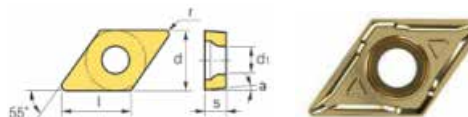

Art.	€	Dimensioni	d	l	S	r	d1	a°	Pack
DCMT070204N	€ 7,60	7 mm	6.35 mm	7.70 mm	2.38 mm	0.40 mm	2.80 mm	7°	10
DCMT11T304N	€ 10,00	11 mm	9.52 mm	11.60 mm	3.97 mm	0.40 mm	2.20 mm	7°	10

DCMTXA

INSERTO PER TORNITURA

Positiva.

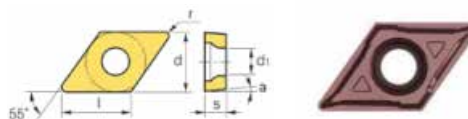

Art.	€	Dimensioni	d	l	S	r	d1	a°	Pack
DCMT07020420A	€ 7,90	7 mm	6.35 mm	7.70 mm	2.38 mm	0.40 mm	2.80 mm	7°	10
DCMT11T30420A	€ 10,40	11 mm	9.52 mm	11.60 mm	3.97 mm	0.40 mm	2.20 mm	7°	10

DNMGX

INSERTI PER TORNITURA

Negativa.

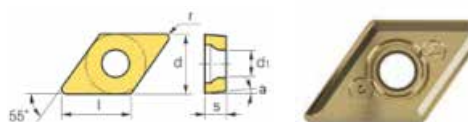

Art.	€	Dimensioni	d	l	S	r	d1	a°	Pack
DNMG150608N	€ 14,50	15 mm	12.70 mm	15.50 mm	6.35 mm	0.80 mm	5.20 mm	-	10

DNMGXM25
INSERTO PER TORNITURA

Negativa.

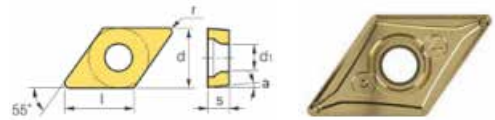

Art.	€	Dimensioni	d	l	S	r	d1	a°	Pack
DNMG150608M25	€ 15,40	15 mm	12.70 mm	15.50 mm	6.35 mm	0.80 mm	5.20 mm	-	10

DNMGXM35
INSERTO PER TORNITURA

Negativa.

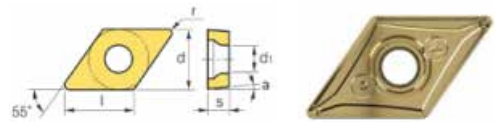

Art.	€	Dimensioni	d	l	S	r	d1	a°	Pack
DNMG150608M35	€ 15,40	15 mm	12.70 mm	15.50 mm	6.35 mm	0.80 mm	5.20 mm	-	10

KNUX
INSERTI PER TORNITURA

Positiva.

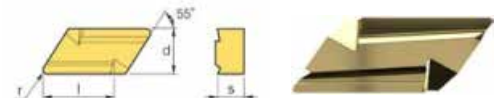

Art.	€	Dimensioni	d	l	S	r	a°	Pack
KNUX160405RN	€ 12,40	16 mm	9.52 mm	19.72 mm	4.76 mm	0.50 mm	-	10
KNUX160410RN	€ 12,40	16 mm	9.52 mm	19.72 mm	4.76 mm	1.00 mm	-	10
KNUX160405LN	€ 12,40	16 mm	9.52 mm	19.72 mm	4.76 mm	0.50 mm	-	10
KNUX160410LN	€ 12,40	16 mm	9.52 mm	19.72 mm	4.76 mm	1.00 mm	-	10

SCMTX
INSERTI PER TORNITURA

Positiva.

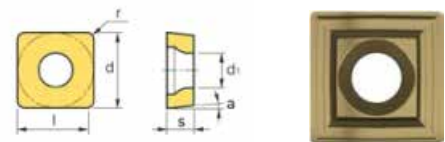

Art.	€	Dimensioni	d	l	S	r	d1	a°	Pack
SCMT09T304N	€ 8,80	9 mm	9.52 mm	9.52 mm	3.97 mm	0.40 mm	4.40 mm	7°	10
SCMT09T308N	€ 8,80	9 mm	9.52 mm	9.52 mm	3.97 mm	0.80 mm	4.40 mm	7°	10
SCMT120408N	€ 12,30	12 mm	12.70 mm	12.70 mm	4.76 mm	0.80 mm	5.50 mm	7°	10

SCMTXA1
INSERTO PER TORNITURA

Positiva.

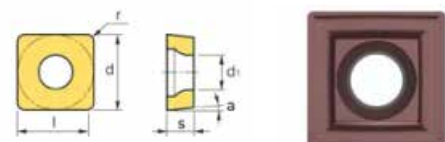

Art.	€	Dimensioni	d	l	S	r	d1	a°	Pack
SCMT09T30420A	€ 9,30	9 mm	9.52 mm	9.52 mm	3.97 mm	0.40 mm	4.40 mm	7°	10



SCMTXA2

INSERTO PER TORNITURA

Positiva.

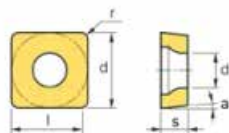

Art.	€	Dimensioni	d	l	S	r	d1	a°	Pack
SCMT09T30820A	€ 9,30	9 mm	9.52 mm	9.52 mm	3.97 mm	0.80 mm	4.40 mm	7°	10

SCMTXA3

INSERTO PER TORNITURA

Positiva.

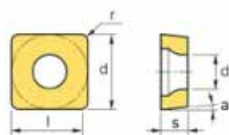

Art.	€	Dimensioni	d	l	S	r	d1	a°	Pack
SCMT12040820A	€ 12,80	12 mm	12.70 mm	12.70 mm	4.76 mm	0.80 mm	5.50 mm	7°	10

SNMGXF15

INSERTO PER TORNITURA

Negativa.

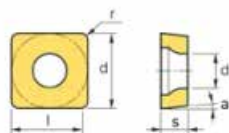

Art.	€	Dimensioni	d	l	S	r	d1	a°	Pack
SNMG120404F15	€ 11,40	12 mm	12.70 mm	12.70 mm	4.76 mm	0.40 mm	5.16 mm	-	10

SNMGXF25

INSERTO PER TORNITURA

Negativa.

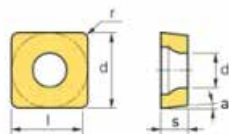

Art.	€	Dimensioni	d	l	S	r	d1	a°	Pack
SNMG120404F25	€ 11,40	12 mm	12.70 mm	12.70 mm	4.76 mm	0.40 mm	5.16 mm	-	10

SNMGXM25

INSERTO PER TORNITURA

Negativa.

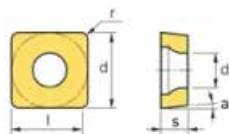

Art.	€	Dimensioni	d	l	S	r	d1	a°	Pack
SNMG120408M25	€ 11,40	12 mm	12.70 mm	12.70 mm	4.76 mm	0.80 mm	5.16 mm	-	10

SNMGXM35
INSERTO PER TORNITURA

Negativa.

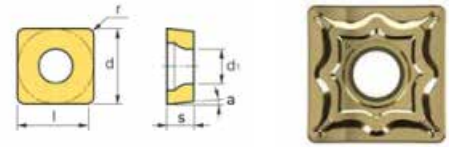

Art.	€	Dimensioni	d	l	S	r	d1	a°	Pack
SNMG120408M35	€ 11,40	12 mm	12.70 mm	12.70 mm	4.76 mm	0.80 mm	5.16 mm	-	10

SPMRX
INSERTI PER TORNITURA

Positiva.

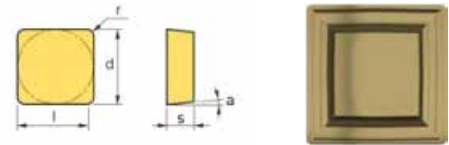

Art.	€	Dimensioni	d	l	S	r	a°	Pack
SPMR120304N	€ 10,10	12 mm	12.70 mm	12.70 mm	3.18 mm	0.40 mm	11°	10
SPMR120308N	€ 10,10	12 mm	12.70 mm	12.70 mm	3.18 mm	0.80 mm	11°	10

TCMTX
INSERTI PER TORNITURA

Positiva.

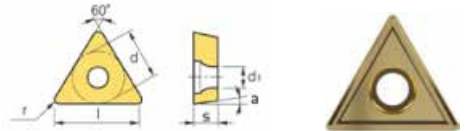

Art.	€	Dimensioni	d	l	S	r	d1	a°	Pack
TCMT090204N	€ 7,40	9 mm	3.40 mm	9.63 mm	2.38 mm	0.40 mm	2.50 mm	7°	10
TCMT110204N	€ 7,70	11 mm	6.35 mm	11.00 mm	2.38 mm	0.40 mm	2.80 mm	7°	10
TCMT16T304N	€ 9,80	16 mm	9.52 mm	16.50 mm	3.97 mm	0.40 mm	4.40 mm	7°	10
TCMT16T308N	€ 9,80	16 mm	9.52 mm	16.50 mm	3.97 mm	0.80 mm	4.40 mm	7°	10

TCMTXA
INSERTO PER TORNITURA

Positiva.

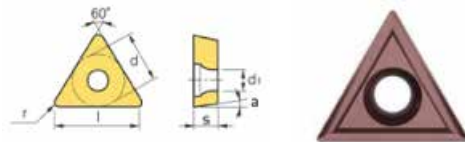

Art.	€	Dimensioni	d	l	S	r	d1	a°	Pack
TCMT09020420A	€ 7,80	9 mm	3.40 mm	9.63 mm	2.38 mm	0.40 mm	2.50 mm	7°	10
TCMT11020420A	€ 8,10	11 mm	6.35 mm	11.00 mm	2.38 mm	0.40 mm	2.80 mm	7°	10
TCMT16T30420A	€ 10,30	16 mm	9.52 mm	16.50 mm	3.97 mm	0.40 mm	4.40 mm	7°	10
TCMT16T30820A	€ 10,30	16 mm	9.52 mm	16.50 mm	3.97 mm	0.80 mm	4.40 mm	7°	10

WNMGX
INSERTI PER TORNITURA

Negativa.

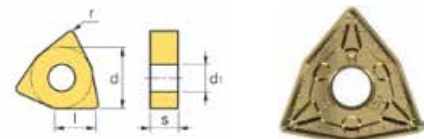

Art.	€	Dimensioni	d	l	S	r	d1	a°	Pack
WNMG080408N	€ 12,30	8 mm	12.70 mm	8.70 mm	4.76 mm	0.80 mm	5.10 mm	-	10



WNMGXM25

INSERTO PER TORNITURA

Negativa.

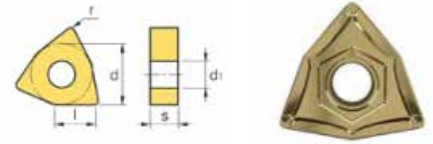

Art.	€	Dimensioni	d	l	S	r	d1	a°	Pack
WNMG080408M25	€ 12,80	8 mm	12.70 mm	8.70 mm	4.76 mm	0.80 mm	5.10 mm	-	10

WNMGXM35

INSERTO PER TORNITURA

Negativa.

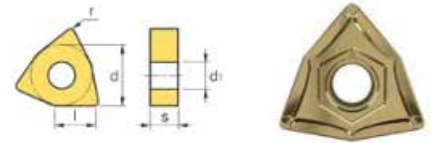

Art.	€	Dimensioni	d	l	S	r	d1	a°	Pack
WNMG080408M35	€ 12,80	8 mm	12.70 mm	8.70 mm	4.76 mm	0.80 mm	5.10 mm	-	10

TNMGX

INSERTI PER TORNITURA

Negativa.

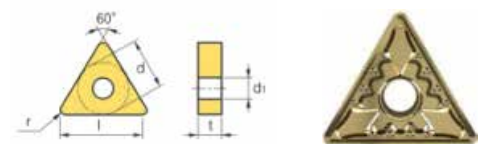

Art.	€	Dimensioni	d	l	S	r	d1	a°	Pack
TNMG160404N	€ 10,40	16 mm	9.52 mm	16.50 mm	4.76 mm	0.40 mm	3.81 mm	-	10
TNMG160408N	€ 10,40	16 mm	9.52 mm	16.50 mm	4.76 mm	0.80 mm	3.81 mm	-	10
TNMG220408N	€ 11,60	22 mm	12.70 mm	18.25 mm	4.76 mm	0.80 mm	5.16 mm	-	10

TNMGXF15

INSERTO PER TORNITURA

Negativa.

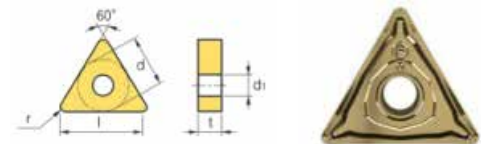

Art.	€	Dimensioni	d	l	S	r	d1	a°	Pack
TNMG160404F15	€ 11,00	16 mm	9.52 mm	16.50 mm	4.76 mm	0.40 mm	3.81 mm	-	10

TNMGXF25

INSERTO PER TORNITURA

Negativa.

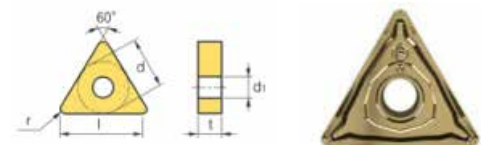

Art.	€	Dimensioni	d	l	S	r	d1	a°	Pack
TNMG160404F25	€ 11,00	16 mm	9.52 mm	16.50 mm	4.76 mm	0.40 mm	3.81 mm	-	10

TNMGXM25
INSERTO PER TORNITURA

Negativa.

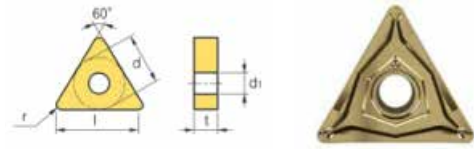

Art.	€	Dimensioni	d	l	S	r	d1	a°	Pack
TNMG160408M25	€ 11,00	16 mm	9.52 mm	16.50 mm	4.76 mm	0.80 mm	3.81 mm	-	10

TNMGXM35
INSERTO PER TORNITURA

Negativa.

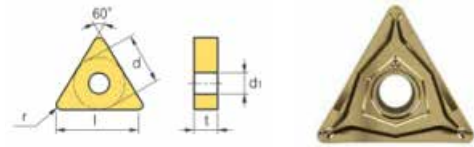

Art.	€	Dimensioni	d	l	S	r	d1	a°	Pack
TNMG160408M35	€ 11,00	16 mm	9.52 mm	16.50 mm	4.76 mm	0.80 mm	3.81 mm	-	10

TPMRX
INSERTI PER TORNITURA

Positiva.



Art.	€	Dimensioni	d	l	S	r	a°	Pack
TPMR110304N	€ 7,90	11 mm	5.98 mm	10.37 mm	3.18 mm	0.40 mm	11°	10
TPMR110308N	€ 8,90	11 mm	5.98 mm	10.37 mm	3.18 mm	0.80 mm	11°	10
TPMR160304N	€ 9,20	16 mm	9.23 mm	16 mm	3.18 mm	0.40 mm	11°	10
TPMR160308N	€ 9,20	16 mm	9.23 mm	16 mm	3.18 mm	0.80 mm	11°	10

VBMTX
INSERTI PER TORNITURA

Positiva.

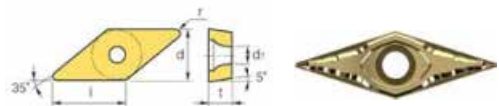

Art.	€	Dimensioni	d	l	S	r	d1	a°	Pack
VBMT160404N	€ 14,10	16 mm	9.52 mm	16.60 mm	4.76 mm	0.40 mm	4.40 mm	5°	10

VBMTXA
INSERTO PER TORNITURA

Positiva

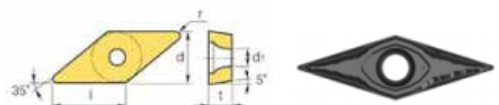

Art.	€	Dimensioni	d	l	S	r	d1	a°	Pack
VBMT16040420A	€ 14,90	16 mm	9.52 mm	16.60 mm	4.76 mm	0.40 mm	4.40 mm	5°	10



ADLTXA

INSERTI PER FRESATURA

90°.

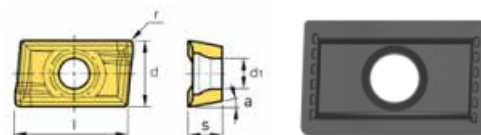

Art.	€	Dimensioni	d	l	S	r	d1	a°	Pack
ADLT150308R20A	€ 10,80	15 mm	9.52 mm	14.5 mm	3.18 mm	0.80 mm	4.50 mm	15°	10

ADLTX

INSERTI PER FRESATURA

90°.

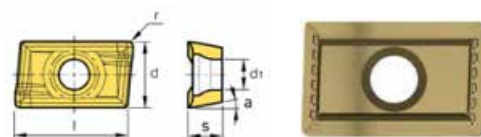

Art.	€	Dimensioni	d	l	S	r	d1	a°	Pack
ADLT1503ZZR234	€ 9,50	15 mm	9.52 mm	14.50 mm	3.18 mm	0.80 mm	4.50 mm	15°	10

ADLTXA1

INSERTO PER FRESATURA

90°.

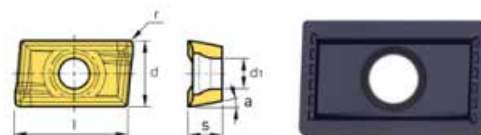

Art.	€	Dimensioni	d	l	S	r	d1	a°	Pack
ADLT1503ZZR20A	€ 10,10	15 mm	9.52 mm	14.50 mm	3.18 mm	0.80 mm	4.50 mm	15°	10

APKTX

INSERTI PER FRESATURA

90°.

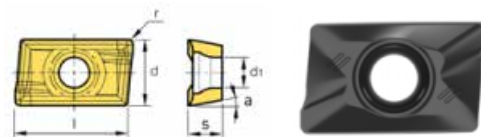

Art.	€	Dimensioni	d	l	S	r	d1	a°	Pack
APKT1003PDER20A	€ 12,40	10 mm	6.70 mm	10.00 mm	3.18 mm	0.50 mm	3.20 mm	11°	10
APKT1604PDER20A	€ 14,10	16 mm	9.50 mm	16.30 mm	4.76 mm	0.90 mm	4.40 mm	11°	10

OFEXX

INSERTI PER FRESATURA

45°.

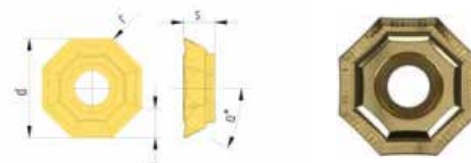

Art.	€	Dimensioni	d	l	S	r	d1	a°	Pack
OFEX05T305234	€ 12,90	5 mm	12.80 mm	3.70 mm	3.97 mm	0.50 mm	4.56 mm	25°	10

OFEXXA
INSERTO PER FRESATURA

45°.



Art.	€	Dimensioni	d	l	S	r	d1	a°	Pack
OFEX05T30520A	€ 13,70	5 mm	12.80 mm	3.70 mm	3.97 mm	0.50 mm	4.56 mm	25°	10

ONMXXA
INSERTO PER FRESATURA

45°.

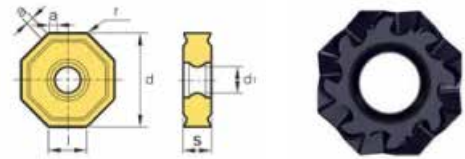

Art.	€	Dimensioni	d	l	S	d1	a°	Pack
ONMX120520A	€ 16,70	12 mm	12.70 mm	1.50 mm	5.56 mm	6.00 mm	-	10

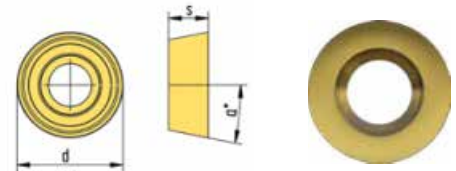
RDHTX
INSERTI PER FRESATURA

Art.	€	Dimensioni	d	S	a°	Pack
RDHT10T3M0-N	€ 11,60	10 mm	10 mm	3.97 mm	15°	10

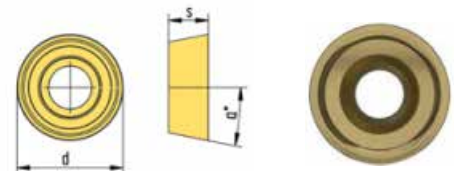
RPMTX
INSERTI PER FRESATURA

Art.	€	Dimensioni	d	S	a°	Pack
RPMT1204N	€ 10,90	12 mm	12 mm	4.76 mm	11°	10

SEHTX
INSERTI PER FRESATURA

45°.

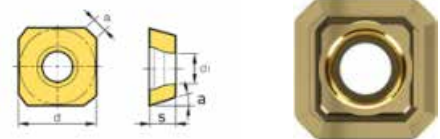

Art.	€	Dimensioni	d	a	S	d1	a°	Pack
SEHT1204AFN234	€ 17,00	12 mm	12.70 mm	1.80 mm	4.76 mm	5.50 mm	20°	10

SEHTXA
INSERTO PER FRESATURA

45°.

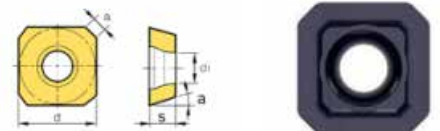

Art.	€	Dimensioni	d	a	S	d1	a°	Pack
SEHT1204AFN20A	€ 18,00	12 mm	12.70 mm	1.80 mm	4.76 mm	5.50 mm	20°	10



SEKNX

INSERTI PER FRESATURA

45°.

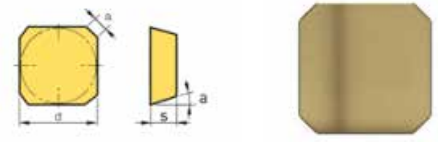

Art.	€	Dimensioni	d	a	S	a°	Pack
SEKN1203AFN25	€ 9,80	12 mm	12.70 mm	1.80 mm	3.18 mm	20°	10

SEHXX

INSERTI PER FRESATURA

45°.

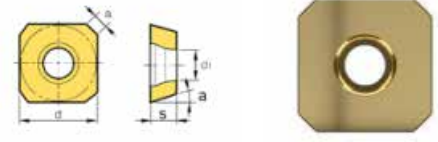

Art.	€	Dimensioni	d	a	S	d1	a°	Pack
SEHX1204234	€ 12,70	12 mm	12.70 mm	1.80 mm	4.76 mm	5.50 mm	20°	10

SEHXXA

INSERTO PER FRESATURA

45°.

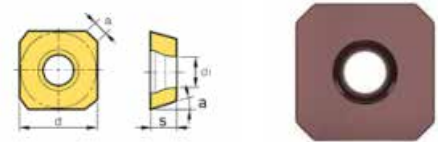

Art.	€	Dimensioni	d	a	S	d1	a°	Pack
SEHX120420A	€ 13,40	12 mm	12.70 mm	1.80 mm	4.76 mm	5.50 mm	20°	10

SNMXX

INSERTO PER FRESATURA

45°



Art.	€	Dimensioni	d	a	S	d1	a°	Pack
SNMX120520A	€ 13,10	12 mm	12.70 mm	1.80 mm	5.56 mm	6.00 mm	-	10

SPKNX

INSERTI PER FRESATURA

45°.



Art.	€	Dimensioni	l	a	S	a°	Pack
SPKN1203R25	€ 11,20	12 mm	12.7 mm	1.40 mm	3.18 mm	11°	10

TPKNX

INSERTI PER FRESATURA

45°.

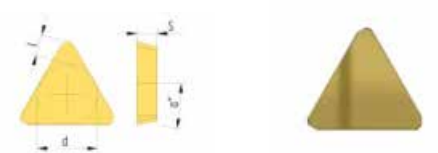

Art.	€	Dimensioni	d	l	a	S	a°	Pack
TPKN1603R25	€ 8,80	16 mm	9.52 mm	16.50 mm	1.47 mm	3.18 mm	11°	10
TPKN2204R25	€ 12,70	22 mm	12.70 mm	22.00 mm	1.47 mm	4.76 mm	11°	10

16IRX
INSERTI PER FILETTATURA INTERNA

ISO 9



Art.	€	Filetto	Pack
11IRA55134	€ 11,60	Whitworth 28 - 11 TPI	10
11IRA60134	€ 11,60	Metric 0.2 - 3 mm	10
16IR100ISO134	€ 12,90	P. Metric 1 mm	10
16IR125ISO134	€ 12,90	P. Metric 1.25 mm	10
16IR150ISO134	€ 12,90	P. Metric 1.50 mm	10
16IR175ISO134	€ 12,90	P. Metric 1.75 mm	10
16IR200ISO134	€ 12,90	P. Metric 2.00 mm	10
16IR250ISO134	€ 12,90	P. Metric 2.50 mm	10
16IR300ISO134	€ 12,90	P. Metric 3.00 mm	10
16IRAG60134	€ 12,90	Metric 0.2 - 3 mm	10
16IR14W134	€ 12,90	Whitworth 14 TPI	10
16IR11W134	€ 12,90	Whitworth 11 TPI	10
16IRAG55134	€ 12,90	Whitworth 28 - 11 TPI	10

16ERX
INSERTI PER FILETTATURA ESTERNA

ISO 9



Art.	€	Filetto	Pack
16ER100ISO134	€ 12,90	P. Metric 1 mm	10
16ER125ISO134	€ 12,90	P. Metric 1.25 mm	10
16ER150ISO134	€ 12,90	P. Metric 1.50 mm	10
16ER175ISO134	€ 12,90	P. Metric 1.75 mm	10
16ER200ISO134	€ 12,90	P. Metric 2.00 mm	10
16ER250ISO134	€ 12,90	P. Metric 2.50 mm	10
16ER300ISO134	€ 12,90	P. Metric 3.00 mm	10
16ERAG60134	€ 12,90	Metric 0.2 - 3 mm	10
16ER14W134	€ 12,90	Whitworth 14 TPI	10
16ER11W134	€ 12,90	Whitworth 11 TPI	10
16ERAG55134	€ 12,90	Whitworth 28 - 11 TPI	10

GCMX
INSERTI PER TRONCATURA

ISO 6

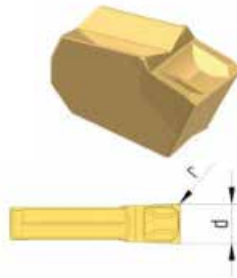

Art.	€	d	r	Pack
GCMX2N134	€ 9,20	2.20 mm	0.20 mm	10
GCMX3N134	€ 9,20	3.10 mm	0.20 mm	10
GCMX4N134	€ 10,40	4.10 mm	0.20 mm	10
GCMX5N134	€ 10,90	5.10 mm	0.30 mm	10



Art.	€	d	r	Pack
GCMX2N20A	€ 9,70	2.20 mm	0.20 mm	10
GCMX3N20A	€ 9,70	3.10 mm	0.20 mm	10
GCMX4N20A	€ 11,00	4.10 mm	0.20 mm	10
GCMX5N20A	€ 11,60	5.10 mm	0.30 mm	10

165X
INSERTI PER SCANALATURA

Art.	€	Spessore	Pack
165110134	€ 12,90	1.10 mm	10
165130134	€ 12,90	1.30 mm	10
165160134	€ 12,90	1.60 mm	10
165185134	€ 12,90	1.85 mm	10
165215134	€ 12,90	2.15 mm	10
165265134	€ 12,90	2.65 mm	10
165315134	€ 12,90	3.15 mm	10



IDENTIFICAZIONE BRASATI FERVI

Esplora la nostra vasta selezione di brasati con inserti termosaldati e seleziona il modello più adatto alle tue esigenze, in base alla specifica lavorazione che devi eseguire. Con la nostra gamma completa, garantiamo soluzioni versatili e di alta qualità per soddisfare le tue esigenze.

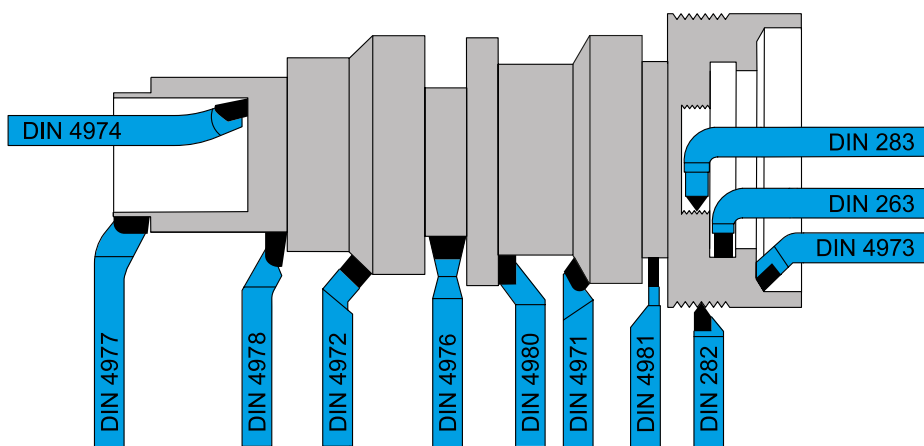

BR10- SET UTENSILI BRASATI NEW

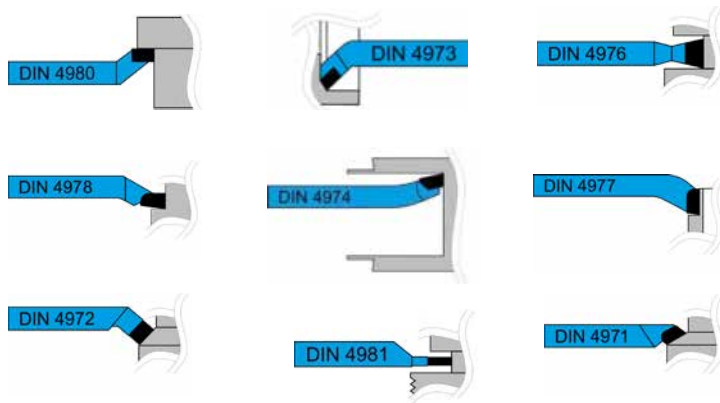

Art.	€	Dimensioni
BR10/10	€ 62,00	10 x 10 x L150 mm (ISO 8 DIN 4973, ISO 9 DIN 4974) 10 x 10 x L90 mm (ISO 1 DIN 4971, ISO 2 DIN 4972, ISO 6R DIN 4980, ISO 6L DIN 4980, ISO 7 DIN 4981) 6 x 10 x L90 mm (ISO 3R DIN 4978, ISO 4 DIN 4976, ISO 5 DIN 4977)
BR10/12	€ 72,00	12 x 12 x L180 mm (ISO 8 DIN 4973, ISO 9 DIN 4974) 12 x 12 x L100 mm (ISO 1 DIN 4971, ISO 2 DIN 4972, ISO 6R DIN 4980, ISO 6L DIN 4980) 8 x 12 x L100 mm (ISO 3R DIN 4978, ISO 4 DIN 4976, ISO 5 DIN 4977, ISO 7 DIN 4981)

B005- SERIE UTENSILI BRASATI

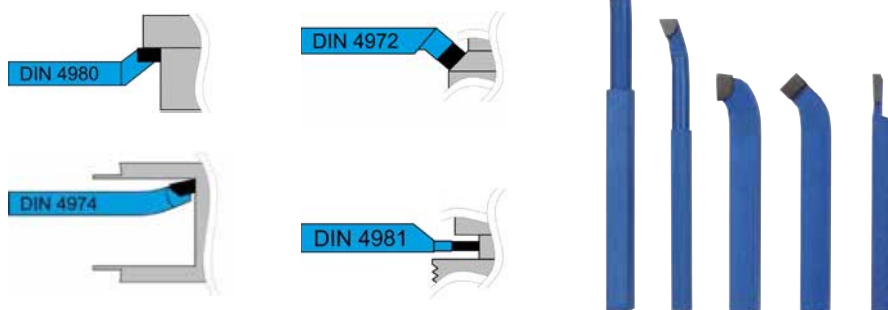

Art.	€	Kit
B005	€ 26,70	1BRAS411108RP - 1BRAS411110RP - 1BRAS410312RP - 1BRAS410412RP - 1BRAS410912RP
B005/16	€ 40,00	1BRAS411110RP - 1BRAS411112RP - 1BRAS410316RP - 1BRAS410416RP - 1BRAS410916RP
B005/20	€ 50,10	1BRAS411112RP - 1BRAS411116RP - 1BRAS410320RP - 1BRAS410420RP - 1BRAS410920RP

BRFEX
BRASATO PER FILETTATURA ESTERNA

Per l'esecuzione di tutte le filettature esterne a 60°.

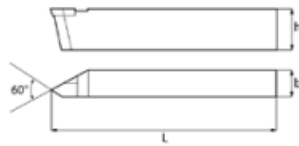

Art.	€	L	b	h
BRFE12RP	€ 9,60	90 mm	12 mm	12 mm
BRFE16RP	€ 10,90	100 mm	16 mm	16 mm
BRFE20RP	€ 13,50	125 mm	20 mm	20 mm
BRFE25RP	€ 16,40	140 mm	25 mm	25 mm

BRAS4111X
BRASATO PER FORI CIECHI

ISO 9

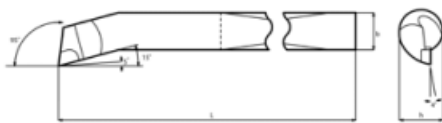

Art.	€	L	b	h
BRAS411108RP	€ 7,20	125 mm	8 mm	8 mm
BRAS411110RP	€ 8,80	150 mm	10 mm	10 mm
BRAS411112RP	€ 9,30	180 mm	12 mm	12 mm
BRAS411116RP	€ 11,20	210 mm	16 mm	16 mm
BRAS411120RP	€ 12,10	250 mm	20 mm	20 mm
BRAS411125RP	€ 18,20	300 mm	25 mm	25 mm
BRAS411132RP	€ 21,70	355 mm	32 mm	32 mm

BRAS4104X
BRASATO PER SFACCIARE

ISO 6

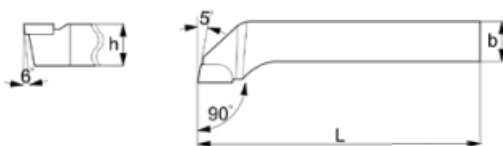

Art.	€	L	b	h
BRAS410410LP	€ 6,30	90 mm	10 mm	10 mm
BRAS410410RP	€ 6,30	90 mm	10 mm	10 mm
BRAS410412LP	€ 6,90	100 mm	12 mm	12 mm
BRAS410412RP	€ 6,90	100 mm	12 mm	12 mm
BRAS410416LP	€ 8,30	110 mm	16 mm	16 mm
BRAS410416RP	€ 8,30	110 mm	16 mm	16 mm
BRAS410420LP	€ 10,10	125 mm	20 mm	20 mm
BRAS410420RP	€ 10,10	125 mm	20 mm	20 mm
BRAS410425RP	€ 14,70	140 mm	25 mm	25 mm

BRFIX
BRASATO PER FILETTATURA INTERNA

Per l'esecuzione di tutte le filettature interne a 60°.

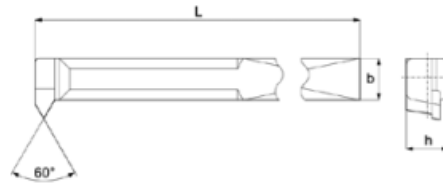

Art.	€	L	b	h
BRFI10RP	€ 10,10	150 mm	10 mm	10 mm
BRFI12RP	€ 10,90	180 mm	12 mm	12 mm
BRFI16RP	€ 13,50	210 mm	16 mm	16 mm
BRFI20RP	€ 14,10	250 mm	20 mm	20 mm
BRFI25RP	€ 17,50	300 mm	25 mm	25 mm

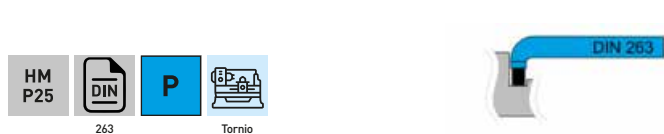
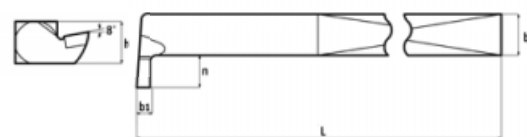
BRCIX
BRASATO PER CANALINI INTERNI

Art.	€	L	b	h	b1	N
BRCI10RP	€ 10,40	150 mm	10 mm	10 mm	3 mm	8 mm
BRCI12RP	€ 10,40	180 mm	12 mm	12 mm	4 mm	10 mm
BRCI16RP	€ 11,90	210 mm	16 mm	16 mm	5 mm	12 mm
BRCI20RP	€ 12,90	210 mm	20 mm	20 mm	6 mm	16 mm
BRCI25RP	€ 16,70	300 mm	25 mm	25 mm	8 mm	20 mm

BRAS4103X
BRASATO PER SGROSSARE

ISO 2

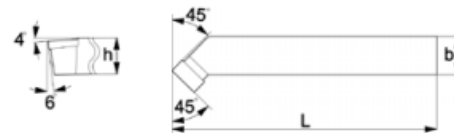

Art.	€	L	b	h
BRAS410310RP	€ 6,60	90 mm	10 mm	10 mm
BRAS410312LP	€ 7,20	100 mm	12 mm	12 mm
BRAS410312RP	€ 7,20	100 mm	12 mm	12 mm
BRAS410316LP	€ 8,70	110 mm	16 mm	16 mm
BRAS410316RP	€ 8,70	110 mm	16 mm	16 mm
BRAS410320LP	€ 10,70	125 mm	20 mm	20 mm
BRAS410320RP	€ 10,70	125 mm	20 mm	20 mm
BRAS410325RP	€ 15,40	140 mm	25 mm	25 mm



BRAS4109X

BRASATO PER TRONCARE

ISO 7

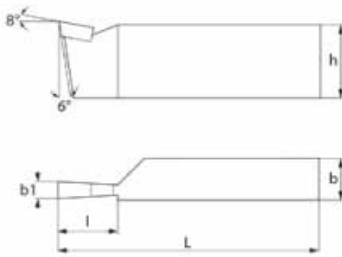

Art.	€	L	l	b	h	b1
BRAS410912RP	€ 6,60	100 mm	12 mm	8 mm	12 mm	3 mm
BRAS410916RP	€ 7,20	110 mm	14 mm	10 mm	16 mm	3,5 mm
BRAS410920RP	€ 8,10	125 mm	16 mm	12 mm	20 mm	5 mm
BRAS410925RP	€ 11,40	140 mm	20 mm	16 mm	25 mm	6 mm

B012-

BARRETTE TRATTATE E RETTIFICATE

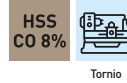

Art.	€	ø	Lunghezza	Tolleranza
B012/04	€ 9,30	4 mm	200 mm	h9
B012/05	€ 10,40	5 mm	200 mm	h9
B012/06	€ 11,90	6 mm	200 mm	h9
B012/08	€ 15,40	8 mm	200 mm	h9
B012/10	€ 19,10	10 mm	200 mm	h9
B012/12	€ 24,30	12 mm	200 mm	h9
B012/13	€ 29,80	13 mm	135 mm	h9
B012/16	€ 45,70	16 mm	200 mm	h9
B012/20	€ 59,00	20 mm	200 mm	h9

B013-

BARRETTE TRATTATE E RETTIFICATE

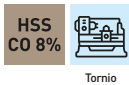

Art.	€	Dimensioni lati	Lunghezza	Tolleranza
B013/04X04	€ 10,80	4 x 4 mm	200 mm	h13
B013/05X05	€ 13,70	5 x 5 mm	200 mm	h13
B013/06X06	€ 15,00	6 x 6 mm	200 mm	h13
B013/08X08	€ 18,20	8 x 8 mm	200 mm	h13
B013/10X10	€ 25,40	10 x 10 mm	200 mm	h13
B013/12X12	€ 29,90	12 x 12 mm	200 mm	h13
B013/14X14	€ 41,90	14 x 14 mm	200 mm	h13
B013/16X16	€ 48,10	16 x 16 mm	200 mm	h13
B013/20X20	€ 71,10	20 x 20 mm	200 mm	h13

B014-



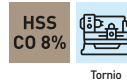



BARRETTE TRATTATE E RETTIFICATE



Art.	€	Dimensioni lati	Lunghezza	Tolleranza
B014/20X04	€ 25,80	20 x 04 mm	200 mm	h13
B014/20X05	€ 27,70	20 x 05 mm	200 mm	h13
B014/20X06	€ 41,60	20 x 06 mm	200 mm	h13
B014/20X08	€ 52,70	20 x 08 mm	200 mm	h13
B014/20X10	€ 56,00	20 x 10 mm	200 mm	h13
B014/20X12	€ 56,00	20 x 12 mm	200 mm	h13
B014/25X06	€ 40,40	25 x 06 mm	200 mm	h13



TIPOLOGIE DEL MATERIALE DI COSTRUZIONE DELLE PUNTE ELICOIDALI

Tipologia	Prodotto	Descrizione	Durata	Metalli lavorabili
HSS	 ST1Ax	HSS, High Speed Steel, cioè acciaio rapido, è il più comune tra tutti gli acciai per la realizzazione di utensili per metalli. Un utensile in HSS possiede una durezza elevata e una buona resistenza.	**	Acciai legati e non legati, metalli non ferrosi, ghisa grigia e malleabile, ferro sinterizzato
	 P023-			
	 ST2Ax			
HSS-TiN	 P058-	Il rivestimento di titanio, effettuato ad un utensile in HSS forma una lega più dura e più resistente. Questo porta ad avere una punta in grado di lavorare gli stessi materiali di quella in HSS ma con una usura del tagliente molto ridotta.	****	Acciai legati e non legati, metalli non ferrosi, ghisa malleabile, ferro sinterizzato
HSS-Co5%	 P065-	Il cobalto, aggiunto ad una utensile in acciaio come un HSS - in questo caso il 5% - conferisce solidità e resistenza ed aumenta la durezza dell'utensile stesso. Il cobalto mantiene le sue proprietà ad una temperatura più alta rispetto al titanio, il che rende possibile forare ad una velocità più elevata ed a condizioni più critiche.	*****	Acciai duri e trattati, acciai inossidabili, cromo nichel, ghisa e bronzo
HSS-Co8%	 P064-	Il cobalto, aggiunto ad una utensile in acciaio come un HSS - in questo caso il 8% - conferisce solidità e resistenza ed aumenta la durezza dell'utensile stesso. Il cobalto mantiene le sue proprietà ad una temperatura più alta rispetto al titanio, il che rende possibile forare ad una velocità più elevata ed a condizioni più critiche.	*****	Acciai duri e trattati, acciai inossidabili, cromo nichel, ghisa e bronzo

PARAMETRI FORATURA PER TIPOLOGIA DI MATERIALE PUNTE HSS, HSS-CO5% E HSS-CO8%

Materiale da lavorare	Tipo Punta	Velocità Periferica Vt (m/min)	Diametro punta				Refrigerante
			2	5	8	12	
			Avanzamento (mm/giro)				
Acciaio non legato da costruzione R<600N/mm2	HSS	20 - 25	0,05	0,12	0,20	0,25	Emulsione
	HSS-Tin	25 - 30					
Acciaio da costruzione basso legato R< 700÷900N/mm2	HSS	10 - 12	0,03	0,07	0,10	0,16	Emulsione
	HSS-Tin	15 - 18					
Acciaio legato R<1100÷1300N/mm2	HSS	6 - 8	0,02	0,05	0,08	0,12	Emulsione
	HSS-Tin	8 - 10					
Acciaio Inox	Hss-Co5%	6 - 8	0,02	0,05	0,08	0,12	Emulsione
	Hss-Co8%	8 - 10					
Ghisa Grigia 200HB	HSS	15 - 20	0,02	0,12	0,20	0,25	No refriger.
	HSS-Tin	20 - 25					
Ghisa Grigia 350HB	HSS	5 - 10	0,03	0,07	0,10	0,16	No refriger.
	HSS-Tin	20 - 25					
Bronzo	HSS	20 - 30	0,05	0,08	0,14	0,20	Emulsione o Olio
Ottone	HSS	40 - 70	0,06	0,16	0,22	0,32	
Alluminio	HSS	40 - 80	0,05	0,14	0,18	0,22	Emulsione
Leghe di Alluminio	HSS	30 - 60	0,05	0,14	0,18	0,22	



NUMERI DI GIRI AL MINUTO TEORICI PER L'UTILIZZO DELLE PUNTE ELICOIDALI IN BASE ALLA "Vt" SCELTA

Ø Punta	Velocità di taglio Vt (mt/min)																	
	3	4	5	6	8	10	12	15	18	20	25	30	35	40	50	60	70	80
(mm)	Numero di giri al minuto (rpm)																	
2	478	637	796	955	1274	1592	1911	2389	2866	3185	3981	4777	5573	6369	7962	9554	11146	12739
3	318	425	531	637	849	1062	1274	1592	1911	2123	2654	3185	3715	4246	5308	6369	7431	8493
4	239	318	398	478	637	796	955	1194	1433	1592	1990	2389	2787	3185	3981	4777	5573	6369
5	191	255	318	382	510	637	764	955	1146	1274	1592	1911	2229	2548	3185	3822	4459	5096
6	159	212	265	318	425	531	637	796	955	1062	1327	1592	1858	2123	2654	3185	3715	4246
8	119	159	199	239	318	398	478	597	717	796	995	1194	1393	1592	1990	2389	2787	3185
10	96	127	159	191	255	318	382	478	573	637	796	955	1115	1274	1592	1911	2229	2548
12	80	106	133	159	212	265	318	398	478	531	663	796	929	1062	1327	1592	1858	2123

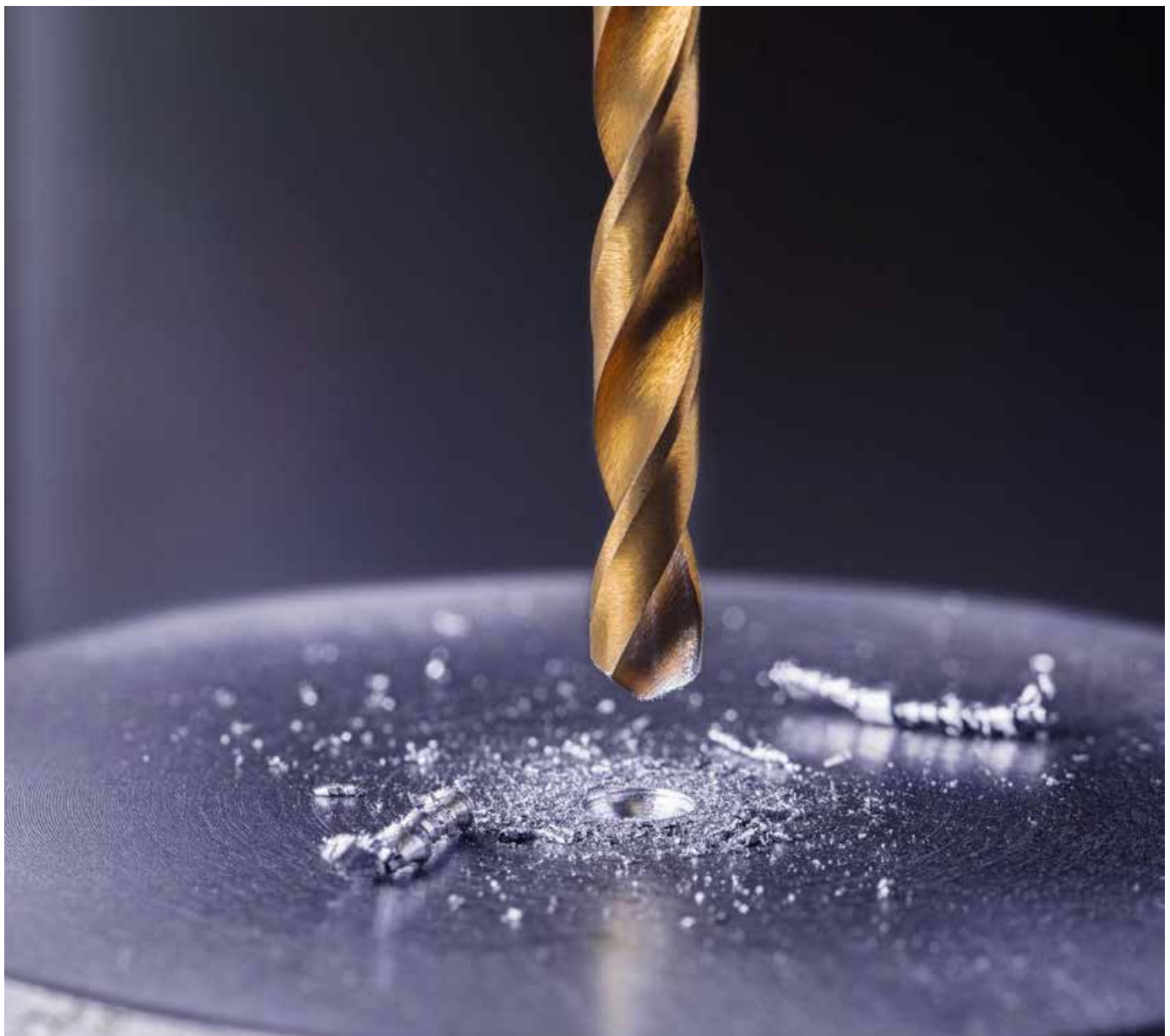

ST1AX
PUNTA CILINDRICA ELICOIDALE

Destra, rullata, nera, con gambo ridotto a 10 mm.

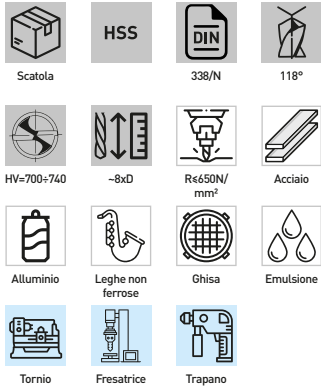
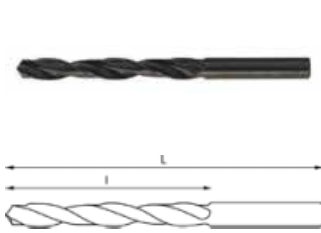

Art.	€	ø	L	l	Pack
ST1A01	€ 0,45	1,00 mm	34 mm	12 mm	10
ST1A01.25	€ 0,45	1,25 mm	38 mm	16 mm	10
ST1A01.50	€ 0,45	1,50 mm	40 mm	18 mm	10
ST1A01.75	€ 0,45	1,75 mm	46 mm	22 mm	10
ST1A02	€ 0,45	2,00 mm	49 mm	24 mm	10
ST1A02.25	€ 0,45	2,25 mm	53 mm	27 mm	10
ST1A02.50	€ 0,45	2,50 mm	57 mm	30 mm	10
ST1A02.75	€ 0,45	2,75 mm	61 mm	33 mm	10
ST1A03	€ 0,45	3,00 mm	61 mm	33 mm	10
ST1A03.25	€ 0,50	3,25 mm	65 mm	36 mm	10
ST1A03.50	€ 0,50	3,50 mm	70 mm	39 mm	10
ST1A03.75	€ 0,50	3,75 mm	70 mm	39 mm	10
ST1A04	€ 0,50	4,00 mm	75 mm	43 mm	10
ST1A04.25	€ 0,59	4,25 mm	75 mm	43 mm	10
ST1A04.50	€ 0,59	4,50 mm	80 mm	47 mm	10
ST1A04.75	€ 0,59	4,75 mm	80 mm	47 mm	10
ST1A05	€ 0,66	5,00 mm	86 mm	52 mm	10
ST1A05.25	€ 0,66	5,25 mm	86 mm	52 mm	10
ST1A05.50	€ 0,66	5,50 mm	93 mm	57 mm	10
ST1A05.75	€ 0,76	5,75 mm	93 mm	57 mm	10
ST1A06	€ 0,76	6,00 mm	93 mm	57 mm	10
ST1A06.25	€ 0,86	6,25 mm	101 mm	63 mm	10
ST1A06.50	€ 0,86	6,50 mm	101 mm	63 mm	10
ST1A06.75	€ 1,14	6,75 mm	109 mm	69 mm	10
ST1A07	€ 1,14	7,00 mm	109 mm	69 mm	10
ST1A07.25	€ 1,14	7,25 mm	109 mm	69 mm	10
ST1A07.50	€ 1,25	7,50 mm	109 mm	69 mm	10
ST1A07.75	€ 1,33	7,75 mm	117 mm	75 mm	10
ST1A08	€ 1,33	8,00 mm	117 mm	75 mm	10
ST1A08.25	€ 1,53	8,25 mm	117 mm	75 mm	5
ST1A08.50	€ 1,53	8,50 mm	117 mm	75 mm	5
ST1A08.75	€ 1,70	8,75 mm	125 mm	81 mm	5
ST1A09	€ 1,70	9,00 mm	125 mm	81 mm	5
ST1A09.25	€ 1,89	9,25 mm	125 mm	81 mm	5
ST1A09.50	€ 1,89	9,50 mm	125 mm	81 mm	5
ST1A09.75	€ 1,99	9,75 mm	133 mm	87 mm	5
ST1A10	€ 2,09	10,00 mm	133 mm	87 mm	5
ST1A10.25	€ 2,48	10,25 mm	133 mm	87 mm	5
ST1A10.50	€ 2,48	10,50 mm	133 mm	87 mm	5
ST1A10.75	€ 2,84	10,75 mm	142 mm	94 mm	5
ST1A11	€ 2,84	11,00 mm	142 mm	94 mm	5
ST1A11.25	€ 3,22	11,25 mm	142 mm	94 mm	5
ST1A11.50	€ 3,22	11,50 mm	142 mm	94 mm	5
ST1A11.75	€ 3,60	11,75 mm	142 mm	94 mm	5
ST1A12	€ 3,60	12,00 mm	151 mm	101 mm	5
ST1A12.25	€ 4,08	12,25 mm	151 mm	101 mm	5
ST1A12.50	€ 4,08	12,50 mm	151 mm	101 mm	5
ST1A12.75	€ 4,08	12,75 mm	151 mm	101 mm	5
ST1A13	€ 4,08	13,00 mm	151 mm	101 mm	5

P046
€ 32,90
SERIE PUNTE

Destra, rullate, nere.



Misura (progressione 0,5 mm) 1 + 13 mm

P045
€ 16,60
SERIE PUNTE

Destra, rullate, nere.



Misura (progressione 0,5 mm) 1+10 mm

ST1AXC
PUNTA CILINDRICA ELICOIDALE

Destra, serie corta, rullata, nera.



Art.	€	ø	L	l	Pack
ST1A02.00C	€ 0,33	2,00 mm	38 mm	12 mm	10
ST1A02.50C	€ 0,33	2,50 mm	43 mm	14 mm	10
ST1A03.00C	€ 0,33	3,00 mm	46 mm	16 mm	10
ST1A03.25C	€ 0,38	3,25 mm	49 mm	18 mm	10
ST1A03.50C	€ 0,38	3,50 mm	52 mm	20 mm	10
ST1A03.75C	€ 0,42	3,75 mm	52 mm	20 mm	10
ST1A04.00C	€ 0,42	4,00 mm	55 mm	22 mm	10
ST1A04.25C	€ 0,45	4,25 mm	55 mm	22 mm	10
ST1A04.50C	€ 0,45	4,50 mm	58 mm	24 mm	10
ST1A05.00C	€ 0,55	5,00 mm	62 mm	26 mm	10
ST1A05.50C	€ 0,75	5,50 mm	66 mm	28 mm	10
ST1A06.00C	€ 0,75	6,00 mm	66 mm	28 mm	10



ST1AXR10

PUNTA CILINDRICA ELICOIDALE

Destra, rullata, nera, con gambo ridotto a 10 mm.



Art.	€	Ø	L	l	Pack
ST1A10.25R10	€ 2,66	10,25 mm	133 mm	87 mm	5
ST1A10.50R10	€ 2,66	10,5 mm	133 mm	87 mm	5
ST1A10.75R10	€ 3,00	10,75 mm	142 mm	94 mm	5
ST1A11.00R10	€ 3,00	11,00 mm	142 mm	94 mm	5
ST1A11.25R10	€ 3,44	11,25 mm	142 mm	94 mm	5
ST1A11.50R10	€ 3,44	11,5 mm	142 mm	94 mm	5
ST1A11.75R10	€ 3,89	11,75 mm	142 mm	94 mm	5
ST1A12.00R10	€ 3,89	12 mm	151 mm	101 mm	5
ST1A12.25R10	€ 4,33	12,25 mm	151 mm	101 mm	5
ST1A12.50R10	€ 4,33	12,50 mm	151 mm	101 mm	5
ST1A12.75R10	€ 4,33	12,75 mm	151 mm	101 mm	5
ST1A13.00R10	€ 4,33	13 mm	151 mm	101 mm	5
ST1A13.25R10	€ 5,50	13,25 mm	160 mm	108 mm	5
ST1A13.50R10	€ 5,50	13,5 mm	160 mm	108 mm	5
ST1A13.75R10	€ 5,50	13,75 mm	160 mm	108 mm	5
ST1A14.00R10	€ 5,50	14,00 mm	160 mm	108 mm	5
ST1A14.25R10	€ 6,00	14,25 mm	169 mm	114 mm	5
ST1A14.50R10	€ 6,00	14,5 mm	169 mm	114 mm	5
ST1A14.75R10	€ 6,00	14,75 mm	169 mm	114 mm	5
ST1A15.00R10	€ 6,00	15 mm	169 mm	114 mm	5
ST1A15.25R10	€ 7,40	15,25 mm	178 mm	120 mm	5
ST1A15.50R10	€ 7,40	15,50 mm	178 mm	120 mm	5
ST1A15.75R10	€ 7,40	15,75 mm	178 mm	120 mm	5
ST1A16.00R10	€ 7,40	16 mm	178 mm	120 mm	5

ST1AXR13

PUNTA CILINDRICA ELICOIDALE

Destra, rullata, nera, con gambo ridotto a 13 mm.



Art.	€	Ø	L	l	Pack
ST1A13.25R13	€ 5,50	13,25 mm	160 mm	108 mm	5
ST1A13.50R13	€ 5,50	13,50 mm	160 mm	108 mm	5
ST1A13.75R13	€ 5,50	13,75 mm	160 mm	108 mm	5
ST1A14.00R13	€ 5,50	14,00 mm	160 mm	108 mm	5
ST1A14.25R13	€ 6,00	14,25 mm	169 mm	114 mm	5
ST1A14.50R13	€ 6,00	14,50 mm	169 mm	114 mm	5
ST1A14.75R13	€ 6,00	14,75 mm	169 mm	114 mm	5
ST1A15.00R13	€ 6,00	15,00 mm	169 mm	114 mm	5
ST1A15.25R13	€ 7,40	15,25 mm	178 mm	120 mm	5
ST1A15.50R13	€ 7,40	15,50 mm	178 mm	120 mm	5
ST1A15.75R13	€ 7,40	15,75 mm	178 mm	120 mm	5
ST1A16.00R13	€ 7,40	16,00 mm	178 mm	120 mm	5

P023-
PUNTA ELICOIDALE CILINDRICA

Destra, rettificata.

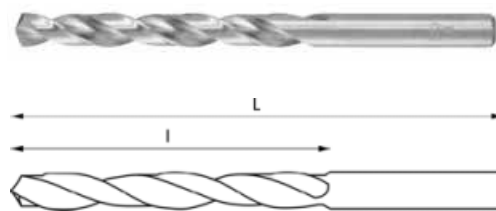
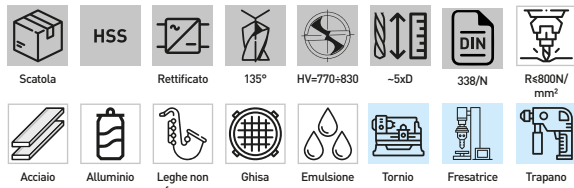

Art.	€	ø	L	l	Pack	Art.	€	ø	L	l	Pack	Art.	€	ø	L	l	Pack
P023/00.30	€ 0,41	0.30 mm	19 mm	3 mm	10	P023/03.80	€ 0,89	3.80 mm	75 mm	43 mm	10	P023/07.80	€ 2,54	7.80 mm	117 mm	75 mm	10
P023/00.35	€ 0,41	0.35 mm	19 mm	4 mm	10	P023/03.90	€ 0,89	3.90 mm	75 mm	43 mm	10	P023/07.90	€ 2,54	7.90 mm	117 mm	75 mm	10
P023/00.40	€ 0,41	0.40 mm	20 mm	5 mm	10	P023/04.00	€ 1,04	4.00 mm	75 mm	43 mm	10	P023/08.00	€ 3,36	8.00 mm	117 mm	75 mm	5
P023/00.45	€ 0,41	0.45 mm	20 mm	5 mm	10	P023/04.10	€ 0,98	4.10 mm	75 mm	43 mm	10	P023/08.10	€ 2,89	8.10 mm	117 mm	75 mm	5
P023/00.50	€ 0,41	0.50 mm	22 mm	6 mm	10	P023/04.20	€ 0,98	4.20 mm	75 mm	43 mm	10	P023/08.20	€ 2,89	8.20 mm	117 mm	75 mm	5
P023/00.55	€ 0,41	0.55 mm	24 mm	7 mm	10	P023/04.25	€ 1,42	4.25 mm	75 mm	43 mm	10	P023/08.25	€ 4,29	8.25 mm	117 mm	75 mm	5
P023/00.60	€ 0,41	0.60 mm	24 mm	7 mm	10	P023/04.30	€ 1,04	4.30 mm	80 mm	47 mm	10	P023/08.30	€ 2,89	8.30 mm	117 mm	75 mm	5
P023/00.65	€ 0,41	0.65 mm	26 mm	8 mm	10	P023/04.40	€ 1,04	4.40 mm	80 mm	47 mm	10	P023/08.40	€ 2,89	8.40 mm	117 mm	75 mm	5
P023/00.70	€ 0,41	0.70 mm	28 mm	9 mm	10	P023/04.50	€ 1,23	4.50 mm	80 mm	47 mm	10	P023/08.50	€ 4,22	8.50 mm	117 mm	75 mm	5
P023/00.75	€ 0,41	0.75 mm	28 mm	9 mm	10	P023/04.60	€ 1,22	4.60 mm	80 mm	47 mm	10	P023/08.60	€ 3,35	8.60 mm	125 mm	81 mm	5
P023/00.80	€ 0,41	0.80 mm	30 mm	10 mm	10	P023/04.70	€ 1,22	4.70 mm	80 mm	47 mm	10	P023/08.70	€ 3,35	8.70 mm	125 mm	81 mm	5
P023/00.85	€ 0,41	0.85 mm	30 mm	10 mm	10	P023/04.75	€ 1,42	4.75 mm	80 mm	47 mm	10	P023/08.75	€ 4,59	8.75 mm	125 mm	81 mm	5
P023/00.90	€ 0,41	0.90 mm	32 mm	11 mm	10	P023/04.80	€ 1,22	4.80 mm	86 mm	52 mm	10	P023/08.80	€ 3,35	8.80 mm	125 mm	81 mm	5
P023/00.95	€ 0,41	0.95 mm	32 mm	11 mm	10	P023/04.90	€ 1,22	4.90 mm	86 mm	52 mm	10	P023/08.90	€ 3,35	8.90 mm	125 mm	81 mm	5
P023/01.00	€ 0,93	1.00 mm	34 mm	12 mm	10	P023/05.00	€ 1,31	5.00 mm	86 mm	52 mm	10	P023/09.00	€ 4,40	9.00 mm	125 mm	81 mm	5
P023/01.10	€ 0,49	1.10 mm	36 mm	14 mm	10	P023/05.10	€ 1,51	5.10 mm	86 mm	52 mm	10	P023/09.10	€ 3,71	9.10 mm	125 mm	81 mm	5
P023/01.20	€ 0,49	1.20 mm	38 mm	16 mm	10	P023/05.20	€ 1,51	5.20 mm	86 mm	52 mm	10	P023/09.20	€ 3,71	9.20 mm	125 mm	81 mm	5
P023/01.25	€ 0,93	1.25 mm	38 mm	16 mm	10	P023/05.25	€ 1,78	5.25 mm	86 mm	52 mm	10	P023/09.25	€ 5,20	9.25 mm	125 mm	81 mm	5
P023/01.30	€ 0,49	1.30 mm	38 mm	16 mm	10	P023/05.30	€ 1,51	5.30 mm	86 mm	52 mm	10	P023/09.30	€ 3,71	9.30 mm	125 mm	81 mm	5
P023/01.40	€ 0,49	1.40 mm	40 mm	18 mm	10	P023/05.40	€ 1,51	5.40 mm	93 mm	57 mm	10	P023/09.40	€ 3,71	9.40 mm	125 mm	81 mm	5
P023/01.50	€ 0,85	1.50 mm	40 mm	18 mm	10	P023/05.50	€ 1,68	5.50 mm	93 mm	57 mm	10	P023/09.50	€ 4,67	9.50 mm	125 mm	81 mm	5
P023/01.60	€ 0,55	1.60 mm	43 mm	20 mm	10	P023/05.60	€ 1,59	5.60 mm	93 mm	57 mm	10	P023/09.60	€ 4,15	9.60 mm	133 mm	87 mm	5
P023/01.70	€ 0,55	1.70 mm	43 mm	20 mm	10	P023/05.70	€ 1,59	5.70 mm	93 mm	57 mm	10	P023/09.70	€ 4,15	9.70 mm	133 mm	87 mm	5
P023/01.75	€ 0,75	1.75 mm	46 mm	22 mm	10	P023/05.75	€ 1,97	5.75 mm	93 mm	57 mm	10	P023/09.75	€ 5,60	9.75 mm	133 mm	87 mm	5
P023/01.80	€ 0,55	1.80 mm	46 mm	22 mm	10	P023/05.80	€ 1,59	5.80 mm	93 mm	57 mm	10	P023/09.80	€ 4,15	9.80 mm	133 mm	87 mm	5
P023/01.90	€ 0,55	1.90 mm	46 mm	22 mm	10	P023/05.90	€ 1,59	5.90 mm	93 mm	57 mm	10	P023/09.90	€ 4,15	9.90 mm	133 mm	87 mm	5
P023/02.00	€ 0,75	2.00 mm	49 mm	24 mm	10	P023/06.00	€ 1,78	6.00 mm	93 mm	57 mm	10	P023/10.00	€ 5,10	10.00 mm	133 mm	87 mm	5
P023/02.10	€ 0,60	2.10 mm	49 mm	24 mm	10	P023/06.10	€ 1,64	6.10 mm	101 mm	63 mm	10	P023/10.25	€ 7,00	10.25 mm	133 mm	87 mm	5
P023/02.20	€ 0,60	2.20 mm	53 mm	27 mm	10	P023/06.20	€ 1,64	6.20 mm	101 mm	63 mm	10	P023/10.30	€ 5,20	10.30 mm	133 mm	87 mm	5
P023/02.25	€ 0,85	2.25 mm	53 mm	27 mm	10	P023/06.25	€ 2,53	6.25 mm	101 mm	63 mm	10	P023/10.40	€ 5,20	10.40 mm	133 mm	87 mm	5
P023/02.30	€ 0,60	2.30 mm	53 mm	27 mm	10	P023/06.30	€ 1,64	6.30 mm	101 mm	63 mm	10	P023/10.50	€ 6,20	10.50 mm	133 mm	87 mm	5
P023/02.40	€ 0,60	2.40 mm	57 mm	30 mm	10	P023/06.40	€ 1,64	6.40 mm	101 mm	63 mm	10	P023/10.75	€ 8,50	10.75 mm	142 mm	94 mm	5
P023/02.50	€ 0,75	2.50 mm	57 mm	30 mm	10	P023/06.50	€ 2,25	6.50 mm	101 mm	63 mm	10	P023/11.00	€ 7,40	11.00 mm	142 mm	94 mm	5
P023/02.60	€ 0,71	2.60 mm	57 mm	30 mm	10	P023/06.60	€ 1,98	6.60 mm	101 mm	63 mm	10	P023/11.25	€ 8,90	11.25 mm	142 mm	94 mm	5
P023/02.70	€ 0,71	2.70 mm	61 mm	33 mm	10	P023/06.70	€ 1,98	6.70 mm	101 mm	63 mm	10	P023/11.40	€ 6,50	11.40 mm	142 mm	94 mm	5
P023/02.75	€ 0,93	2.75 mm	61 mm	33 mm	10	P023/06.75	€ 2,91	6.75 mm	109 mm	69 mm	10	P023/11.50	€ 7,80	11.50 mm	142 mm	94 mm	5
P023/02.80	€ 0,71	2.80 mm	61 mm	33 mm	10	P023/06.80	€ 1,98	6.80 mm	109 mm	69 mm	10	P023/11.75	€ 9,80	11.75 mm	142 mm	94 mm	5
P023/02.90	€ 0,71	2.90 mm	61 mm	33 mm	10	P023/06.90	€ 1,98	6.90 mm	109 mm	69 mm	10	P023/12.00	€ 8,50	12.00 mm	151 mm	101 mm	5
P023/03.00	€ 0,85	3.00 mm	61 mm	33 mm	10	P023/07.00	€ 2,72	7.00 mm	109 mm	69 mm	10	P023/12.25	€ 10,60	12.25 mm	151 mm	101 mm	5
P023/03.10	€ 0,85	3.10 mm	65 mm	36 mm	10	P023/07.10	€ 2,27	7.10 mm	109 mm	69 mm	10	P023/12.30	€ 8,00	12.30 mm	151 mm	101 mm	5
P023/03.20	€ 0,85	3.20 mm	65 mm	36 mm	10	P023/07.20	€ 2,27	7.20 mm	109 mm	69 mm	10	P023/12.40	€ 8,00	12.40 mm	151 mm	101 mm	5
P023/03.25	€ 1,04	3.25 mm	65 mm	36 mm	10	P023/07.25	€ 3,18	7.25 mm	109 mm	69 mm	10	P023/12.50	€ 9,20	12.50 mm	151 mm	101 mm	5
P023/03.30	€ 0,93	3.30 mm	65 mm	36 mm	10	P023/07.30	€ 2,27	7.30 mm	109 mm	69 mm	10	P023/12.75	€ 12,00	12.75 mm	151 mm	101 mm	5
P023/03.40	€ 0,93	3.40 mm	70 mm	39 mm	10	P023/07.40	€ 2,27	7.40 mm	109 mm	69 mm	10	P023/13.00	€ 10,00	13.00 mm	151 mm	101 mm	5
P023/03.50	€ 0,93	3.50 mm	70 mm	39 mm	10	P023/07.50	€ 2,80	7.50 mm	109 mm	69 mm	10	P023/14.30	€ 16,10	14.30 mm	165 mm	115 mm	5
P023/03.60	€ 0,89	3.60 mm	70 mm	39 mm	10	P023/07.60	€ 2,54	7.60 mm	117 mm	75 mm	10	P023/14.40	€ 16,10	14.40 mm	165 mm	115 mm	5
P023/03.70	€ 0,89	3.70 mm	70 mm	39 mm	10	P023/07.70	€ 2,54	7.70 mm	117 mm	75 mm	10	P023/16.40	€ 20,80	16.40 mm	170 mm	115 mm	5
P023/03.75	€ 1,12	3.75 mm	70 mm	39 mm	10	P023/07.75	€ 3,55	7.75 mm	117 mm	75 mm	10						

P023/19
€ 38,00
SERIE PUNTE ELICOIDALI CILINDRICHE

Destra, rettificata.



19 Pcs

Misura (progressione 0,5 mm) 1 ÷ 10 mm

P023/25
€ 77,10
SERIE PUNTE ELICOIDALI CILINDRICHE

Destra, rettificata.



25 Pcs

Misura (progressione 0,5 mm) 1 ÷ 13 mm





P023-XC

PUNTA ELICOIDALE CILINDRICA SERIE CORTA

Destra, rettificata.

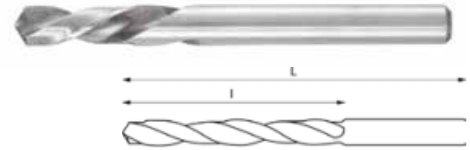

Art.	€	Ø	L	l	Pack
P023/03.00C	€ 0,93	3,00 mm	46 mm	16 mm	10
P023/03.25C	€ 1,04	3,25 mm	49 mm	18 mm	10
P023/03.50C	€ 1,04	3,50 mm	52 mm	20 mm	10
P023/03.75C	€ 1,12	3,75 mm	52 mm	20 mm	10
P023/04.00C	€ 1,12	4,00 mm	55 mm	22 mm	10

Art.	€	Ø	L	l	Pack
P023/04.25C	€ 1,49	4,25 mm	55 mm	22 mm	10
P023/04.50C	€ 1,31	4,50 mm	58 mm	24 mm	10
P023/05.00C	€ 1,42	5,00 mm	62 mm	26 mm	10
P023/05.50C	€ 1,87	5,50 mm	66 mm	28 mm	10
P023/06.00C	€ 1,97	6,00 mm	66 mm	28 mm	10

P023-XL

PUNTA ELICOIDALE CILINDRICA LUNGA

Destra, rettificata.

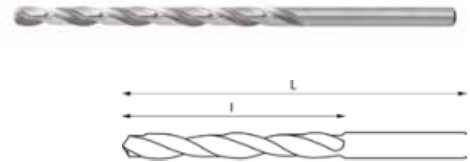
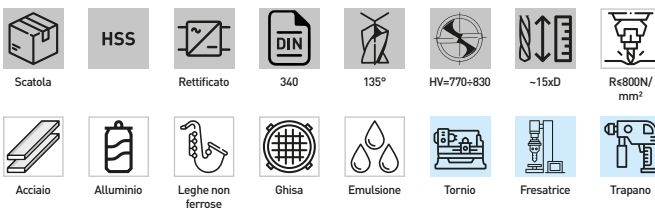

Art.	€	Ø	L	l	Pack
P023/01.00L	€ 1,04	1,00 mm	56 mm	33 mm	10
P023/01.25L	€ 1,04	1,25 mm	65 mm	40 mm	10
P023/01.50L	€ 1,04	1,50 mm	70 mm	45 mm	10
P023/01.75L	€ 1,04	1,75 mm	80 mm	53 mm	10
P023/02.00L	€ 0,93	2,00 mm	85 mm	56 mm	10
P023/02.25L	€ 1,04	2,25 mm	90 mm	59 mm	10
P023/02.50L	€ 0,93	2,50 mm	95 mm	62 mm	10
P023/02.75L	€ 1,12	2,75 mm	100 mm	66 mm	10
P023/03.00L	€ 1,04	3,00 mm	100 mm	66 mm	10
P023/03.25L	€ 1,12	3,25 mm	106 mm	69 mm	10
P023/03.50L	€ 1,12	3,50 mm	112 mm	73 mm	10
P023/03.75L	€ 1,31	3,75 mm	112 mm	73 mm	10
P023/04.00L	€ 1,23	4,00 mm	119 mm	78 mm	10
P023/04.25L	€ 1,42	4,25 mm	119 mm	78 mm	10
P023/04.50L	€ 1,42	4,50 mm	126 mm	82 mm	10
P023/04.75L	€ 1,68	4,75 mm	126 mm	82 mm	10
P023/05.00L	€ 1,68	5,00 mm	132 mm	87 mm	10
P023/05.25L	€ 2,06	5,25 mm	132 mm	87 mm	10
P023/05.50L	€ 2,06	5,50 mm	139 mm	91 mm	10
P023/05.75L	€ 2,25	5,75 mm	139 mm	91 mm	10
P023/06.00L	€ 2,25	6,00 mm	139 mm	91 mm	10
P023/06.25L	€ 2,80	6,25 mm	148 mm	97 mm	10

Art.	€	Ø	L	l	Pack
P023/06.50L	€ 2,80	6,50 mm	148 mm	97 mm	10
P023/06.75L	€ 2,91	6,75 mm	148 mm	97 mm	10
P023/07.00L	€ 2,91	7,00 mm	156 mm	102 mm	10
P023/07.25L	€ 3,36	7,25 mm	156 mm	102 mm	10
P023/07.50L	€ 3,36	7,25 mm	156 mm	102 mm	10
P023/07.75L	€ 4,03	7,75 mm	165 mm	109 mm	10
P023/08.00L	€ 3,84	8,00 mm	165 mm	109 mm	5
P023/08.25L	€ 5,50	8,25 mm	165 mm	109 mm	5
P023/08.50L	€ 5,50	8,50 mm	165 mm	109 mm	5
P023/08.75L	€ 5,60	8,75 mm	175 mm	115 mm	5
P023/09.00L	€ 5,60	9,00 mm	175 mm	115 mm	5
P023/09.25L	€ 6,40	9,25 mm	175 mm	115 mm	5
P023/09.50L	€ 6,40	9,50 mm	175 mm	115 mm	5
P023/09.75L	€ 6,40	9,75 mm	184 mm	121 mm	5
P023/10.00L	€ 6,40	10,00 mm	184 mm	121 mm	5
P023/10.25L	€ 8,80	10,25 mm	184 mm	121 mm	5
P023/10.50L	€ 8,80	10,50 mm	184 mm	121 mm	5
P023/11.00L	€ 10,40	11,00 mm	195 mm	128 mm	5
P023/11.50L	€ 11,20	11,50 mm	195 mm	128 mm	5
P023/12.00L	€ 13,10	12,00 mm	205 mm	134 mm	5
P023/12.50L	€ 14,50	12,50 mm	205 mm	134 mm	5
P023/13.00L	€ 15,20	13,00 mm	205 mm	134 mm	5

P023-XL1

PUNTA ELICOIDALE CILINDRICA SERIE EXTRA LUNGA

Destra, rettificata.

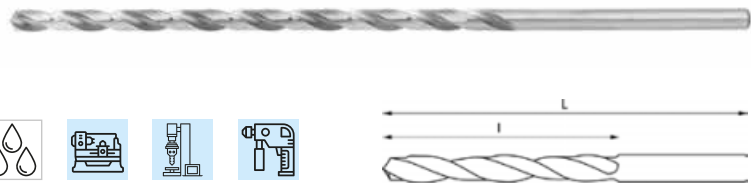
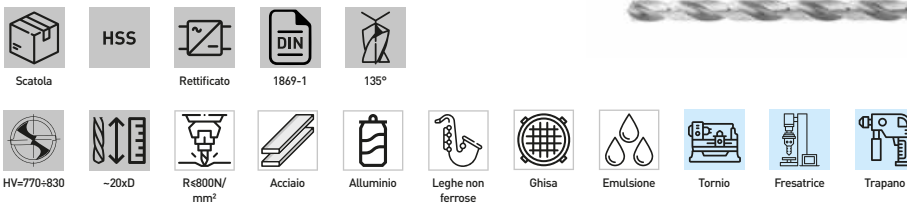

Art.	€	Ø	L	l
P023/02.00L1	€ 1,68	2,00 mm	125 mm	85 mm
P023/02.50L1	€ 1,87	2,50 mm	140 mm	95 mm
P023/03.00L1	€ 2,35	3,00 mm	150 mm	100 mm
P023/03.50L1	€ 2,80	3,50 mm	165 mm	115 mm
P023/04.00L1	€ 3,74	4,00 mm	175 mm	120 mm
P023/04.50L1	€ 4,67	4,50 mm	185 mm	125 mm
P023/05.00L1	€ 5,60	5,00 mm	195 mm	135 mm
P023/05.50L1	€ 6,60	5,50 mm	205 mm	140 mm
P023/06.00L1	€ 8,50	6,00 mm	205 mm	140 mm
P023/06.50L1	€ 9,30	6,50 mm	215 mm	150 mm
P023/07.00L1	€ 11,20	7,00 mm	225 mm	155 mm
P023/07.50L1	€ 12,20	7,50 mm	225 mm	155 mm

Art.	€	Ø	L	l
P023/08.00L1	€ 15,00	8,00 mm	240 mm	165 mm
P023/08.50L1	€ 16,80	8,50 mm	240 mm	165 mm
P023/09.00L1	€ 18,70	9,00 mm	250 mm	175 mm
P023/09.50L1	€ 20,60	9,50 mm	250 mm	175 mm
P023/10.00L1	€ 23,40	10,00 mm	265 mm	185 mm
P023/10.50L1	€ 25,30	10,50 mm	265 mm	185 mm
P023/11.00L1	€ 28,00	11,00 mm	280 mm	195 mm
P023/11.50L1	€ 31,00	11,50 mm	280 mm	195 mm
P023/12.00L1	€ 32,80	12,00 mm	295 mm	205 mm
P023/12.50L1	€ 34,70	12,50 mm	295 mm	205 mm
P023/13.00L1	€ 36,50	13,00 mm	295 mm	205 mm

P023-XL2
PUNTA ELICOIDALE CILINDRICA SERIE EXTRA LUNGA

Destra, rettificata.

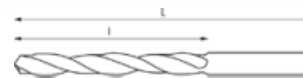

Art.	€	Ø	L	l
P023/02.00L2	€ 2,35	2,00 mm	160 mm	110 mm
P023/02.50L2	€ 2,80	2,50 mm	180 mm	120 mm
P023/03.00L2	€ 3,36	3,00 mm	190 mm	130 mm
P023/03.50L2	€ 3,74	3,50 mm	210 mm	145 mm
P023/04.00L2	€ 5,60	4,00 mm	220 mm	150 mm
P023/04.50L2	€ 6,60	4,50 mm	235 mm	160 mm
P023/05.00L2	€ 8,50	5,00 mm	245 mm	170 mm
P023/05.50L2	€ 9,30	5,50 mm	260 mm	180 mm
P023/06.00L2	€ 11,20	6,00 mm	260 mm	180 mm
P023/06.50L2	€ 13,10	6,50 mm	275 mm	190 mm
P023/07.00L2	€ 16,00	7,00 mm	290 mm	200 mm
P023/07.50L2	€ 16,80	7,50 mm	290 mm	200 mm
P023/08.00L2	€ 20,60	8,00 mm	305 mm	210 mm
P023/08.50L2	€ 22,50	8,50 mm	305 mm	210 mm
P023/09.00L2	€ 25,30	9,00 mm	320 mm	220 mm
P023/09.50L2	€ 26,10	9,50 mm	320 mm	220 mm
P023/10.00L2	€ 31,80	10,00 mm	340 mm	235 mm
P023/10.50L2	€ 33,70	10,50 mm	340 mm	235 mm
P023/11.00L2	€ 39,30	11,00 mm	365 mm	250 mm
P023/11.50L2	€ 42,10	11,50 mm	365 mm	250 mm
P023/12.00L2	€ 44,00	12,00 mm	375 mm	260 mm
P023/12.50L2	€ 46,70	12,50 mm	375 mm	260 mm
P023/13.00L2	€ 51,50	13,00 mm	375 mm	260 mm

P023-XL3
PUNTA ELICOIDALE CILINDRICA SERIE EXTRA LUNGA

Destra, rettificata.



Art.	€	Ø	L	l
P023/02.00L3	€ 2,80	02,00 mm	200 mm	135 mm
P023/02.50L3	€ 3,29	02,50 mm	225 mm	150 mm
P023/03.00L3	€ 3,74	03,00 mm	240 mm	160 mm
P023/03.50L3	€ 5,60	03,50 mm	265 mm	180 mm
P023/04.00L3	€ 6,60	04,00 mm	280 mm	190 mm
P023/04.50L3	€ 8,50	04,50 mm	295 mm	200 mm
P023/05.00L3	€ 10,40	05,00 mm	315 mm	210 mm
P023/05.50L3	€ 12,20	05,50 mm	330 mm	225 mm
P023/06.00L3	€ 14,10	06,00 mm	330 mm	225 mm
P023/06.50L3	€ 16,80	06,50 mm	350 mm	235 mm
P023/07.00L3	€ 20,60	07,00 mm	370 mm	250 mm
P023/07.50L3	€ 22,50	07,50 mm	370 mm	250 mm
P023/08.00L3	€ 26,10	08,00 mm	390 mm	265 mm
P023/08.50L3	€ 29,10	08,50 mm	390 mm	265 mm
P023/09.00L3	€ 33,70	09,00 mm	410 mm	280 mm
P023/09.50L3	€ 34,70	09,50 mm	410 mm	280 mm
P023/10.00L3	€ 40,30	10,00 mm	430 mm	295 mm
P023/10.50L3	€ 43,10	10,50 mm	430 mm	295 mm
P023/11.00L3	€ 46,70	11,00 mm	455 mm	310 mm
P023/11.50L3	€ 49,70	11,50 mm	455 mm	310 mm
P023/12.00L3	€ 56,10	12,00 mm	480 mm	330 mm
P023/12.50L3	€ 60,80	12,50 mm	480 mm	330 mm
P023/13.00L3	€ 64,60	13,00 mm	480 mm	330 mm



P058-

PUNTA CILINDRICA ELICOIDALE

Destra, lunga durata grazie al rivestimento in titanio.

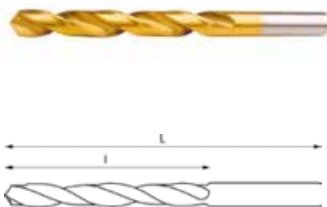

Art.	€	Ø	L	l	Pack
P058/01.00	€ 0,76	1 mm	34 mm	12 mm	10
P058/01.25	€ 0,76	1,25 mm	38 mm	16 mm	10
P058/01.50	€ 0,76	1,50 mm	40 mm	18 mm	10
P058/01.75	€ 0,76	1,75 mm	46 mm	22 mm	10
P058/02.00	€ 0,86	2 mm	49 mm	24 mm	10
P058/02.25	€ 0,95	2,25 mm	53 mm	27 mm	10
P058/02.50	€ 0,95	2,50 mm	57 mm	30 mm	10
P058/02.75	€ 0,95	2,75 mm	61 mm	33 mm	10
P058/03.00	€ 0,95	3 mm	61 mm	33 mm	10
P058/03.25	€ 1,14	3,25 mm	65 mm	36 mm	10
P058/03.50	€ 1,14	3,50 mm	70 mm	39 mm	10
P058/03.75	€ 1,14	3,75 mm	70 mm	39 mm	10
P058/04.00	€ 1,14	4 mm	75 mm	43 mm	10
P058/04.25	€ 1,53	4,25 mm	75 mm	43 mm	10
P058/04.50	€ 1,53	4,50 mm	80 mm	47 mm	10
P058/04.75	€ 1,53	4,75 mm	80 mm	47 mm	10
P058/05.00	€ 1,53	5 mm	86 mm	52 mm	10
P058/05.25	€ 1,89	5,25 mm	86 mm	52 mm	10
P058/05.50	€ 1,89	5,50 mm	93 mm	57 mm	10
P058/05.75	€ 1,89	5,75 mm	93 mm	57 mm	10
P058/06.00	€ 1,89	6 mm	93 mm	57 mm	10
P058/06.25	€ 2,09	6,25 mm	101 mm	63 mm	10
P058/06.50	€ 2,09	6,50 mm	101 mm	63 mm	10
P058/06.75	€ 2,09	6,75 mm	109 mm	69 mm	10
P058/07.00	€ 2,09	7 mm	109 mm	69 mm	10
P058/07.25	€ 3,22	7,25 mm	109 mm	69 mm	10
P058/07.50	€ 3,22	7,50 mm	109 mm	69 mm	10
P058/07.75	€ 3,22	7,75 mm	117 mm	75 mm	10
P058/08.00	€ 3,22	8 mm	117 mm	75 mm	10
P058/08.25	€ 4,40	8,25 mm	117 mm	75 mm	5
P058/08.50	€ 4,40	8,50 mm	117 mm	75 mm	5
P058/08.75	€ 4,40	8,75 mm	125 mm	81 mm	5
P058/09.00	€ 4,40	9 mm	125 mm	81 mm	5
P058/09.25	€ 5,10	9,25 mm	125 mm	81 mm	5
P058/09.50	€ 5,10	9,50 mm	125 mm	81 mm	5
P058/09.75	€ 5,10	9,75 mm	133 mm	87 mm	5
P058/10.00	€ 5,10	10 mm	133 mm	87 mm	5
P058/10.25	€ 5,80	10,25 mm	133 mm	87 mm	5
P058/10.50	€ 5,80	10,50 mm	133 mm	87 mm	5
P058/10.75	€ 5,80	10,75 mm	142 mm	94 mm	5
P058/11.00	€ 5,80	11 mm	142 mm	94 mm	5
P058/11.25	€ 6,70	11,25 mm	142 mm	94 mm	5
P058/11.50	€ 6,70	11,50 mm	142 mm	94 mm	5
P058/11.75	€ 6,70	11,75 mm	142 mm	94 mm	5
P058/12.00	€ 6,70	12 mm	151 mm	101 mm	5
P058/12.25	€ 8,40	12,25 mm	151 mm	101 mm	5
P058/12.50	€ 8,40	12,50 mm	151 mm	101 mm	5
P058/12.75	€ 8,40	12,75 mm	151 mm	101 mm	5
P058/13.00	€ 8,40	13 mm	151 mm	101 mm	5

	HSS		TiN
Scatola		Rettificato	
338/N	135°	HV=740-780	-8xD
Re700N/mm²	Acciaio	Alluminio	Leghe non ferrose
Ghisa	Emulsione	Tornio	Fresatrice

P058/170

€ 186,00

SERIE PUNTE



150 (10x) Pz (progressione 0,5 mm) Ø 8 mm
20 (5x) Pz (progressione 0,5 mm) Ø 8,5-10 mm

P010/51

€ 64,10

SERIE PUNTE CILINDRICHE A DECIMI

Destra, lunga durata grazie al rivestimento in titanio.



Misura (progressione 0,1 mm) 1 ÷ 6 mm

P010/41

€ 149,00

SERIE PUNTE CILINDRICHE A DECIMI

Destra, lunga durata grazie al rivestimento in titanio.



Misura (progressione 0,1 mm) 6 ÷ 10 mm

P062

€ 70,60

SERIE PUNTE



Misura (progressione 0,5 mm) 1 ÷ 13 mm

P061

€ 39,50

SERIE PUNTE CILINDRICHE RETTIFICATE

Destra, lunga durata grazie al rivestimento in titanio.



Misura (progressione 0,5 mm) 1 ÷ 10 mm

P068

€ 7,90

SERIE PUNTE

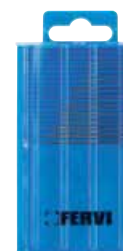

Misure x 1Pz 0.25 - 0.30 - 0.35 - 0.40 - 0.45 - 0.55
- 0.65 - 0.70 - 0.75 - 0.85 - 0.90 - 0.95 mm
Misure x 2 Pz 0.50 - 0.60 - 0.80 - 1.00 mm

P065-
PUNTA ELICOIDALE CILINDRICA AL COBALTO

Autocentrante, destra, con grande resistenza termica

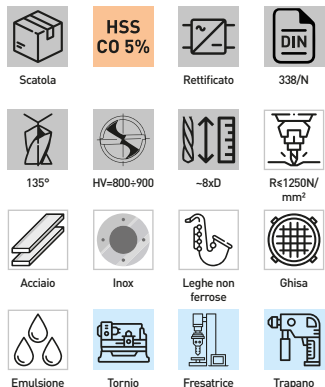
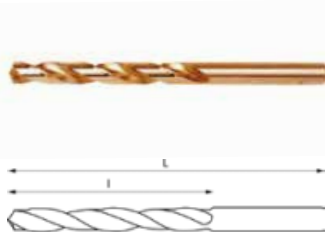

Art.	€	Ø	Lunghezza totale	Lunghezza elica	Pack
P065/01.00	€ 1,07	1 mm	34 mm	12 mm	10
P065/01.25	€ 1,29	1,25 mm	38 mm	16 mm	10
P065/01.50	€ 1,29	1,50 mm	40 mm	18 mm	10
P065/01.75	€ 1,29	1,75 mm	46 mm	22 mm	10
P065/02.00	€ 1,29	2 mm	49 mm	24 mm	10
P065/02.25	€ 1,49	2,25 mm	53 mm	27 mm	10
P065/02.50	€ 1,49	2,50 mm	57 mm	30 mm	10
P065/02.75	€ 1,49	2,75 mm	61 mm	33 mm	10
P065/03.00	€ 1,49	3 mm	61 mm	33 mm	10
P065/03.25	€ 2,05	3,25 mm	69 mm	39 mm	10
P065/03.50	€ 2,05	3,50 mm	70 mm	39 mm	10
P065/03.75	€ 2,05	3,75 mm	70 mm	39 mm	10
P065/04.00	€ 2,05	4 mm	75 mm	43 mm	10
P065/04.25	€ 2,89	4,25 mm	75 mm	43 mm	10
P065/04.50	€ 2,89	4,50 mm	80 mm	47 mm	10
P065/04.75	€ 2,89	4,75 mm	80 mm	47 mm	10
P065/05.00	€ 2,89	5 mm	86 mm	52 mm	10
P065/05.25	€ 3,63	5,25 mm	86 mm	52 mm	10
P065/05.50	€ 3,63	5,50 mm	93 mm	57 mm	10
P065/05.75	€ 3,63	5,75 mm	93 mm	57 mm	10
P065/06.00	€ 3,63	6 mm	93 mm	57 mm	10
P065/06.25	€ 4,48	6,25 mm	101 mm	63 mm	10
P065/06.50	€ 4,48	6,50 mm	101 mm	63 mm	10
P065/06.75	€ 4,48	6,75 mm	109 mm	69 mm	10
P065/07.00	€ 4,48	7 mm	109 mm	69 mm	10
P065/07.25	€ 7,80	7,25 mm	109 mm	69 mm	10
P065/07.50	€ 7,80	7,50 mm	109 mm	69 mm	10
P065/07.75	€ 7,80	7,75 mm	117 mm	75 mm	10
P065/08.00	€ 7,80	8 mm	117 mm	75 mm	5
P065/08.25	€ 9,60	8,25 mm	117 mm	75 mm	5
P065/08.50	€ 9,60	8,50 mm	117 mm	75 mm	5
P065/08.75	€ 9,60	8,75 mm	125 mm	81 mm	5
P065/09.00	€ 9,60	9 mm	125 mm	81 mm	5
P065/09.25	€ 12,10	9,25 mm	125 mm	81 mm	5
P065/09.50	€ 12,10	9,50 mm	125 mm	81 mm	5
P065/09.75	€ 12,10	9,75 mm	133 mm	87 mm	5
P065/10.00	€ 12,10	10 mm	133 mm	87 mm	5
P065/10.25	€ 14,50	10,25 mm	133 mm	87 mm	5
P065/10.50	€ 14,50	10,50 mm	133 mm	87 mm	5
P065/10.75	€ 14,50	10,75 mm	142 mm	94 mm	5
P065/11.00	€ 14,50	11 mm	142 mm	94 mm	5
P065/11.25	€ 17,30	11,25 mm	142 mm	94 mm	5
P065/11.50	€ 17,30	11,50 mm	142 mm	94 mm	5
P065/11.75	€ 17,30	11,75 mm	142 mm	94 mm	5
P065/12.00	€ 17,30	12 mm	151 mm	101 mm	5
P065/12.25	€ 21,00	12,25 mm	151 mm	101 mm	5
P065/12.50	€ 21,00	12,50 mm	151 mm	101 mm	5
P065/12.75	€ 21,00	12,75 mm	151 mm	101 mm	5
P065/13.00	€ 21,00	13 mm	151 mm	101 mm	5

P067
€ 70,60
SERIE PUNTE AL COBALTO

Autocentrante, destra, con grande resistenza termica.



19 Pcs

Misura (progressione 0,5 mm)

1 ÷ 10 mm

P069
€ 139,00
SERIE PUNTE AL COBALTO

Autocentrante, destra, con grande resistenza termica.



25 Pcs

Misura (progressione 0,5 mm)

1 ÷ 13 mm





P064-

PUNTA CILINDRICA RETTIFICATA

Autocentrante, destra, con grande resistenza termica.

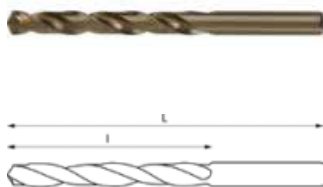

Art.	€	ø	L	l	Pack
P064/01.00	€ 1,49	01.00 mm	34 mm	12 mm	10
P064/01.25	€ 1,49	01.25 mm	38 mm	16 mm	10
P064/01.50	€ 1,49	01.50 mm	40 mm	18 mm	10
P064/01.75	€ 1,49	01.75 mm	46 mm	22 mm	10
P064/02.00	€ 1,49	02.00 mm	49 mm	24 mm	10
P064/02.25	€ 1,73	02.25 mm	53 mm	27 mm	10
P064/02.50	€ 1,73	02.50 mm	57 mm	30 mm	10
P064/02.75	€ 1,73	02.75 mm	61 mm	33 mm	10
P064/03.00	€ 1,73	03.00 mm	61 mm	33 mm	10
P064/03.25	€ 2,37	03.25 mm	69 mm	39 mm	10
P064/03.50	€ 2,37	03.50 mm	70 mm	39 mm	10
P064/03.75	€ 2,37	03.75 mm	70 mm	39 mm	10
P064/04.00	€ 2,37	04.00 mm	75 mm	43 mm	10
P064/04.25	€ 3,34	04.25 mm	75 mm	43 mm	10
P064/04.50	€ 3,34	04.50 mm	80 mm	47 mm	10
P064/04.75	€ 3,34	04.75 mm	80 mm	47 mm	10
P064/05.00	€ 3,34	05.00 mm	86 mm	52 mm	10
P064/05.25	€ 4,22	05.25 mm	86 mm	52 mm	10
P064/05.50	€ 4,22	05.50 mm	93 mm	57 mm	10
P064/05.75	€ 4,22	05.75 mm	93 mm	57 mm	10
P064/06.00	€ 4,22	06.00 mm	93 mm	57 mm	10
P064/06.25	€ 5,10	06.25 mm	101 mm	63 mm	10
P064/06.50	€ 5,10	06.50 mm	101 mm	63 mm	10
P064/06.75	€ 5,10	06.75 mm	109 mm	69 mm	10
P064/07.00	€ 5,10	07.00 mm	109 mm	69 mm	10
P064/07.25	€ 8,90	07.25 mm	109 mm	69 mm	10
P064/07.50	€ 8,90	07.50 mm	109 mm	69 mm	10
P064/07.75	€ 8,90	07.75 mm	117 mm	75 mm	10
P064/08.00	€ 8,90	08.00 mm	117 mm	75 mm	5
P064/08.25	€ 11,10	08.25 mm	117 mm	75 mm	5
P064/08.50	€ 11,10	08.50 mm	117 mm	75 mm	5
P064/08.75	€ 11,10	08.75 mm	125 mm	81 mm	5
P064/09.00	€ 11,10	09.00 mm	125 mm	81 mm	5
P064/09.25	€ 14,00	09.25 mm	125 mm	81 mm	5
P064/09.50	€ 14,00	09.50 mm	125 mm	81 mm	5
P064/09.75	€ 14,00	09.75 mm	133 mm	87 mm	5
P064/10.00	€ 14,00	10.00 mm	133 mm	87 mm	5
P064/10.25	€ 16,80	10.25 mm	133 mm	87 mm	5
P064/10.50	€ 16,80	10.50 mm	133 mm	87 mm	5
P064/10.75	€ 16,80	10.75 mm	142 mm	94 mm	5
P064/11.00	€ 16,80	11.00 mm	142 mm	94 mm	5
P064/11.25	€ 20,10	11.25 mm	142 mm	94 mm	5
P064/11.50	€ 20,10	11.50 mm	142 mm	94 mm	5
P064/11.75	€ 20,10	11.75 mm	142 mm	94 mm	5
P064/12.00	€ 20,10	12.00 mm	151 mm	101 mm	5
P064/12.25	€ 24,40	12.25 mm	151 mm	101 mm	5
P064/12.50	€ 24,40	12.50 mm	151 mm	101 mm	5
P064/12.75	€ 24,40	12.75 mm	151 mm	101 mm	5
P064/13.00	€ 24,40	13.00 mm	151 mm	101 mm	5

P064/19A

€ 85,40

SERIE PUNTE AL COBALTO

Autocentrante, destra, con grande resistenza termica.



Misura (progressione 0,5 mm) 1 ÷ 10 mm

P064/25A

€ 182,00

SERIE PUNTE AL COBALTO

Autocentrante, destra, con grande resistenza termica.



Misura (progressione 0,5 mm) 1 ÷ 13 mm



ST2AX

PUNTA ELICOIDALE A CODOLO CONICO

Destra

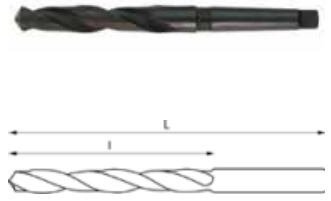
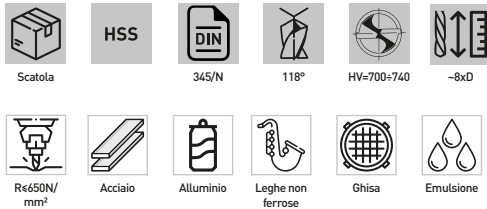

Art.	€	Ø	CM	L	l
ST2A05.75	€ 8,80	5,75 mm	1	138 mm	57 mm
ST2A06	€ 8,80	6,00 mm	1	138 mm	57 mm
ST2A06.25	€ 8,80	6,25 mm	1	144 mm	63 mm
ST2A06.50	€ 8,80	6,50 mm	1	144 mm	63 mm
ST2A06.75	€ 8,80	6,75 mm	1	150 mm	69 mm
ST2A07	€ 8,80	7,00 mm	1	150 mm	69 mm
ST2A07.25	€ 8,80	7,25 mm	1	150 mm	69 mm
ST2A07.50	€ 8,80	7,50 mm	1	150 mm	69 mm
ST2A07.75	€ 8,80	7,75 mm	1	156 mm	75 mm
ST2A08	€ 8,80	8,00 mm	1	156 mm	75 mm
ST2A08.25	€ 8,80	8,25 mm	1	156 mm	75 mm
ST2A08.50	€ 8,80	8,50 mm	1	156 mm	75 mm
ST2A08.75	€ 8,80	8,75 mm	1	156 mm	75 mm
ST2A09	€ 8,80	9,00 mm	1	162 mm	81 mm
ST2A09.25	€ 8,80	9,25 mm	1	162 mm	81 mm
ST2A09.50	€ 8,80	9,50 mm	1	162 mm	81 mm
ST2A09.75	€ 8,80	9,75 mm	1	162 mm	81 mm
ST2A10	€ 8,80	10,00 mm	1	168 mm	81 mm
ST2A10.25	€ 10,20	10,25 mm	1	168 mm	87 mm
ST2A10.50	€ 10,20	10,50 mm	1	168 mm	87 mm
ST2A10.75	€ 10,20	10,75 mm	1	175 mm	87 mm
ST2A11	€ 10,20	11,00 mm	1	175 mm	94 mm
ST2A11.25	€ 10,20	11,25 mm	1	175 mm	94 mm
ST2A11.50	€ 10,20	11,50 mm	1	175 mm	94 mm
ST2A11.75	€ 10,20	11,75 mm	1	175 mm	94 mm
ST2A12	€ 10,20	12,00 mm	1	182 mm	94 mm
ST2A12.25	€ 11,70	12,25 mm	1	182 mm	101 mm
ST2A12.50	€ 11,70	12,50 mm	1	182 mm	101 mm
ST2A12.75	€ 11,70	12,75 mm	1	182 mm	101 mm
ST2A13	€ 11,70	13,00 mm	1	182 mm	101 mm
ST2A13.25	€ 11,70	13,25 mm	1	182 mm	101 mm
ST2A13.50	€ 11,70	13,50 mm	1	189 mm	108 mm
ST2A13.75	€ 11,70	13,75 mm	1	189 mm	108 mm
ST2A14	€ 11,70	14,00 mm	1	189 mm	108 mm
ST2A14.25	€ 11,70	14,25 mm	2	212 mm	114 mm
ST2A14.50	€ 11,70	14,50 mm	2	212 mm	114 mm
ST2A14.75	€ 11,70	14,75 mm	2	212 mm	114 mm
ST2A15	€ 11,70	15,00 mm	2	212 mm	114 mm
ST2A15.25	€ 17,30	15,25 mm	2	218 mm	120 mm
ST2A15.50	€ 17,30	15,50 mm	2	218 mm	120 mm
ST2A15.75	€ 17,30	15,75 mm	2	218 mm	120 mm
ST2A16	€ 17,30	16,00 mm	2	218 mm	120 mm
ST2A16.25	€ 17,30	16,25 mm	2	223 mm	125 mm
ST2A16.50	€ 17,30	16,50 mm	2	223 mm	125 mm
ST2A16.75	€ 17,30	16,75 mm	2	223 mm	125 mm
ST2A17	€ 17,30	17,00 mm	2	223 mm	125 mm
ST2A17.25	€ 17,30	17,25 mm	2	228 mm	130 mm
ST2A17.50	€ 17,30	17,50 mm	2	228 mm	130 mm
ST2A17.75	€ 17,30	17,75 mm	2	228 mm	130 mm
ST2A18	€ 21,20	18,00 mm	2	228 mm	130 mm
ST2A18.25	€ 21,20	18,25 mm	2	233 mm	135 mm
ST2A18.50	€ 21,20	18,50 mm	2	233 mm	135 mm
ST2A18.75	€ 21,20	18,75 mm	2	233 mm	135 mm
ST2A19	€ 21,20	19,00 mm	2	233 mm	135 mm
ST2A19.25	€ 22,50	19,25 mm	2	238 mm	140 mm
ST2A19.50	€ 22,50	19,50 mm	2	238 mm	130 mm
ST2A19.75	€ 22,50	19,75 mm	2	238 mm	140 mm
ST2A20	€ 22,50	20,00 mm	2	238 mm	140 mm
ST2A20.25	€ 22,50	20,25 mm	2	243 mm	145 mm
ST2A20.50	€ 26,00	20,50 mm	2	243 mm	145 mm
ST2A20.75	€ 26,00	20,75 mm	2	243 mm	145 mm
ST2A21	€ 26,00	21,00 mm	2	243 mm	145 mm
ST2A21.25	€ 28,70	21,25 mm	2	248 mm	150 mm
ST2A21.50	€ 28,70	21,50 mm	2	248 mm	150 mm
ST2A21.75	€ 28,70	21,75 mm	2	248 mm	150 mm
ST2A22	€ 28,70	22,00 mm	2	248 mm	150 mm
ST2A22.25	€ 30,10	22,25 mm	2	248 mm	150 mm

Art.	€	Ø	CM	L	l
ST2A22.50	€ 30,10	22,50 mm	2	253 mm	155 mm
ST2A22.75	€ 30,10	22,75 mm	2	253 mm	155 mm
ST2A23	€ 30,10	23,00 mm	2	253 mm	155 mm
ST2A23.25	€ 30,10	23,25 mm	3	276 mm	155 mm
ST2A23.50	€ 33,30	23,50 mm	3	276 mm	155 mm
ST2A23.75	€ 33,30	23,75 mm	3	281 mm	160 mm
ST2A24	€ 33,30	24,00 mm	3	281 mm	160 mm
ST2A24.25	€ 36,90	24,25 mm	3	281 mm	160 mm
ST2A24.50	€ 36,90	24,50 mm	3	281 mm	160 mm
ST2A24.75	€ 36,90	24,75 mm	3	281 mm	160 mm
ST2A25	€ 36,90	25,00 mm	3	281 mm	160 mm
ST2A25.25	€ 39,50	25,25 mm	3	281 mm	160 mm
ST2A25.50	€ 39,50	25,50 mm	3	281 mm	160 mm
ST2A25.75	€ 39,50	25,75 mm	3	281 mm	160 mm
ST2A26	€ 39,50	26,00 mm	3	286 mm	165 mm
ST2A26.25	€ 46,70	26,25 mm	3	286 mm	165 mm
ST2A26.50	€ 46,70	26,50 mm	3	286 mm	165 mm
ST2A26.75	€ 46,70	26,75 mm	3	291 mm	170 mm
ST2A27	€ 46,70	27,00 mm	3	291 mm	170 mm
ST2A27.25	€ 46,70	27,25 mm	3	291 mm	170 mm
ST2A27.50	€ 46,70	27,50 mm	3	291 mm	170 mm
ST2A27.75	€ 46,70	27,75 mm	3	291 mm	170 mm
ST2A28	€ 46,70	28,00 mm	3	291 mm	170 mm
ST2A28.25	€ 52,50	28,25 mm	3	296 mm	175 mm
ST2A28.50	€ 52,50	28,50 mm	3	296 mm	175 mm
ST2A28.75	€ 52,50	28,75 mm	3	296 mm	175 mm
ST2A29	€ 52,50	29,00 mm	3	296 mm	175 mm
ST2A29.25	€ 52,50	29,25 mm	3	296 mm	175 mm
ST2A29.50	€ 52,50	29,50 mm	3	296 mm	175 mm
ST2A29.75	€ 52,50	29,75 mm	3	296 mm	175 mm
ST2A30	€ 52,50	30,00 mm	3	296 mm	175 mm
ST2A30.25	€ 53,40	30,25 mm	3	301 mm	180 mm
ST2A30.50	€ 53,40	30,50 mm	3	301 mm	180 mm
ST2A30.75	€ 53,40	30,75 mm	3	301 mm	180 mm
ST2A31	€ 53,40	31,00 mm	3	301 mm	180 mm
ST2A31.25	€ 55,70	31,25 mm	3	301 mm	180 mm
ST2A31.50	€ 55,70	31,50 mm	3	301 mm	180 mm
ST2A31.75	€ 55,70	31,75 mm	4	306 mm	185 mm
ST2A32	€ 55,70	32,00 mm	4	334 mm	185 mm
ST2A32.50	€ 73,10	32,50 mm	4	334 mm	185 mm
ST2A33	€ 73,10	33,00 mm	4	334 mm	185 mm
ST2A33.50	€ 73,10	33,50 mm	4	334 mm	185 mm
ST2A34	€ 73,10	34,00 mm	4	339 mm	190 mm
ST2A34.50	€ 73,10	34,50 mm	4	339 mm	190 mm
ST2A35	€ 73,10	35,00 mm	4	339 mm	190 mm
ST2A35.50	€ 85,40	35,50 mm	4	339 mm	190 mm
ST2A36	€ 85,40	36,00 mm	4	344 mm	195 mm
ST2A36.50	€ 85,40	36,50 mm	4	344 mm	195 mm
ST2A37	€ 85,40	37,00 mm	4	344 mm	195 mm
ST2A37.50	€ 85,40	37,50 mm	4	344 mm	195 mm
ST2A38	€ 85,40	38,00 mm	4	349 mm	200 mm
ST2A38.50	€ 98,30	38,50 mm	4	349 mm	200 mm
ST2A39	€ 98,30	39,00 mm	4	349 mm	200 mm
ST2A39.50	€ 98,30	39,50 mm	4	349 mm	200 mm
ST2A40	€ 98,30	40,00 mm	4	349 mm	200 mm
ST2A40.50	€ 110,00	40,50 mm	4	354 mm	205 mm
ST2A41	€ 110,00	41,00 mm	4	354 mm	205 mm
ST2A41.50	€ 110,00	41,50 mm	4	354 mm	205 mm
ST2A42	€ 110,00	42,00 mm	4	354 mm	205 mm
ST2A42.50	€ 122,00	42,50 mm	4	354 mm	205 mm
ST2A43	€ 122,00	43,00 mm	4	359 mm	210 mm
ST2A43.50	€ 122,00	43,50 mm	4	359 mm	210 mm
ST2A44	€ 122,00	44,00 mm	4	359 mm	210 mm
ST2A44.50	€ 122,00	44,50 mm	4	359 mm	210 mm
ST2A45	€ 135,00	45,00 mm	4	359 mm	210 mm
ST2A45.50	€ 135,00	45,50 mm	4	364 mm	215 mm
ST2A46	€ 135,00	46,00 mm	4	364 mm	215 mm

Art.	€	Ø	CM	L	l
ST2A46.50	€ 158,00	46,50 mm	4	364 mm	215 mm
ST2A47	€ 158,00	47,00 mm	4	364 mm	215 mm
ST2A47.50	€ 158,00	47,50 mm	4	364 mm	215 mm
ST2A48	€ 158,00	48,00 mm	4	369 mm	220 mm
ST2A48.50	€ 174,00	48,50 mm	4	369 mm	220 mm
ST2A49	€ 174,00	49,00 mm	4	369 mm	220 mm
ST2A49.50	€ 174,00	49,50 mm	4	369 mm	220 mm
ST2A50	€ 177,00	50,00 mm	4	369 mm	220 mm
ST2A50.50	€ 182,00	50,50 mm	4	374 mm	225 mm
ST2A51	€ 188,00	51,00 mm	5	412 mm	225 mm
ST2A51.50	€ 194,00	51,50 mm	5	412 mm	225 mm
ST2A52	€ 205,00	52,00 mm	5	412 mm	225 mm
ST2A53	€ 205,00	53,00 mm	5	412 mm	225 mm
ST2A54	€ 205,00	54,00 mm	5	417 mm	230 mm
ST2A55	€ 205,00	55,00 mm	5	417 mm	230 mm
ST2A56	€ 238,00	56,00 mm	5	417 mm	230 mm
ST2A57	€ 238,00	57,00 mm	5	422 mm	235 mm
ST2A58	€ 238,00	58,00 mm	5	422 mm	235 mm
ST2A59	€ 238,00	59,00 mm	5	422 mm	235 mm
ST2A60	€ 238,00	60,00 mm	5	422 mm	235 mm
ST2A61	€ 285,00	61,00 mm	5	427 mm	240 mm
ST2A62	€ 308,00	62,00 mm	5	427 mm	240 mm
ST2A63	€ 353,00	63,00 mm	5	427 mm	240 mm
ST2A65	€ 353,00	65,00 mm	5	432 mm	245 mm
ST2A66	€ 353,00	66,00 mm	5	432 mm	245 mm
ST2A67	€ 357,00	67,00 mm	5	432 mm	245 mm
ST2A68	€ 366,00	68,00 mm	5	437 mm	250 mm
ST2A69	€ 371,00	69,00 mm	5	437 mm	250 mm
ST2A70	€ 371,00	70,00 mm	5	437 mm	250 mm
ST2A71	€ 371,00	71,00 mm	5	437 mm	250 mm
ST2A72	€ 371,00	72,00 mm	5	442 mm	255 mm
ST2A73	€ 420,00	73,00 mm	5	442 mm	255 mm
ST2A74	€ 420,00	74,00 mm	5	442 mm	255 mm
ST2A75	€ 440,00	75,00 mm	5	442 mm	255 mm
ST2A77	€ 513,00	77,00 mm	6	514 mm	260 mm
ST2A78	€ 674,00	78,00 mm	6	514 mm	260 mm
ST2A79	€ 881,00	79,00 mm	6	514 mm	260 mm

P057 € 107,00

SERIE PUNTE ELICOIDALI A CODOLO CONICO

Destra.



Misure	CM1: 14 mm
CM	1 - 14 mm
Misure	CM2: 15 - 16 - 17 - 18 - 19 - 20 - 21 - 22 - 23 mm



P081-

PUNTA DA CENTRO PER MACCHINE CN

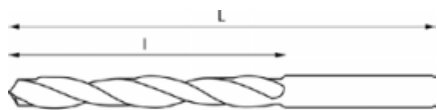

Art.	€	ø	l	L
P081/03	€ 6,70	3 mm	17 mm	46 mm
P081/04	€ 8,70	4 mm	20 mm	55 mm
P081/05	€ 10,70	5 mm	25 mm	60 mm
P081/06	€ 12,90	6 mm	27 mm	66 mm
P081/08	€ 18,30	8 mm	30 mm	79 mm
P081/10	€ 23,40	10 mm	35 mm	89 mm
P081/12	€ 32,80	12 mm	30 mm	102 mm
P081/16	€ 53,00	16 mm	35 mm	115 mm
P081/20	€ 73,90	20 mm	40 mm	131 mm

P056-

PUNTA DA CENTRO

Rettificata, con scanalature vaporizzate. Angolo conicità 60°.



Art.	€	ø	Gambo	Lunghezza
P056/1	€ 2,57	1 mm	ø 3 mm	30,5 mm
P056/1.6	€ 2,57	1,6 mm	ø 4 mm	35,5 mm
P056/2	€ 3,85	2 mm	ø 5 mm	40 mm
P056/2.5	€ 4,06	2,5 mm	ø 6,3 mm	45 mm
P056/3.15	€ 4,48	3,15 mm	ø 8 mm	50 mm
P056/4	€ 8,00	4 mm	ø 10 mm	56 mm
P056/5	€ 10,70	5 mm	ø 12,5 mm	63 mm

P056/10S

€ 36,40

SERIE PUNTE DA CENTRO

Rettificata, con scanalature vaporizzate. Angolo conicità 60°.



Misure	0.75 - 1.00 - 1.5 - 1.6 - 2.0 - 2.5 - 3.0 - 3.15 - 4.0 - 5.0 mm
Tipo	A
Tolleranza	K12



SEGHE A CAROTARE

Utensili progettati per forare e lavorare materiali metallici. Sono punte cilindriche con una sezione circolare dentata. Si montano al mandrino di appositi utensili come macchine foratrici, trapani a base magnetica e trapani a colonna. A differenza delle frese a tazza, che presentano una corona che mantiene all'interno il materiale da asportare, queste frese lavorano il materiale per asportazione del truciolo attraverso i taglienti laterali dell'utensile.



N° DI GIRI TEORICI PER SEGHE A CAROTARE IN FUNZIONE AL MATERIALE DA LAVORARE

Materiale da lavorare	Tipo Sega	Ø Sega							Refrigerante
		12 - 15	16 - 20	21 - 25	26 - 30	31 - 35	36 - 49	50 - 60	
		n. di giri (rpm)							
Acciaio da costruzione basso legato R< 700÷900N/mm ²	HSS	700	530	420	340	290	240	170	Emulsione
	HSS-Co5%	875	663	525	425	363	300	213	Emulsione
Acciaio legato R<1100÷1300N/mm ²	HSS	470	350	270	230	190	160	120	Emulsione
	HSS-Co5%	588	438	338	288	238	200	150	Emulsione
Acciaio Inox	HSS	470	350	270	230	190	160	120	Emulsione
	HSS-Co5%	588	438	338	288	238	200	150	Emulsione
Ghisa	HSS	240	180	140	120	100	80	60	No refriger.
Leghe Leggere	HSS	700	530	420	340	290	240	170	No refriger.
Plastica	HSS	830	620	480	400	340	280	200	No refriger.





F011-

SEGA A CAROTARE CON ATTACCO WELDON

Permette un taglio molto veloce, non necessita di preforo e non crea nessuna formazione di bava grazie al minor sforzo del tagliente durante la lavorazione.

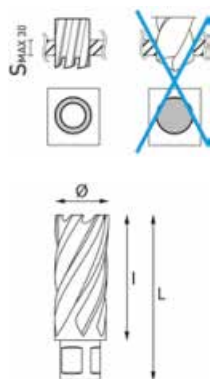

Art.	€	Capacità di taglio	Ø	Lunghezza totale
F011/12	€ 24,70	30 mm	12 mm	62 mm
F011/13	€ 25,70	30 mm	13 mm	62 mm
F011/14	€ 29,80	30 mm	14 mm	62 mm
F011/15	€ 30,80	30 mm	15 mm	62 mm
F011/16	€ 32,90	30 mm	16 mm	62 mm
F011/17	€ 33,90	30 mm	17 mm	62 mm
F011/18	€ 35,90	30 mm	18 mm	62 mm
F011/19	€ 36,90	30 mm	19 mm	62 mm
F011/20	€ 38,00	30 mm	20 mm	62 mm
F011/21	€ 38,50	30 mm	21 mm	62 mm
F011/22	€ 40,00	30 mm	22 mm	62 mm
F011/23	€ 41,10	30 mm	23 mm	62 mm
F011/24	€ 43,70	30 mm	24 mm	62 mm
F011/25	€ 45,30	30 mm	25 mm	62 mm
F011/26	€ 51,30	30 mm	26 mm	62 mm
F011/27	€ 52,80	30 mm	27 mm	62 mm
F011/28	€ 54,40	30 mm	28 mm	62 mm
F011/29	€ 56,00	30 mm	29 mm	62 mm
F011/30	€ 57,40	30 mm	30 mm	62 mm
F011/31	€ 60,00	30 mm	31 mm	62 mm
F011/32	€ 61,60	30 mm	32 mm	62 mm
F011/33	€ 63,40	30 mm	33 mm	62 mm
F011/34	€ 65,20	30 mm	34 mm	62 mm
F011/35	€ 66,70	30 mm	35 mm	62 mm
F011/36	€ 68,60	30 mm	36 mm	62 mm
F011/37	€ 70,40	30 mm	37 mm	62 mm
F011/38	€ 72,70	30 mm	38 mm	62 mm
F011/39	€ 74,80	30 mm	39 mm	62 mm
F011/40	€ 76,00	30 mm	40 mm	62 mm
F011/41	€ 87,80	30 mm	41 mm	62 mm
F011/42	€ 89,80	30 mm	42 mm	62 mm
F011/43	€ 91,40	30 mm	43 mm	62 mm
F011/44	€ 93,30	30 mm	44 mm	62 mm
F011/45	€ 109,00	30 mm	45 mm	62 mm
F011/46	€ 111,00	30 mm	46 mm	62 mm
F011/47	€ 113,00	30 mm	47 mm	62 mm
F011/48	€ 117,00	30 mm	48 mm	62 mm
F011/49	€ 119,00	30 mm	49 mm	62 mm
F011/50	€ 121,00	30 mm	50 mm	62 mm
F011/51	€ 131,00	30 mm	51 mm	62 mm
F011/52	€ 133,00	30 mm	52 mm	62 mm
F011/53	€ 135,00	30 mm	53 mm	62 mm
F011/54	€ 139,00	30 mm	54 mm	62 mm
F011/55	€ 144,00	30 mm	55 mm	62 mm
F011/60	€ 168,00	30 mm	60 mm	62 mm

F011/6

€ 194,00

SERIE DI TAZZE A CAROTARE CON ATTACCO WELDON

Permette un taglio molto veloce, non necessita di preforo e non crea nessuna formazione di bava grazie al minor sforzo del tagliente durante la lavorazione.

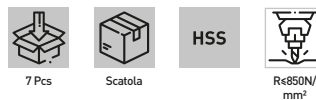

Misure	12 x 62 - 14 x 62 - 16 x 62 - 18 x 62 - 20 x 62 - 22 x 62 mm
Capacità di taglio	30 mm
Attacco	Weldon 19,05 mm

F011-XP

PUNTE CON ATTACCO WELDON

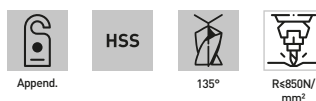

Art.	€	Ø	l	L
F011/006P	€ 30,10	6 mm	30 mm	62 mm
F011/007P	€ 30,10	7 mm	30 mm	62 mm
F011/008P	€ 30,10	8 mm	30 mm	62 mm
F011/009P	€ 33,30	9 mm	30 mm	62 mm
F011/010P	€ 33,30	10 mm	30 mm	62 mm
F011/011P	€ 36,40	11 mm	30 mm	62 mm

F002-
SEGA A CAROTARE CON ATTACCO WELDON

Permette un taglio molto veloce, non necessita di preforo e non crea nessuna formazione di bava grazie al minor sforzo del tagliente durante la lavorazione.

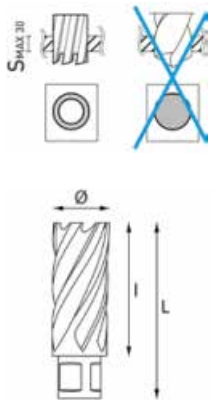

Art.	€	Ø	Capacità di taglio	Lunghezza totale
F002/12	€ 40,80	12 mm	30 mm	62 mm
F002/13	€ 43,20	13 mm	30 mm	62 mm
F002/14	€ 47,10	14 mm	30 mm	62 mm
F002/15	€ 51,30	15 mm	30 mm	62 mm
F002/16	€ 53,30	16 mm	30 mm	62 mm
F002/17	€ 53,30	17 mm	30 mm	62 mm
F002/18	€ 53,30	18 mm	30 mm	62 mm
F002/19	€ 54,40	19 mm	30 mm	62 mm
F002/20	€ 56,50	20 mm	30 mm	62 mm
F002/21	€ 58,50	21 mm	30 mm	62 mm
F002/22	€ 60,60	22 mm	30 mm	62 mm
F002/23	€ 62,10	23 mm	30 mm	62 mm
F002/24	€ 65,70	24 mm	30 mm	62 mm
F002/25	€ 67,70	25 mm	30 mm	62 mm
F002/26	€ 77,90	26 mm	30 mm	62 mm
F002/27	€ 81,20	27 mm	30 mm	62 mm
F002/28	€ 83,20	28 mm	30 mm	62 mm
F002/29	€ 84,10	29 mm	30 mm	62 mm
F002/30	€ 87,30	30 mm	30 mm	62 mm
F002/31	€ 91,40	31 mm	30 mm	62 mm
F002/32	€ 94,50	32 mm	30 mm	62 mm
F002/33	€ 102,00	33 mm	30 mm	62 mm
F002/34	€ 107,00	34 mm	30 mm	62 mm
F002/35	€ 110,00	35 mm	30 mm	62 mm
F002/36	€ 114,00	36 mm	30 mm	62 mm
F002/37	€ 120,00	37 mm	30 mm	62 mm
F002/38	€ 124,00	38 mm	30 mm	62 mm
F002/39	€ 129,00	39 mm	30 mm	62 mm
F002/40	€ 133,00	40 mm	30 mm	62 mm
F002/41	€ 139,00	41 mm	30 mm	62 mm
F002/42	€ 145,00	42 mm	30 mm	62 mm
F002/43	€ 148,00	43 mm	30 mm	62 mm
F002/44	€ 155,00	44 mm	30 mm	62 mm
F002/45	€ 166,00	45 mm	30 mm	62 mm
F002/46	€ 168,00	46 mm	30 mm	62 mm
F002/47	€ 172,00	47 mm	30 mm	62 mm
F002/48	€ 175,00	48 mm	30 mm	62 mm
F002/49	€ 181,00	49 mm	30 mm	62 mm
F002/50	€ 185,00	50 mm	30 mm	62 mm
F002/55	€ 215,00	55 mm	30 mm	62 mm
F002/60	€ 333,00	60 mm	30 mm	62 mm

F002/6
€ 297,00
SERIE SEGHE A CAROTARE CON ATTACCO WELDON

Permette un taglio molto veloce, non necessita di preforo e non crea nessuna formazione di bava grazie al minor sforzo del tagliente durante la lavorazione.

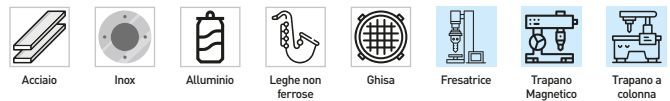
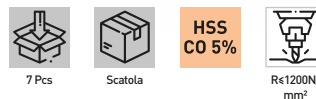

Misure Attacco 12 x 62 - 14 x 62 - 16 x 62 - 18 x 62 - 20 x 62 - 22 x 62 mm
Weldon 19,05 mm

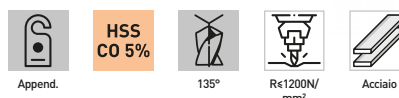
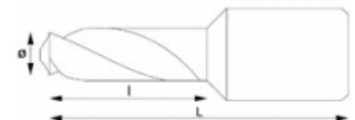
F002-XP
PUNTE CON ATTACCO WELDON

Art.	€	Ø	l	L
F002/006P	€ 28,00	6 mm	30 mm	62.50 mm
F002/007P	€ 28,00	7 mm	30 mm	62.50 mm
F002/008P	€ 28,00	8 mm	30 mm	62.50 mm
F002/009P	€ 28,00	9 mm	30 mm	62.50 mm
F002/010P	€ 28,00	10 mm	30 mm	62.50 mm
F002/011P	€ 28,00	11 mm	30 mm	62.50 mm



F002-XL

SEGA A CAROTARE LUNGA CON ATTACCO WELDON

Permette un taglio molto veloce, non necessita di preforo e non crea nessuna formazione di bava grazie al minor sforzo del tagliente durante la lavorazione.

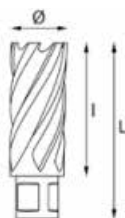
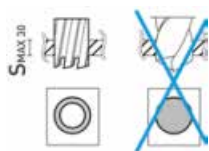

Art.	€	Ø	Capacità di taglio	Lunghezza totale
F002/12L	€ 57,40	12 mm	50 mm	85 mm
F002/13L	€ 58,50	13 mm	50 mm	85 mm
F002/14L	€ 68,80	14 mm	50 mm	85 mm
F002/15L	€ 69,80	15 mm	50 mm	85 mm
F002/16L	€ 75,00	16 mm	50 mm	85 mm
F002/17L	€ 77,90	17 mm	50 mm	85 mm
F002/18L	€ 81,20	18 mm	50 mm	85 mm
F002/19L	€ 83,20	19 mm	50 mm	85 mm
F002/20L	€ 85,20	20 mm	50 mm	85 mm
F002/21L	€ 87,30	21 mm	50 mm	85 mm
F002/22L	€ 89,30	22 mm	50 mm	85 mm
F002/23L	€ 91,40	23 mm	50 mm	85 mm
F002/24L	€ 96,50	24 mm	50 mm	85 mm
F002/25L	€ 98,50	25 mm	50 mm	85 mm
F002/26L	€ 114,00	26 mm	50 mm	85 mm
F002/27L	€ 117,00	27 mm	50 mm	85 mm
F002/28L	€ 120,00	28 mm	50 mm	85 mm
F002/29L	€ 122,00	29 mm	50 mm	85 mm
F002/30L	€ 124,00	30 mm	50 mm	85 mm
F002/31L	€ 131,00	31 mm	50 mm	85 mm
F002/32L	€ 134,00	32 mm	50 mm	85 mm
F002/33L	€ 135,00	33 mm	50 mm	85 mm
F002/34L	€ 140,00	34 mm	50 mm	85 mm
F002/35L	€ 142,00	35 mm	50 mm	85 mm
F002/36L	€ 147,00	36 mm	50 mm	85 mm
F002/37L	€ 148,00	37 mm	50 mm	85 mm
F002/38L	€ 153,00	38 mm	50 mm	85 mm
F002/39L	€ 158,00	39 mm	50 mm	85 mm
F002/40L	€ 159,00	40 mm	50 mm	85 mm
F002/41L	€ 185,00	41 mm	50 mm	85 mm
F002/42L	€ 188,00	42 mm	50 mm	85 mm
F002/43L	€ 192,00	43 mm	50 mm	85 mm
F002/44L	€ 195,00	44 mm	50 mm	85 mm
F002/45L	€ 234,00	45 mm	50 mm	85 mm
F002/46L	€ 237,00	46 mm	50 mm	85 mm
F002/47L	€ 240,00	47 mm	50 mm	85 mm
F002/48L	€ 245,00	48 mm	50 mm	85 mm
F002/49L	€ 249,00	49 mm	50 mm	85 mm
F002/50L	€ 253,00	50 mm	50 mm	85 mm
F002/55L	€ 298,00	55 mm	50 mm	85 mm
F002/60L	€ 344,00	60 mm	50 mm	85 mm

F002-XPL

PUNTE LUNGHE CON ATTACCO WELDON

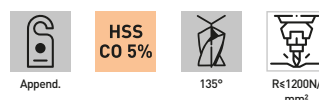
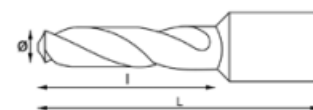

Art.	€	Ø	l	L
F002/006PL	€ 36,40	6 mm	55 mm	86.50 mm
F002/007PL	€ 36,40	7 mm	55 mm	86.50 mm
F002/008PL	€ 36,40	8 mm	55 mm	86.50 mm
F002/009PL	€ 36,40	9 mm	55 mm	86.50 mm
F002/010PL	€ 36,40	10 mm	55 mm	86.50 mm
F002/011PL	€ 36,40	11 mm	55 mm	86.50 mm

F002/P

€ 8,20

ESPULSORE

Per seghe a carotare.

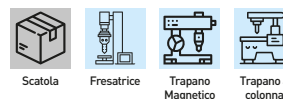

Dimensioni 6,35 x 77 mm

F002/PL

€ 10,20

ESPULSORE

Per seghe a carotare lunghe.

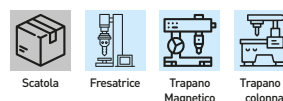

Dimensioni 6,35 x 102 mm

SEGHE A TAZZA CON INSERTI IN METALLO DURO



La geometria variabile dei denti in metallo duro consente il taglio di tubi, profilati e lamiere in acciaio inox, acciai alto-legati. Spessore massimo di taglio: 5 mm

N° DI GIRI TEORICI PER SEGHE A TAZZA CON INSERTI IN METALLO DURO IN FUNZIONE AL MATERIALE DA LAVORARE

Materiale da lavorare	Ø Sega							Refrigerante
	15 - 20	21 - 25	26 - 30	31 - 40	41 - 50	51 - 70	71 - 100	
	n. di giri (rpm)							
Acciaio legato R<1100÷1300N/mm ²	530	420	340	270	210	160	100	Emulsione
Acciaio Inox	530	420	340	270	210	160	100	Emulsione
Alluminio	880	690	570	450	350	270	190	Emulsione





F019-

SEGA A TAZZA CON INSERTI IN METALLO DURO

Con scarico truciolo laterale e punta pilota. Profondità massima di taglio 5 mm.

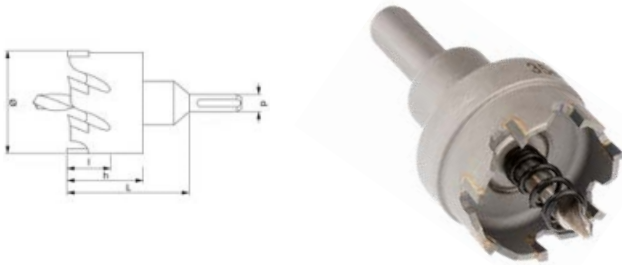

Art.	€	ø	h	d	L	Profondità di taglio	Filetto
F019/015	€ 13,10	15 mm	28 mm	10 mm	50 mm	5 mm	-
F019/016	€ 14,10	16 mm	28 mm	10 mm	50 mm	5 mm	-
F019/017	€ 15,00	17 mm	28 mm	10 mm	50 mm	5 mm	-
F019/018	€ 16,00	18 mm	28 mm	10 mm	50 mm	5 mm	-
F019/019	€ 16,80	19 mm	28 mm	10 mm	50 mm	5 mm	-
F019/020	€ 17,90	20 mm	28 mm	10 mm	50 mm	5 mm	-
F019/021	€ 18,70	21 mm	28 mm	10 mm	50 mm	5 mm	-
F019/022	€ 19,70	22 mm	28 mm	10 mm	50 mm	5 mm	M12 x 1,25
F019/023	€ 20,60	23 mm	28 mm	10 mm	50 mm	5 mm	M12 x 1,25
F019/024	€ 21,50	24 mm	28 mm	10 mm	50 mm	5 mm	M12 x 1,25
F019/025	€ 22,50	25 mm	28 mm	10 mm	50 mm	5 mm	M12 x 1,25
F019/026	€ 23,40	26 mm	28 mm	10 mm	50 mm	5 mm	M12 x 1,25
F019/027	€ 24,40	27 mm	28 mm	10 mm	50 mm	5 mm	M12 x 1,25
F019/028	€ 25,30	28 mm	28 mm	10 mm	50 mm	5 mm	M12 x 1,25
F019/029	€ 26,10	29 mm	28 mm	10 mm	50 mm	5 mm	M12 x 1,25
F019/030	€ 27,20	30 mm	28 mm	10 mm	50 mm	5 mm	M12 x 1,25
F019/031	€ 28,00	31 mm	28 mm	10 mm	50 mm	5 mm	M12 x 1,25
F019/032	€ 29,10	32 mm	28 mm	10 mm	50 mm	5 mm	M12 x 1,25
F019/033	€ 29,90	33 mm	28 mm	10 mm	50 mm	5 mm	M12 x 1,25
F019/034	€ 31,00	34 mm	28 mm	10 mm	50 mm	5 mm	M12 x 1,25
F019/035	€ 31,80	35 mm	28 mm	10 mm	50 mm	5 mm	M14 x 1,5
F019/036	€ 32,80	36 mm	28 mm	10 mm	50 mm	5 mm	M14 x 1,5
F019/037	€ 33,70	37 mm	28 mm	10 mm	50 mm	5 mm	M14 x 1,5
F019/038	€ 34,70	38 mm	28 mm	10 mm	50 mm	5 mm	M14 x 1,5
F019/039	€ 35,50	39 mm	28 mm	10 mm	50 mm	5 mm	M14 x 1,5
F019/040	€ 36,50	40 mm	28 mm	10 mm	50 mm	5 mm	M14 x 1,5
F019/041	€ 36,90	41 mm	28 mm	10 mm	50 mm	5 mm	M14 x 1,5
F019/042	€ 37,90	42 mm	28 mm	10 mm	50 mm	5 mm	M14 x 1,5
F019/043	€ 38,70	43 mm	28 mm	10 mm	50 mm	5 mm	M14 x 1,5
F019/044	€ 39,30	44 mm	28 mm	10 mm	50 mm	5 mm	M14 x 1,5
F019/045	€ 40,30	45 mm	28 mm	10 mm	50 mm	5 mm	M14 x 1,5
F019/046	€ 41,20	46 mm	28 mm	10 mm	50 mm	5 mm	M14 x 1,5
F019/047	€ 42,10	47 mm	28 mm	10 mm	50 mm	5 mm	M14 x 1,5
F019/048	€ 43,10	48 mm	28 mm	10 mm	50 mm	5 mm	M14 x 1,5
F019/049	€ 44,00	49 mm	28 mm	10 mm	50 mm	5 mm	M14 x 1,5
F019/050	€ 44,80	50 mm	28 mm	10 mm	50 mm	5 mm	M14 x 1,5
F019/051	€ 45,90	51 mm	28 mm	12 mm	50 mm	5 mm	M16 x 1,5
F019/052	€ 46,70	52 mm	28 mm	12 mm	50 mm	5 mm	M16 x 1,5
F019/053	€ 47,80	53 mm	28 mm	12 mm	50 mm	5 mm	M16 x 1,5
F019/054	€ 48,60	54 mm	28 mm	12 mm	50 mm	5 mm	M16 x 1,5
F019/055	€ 49,70	55 mm	28 mm	12 mm	50 mm	5 mm	M16 x 1,5
F019/056	€ 50,50	56 mm	28 mm	12 mm	50 mm	5 mm	M16 x 1,5
F019/057	€ 51,50	57 mm	28 mm	12 mm	50 mm	5 mm	M16 x 1,5
F019/058	€ 52,40	58 mm	28 mm	12 mm	50 mm	5 mm	M16 x 1,5
F019/059	€ 53,30	59 mm	28 mm	12 mm	50 mm	5 mm	M16 x 1,5
F019/060	€ 54,20	60 mm	28 mm	12 mm	50 mm	5 mm	M16 x 1,5
F019/065	€ 62,70	65 mm	28 mm	12 mm	50 mm	5 mm	M16 x 1,5
F019/070	€ 66,50	70 mm	28 mm	12 mm	50 mm	5 mm	M16 x 1,5
F019/075	€ 71,10	75 mm	28 mm	12 mm	50 mm	5 mm	M16 x 1,5
F019/080	€ 75,80	80 mm	28 mm	12 mm	50 mm	5 mm	M16 x 1,5
F019/085	€ 80,40	85 mm	28 mm	12 mm	50 mm	5 mm	M16 x 1,5
F019/090	€ 86,00	90 mm	28 mm	12 mm	50 mm	5 mm	M16 x 1,5
F019/095	€ 90,70	95 mm	28 mm	12 mm	50 mm	5 mm	M16 x 1,5
F019/100	€ 95,30	100 mm	28 mm	12 mm	50 mm	5 mm	M16 x 1,5

F019/006

€ 105,00

SET SEGHE A TAZZA CON INSERTI IN METALLO DURO

Con scarico truciolo laterale e punta pilota.

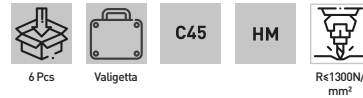

Misure 16 mm, 18 mm, 20 mm, 22 mm, 25 mm, 30 mm
Profondità di taglio 5 mm

F019/008

€ 148,00

SET SEGHE A TAZZA CON INSERTI IN METALLO DURO

Con scarico truciolo laterale e punta pilota.



Misure 16 mm, 18 mm, 20 mm, 22 mm, 25 mm, 30 mm, 32 mm, 35 mm
Profondità di taglio 5 mm

F019/005

€ 1,97

PUNTA PILOTA

Per articolo F019-.

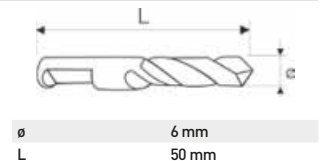

F019/007

€ 0,24

MOLLA

Per articolo F019-.



SEGHE A TAZZA IN HSS

Dotata di taglio laterale rompitruciolo. Precisione di foratura di lamiere in acciaio, leghe leggere e materiali metallici in genere. Profondità di foratura sino a 5 mm



N° DI GIRI TEORICI PER SEGHE A TAZZE IN FUNZIONE AL MATERIALE DA LAVORARE

Materiale da lavorare	Ø Sega												Refrigerante
	12-17	18-24	25-32	33-38	39-44	45-51	52-57	58-64	65-70	71-80	81-90	91-100	
	n. di giri (rpm)												
Acciaio da costruzione basso legato R < 700÷900N/mm ²	550	380	300	240	200	170	150	130	120	110	100	90	Emulsione
Acciaio legato R < 1100÷1300N/mm ²	230	160	130	100	80	70	60	60	50	50	40	40	Emulsione
Acciaio Inox	230	160	130	100	80	70	60	60	50	50	40	40	Emulsione
Ghisa	280	190	150	120	100	90	80	70	60	60	50	40	No refriger.
Leghe Leggere	870	590	470	370	310	270	240	210	190	170	150	140	Emulsione
Alluminio	870	590	470	370	310	270	240	210	190	170	150	140	Emulsione
Plastica	660	450	350	280	240	210	180	160	150	130	120	100	Acqua No refriger.





F015-

SEGHE A TAZZA

Con scarico truciolo laterale e punta pilota.

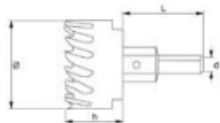

Art.	€	ø	h	d	L	Filetto
F015/012	€ 10,80	12 mm	23 mm	8 mm	56 mm	M10 x 1,25
F015/013	€ 10,80	13 mm	23 mm	8 mm	56 mm	M10 x 1,25
F015/014	€ 11,30	14 mm	23 mm	8 mm	56 mm	M10 x 1,25
F015/015	€ 11,30	15 mm	23 mm	10 mm	56 mm	M12 x 1,25
F015/016	€ 11,30	16 mm	23 mm	10 mm	56 mm	M12 x 1,25
F015/017	€ 11,30	17 mm	23 mm	10 mm	56 mm	M12 x 1,25
F015/018	€ 11,30	18 mm	23 mm	10 mm	56 mm	M12 x 1,25
F015/019	€ 11,90	19 mm	23 mm	10 mm	56 mm	M12 x 1,25
F015/020	€ 12,40	20 mm	23 mm	10 mm	56 mm	M12 x 1,25
F015/021	€ 12,80	21 mm	23 mm	10 mm	56 mm	M12 x 1,25
F015/022	€ 13,30	22 mm	23 mm	10 mm	56 mm	M12 x 1,25
F015/023	€ 14,50	23 mm	23 mm	10 mm	56 mm	M12 x 1,25
F015/024	€ 14,80	24 mm	23 mm	10 mm	56 mm	M12 x 1,25
F015/025	€ 15,30	25 mm	23 mm	10 mm	56 mm	M12 x 1,25
F015/026	€ 16,40	26 mm	23 mm	10 mm	56 mm	M12 x 1,25
F015/027	€ 16,80	27 mm	23 mm	10 mm	56 mm	M12 x 1,25
F015/028	€ 17,30	28 mm	23 mm	10 mm	56 mm	M12 x 1,25
F015/029	€ 17,90	29 mm	23 mm	10 mm	56 mm	M12 x 1,25
F015/030	€ 18,20	30 mm	23 mm	10 mm	56 mm	M12 x 1,25
F015/031	€ 18,70	31 mm	23 mm	10 mm	56 mm	M12 x 1,25
F015/032	€ 19,70	32 mm	23 mm	10 mm	56 mm	M12 x 1,25
F015/033	€ 19,70	33 mm	23 mm	10 mm	56 mm	M12 x 1,25
F015/034	€ 20,70	34 mm	23 mm	10 mm	56 mm	M12 x 1,25
F015/035	€ 21,70	35 mm	23 mm	10 mm	56 mm	M14 x 1,5
F015/036	€ 22,70	36 mm	23 mm	10 mm	56 mm	M14 x 1,5
F015/037	€ 22,70	37 mm	23 mm	10 mm	56 mm	M14 x 1,5
F015/038	€ 23,20	38 mm	23 mm	10 mm	56 mm	M14 x 1,5
F015/039	€ 25,20	39 mm	23 mm	10 mm	56 mm	M14 x 1,5
F015/040	€ 25,20	40 mm	23 mm	10 mm	56 mm	M14 x 1,5
F015/041	€ 25,70	41 mm	23 mm	10 mm	56 mm	M14 x 1,5
F015/042	€ 25,70	42 mm	23 mm	10 mm	56 mm	M14 x 1,5
F015/043	€ 26,70	43 mm	23 mm	10 mm	56 mm	M14 x 1,5
F015/044	€ 27,20	44 mm	23 mm	10 mm	56 mm	M14 x 1,5
F015/045	€ 28,70	45 mm	23 mm	10 mm	56 mm	M14 x 1,5
F015/046	€ 28,70	46 mm	23 mm	10 mm	56 mm	M14 x 1,5
F015/047	€ 29,20	47 mm	23 mm	10 mm	56 mm	M14 x 1,5
F015/048	€ 31,10	48 mm	23 mm	10 mm	56 mm	M14 x 1,5
F015/049	€ 31,50	49 mm	23 mm	10 mm	56 mm	M14 x 1,5
F015/050	€ 31,50	50 mm	23 mm	10 mm	56 mm	M14 x 1,5
F015/051	€ 38,50	51 mm	23 mm	12 mm	56 mm	M16 x 1,5
F015/052	€ 38,50	52 mm	23 mm	12 mm	56 mm	M16 x 1,5
F015/053	€ 39,50	53 mm	23 mm	12 mm	56 mm	M16 x 1,5
F015/054	€ 41,50	54 mm	23 mm	12 mm	56 mm	M16 x 1,5
F015/055	€ 41,50	55 mm	23 mm	12 mm	56 mm	M16 x 1,5
F015/056	€ 42,40	56 mm	23 mm	12 mm	56 mm	M16 x 1,5
F015/057	€ 42,40	57 mm	23 mm	12 mm	56 mm	M16 x 1,5
F015/058	€ 44,40	58 mm	23 mm	12 mm	56 mm	M16 x 1,5
F015/059	€ 46,40	59 mm	23 mm	12 mm	56 mm	M16 x 1,5
F015/060	€ 46,40	60 mm	23 mm	12 mm	56 mm	M16 x 1,5
F015/065	€ 59,20	65 mm	23 mm	12 mm	56 mm	M16 x 1,5
F015/070	€ 63,20	70 mm	23 mm	12 mm	56 mm	M16 x 1,5
F015/075	€ 68,00	75 mm	23 mm	12 mm	56 mm	M16 x 1,5
F015/080	€ 75,10	80 mm	23 mm	12 mm	56 mm	M16 x 1,5
F015/085	€ 85,90	85 mm	23 mm	12 mm	56 mm	M16 x 1,5
F015/090	€ 94,70	90 mm	23 mm	12 mm	56 mm	M16 x 1,5
F015/095	€ 103,00	95 mm	23 mm	12 mm	56 mm	M16 x 1,5
F015/100	€ 108,00	100 mm	23 mm	12 mm	56 mm	M16 x 1,5

F015/006S

€ 105,00

SET SEGHE A TAZZA

Con scarico truciolo laterale e punta pilota.

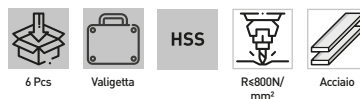

Misure 16 mm, 18 mm, 20 mm, 22 mm, 25 mm, 30 mm

F015/008S

€ 148,00

SET SEGHE A TAZZA

Con scarico truciolo laterale e punta pilota.

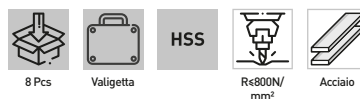

Misure 16 mm, 18 mm, 20 mm, 22 mm, 25 mm, 30 mm, 32 mm, 35 mm

F015-A

ALBERO PER SEGHE A TAZZA

Per articolo F015-.

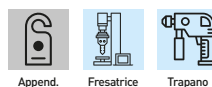
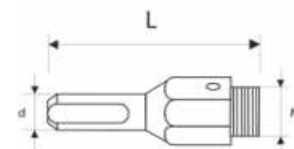

Art.	€	ø	d	L	Filetto
F015/001	€ 3,45	12 - 14 mm	8 mm	56 mm	M10 x 1,25
F015/002	€ 3,45	15-34 mm	10 mm	56 mm	M12 x 1,25
F015/003	€ 4,95	35-50 mm	10 mm	56 mm	M14 x 1,5
F015/004	€ 4,95	51-100 mm	12 mm	60 mm	M16 x 1,5

F015/005

€ 1,97

PUNTA PILOTA

Per articolo F015-

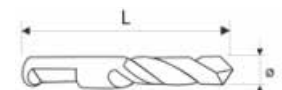

ø 6 mm
L 50 mm

F015/007

€ 0,24

MOLLA

Per articolo F015-.



SEGA A TAZZA BIMETALLICA

Dotata di dentatura variabile per il taglio di materiale a spessore sottile quale acciaio, ghisa, alluminio, rame, bronzo, ottone, legno, plastica, fibra di vetro e cartongesso



N° DI GIRI TEORICI PER SEGHE A TAZZA IN FUNZIONE AL MATERIALE DA LAVORARE

Materiale da lavorare	Ø Sega																Refrigerante
	14 - 17	19 - 24	25 - 32	33 - 38	40 - 44	46 - 51	52 - 57	59 - 64	65 - 70	73 - 79	83 - 89	92 - 98	102 - 108	111 - 121	127 - 140	146 - 152	
	n. di giri (rpm)																
Acciaio da costruzione basso legato R < 700 ÷ 900 N/mm ²	530	360	280	230	190	170	140	130	120	110	90	80	80	70	60	50	Emulsione
Acciaio legato R < 1100 ÷ 1300 N/mm ²	210	140	110	90	80	70	60	50	50	40	40	30	30	30	20	20	Emulsione
Acciaio Inox	210	140	110	90	80	70	60	50	50	40	40	30	30	30	20	20	Emulsione
Ghisa	250	180	170	140	110	90	70	60	60	50	40	40	40	30	30	30	No refriger.
Ottone	740	510	400	320	270	230	200	180	170	150	130	120	110	100	80	70	Emulsione Olio
Alluminio e leghe leggere	850	580	450	360	300	270	230	210	190	170	150	130	120	110	100	80	Emulsione
Legno	960	650	510	410	340	300	260	230	210	190	170	150	140	120	110	100	No refriger.
Plastica	640	430	340	270	230	200	170	150	140	130	110	100	90	80	70	60	No refriger.
Cartongesso	960	650	510	410	340	300	260	230	210	190	170	150	140	120	110	100	No refriger.





0278-

SEGA A TAZZA BIMETALLICA A DENTATURA VARIABILE

Grazie alla geometria della dentatura variabile si ha una esecuzione di tagli rapidi e precisi, oltre ad una maggiore dispersione di calore durante il taglio per una minore usura dei denti. Inoltre si ha una notevole riduzione del fenomeno di grippaggio.



BIM - HSS-CO 8% AISI M42



Scatola



HSS CO 8%



Acciaio



Inox



Alluminio



Leghe non ferrose



Plastica



Plexiglass



Legno



Multistrato



Truciolato



Cartonges.



Ghisa



Emulsione



A secco



Fresatrice

Art.	€	Ø	Ø inch
0278/014	€ 5,60	14 mm	9/16
0278/016	€ 5,60	16 mm	5/8
0278/017	€ 5,60	17 mm	11/16
0278/019	€ 6,00	19 mm	3/4
0278/020	€ 6,00	20 mm	25/32
0278/021	€ 6,40	21 mm	13/16
0278/022	€ 6,40	22 mm	7/8
0278/024	€ 6,70	24 mm	15/16
0278/025	€ 6,70	25 mm	1
0278/027	€ 7,40	27 mm	1-1/16
0278/029	€ 7,40	29 mm	1-1/8
0278/030	€ 8,70	30 mm	1-3/16
0278/032	€ 8,70	32 mm	1-1/4
0278/033	€ 8,90	33 mm	1-5/16
0278/035	€ 9,50	35 mm	1-3/8
0278/037	€ 10,00	37 mm	1-7/16
0278/038	€ 10,00	38 mm	1-1/2
0278/040	€ 10,20	40 mm	1-9/16
0278/041	€ 10,40	41 mm	1-5/8
0278/043	€ 10,40	43 mm	1-11/16
0278/044	€ 11,30	44 mm	1-3/4
0278/046	€ 11,30	46 mm	1-13/16
0278/048	€ 11,70	48 mm	1-7/8
0278/051	€ 12,00	51 mm	2
0278/052	€ 13,30	52 mm	2-1/16
0278/054	€ 13,30	54 mm	2-1/8
0278/057	€ 13,30	57 mm	2-1/4
0278/059	€ 13,80	59 mm	2-5/16
0278/060	€ 13,80	60 mm	2-3/8
0278/064	€ 14,80	64 mm	2-1/2
0278/065	€ 14,80	65 mm	2-9/16
0278/067	€ 16,00	67 mm	2-5/8
0278/068	€ 16,00	68 mm	2-11/16
0278/070	€ 16,00	70 mm	2-3/4
0278/073	€ 17,50	73 mm	2-7/8
0278/076	€ 17,50	76 mm	3
0278/079	€ 18,60	79 mm	3-1/8
0278/083	€ 19,70	83 mm	3-1/4
0278/085	€ 19,70	85 mm	3-3/8
0278/089	€ 21,40	89 mm	3-1/2
0278/092	€ 21,90	92 mm	3-5/8
0278/095	€ 22,80	95 mm	3-3/4
0278/098	€ 22,80	98 mm	3-7/8
0278/102	€ 23,00	102 mm	4
0278/105	€ 23,40	105 mm	4-1/8
0278/108	€ 24,20	108 mm	4-1/4
0278/111	€ 24,90	111 mm	4-3/8
0278/114	€ 26,00	114 mm	4-1/2
0278/121	€ 27,20	121 mm	4-3/4
0278/127	€ 29,40	127 mm	5
0278/140	€ 39,70	140 mm	5-1/2
0278/152	€ 46,20	152 mm	6

0278/002S

€ 101,00

ASSORTIMENTO IN VALIGETTA

Kit elettricista.



BIM - HSS-CO 8% AISI M42



9 Pcs



Valigetta



HSS CO 8%



Acciaio



Inox



Tazze	22 - 29 mm
Alberi, punte, adattatore corrispondenti	0712/600
Tazze	35 - 44 mm
Alberi, punte, adattatore corrispondenti	0712/800
Tazze	51 - 64 mm
Alberi, punte, adattatore corrispondenti	0712/900

0278/005S

€ 66,00

ASSORTIMENTO IN VALIGETTA

Kit riparatore.



BIM - HSS-CO 8% AISI M42



7 Pcs



Valigetta



HSS CO 8%



Tazze	22 - 25 - 29 mm
Alberi, punte, adattatore corrispondenti	0712/600
Tazze	32 - 38 mm
Alberi, punte, adattatore corrispondenti	0712/900

0278/008S

€ 95,80

ASSORTIMENTO IN VALIGETTA

Kit idraulico.



BIM - HSS-CO 8% AISI M42



9 Pcs



Valigetta



HSS CO 8%



Tazze	19 - 22 - 29 mm
Alberi, punte, adattatore corrispondenti	0712/600
Tazze	38 - 44 - 57 mm
Alberi, punte, adattatore corrispondenti	0712/800 - 0712/900

0278/009S

€ 113,00

ASSORTIMENTO IN VALIGETTA

Kit installatore



BIM - HSS-CO 8% AISI M42



13 Pcs



Valigetta



HSS CO 8%



Tazze	19 - 22 - 29 mm
Alberi, punte, adattatore corrispondenti	0712/600 - 0712/900 - 0712/300
Tazze	35 - 38 - 44 - 51 - 57 - 64 mm
Alberi, punte, adattatore corrispondenti	0712/800

0712-
SEGA A TAZZA BIMETALLICA A DENTATURA VARIABILE

Grazie alla geometria della dentatura variabile si ha una esecuzione di tagli rapidi e precisi, oltre ad una maggiore dispersione di calore durante il taglio per una minore usura dei denti. Inoltre si ha una notevole riduzione del fenomeno di grippaggio.

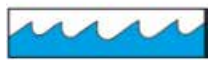
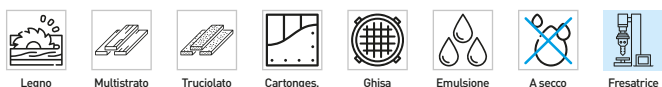
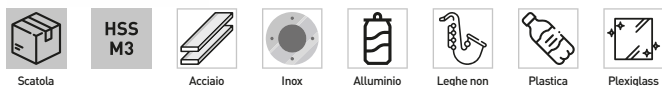
 BIM - HSS M3/1
Var. Z 4-6

Art.	€	Ø	Ø inch
0712/014	€ 5,20	14 mm	9/16
0712/016	€ 5,20	16 mm	5/8
0712/017	€ 5,20	17 mm	11/16
0712/019	€ 5,20	19 mm	3/4
0712/020	€ 5,20	20 mm	25/32
0712/021	€ 5,20	21 mm	13/16
0712/022	€ 7,40	22 mm	7/8
0712/024	€ 7,40	24 mm	15/16
0712/025	€ 7,40	25 mm	1
0712/027	€ 7,40	27 mm	1-1/16
0712/029	€ 7,40	29 mm	1-1/8
0712/030	€ 7,50	30 mm	1-3/16
0712/032	€ 7,50	32 mm	1-1/4
0712/033	€ 7,50	33 mm	1-5/16
0712/035	€ 9,60	35 mm	1-3/8
0712/037	€ 9,60	37 mm	1-7/16
0712/038	€ 9,60	38 mm	1-1/2
0712/040	€ 9,60	40 mm	1-9/16
0712/041	€ 9,60	41 mm	1-5/8
0712/043	€ 9,60	43 mm	1-11/16
0712/044	€ 9,60	44 mm	1-3/4
0712/046	€ 9,60	46 mm	1-13/16
0712/048	€ 9,60	48 mm	1-7/8
0712/051	€ 9,60	51 mm	2
0712/052	€ 11,20	52 mm	2-1/16
0712/054	€ 11,20	54 mm	2-1/8
0712/057	€ 11,20	57 mm	2-1/4
0712/059	€ 11,20	59 mm	2-5/16
0712/060	€ 11,20	60 mm	2-3/8
0712/064	€ 12,60	64 mm	2-1/2
0712/065	€ 12,60	65 mm	2-9/16
0712/067	€ 12,60	67 mm	2-5/8
0712/068	€ 12,60	68 mm	2-11/16
0712/070	€ 12,60	70 mm	2-3/4
0712/073	€ 14,70	73 mm	2-7/8
0712/076	€ 14,70	76 mm	3
0712/079	€ 14,70	79 mm	3-1/8
0712/083	€ 16,40	83 mm	3-1/4
0712/085	€ 16,40	85 mm	3-3/8
0712/089	€ 16,40	89 mm	3-1/2
0712/092	€ 16,40	92 mm	3-5/8
0712/095	€ 18,20	95 mm	3-3/4
0712/098	€ 18,20	98 mm	3-7/8
0712/102	€ 19,40	102 mm	4
0712/105	€ 21,20	105 mm	4-1/8
0712/108	€ 26,00	108 mm	4-1/4
0712/111	€ 32,30	111 mm	4-3/8
0712/114	€ 32,30	114 mm	4-1/2
0712/121	€ 32,30	121 mm	4-3/4
0712/127	€ 32,30	127 mm	5
0712/140	€ 37,40	140 mm	5-1/2
0712/152	€ 37,40	152 mm	6

0712/002
€ 91,20
ASSORTIMENTO IN VALIGETTA

Kit elettricista.

 BIM - HSS M3/1
Var. Z 4-6

Tazze	22 - 29 mm
Alberi, punte, adattatore corrispondenti	0712/600
Tazze	35 - 44 mm
Alberi, punte, adattatore corrispondenti	0712/800
Tazze	51 - 64 mm
Alberi, punte, adattatore corrispondenti	0712/900

0712/005
€ 59,70
ASSORTIMENTO IN VALIGETTA

Kit riparatore.

 BIM - HSS M3/1
Var. Z 4-6

Tazze	22 - 25 - 29 mm
Alberi, punte, adattatore corrispondenti	0712/600
Tazze	32 - 38 mm
Alberi, punte, adattatore corrispondenti	0712/900

0712/008
€ 91,20
ASSORTIMENTO IN VALIGETTA

Kit idraulico

 BIM - HSS M3/1
Var. Z 4-6

Tazze	19 - 22 - 29 mm
Alberi, punte, adattatore corrispondenti	0712/600
Tazze	38 - 44 - 57 mm
Alberi, punte, adattatore corrispondenti	0712/800 - 0712/900

0712/009
€ 104,00
ASSORTIMENTO IN VALIGETTA

Kit installatore.

 BIM - HSS M3/1
Var. Z 4-6

Tazze	19 - 22 - 29 mm
Alberi, punte, adattatore corrispondenti	0712/600 - 0712/900 - 0712/300
Tazze	35 - 38 - 44 - 51 - 57 - 64 mm
Alberi, punte, adattatore corrispondenti	0712/800



0712/010

€ 195,00

ASSORTIMENTO IN VALIGETTA

Kit industria.



Dim. - HSS M31
Var. 2-4-6



21 Pcs



Valigetta

**HSS
M3**



Tazze	19 - 22 - 29 mm
Alberi, punte, adattatore corrispondenti	0712/600 - 0712/900 - 0712/300
Tazze	35 - 38 - 44 - 51 - 57 - 64 - 76 - 83 - 92 - 95 - 105 - 114 mm
Alberi, punte, adattatore corrispondenti	0712/600 - 0712/900 - 0712/300
Prolunga	300 mm

0712-X00

PUNTA PER ALBERI

Intercambiabile con tutte le marche.



Scatola

HSS

Art.	€	Gambo	Per alberi	Lunghezza	Pack
0712/300	€ 4,16	Ø 6,35 mm	0712/600	105 mm	10
0712/200	€ 4,16	Ø 6,35 mm	0712/700 - 800	75 mm	10

0712/900

€ 4,16

ADATTATORE PER SEGHE A TAZZA



Scatola

Riduzione	1/2" - 5/8"
Per alberi	0712/600 - 0712/700

0712-X0

ALBERO COMPLETO DI PUNTA

Attacco esagonale, intercambiabile con tutte le marche.



Scatola

HSS

Art.	€	Attacco	Gambo	Tazze	Filetto
0712/600	€ 7,50	Albero Tondo	Ø 6,35 mm	Ø 14+30 mm	1/2"
0712/700	€ 8,40	Albero Esagonale	Ø 9,5 mm	Ø 14+30 mm	1/2"
0712/800	€ 13,30	Albero Esagonale	Ø 11 mm	Ø 32+152 mm	5/8"



A208B-
ALESATORE A MACCHINA

Rettificati per accoppiamenti H7. Taglio destro, taglienti elicoidali sinistri, attacco cono morse. Utilizzabili prevalentemente per fori passanti ma grazie all'imbocco corto è possibile alesare anche fori ciechi.



Art.	€	øH7	L	I	CM
A208B/05	€ 22,50	5 mm	133 mm	23 mm	1
A208B/06	€ 24,40	6 mm	138 mm	26 mm	1
A208B/07	€ 24,40	7 mm	150 mm	31 mm	1
A208B/08	€ 25,50	8 mm	156 mm	33 mm	1
A208B/09	€ 25,50	9 mm	162 mm	36 mm	1
A208B/10	€ 27,80	10 mm	168 mm	38 mm	1
A208B/11	€ 27,80	11 mm	175 mm	41 mm	1
A208B/12	€ 29,20	12 mm	182 mm	44 mm	1
A208B/13	€ 29,20	13 mm	182 mm	44 mm	1
A208B/14	€ 30,60	14 mm	189 mm	47 mm	1
A208B/15	€ 34,90	15 mm	204 mm	50 mm	2
A208B/16	€ 34,90	16 mm	210 mm	52 mm	2
A208B/17	€ 35,80	17 mm	214 mm	54 mm	2
A208B/18	€ 36,40	18 mm	219 mm	56 mm	2
A208B/19	€ 37,40	19 mm	223 mm	58 mm	2
A208B/20	€ 41,50	20 mm	228 mm	60 mm	2
A208B/21	€ 43,70	21 mm	232 mm	62 mm	2
A208B/22	€ 47,80	22 mm	237 mm	64 mm	2
A208B/23	€ 52,50	23 mm	241 mm	66 mm	2
A208B/24	€ 54,50	24 mm	268 mm	68 mm	3
A208B/25	€ 59,70	25 mm	268 mm	68 mm	3
A208B/26	€ 62,70	26 mm	273 mm	70 mm	3
A208B/27	€ 69,90	27 mm	277 mm	71 mm	3
A208B/28	€ 76,10	28 mm	277 mm	71 mm	3
A208B/29	€ 78,10	29 mm	281 mm	73 mm	3
A208B/30	€ 83,30	30 mm	281 mm	73 mm	3
A208B/31	€ 87,40	31 mm	285 mm	75 mm	3
A208B/32	€ 91,50	32 mm	317 mm	77 mm	4
A208B/34	€ 122,00	34 mm	321 mm	78 mm	4
A208B/35	€ 127,00	35 mm	321 mm	78 mm	4
A208B/36	€ 132,00	36 mm	325 mm	79 mm	4
A208B/38	€ 147,00	38 mm	329 mm	81 mm	4
A208B/40	€ 160,00	40 mm	329 mm	81 mm	4

A212-
ALESATORE A MACCHINA

Rettificati per accoppiamenti H7. Taglio destro, taglienti elicoidali sinistri, attacco cilindrico. Utilizzabili prevalentemente per fori passanti ma grazie all'imbocco corto è possibile alesare anche fori ciechi.



Art.	€	øH7	L	I	d h9	Z
A212/02.00	€ 21,20	2 mm	49 mm	11 mm	2 mm	4
A212/02.50	€ 21,20	2,5 mm	57 mm	14 mm	2,5 mm	4
A212/03.00	€ 21,20	3 mm	61 mm	15 mm	3 mm	4
A212/03.50	€ 21,20	3,5 mm	70 mm	18 mm	3,5 mm	6
A212/04.50	€ 14,20	4,5 mm	80 mm	21 mm	4,5 mm	6
A212/05.00	€ 14,20	5 mm	86 mm	23 mm	5 mm	6
A212/05.50	€ 14,20	5,5 mm	93 mm	26 mm	5,5 mm	6
A212/06.00	€ 14,20	6 mm	93 mm	26 mm	6 mm	6
A212/06.50	€ 18,00	6,5 mm	101 mm	28 mm	6,5 mm	6
A212/07.00	€ 18,00	7 mm	109 mm	31 mm	7 mm	6
A212/07.50	€ 18,00	7,5 mm	109 mm	31 mm	7 mm	6
A212/08.00	€ 18,00	8 mm	117 mm	33 mm	8 mm	6
A212/08.50	€ 22,40	8,5 mm	117 mm	33 mm	8 mm	6
A212/09.00	€ 22,40	9 mm	125 mm	36 mm	9 mm	6
A212/09.50	€ 22,40	9,5 mm	125 mm	36 mm	9 mm	6
A212/10.00	€ 22,40	10 mm	133 mm	38 mm	10 mm	6
A212/11.00	€ 25,50	11 mm	142 mm	41 mm	10 mm	6
A212/12.00	€ 34,90	12 mm	151 mm	44 mm	10 mm	6
A212/13.00	€ 34,90	13 mm	151 mm	44 mm	10 mm	6
A212/14.00	€ 42,10	14 mm	160 mm	47 mm	12 mm	6
A212/15.00	€ 42,10	15 mm	162 mm	50 mm	12 mm	8
A212/16.00	€ 42,10	16 mm	170 mm	52 mm	12 mm	8





L018-

LAMATORE CON ATTACCO CILINDRICO PER PREFORI DI FILETTATURE

Per prefori di filettature.

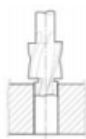

Art.	€	Viti	D	d1	d2	L1	L2	L
L018/03	€ 13,00	M3	6 mm	2,5 mm	5 mm	4 mm	14 mm	71 mm
L018/04	€ 13,00	M4	8 mm	3,3 mm	5 mm	5 mm	14 mm	71 mm
L018/05	€ 13,00	M5	10 mm	4,2 mm	8 mm	6 mm	18 mm	80 mm
L018/06	€ 13,40	M6	11 mm	5,0 mm	8 mm	7 mm	18 mm	80 mm
L018/08	€ 21,80	M8	15 mm	6,8 mm	12,5 mm	9 mm	22 mm	100 mm
L018/10	€ 25,90	M10	18 mm	8,5 mm	12,5 mm	14 mm	22 mm	100 mm
L018/12	€ 28,00	M12	20 mm	10,2 mm	12,5 mm	14 mm	22 mm	100 mm

L019-

LAMATORE CON ATTACCO CILINDRICO GRADO FINO

Per fori passanti per l'esecuzione di viteria o bulloneria di precisione.

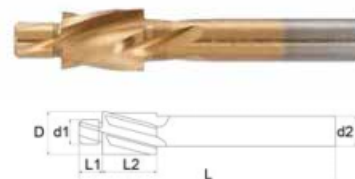

Art.	€	Viti	D	d1	d2	L1	L2	L
L019/03	€ 13,00	M3	6 mm	3,2 mm	5 mm	4 mm	14 mm	71 mm
L019/04	€ 13,00	M4	8 mm	4,3 mm	5 mm	5 mm	14 mm	71 mm
L019/05	€ 13,00	M5	10 mm	5,3 mm	8 mm	6 mm	18 mm	80 mm
L019/06	€ 13,40	M6	11 mm	6,4 mm	8 mm	7 mm	18 mm	80 mm
L019/08	€ 21,80	M8	15 mm	8,4 mm	12,5 mm	9 mm	22 mm	100 mm
L019/10	€ 25,90	M10	18 mm	10,5 mm	12,5 mm	14 mm	22 mm	100 mm
L019/12	€ 28,00	M12	20 mm	13,0 mm	12,5 mm	14 mm	22 mm	100 mm

L020-

LAMATORE CON ATTACCO CILINDRICO TIPO MEDIO

Per fori passanti.

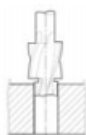

Art.	€	Viti	D	d1	d2	L1	L2	L
L020/03	€ 14,20	M3	6 mm	3,4 mm	5 mm	4 mm	14 mm	71 mm
L020/04	€ 15,30	M4	8 mm	4,5 mm	5 mm	5 mm	14 mm	71 mm
L020/05	€ 16,60	M5	10 mm	5,5 mm	8 mm	6 mm	18 mm	80 mm
L020/06	€ 17,40	M6	11 mm	6,6 mm	8 mm	7 mm	18 mm	80 mm
L020/08	€ 26,60	M8	15 mm	9 mm	12,5 mm	9 mm	22 mm	100 mm
L020/10	€ 30,10	M10	18 mm	11 mm	12,5 mm	14 mm	22 mm	100 mm
L020/12	€ 33,90	M12	20 mm	13,5 mm	12,5 mm	14 mm	22 mm	100 mm

L018S

€ 88,30

SERIE LAMATORI CON ATTACCO CILINDRICO PER PREFORI DI FILETTATURE

Per prefori di filettature.

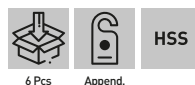

Per viti M3, M4, M5, M6, M8, M10

L019S

€ 88,30

SERIE LAMATORI CON ATTACCO CILINDRICO GRADO FINO

Per fori passanti per l'esecuzione di viteria o bulloneria di precisione.

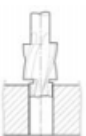

Per viti M3, M4, M5, M6, M8, M10

L020S

€ 88,30

SERIE LAMATORI CON ATTACCO CILINDRICO GRADO MEDIO

Per fori passanti.



Per viti M3, M4, M5, M6, M8, M10

L020
€ 104,00
SERIE LAMATORI TIPO MEDIO CON ATTACCO CILINDRICO

Per fori passanti.

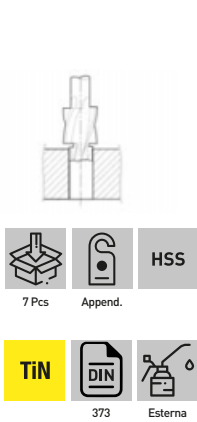

Per viti M3, M4, M5, M6, M8, M10, M12

S0X
NEW
SVASATORE A 3 TAGLIANTI 90°

Con spoglie rettificata e scanalature ricavate dal pieno, per eseguire svasature coniche senza vibrazioni.

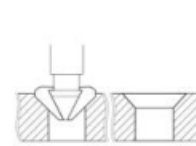
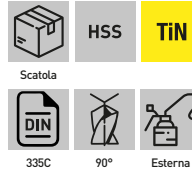

Art.	€	Ø max	Per Viti M	Gambo
S006	€ 10,70	6,3 mm	3	Ø 5 mm
S006/A	€ 10,50	6 mm	3 - DIN 74 AF	Ø 5 mm
S008	€ 11,40	8 mm	4 - DIN 74 AF	Ø 6 mm
S010	€ 12,60	10,4 mm	5	Ø 6 mm
S010/A	€ 12,30	10 mm	5 - DIN 74 AF	Ø 6 mm
S012	€ 14,50	12,4 mm	6	Ø 8 mm
S016	€ 18,80	16,5 mm	8	Ø 10 mm
S020	€ 23,00	20,5 mm	10	Ø 10 mm
S025	€ 27,50	25 mm	12	Ø 10 mm
S028	€ 34,80	28 mm	14	Ø 12 mm
S031	€ 37,30	31 mm	16	Ø 12 mm
S040	€ 63,00	40 mm	--	Ø 15 mm

S001
€ 97,80
SERIE SVASATORE A 3 TAGLIANTI 90°

Con spoglie rettificata e scanalature ricavate dal pieno, per eseguire svasature coniche senza vibrazioni.

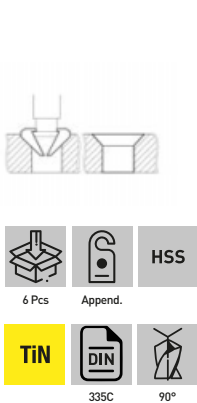

Ø max 6 - 8 - 10 - 12,4 - 16,5 - 20,5 mm

S026-
SVASATORE CON GAMBO ESAGONALE

Per eseguire svasature coniche senza vibrazioni.

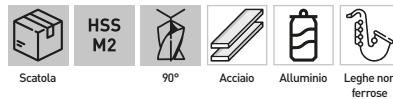
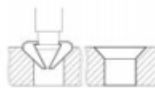

Art.	€	Ø	Lunghezza totale	Dimensioni gambo
S026/06	€ 9,90	6,3 mm	31 mm	1/4" HEX x 25 mm
S026/08	€ 9,90	8,3 mm	31 mm	1/4" HEX x 25 mm
S026/10	€ 10,80	10,4 mm	34 mm	1/4" HEX x 25 mm
S026/12	€ 11,30	12,4 mm	35 mm	1/4" HEX x 25 mm
S026/16	€ 12,40	16,5 mm	40 mm	1/4" HEX x 25 mm
S026/20	€ 14,40	20,5 mm	41 mm	1/4" HEX x 25 mm

S026/06-20S
€ 63,20
SERIE SVASATORI CON GAMBO ESAGONALE

Per eseguire svasature coniche senza vibrazioni.

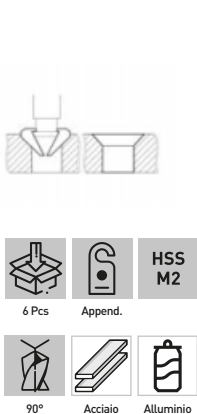
 Misure 6,3 - 8,3 - 10,4 - 12,4 - 16,5 - 20,5 mm
 Dimensioni gambo 1/4" HEX x 25 mm

S026/06-20SM
€ 77,10
SERIE SVASATORI CON GAMBO ESAGONALE

Per eseguire svasature coniche senza vibrazioni. Con manico e prolunga magnetica.

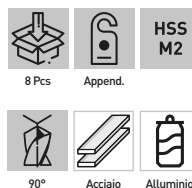
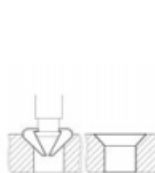
 Misure 6,3 - 8,3 - 10,4 - 12,4 - 16,5 - 20,5 mm
 Dimensioni gambo 1/4" HEX x 25 mm



S1-

NEW

SVASATORE A 3 TAGLIENTI 60°

Con spoglie rettificate e scanalature ricavate dal pieno, per eseguire svasature coniche senza vibrazioni.

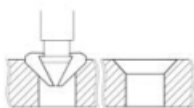

Art.	€	Ø max	Lunghezza	Gambo
S1/06	€ 8,40	6,3 mm	45 mm	5 mm
S1/08	€ 10,70	8 mm	50 mm	6 mm
S1/10	€ 12,00	10 mm	53 mm	6 mm
S1/12	€ 13,00	12,5 mm	56 mm	8 mm
S1/16	€ 16,50	16 mm	63 mm	10 mm
S1/20	€ 21,50	20 mm	67 mm	10 mm
S1/25	€ 33,00	25 mm	71 mm	10 mm

A014-

UTENSILE CONICO ALLARGAFORI

Con gambo cilindrico.



Art.	€	Ø	Lunghezza totale
A014/03-14	€ 13,10	3 - 14 mm	58 mm
A014/06-20	€ 22,70	6 - 20 mm	63 mm
A014/16-30	€ 40,50	16 - 30,5 mm	72 mm
A014/26-40	€ 75,10	26 - 40 mm	86 mm
A014/36-50	€ 101,00	36 - 50 mm	89 mm
A014/40-61	€ 168,00	40 - 61 mm	94 mm
A014/03-31	€ 47,40	3 - 31 mm	104 mm
A014/03-22	€ 28,10	3 - 22,5 mm	76 mm

F639

€ 82,50

UTENSILE CONICO A GRADINO

Per creare e allargare fori in lamiera.



Gambo	10 mm
Ø	6 + 39 (6-9-12-15-18-21-24-27-30-33-36-39) mm

S001/60

€ 65,00 NEW

SERIE SVASATORI A 3 TAGLIENTI 60°

Con spoglie rettificate e scanalature ricavate dal pieno, per eseguire svasature coniche senza vibrazioni.

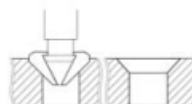

Ø max	6-8-10-12,5-16-20 mm
-------	----------------------



A014/03-30S

€ 85,40

SERIE UTENSILI CONICI ALLARGAFORI

Con gambo cilindrico.



Misure	3-14 - 6-20 - 16-30,5 mm
--------	--------------------------



F430

€ 78,10

SERIE UTENSILI CONICI A SCALINI

Per creare e allargare fori in lamiera.



Gambo	6 - 8 - 10 mm
Ø	4 + 12 - 6 + 20 - 6 + 30 mm



F23X
UTENSILE CONICO A GRADINO

Per creare e allargare fori in lamiera, con punta intercambiabile.



Art.	€	Gambo	Ø
F232	€ 76,00	10 mm	2,5 ÷ 32 (2,5-6,3-11,2-14,5-18,2-22,3-27,9-32) mm
F238	€ 81,40	10 mm	2,5 ÷ 38 (2,5-6,3-13-16-19-21-23-26-29-32-35-38) mm

P037-
PUNTA FRESA

Per foratura e fresatura di materiali sottili.



Art.	€	Ø	Gambo	Lunghezza totale
P037/6	€ 2,85	6 mm	6 mm	90 mm
P037/8	€ 4,26	8 mm	8 mm	90 mm

F001/10
€ 239,00
SERIE FRESE FRONTALI A SGROSSARE

Taglio al centro, gambo cilindrico, attacco weldon, serie normale



Fresa	Ø 6 8 10 12 14 16 18 20 22 25 mm
Gambo	Ø 6 10 10 12 12 16 16 20 20 25 mm

F025
€ 6,80
PUNTA DI RICAMBIO

Compatibile con F232 F238.



Gambo	4 mm
Punta di ricambio	Ø 2,5 mm

P036-
PUNTA FRESA

Per rimuovere punti di saldatura e per forare lamiera in genere.



Art.	€	Ø	Lunghezza totale
P036/06	€ 6,20	6 mm	66 mm
P036/07	€ 8,80	7 mm	74 mm
P036/08	€ 9,30	8 mm	79 mm
P036/10	€ 10,40	10 mm	89 mm

F001/20
€ 239,00
SERIE FRESE FRONTALI PER FINITURA

A 2 e 4 taglienti, taglio al centro, gambo cilindrico, attacco weldon, serie normale.



Fresa 2 T	Ø 3 - 4 - 5 - 6 - 8 - 10 - 12 - 14 - 18 - 20 mm
Gambo	Ø 6 - 6 - 6 - 6 - 10 - 10 - 12 - 12 - 16 - 20 mm
Fresa 4 T	Ø 3 - 4 - 5 - 6 - 8 - 10 - 12 - 14 - 18 - 20 mm
Gambo	Ø 6 - 6 - 6 - 6 - 10 - 10 - 12 - 12 - 16 - 20 mm



F005-

FRESA FRONTALE PER FINITURA A 2 TAGLIANTI

Per finitura, gambo cilindrico, attacco weldon, serie normale.



Art.	€	D	d	l	Z	L
F005/03	€ 7,90	3 mm	6 mm	5 mm	2	49 mm
F005/04	€ 8,20	4 mm	6 mm	7 mm	2	51 mm
F005/05	€ 9,20	5 mm	6 mm	8 mm	2	52 mm
F005/06	€ 9,50	6 mm	6 mm	8 mm	2	52 mm
F005/08	€ 11,30	8 mm	10 mm	11 mm	2	61 mm
F005/10	€ 11,40	10 mm	10 mm	13 mm	2	63 mm
F005/12	€ 13,30	12 mm	12 mm	16 mm	2	73 mm

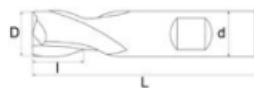

Art.	€	D	d	l	Z	L
F005/14	€ 17,90	14 mm	12 mm	16 mm	2	73 mm
F005/16	€ 26,50	16 mm	16 mm	19 mm	2	79 mm
F005/18	€ 27,50	18 mm	16 mm	19 mm	2	79 mm
F005/20	€ 37,30	20 mm	20 mm	22 mm	2	88 mm
F005/22	€ 46,20	22 mm	20 mm	22 mm	2	88 mm
F005/24	€ 52,40	24 mm	20 mm	26 mm	2	92 mm
F005/25	€ 56,70	25 mm	20 mm	26 mm	2	92 mm

F006-

FRESA FRONTALE PER FINITURA A 4 TAGLIANTI

Per finitura, gambo cilindrico, attacco weldon, serie normale.



Art.	€	D	d	l	Z	L
F006/03	€ 8,20	3 mm	6 mm	8 mm	4	52 mm
F006/04	€ 8,20	4 mm	6 mm	11 mm	4	55 mm
F006/05	€ 9,30	5 mm	6 mm	13 mm	4	57 mm
F006/06	€ 9,50	6 mm	6 mm	13 mm	4	57 mm
F006/08	€ 11,90	8 mm	10 mm	19 mm	4	69 mm
F006/10	€ 12,50	10 mm	10 mm	22 mm	4	72 mm



Art.	€	D	d	l	Z	L
F006/12	€ 16,20	12 mm	12 mm	26 mm	4	83 mm
F006/14	€ 16,20	14 mm	12 mm	26 mm	4	83 mm
F006/16	€ 23,70	16 mm	16 mm	32 mm	4	92 mm
F006/18	€ 23,90	18 mm	16 mm	32 mm	4	92 mm
F006/20	€ 33,50	20 mm	20 mm	38 mm	4	104 mm

F007-

FRESA FRONTALE A 4 TAGLIANTI PER SGROSSATURA

Taglio al centro, gambo cilindrico, attacco weldon, serie normale per sgrossatura passo fine.



Art.	€	D	d	l	Z	L
F007/06	€ 13,30	6 mm	6 mm	13 mm	4	57 mm
F007/07	€ 13,30	7 mm	10 mm	16 mm	4	66 mm
F007/08	€ 14,70	8 mm	10 mm	19 mm	4	69 mm
F007/09	€ 17,10	9 mm	10 mm	19 mm	4	69 mm
F007/10	€ 17,10	10 mm	10 mm	22 mm	4	72 mm
F007/11	€ 17,10	11 mm	12 mm	22 mm	4	76 mm
F007/12	€ 17,10	12 mm	12 mm	26 mm	4	83 mm
F007/13	€ 18,40	13 mm	12 mm	26 mm	4	83 mm

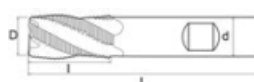

Art.	€	D	d	l	Z	L
F007/14	€ 18,40	14 mm	12 mm	26 mm	4	83 mm
F007/15	€ 23,20	15 mm	12 mm	26 mm	4	83 mm
F007/16	€ 23,20	16 mm	16 mm	32 mm	4	92 mm
F007/18	€ 31,80	18 mm	16 mm	32 mm	4	92 mm
F007/20	€ 43,20	20 mm	20 mm	38 mm	4	104 mm
F007/22	€ 49,50	22 mm	20 mm	38 mm	4	104 mm
F007/25	€ 54,70	25 mm	25 mm	45 mm	4	121 mm



FRESE ROTATIVE IN METALLO DURO

Tipologia di taglio	Rappresentazione	Descrizione
Taglio Standard		Tipologia di taglio adatta per acciaio, acciaio temprato, ghisa, cordoni di saldatura e materiali metallici in generale.
Taglio incrociato		Tipologia di taglio adatta per acciai trattati, acciaio inox, materiali metallici in generale. Grazie a questa tipologia di taglio le vibrazioni sono notevolmente ridotte.
Taglio Alluminio		Tipologia di taglio adatta per alluminio, magnesio, plastiche e gomma dura.

TIPOLOGIE DI FORME ED IL LORO UTILIZZO

Cilindrica senza taglio frontale 	Cilindrica a taglio frontale 	Cilindrica a testa raggiata 	Sferica
Ovale 	Ogiva a punta arrotondata 	Ogiva 	A lancia raggiata
Conica a punta raggiata 	Conica a punta 	Tronco coniche 	Conica a 90°
Conica a 60° 			

AXSC FRESE ROTATIVE CILINDRICA SENZA TAGLIO FRONTALE

Scatola
 HM
 Acciaio

Ghisa
 A secco
 Smerigl. assiale

Art.	€	D1	L1	D2	L2
A02SC3	€ 4,67	ø2 mm	10 mm	3 mm	38 mm
A06SC6	€ 13,00	ø6 mm	16 mm	6 mm	61 mm
A08SC6	€ 14,60	ø8 mm	20 mm	6 mm	65 mm
A10SC6	€ 18,20	ø10 mm	20 mm	6 mm	65 mm
A12SC6	€ 26,60	ø12 mm	25 mm	6 mm	70 mm
A16SC6	€ 41,50	ø16 mm	25 mm	6 mm	70 mm

AXDC FRESE ROTATIVE A taglio diamante.

Scatola
 HM
 Acciaio

Inox
 Ghisa
 A secco

Art.	€	D1	L1	D2	L2
A02DC3	€ 4,67	ø2 mm	10 mm	3 mm	38 mm
A06DC6	€ 13,00	ø6 mm	16 mm	6 mm	61 mm
A08DC6	€ 14,60	ø8 mm	20 mm	6 mm	65 mm
A10DC6	€ 18,20	ø10 mm	20 mm	6 mm	65 mm
A12DC6	€ 26,60	ø12 mm	25 mm	6 mm	70 mm
A16DC6	€ 41,50	ø16 mm	25 mm	6 mm	70 mm



A12AL6

€ 30,70

FRESE ROTATIVE PER ALLUMINIO

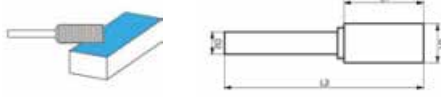

D1	ø12 mm
L1	25 mm
D2	6 mm
L2	70 mm

BXDC

FRESE ROTATIVE A TAGLIO DIAMANTE



Art.	€	D1	L1	D2	L2
B02DC3	€ 4,67	ø2 mm	10 mm	3 mm	38 mm
B03DC3	€ 4,67	ø3 mm	13 mm	3 mm	38 mm
B04DC3	€ 9,90	ø4 mm	13 mm	3 mm	41 mm
B04DC6	€ 10,40	ø4 mm	13 mm	6 mm	58 mm
B06DC6	€ 13,00	ø6 mm	16 mm	6 mm	61 mm
B08DC6	€ 14,60	ø8 mm	20 mm	6 mm	65 mm
B10DC6	€ 18,20	ø10 mm	20 mm	6 mm	65 mm
B12DC6	€ 26,60	ø12 mm	25 mm	6 mm	70 mm
B16DC6	€ 41,50	ø16 mm	25 mm	6 mm	70 mm
B19DC6	€ 60,30	ø19 mm	25 mm	6 mm	70 mm
B22DC6	€ 92,50	ø22 mm	25 mm	6 mm	70 mm
B25DC6	€ 107,00	ø25 mm	25 mm	6 mm	70 mm

BXSCXL

FRESE ROTATIVE A TAGLIO SINGOLO LUNGHE



Art.	€	D1	L1	D2	L2
B02SC3L	€ 6,10	ø2 mm	10 mm	3 mm	65 mm
B03SC3L	€ 6,10	ø3 mm	13 mm	3 mm	65 mm
B08SC6L	€ 18,70	ø8 mm	20 mm	6 mm	120 mm
B10SC6L	€ 23,40	ø10 mm	20 mm	6 mm	120 mm
B12SC6L	€ 28,60	ø12 mm	25 mm	6 mm	120 mm

BXSC

FRESE ROTATIVE A TAGLIO SINGOLO

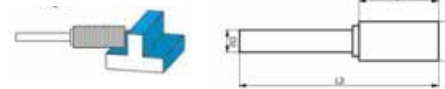

Art.	€	D1	L1	D2	L2
B02SC3	€ 4,67	ø2 mm	10 mm	3 mm	38 mm
B03SC3	€ 4,67	ø3 mm	13 mm	3 mm	38 mm
B04SC3	€ 9,90	ø4 mm	13 mm	3 mm	41 mm
B04SC6	€ 10,40	ø4 mm	13 mm	6 mm	58 mm
B06SC6	€ 13,00	ø6 mm	16 mm	6 mm	61 mm
B08SC6	€ 14,60	ø8 mm	20 mm	6 mm	65 mm
B10SC6	€ 18,20	ø10 mm	20 mm	6 mm	65 mm
B12SC6	€ 26,60	ø12 mm	25 mm	6 mm	70 mm
B16SC6	€ 41,50	ø16 mm	25 mm	6 mm	70 mm

BXAL

FRESE ROTATIVE PER ALLUMINIO



Art.	€	D1	L1	D2	L2
B06AL6	€ 15,10	ø6 mm	16 mm	6 mm	61 mm
B08AL6	€ 17,20	ø8 mm	20 mm	6 mm	65 mm
B10AL6	€ 20,80	ø10 mm	20 mm	6 mm	65 mm
B12AL6	€ 30,10	ø12 mm	25 mm	6 mm	70 mm

BXDCXL

FRESE ROTATIVE IN MD TAGLIO DIAMANTE LUNGO

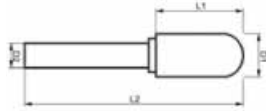
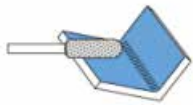

Art.	€	D1	L1	D2	L2
B02DC3L	€ 6,10	ø2 mm	10 mm	3 mm	65 mm
B03DC3L	€ 6,10	ø3 mm	13 mm	3 mm	65 mm
B08DC6L	€ 18,70	ø8 mm	20 mm	6 mm	120 mm
B10DC6L	€ 23,40	ø10 mm	20 mm	6 mm	120 mm
B12DC6L	€ 28,60	ø12 mm	25 mm	6 mm	120 mm

CXSC
FRESE ROTATIVE A TAGLIO SINGOLO

Art.	€	D1	L1	D2	L2
C02SC3	€ 4,67	ø2 mm	10 mm	3 mm	38 mm
C03SC3	€ 4,67	ø3 mm	13 mm	3 mm	38 mm
C04SC3	€ 9,90	ø4 mm	13 mm	3 mm	58 mm
C04SC6	€ 10,40	ø4 mm	13 mm	6 mm	58 mm
C06SC6	€ 13,00	ø6 mm	16 mm	6 mm	61 mm
C08SC6	€ 14,60	ø8 mm	20 mm	6 mm	65 mm
C10SC6	€ 18,20	ø10 mm	20 mm	6 mm	65 mm
C12SC6	€ 26,60	ø12 mm	25 mm	6 mm	70 mm
C16SC6	€ 41,50	ø16 mm	25 mm	6 mm	70 mm

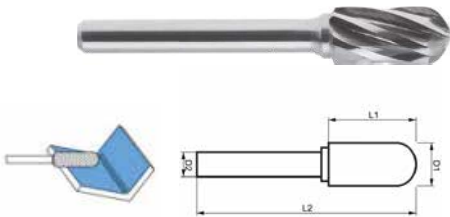
CXAL
FRESE ROTATIVE PER ALLUMINIO

Art.	€	D1	L1	D2	L2
C06AL6	€ 14,60	ø6 mm	16 mm	6 mm	61 mm
C08AL6	€ 17,20	ø8 mm	20 mm	6 mm	65 mm
C10AL6	€ 20,80	ø10 mm	20 mm	6 mm	65 mm
C12AL6	€ 30,10	ø12 mm	25 mm	6 mm	70 mm

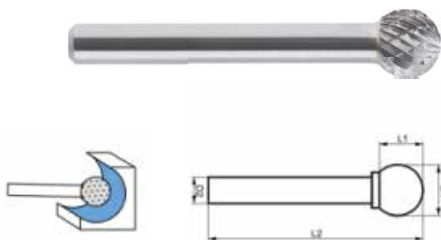
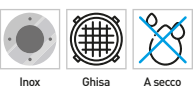
DXDC
FRESE ROTATIVE A TAGLIO DIAMANTE

Art.	€	D1	L1	D2	L2
D03DC3	€ 4,67	ø3 mm	2.7 mm	3 mm	38 mm
D04DC6	€ 10,40	ø4 mm	3.6 mm	6 mm	38 mm
D06DC6	€ 10,40	ø6 mm	5.4 mm	6 mm	50 mm
D08DC6	€ 11,40	ø8 mm	7.2 mm	6 mm	52 mm
D10DC6	€ 15,10	ø10 mm	9 mm	6 mm	54 mm
D12DC6	€ 21,30	ø12 mm	10.8 mm	6 mm	56 mm
D16DC6	€ 29,10	ø16 mm	14.4 mm	6 mm	60 mm
D19DC6	€ 60,30	ø19 mm	17.4 mm	6 mm	64 mm

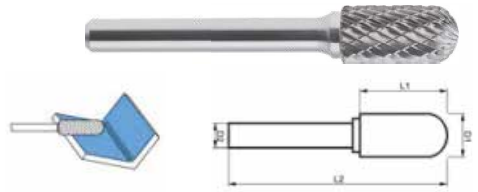
CXDC
FRESE ROTATIVE A TAGLIO DIAMANTE

Art.	€	D1	L1	D2	L2
C02DC3	€ 4,67	ø2 mm	10 mm	3 mm	38 mm
C03DC3	€ 4,67	ø3 mm	13 mm	3 mm	38 mm
C04DC3	€ 9,90	ø4 mm	13 mm	3 mm	38 mm
C04DC6	€ 10,40	ø4 mm	13 mm	6 mm	38 mm
C06DC6	€ 13,00	ø6 mm	16 mm	6 mm	61 mm
C08DC6	€ 14,60	ø8 mm	20 mm	6 mm	65 mm
C10DC6	€ 18,20	ø10 mm	20 mm	6 mm	65 mm
C12DC6	€ 26,60	ø12 mm	25 mm	6 mm	70 mm
C16DC6	€ 41,50	ø16 mm	25 mm	6 mm	70 mm
C19DC6	€ 60,30	ø19 mm	25 mm	6 mm	70 mm
C22DC6	€ 92,50	ø22 mm	25 mm	6 mm	70 mm
C25DC6	€ 107,00	ø25 mm	25 mm	6 mm	70 mm

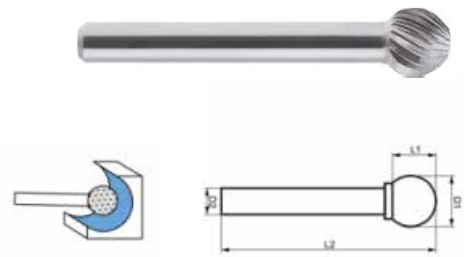
DXSC
FRESE ROTATIVE A TAGLIO SINGOLO

Art.	€	D1	L1	D2	L2
D03SC3	€ 4,67	ø3 mm	2.7 mm	3 mm	38 mm
D04SC6	€ 10,40	ø4 mm	3.6 mm	6 mm	38 mm
D06SC6	€ 10,40	ø6 mm	5.4 mm	6 mm	50 mm
D08SC6	€ 11,40	ø8 mm	7.2 mm	6 mm	52 mm
D10SC6	€ 15,10	ø10 mm	9 mm	6 mm	54 mm
D12SC6	€ 21,30	ø12 mm	10.8 mm	6 mm	56 mm
D16SC6	€ 29,10	ø16 mm	14.4 mm	6 mm	60 mm

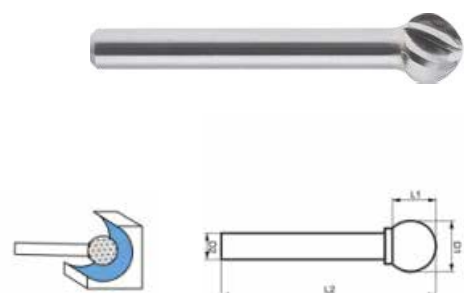
DXAL
FRESE ROTATIVE PER ALLUMINIO

Art.	€	D1	L1	D2	L2
D06AL6	€ 12,00	ø6 mm	5.4 mm	6 mm	50 mm
D08AL6	€ 12,50	ø8 mm	7.2 mm	6 mm	52 mm
D10AL6	€ 17,70	ø10 mm	9 mm	6 mm	54 mm



EXSC

FRESE ROTATIVE A TAGLIO SINGOLO

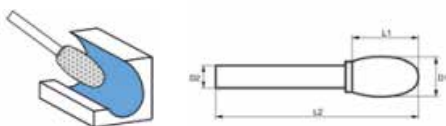

Art.	€	D1	L1	D2	L2
E08SC6	€ 14,60	ø8 mm	13 mm	6 mm	58 mm
E10SC6	€ 18,20	ø10 mm	16 mm	6 mm	61 mm
E12SC6	€ 26,60	ø12 mm	20 mm	6 mm	65 mm
E16SC6	€ 41,50	ø16 mm	25 mm	6 mm	70 mm

EXDC

FRESE ROTATIVE A TAGLIO DIAMANTE

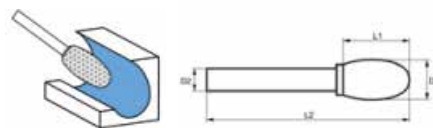
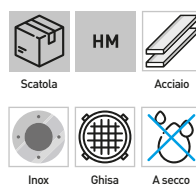

Art.	€	D1	L1	D2	L2
E08DC6	€ 14,60	ø8 mm	13 mm	6 mm	58 mm
E10DC6	€ 18,20	ø10 mm	16 mm	6 mm	61 mm
E12DC6	€ 26,60	ø12 mm	20 mm	6 mm	65 mm
E16DC6	€ 41,50	ø16 mm	25 mm	6 mm	70 mm

EXAL

FRESE ROTATIVE PER ALLUMINIO

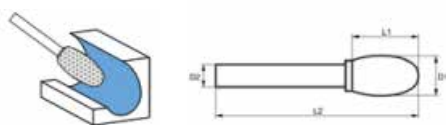

Art.	€	D1	L1	D2	L2
E10AL6	€ 20,80	10 mm	16 mm	6 mm	61 mm
E12AL6	€ 30,70	12 mm	20 mm	6 mm	65 mm

FXSC

FRESE ROTATIVE A TAGLIO SINGOLO

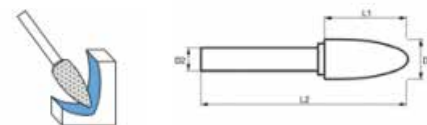

Art.	€	D1	D2	L1	L2
F03SC3	€ 4,67	ø3 mm	13 mm	3 mm	38 mm
F06SC6	€ 13,00	ø6 mm	18 mm	6 mm	63 mm
F08SC6	€ 14,60	ø8 mm	20 mm	6 mm	65 mm
F10SC6	€ 18,20	ø10 mm	20 mm	6 mm	65 mm
F12SC6	€ 26,60	ø12 mm	25 mm	6 mm	70 mm

FXDC

FRESE ROTATIVE A TAGLIO DIAMANTE

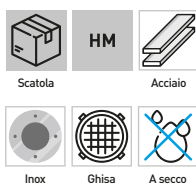

Art.	€	D1	D2	L1	L2
F03DC3	€ 4,67	ø3 mm	13 mm	3 mm	38 mm
F06DC6	€ 13,00	ø6 mm	18 mm	6 mm	63 mm
F08DC6	€ 14,60	ø8 mm	20 mm	6 mm	65 mm
F10DC6	€ 18,20	ø10 mm	20 mm	6 mm	65 mm
F12DC6	€ 26,60	ø12 mm	25 mm	6 mm	70 mm
F16DC6	€ 41,50	ø16 mm	25 mm	6 mm	70 mm
F19DC6	€ 60,30	ø19 mm	25 mm	6 mm	70 mm

FXAL

FRESE ROTATIVE PER ALLUMINIO

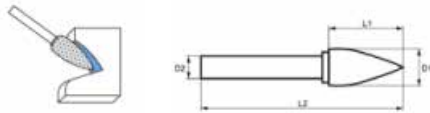

Art.	€	D1	L1	D2	L2
F10AL6	€ 20,80	ø10 mm	20 mm	6 mm	65 mm
F12AL6	€ 30,70	ø12 mm	25 mm	6 mm	70 mm

GXSC
FRESE ROTATIVE A TAGLIO SINGOLO

Art.	€	D1	L1	D2	L2
G03SC3	€ 4,67	ø3 mm	13 mm	3 mm	38 mm
G06SC6	€ 13,00	ø6 mm	18 mm	6 mm	65 mm
G10SC6	€ 18,20	ø10 mm	20 mm	6 mm	65 mm
G12SC6	€ 26,60	ø12 mm	25 mm	6 mm	70 mm

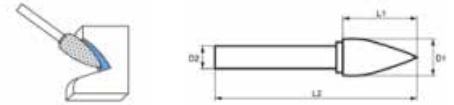
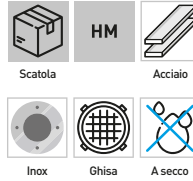
GXDC
FRESE ROTATIVE A TAGLIO DIAMANTE

Art.	€	D1	L1	D2	L2
G03DC3	€ 4,67	ø3 mm	13 mm	3 mm	38 mm
G06DC6	€ 13,00	ø6 mm	18 mm	6 mm	65 mm
G10DC6	€ 18,20	ø10 mm	20 mm	6 mm	65 mm
G12DC6	€ 26,60	ø12 mm	25 mm	6 mm	70 mm
G16DC6	€ 41,50	ø16 mm	25 mm	6 mm	70 mm
G19DC6	€ 60,30	ø19 mm	25 mm	6 mm	70 mm

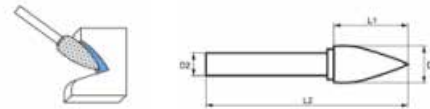
GXAL
FRESE ROTATIVE PER ALLUMINIO

Art.	€	D1	L1	D2	L2
G10AL6	€ 20,80	ø10 mm	20 mm	6 mm	65 mm
G12AL6	€ 30,70	ø12 mm	25 mm	6 mm	70 mm

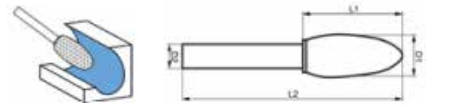
HXSC
FRESE ROTATIVE A TAGLIO SINGOLO

Art.	€	D1	L1	D2	L2
H08SC6	€ 14,10	ø8 mm	20 mm	6 mm	65 mm
H10SC6	€ 16,10	ø10 mm	25 mm	6 mm	70 mm
H12SC6	€ 30,10	ø12 mm	32 mm	6 mm	77 mm

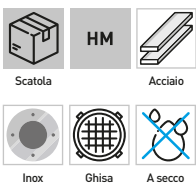
HXDC
FRESE ROTATIVE A TAGLIO DIAMANTE

Art.	€	D1	D2	L1	L2
H06DC6	€ 13,00	ø6 mm	16 mm	6 mm	61 mm
H08DC6	€ 14,10	ø8 mm	20 mm	6 mm	65 mm
H10DC6	€ 16,10	ø10 mm	25 mm	6 mm	70 mm
H12DC6	€ 30,10	ø12 mm	32 mm	6 mm	77 mm

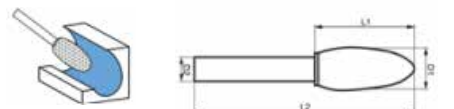
HXAL
FRESE ROTATIVE PER ALLUMINIO

Art.	€	D1	D2	L1	L2
H08AL6	€ 16,10	ø8 mm	20 mm	6 mm	65 mm
H10AL6	€ 20,80	ø10 mm	25 mm	6 mm	70 mm
H12AL6	€ 35,30	ø12 mm	32 mm	6 mm	77 mm



LXSC

FRESE ROTATIVE A TAGLIO SINGOLO

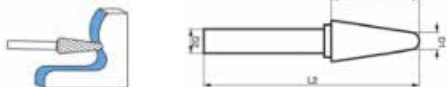

Art.	€	D1	L1	D2	L2
L03SC3	€ 4,67	ø3 mm	13 mm	3 mm	38 mm
L06SC6	€ 13,00	ø6 mm	16 mm	6 mm	61 mm

LXDC

FRESE ROTATIVE A TAGLIO DIAMANTE



Art.	€	D1	L1	D2	L2
L03DC3	€ 4,67	ø3 mm	13 mm	3 mm	38 mm
L06DC6	€ 13,00	ø6 mm	16 mm	6 mm	61 mm
L08DC6	€ 15,50	ø8 mm	22 mm	6 mm	65 mm
L10DC6	€ 19,70	ø10 mm	25 mm	6 mm	70 mm
L12DC6	€ 26,60	ø12 mm	25 mm	6 mm	70 mm

L10AL6

€ 20,80

FRESE ROTATIVE PER ALLUMINIO

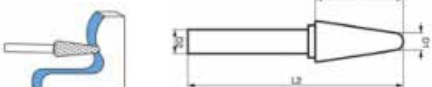

D1	ø10 mm
L1	25 mm
D2	6 mm
L2	70 mm

MXSC

FRESE ROTATIVE A TAGLIO SINGOLO

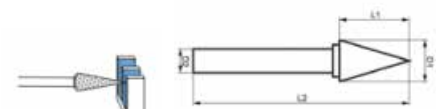

Art.	€	D1	L1	D2	L2
M08SC6	€ 14,60	ø8 mm	20 mm	6 mm	65 mm
M10SC6	€ 18,70	ø10 mm	20 mm	6 mm	65 mm
M12SC6	€ 26,60	ø12 mm	25 mm	6 mm	70 mm

MXDC

FRESE ROTATIVE A TAGLIO DIAMANTE

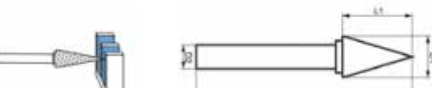

Art.	€	D1	L1	D2	L2
M03DC3	€ 4,67	ø3 mm	11 mm	3 mm	38 mm
M03DC6	€ 8,70	ø3 mm	11 mm	6 mm	38 mm
M06DC6	€ 13,00	ø6 mm	18 mm	6 mm	60 mm
M08DC6	€ 14,60	ø8 mm	20 mm	6 mm	65 mm
M10DC6	€ 18,70	ø10 mm	20 mm	6 mm	65 mm
M12DC6	€ 26,60	ø12 mm	25 mm	6 mm	70 mm
M16DC6	€ 41,50	ø16 mm	25 mm	6 mm	70 mm

M10AL6

€ 19,70

FRESE ROTATIVE PER ALLUMINIO

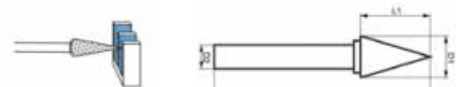

D1	ø10 mm
L1	20 mm
D2	6 mm
L2	65 mm

NXSC
FRESE ROTATIVE A TAGLIO SINGOLO

Scatola HM Acciaio



Ghisa A secco Smerigl. assiale

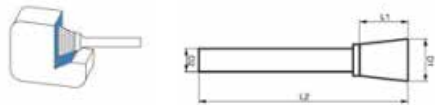

Art.	€	D1	L1	D2	L2
N12SC6	€ 26,60	ø12 mm	13 mm	6 mm	58 mm
N16SC6	€ 37,40	ø16 mm	16 mm	6 mm	58 mm

N12DC6

€ 26,60

FRESE ROTATIVE A TAGLIO DIAMANTE

Scatola HM Acciaio



Inox Ghisa A secco

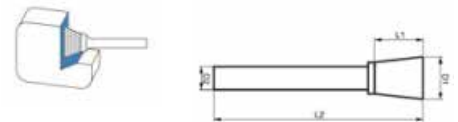

D1	ø12 mm
L1	13 mm
D2	6 mm
L2	58 mm

JXSC
FRESE ROTATIVE A TAGLIO SINGOLO

Scatola HM Acciaio



Ghisa A secco Smerigl. assiale



Art.	€	D1	L1	D2	L2
J03SC3	€ 4,67	ø3 mm	2.5 mm	3 mm	38 mm
J06SC6	€ 13,00	ø6 mm	5.2 mm	6 mm	54 mm
J10SC6	€ 18,20	ø10 mm	8 mm	6 mm	58 mm
J16SC6	€ 41,50	ø16 mm	13 mm	6 mm	62 mm

JXDC
FRESE ROTATIVE A TAGLIO DIAMANTE

Scatola HM Acciaio



Inox Ghisa A secco

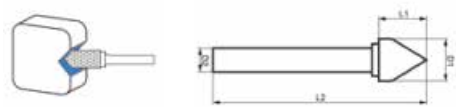

Art.	€	D1	L1	D2	L2
J03DC3	€ 4,67	ø3 mm	2.5 mm	3 mm	38 mm
J06DC6	€ 13,00	ø6 mm	5.2 mm	6 mm	54 mm
J10DC6	€ 18,20	ø10 mm	8 mm	6 mm	58 mm
J16DC6	€ 41,50	ø16 mm	13 mm	6 mm	62 mm

KXSC
FRESE ROTATIVE A TAGLIO SINGOLO

Scatola HM Acciaio



Ghisa A secco Smerigl. assiale

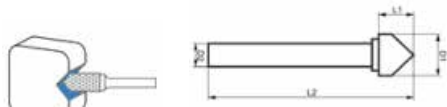

Art.	€	D1	L1	D2	L2
K10SC6	€ 18,20	ø10 mm	5 mm	6 mm	54 mm
K16SC6	€ 37,40	ø16 mm	8 mm	6 mm	58 mm

KXDC
FRESE ROTATIVE A TAGLIO DIAMANTE

Scatola HM Acciaio

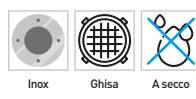

Inox Ghisa A secco

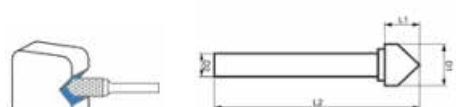

Art.	€	D1	L1	D2	L2
K10DC6	€ 18,20	ø10 mm	5 mm	6 mm	54 mm
K16DC6	€ 37,40	ø16 mm	8 mm	6 mm	58 mm



F008DC

€ 67,50

SERIE FRESE ROTATIVE IN METALLO DURO

Con taglio a diamante.

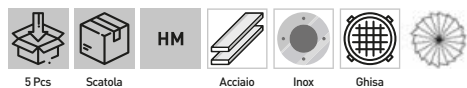

Misure	10 x 20 mm
Tipo	B, C, D, G, M
Gambo	6 mm

F008SC

€ 67,50

SERIE FRESE ROTATIVE IN METALLO DURO

A taglio singolo.



Misure	10 x 20 mm
Tipo	B, C, D, G, M
Gambo	6 mm

F008-

FRESE ROTATIVE

In metallo duro con taglio incrociato.

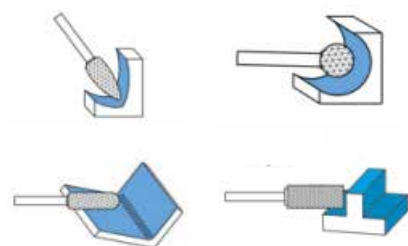

Art.	€	Gambo
F008/3	€ 63,00	Ø 3 mm
F008/6	€ 107,00	Ø 6 mm



C003-
COLTELLO STOZZATORE NORMALE A DISCO

Forma base foro 44,45 mm angolo di pressione 20° classe A.



Art.	€	Modulo	Ø max	Ø d0	Altezza b1	Denti
C003/1	€ 344,00	1,00	102 mm	100 mm	16 mm	100
C003/1.25	€ 344,00	1,25	105 mm	100 mm	16 mm	80
C003/1.50	€ 374,00	1,50	107 mm	102 mm	18 mm	68
C003/1.75	€ 404,00	1,75	107,4 mm	101,5 mm	20 mm	58
C003/2	€ 404,00	2,00	107,31 mm	100 mm	20 mm	50
C003/2.25	€ 404,00	2,25	109,29 mm	101,25 mm	20 mm	45
C003/2.50	€ 462,00	2,50	108,46 mm	100 mm	20 mm	40
C003/2.75	€ 462,00	2,75	108,36 mm	99 mm	24 mm	36
C003/3	€ 462,00	3,00	111,82 mm	99 mm	24 mm	33
C003/3.25	€ 507,00	3,25	110,99 mm	99 mm	24 mm	31
C003/3.50	€ 507,00	3,50	108,72 mm	101,5 mm	24 mm	29
C003/3.75	€ 507,00	3,75	112,35 mm	101,5 mm	24 mm	27
C003/4	€ 507,00	4,00	111,75 mm	100 mm	24 mm	25
C003/4.25	€ 540,00	4,25	114,12 mm	102 mm	24 mm	24
C003/4.50	€ 540,00	4,50	111,65 mm	99 mm	24 mm	22
C003/5	€ 550,00	5,00	114,05 mm	100 mm	24 mm	20
C003/5.50	€ 584,00	5,50	119,96 mm	99 mm	24 mm	18
C003/6	€ 584,00	6,00	118,86 mm	102 mm	24 mm	17
C003/6.50	€ 732,00	6,50	122,5 mm	112 mm	24 mm	16
C003/7	€ 852,00	7,00	127 mm	105 mm	24 mm	15
C003/8	€ 957,00	8,00	135 mm	112 mm	24 mm	14
C003/10	€ 1310,00	10,00	168 mm	140 mm	24 mm	14

C001-
CREATORE PER INGRANAGGI CILINDRICI CON ANGOLO DI PRESSIONE 20°

Profilo rettificato finitore classe A.



Art.	€	Modulo	Diametro Ø	Lunghezza	Foro
C001/1	€ 380,00	1,00	50 mm	31 mm	22 mm
C001/1.25	€ 380,00	1,25	50 mm	31 mm	22 mm
C001/1.50	€ 380,00	1,50	53 mm	50 mm	22 mm
C001/1.75	€ 380,00	1,75	56 mm	38 mm	22 mm
C001/2	€ 392,00	2,00	63 mm	46 mm	27 mm
C001/2.25	€ 453,00	2,25	70 mm	56 mm	27 mm
C001/2.50	€ 453,00	2,50	71 mm	63 mm	27 mm
C001/2.75	€ 453,00	2,75	70 mm	56 mm	27 mm
C001/3	€ 550,00	3,00	80 mm	71 mm	32 mm
C001/3.25	€ 642,00	3,25	80 mm	69 mm	32 mm
C001/3.50	€ 668,00	3,50	80 mm	71 mm	32 mm
C001/3.75	€ 765,00	3,75	90 mm	78 mm	32 mm
C001/4	€ 765,00	4,00	90 mm	78 mm	32 mm
C001/4.25	€ 834,00	4,25	90 mm	78 mm	32 mm
C001/4.50	€ 834,00	4,50	90 mm	78 mm	32 mm
C001/5	€ 834,00	5,00	100 mm	88 mm	32 mm
C001/5.50	€ 834,00	5,50	100 mm	88 mm	32 mm
C001/6	€ 1100,00	6,00	110 mm	108 mm	40 mm
C001/6.50	€ 1170,00	6,50	110 mm	109 mm	40 mm
C001/7	€ 1170,00	7,00	110 mm	110 mm	40 mm
C001/8	€ 1840,00	8,00	125 mm	130 mm	40 mm
C001/9	€ 2090,00	9,00	125 mm	140 mm	40 mm
C001/10	€ 2820,00	10,00	140 mm	160 mm	40 mm
C001/12	€ 4050,00	12,00	170 mm	195 mm	50 mm
C001/13	€ 4260,00	13,00	180 mm	210 mm	50 mm



P049-

PUNTA PER MURO

Serie corta, attacco cilindrico, con inserto in metallo duro.



Scatola

C45

HM

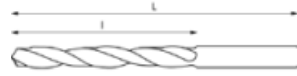

8039



Mattoni



Calcestr.



Pietre



Ceramica



Cartongesso



Percuss.



Trapano Portatile

Art.	€	Ø	L	l	Gambo	Pack
P049/03	€ 0,39	3 mm	70 mm	40 mm	Ø 2,5 mm	10
P049/04	€ 0,41	4 mm	75 mm	40 mm	Ø 3,5 mm	10
P049/05	€ 0,46	5 mm	85 mm	40 mm	Ø 4,5 mm	10
P049/06	€ 0,50	6 mm	100 mm	55 mm	Ø 4,5 mm	10
P049/07	€ 0,74	7 mm	100 mm	55 mm	Ø 6,5 mm	10
P049/08	€ 0,78	8 mm	120 mm	70 mm	Ø 6,5 mm	10
P049/09	€ 0,92	9 mm	120 mm	70 mm	Ø 6,5 mm	10
P049/10	€ 1,04	10 mm	120 mm	70 mm	Ø 7 mm	10
P049/11	€ 1,75	11 mm	150 mm	90 mm	Ø 7 mm	10
P049/12	€ 1,77	12 mm	150 mm	90 mm	Ø 9 mm	10
P049/13	€ 1,99	13 mm	150 mm	90 mm	Ø 9 mm	5
P049/14	€ 2,25	14 mm	150 mm	90 mm	Ø 11 mm	5
P049/15	€ 2,91	15 mm	150 mm	90 mm	Ø 12 mm	5
P049/16	€ 2,94	16 mm	150 mm	90 mm	Ø 12 mm	5
P049/18	€ 5,30	18 mm	160 mm	100 mm	Ø 13 mm	5
P049/22	€ 7,60	22 mm	160 mm	100 mm	Ø 13 mm	5
P049/24	€ 9,00	24 mm	160 mm	100 mm	Ø 13 mm	5

P051-

PUNTA PER MARMO E GRANITO

Attacco cilindrico, specifica per la foratura di marmo e granito con inserto in metallo duro per rotopercolazione



Scatola

C45

HM



8039



Granito



Marmo



Percuss.



Trapano Portatile

Art.	€	Ø	L	l	Gambo	Pack
P051/03	€ 2,88	3 mm	70 mm	40 mm	Ø 2,5 mm	10
P051/04	€ 2,91	4 mm	75 mm	40 mm	Ø 3,5 mm	10
P051/05	€ 3,24	5 mm	85 mm	40 mm	Ø 4,5 mm	10
P051/06	€ 3,56	6 mm	100 mm	55 mm	Ø 5,5 mm	10
P051/07	€ 3,56	7 mm	100 mm	55 mm	Ø 5,5 mm	10
P051/08	€ 3,99	8 mm	120 mm	70 mm	Ø 6,5 mm	5
P051/09	€ 4,25	9 mm	120 mm	70 mm	Ø 8 mm	5
P051/10	€ 4,96	10 mm	120 mm	70 mm	Ø 9 mm	5
P051/12	€ 5,80	12 mm	150 mm	90 mm	Ø 10 mm	5
P051/14	€ 7,40	14 mm	150 mm	90 mm	Ø 12 mm	5
P051/16	€ 8,30	16 mm	150 mm	90 mm	Ø 12 mm	5

P050-

PUNTA PER MURO

Serie lunga, attacco cilindrico, con inserto in metallo duro.



Scatola

C45

HM



8039



Mattoni



Calcestr.



Pietre



Ceramica



Cartongesso



Percuss.



Trapano Portatile

Art.	€	Ø	L	l	Gambo	Pack
P050/06	€ 2,09	6 mm	400 mm	240 mm	Ø 4,5 mm	5
P050/08	€ 2,44	8 mm	400 mm	240 mm	Ø 7 mm	5
P050/09	€ 2,98	9 mm	400 mm	240 mm	Ø 7 mm	5
P050/10	€ 3,56	10 mm	400 mm	240 mm	Ø 7 mm	5
P050/12	€ 4,96	12 mm	400 mm	240 mm	Ø 9 mm	5
P050/14	€ 6,00	14 mm	400 mm	240 mm	Ø 10 mm	5
P050/16	€ 6,70	16 mm	400 mm	240 mm	Ø 12 mm	5
P050/18	€ 8,20	18 mm	400 mm	240 mm	Ø 12,5 mm	5
P050/20	€ 10,40	20 mm	400 mm	240 mm	Ø 12,5 mm	5

P063-

PUNTA PER MURO

2 taglienti, attacco sds-plus, doppia elica per facilitare la fuoriuscita dei detriti, con inserto in metallo duro.



Append.

HM

40 Cr



SDS PLUS



Mattoni



Calcestr.



Pietre



Ceramica



Cartongesso



Percuss.



Trapano Portatile

Art.	€	Misura	Pack
P063/5110	€ 3,33	5 x 110 mm	10
P063/6110	€ 3,33	6 x 110 mm	10
P063/6160	€ 3,33	6 x 160 mm	10
P063/8110	€ 3,33	8 x 110 mm	10
P063/8160	€ 3,33	8 x 160 mm	10
P063/9160	€ 3,33	9 x 160 mm	10
P063/10160	€ 4,00	10 x 160 mm	10
P063/12160	€ 4,00	12 x 160 mm	10
P063/12300	€ 4,65	12 x 300 mm	10
P063/14160	€ 4,65	14 x 160 mm	10
P063/14300	€ 4,65	14 x 300 mm	10
P063/15160	€ 5,40	15 x 160 mm	10
P063/16160	€ 5,40	16 x 160 mm	10
P063/16300	€ 5,40	16 x 300 mm	10
P063/16450	€ 10,00	16 x 450 mm	5
P063/18160	€ 7,40	18 x 160 mm	5
P063/18300	€ 7,40	18 x 300 mm	5
P063/18450	€ 10,90	18 x 450 mm	5
P063/20160	€ 7,40	20 x 160 mm	5
P063/20450	€ 10,90	20 x 450 mm	5
P063/22450	€ 12,90	22 x 450 mm	5
P063/24450	€ 14,60	24 x 450 mm	5

0332
€ 35,60
SERIE PUNTE CON INSERTO IN METALLO DURO E SCALPELLI PER MURO

Con attacco SDS PLUS, composta da 9 punte: Ø4 x 110 mm Ø5 x 110 mm Ø6 x 110 mm Ø5 x 160 mm Ø6 x 160 mm Ø8 x 160 mm Ø9 x 160 mm Ø10 x 160 mm Ø12 x 160 mm, 1 portainseriti, 1 scalpello piatto e 1 scalpello a punta.

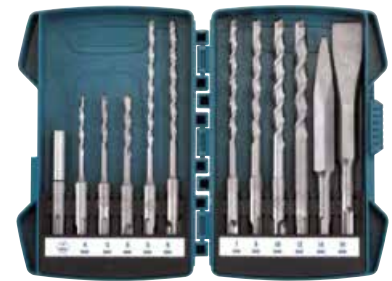
P076-
SEGA A TAZZA PER EDILIZIA CON TAGLIANTI IN METALLO DURO

Per l'esecuzione di fori di medie e grandi dimensioni nel muro.

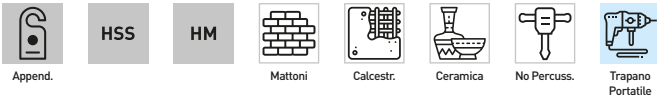
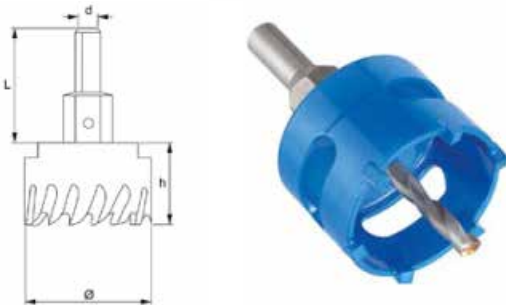

Art.	€	Ø	d	Filetto	Z	L	Punta
P076/016	€ 15,10	16 mm	10 mm	M12 x 1.25	2	46 mm	Ø6 x 69 mm
P076/022	€ 16,20	22 mm	10 mm	M12 x 1.25	3	46 mm	Ø6 x 69 mm
P076/025	€ 20,50	25 mm	10 mm	M12 x 1.25	3	46 mm	Ø6 x 69 mm
P076/027	€ 21,60	27 mm	10 mm	M12 x 1.25	4	46 mm	Ø6 x 69 mm
P076/030	€ 22,70	30 mm	10 mm	M12 x 1.25	4	46 mm	Ø6 x 69 mm
P076/035	€ 23,20	35 mm	10 mm	M12 x 1.25	4	46 mm	Ø6 x 69 mm
P076/038	€ 25,80	38 mm	10 mm	M12 x 1.25	4	46 mm	Ø6 x 69 mm
P076/040	€ 28,60	40 mm	10 mm	M12 x 1.25	5	46 mm	Ø6 x 69 mm
P076/045	€ 30,80	45 mm	10 mm	M12 x 1.25	5	46 mm	Ø6 x 69 mm
P076/050	€ 32,30	50 mm	10 mm	M12 x 1.25	6	46 mm	Ø6 x 69 mm
P076/055	€ 36,60	55 mm	12 mm	M16 x 1.5	6	46 mm	Ø8 x 69 mm
P076/060	€ 38,90	60 mm	12 mm	M16 x 1.5	7	46 mm	Ø8 x 69 mm
P076/065	€ 43,10	65 mm	12 mm	M16 x 1.5	7	46 mm	Ø8 x 69 mm
P076/070	€ 54,00	70 mm	12 mm	M16 x 1.5	8	46 mm	Ø8 x 69 mm
P076/080	€ 61,40	80 mm	12 mm	M16 x 1.5	8	46 mm	Ø8 x 69 mm
P076/085	€ 69,60	85 mm	12 mm	M16 x 1.5	9	46 mm	Ø8 x 69 mm
P076/090	€ 80,90	90 mm	12 mm	M16 x 1.5	9	46 mm	Ø8 x 69 mm
P076/095	€ 81,90	95 mm	12 mm	M16 x 1.5	10	46 mm	Ø8 x 69 mm
P076/100	€ 87,90	100 mm	12 mm	M16 x 1.5	11	46 mm	Ø8 x 69 mm
P076/110	€ 104,00	110 mm	12 mm	M16 x 1.5	11	46 mm	Ø8 x 69 mm
P076/125	€ 114,00	125 mm	12 mm	M16 x 1.5	12	46 mm	Ø8 x 69 mm
P076/150	€ 146,00	150 mm	12 mm	M16 x 1.5	15	46 mm	Ø8 x 69 mm

P076/006S
€ 145,00
SERIE DI SEGHE A TAZZA PER EDILIZIA

Per l'esecuzione di fori di medie e grandi dimensioni nel muro.



Misure 16 mm - 22 mm - 25 mm - 27 mm - 30 mm - 35 mm

P076/008S
€ 213,00
SERIE DI SEGHE A TAZZA PER EDILIZIA

Per l'esecuzione di fori di medie e grandi dimensioni nel muro.



Misure 16 mm - 22 mm - 25 mm - 27 mm - 30 mm - 35 mm - 40 mm - 45 mm

P076-GX
GAMBO PER SEGHE A TAZZA PER EDILIZIA

Per articolo P076-.



Art.	€	Ø	L	Filetto	Misure
P076/G12	€ 3,78	10 mm	46 mm	M12 x 1.25	16-50
P076/G16	€ 5,10	12 mm	46 mm	M16 x 1.5	55-150

P076-PX
PUNTA PILOTA PER SEGHE A TAZZA PER EDILIZIA

Per articolo P076-.



Art.	€	Ø	Lunghezza totale	Misure	Pack
P076/P12	€ 1,62	6 mm	69 mm	16-50	10
P076/P16	€ 2,16	8 mm	69 mm	55-150	10



P031-

PUNTE A TAZZA DIAMANTATE A CORONA CONTINUA

La corona diamantata a spessore sottile garantisce tagli senza sbavature. Questa caratteristica agevola i lavori di foratura su piastrelle dure in posa, dove sia necessario realizzare un foro pulito, senza scheggiare la piastrella. Invertendo periodicamente il senso di rotazione della fresa da orario ad antiorario si ravvivano i diamanti e la fresa continua a lavorare per un ciclo di vita utile più lungo.



Art.	€	Misura	Attacco esagonale	Lunghezza totale	Altezza diamante	Grana
P031/05	€ 16,20	Ø 5 mm	8.5 mm	56 mm	2 mm	50/60
P031/06	€ 16,70	Ø 6 mm	8.5 mm	56 mm	2 mm	50/60
P031/07	€ 17,90	Ø 7 mm	8.5 mm	56 mm	2 mm	50/60
P031/08	€ 18,90	Ø 8 mm	8.5 mm	56 mm	2 mm	50/60
P031/10	€ 21,60	Ø 10 mm	8.5 mm	56 mm	2 mm	50/60
P031/12	€ 22,70	Ø 12 mm	8.5 mm	56 mm	2 mm	50/60
P031/14	€ 25,80	Ø 14 mm	8.5 mm	56 mm	2 mm	50/60
P031/16	€ 31,30	Ø 16 mm	11 mm	90 mm	5 mm	35/40
P031/18	€ 32,30	Ø 18 mm	11 mm	90 mm	5 mm	35/40
P031/20	€ 36,60	Ø 20 mm	11 mm	90 mm	5 mm	35/40
P031/22	€ 39,90	Ø 22 mm	11 mm	90 mm	5 mm	35/40
P031/25	€ 45,30	Ø 25 mm	11 mm	90 mm	5 mm	35/40
P031/28	€ 48,50	Ø 28 mm	11 mm	90 mm	5 mm	35/40
P031/30	€ 54,00	Ø 30 mm	11 mm	90 mm	5 mm	35/40
P031/32	€ 58,20	Ø 32 mm	11 mm	90 mm	5 mm	35/40
P031/35	€ 62,50	Ø 35 mm	11 mm	90 mm	5 mm	35/40
P031/40	€ 71,20	Ø 40 mm	11 mm	90 mm	5 mm	35/40
P031/45	€ 79,80	Ø 45 mm	11 mm	90 mm	5 mm	35/40
P031/50	€ 89,60	Ø 50 mm	11 mm	90 mm	5 mm	35/40
P031/60	€ 111,00	Ø 60 mm	11 mm	90 mm	5 mm	35/40
P031/65	€ 121,00	Ø 65 mm	11 mm	90 mm	5 mm	35/40
P031/67	€ 130,00	Ø 67 mm	11 mm	90 mm	5 mm	35/40
P031/70	€ 143,00	Ø 70 mm	11 mm	90 mm	5 mm	35/40
P031/80	€ 164,00	Ø 80 mm	11 mm	90 mm	5 mm	35/40

P031/06P

€ 2,96

PUNTA PILOTA

Per articolo P031-



Append.



Diametro	Ø 6 mm
Lunghezza	100 mm
Gambo	Ø 5 mm
Pack	10

P031/03S

€ 54,00

SERIE PUNTE E TAZZE DIAMANTATE A CORONA CONTINUA

La corona diamantata a spessore sottile garantisce tagli senza sbavature. Questa caratteristica agevola i lavori di foratura su piastrelle dure in posa, dove sia necessario realizzare un foro pulito, senza scheggiare la piastrella. Invertendo periodicamente il senso di rotazione della fresa da orario ad antiorario si ravvivano i diamanti e la fresa continua a lavorare per un ciclo di vita utile più lungo.



Misure	Ø 6 mm - 8 mm - 10 mm
Attacco esagonale	9.5 mm
Lunghezza totale	56 mm
Altezza diamante	2 mm
Grana	50/60



P031/05S

€ 86,30

SERIE PUNTE E TAZZE DIAMANTATE A CORONA CONTINUA

La corona diamantata a spessore sottile garantisce tagli senza sbavature. Questa caratteristica agevola i lavori di foratura su piastrelle dure in posa, dove sia necessario realizzare un foro pulito, senza scheggiare la piastrella. Invertendo periodicamente il senso di rotazione della fresa da orario ad antiorario si ravvivano i diamanti e la fresa continua a lavorare per un ciclo di vita utile più lungo.



Misure	Ø 5 mm - 6 mm - 8 mm - 10 mm - 12 mm
Attacco esagonale	8.5 mm
Lunghezza totale	56 mm
Altezza diamante	2 mm
Grana	50/60



P031/06S

€ 258,00

SERIE PUNTE E TAZZE DIAMANTATE A CORONA CONTINUA

La corona diamantata a spessore sottile garantisce tagli senza sbavature. Questa caratteristica agevola i lavori di foratura su piastrelle dure in posa, dove sia necessario realizzare un foro pulito, senza scheggiare la piastrella. Invertendo periodicamente il senso di rotazione della fresa da orario ad antiorario si ravvivano i diamanti e la fresa continua a lavorare per un ciclo di vita utile più lungo.



Misure	Ø 16 mm - 22 mm - 25 mm - 28 mm - 30 mm - 35 mm
Attacco esagonale	11 mm
Lunghezza totale	90 mm
Altezza diamante	5 mm
Grana	50/60



P033-
PUNTE DIAMANTATE A CORONA CONTINUA

Funzionamento ottimale su pareti verticali, non asportare la carota, che funge da tappo-dosatore per il refrigerante. L'utilizzo con refrigerazione ad acqua allunga la vita utile dell'utensile. La corona diamantata a spessore sottile garantisce tagli senza sbavature. Questa caratteristica agevola i lavori di foratura su piastrelle dure in posa, dove sia necessario realizzare un foro pulito.

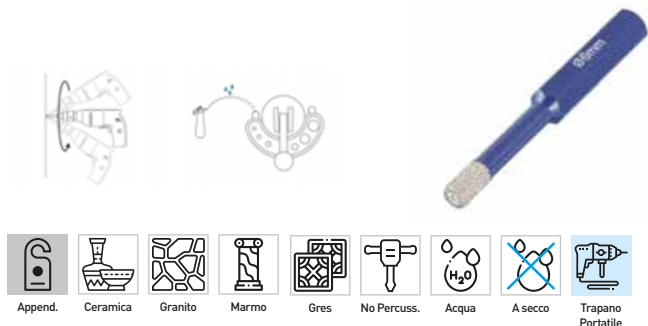

Art.	€	Misura	Attacco esagonale	Lunghezza totale	Altezza diamante	Grana
P033/05	€ 26,90	Ø 5 mm	9.5 mm	80 mm	10 mm	40
P033/06	€ 26,90	Ø 6 mm	9.5 mm	80 mm	10 mm	40
P033/08	€ 26,90	Ø 8 mm	9.5 mm	80 mm	10 mm	40
P033/10	€ 29,10	Ø 10 mm	9.5 mm	80 mm	10 mm	40
P033/12	€ 32,30	Ø 12 mm	9.5 mm	80 mm	10 mm	40
P033/14	€ 34,50	Ø 14 mm	12.5 mm	80 mm	10 mm	40
P033/16	€ 39,90	Ø 16 mm	12.5 mm	80 mm	10 mm	40
P033/18	€ 45,30	Ø 18 mm	12.5 mm	80 mm	10 mm	40
P033/20	€ 50,70	Ø 20 mm	12.5 mm	80 mm	10 mm	40
P033/22	€ 55,00	Ø 22 mm	12.5 mm	80 mm	10 mm	40
P033/25	€ 62,50	Ø 25 mm	12.5 mm	80 mm	10 mm	40

P034-
PUNTE E TAZZE DIAMANTATE M14 A CORONA CONTINUA

La corona diamantata a spessore sottile garantisce tagli senza sbavature. Questa caratteristica agevola i lavori di foratura su piastrelle dure in posa, dove sia necessario realizzare un foro pulito, senza scheggiare la piastrella. Invertendo periodicamente il senso di rotazione della fresa da orario ad antiorario si ravvivano i diamanti e la fresa continua a lavorare per un ciclo di vita utile più lungo.

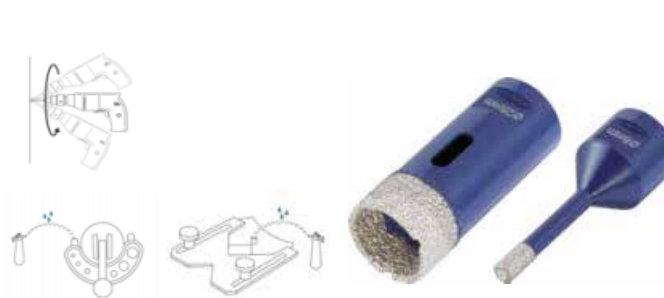

Art.	€	Misura	Lunghezza totale	Altezza diamante	Grana
P034/006	€ 31,80	Ø 6 mm	62 mm	10 mm	30/50
P034/008	€ 32,30	Ø 8 mm	62 mm	10 mm	30/50
P034/010	€ 32,30	Ø 10 mm	62 mm	10 mm	30/50
P034/012	€ 34,50	Ø 12 mm	62 mm	10 mm	30/50
P034/014	€ 37,80	Ø 14 mm	62 mm	10 mm	30/50
P034/016	€ 38,30	Ø 16 mm	62 mm	15 mm	30/50
P034/018	€ 38,90	Ø 18 mm	62 mm	15 mm	30/50
P034/020	€ 39,40	Ø 20 mm	60 mm	15 mm	30/50
P034/022	€ 39,90	Ø 22 mm	60 mm	15 mm	30/50
P034/025	€ 40,50	Ø 25 mm	60 mm	10 mm	30/50
P034/028	€ 44,20	Ø 28 mm	60 mm	15 mm	30/50
P034/030	€ 47,50	Ø 30 mm	60 mm	15 mm	30/50
P034/032	€ 50,70	Ø 32 mm	60 mm	15 mm	30/50
P034/035	€ 55,00	Ø 35 mm	60 mm	15 mm	30/50
P034/040	€ 63,60	Ø 40 mm	60 mm	15 mm	30/50
P034/045	€ 71,20	Ø 45 mm	60 mm	15 mm	30/50
P034/050	€ 76,50	Ø 50 mm	60 mm	15 mm	30/50
P034/055	€ 86,30	Ø 55 mm	60 mm	15 mm	30/50
P034/060	€ 94,80	Ø 60 mm	60 mm	15 mm	30/50
P034/065	€ 102,00	Ø 65 mm	60 mm	15 mm	30/50
P034/067	€ 106,00	Ø 67 mm	60 mm	15 mm	30/50
P034/070	€ 111,00	Ø 70 mm	60 mm	15 mm	30/50
P034/080	€ 126,00	Ø 80 mm	60 mm	15 mm	30/50
P034/090	€ 139,00	Ø 90 mm	60 mm	15 mm	30/50
P034/100	€ 171,00	Ø 100 mm	60 mm	15 mm	30/50

P033/03S
€ 75,40
SERIE PUNTE E TAZZE DIAMANTATE A CORONA CONTINUA

Funzionamento ottimale su pareti verticali, non asportare la carota, che funge da tappo-dosatore per il refrigerante. L'utilizzo con refrigerazione ad acqua allunga la vita utile dell'utensile. La corona diamantata a spessore sottile garantisce tagli senza sbavature. Questa caratteristica agevola i lavori di foratura su piastrelle dure in posa, dove sia necessario realizzare un foro pulito.

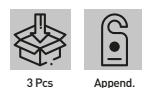

Misure	Ø 6 mm - 8 mm - 10 mm
Attacco esagonale	9.5 mm
Lunghezza totale	80 mm
Altezza diamante	10 mm
Grana	40

P034/05S
€ 162,00
SERIE PUNTE E TAZZE DIAMANTATE M14 A CORONA CONTINUA

La corona diamantata a spessore sottile garantisce tagli senza sbavature. Questa caratteristica agevola i lavori di foratura su piastrelle dure in posa, dove sia necessario realizzare un foro pulito, senza scheggiare la piastrella. Invertendo periodicamente il senso di rotazione della fresa da orario ad antiorario si ravvivano i diamanti e la fresa continua a lavorare per un ciclo di vita utile più lungo.



Misure	Ø 6 mm - 8 mm - 10 mm - 12 mm - 14 mm
Lunghezza totale	62 mm
Altezza diamante	10 mm
Grana	30/50

P034/06S
€ 402,00
SERIE PUNTE E TAZZE DIAMANTATE M14 A CORONA CONTINUA

La corona diamantata a spessore sottile garantisce tagli senza sbavature. Questa caratteristica agevola i lavori di foratura su piastrelle dure in posa, dove sia necessario realizzare un foro pulito, senza scheggiare la piastrella invertendo periodicamente il senso di rotazione della fresa da orario ad antiorario si ravvivano i diamanti e la fresa continua a lavorare per un ciclo di vita utile più lungo.



Misure	Ø 22 mm - 35 mm - 40 mm - 45 mm - 50 mm - 67 mm
Lunghezza totale	60 mm
Altezza diamante	15 mm
Grana	30/50



P035-

PUNTE DIAMANTATE A CORONA CONTINUA

La corona diamantata a spessore sottile garantisce tagli senza sbavature. Questa caratteristica agevola i lavori di foratura su piastrelle dure in posa, dove sia necessario realizzare un foro pulito, senza scheggiare la piastrella. Invertendo periodicamente il senso di rotazione della fresa da orario ad antiorario si rinvivano i diamanti e la fresa continua a lavorare per un ciclo di vita utile più lungo.



Art.	€	Misura	Gambo	Lunghezza totale	Altezza diamante	Grana
P035/05	€ 8,70	Ø 5 mm	Ø 6 mm	65 mm	5 mm	60/80
P035/06	€ 8,70	Ø 6 mm	Ø 6 mm	65 mm	5 mm	60/80
P035/08	€ 8,70	Ø 8 mm	Ø 6 mm	65 mm	5 mm	60/80
P035/10	€ 8,70	Ø 10 mm	Ø 6 mm	65 mm	5 mm	60/80
P035/12	€ 9,70	Ø 12 mm	Ø 6 mm	65 mm	5 mm	60/80
P035/14	€ 10,70	Ø 14 mm	Ø 6 mm	65 mm	5 mm	60/80

D009/5-12

€ 30,10

DIMA A VENTOSA CON FORI DI GUIDA

Consente un'agevole centratura e sicurezza di taglio della punta diamantata nei vari materiali lavorabili. Da utilizzare in accoppiata con nebulizzatore per lavorazioni ad acqua.



Scatola

Fori 4 mm - 5 mm - 6 mm - 7 mm - 8 mm - 10 mm - 12 mm

D020

€ 27,60

SERIE FRESE ROTATIVE DIAMANTATE

Adatte per incisioni, scritte o rifiniture grazie alle varie geometrie disponibili.



20 Pcs

Scatola

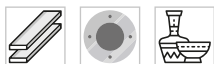

Acciaio

Inox

Ceramica

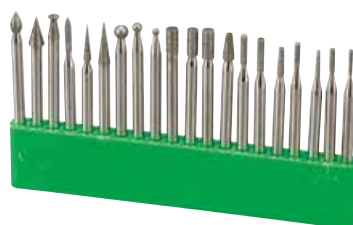

Gambo Ø 3 mm
Lunghezza 45 mm

P035/04S

€ 32,30

SERIE PUNTE DIAMANTATE A CORONA CONTINUA

La corona diamantata a spessore sottile garantisce tagli senza sbavature. Questa caratteristica agevola i lavori di foratura su piastrelle dure in posa, dove sia necessario realizzare un foro pulito, senza scheggiare la piastrella. Invertendo periodicamente il senso di rotazione della fresa da orario ad antiorario si rinvivano i diamanti e la fresa continua a lavorare per un ciclo di vita utile più lungo.



4 Pcs



Append.

Misure	Ø 5 mm - 6 mm - 8 mm - 10 mm
Gambo	Ø 6 mm
Lunghezza totale	65 mm
Altezza diamante	5 mm
Grana	60/80

0529

€ 41,10

SERIE PUNTE DIAMANTATE

La corona diamantata a spessore sottile garantisce tagli senza sbavature. Questa caratteristica agevola i lavori di foratura su piastrelle dure in posa, dove sia necessario realizzare un foro pulito, senza scheggiare la piastrella. Invertendo periodicamente il senso di rotazione della fresa da orario ad antiorario si rinvivano i diamanti e la fresa continua a lavorare per un ciclo di vita utile più lungo.



6 Pcs



Append.

Punte	Ø 5 - 6 - 8 - 10 - 12 mm
Lunghezza totale	60 mm
Taglio utile	30 mm
Altezza diamante	3 mm
Grana	70/80

D009/5-85

€ 45,30

DIMA REGOLABILE A VENTOSA

Consente un'agevole centratura e sicurezza di taglio della punta diamantata nei vari materiali lavorabili. Da utilizzare in accoppiata con nebulizzatore per lavorazioni ad acqua.



Scatola

Fori 5 - 85 mm

D050

€ 54,20

SERIE FRESE ROTATIVE DIAMANTATE

Adatte per incisioni, scritte o rifiniture grazie alle varie geometrie disponibili.



50 Pcs

Scatola



Acciaio

Inox

Ceramica



Gambo Ø 3 mm
Lunghezza 45 mm

P052-
PUNTE ELICOIDALI PER LEGNO

A doppia elica, con punta di centraggio consente un posizionamento esatto del foro.



Art.	€	Ø	Lunghezza totale	Lunghezza elica	Pack
P052/03	€ 0,92	3 mm	61 mm	33 mm	5
P052/04	€ 1,02	4 mm	75 mm	43 mm	5
P052/05	€ 1,23	5 mm	86 mm	52 mm	5
P052/06	€ 1,33	6 mm	93 mm	57 mm	5
P052/07	€ 1,64	7 mm	109 mm	69 mm	5
P052/08	€ 2,15	8 mm	117 mm	75 mm	5
P052/09	€ 2,46	9 mm	125 mm	81 mm	1
P052/10	€ 2,88	10 mm	133 mm	87 mm	1
P052/11	€ 3,79	11 mm	142 mm	94 mm	1
P052/12	€ 4,71	12 mm	151 mm	101 mm	1
P052/13	€ 5,50	13 mm	151 mm	101 mm	1
P052/14	€ 6,70	14 mm	160 mm	108 mm	1
P052/15	€ 8,00	15 mm	169 mm	114 mm	1
P052/16	€ 11,10	16 mm	178 mm	120 mm	1
P052/17	€ 12,80	17 mm	184 mm	125 mm	1
P052/18	€ 14,90	18 mm	191 mm	130 mm	1
P052/19	€ 16,90	19 mm	198 mm	135 mm	1
P052/20	€ 18,50	20 mm	205 mm	140 mm	1

P052/08S
€ 14,30
SERIE DI PUNTE ELICOIDALI PER LEGNO

A doppia elica, con punta di centraggio consente un posizionamento esatto del foro.

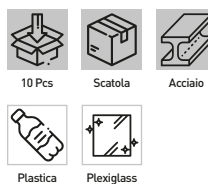

Misura 3 ÷ 10 mm

0238
€ 12,70
SERIE SEGHE A TAZZA PER LEGNO

Misure Ø 22 - 29 - 32 - 38 - 44 - 51 - 57 - 67 mm

0463
€ 22,90
SERIE PUNTE CON SVASATORE PER LEGNO

Per svasare il legno.

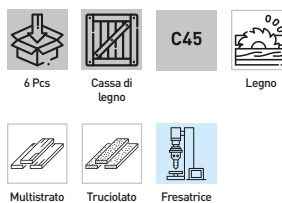

Misure 2 - 2,5 - 3 - 3,5 mm

0799-
SERIE PUNTE PER MORTASA

Art.	€	Misure	Rotazione	Gambo
0799/SXC	€ 71,40	Ø 6 - 8 - 10 - 12 - 14 - 16 mm	Sx	Ø 16 x 50 mm
0799/DXC	€ 71,40	Ø 6 - 8 - 10 - 12 - 14 - 16 mm	Dx	Ø 16 x 50 mm

0087
€ 46,10
SERIE PUNTE PER CERNIERE CON RIPOSTO IN METALLO DURO

Punta Ø 15 - 20 - 26 - 30 - 35 mm

0087/35
€ 11,70
PUNTA PER CERNIERE CON RIPOSTO IN METALLO DURO

 Punta Ø 35 mm
 Gambo Ø 8 mm



0526 € 32,80

SERIE PUNTE CON SVASATORE PER LEGNO

Attacco da 1/4" e svasatore per legno, per forare e svasare il legno senza rovinarlo.

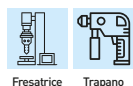

Punte 2,75 - 3,25 - 3,5 mm
Attacco 1/4"

0524 € 53,30

SERIE PORTA PUNTE CON ATTACCO 1/4"

Per velocizzare il lavoro sostituendo velocemente le punte.

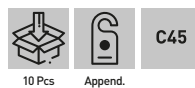

Misure 3-3.5-4-4.5-5-5.5-6-6.5-8-10 mm
Attacco 1/4"

0835/15 € 56,30

SERIE FRESE PER LEGNO

Per la lavorazione professionale del legno quali bordi, rifiniture, scanalature.



Gambo Ø 6 mm

0830 € 244,00

SERIE FRESE PER LEGNO

Per la lavorazione professionale del legno quali bordi, rifiniture, scanalature.



Gambo Ø 6 mm



M015S

€ 58,20

SERIE MASCHI E PUNTE

Con giramaschi.



Maschi M3x0,50 - M4x0,70 - M5x0,80 - M6x1,00 - M8x1,20 - M10x1,50 - M12x1,75
Punte Ø2.5 - Ø3.3 - Ø4.2 - Ø5.0 - Ø6.8 - Ø8.5 - Ø10.2

M312/P

€ 63,60

SERIE MASCHI PER FORI PASSANTI GAMBO RINFORZATO

Con giramaschi.



Misura M3 x 0,50 - M4 x 0,70 - M5 x 0,80 - M6 x 1 - M8 x 1,25 - M10 x 1,50 - M12 x 1,75

M312/C

€ 69,20

SERIE MASCHI PER FORI CIECHI 35° GAMBO RINFORZATO

Con giramaschi.



Misura M3 x 0,50 - M4 x 0,70 - M5 x 0,80 - M6 x 1 - M8 x 1,25 - M10 x 1,50 - M12 x 1,75

M020

€ 32,10

SERIE MASCHI E FILIERE

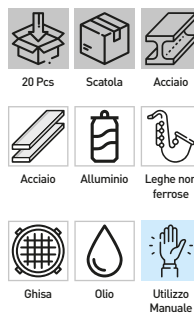

Giramaschio M3 - M12
Girafiliera 25 x 9 mm
Maschi M3x0,5 - M4x0,7 - M5x0,8 - M6x1 - M7x1 - M8x1,25 - M10x1,5 - M12x1,75 - 1/8" NPT27
Filiera M3x0,5 - M4x0,7 - M5x0,8 - M6x1 - M7x1 - M8x1,25 - M10x1,5 - M12x1,75 - 1/8" NPT27

M036

€ 62,40

SERIE MASCHI E FILIERE

Con punte e contafiletti.



Giramaschio M3 - M12
Girafiliera 25 x 9 mm
Maschi M3x0,5 - M4x0,7 - M5x0,8 - M6x1 - M7x1 - M8x1,25 - M10x1,5 - M12
Filiera M3x0,5 - M4x0,7 - M5x0,8 - M6x1 - M7x1 - M8x1,25 - M10x1,5 - M12
Punte 2,5 - 3,3 - 4,2 - 5 - 6 - 6,8 - 8,5 - 10,3 mm
Giravite 6,5 x 50 mm

M032

€ 116,00

SERIE MASCHI E FILIERE

Con giramaschi, girafiliera e contafiletti.

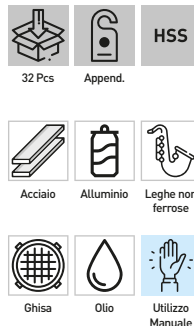

Maschi M3x0,5 M4x0,7 M5x0,8 M6x1 M8x1,25 M10x1,5 M12x1,75
Filiera M3x0,5 M4x0,7 M5x0,8 M6x1 M8x1,25 M10x1,5 M12x1,75
Giravite 3,5 x 50 mm



M029

€ 124,00

SERIE MASCHI E FILIERE

Con punte, giramaschi e girafilieri a cricchetto.

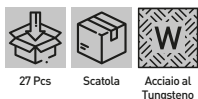

Manico a cricchetto	200 mm
Adattatore	Maschi 5 - 7,5 mm Filiere 25 x 9 mm
Maschi	M3x0,5 - M4x0,7 - M5x0,8 - M6x1 - M8x1,25 - M10x1,5 - M12x1,75
Filieri	M3x0,5 - M4x0,7 - M5x0,8 - M6x1 - M8x1,25 - M10x1,5 - M12x1,75
Punte	2,5 - 3,3 - 4,2 - 5 - 6,8 - 8,5 - 10,3 mm
Giravite	6,5 x 50 mm
Giravite	3 x 50 mm

M101

€ 114,00

SERIE MASCHI E FILIERE

Maschio a mano e filiera: Metric M3x0,5 - UNC 1/4 20 - UNF 4 40 - Metric M4x0,7 - UNC 1/4 28 - UNF 6 32 - Metric M5x0,8 - UNC 5/16 18 - UNF 8 32 - Metric M6x1 - UNC 5/16 24 - UNF 10 32 - Metric M7x1 - UNC 3/8 16 - UNF 10 24 - Metric M8x1,25 - UNC 3/8 24 - UNF 12 24 - Metric M9x1,25 - UNC 7/16 14 - Metric M10x1,5 - UNC 7/16 20 - Metric M10x1 - UNC 1/2 13 - Metric M12x1,75 - UNC 1/2 20 - NPT 1/8 27. Completo di giramaschi e girafilieri.



M030

€ 72,60

SERIE MASCHI E FILIERE

Da M1 a M2.5, con girafilieri e addattatori per convertirlo in giramaschi.



Misura M1 - M1.1 - M1.2 - M1.4 - M1.6 - M1.8 - M2.0 - M2.2 - M2.5

M100

€ 153,00

SERIE MASCHI E FILIERE

Con giramaschi e girafilieri. M6x0,75 - M6x1 - M8x1 - M8x1,25 - M10x1,25 - M10x1,5 - M12x1,5 - M12x1,75 - M14x1,5 - M14x2 - M16x1,5 - M16x2 - M18x1,5 - M18x2,5 - M20x1,5 - M20x2,5 - M22x1,5 - M22x2,5 x M24x1,5 - M24x3.



M218

€ 247,00

SERIE MASCHI E FILIERE

Maschi a mano serie 2pz e filiera: M2 x 0,40 - M3 x 0,50 - M4 x 0,70 - M5 x 0,80 - M6 x 0,75 - M6 x 1 - M7 x 0,75 - M7 x 1 - M8 x 0,75 - M8 x 1 - M8 x 1,25 - M9 x 0,75 - M9 x 1 - M9 x 1,25 - M10 x 0,75 - M10 x 1 - M10 x 1,25 - M10 x 1,5 - M11 x 0,75 - M11 x 1 - M11 x 1,25 - M11 x 1,5 - M12 x 0,75 - M12 x 1 - M12 x 1,25 - M12 x 1,5 - M12 x 1,75 - M14 x 1 - M14 x 1,25 - M14 x 1,5 - M14 x 2 - M16 x 1 - M16 x 1,5 - M16 x 2 - M18 x 1,5. Completo di 2 giramaschi e 2 girafilieri.



MASCHIATURA

TIPOLOGIA DI SCALANATURE

SCALANATURE DRITTE IMBOCCO CORRETTO

La correzione dell'imbocco è data da una forte inclinazione dell'elica combinata a un accentuato angolo di taglio nella parte iniziale del maschio. Questa esecuzione assicura l'evacuazione dei trucioli in direzione dell'avanzamento. Pertanto nelle maschiature di fori passanti su materiali che producono truciolo continuo, sono pressochè eliminati i rischi di intasamento e rottura.



SCALANATURE ELICOIDALI A FORTE TORSIONE 35°

Le scalanature elicoidali inclinate favoriscono l'estrazione del truciolo in direzione opposta all'avanzamento del maschio. La forte inclinazione dell'elica inoltre assicura l'estrazione del truciolo da fori ciechi e profondi riducendo i rischi di intasamento e rottura.



SCelta DELLE VELOCITÀ DI TAGLIO TEORICHE DEI MASCHI A MACCHINA, IN FUNZIONE DEL MATERIALE DA FILETTARE

Materiale da lavorare	Velocità di taglio (m/min)	Refrigerante
Acciaio da costruzione basso legato R< 700÷900N/mm2	10 - 20	Olio
Acciaio per utensili	4 - 8	Olio
Acciaio legato R<1100÷1300N/mm2	2 - 5	Olio
Acciaio Inox	5 - 10	Olio
Ghisa Sferoidale	6 - 20	No lubrif.
Leghe di Rame	10 - 15	Olio
Ottone	20 - 30	Olio
Bronzo	6 - 15	Olio
Alluminio truciolo corto	15 - 30	Olio
Alluminio truciolo lungo	10 - 20	Olio
Titanio	3 - 4	Olio
Plastica e materiali termoplastici	5 - 15	Acqua
Materiali termoindurenti	5 - 10	No lubrif.





M001-X

MASCHI A MACCHINA PER FORI PASSANTI, IMBOCCO CORRETTO

Filettatura metrica a passo grosso (MA) - gambo rinforzato.



- Scatola
- HSS-G
- DIN 371/B
- HV=750
- Esterna
- Re700N/mm²
- Acciaio
- Alluminio
- Leghe non ferrose
- Ghisa
- Olio
- Tornio

Art.	€	B	L2	L1	D2	C
M001/3	€ 6,10	M3 x 0,50	13 mm	56 mm	3.5 mm	2.7 mm
M001/4	€ 6,10	M4 x 0,70	13 mm	66 mm	4.5 mm	3.4 mm
M001/5	€ 7,50	M5 x 0,80	16 mm	70 mm	6 mm	4.9 mm
M001/6	€ 8,00	M6 x 1	22 mm	85 mm	6 mm	4.9 mm
M001/8	€ 9,80	M8 x 1,25	22 mm	90 mm	8 mm	6.2 mm
M001/10	€ 12,50	M10 x 1,5	24 mm	100 mm	10 mm	8 mm

M001-XV

MASCHI A MACCHINA PER FORI PASSANTI, IMBOCCO CORRETTO

Filettatura metrica a passo grosso (MA) - gambo rinforzato, il trattamento di vaporizzazione aumenta la durezza superficiale e la resistenza a usura riducendo la possibilità d'incollamento dei trucioli.



- Scatola
- HSS-G
- Vaporizzato
- DIN 371/B
- HV=750
- Esterna
- Re700N/mm²
- Acciaio
- Alluminio
- Leghe non ferrose
- Ghisa
- Olio

Art.	€	B	L2	L1	D2	C
M001/03V	€ 7,70	M3 x 0,50	11 mm	56 mm	3.5 mm	2.7 mm
M001/04V	€ 7,70	M4 x 0,70	13 mm	63 mm	4.5 mm	3.4 mm
M001/05V	€ 8,50	M5 x 0,80	16 mm	70 mm	6 mm	4.9 mm
M001/06V	€ 9,20	M6 x 1	19 mm	80 mm	6 mm	4.9 mm
M001/08V	€ 11,70	M8 x 1,25	22 mm	90 mm	8 mm	6.2 mm
M001/10V	€ 14,60	M10 x 1,5	24 mm	100 mm	10 mm	8 mm

M002-

MASCHI A MACCHINA PER FORI PASSANTI IMBOCCO CORRETTO

Filettatura metrica a passo grosso (MA).



- Scatola
- HSS-G
- DIN 376/B
- HV=750
- Esterna
- Re700N/mm²
- Acciaio
- Alluminio
- Leghe non ferrose
- Ghisa
- Olio
- Tornio

Art.	€	B	L2	L1	D2	C
M002/12	€ 13,50	M12 x 1,75	29 mm	110 mm	9 mm	7 mm
M002/14	€ 17,50	M14 x 2	30 mm	110 mm	11 mm	9 mm
M002/16	€ 19,50	M16 x 2	32 mm	110 mm	12 mm	9 mm
M002/18	€ 30,20	M18 x 2,5	34 mm	125 mm	14 mm	11 mm
M002/20	€ 35,90	M20 x 2,5	34 mm	140 mm	16 mm	12 mm
M002/22	€ 50,30	M22 x 2,5	34 mm	140 mm	18 mm	14.5 mm
M002/24	€ 55,20	M24 x 3	38 mm	160 mm	18 mm	14.5 mm
M002/27	€ 77,30	M27 x 3	38 mm	160 mm	20 mm	16 mm
M002/30	€ 89,60	M30 x 3,5	45 mm	180 mm	22 mm	18 mm

M002-XV

MASCHI A MACCHINA PER FORI PASSANTI IMBOCCO CORRETTO

Filettatura metrica a passo grosso (MA) - gambo rinforzato, il trattamento di vaporizzazione aumenta la durezza superficiale e la resistenza a usura riducendo la possibilità d'incollamento dei trucioli.



- Scatola
- HSS-G
- Vaporizzato
- DIN 376/B
- HV=750
- Esterna
- Re700N/mm²
- Acciaio
- Alluminio
- Leghe non ferrose
- Ghisa
- Olio

Art.	€	B	L2	L1	D2	C
M002/12V	€ 15,20	M12 x 1,75	29 mm	110 mm	9 mm	7 mm
M002/14V	€ 20,10	M14 x 2	30 mm	110 mm	11 mm	9 mm
M002/16V	€ 22,90	M16 x 2	32 mm	110 mm	12 mm	9 mm
M002/18V	€ 32,30	M18 x 2,5	34 mm	125 mm	14 mm	11 mm
M002/20V	€ 40,70	M20 x 2,5	34 mm	140 mm	16 mm	12 mm

M003-
MASCHI A MACCHINA PER FORI CIECHI A FORTE TORSIONE 35°

Filettatura metrica a passo grosso (ma) - gambo rinforzato.



	HSS-G					
Scatola		371/C				
HV=750	Esterna	R<700N/mm²				
Acciaio	Alluminio	Leghe non ferrose				
Ghisa	Olio	Tornio				

Art.	€	B	L2	L1	D2	C
M003/3	€ 6,10	M3 x 0,50	11 mm	59 mm	3.5 mm	2.7 mm
M003/4	€ 6,10	M4 x 0,70	13 mm	63 mm	4.5 mm	3.4 mm
M003/5	€ 6,80	M5 x 0,80	18 mm	74 mm	6 mm	4.9 mm
M003/6	€ 8,50	M6 x 1	22 mm	80 mm	6 mm	4.9 mm
M003/8	€ 10,40	M8 x 1,25	22 mm	90 mm	8 mm	6.2 mm
M003/10	€ 12,80	M10 x 1,5	24 mm	100 mm	10 mm	8 mm

M003-XV
MASCHI A MACCHINA PER FORI CIECHI A FORTE TORSIONE 35°

Filettatura metrica a passo grosso (ma) - gambo rinforzato, il trattamento di vaporizzazione aumenta la durezza superficiale e la resistenza a usura riducendo la possibilità d'incollamento dei trucioli.



	HSS-G	V				
Scatola		Vaporizzato				
371/C	HV=750	Esterna				
R<700N/mm²	Acciaio	Alluminio				
Leghe non ferrose	Ghisa	Olio				

Art.	€	B	L2	L1	D2	C
M003/03V	€ 7,70	M3 x 0,50	11 mm	56 mm	3.5 mm	2.7 mm
M003/04V	€ 7,70	M4 x 0,70	13 mm	63 mm	4.5 mm	3.4 mm
M003/05V	€ 9,10	M5 x 0,80	16 mm	75 mm	6 mm	4.9 mm
M003/06V	€ 10,40	M6 x 1	22 mm	86 mm	6 mm	4.9 mm
M003/08V	€ 12,00	M8 x 1,25	22 mm	90 mm	8 mm	6.2 mm
M003/10V	€ 15,00	M10 x 1,5	24 mm	100 mm	10 mm	8 mm

M003-XXX
MASCHI A MACCHINA PER FORI CIECHI A FORTE TORSIONE 35°

Filettatura metrica a passo grosso (ma).



	HSS-G					
Scatola		376/C				
HV=750	Esterna	R<700N/mm²				
Acciaio	Alluminio	Leghe non ferrose				
Ghisa	Olio	Tornio				

Art.	€	B	L2	L1	D2	C
M003/12	€ 14,00	M12 x 1,75	29 mm	110 mm	9 mm	7 mm
M003/14	€ 17,70	M14 x 2	30 mm	110 mm	11 mm	9 mm
M003/16	€ 20,40	M16x2	32 mm	110 mm	12 mm	9 mm
M003/18	€ 33,20	M18 x 2,5	34 mm	125 mm	14 mm	11 mm
M003/20	€ 36,40	M20 x 2,5	34 mm	140 mm	16 mm	12 mm
M003/22	€ 50,30	M22 x 2,5	34 mm	140 mm	18 mm	14.5 mm
M003/24	€ 55,10	M24 x 3	38 mm	160 mm	18 mm	14.5 mm
M003/27	€ 77,30	M27 x 3	38 mm	160 mm	20 mm	16 mm
M003/30	€ 89,60	M30 x 3,5	45 mm	180 mm	22 mm	18 mm

M003-XXV
MASCHI A MACCHINA PER FORI CIECHI A FORTE TORSIONE 35°

Filettatura metrica a passo grosso (MA) - gambo rinforzato, il trattamento di vaporizzazione aumenta la durezza superficiale e la resistenza a usura riducendo la possibilità d'incollamento dei trucioli.



	HSS-G	V				
Scatola		Vaporizzato				
376/C	HV=750	Esterna				
R<700N/mm²	Acciaio	Alluminio				
Leghe non ferrose	Ghisa	Olio				

Art.	€	B	L2	L1	D2	C
M003/12V	€ 17,70	M12 x 1,75	29 mm	110 mm	9 mm	7 mm
M003/14V	€ 20,10	M14 x 2	30 mm	110 mm	11 mm	9 mm
M003/16V	€ 23,80	M16 x 2	32 mm	110 mm	12 mm	9 mm
M003/18V	€ 32,30	M18 x 2,5	34 mm	125 mm	14 mm	11 mm
M003/20V	€ 40,70	M20 x 2,5	34 mm	140 mm	16 mm	12 mm



0890-

UTENSILE 3 IN 1, PUNTA-MASCHIO-SVASATORE

Grazie alla particolare geometria in un'unica operazione è in grado di forare, filettare e svasare.

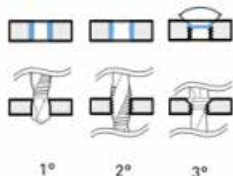

Art.	€	Maschi	Attacco	Dimensioni
0890/M3	€ 7,00	M3 x 0,5	1/4"	52 mm
0890/M4	€ 7,00	M4 x 0,7	1/4"	52 mm
0890/M5	€ 8,00	M5 x 0,8	1/4"	54 mm
0890/M6	€ 8,00	M6 x 1	1/4"	56 mm
0890/M8	€ 9,20	M8 x 1,25	1/4"	58 mm
0890/M10	€ 11,30	M10 x 1,5	1/4"	60 mm

0897-

NEW

UTENSILE FRANTUMA MASCHI IN METALLO DURO

Per togliere maschi spezzati all'interno di fori. Codolo cilindrico con esagono per l'alloggiamento nel mandrino, e tagliente autocentrante.

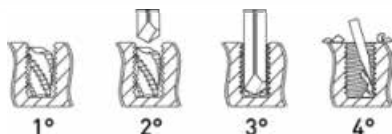

Art.	€	L	l	Maschi	Gambo
0897/M3	€ 13,60	38 mm	10 mm	M3	3 mm
0897/M4	€ 20,50	46 mm	15 mm	M4	4 mm
0897/M5	€ 27,00	50 mm	19 mm	M5	5 mm
0897/M6	€ 35,00	50 mm	23 mm	M6	6 mm
0897/M8	€ 50,00	60 mm	23 mm	M8	7 mm
0897/M10	€ 73,00	100 mm	25 mm	M10	9 mm
0897/M12	€ 83,00	100 mm	35 mm	M12	12 mm

G003-

NEW

GIRAMASCHI A CRICCHETTO

A funzionamento destrorso, sinistrorso o in posizione fissa. Dotato di livella sulla testa per facilitare il corretto allineamento del maschio con l'imbocco del foro.



Art.	€	Lunghezza	Maschi	Quadro
G003/1	€ 12,50	85 mm	M3 ÷ M8	1,75 ÷ 5,5 mm
G003/2	€ 15,20	100 mm	M5 ÷ M12	4 ÷ 8 mm
G003/3	€ 18,50	250 mm	M3 ÷ M8	2,7 ÷ 5 mm
G003/4	€ 21,00	300 mm	M5 ÷ M12	4,9 ÷ 8 mm

0890

€ 55,80

UTENSILI 3 IN 1, PUNTA-MASCHIO-SVASATORE E SERIE INSERTI

Grazie alla particolare geometria in un'unica operazione è in grado di forare, filettare e svasare. Con porta inserti a cambio rapido.



Maschi	M3 x 0,5 - M4 x 0,7 - M5 x 0,8 - M6 x 1 - M8 x 1,25 - M10 x 1,5
Attacco	1/4"
Phillips	1 - 2
Pozi-driv	1 - 2
Taglio	4 - 5 mm

G002-

GIRAMASCHI REGOLABILI

Con ganasce temprate, un'impugnatura svitabile per eseguire lavori con ingombri stretti.



Art.	€	Maschi	Quadro
G002/1	€ 6,80	M1 ÷ M10	1,75 ÷ 5,5
G002/2	€ 10,10	M4 ÷ M12	2,4 ÷ 8 mm
G002/3	€ 14,00	M5 ÷ M20	2,7 ÷ 12

G011-

NEW

GIRAMASCHI CON ATTACCO MANDRINO PER CENTRAGGIO

Dotato di perno guida di centraggio, che permette di fissare su mandrini di macchine utensili per poter mantenere la rettilineità del maschio rispetto al preforo precedentemente eseguito.

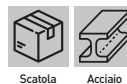

Art.	€	Maschi	Quadro	Attacco cilindrico
G011/1	€ 15,00	M2 ÷ M6	3 ÷ 5 mm	Ø6,25 mm
G011/2	€ 18,00	M6 ÷ M12	5 ÷ 12 mm	Ø7,60 mm

F123
€ 51,00
SERIE FILIERE

Da M3 a M12, completo di girafiliera.



Misura	M3 - M4 - M5 - M6 - M8 - M10 - M12
Girafiliera	25 x 9 mm

G001-
GIRAFILIERA

Con 3 viti di fissaggio filiera, 1 impugnatura svitabile per eseguire lavori con ingombri stretti.



Art.	€	Dimensioni filiera	Per filiera
G001/20	€ 6,80	20 x 7 mm	M4,5 ÷ M6
G001/25	€ 6,80	25 x 9 mm	M7 ÷ M9
G001/30	€ 8,40	30 x 11 mm	M10 ÷ M11
G001/38	€ 12,80	38 x 14 mm	M12 ÷ M14
G001/45	€ 14,60	45 x 18 mm	M16 ÷ M20
G001/55	€ 15,80	55 x 22 mm	M22 ÷ M24

F121-
FILIERA METRICA PER FILETTATURA A PASSO GROSSO

Con imbocco corretto su entrambi i lati per agevolare l'esecuzione del filetto ed evacuare correttamente i trucioli nella direzione di taglio.



Art.	€	Passo	Dimensioni
F121/03	€ 8,40	3 x 0,5 mm	Ø20 x 5 mm
F121/04	€ 8,40	4 x 0,7 mm	Ø20 x 5 mm
F121/05	€ 9,60	5 x 0,8 mm	Ø20 x 7 mm
F121/06	€ 11,00	6 x 1 mm	Ø20 x 7 mm
F121/08	€ 11,00	8 x 1,25 mm	Ø25 x 9 mm
F121/10	€ 12,60	10 x 1,5 mm	Ø30 x 11 mm
F121/12	€ 14,60	12 x 1,75 mm	Ø38 x 14 mm
F121/14	€ 20,60	14 x 2 mm	Ø38 x 14 mm
F121/16	€ 24,20	16 x 2 mm	Ø45 x 18 mm
F121/18	€ 28,00	18 x 2,5 mm	Ø45 x 18 mm
F121/20	€ 29,70	20 x 2,5 mm	Ø45 x 18 mm

F122-
FILIERA PER FILETTATURA GAS CILINDRICA

Con imbocco corretto su entrambi i lati per agevolare l'esecuzione del filetto ed evacuare correttamente i trucioli nella direzione di taglio.



Art.	€	Passo	Dimensioni
F122/1/8	€ 10,90	G1/8-28	Ø30 x 11 mm
F122/1/4	€ 19,00	G1/4-19	Ø38 x 10 mm
F122/3/8	€ 23,60	G3/8-19	Ø45 x 14 mm
F122/1/2	€ 25,40	G1/2-14	Ø45 x 14 mm
F122/5/8	€ 45,50	G5/8-14	Ø55 x 16 mm
F122/3/4	€ 49,90	G3/4-14	Ø55 x 16 mm
F122/7/8	€ 55,20	G7/8-14	Ø65 x 18 mm
F122/1	€ 55,80	G1-11	Ø65 x 18 mm

GAMMA RIPRISTINA FILETTI F-COIL

E' indispensabile per il rinforzo delle filettature in materiali con resistenza ridotta (alluminio, leghe di alluminio o di magnesio). I settori industriali dove trova maggior impiego sono: costruzioni meccaniche ed edilizia, industria automobilistica, attrezzature mediche ed elettroniche e costruzioni aerospaziali e aeronautiche. Il rinforzo della maschiatura elimina l'usura della maschiatura stessa, permettendo un utilizzo frequente del filetto stesso. Sono indispensabili per un ripristino economico e duraturo delle filettature usurate o scartate in fabbricazione.

PROCEDIMENTO DI RIPRISTINO E POSA

1° operazione Conoscere il tipo di filetto rovinato

Conoscenza del tipo di filetto rovinato in modo da poter acquistare il kit adeguato al ripristino.



2° operazione Esecuzione foratura con punta specifica

Esecuzione foratura per la rimozione del filetto rovinato e per la preparazione alla filettatura per il nuovo inserto-filetto F-Coil.



3° Operazione Esecuzione maschiatura per preparazione alloggiamento Filetto F-Coil

Esecuzione dell'operazione di maschiatura con il maschio specifico per la realizzazione dell'alloggio per l'inserto filetto F-Coil.



4° Operazione Avvitare l'inserto Coil con apposito utensile

Avvitare l'inserto F-Coil con l'apposito utensile di montaggio fino a raggiungere la profondità necessaria. Nel caso un'elica non bastasse è possibile aggiungerne altre fino alla profondità necessaria. E' consigliata l'applicazione di colla frenafilletti per evitare il possibile smontaggio del F-Coil.



5° Operazione Rottura con apposito troncatore della tacca di trascinamento

Ultimata l'installazione dell'inserto-filetto procedere con la rottura del codolo di trascinamento.

Per poterlo rompere è necessario utilizzare l'utensile specifico per la rottura.

A partire dalla dimensione del filetto di M14 è possibile eseguire questa operazione con l'utilizzo di una pinza laddove la dimensione del passo lo permette.



RIPARAZIONE FILETTI PER SEDI CANDELE

Per il ripristino delle sedi candele danneggiate il procedimento è diverso: si effettua direttamente la filettatura con l'apposito maschio in dotazione al KIT sul filetto rovinato. Dopodiché viene inserita la boccola-filetto F-COIL che deve essere avvitata completamente fino alla battuta. E' consigliata l'applicazione di collante frenafilletti.

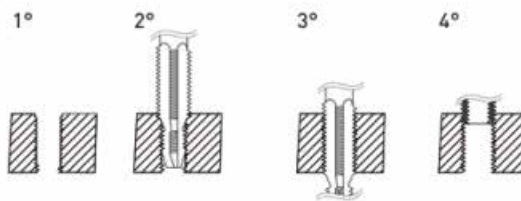

COMPOSIZIONE KIT RIPARAZIONE FILETTI

1	Inserti filettati in acciaio inox da inserire nella maschiatura eseguita ricreando il filetto precedentemente rovinato (disponibile nelle lunghezze di 1xØ, 1,5xØ, 2xØ, 2,5xØ e 3xØ).	
2	Punta elicoidale in HSS per la realizzazione del preforo per maschio.	
3	Maschio specifico per l'esecuzione della maschiatura per l'applicazione dell'inserto filettato.	
4	Utensile per montaggio inserti filettati F-Coil .	Per inserti filetti fino a M24.
		Per inserti da M26.
5	Utensile specifico per la rottura del codolo F-Coil.	





E010

€ 129,00

KIT RIPARAZIONE FILETTI METRICI F-COIL

Adatti per la rigenerazione delle filettature o per ottenere delle maschiature molto resistenti in materiali teneri.

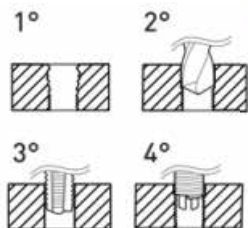

Misure	M5 - M12
Maschi STI	M5 x 0.8 - M6 x 1.0 - M8 x 1.25 - M10 x 1.5 - M12 x 1.75
Punte	5.2 mm - 6.3 mm - 8.3 mm - 10.4 mm - 12.4 mm
Inseri filettati	M5=25 M6=25 M8=25 M10=25 M12=10
Utensile montaggio	5 Pz
Attrezzo rottura	5 Pz

E010B

€ 167,00

KIT RIPARAZIONE FILETTI METRICI F-COIL

Adatti per la rigenerazione delle filettature o per ottenere delle maschiature molto resistenti in materiali teneri.

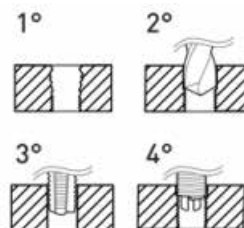

Misure	M6 - M14
Maschi STI	M6 x 1.0 - M8 x 1.25 - M10 x 1.5 - M12 x 1.75 - M14 x 1.25
Punte	6.3 mm - 8.3 mm - 10.4 mm - 12.4 mm
Inseri filettati	M6=25 M8=25 M10=20 M12=15 M14=25
Utensile montaggio	5 Pz
Attrezzo rottura	5 Pz

E010E

€ 112,00

KIT RIPARAZIONE FILETTI METRICI F-COIL

Adatti per la rigenerazione delle filettature o per ottenere delle maschiature molto resistenti in materiali teneri.

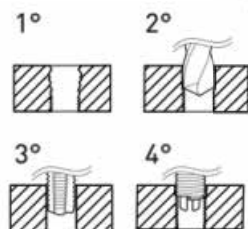

Misure	M5 - M12
Maschi STI	M5 x 0.8 - M6 x 1.0 - M8 x 1.25 - M10 x 1.5 - M12 x 1.75
Punte	5.2 mm - 6.3 mm - 8.3 mm - 10.4 mm - 12.4 mm
Inseri filettati	M5=25 M6=25 M8=25 M10=25 M12=10
Utensile montaggio	5 Pz
Attrezzo rottura	5 Pz

E010-

KIT RIPARAZIONE FILETTI

Adatti per la rigenerazione delle filettature o per ottenere delle maschiature molto resistenti in materiali teneri.

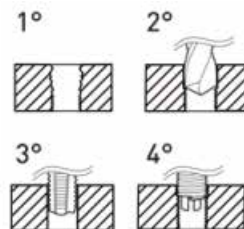

Art.	€	Filetto inserto	Punta	Maschi	Manico
E010/M05	€ 28,50	M5	5,2 mm	x M5	2
E010/M06	€ 30,90	M6	6,3 mm	x M6	2
E010/M08	€ 34,00	M8	8,3 mm	x M8	2
E010/M10	€ 41,10	M10	10,4 mm	x M10	2
E010/M12	€ 43,50	M12	12,4 mm	x M12	2
E010/M14	€ 52,00	M14 x 1,25	14,4 mm	x M14 x 1,25	2

E011A
€ 172,00
KIT RIPARAZIONE FILETTI METRICI F-COIL

Adatti per la rigenerazione delle filettature o per ottenere delle maschiature molto resistenti in materiali teneri.

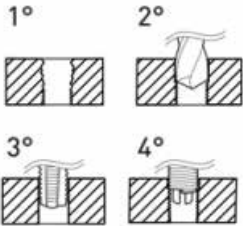

Misure	M5 - M12
Maschi STI	M5 x 0.8 - M6 x 1.0 - M8 x 1.25 - M10 x 1.5 - M12 x 1.75
Punte	5.2 mm - 6.3 mm - 8.3 mm - 10.4 mm - 12.4 mm
Inseriti filettati	M5=25 M6=25 M8=25 M10=25 M12=10
Utensile montaggio	5 Pz
Attrezzo rottura	5 Pz

E011B
€ 202,00
KIT RIPARAZIONE FILETTI METRICI F-COIL

Adatti per la rigenerazione delle filettature o per ottenere delle maschiature molto resistenti in materiali teneri.

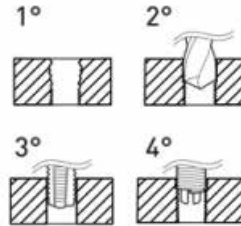

Misure	M6 - M14
Maschi STI	M6 x 1.0 - M8 x 1.25 - M10 x 1.5 - M12 x 1.75 - M14 x 1.25
Punte	6.3 mm - 8.3 mm - 10.4 mm - 12.4 mm
Inseriti filettati	M6=25 M8=25 M10=25 M12=10 M14=10
Utensile montaggio	5 Pz
Attrezzo rottura	4 Pz

E011C
€ 119,00
KIT RIPARAZIONE FILETTI METRICI F-COIL

Adatti per la rigenerazione delle filettature o per ottenere delle maschiature molto resistenti in materiali teneri.

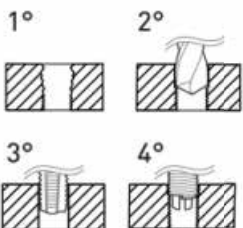

Misure	M6 - M10
Maschi STI	M6 x 1.0 - M8 x 1.25 - M10 x 1.5
Punte	6.3 mm - 8.3 mm - 10.4 mm
Inseriti filettati	M6 25 Pz - M8 25 Pz - M10 25 Pz
Utensile montaggio	3 Pz
Attrezzo rottura	3 Pz

E011D
€ 213,00
KIT RIPARAZIONE FILETTI METRICI F-COIL

Adatti per la rigenerazione delle filettature o per ottenere delle maschiature molto resistenti in materiali teneri. Misura da 14 mm specifica per candele auto.

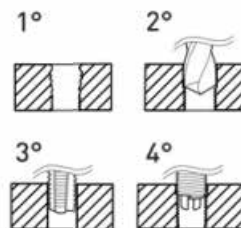

Misure	M6 - M14
Maschi STI	M6 x 1.0 - M8 x 1.25 - M10 x 1.5 - M12 x 1.75 - M14 x 1.25
Punte	6.3 mm - 8.3 mm - 10.4 mm - 12.4 mm
Inseriti filettati	M6 25 Pz - M8 25 Pz - M10 25 Pz - M12 10 Pz - M14 10 Pz
Utensile montaggio	5 Pz
Attrezzo rottura	4 Pz



E011-MX1

KIT RIPARAZIONE FILETTI METRICI F-COIL

Adatti per la rigenerazione delle filettature o per ottenere delle maschiature molto resistenti in materiali teneri.

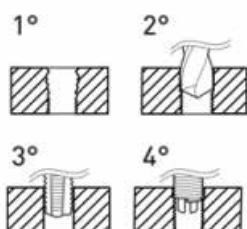

Append.

Art.	€	Dimensioni	Punta	Maschi STI	Utensile montaggio	Attrezzo rottura	Quantità inserti
E011/M020X040	€ 27,50	M 2 x 0.4	Ø 2.1 mm	E011/M020X040M	E011/U02	E011/A02	20
E011/M025X045	€ 27,50	M 2.5 x 0.45	Ø 2.6 mm	E011/M025X045M	E011/U03	E011/A03	20
E011/M030X050	€ 27,50	M 3 x 0.5	Ø 3.2 mm	E011/M030X050M	E011/U04	E011/A04	20
E011/M035X060	€ 27,50	M 3.5 x 0.6	Ø 3.7 mm	E011/M035X060M	E011/U05	E011/A05	20
E011/M040X070	€ 27,50	M 4 x 0.7	Ø 4.2 mm	E011/M040X070M	E011/U06	E011/A06	20
E011/M050X080	€ 28,50	M 5 x 0.8	Ø 5.2 mm	E011/M050X080M	E011/U08	E011/A08	20
E011/M060X100	€ 30,20	M 6 x 1.0	Ø 6.3 mm	E011/M060X100M	E011/U09	E011/A09	20
E011/M070X100	€ 37,50	M 7 x 1.0	Ø 7.3 mm	E011/M070X100M	E011/U10	E011/A11	20
E011/M080X100	€ 37,50	M 8 x 1.0	Ø 8.3 mm	E011/M080X100M	E011/U11	E011/A11	20
E011/M080X125	€ 37,50	M 8 x 1.25	Ø 8.3 mm	E011/M080X125M	E011/U11	E011/A11	20
E011/M090X100	€ 37,50	M 9 x 1.0	Ø 9.3 mm	E011/M090X100M	E011/U12	E011/A12	10
E011/M090X125	€ 42,10	M 9 x 1.25	Ø 9.3 mm	E011/M090X125M	E011/U12	E011/A12	15
E011/M100X100	€ 40,20	M 10 x 1.0	Ø 10.3 mm	E011/M100X100M	E011/U13	E011/A13	15
E011/M100X125	€ 40,20	M 10 x 1.25	Ø 10.3 mm	E011/M100X125M	E011/U13	E011/A13	15
E011/M100X150	€ 40,20	M 10 x 1.5	Ø 10.4 mm	E011/M100X150M	E011/U13	E011/A13	15
E011/M110X150	€ 44,70	M 11 x 1.5	Ø 11.4 mm	E011/M110X150M	E011/U14	E011/A14	10
E011/M120X100	€ 44,70	M 12 x 1.0	Ø 12.3 mm	E011/M120X100M	E011/U15	E011/A15	10
E011/M120X125	€ 44,70	M 12 x 1.25	Ø 12.3 mm	E011/M120X125M	E011/U15	E011/A15	10
E011/M120X150	€ 44,70	M 12 x 1.5	Ø 12.4 mm	E011/M120X150M	E011/U15	E011/A15	10
E011/M120X175	€ 44,70	M 12 x 1.75	Ø 12.4 mm	E011/M120X175M	E011/U15	E011/A15	10
E011/M140X100	€ 52,00	M 14 x 1.0	-	E011/M140X100M	E011/U16	-	10
E011/M140X125	€ 52,00	M 14 x 1.25	-	E011/M140X125M	E011/U16	-	10
E011/M140X150	€ 52,00	M 14 x 1.5	-	E011/M140X150M	E011/U17	-	10
E011/M140X200	€ 52,00	M 14 x 2.0	-	E011/M140X200M	E011/U17	-	10
E011/M160X150	€ 61,10	M 16 x 1.5	-	E011/M160X150M	E011/U18	-	10
E011/M160X200	€ 61,10	M 16 x 2.0	-	E011/M160X200M	E011/U18	-	10
E011/M180X150	€ 72,00	M 18 x 1.5	-	E011/M180X150M	E011/U20	-	5
E011/M180X200	€ 72,00	M 18 x 2.0	-	E011/M180X200M	E011/U20	-	5
E011/M180X250	€ 72,00	M 18 x 2.5	-	E011/M180X250M	E011/U20	-	5
E011/M200X150	€ 78,30	M 20 x 1.5	-	E011/M200X150M	E011/U21	-	5
E011/M200X200	€ 78,30	M 20 x 2.0	-	E011/M200X200M	E011/U21	-	5
E011/M200X250	€ 78,30	M 20 x 2.5	-	E011/M200X250M	E011/U21	-	5
E011/M220X150	€ 89,30	M 22 x 1.5	-	E011/M220X150M	E011/U22	-	5
E011/M220X200	€ 89,30	M 22 x 2.0	-	E011/M220X200M	E011/U22	-	5
E011/M220X250	€ 89,30	M 22 x 2.5	-	E011/M220X250M	E011/U22	-	5
E011/M240X150	€ 101,00	M 24 x 1.5	-	E011/M240X150M	E011/U23	-	5
E011/M240X200	€ 101,00	M 24 x 2.0	-	E011/M240X200M	E011/U23	-	5
E011/M240X300	€ 101,00	M 24 x 3.0	-	E011/M240X300M	E011/U23	-	5

E011/M140X125B

€ 66,30

KIT METRICO DI RIPARAZIONE CON FILETTI A BUSSOLA PER CANDELE

Specifico per riparazioni o rinforzi sedi candele.



17 Pcs

Append.

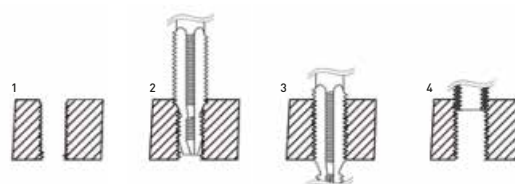

Maschi STI

E011/M140X125MCB

Inserti filettati

4 x H 9.5 mm - 4 x H 11.2 mm - 4 x H 12.7 mm - 4 x H 17.5 mm

E011-MXC

KIT RIPARAZIONE FILETTI METRICI CANDELE F-COIL

Specifico per riparazioni o rinforzi sedi candele.



Append.

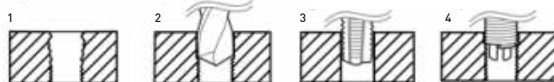

Art.	€	Misura	Utensile montaggio	Maschi STI	Inserti filettati
E011/M060X100C	€ 43,70	M 6 x 1.0	E011/U09	E011/M060X100M	10
E011/M080X125C	€ 43,70	M 8 x 1.25	E011/U11	E011/M080X125M	10
E011/M100X100C	€ 46,30	M 10 x 1.0	E011/U13	E011/M100X100M	10
E011/M100X125C	€ 46,30	M 10 x 1.25	E011/U13	E011/M100X125M	10
E011/M100X150C	€ 46,30	M 10 x 1.5	E011/U13	E011/M100X150M	10
E011/M120X125C	€ 54,80	M 12 x 1.25	E011/U15	E011/M120X125M	10
E011/M140X125C	€ 62,30	M 14 x 1.25	E011/U17	E011/M140X125M	5 x E010/M140X125E084 - 5 x E010/M140X125E124 - 5 x E010/M140X125E164

E010-MXEXC
INSERTO FILETTATO INOX

Specifico per riparazioni o rinforzi sedi candele. A sezione romboidale, con forma a molla, che crea due filettature perfettamente concentriche; una esterna che si accoppia con il foro filettato precedentemente eseguito e una interna che accoglie la vite.



Append.

Art.	€	Dimensioni	H	Pack
E010/M140X125E084	€ 0,80	M 14 x 1.25	8.4 mm	10
E010/M140X125E124	€ 0,71	M 14 x 1.25	12.4 mm	10
E010/M140X125E164	€ 0,79	M 14 x 1.25	16.4 mm	10

E011-M140X125EX
KIT FILETTI A BUSSOLA PER CANDELE

Specifico per riparazioni o rinforzi sedi candele.



Append.

Art.	€	Misura	H	Pack
E011/M140X125E095	€ 3,91	M 14 x 1.25	9.5 mm	10
E011/M140X125E112	€ 4,09	M 14 x 1.25	11.2 mm	10
E011/M140X125E127	€ 4,09	M 14 x 1.25	12.7 mm	10
E011/M140X125E175	€ 4,36	M 14 x 1.25	17.5 mm	10

E011/M140X125MCB
€ 39,10
MASCHIO COMBINATO

Specifico per creazione di filettature di ripristino su sedi candele.



Misura	M 16 x 1.25
Esagono	18 mm
L	70 mm
l	32 mm

E011/MC
€ 193,00
KIT METRICA DI RIPARAZIONE CON FILETTI A BUSSOLA PER CANDELETTE

Specifico per riparazioni o rinforzi sedi candele.



33 Pcs

Scatola

Misura	8 mm - 10 mm - 12 mm
Maschi STI	M8x1 - M10x1 - M10x1.25 - M12x1 - M12x1.25 - M14x1.25

E011/BSW
€ 229,00
KIT RIPARAZIONE FILETTI BSW F-COIL 1/4-1/2

Adatti per la rigenerazione delle filettature o per ottenere delle maschiature molto resistenti in materiali teneri.



115 Pcs

Valigetta

Misure	BSW 1/4" - 1/2"
Maschi STI	1/4"x20-5/16"x18-3/8"x16-7/16"x14-1/2"x12
Punte	6.6 mm - 8.3 mm - 9.9 mm - 11.5 mm - 13.0 mm
Inserti filettati	1/4"=25 5/16"=25 3/8"=25 7/16"=10 1/2"=10
Utensile montaggio	5 Pz
Attrezzo rottura	5 Pz

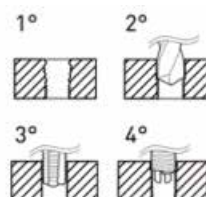
E011-BSWX
KIT RIPARAZIONE FILETTI BSW F-COIL

Adatti per la rigenerazione delle filettature o per ottenere delle maschiature molto resistenti in materiali teneri.



Append.

Art.	€	Filetto	Punta	Maschi STI	Utensile montaggio	Attrezzo rottura	Inserti filettati	Quantità inserti
E011/BSW1/8	€ 35,90	1/8" x 40	Ø 3.4 mm	E011/BSW1/8M	E011/U04	E011/A4	E010/BSW1/8E15	20
E011/BSW3/16	€ 35,90	3/16" x 24	Ø 5.0 mm	E011/BSW3/16M	E011/U08	E011/A8	E010/BSW3/16E15	20
E011/BSW1/4	€ 32,70	1/4" x 20	Ø 6.7 mm	E011/BSW1/4M	E011/U09	E011/A9	E010/BSW1/4E15	20
E011/BSW5/16	€ 39,40	5/16" x 18	Ø 8.3 mm	E011/BSW5/16M	E011/U10	E011/A11	E010/BSW5/16E15	20
E011/BSW7/16	€ 46,60	7/16" x 14	Ø 11.5 mm	E011/BSW7/16M	E011/U14	E011/A14	E010/BSW7/16E15	10
E011/BSW1/2	€ 50,80	1/2" x 12	Ø 13.0 mm	E011/BSW1/2M	E011/U15	E011/A15	E010/BSW1/2E15	10
E011/BSW9/16	€ 67,10	9/16" x 12	-	E011/BSW9/16M	E011/U16	-	E010/BSW9/16E15	10
E011/BSW5/8	€ 67,10	5/8" x 11	-	E011/BSW5/8M	E011/U18	-	E010/BSW5/8E15	10
E011/BSW3/4	€ 84,80	3/4" x 10	-	E011/BSW3/4M	E011/U20	-	E010/BSW3/4E15	5
E011/BSW7/8	€ 102,00	7/8" x 9	-	E011/BSW7/8M	E011/U22	-	E010/BSW7/8E15	5
E011/BSW1	€ 97,90	1" x 8	-	E011/BSW1M	E011/U23	-	E010/BSW1E15	4





E011/BSF

€ 229,00

KIT RIPARAZIONE FILETTI BSF F-COIL 1/4-1/2

Adatti per la rigenerazione delle filettature o per ottenere delle maschiature molto resistenti in materiali teneri.



Misure	BSF 1/4" - 1/2"	
Maschi STI	1/4"x26-5/16"x22-3/8"x20-7/16"x18-1/2"x16	
Punte	6.6 mm - 8.3 mm - 9.9 mm - 11.5 mm - 13.0 mm	
Inseri filettati	1/4"=25 5/16"=25 3/8"=25 7/16"=10 - 1/2"=10	
Utensile montaggio	5 Pz	
Attrezzo rottura	5 Pz	

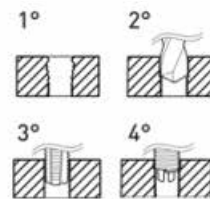

E011-BSFX

KIT RIPARAZIONE FILETTI BSF F-COIL

Adatti per la rigenerazione delle filettature o per ottenere delle maschiature molto resistenti in materiali teneri.



Art.	€	Filetto	Punta	Maschi STI	Utensile montaggio	Attrezzo rottura	Inseri filettati	Quantità inserti
E011/BSF3/16	€ 35,90	3/16" x 32	Ø 5.0 mm	E011/BSF3/16M	E011/U07	E011/A06	E010/BSF3/16E15	20
E011/BSF1/4	€ 32,70	1/4" x 26	Ø 6.6 mm	E011/BSF1/4M	E011/U09	E011/A09	E010/BSF1/4E15	20
E011/BSF5/16	€ 39,40	5/16" x 22	Ø 8.3 mm	E011/BSF5/16M	E011/U11	E011/A11	E010/BSF5/16E15	20
E011/BSF3/8	€ 41,90	3/8" x 20	Ø 9.9 mm	E011/BSF3/8M	E011/U13	E011/A13	E010/BSF3/8E15	15
E011/BSF7/16	€ 46,60	7/16" x 18	Ø 11.5 mm	E011/BSF7/16M	E011/U14	E011/A14	E010/BSF7/16E15	10
E011/BSF1/2	€ 50,80	1/2" x 16	Ø 13.0 mm	E011/BSF1/2M	E011/U15	E011/A15	E010/BSF1/2E15	10
E011/BSF9/16	€ 67,10	9/16" x 16	-	E011/BSF9/16M	E011/U16	-	E010/BSF9/16E15	10
E011/BSF5/8	€ 67,10	5/8" x 14	-	E011/BSF5/8M	E011/U18	-	E010/BSF5/8E15	10
E011/BSF3/4	€ 84,80	3/4" x 12	-	E011/BSF3/4M	E011/U20	-	E010/BSF3/4E15	5
E011/BSF7/8	€ 102,00	7/8" x 11	-	E011/BSF7/8M	E011/U22	-	E010/BSF7/8E15	5
E011/BSF1	€ 97,90	1" x 10	-	E011/BSF1M	E011/U23	-	E010/BSF1E15	4

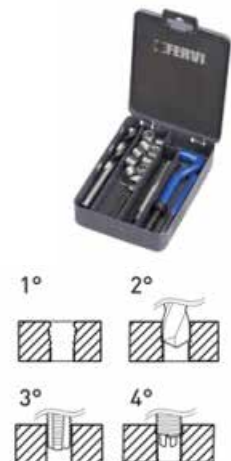

E011/UNC

€ 229,00

SERIE RIPARAZIONE FILETTI UNC F-COIL 1/4-1/2

Adatti per la rigenerazione delle filettature o per ottenere delle maschiature molto resistenti in materiali teneri.



Misure	UNC 1/4" - 1/2"	
Maschi STI	1/4"x20-5/16"x18-3/8"x16-7/16"x14-1/2"x13	
Punte	6.7 mm - 8.3 mm - 9.8 mm - 11.5 mm - 13.0 mm	
Inseri filettati	1/4"=25 5/16"=25 3/8"=25 7/16"=10 1/2"=10	
Utensile montaggio	5 Pz	
Attrezzo rottura	5 Pz	

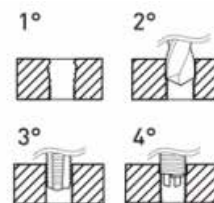

E011-UNCX

KIT RIPARAZIONE FILETTI UNC F-COIL

Adatti per la rigenerazione delle filettature o per ottenere delle maschiature molto resistenti in materiali teneri.



Art.	€	Filetto	Punte	Maschi STI	Utensile montaggio	Attrezzo rottura	Inseri filettati	Quantità inserti
E011/UNC1/4	€ 31,70	1/4" x 20	Ø 6.7 mm	E011/UNC1/4M	E011/U09	E011/A09	E010/UNC1/4E15	20
E011/UNC5/16	€ 38,50	5/16" x 18	Ø 8.3 mm	E011/UNC5/16M	E011/U10	E011/A11	E010/UNC5/16E15	20
E011/UNC3/8	€ 41,00	3/8" x 16	Ø 9.9 mm	E011/UNC3/8M	E011/U06	E011/A06	E010/UNC3/8E15	20
E011/UNC7/16	€ 45,70	7/16" x 14	Ø 11.6 mm	E011/UNC7/16M	E011/U14	E011/A14	E010/UNC7/16E15	10
E011/UNC1/2	€ 50,00	1/2" x 13	Ø 13.0 mm	E011/UNC1/2M	E011/U15	E011/A15	E010/UNC1/2E15	10
E011/UNC9/16	€ 66,20	9/16" x 12	-	E011/UNC9/16M	E011/U16	-	E010/UNC9/16E15	10
E011/UNC5/8	€ 66,20	5/8" x 1	-	E011/UNC5/8M	E011/U18	-	E010/UNC5/8E15	10
E011/UNC3/4	€ 83,90	3/4" x 10	-	E011/UNC3/4M	E011/U20	-	E010/UNC3/4E15	5
E011/UNC7/8	€ 102,00	7/8" x 9	-	E011/UNC7/8M	E011/U22	-	E010/UNC7/8E15	5



E011/UNF
€ 229,00
KIT RIPARAZIONE FILETTI UNF F-COIL 1/4-1/2

Adatti per la rigenerazione delle filettature o per ottenere delle maschiature molto resistenti in materiali teneri.

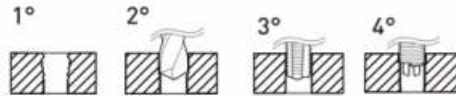

Misure	UNF 1/4" - 1/2"
Maschi STI	1/4"x28-5/16"x24-3/8"x24-7/16"x20-1/2"x20
Punte	6.7 mm - 8.3 mm - 9.8 mm - 11.5 mm - 13.0 mm
Inseri filettati	1/4"=25 5/16"=25 3/8"=25 7/16"=10 - 1/2"=10
Utensile montaggio	5 Pz
Attrezzo rottura	5 Pz

E011-UNFX
KIT RIPARAZIONE FILETTI UNF F-COIL

Adatti per la rigenerazione delle filettature o per ottenere delle maschiature molto resistenti in materiali teneri.



Append.

Art.	€	Filetto	Punte	Maschi STI	Utensile montaggio	Attrezzo rottura	Inseri filettati	Quantità inserti
E011/UNFN10	€ 38,50	No. 10 x 32	Ø 5.1 mm	E011/UNFN10M	E011/U08	E011/A08	E010/UNFN10E15	20
E011/UNF1/4	€ 31,70	1/4" x 28	Ø 6.7 mm	E011/UNF1/4M	E011/U09	E011/A09	E010/UNF1/4E15	20
E011/UNF5/16	€ 38,50	5/16" x 24	Ø 8.3 mm	E011/UNF5/16M	E011/U11	E011/A11	E010/UNF5/16E15	20
E011/UNF3/8	€ 41,00	3/8" x 24	Ø 9.8 mm	E011/UNF3/8M	E011/U13	E011/A13	E010/UNF3/8E15	15
E011/UNF1/2	€ 50,00	1/2" x 20	Ø 13.0 mm	E011/UNF1/2M	E011/U15	E011/A15	E010/UNF1/2E15	10
E011/UNF9/16	€ 66,20	9/16" x 18	-	E011/UNF9/16M	E011/U16	-	E010/UNF9/16E15	10
E011/UNF5/8	€ 66,20	5/8" x 18	-	E011/UNF5/8M	E011/U18	-	E010/UNF5/8E15	10
E011/UNF3/4	€ 83,90	3/4" x 16	-	E011/UNF3/4M	E011/U21	-	E010/UNF3/4E15	5
E011/UNF7/8	€ 102,00	7/8" x 14	-	E011/UNF7/8M	E011/U22	-	E010/UNF7/8E15	5
E011/UNF1	€ 96,60	1" x 12	-	E011/UNF112M	E011/U23	-	E010/UNF1E15	4

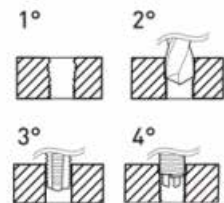
E010-MXE1
INSERTO FILETTATO INOX H=1XD

A sezione romboidale, con forma a molla, che crea due filettature perfettamente concentriche; una esterna che si accoppia con il foro precedentemente filettato con il maschio apposito ed una interna dove si andrà ad avvitare la vite di fissaggio.



Append.

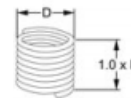

Art.	€	D	Pack
E010/M020X040E1	€ 0,68	M 2 x 0.4	25
E010/M022X045E1	€ 0,68	M 2.2 x 0.45	25
E010/M025X045E1	€ 0,21	M 2.5 x 0.45	25
E010/M030X050E1	€ 0,21	M 3 x 0.5	25
E010/M035X060E1	€ 0,23	M 3.5 x 0.6	25
E010/M040X070E1	€ 0,21	M 4 x 0.7	25
E010/M050X080E1	€ 0,23	M 5 x 0.8	25
E010/M060X100E1	€ 0,26	M 6 x 1.0	25
E010/M070X100E1	€ 0,27	M 7 x 1.0	25
E010/M080X100E1	€ 0,30	M 8 x 1.0	25
E010/M080X125E1	€ 0,26	M 8 x 1.25	25
E010/M090X125E1	€ 0,37	M 9 x 1.25	25
E010/M100X100E1	€ 0,33	M 10 x 1.0	25
E010/M100X125E1	€ 0,33	M 10 x 1.25	25
E010/M100X150E1	€ 0,33	M 10 x 1.5	25
E010/M110X150E1	€ 0,56	M 11 x 1.5	10
E010/M120X100E1	€ 0,49	M 12 x 1.0	10
E010/M120X125E1	€ 0,49	M 12 x 1.25	10
E010/M120X150E1	€ 0,49	M 12 x 1.5	10

Art.	€	D	Pack
E010/M120X175E1	€ 0,49	M 12 x 1.75	10
E010/M140X100E1	€ 0,84	M 14 x 1.0	10
E010/M140X125E1	€ 0,69	M 14 x 1.25	10
E010/M140X150E1	€ 0,69	M 14 x 1.5	10
E010/M140X200E1	€ 0,69	M 14 x 2.0	10
E010/M160X150E1	€ 0,95	M 16 x 1.5	10
E010/M160X200E1	€ 0,95	M 16 x 2.0	10
E010/M180X150E1	€ 1,37	M 18 x 1.5	10
E010/M180X200E1	€ 1,37	M 18 x 2.0	10
E010/M180X250E1	€ 1,37	M 18 x 2.5	10
E010/M200X150E1	€ 1,60	M 20 x 1.5	10
E010/M200X200E1	€ 1,60	M 20 x 2.0	10
E010/M200X250E1	€ 1,60	M 20 x 2.5	10
E010/M220X150E1	€ 1,73	M 22 x 1.5	5
E010/M220X200E1	€ 1,73	M 22 x 2.0	5
E010/M220X250E1	€ 1,73	M 22 x 2.5	5
E010/M240X150E1	€ 2,17	M 24 x 1.5	5
E010/M240X200E1	€ 2,17	M 24 x 2.0	5
E010/M240X300E1	€ 2,17	M 24 x 3.0	5

E010-MXE15
INSERTO FILETTATO INOX
H=1,5XD

A sezione romboidale, con forma a molla, che crea due filettature perfettamente concentriche; una esterna che si accoppia con il foro precedentemente filettato con il maschio apposito ed una interna dove si andrà ad avvitare la vite di fissaggio.



Append.

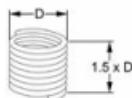

Art.	€	D	Pack
E010/M020X040E15	€ 0,88	M 2 x 0.4	25
E010/M022X045E15	€ 0,88	M 2.2 x 0.45	25
E010/M025X045E15	€ 0,22	M 2.5 x 0.45	25
E010/M030X050E15	€ 0,22	M 3 x 0.5	25
E010/M035X060E15	€ 0,26	M 3.5 x 0.6	25
E010/M040X070E15	€ 0,22	M 4 x 0.7	25
E010/M050X080E15	€ 0,20	M 5 x 0.8	25
E010/M060X100E15	€ 0,21	M 6 x 1.0	25
E010/M070X100E15	€ 0,33	M 7 x 1.0	25
E010/M080X100E15	€ 0,30	M 8 x 1.0	25
E010/M080X125E15	€ 0,26	M 8 x 1.25	25
E010/M090X100E15	€ 0,58	M 9 x 1.0	25
E010/M090X125E15	€ 0,49	M 9 x 1.25	25
E010/M100X100E15	€ 0,37	M 10 x 1.0	25
E010/M100X125E15	€ 0,37	M 10 x 1.25	25
E010/M100X150E15	€ 0,37	M 10 x 1.5	25
E010/M110X150E15	€ 0,62	M 11 x 1.5	10
E010/M120X100E15	€ 0,57	M 12 x 1.0	10
E010/M120X125E15	€ 0,57	M 12 x 1.25	10
E010/M120X150E15	€ 0,57	M 12 x 1.5	10
E010/M120X175E15	€ 0,57	M 12 x 1.75	10
E010/M140X100E15	€ 0,67	M 14 x 1.0	10
E010/M140X125E15	€ 0,67	M 14 x 1.25	10
E010/M140X150E15	€ 0,67	M 14 x 1.50	10
E010/M140X200E15	€ 0,67	M 14 x 2.0	10
E010/M160X150E15	€ 0,78	M 16 x 1.5	10
E010/M160X200E15	€ 0,78	M 16 x 2.0	10
E010/M180X150E15	€ 1,20	M 18 x 1.5	10
E010/M180X200E15	€ 1,20	M 18 x 2.0	10
E010/M180X250E15	€ 1,20	M 18 x 2.5	10
E010/M200X150E15	€ 1,53	M 20 x 1.5	10
E010/M200X200E15	€ 1,53	M 20 x 2.0	10
E010/M200X250E15	€ 1,53	M 20 x 2.5	10
E010/M220X150E15	€ 2,17	M 22 x 1.5	5
E010/M220X200E15	€ 2,17	M 22 x 2.0	5
E010/M220X250E15	€ 2,17	M 22 x 2.5	5
E010/M240X150E15	€ 2,31	M 24 x 1.5	5
E010/M240X200E15	€ 2,31	M 24 x 2.0	5
E010/M240X300E15	€ 2,31	M 24 x 3.0	5
E010/M260X150E15	€ 4,33	M 26 x 1.5	5
E010/M270X150E15	€ 4,33	M 27 x 1.5	5
E010/M270X200E15	€ 4,33	M 27 x 2.0	5
E010/M270X300E15	€ 4,33	M 27 x 3.0	5
E010/M280X150E15	€ 4,33	M 28 x 1.5	5
E010/M300X150E15	€ 5,30	M 30 x 1.5	5
E010/M300X200E15	€ 5,30	M 30 x 2.0	5
E010/M300X350E15	€ 5,30	M 30 x 3.5	5
E010/M330X200E15	€ 6,20	M 33 x 2.0	5
E010/M330X350E15	€ 6,20	M 33 x 3.5	5
E010/M360X150E15	€ 6,20	M 36 x 1.5	5
E010/M360X200E15	€ 6,20	M 36 x 2.0	5
E010/M360X300E15	€ 6,20	M 36 x 3.0	5
E010/M360X400E15	€ 6,20	M 36 x 4.0	5
E010/M390X300E15	€ 13,70	M 39 x 3.0	5
E010/M390X400E15	€ 13,70	M 39 x 4.0	5
E010/M400X300E15	€ 19,00	M 40 x 3.0	5
E010/M420X300E15	€ 19,00	M 42 x 3.0	5
E010/M450X300E15	€ 22,80	M 45 x 3.0	5

E010-MXE2
INSERTO FILETTATO INOX
H=2XD

A sezione romboidale, con forma a molla, che crea due filettature perfettamente concentriche; una esterna che si accoppia con il foro precedentemente filettato con il maschio apposito ed una interna dove si andrà ad avvitare la vite di fissaggio.



Append.

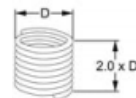

Art.	€	D	Pack
E010/M020X040E2	€ 1,03	M 2 x 0.4	25
E010/M022X045E2	€ 1,03	M 2.2 x 0.45	25
E010/M025X045E2	€ 0,23	M 2.5 x 0.45	25
E010/M030X050E2	€ 0,23	M 3 x 0.5	25
E010/M035X060E2	€ 0,26	M 3.5 x 0.6	25
E010/M040X070E2	€ 0,23	M 4 x 0.7	25
E010/M050X080E2	€ 0,26	M 5 x 0.8	25
E010/M060X100E2	€ 0,30	M 6 x 1.0	25
E010/M070X100E2	€ 0,37	M 7 x 1.0	25
E010/M080X100E2	€ 0,39	M 8 x 1.0	25
E010/M080X125E2	€ 0,37	M 8 x 1.25	25
E010/M090X125E2	€ 0,49	M 9 x 1.25	25
E010/M100X100E2	€ 0,42	M 10 x 1.0	25
E010/M100X125E2	€ 0,42	M 10 x 1.25	25
E010/M100X150E2	€ 0,42	M 10 x 1.5	25
E010/M110X150E2	€ 0,67	M 11 x 1.5	10
E010/M120X100E2	€ 0,64	M 12 x 1.0	10
E010/M120X125E2	€ 0,64	M 12 x 1.25	10
E010/M120X150E2	€ 0,64	M 12 x 1.5	10
E010/M120X175E2	€ 0,64	M 12 x 1.75	10
E010/M140X100E2	€ 0,83	M 14 x 1.0	10
E010/M140X125E2	€ 0,83	M 14 x 1.25	10
E010/M140X150E2	€ 0,83	M 14 x 1.5	10
E010/M140X200E2	€ 0,83	M 14 x 2.0	10
E010/M160X150E2	€ 1,22	M 16 x 1.5	10
E010/M160X200E2	€ 1,22	M 16 x 2.0	10
E010/M180X150E2	€ 2,17	M 18 x 1.5	10
E010/M180X200E2	€ 2,17	M 18 x 2.0	10
E010/M180X250E2	€ 2,17	M 18 x 2.5	10
E010/M200X150E2	€ 2,59	M 20 x 1.5	10
E010/M200X200E2	€ 2,59	M 20 x 2.0	10
E010/M200X250E2	€ 2,59	M 20 x 2.5	10
E010/M220X150E2	€ 2,75	M 22 x 1.5	5
E010/M220X200E2	€ 2,75	M 22 x 2.0	5
E010/M220X250E2	€ 2,75	M 22 x 2.5	5
E010/M240X150E2	€ 2,88	M 24 x 1.5	5
E010/M240X200E2	€ 2,88	M 24 x 2.0	5
E010/M240X300E2	€ 2,88	M 24 x 3.0	5



E010-MXE25
**INSERTO FILETTATO INOX
H=2,5XD**

A sezione romboidale, con forma a molla, che crea due filettature perfettamente concentriche; una esterna che si accoppia con il foro precedentemente filettato con il maschio apposito ed una interna dove si andrà ad avvitare la vite di fissaggio.

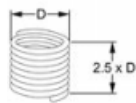

Art.	€	D	Pack
E010/M020X040E25	€ 1,16	2 x 0.4	25
E010/M022X045E25	€ 1,16	2.2 x 0.45	25
E010/M025X045E25	€ 0,27	2.5 x 0.45	25
E010/M030X050E25	€ 0,27	3 x 0.5	25
E010/M035X060E25	€ 0,30	3.5 x 0.6	25
E010/M040X070E25	€ 0,27	4 x 0.7	25
E010/M050X080E25	€ 0,32	5 x 0.8	25
E010/M060X100E25	€ 0,37	6 x 1.0	25
E010/M070X100E25	€ 0,44	7 x 1.0	25
E010/M080X100E25	€ 0,46	8 x 1.0	25
E010/M080X125E25	€ 0,44	8 x 1.25	25
E010/M090X125E25	€ 0,55	9 x 1.25	25
E010/M100X100E25	€ 0,50	10 x 1.0	25
E010/M100X125E25	€ 0,50	10 x 1.25	25
E010/M100X150E25	€ 0,50	10 x 1.5	25
E010/M110X150E25	€ 0,76	11 x 1.5	10
E010/M120X100E25	€ 0,76	12 x 1.0	10
E010/M120X125E25	€ 0,76	12 x 1.25	10
E010/M120X150E25	€ 0,76	12 x 1.5	10
E010/M120X175E25	€ 0,76	12 x 1.75	10
E010/M140X100E25	€ 1,00	14 x 1.0	10
E010/M140X125E25	€ 1,00	14 x 1.25	10
E010/M140X150E25	€ 1,00	14 x 1.5	10
E010/M140X200E25	€ 1,00	14 x 2.0	10
E010/M160X150E25	€ 1,32	16 x 1.5	10
E010/M160X200E25	€ 1,32	16 x 2.0	10
E010/M180X150E25	€ 2,46	18 x 1.5	10
E010/M180X200E25	€ 2,46	18 x 2.0	10
E010/M180X250E25	€ 2,46	18 x 2.5	10
E010/M200X150E25	€ 2,88	20 x 1.5	10
E010/M200X200E25	€ 2,88	20 x 2.0	10
E010/M200X250E25	€ 2,88	20 x 2.5	10
E010/M220X150E25	€ 3,17	22 x 1.5	5
E010/M220X200E25	€ 3,17	22 x 2.0	5
E010/M220X250E25	€ 3,17	22 x 2.5	5
E010/M240X150E25	€ 3,45	24 x 1.5	5
E010/M240X200E25	€ 3,45	24 x 2.0	5
E010/M240X300E25	€ 3,45	24 x 3.0	5

E010-MXE3
**INSERTO FILETTATO INOX
H=3XD**

A sezione romboidale, con forma a molla, che crea due filettature perfettamente concentriche; una esterna che si accoppia con il foro precedentemente filettato con il maschio apposito ed una interna dove si andrà ad avvitare la vite di fissaggio.

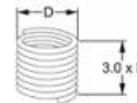

Art.	€	D	Pack
E010/M020X040E3	€ 1,44	M 2 x 0.4	25
E010/M022X045E3	€ 1,44	M 2.2 x 0.45	25
E010/M025X045E3	€ 0,33	M 2.5 x 0.45	25
E010/M030X050E3	€ 0,33	M 3 x 0.5	25
E010/M035X060E3	€ 0,37	M 3.5 x 0.6	25
E010/M040X070E3	€ 0,30	M 4 x 0.7	25
E010/M050X080E3	€ 0,38	M 5 x 0.8	25
E010/M060X100E3	€ 0,45	M 6 x 1.0	25
E010/M070X100E3	€ 0,51	M 7 x 1.0	25
E010/M080X100E3	€ 0,57	M 8 x 1.0	25
E010/M080X125E3	€ 0,51	M 8 x 1.25	25
E010/M090X125E3	€ 0,64	M 9 x 1.25	25
E010/M100X100E3	€ 0,61	M 10 x 1.0	25
E010/M100X125E3	€ 0,61	M 10 x 1.25	25
E010/M100X150E3	€ 0,61	M 10 x 1.5	25
E010/M110X150E3	€ 0,90	M 11 x 1.5	10
E010/M120X100E3	€ 0,90	M 12 x 1.0	10
E010/M120X125E3	€ 0,90	M 12 x 1.25	10
E010/M120X150E3	€ 0,90	M 12 x 1.5	10
E010/M120X175E3	€ 0,90	M 12 x 1.75	10
E010/M140X100E3	€ 1,22	M 14 x 1.0	10
E010/M140X125E3	€ 1,22	M 14 x 1.25	10
E010/M140X150E3	€ 1,22	M 14 x 1.5	10
E010/M140X200E3	€ 1,44	M 14 x 2.0	10
E010/M160X150E3	€ 1,44	M 16 x 1.5	10
E010/M160X200E3	€ 1,44	M 16 x 2.0	10
E010/M180X150E3	€ 2,88	M 18 x 1.5	10
E010/M180X200E3	€ 2,88	M 18 x 2.0	10
E010/M180X250E3	€ 2,88	M 18 x 2.5	10
E010/M200X150E3	€ 3,33	M 20 x 1.5	10
E010/M200X200E3	€ 3,33	M 20 x 2.0	10
E010/M200X250E3	€ 3,33	M 20 x 2.5	10
E010/M220X150E3	€ 3,61	M 22 x 1.5	5
E010/M220X200E3	€ 3,61	M 22 x 2.0	5
E010/M220X250E3	€ 3,61	M 22 x 2.5	5
E010/M240X150E3	€ 4,03	M 24 x 1.5	5
E010/M240X200E3	€ 4,03	M 24 x 2.0	5
E010/M240X300E3	€ 4,03	M 24 x 3.0	5



E010-MXEXA
**INSERTO FILETTATO
AUTOBLOCCANTE INOX**

A sezione romboidale, con forma a molla, che crea due filettature perfettamente concentriche; una esterna che si accoppia con il foro precedentemente filettato con il maschio apposito ed una interna dove si andrà ad avvitare la vite di fissaggio.

INOX

Append.

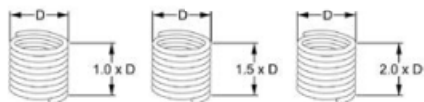

Art.	€	D	Altezza	Pack
E010/M030X050E1A	€ 0,32	M 3 x 0.5	1.0 D	25
E010/M040X070E1A	€ 0,32	M 4 x 0.7	1.0 D	25
E010/M050X080E1A	€ 0,37	M 5 x 0.8	1.0 D	25
E010/M060X100E1A	€ 0,40	M 6 x 1.0	1.0 D	25
E010/M080X125E1A	€ 0,42	M 8 x 1.25	1.0 D	25
E010/M100X150E1A	€ 0,55	M 10 x 1.5	1.0 D	25
E010/M120X175E1A	€ 0,78	M 12 x 1.75	1.0 D	10
E010/M140X200E1A	€ 1,12	M 14 x 2.0	1.0 D	10
E010/M160X200E1A	€ 1,50	M 16 x 2.0	1.0 D	10
E010/M030X050E15A	€ 0,35	M 3 x 0.5	1.5 D	25
E010/M040X070E15A	€ 0,35	M 4 x 0.7	1.5 D	25
E010/M050X080E15A	€ 0,38	M 5 x 0.8	1.5 D	25
E010/M060X100E15A	€ 0,44	M 6 x 1.0	1.5 D	25
E010/M080X125E15A	€ 0,48	M 8 x 1.25	1.5 D	25
E010/M100X150E15A	€ 0,58	M 10 x 1.5	1.5 D	25
E010/M120X175E15A	€ 0,89	M 12 x 1.75	1.5 D	10
E010/M140X200E15A	€ 1,27	M 14 x 2.0	1.5 D	10
E010/M160X200E15A	€ 1,58	M 16 x 2.0	1.5 D	10
E010/M030X050E2A	€ 0,37	M 3 x 0.5	2.0 D	25
E010/M040X070E2A	€ 0,37	M 4 x 0.7	2.0 D	25
E010/M050X080E2A	€ 0,42	M 5 x 0.8	2.0 D	25
E010/M060X100E2A	€ 0,48	M 6 x 1.0	2.0 D	25
E010/M080X125E2A	€ 0,58	M 8 x 1.25	2.0 D	25
E010/M100X150E2A	€ 0,67	M 10 x 1.5	2.0 D	25
E010/M120X175E2A	€ 1,02	M 12 x 1.75	2.0 D	10
E010/M140X200E2A	€ 1,32	M 14 x 2.0	2.0 D	10
E010/M160X200E2A	€ 1,93	M 16 x 2.0	2.0 D	10

E010-BSFXEX
INSERTO FILETTATO INOX BSF H=1,5XD

A sezione romboidale, con forma a molla, che crea due filettature perfettamente concentriche; una esterna che si accoppia con il foro precedentemente filettato con il maschio apposito ed una interna dove si andrà ad avvitare la vite di fissaggio.

INOX

Append.

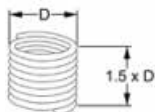

Art.	€	D	Pack
E010/BSF3/16E15	€ 1,06	3/16" x 32	10
E010/BSF1/4E15	€ 0,49	1/4" x 26	10
E010/BSF5/16E15	€ 0,58	5/16" x 22	10
E010/BSF3/8E15	€ 0,90	3/8" x 20	10
E010/BSF7/16E15	€ 1,06	7/16" x 18	10
E010/BSF1/2E15	€ 1,06	1/2" x 16	10
E010/BSF9/16E15	€ 3,65	9/16" x 16	5
E010/BSF5/8E15	€ 3,65	5/8" x 14	5
E010/BSF3/4E15	€ 4,61	3/4" x 12	5
E010/BSF7/8E15	€ 5,80	7/8" x 11	5
E010/BSF1E15	€ 5,80	1" x 10	5

E010-BSWXEX
INSERTO FILETTATO INOX BSW H=1,5XD

A sezione romboidale, con forma a molla, che crea due filettature perfettamente concentriche; una esterna che si accoppia con il foro precedentemente filettato con il maschio apposito ed una interna dove si andrà ad avvitare la vite di fissaggio.

INOX

Append.

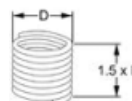

Art.	€	D	Pack
E010/BSW1/8E15	€ 1,06	1/8" x 40	10
E010/BSW3/16E15	€ 1,06	3/16" x 24	10
E010/BSW1/4E15	€ 0,49	1/4" x 20	10
E010/BSW5/16E15	€ 0,58	5/16" x 18	10
E010/BSW3/8E15	€ 0,90	3/8" x 16	10
E010/BSW7/16E15	€ 1,06	7/16" x 14	10
E010/BSW1/2E15	€ 1,06	1/2" x 12	10
E010/BSW9/16E15	€ 3,36	9/16" x 12	5
E010/BSW5/8E15	€ 3,36	5/8" x 11	5
E010/BSW3/4E15	€ 3,84	3/4" x 10	5
E010/BSW7/8E15	€ 5,80	7/8" x 9	5
E010/BSW1E15	€ 6,20	1" x 8	5

E010-UNCXEX
INSERTO FILETTATO INOX UNC H=1,5XD

A sezione romboidale, con forma a molla, che crea due filettature perfettamente concentriche; una esterna che si accoppia con il foro precedentemente filettato con il maschio apposito ed una interna dove si andrà ad avvitare la vite di fissaggio.

INOX

Append.

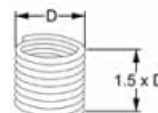

Art.	€	D	Pack
E010/UNC1/4E15	€ 0,46	1/4" x 20	10
E010/UNC5/16E15	€ 0,65	5/16" x 18	10
E010/UNC3/8E15	€ 0,85	3/8" x 16	10
E010/UNC7/16E15	€ 1,13	7/16" x 14	10
E010/UNC1/2E15	€ 1,13	1/2" x 13	10
E010/UNC9/16E15	€ 1,22	9/16" x 12	5
E010/UNC5/8E15	€ 2,44	5/8" x 11	5
E010/UNC3/4E15	€ 3,45	3/4" x 10	5
E010/UNC7/8E15	€ 5,20	7/8" x 9	5

E010-UNFEXX
INSERTO FILETTATO INOX UNF H=1,5XD

A sezione romboidale, con forma a molla, che crea due filettature perfettamente concentriche; una esterna che si accoppia con il foro precedentemente filettato con il maschio apposito ed una interna dove si andrà ad avvitare la vite di fissaggio.

INOX

Append.

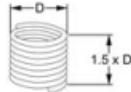

Art.	€	D	Pack
E010/UNFN04E15	€ 1,04	No. 4 x 48	10
E010/UNFN10E15	€ 0,41	No. 10 x 32	10
E010/UNF1/4E15	€ 0,41	1/4" x 28	10
E010/UNF5/16E15	€ 0,59	5/16" x 24	10
E010/UNF3/8E15	€ 0,85	3/8" x 24	10
E010/UNF7/16E15	€ 1,13	7/16" x 20	10
E010/UNF1/2E15	€ 1,13	1/2" x 20	10
E010/UNF9/16E15	€ 2,36	9/16" x 18	5
E010/UNF5/8E15	€ 2,36	5/8" x 18	5
E010/UNF3/4E15	€ 2,36	3/4" x 16	5
E010/UNF7/8E15	€ 6,10	7/8" x 14	5
E010/UNF1E15	€ 6,10	1" x 12	5

E011-MXM
MASCHI METRICI STI PER F-COIL

Tipo speciale per creazione sede alloggiamento inserto filettato.



Scatola

HSS-G

Acciaio



Alluminio



Leghe non ferrose



Ghisa



Olio



Tornio



Fresatrice



Utilizzo Manuale

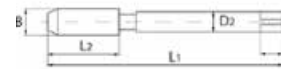

Art.	€	Misura	B	L1	L2	D2	C
E011/M020X040M	€ 10,90	M 2 x 0.40	2.5 mm	44.5 mm	9.5 mm	2.8 mm	2.24 mm
E011/M025X045M	€ 10,90	M 2.5 x 0.45	3.1 mm	48.0 mm	11.0 mm	3.15 mm	2.5 mm
E011/M030X050M	€ 10,90	M 3 x 0.5	3.6 mm	53.0 mm	13.0 mm	4.0 mm	3.15 mm
E011/M035X060M	€ 10,90	M 3.5 x 0.6	4.3 mm	53.0 mm	13.0 mm	4.5 mm	3.55 mm
E011/M040X070M	€ 10,90	M 4 x 0.7	4.9 mm	58 mm	16.0 mm	5.0 mm	4.00 mm
E011/M050X080M	€ 10,90	M 5 x 0.8	6.0 mm	66.0 mm	19.0 mm	6.3 mm	5.00 mm
E011/M060X100M	€ 10,90	M 6 x 1.0	7.3 mm	72.0 mm	22.0 mm	8.0 mm	6.30 mm
E011/M070X100M	€ 12,70	M 7 x 1.0	8.3 mm	72.0 mm	22.0 mm	9.0 mm	7.10 mm
E011/M080X100M	€ 12,70	M 8 x 1.0	9.3 mm	80.0 mm	24.0 mm	10.0 mm	8.00 mm
E011/M080X125M	€ 12,70	M 8 x 1.25	9.6 mm	80.0 mm	24.0 mm	8.0 mm	8.00 mm
E011/M090X100M	€ 14,50	M 9 x 1.0	10.6 mm	85.0 mm	25.0 mm	8.0 mm	6.30 mm
E011/M090X125M	€ 14,50	M 9 x 1.25	10.6 mm	85.0 mm	25.0 mm	8.0 mm	6.30 mm
E011/M100X100M	€ 14,50	M 10 x 1.0	11.3 mm	85.0 mm	25.0 mm	8.0 mm	6.30 mm
E011/M100X125M	€ 14,50	M 10 x 1.25	11.6 mm	85.0 mm	25.0 mm	8.0 mm	6.30 mm
E011/M100X150M	€ 14,50	M 10 x 1.5	11.9 mm	89.0 mm	29.0 mm	9.0 mm	7.10 mm
E011/M110X150M	€ 19,00	M 11 x 1.5	12.9 mm	89.0 mm	29.0 mm	9.0 mm	7.10 mm
E011/M120X100M	€ 19,00	M 12 x 1.0	13.3 mm	95.0 mm	30.0 mm	11.2 mm	9.00 mm
E011/M120X125M	€ 20,00	M 12 x 1.25	13.6 mm	95.0 mm	30.0 mm	11.2 mm	9.00 mm
E011/M120X150M	€ 20,00	M 12 x 1.5	14.0 mm	95.0 mm	30.0 mm	11.2 mm	9.00 mm

Art.	€	Misura	B	L1	L2	D2	C
E011/M120X175M	€ 20,00	M 12 x 1.75	14.3 mm	95.0 mm	30.0 mm	11.2 mm	9.00 mm
E011/M140X100M	€ 22,70	M 14 x 1.0	15.3 mm	102.0 mm	32.0 mm	12.5 mm	10.00 mm
E011/M140X125M	€ 22,70	M 14 x 1.25	15.6 mm	102.0 mm	32.0 mm	12.5 mm	10.00 mm
E011/M140X150M	€ 22,70	M 14 x 1.5	16.0 mm	102.0 mm	32.0 mm	12.5 mm	10.00 mm
E011/M140X200M	€ 22,70	M 14 x 2.0	16.6 mm	102.0 mm	32.0 mm	12.5 mm	10.00 mm
E011/M160X150M	€ 28,10	M 16 x 1.5	18.0 mm	104.0 mm	29.0 mm	14.0 mm	11.20 mm
E011/M160X200M	€ 28,10	M 16 x 2.0	18.6 mm	112.0 mm	37.0 mm	14.0 mm	11.20 mm
E011/M180X150M	€ 29,90	M 18 x 1.5	20.0 mm	104.0 mm	29.0 mm	14.0 mm	11.20 mm
E011/M180X200M	€ 29,90	M 18 x 2.0	20.6 mm	104.0 mm	29.0 mm	14.0 mm	11.20 mm
E011/M180X250M	€ 29,90	M 18 x 2.5	21.3 mm	118.0 mm	38.0 mm	16.0 mm	12.50 mm
E011/M200X150M	€ 33,50	M 20 x 1.5	22.0 mm	113.0 mm	33.0 mm	16.0 mm	12.50 mm
E011/M200X200M	€ 33,50	M 20 x 2.0	22.6 mm	113.0 mm	33.0 mm	16.0 mm	12.50 mm
E011/M200X250M	€ 33,50	M 20 x 2.5	23.3 mm	118.0 mm	38.0 mm	16.0 mm	12.50 mm
E011/M220X150M	€ 42,60	M 22 x 1.5	24.0 mm	120.0 mm	35.0 mm	18.0 mm	14.00 mm
E011/M220X200M	€ 42,60	M 22 x 2.0	24.6 mm	120.0 mm	35.0 mm	18.0 mm	14.00 mm
E011/M220X250M	€ 42,60	M 22 x 2.5	25.3 mm	130.0 mm	45.0 mm	18.0 mm	14.00 mm
E011/M240X150M	€ 45,50	M 24 x 1.5	26.0 mm	120.0 mm	35.0 mm	18.0 mm	14.00 mm
E011/M240X200M	€ 45,50	M 24 x 2.0	26.6 mm	127.0 mm	37.0 mm	20.0 mm	16.00 mm
E011/M240X300M	€ 45,50	M 24 x 3.0	27.9 mm	138.0 mm	48.0 mm	20.0 mm	16.00 mm



E011-MXMC

MASCHIO COMBINATO METRICO STI PER F-COIL

Tipo speciale per creazione sede alloggiamento inserto filettato.



Art.	€	Misura	B1	B2	L3	L2	L1	D2	C
E011/M060X100MC	€ 15,40	M 6 x 1.0	7.3 mm	6 mm	7 mm	28 mm	70 mm	8 mm	6.3 mm
E011/M080X125MC	€ 15,40	M 8 x 1.25	9.6 mm	8 mm	9 mm	32 mm	75 mm	8 mm	6.3 mm
E011/M100X100MC	€ 21,80	M 10 x 1.0	11.3 mm	10 mm	8 mm	30 mm	74 mm	8 mm	6.3 mm
E011/M100X125MC	€ 21,80	M 10 x 1.25	11.6 mm	10 mm	8 mm	30 mm	74 mm	8 mm	6.3 mm
E011/M100X150MC	€ 21,80	M 10 x 1.5	11.9 mm	10 mm	9 mm	37 mm	80 mm	9 mm	7.1 mm
E011/M120X125MC	€ 28,10	M 12 x 1.25	13.6 mm	12 mm	9 mm	32 mm	75 mm	9 mm	7.1 mm
E011/M140X125MC	€ 30,90	M 14 x 1.25	15.6 mm	14 mm	10 mm	45 mm	90 mm	12 mm	9.2 mm
E011/M180X150MC	€ 45,50	M 18 x 1.25	20.0 mm	18 mm	10 mm	47 mm	116 mm	16 mm	12.5 mm



E011-BSWXM

MASCHI BSW STI PER F-COIL

Tipo speciale per creazione sede alloggiamento inserto filettato.



Art.	€	Misura	B	L1	L2	D2	C
E011/BSW1/8M	€ 10,10	1/8" x 40	3.9 mm	53.0 mm	13.0 mm	4.0 mm	3.15 mm
E011/BSW3/16M	€ 10,10	3/16" x 24	6.0 mm	56.0 mm	19.0 mm	6.3 mm	5.00 mm
E011/BSW1/4M	€ 10,10	1/4" x 20	7.8 mm	72.0 mm	22.0 mm	8.0 mm	6.30 mm
E011/BSW5/16M	€ 10,90	5/16" x 18	9.6 mm	80.0 mm	24.0 mm	10.0 mm	8.00 mm
E011/BSW3/8M	€ 11,80	3/8" x 16	11.4 mm	85.0 mm	25.0 mm	8.0 mm	6.30 mm
E011/BSW7/16M	€ 12,70	7/16" x 14	13.2 mm	95.0 mm	30.0 mm	11.2 mm	9.00 mm
E011/BSW1/2M	€ 14,10	1/2" x 12	15.2 mm	102.0 mm	32.0 mm	12.5 mm	10.00 mm
E011/BSW9/16M	€ 21,20	9/16" x 12	16.8 mm	102.0 mm	32.0 mm	12.5 mm	10.00 mm
E011/BSW5/8M	€ 26,00	5/8" x 11	18.6 mm	112.0 mm	37.0 mm	14.0 mm	11.20 mm
E011/BSW3/4M	€ 31,50	3/4" x 10	22.0 mm	118.0 mm	38.0 mm	16.0 mm	12.50 mm
E011/BSW7/8M	€ 42,50	7/8" x 9	25.5 mm	130.0 mm	45.0 mm	18.0 mm	14.00 mm
E011/BSW1M	€ 42,50	1" x 8	29.1 mm	138.0 mm	48.0 mm	20.0 mm	16.0 mm

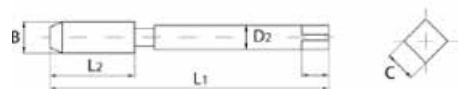

E011-BSFXM

MASCHI BSF STI PER F-COIL

Tipo speciale per creazione sede alloggiamento inserto filettato.



Art.	€	Misura	B	L1	L2	D2	C
E011/BSF3/16M	€ 10,10	3/16" x 32	5.7 mm	66.0 mm	19.0 mm	6.3 mm	5.00 mm
E011/BSF1/4M	€ 10,10	1/4" x 26	7.5 mm	72.0 mm	22.0 mm	8.0 mm	6.30 mm
E011/BSF5/16M	€ 10,90	5/16" x 22	9.3 mm	80.0 mm	24.0 mm	10.0 mm	8.00 mm
E011/BSF3/8M	€ 11,80	3/8" x 20	11.0 mm	85.0 mm	25.0 mm	8.0 mm	6.30 mm
E011/BSF7/16M	€ 12,70	7/16" x 18	12.8 mm	89.0 mm	29.0 mm	9.0 mm	7.10 mm
E011/BSF1/2M	€ 14,10	1/2" x 16	14.6 mm	95.0 mm	30.0 mm	11.2 mm	9.00 mm
E011/BSF9/16M	€ 21,20	9/16" x 16	16.2 mm	102.0 mm	32.0 mm	12.5 mm	10.00 mm
E011/BSF5/8M	€ 26,00	5/8" x 14	18.0 mm	112.0 mm	37.0 mm	14.0 mm	11.20 mm
E011/BSF3/4M	€ 31,50	3/4" x 12	21.5 mm	118.0 mm	38.0 mm	16.0 mm	12.5 mm
E011/BSF7/8M	€ 42,50	7/8" x 11	24.9 mm	130.0 mm	45.0 mm	18.0 mm	14.00 mm
E011/BSF1M	€ 42,50	1" x 10	28.4 mm	138.0 mm	48.0 mm	20.0 mm	16.00 mm

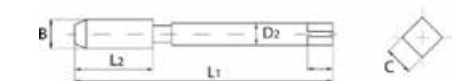

E011-UNCXM
MASCHI UNC STI PER F-COIL

Tipo speciale per creazione sede alloggiamento inserto filettato.



Art.	€	Misura	B	L1	L2	D2	C
E011/UNC1/4M	€ 10,10	1/4" x 20	8.0 mm	72.0 mm	22.0 mm	8.0 mm	6.30 mm
E011/UNC5/16M	€ 10,90	5/16" x 18	9.8 mm	80.0 mm	24.0 mm	10.0 mm	8.00 mm
E011/UNC3/8M	€ 11,80	3/8" x 16	11.6 mm	85.0 mm	25.0 mm	8.0 mm	6.30 mm
E011/UNC7/16M	€ 12,70	7/16" x 14	13.5 mm	95.0 mm	30.0 mm	11.2 mm	10.00 mm
E011/UNC1/2M	€ 14,10	1/2" x 13	15.2 mm	102.0 mm	32.0 mm	12.5 mm	10.00 mm
E011/UNC9/16M	€ 21,20	9/16" x 12	17.0 mm	112.0 mm	37.0 mm	14.0 mm	11.20 mm
E011/UNC5/8M	€ 24,00	5/8" x 11	18.9 mm	112.0 mm	37.0 mm	14.0 mm	11.20 mm
E011/UNC3/4M	€ 31,50	3/4" x 10	22.4 mm	118.0 mm	38.0 mm	16.0 mm	12.50 mm
E011/UNC7/8M	€ 42,50	7/8" x 9	25.9 mm	130.0 mm	45.0 mm	18.0 mm	14.00 mm

E011-UNFXM
MASCHI UNF STI PER F-COIL

Tipo speciale per creazione sede alloggiamento inserto filettato.



Art.	€	Misura	B	L1	L2	D2	C
E011/UNFN04M	€ 12,70	No. 4 x 48	3.5 mm	53.0 mm	13.0 mm	4.0 mm	3.15 mm
E011/UNFN10M	€ 12,70	No. 10 x 32	5.9 mm	66.0 mm	19.0 mm	6.3 mm	5.00 mm
E011/UNF1/4M	€ 10,10	1/4" x 28	7.5 mm	69.0 mm	19.0 mm	8.0 mm	6.30 mm
E011/UNF5/16M	€ 10,90	5/16" x 24	9.3 mm	76.0 mm	20.0 mm	10.0 mm	8.00 mm
E011/UNF3/8M	€ 11,80	3/8" x 24	10.9 mm	82.0 mm	22.0 mm	8.0 mm	6.3 mm
E011/UNF7/16M	€ 12,70	7/16" x 20	12.8 mm	84.0 mm	24.0 mm	9.0 mm	7.10 mm
E011/UNF1/2M	€ 14,10	1/2" x 20	14.4 mm	90.0 mm	25.0 mm	11.2 mm	9.00 mm
E011/UNF9/16M	€ 21,20	9/16" x 18	16.1 mm	104.0 mm	29.0 mm	12.5 mm	10.00 mm
E011/UNF5/8M	€ 26,00	5/8" x 18	17.7 mm	104.0 mm	29.0 mm	14.0 mm	11.20 mm
E011/UNF3/4M	€ 31,50	3/4" x 16	21.1 mm	104.0 mm	29.0 mm	14.0 mm	11.20 mm
E011/UNF7/8M	€ 42,50	7/8" x 14	24.6 mm	120.0 mm	35.0 mm	18.0 mm	14.00 mm
E011/UNF112M	€ 42,50	1" x 12	28.2 mm	127.0 mm	37.0 mm	20.0 mm	16.00 mm

E011-UMX
UTENSILE ESAGONALE MONTAGGIO F-COIL

Art.	€	Diametro	Attacco esagonale
E011/UM260X150	€ 26,30	M 26 x 1.5	1/2"
E011/UM270X150	€ 26,30	M 27 x 1.5	1/2"
E011/UM270X200	€ 26,30	M 27 x 2.0	1/2"
E011/UM270X300	€ 26,30	M 27 x 3.0	1/2"
E011/UM280X150	€ 26,30	M 28 x 1.5	1/2"
E011/UM300X150	€ 29,30	M 30 x 1.5	1/2"
E011/UM300X200	€ 29,30	M 30 x 2.0	1/2"
E011/UM300X350	€ 29,30	M 30 x 3.5	1/2"
E011/UM330X200	€ 36,30	M 33 x 2.0	1/2"
E011/UM330X350	€ 36,30	M 33 x 3.5	1/2"
E011/UM360X150	€ 36,30	M 36 x 1.5	1/2"
E011/UM360X200	€ 36,30	M 36 x 2.0	1/2"
E011/UM360X300	€ 36,30	M 36 x 3.0	1/2"
E011/UM360X400	€ 36,30	M 36 x 4.0	1/2"



E011-UX
UTENSILE MONTAGGIO F-COIL

Art.	€	Metrici	Pollici
E011/U02	€ 7,80	M 2 x 0.4 - M 2.2 x 0.45	UNC N02
E011/U03	€ 7,80	M 2.5 x 0.45	-
E011/U04	€ 7,80	M 3 x 0.5	UNC N05 - UNC/UNF N04 - BSW 1/8"
E011/U05	€ 7,80	M 3.5 x 0.6	UNC/UNF N06
E011/U06	€ 7,80	M 4 x 0.7	UNC/UNF N08
E011/U08	€ 7,80	M 5 x 0.8	UNF N10 - UNC N12 - BSF 3/16"
E011/U09	€ 7,80	M 6 x 1.0	UNC/UNF 1/4" - BSW/BSF 1/4"
E011/U10	€ 7,80	M 7 x 1.0	UNC/BSW 5/16"
E011/U11	€ 8,60	M 8 x 1.25 - M 8 x 1.0	UNF/BSF 5/16"
E011/U12	€ 13,10	M 9 x 1.25 - M 9 x 1.0	UNC/BSW 3/8"
E011/U13	€ 13,10	M 10 x 1.5 - M 10 x 1.0 - M 10 x 1.25	UNF/BSF 3/8"
E011/U14	€ 14,20	M 11 x 1.5	UNC/UNF 7/16" - BSW-BSF 7/16"
E011/U15	€ 14,20	M 12 x 1.75 - M 12 x 1.5 - M 12 x 1.25 - M 12 x 1.0	UNC/UNF 1/2" - BSW-BSF 1/2"
E011/U16	€ 16,20	M 14 x 2.0 - M 14 x 1.5	UNC/UNF 9/16" - BSW-BSF 9/16"
E011/U17	€ 16,20	M 14 x 1.25 - M 14 x 1.0	-
E011/U18	€ 17,60	M 16 x 2.0 - M 16 x 1.5	UNC/UNF 5/8" - BSW-BSF 5/8"
E011/U20	€ 17,60	M 18 x 2.5 - M 18 x 2.0 - M 18 x 1.5	UNC 3/4" - BSW-BSF 3/4"
E011/U21	€ 17,60	M 20 x 2.5 - M 20 x 2.0 - M 20 x 1.5	UNF 3/4"
E011/U22	€ 22,30	M 22 x 2.5 - M 22 x 2.0 - M 22 x 1.5	UNC/UNF 7/8" - BSW-BSF 7/8"
E011/U23	€ 22,30	M 24 x 3.0 - M 24 x 2.0 - M 24 x 1.5	UNC/UNF 1" - BSW-BSF 1"

E011-EX
ESTRATTORE F-COIL

Art.	€	Metrici	Pollici
E011/E2	€ 16,40	M 3 - M 10	3/16" - 3/8"
E011/E3	€ 20,00	M 11 - M 25	3/8" - 1"

E011-AX
ATTREZZO PER ROTTURA CODOLO F-COIL

Art.	€	Metrici	Pollici
E011/A02	€ 2,53	M 2 x 0.4 - M 2.2 x 0.45	UNC N02
E011/A03	€ 2,53	M 2.5 x 0.45	-
E011/A04	€ 2,53	M 3 x 0.5	UNC/UNF N04
E011/A05	€ 2,53	M 3.5 x 0.6	UNC/UNF N06
E011/A06	€ 2,53	M 4 x 0.7	UNC N10 - UNC/UNF N08 - BSF 3/16"
E011/A08	€ 2,53	M 5 x 0.8	UNF N10 - UNC N12 - BSF 3/16"
E011/A09	€ 2,53	M 6 x 1.0	UNC/UNF 1/4" - BSW/BSF 1/4"
E011/A11	€ 2,85	M 7 x 1.0 - M 8 x 1.0 - M 8 x 1.25	UNC/UNF 5/16" - BSW/BSF 5/16"
E011/A12	€ 2,85	M 9 x 1.0 - M 9 x 1.25	UNC 3/8" - BSW/BSF 3/8"
E011/A13	€ 2,85	M 10 x 1.5 - M 10 x 1.0 - M 10 x 1.25	UNF 3/8"
E011/A14	€ 3,43	M 11 x 1.5	UNC/UNF 7/16" - BSW/BSF 7/16"
E011/A15	€ 3,43	M 12 x 1.5 - M 12 x 1.0 - M 12 x 1.25 - M 12 x 1.75	UNC/UNF 1/2" - BSW/BSF 1/2"



LBX
NEW
LAME A NASTRO BIMETALLICHE PER METALLO

Saldate in lunghezza standard.



Art.	€	Misure	Specifiche	Passo
LB01/1140	€ 18,00	1140 x 13 x 0.65 mm	T 8 / 12 Bi-Metal	Variabile
LB01/1325	€ 19,80	1325 x 13 x 0.65 mm	T 8 / 12 Bi-Metal	Variabile
LB01/1335	€ 20,10	1335 x 13 x 0.65 mm	T 8 / 12 Bi-Metal	Variabile
LB01/1435	€ 21,10	1435 x 13 x 0.65 mm	T 8 / 12 Bi-Metal	Variabile
LB01/1440	€ 21,10	1440 x 13 x 0.65 mm	T 8 / 12 Bi-Metal	Variabile
LB01/1638	€ 23,20	1638 x 13 x 0.65 mm	T 8 / 12 Bi-Metal	Variabile
LB01/1735	€ 24,40	1735 x 13 x 0.65 mm	T 8 / 12 Bi-Metal	Variabile
LB02/1140	€ 18,00	1140 x 13 x 0.65 mm	T 6 Bi-Metal	Fisso
LB02/1435	€ 21,10	1435 x 13 x 0.65 mm	T 6 Bi-Metal	Fisso
LB05/1735	€ 25,10	1735 x 13 x 0.9 mm	T 8 / 12 Bi-Metal	Variabile
LB07/2000	€ 29,40	2000 x 20 x 0.9 mm	T 8 / 12 Bi-Metal	Variabile
LB07/2080	€ 30,20	2080 x 20 x 0.9 mm	T 8 / 12 Bi-Metal	Variabile
LB07/2100	€ 30,50	2100 x 20 x 0.9 mm	T 8 / 12 Bi-Metal	Variabile
LB07/2140	€ 31,00	2140 x 20 x 0.9 mm	T 8 / 12 Bi-Metal	Variabile
LB07/2160	€ 31,30	2160 x 20 x 0.9 mm	T 8 / 12 Bi-Metal	Variabile
LB08/2000	€ 29,40	2000 x 20 x 0.9 mm	T 5 / 7 Bi-Metal	Variabile
LB08/2080	€ 30,20	2080 x 20 x 0.9 mm	T 5 / 7 Bi-Metal	Variabile
LB08/2100	€ 30,50	2100 x 20 x 0.9 mm	T 5 / 7 Bi-Metal	Variabile
LB08/2140	€ 31,00	2140 x 20 x 0.9 mm	T 5 / 7 Bi-Metal	Variabile
LB08/2160	€ 31,30	2160 x 20 x 0.9 mm	T 5 / 7 Bi-Metal	Variabile
LB09/2375	€ 33,70	2375 x 27 x 0.9 mm	T 8 / 11 Bi-Metal	Variabile
LB09/2450	€ 36,00	2450 x 27 x 0.9 mm	T 8 / 11 Bi-Metal	Variabile
LB09/2500	€ 37,40	2500 x 27 x 0.9 mm	T 8 / 11 Bi-Metal	Variabile

Art.	€	Misure	Specifiche	Passo
LB09/2720	€ 45,00	2720 x 27 x 0.9 mm	T 8 / 11 Bi-Metal	Variabile
LB09/2750	€ 40,60	2750 x 27 x 0.9 mm	T 8 / 11 Bi-Metal	Variabile
LB09/2825	€ 41,60	2825 x 27 x 0.9 mm	T 8 / 11 Bi-Metal	Variabile
LB09/2845	€ 41,80	2845 x 27 x 0.9 mm	T 8 / 11 Bi-Metal	Variabile
LB09/2945	€ 43,10	2945 x 27 x 0.9 mm	T 8 / 11 Bi-Metal	Variabile
LB09/2950	€ 43,30	2950 x 27 x 0.9 mm	T 8 / 11 Bi-Metal	Variabile
LB09/3010	€ 44,00	3010 x 27 x 0.9 mm	T 8 / 11 Bi-Metal	Variabile
LB09/3100	€ 45,00	3100 x 27 x 0.9 mm	T 8 / 11 Bi-Metal	Variabile
LB09/3120	€ 45,50	3120 x 27 x 0.9 mm	T 8 / 11 Bi-Metal	Variabile
LB09/3150	€ 45,70	3150 x 27 x 0.9 mm	T 8 / 11 Bi-Metal	Variabile
LB10/2375	€ 33,70	2375 x 27 x 0.9 mm	T 5 / 7 Bi-Metal	Variabile
LB10/2450	€ 36,00	2450 x 27 x 0.9 mm	T 5 / 7 Bi-Metal	Variabile
LB10/2500	€ 37,40	2500 x 27 x 0.9 mm	T 5 / 7 Bi-Metal	Variabile
LB11/2720	€ 45,00	2720 x 27 x 0.9 mm	T 5 / 7 Bi-Metal	Variabile
LB10/2750	€ 40,60	2750 x 27 x 0.9 mm	T 5 / 7 Bi-Metal	Variabile
LB10/2825	€ 41,60	2825 x 27 x 0.9 mm	T 5 / 7 Bi-Metal	Variabile
LB10/2845	€ 41,80	2845 x 27 x 0.9 mm	T 5 / 7 Bi-Metal	Variabile
LB10/2945	€ 43,10	2945 x 27 x 0.9 mm	T 5 / 7 Bi-Metal	Variabile
LB10/2950	€ 43,30	2950 x 27 x 0.9 mm	T 5 / 7 Bi-Metal	Variabile
LB10/3010	€ 44,00	3010 x 27 x 0.9 mm	T 5 / 7 Bi-Metal	Variabile
LB10/3100	€ 45,00	3100 x 27 x 0.9 mm	T 5 / 7 Bi-Metal	Variabile
LB10/3120	€ 45,50	3120 x 27 x 0.9 mm	T 5 / 7 Bi-Metal	Variabile
LB10/3150	€ 45,70	3150 x 27 x 0.9 mm	T 5 / 7 Bi-Metal	Variabile

N7X
LAMA PER LEGNO

Lama per taglio sagomato di legno sottile.



Art.	€	Misure	Specifiche
N194	€ 24,40	1400 x 6 x 0.36 mm	T6
N717/N	€ 24,40	1430 x 6 x 0.36 mm	T6
N188	€ 28,80	1790 x 6 x 0.36 mm	T10
N190	€ 28,80	1826 x 6 x 0.36 mm	T10
N855/N2	€ 27,60	2240 x 13 x 0.65 mm	T8
N186	€ 24,70	2400 x 13 x 0.65 mm	T8
N192	€ 24,70	2560 x 13 x 0.65 mm	T8
N764/N2	€ 27,60	2950 x 13 x 0.65 mm	T6
N764/455/N2	€ 38,40	3430 x 16 x 0.65 mm	T6

N7X1
LAME PER LEGNO

Lama per il taglio dritto di legno spesso.



Art.	€	Misure	Specifiche
N195	€ 24,40	1400 x 10 x 0.36 mm	T6
N717/N1	€ 24,40	1430 x 10 x 0.36 mm	T6
N189	€ 28,80	1790 x 10 x 0.36 mm	T6
N191	€ 28,80	1826 x 10 x 0.36 mm	T6
N855/N	€ 27,60	2240 x 16 x 0.65 mm	T4
N187	€ 24,70	2400 x 16 x 0.65 mm	T4
N193	€ 24,70	2560 x 16 x 0.65 mm	T4
N764/N	€ 27,60	2950 x 16 x 0.65 mm	T4
N764/455/N	€ 38,40	3430 x 20 x 0.65 mm	T4



LSL76-20

€ 3,80 **NEW**

SET LAME PER SEGHETTO ALTERNATIVO



Lunghezza	76 mm
Profondità di taglio	51 mm
Spessore	2 mm

LSM76-12

€ 5,40 **NEW**

SET LAME PER SEGHETTO ALTERNATIVO

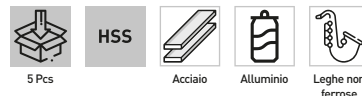

Lunghezza	76 mm
Profondità di taglio	51 mm
Spessore	1,2 mm

07X

NEW

DISCHI PER LEGNO CON RIPORTO IN METALLO DURO

Dentatura alternata universale.

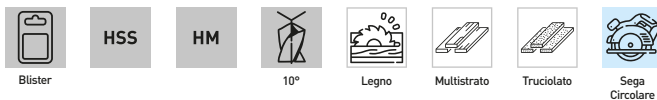

Art.	€	Ø	Denti Z	Foro	Spessore taglio	Spessore disco	Max rpm
0735	€ 14,00	190 mm	24	Ø 20 mm	2,2 mm	1,5 mm	8000
0736	€ 19,00	190 mm	48	Ø 20 mm	2,2 mm	1,5 mm	8000
0685	€ 30,90	254 mm	24	Ø 30 mm	3,2 mm	2,2 mm	6300
0702	€ 51,70	250 mm	60	Ø 30 mm	3,2 mm	2,2 mm	7000
0703	€ 59,50	250 mm	80	Ø 30 mm	3,2 mm	2,2 mm	7000
0704	€ 76,40	300 mm	72	Ø 30 mm	3,2 mm	2,2 mm	6000
0705	€ 82,50	300 mm	96	Ø 30 mm	3,2 mm	2,2 mm	6000
0899	€ 57,00	315 mm	25	Ø 30 mm	2,8 mm	1,8 mm	6000
0745	€ 93,70	350 mm	54	Ø 30 mm	3,5 mm	2,5 mm	5000
0707	€ 95,10	400 mm	48	Ø 30 mm	3,5 mm	2,5 mm	4500
0746	€ 164,00	450 mm	60	Ø 30 mm	4 mm	3,0 mm	4000

0762-

NEW

DISCO PER ALLUMINIO E MATERIALI PLASTICI CON RIPORTO IN METALLO DURO

Dentatura trapezoidale piatta con affilatura alternata.

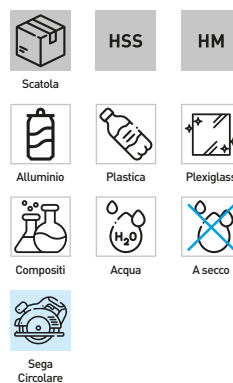

Art.	€	Ø	Denti Z	Foro	Spessore taglio	Spessore disco	Max rpm
0762/190	€ 19,90	190 mm	48	Ø 20 mm	2,2 mm	1,5 mm	8000
0762/250	€ 61,00	250 mm	60	Ø 32 mm	3,2 mm	2,8 mm	7000
0762/300	€ 77,00	300 mm	72	Ø 32 mm	3,2 mm	2,8 mm	6000



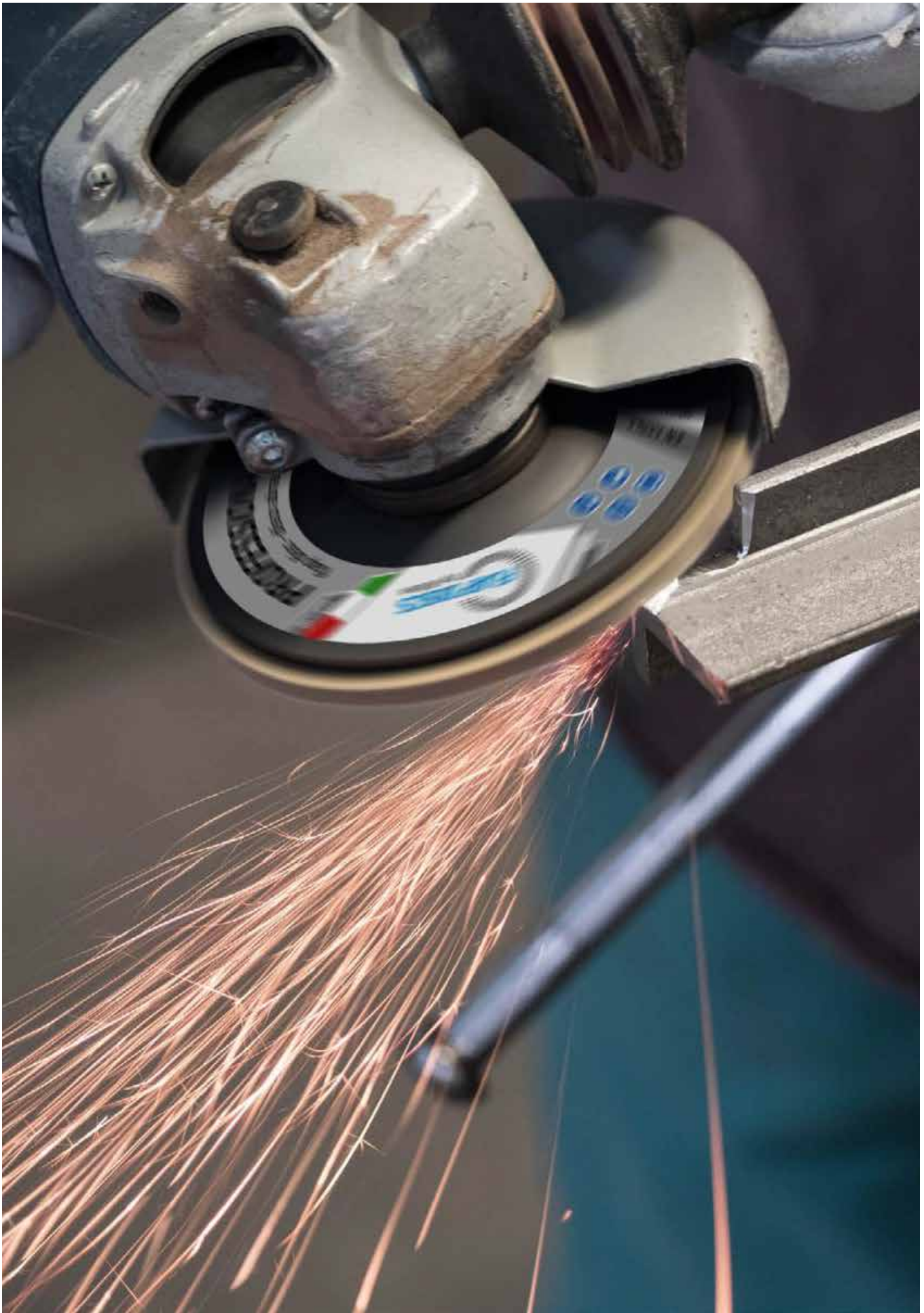



DISCHI LAMELLARI

- p. 256  Professional
- p. 260  Performance
- p. 264  Grindflex
- p. 268  Smartflex
- p. 271  Specialty
- p. 275  Fast Lock



PULITURA

- p. 291  Surface Conditioning
- p. 293  Nylon abrasivo
- p. 294  Non woven



FINITURA E LUCIDATURA

- p. 295  Feltro e paste abrasive
- p. 297  Sisal, cotone e lana
- p. 300  Spugne e gomme abrasive



MOLE E DISCHI DA TAGLIO

- p. 307  Dischi da taglio
- p. 310  Dischi da sbavo
- p. 311  Mole abrasive con foro
- p. 312  Mole abrasive con gambo
- p. 313  Dischi diamantati



RUOTE ABRASIVE

- p. 276  Ruote con gambo
- p. 277  Ruote con foro
- p. 278  Ruote per satinatrici



SPAZZOLE A FILO

- p. 301  Spazzole con foro
- p. 303  Spazzole con gambo



DISCHI E NASTRI ABRASIVI

- p. 281  Dischi in fibra
- p. 282  Dischi adesivi e velcrati
- p. 286  Rotoli e fogli
- p. 290  Nastri

RIFLEX, SPECIFICA ESPERIENZA



MADE IN ITALY

A partire dal 1982 Riflex si distingue sullo scenario internazionale per la specifica esperienza MADE IN ITALY sia nella produzione di dischi lamellari in corindone, zirconio e zirconio ceramicato con supporti sia in nylon che in fibra di vetro, sia nella realizzazione di impianti automatici per la loro produzione, testing e confezionamento.

Riflex supervisiona l'intera filiera produttiva attraverso rapporti decennali con i principali fornitori di materie prime (tela abrasiva, supporti e colla). L'esperienza ultra trentennale ha consentito di sviluppare proprie ricette e protocolli qualitativi ai massimi livelli nel mondo.

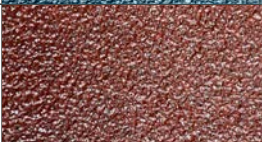
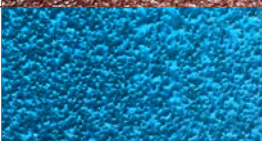

TELE ABRASIVE

		Zirconio Cotone	Per acciai comuni, legati ed inossidabili. Supporto in cotone, ottima prestazione e durata. Questa tela è declinata in vari step di performance in base alle famiglie di prodotto.
		Corindone Cotone	Per metalli e legno, per lavorazioni standard. Supporto in cotone. Questa tela è declinata in vari step di performance in base alle famiglie di prodotto.
SPECIALITY		Zircoceramico Polycotton	Studiato appositamente per la lavorazione di acciaio inossidabile. Terzo strato raffreddante, supporto in polycotton, alta velocità di taglio.
SPECIALITY		Ceramico Polycotton	Studiato appositamente per la lavorazione di acciaio inossidabile, per forti asportazioni. Terzo strato raffreddante, supporto in polycotton estremamente resistente, massima velocità di taglio.
SPECIALITY		Abranet® Rete in poliammide	Studiato appositamente per materiali intasanti come i metalli non ferrosi (alluminio, rame, ottone, zinco, magnesio), legno e materiali compositi. La particolare struttura a rete poliammidica impedisce la formazione di accumuli e intasamenti, assicurando grandi vantaggi: finiture impeccabili ed efficacia costante massimizzando il rendimento e riducendo i costi di lavorazione.



DISCHI LAMELLARI

FERVI BY RIFLEX



PROFESSIONAL

LA SCELTA DEGLI UTENTI PIÙ ESIGENTI

Disco professionale di lunga durata ed elevata velocità di asportazione per gli utenti più esigenti, realizzati esclusivamente con tela Norton™.



PERFORMANCE

LA PRESTAZIONE SENZA IL BLASONE

Ampia gamma di dischi lamellari professionali con tele in Zirconio e Ossido di Alluminio.



GRINDFLEX

IL DISCO PIÙ VERSATILE

Il "best seller", adatto per asportazioni massive e finitura e per lavorazioni su tutti i tipi di metalli, ferrosi e non ferrosi.



SMARTFLEX

VALUE FOR MONEY

Il miglior prezzo senza rinunciare alle prestazioni professionali. Per lavorazioni di asportazione e finitura.



SPECIALTY

PER LAVORAZIONI "SPECIALI"

Gamma di dischi per lavorazioni professionali su acciaio Inox, metalli non ferrosi (Alluminio, Rame, ecc.).

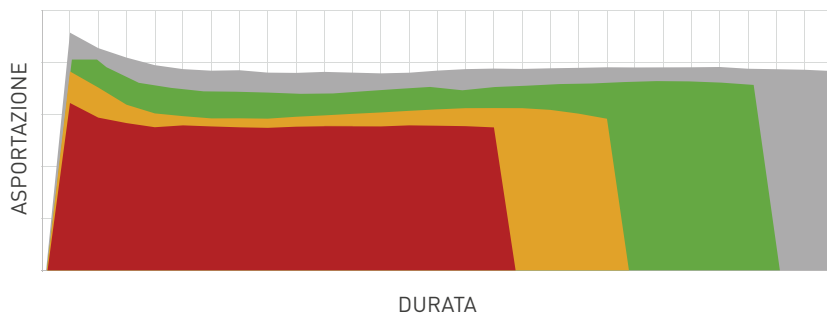

I nostri test sono effettuati con macchine Riflex usando un elettrotensile da 1200W con una pressione costante di 4 kg su un provino di test di acciaio S235JR (Fe360) con step da 2,5 min.

MODELLI

CLASSIC

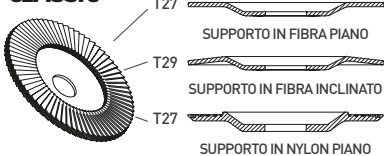

DUAL FLAP

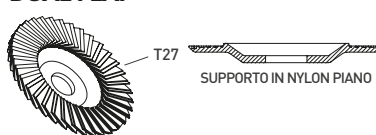

REAL FLAT

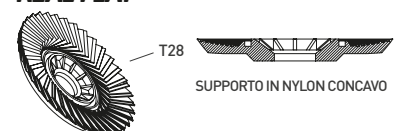

BIGGER

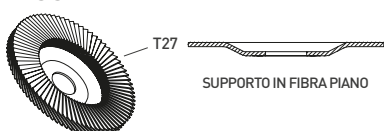

TIGER

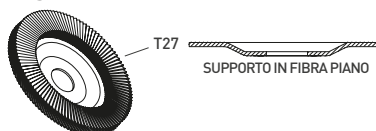

RAPTOR

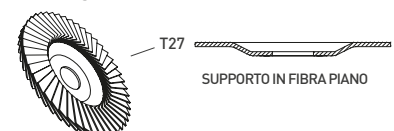



LA SCELTA DEGLI UTENTI PIÙ ESIGENTI

Disco professionale di lunga durata ed elevata velocità di asportazione per gli utenti più esigenti, realizzati esclusivamente con tela Norton™.

Per forti asportazioni, sbavature importanti – Pensato per utenti professionali e aziende di medie e grandi dimensioni. Ideale per lavorazioni su lamiere di grosse dimensioni, asportazione di grandi cordoni di saldatura e attività in cui si chiede lunga vita del disco.

DF8100-Z

DISCO LAMELLARE PROFESSIONAL CLASSIC



Art.	€	Dimensioni	Grana	Max rpm	Pack
DF8100.111	€ 2,53	115 x 22 mm	36	13300	10
DF8100.112	€ 2,53	115 x 22 mm	40	13300	10
DF8100.114	€ 2,53	115 x 22 mm	60	13300	10
DF8100.115	€ 2,53	115 x 22 mm	80	13300	10
DF8100.117	€ 2,53	115 x 22 mm	120	13300	10
DF8100.121	€ 3,17	125 x 22 mm	36	12250	10
DF8100.122	€ 3,17	125 x 22 mm	40	12250	10
DF8100.124	€ 3,17	125 x 22 mm	60	12250	10
DF8100.125	€ 3,17	125 x 22 mm	80	12250	10
DF8100.181	€ 5,30	180 x 22 mm	36	8500	10
DF8100.182	€ 5,30	180 x 22 mm	40	8500	10
DF8100.184	€ 5,30	180 x 22 mm	60	8500	10
DF8100.185	€ 5,30	180 x 22 mm	80	8500	10



DF8150-Z

DISCO LAMELLARE PROFESSIONAL CLASSIC



Art.	€	Dimensioni	Grana	Max rpm	Pack
DF8150.111	€ 2,53	115 x 22 mm	36	13300	10
DF8150.112	€ 2,53	115 x 22 mm	40	13300	10
DF8150.114	€ 2,53	115 x 22 mm	60	13300	10
DF8150.115	€ 2,53	115 x 22 mm	80	13300	10
DF8150.117	€ 2,53	115 x 22 mm	120	13300	10
DF8150.121	€ 3,17	125 x 22 mm	36	12250	10
DF8150.122	€ 3,17	125 x 22 mm	40	12250	10
DF8150.124	€ 3,17	125 x 22 mm	60	12250	10
DF8150.125	€ 3,17	125 x 22 mm	80	12250	10
DF8150.181	€ 5,30	180 x 22 mm	36	8500	10
DF8150.182	€ 5,30	180 x 22 mm	40	8500	10
DF8150.184	€ 5,30	180 x 22 mm	60	8500	10
DF8150.185	€ 5,30	180 x 22 mm	80	8500	10



**DN8100-Z****DISCO LAMELLARE PROFESSIONAL CLASSIC**

Art.	€	Dimensioni	Grana	Max rpm	Pack
DN8100.111	€ 2,53	115 x 22 mm	36	13300	10
DN8100.112	€ 2,53	115 x 22 mm	40	13300	10
DN8100.114	€ 2,53	115 x 22 mm	60	13300	10
DN8100.115	€ 2,53	115 x 22 mm	80	13300	10
DN8100.117	€ 2,53	115 x 22 mm	120	13300	10
DN8100.122	€ 3,17	125 x 22 mm	40	12250	10
DN8100.124	€ 3,17	125 x 22 mm	60	12250	10
DN8100.125	€ 3,17	125 x 22 mm	80	12250	10
DN8100.182	€ 5,30	180 x 22 mm	40	8500	10
DN8100.184	€ 5,30	180 x 22 mm	60	8500	10
DN8100.185	€ 5,30	180 x 22 mm	80	8500	10

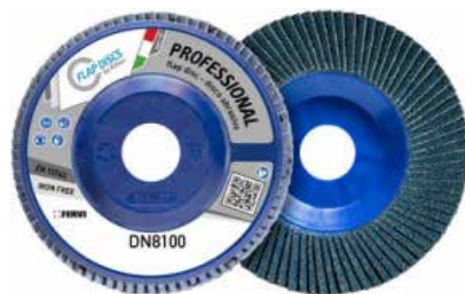
**DN8300-Z****DISCO LAMELLARE PROFESSIONAL DUAL FLAP**

Art.	€	Dimensioni	Grana	Max rpm	Pack
DN8300.111	€ 2,53	115 x 22 mm	36	13300	10
DN8300.112	€ 2,53	115 x 22 mm	40	13300	10
DN8300.114	€ 2,53	115 x 22 mm	60	13300	10
DN8300.115	€ 2,53	115 x 22 mm	80	13300	10
DN8300.117	€ 2,53	115 x 22 mm	120	13300	10
DN8300.122	€ 3,17	125 x 22 mm	40	12250	10
DN8300.124	€ 3,17	125 x 22 mm	60	12250	10
DN8300.125	€ 3,17	125 x 22 mm	80	12250	10
DN8300.182	€ 5,30	180 x 22 mm	40	8500	10
DN8300.184	€ 5,30	180 x 22 mm	60	8500	10
DN8300.185	€ 5,30	180 x 22 mm	80	8500	10

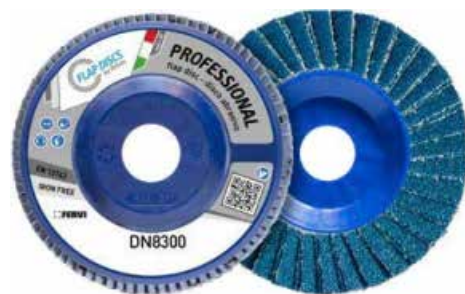
**DN8550-Z****DISCO LAMELLARE PROFESSIONAL REAL FLAT**

Questi dischi lamellari sono fabbricati con uno speciale supporto di forma convessa grazie al quale si ottiene un disco perfettamente piano con lamelle larghe e con densità e durezza costante, sia al centro, sia sul diametro esterno.



Art.	€	Dimensioni	Grana	Max rpm	Pack
DN8550.112	€ 3,69	115 x 22 mm	40	13300	10
DN8550.114	€ 3,69	115 x 22 mm	60	13300	10
DN8550.115	€ 3,69	115 x 22 mm	80	13300	10
DN8550.117	€ 3,69	115 x 22 mm	120	13300	10



DF8600-Z
DISCO LAMELLARE PROFESSIONAL BIGGER

Con il disco lamellare bigger si smeriglia più a lungo, più velocemente, ottenendo una miglior finitura. La nuova struttura assicura migliori risultati se comparati ai dischi lamellari convenzionali o ad altri dischi abrasivi: 50% in più nella capacità di asportazione, con riduzione dei tempi di lavoro, doppia durata, ottimo rapporto qualità prezzo, taglio più freddo, riduzione dei tempi e dei costi.



Art.	€	Dimensioni	Grana	Max rpm	Pack
DF8600.112	€ 3,06	115 x 22 mm	40	13300	10
DF8600.114	€ 3,06	115 x 22 mm	60	13300	10
DF8600.115	€ 3,06	115 x 22 mm	80	13300	10
DF8600.117	€ 3,06	115 x 22 mm	120	13300	10
DF8600.122	€ 3,59	125 x 22 mm	40	12250	10
DF8600.124	€ 3,59	125 x 22 mm	60	12250	10
DF8600.125	€ 3,59	125 x 22 mm	80	12250	10
DF8600.127	€ 3,59	125 x 22 mm	120	12250	10
DF8600.182	€ 6,30	180 x 22 mm	40	8500	10
DF8600.184	€ 6,30	180 x 22 mm	60	8500	10
DF8600.185	€ 6,30	180 x 22 mm	80	8500	10
DF8600.187	€ 6,30	180 x 22 mm	120	8500	10

DF8700-Z
DISCO LAMELLARE PROFESSIONAL TIGER

Tiger è un disco lamellare con il 70% in più di tela abrasiva rispetto ai dischi professionali standard. La sua forma permette l'utilizzo completo della parte abrasiva oltre a renderlo particolarmente compatto. Questa caratteristica, abbinata al supporto rinforzato, permette di esercitare una pressione specifica superiore e di conseguenza una asportazione più rapida.



Art.	€	Dimensioni	Grana	Max rpm	Pack
DF8700.112	€ 3,17	115 x 22 mm	40	13300	10
DF8700.114	€ 3,17	115 x 22 mm	60	13300	10
DF8700.115	€ 3,17	115 x 22 mm	80	13300	10
DF8700.117	€ 3,17	115 x 22 mm	120	13300	10

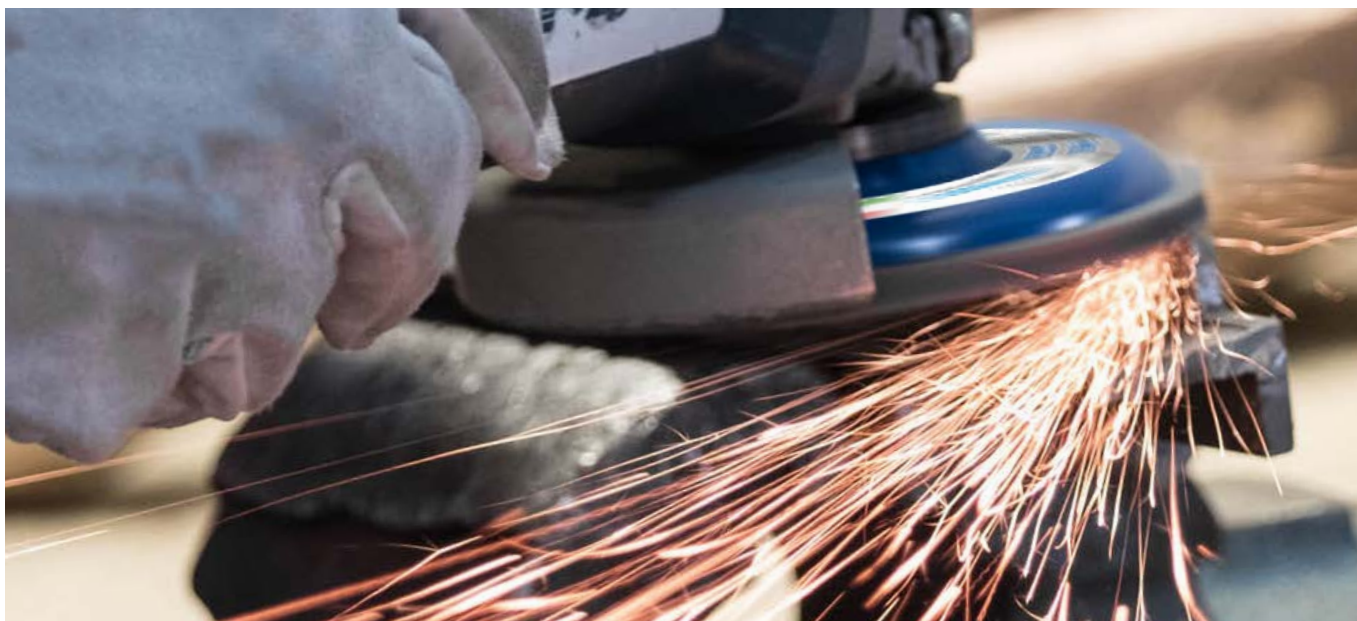
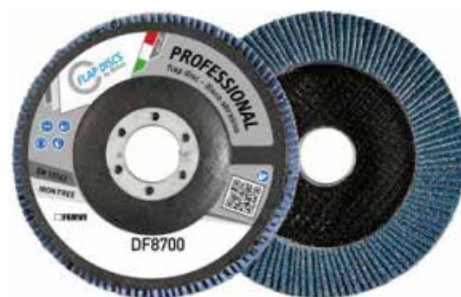

**DF8100-A****DISCO LAMELLARE PROFESSIONAL CLASSIC**

Art.	€	Dimensioni	Grana	Max rpm	Pack
DF8100.212	€ 2,42	115 x 22 mm	40	13300	10
DF8100.214	€ 2,42	115 x 22 mm	60	13300	10
DF8100.215	€ 2,42	115 x 22 mm	80	13300	10

**DF8150-A****DISCO LAMELLARE PROFESSIONAL CLASSIC**

Art.	€	Dimensioni	Grana	Max rpm	Pack
DF8150.212	€ 2,42	115 x 22 mm	40	13300	10
DF8150.214	€ 2,42	115 x 22 mm	60	13300	10
DF8150.215	€ 2,42	115 x 22 mm	80	13300	10

**DN8100-A****DISCO LAMELLARE PROFESSIONAL CLASSIC**

Art.	€	Dimensioni	Grana	Max rpm	Pack
DN8100.212	€ 2,42	115 x 22 mm	40	13300	10
DN8100.214	€ 2,42	115 x 22 mm	60	13300	10
DN8100.215	€ 2,42	115 x 22 mm	80	13300	10

**DN8300-A****DISCO LAMELLARE PROFESSIONAL DUAL FLAP**

Art.	€	Dimensioni	Grana	Max rpm	Pack
DN8300.212	€ 2,42	115 x 22 mm	40	13300	10
DN8300.214	€ 2,42	115 x 22 mm	60	13300	10
DN8300.215	€ 2,42	115 x 22 mm	80	13300	10



LA PRESTAZIONE SENZA IL BLASONE

Nuova gamma di dischi lamellari con tele in Zirconio e Ossido di Alluminio ad alte prestazioni.

Per produzioni massive e dove si richiede alta capacità di asportazione - Pensato per aziende di medie e grosse dimensioni. Ideale per utenti esigenti e per usi gravosi e lavorazioni in cui si richiede lunga vita del disco.

DF6100-Z

DISCO LAMELLARE PERFORMANCE CLASSIC



Art.	€	Dimensioni	Grana	Max rpm	Pack
DF6100.112	€ 2,33	115 x 22 mm	40	13300	10
DF6100.114	€ 2,33	115 x 22 mm	60	13300	10
DF6100.115	€ 2,33	115 x 22 mm	80	13300	10
DF6100.117	€ 2,33	115 x 22 mm	120	13300	10
DF6100.122	€ 2,85	125 x 22 mm	40	12250	10
DF6100.124	€ 2,85	125 x 22 mm	60	12250	10
DF6100.125	€ 2,85	125 x 22 mm	80	12250	10
DF6100.182	€ 4,74	180 x 22 mm	40	8500	10
DF6100.184	€ 4,74	180 x 22 mm	60	8500	10
DF6100.185	€ 4,74	180 x 22 mm	80	8500	10



DF6150-Z

DISCO LAMELLARE PERFORMANCE CLASSIC



Art.	€	Dimensioni	Grana	Max rpm	Pack
DF6150.112	€ 2,33	115 x 22 mm	40	13300	10
DF6150.114	€ 2,33	115 x 22 mm	60	13300	10
DF6150.115	€ 2,33	115 x 22 mm	80	13300	10
DF6150.117	€ 2,33	115 x 22 mm	120	13300	10
DF6150.122	€ 2,85	125 x 22 mm	40	12250	10
DF6150.124	€ 2,85	125 x 22 mm	60	12250	10
DF6150.125	€ 2,85	125 x 22 mm	80	12250	10
DF6150.182	€ 4,74	180 x 22 mm	40	8500	10
DF6150.184	€ 4,74	180 x 22 mm	60	8500	10
DF6150.185	€ 4,74	180 x 22 mm	80	8500	10



**DN6100-Z****DISCO LAMELLARE PERFORMANCE CLASSIC**

Art.	€	Dimensioni	Grana	Max rpm	Pack
DN6100.112	€ 2,33	115 x 22 mm	40	13300	10
DN6100.114	€ 2,33	115 x 22 mm	60	13300	10
DN6100.115	€ 2,33	115 x 22 mm	80	13300	10
DN6100.117	€ 2,33	115 x 22 mm	120	13300	10
DN6100.122	€ 2,85	125 x 22 mm	40	12250	10
DN6100.124	€ 2,85	125 x 22 mm	60	12250	10
DN6100.125	€ 2,85	125 x 22 mm	80	12250	10
DN6100.182	€ 4,74	180 x 22 mm	40	8500	10
DN6100.184	€ 4,74	180 x 22 mm	60	8500	10
DN6100.185	€ 4,74	180 x 22 mm	80	8500	10

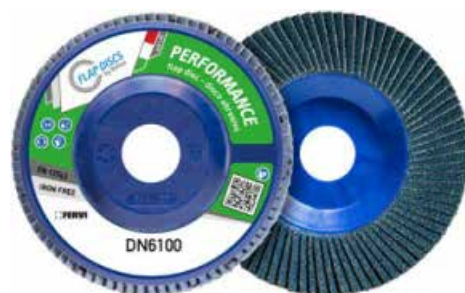
**DN6300-Z****DISCO LAMELLARE PERFORMANCE DUAL FLAP**

Art.	€	Dimensioni	Grana	Max rpm	Pack
DN6300.112	€ 2,33	115 x 22 mm	40	13300	10
DN6300.114	€ 2,33	115 x 22 mm	60	13300	10
DN6300.115	€ 2,33	115 x 22 mm	80	13300	10
DN6300.117	€ 2,33	115 x 22 mm	120	13300	10
DN6300.122	€ 2,85	125 x 22 mm	40	12250	10
DN6300.124	€ 2,85	125 x 22 mm	60	12250	10
DN6300.125	€ 2,85	125 x 22 mm	80	12250	10
DN6300.182	€ 4,74	180 x 22 mm	40	8500	10
DN6300.184	€ 4,74	180 x 22 mm	60	8500	10
DN6300.185	€ 4,74	180 x 22 mm	80	8500	10

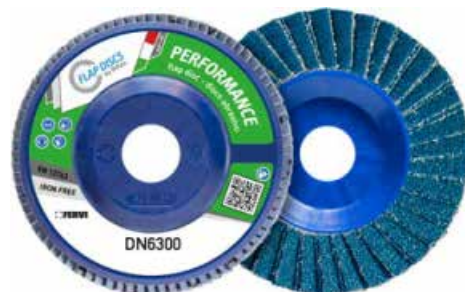
**DN6550-Z****DISCO LAMELLARE PERFORMANCE REAL FLAT**

Questi dischi lamellari sono fabbricati con uno speciale supporto di forma convessa grazie al quale si ottiene un disco perfettamente piano con lamelle larghe e con densità e durezza costante sia al centro che sul diametro esterno.



Art.	€	Dimensioni	Grana	Max rpm	Pack
DN6550.112	€ 3,17	115 x 22 mm	40	13300	10
DN6550.114	€ 3,17	115 x 22 mm	60	13300	10
DN6550.115	€ 3,17	115 x 22 mm	80	13300	10
DN6550.117	€ 3,17	115 x 22 mm	120	13300	10



DF6600-Z
DISCO LAMELLARE PERFORMANCE BIGGER

Con il disco lamellare bigger si smeriglia più a lungo, più velocemente, ottenendo una miglior finitura. La nuova struttura assicura migliori risultati se comparati ai dischi lamellari convenzionali o ad altri dischi abrasivi: 50% in più nella capacità di asportazione, con riduzione dei tempi di lavoro; doppia durata; ottimo rapporto qualità prezzo; taglio più freddo; riduzione dei tempi e dei costi.



Art.	€	Dimensioni	Grana	Max rpm	Pack
DF6600.112	€ 2,85	115 x 22 mm	40	13300	10
DF6600.114	€ 2,85	115 x 22 mm	60	13300	10
DF6600.115	€ 2,85	115 x 22 mm	80	13300	10
DF6600.117	€ 2,85	115 x 22 mm	120	13300	10
DF6600.122	€ 3,27	125 x 22 mm	40	12250	10
DF6600.124	€ 3,27	125 x 22 mm	60	12250	10
DF6600.125	€ 3,27	125 x 22 mm	80	12250	10
DF6600.127	€ 3,27	125 x 22 mm	120	12250	10
DF6600.182	€ 5,80	180 x 22 mm	40	8500	10
DF6600.184	€ 5,80	180 x 22 mm	60	8500	10

DF6700-Z
DISCO LAMELLARE PERFORMANCE TIGER

Tiger è un disco lamellare con il 70% in più di tela abrasiva rispetto ai dischi professionali standard. La sua forma permette l'utilizzo completo della parte abrasiva oltre a renderlo particolarmente compatto. Questa caratteristica abbinata al supporto rinforzato, permette di esercitare una pressione specifica superiore e di conseguenza una asportazione più rapida.



Art.	€	Dimensioni	Grana	Max rpm	Pack
DF6700.112	€ 2,74	115 x 22 mm	40	13300	10
DF6700.114	€ 2,74	115 x 22 mm	60	13300	10
DF6700.115	€ 2,74	115 x 22 mm	80	13300	10
DF6700.117	€ 2,74	115 x 22 mm	120	13300	10

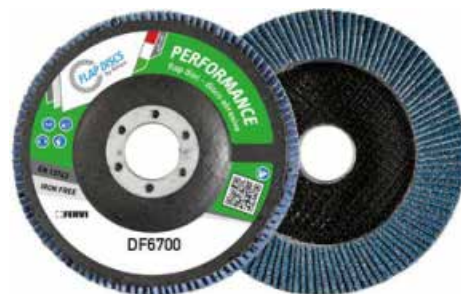

**DF6100-A****DISCO LAMELLARE PERFORMANCE CLASSIC**

Art.	€	Dimensioni	Grana	Max rpm	Pack
DF6100.212	€ 2,22	115 x 22 mm	40	13300	10
DF6100.214	€ 2,22	115 x 22 mm	60	13300	10
DF6100.215	€ 2,22	115 x 22 mm	80	13300	10

**DF6150-A****DISCO LAMELLARE PERFORMANCE CLASSIC**

Art.	€	Dimensioni	Grana	Max rpm	Pack
DF6150.212	€ 2,22	115 x 22 mm	40	13300	10
DF6150.214	€ 2,22	115 x 22 mm	60	13300	10
DF6150.215	€ 2,22	115 x 22 mm	80	13300	10

**DN6100-A****DISCO LAMELLARE PERFORMANCE CLASSIC**

Art.	€	Dimensioni	Grana	Max rpm	Pack
DN6100.212	€ 2,22	115 x 22 mm	40	13300	10
DN6100.214	€ 2,22	115 x 22 mm	60	13300	10
DN6100.215	€ 2,22	115 x 22 mm	80	13300	10

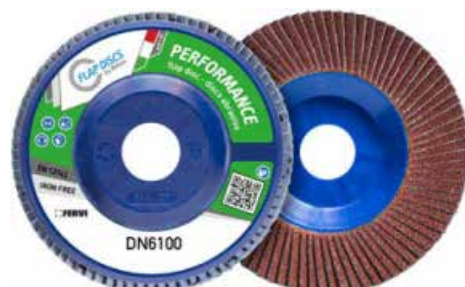
**DN6300-A****DISCO LAMELLARE PERFORMANCE DUAL FLAP**

Art.	€	Dimensioni	Grana	Max rpm	Pack
DN6300.212	€ 2,22	115 x 22 mm	40	13300	10
DN6300.214	€ 2,22	115 x 22 mm	60	13300	10
DN6300.215	€ 2,22	115 x 22 mm	80	13300	10





IL DISCO PIÙ VERSATILE

Il “best seller”, adatto per asportazioni massive e finitura e per lavorazioni su tutti i tipi di metalli, ferrosi e non ferrosi.

Per usi specifici, produzioni massive e finitura - Pensato per artigiani, grandi e medie industrie. Ideale per asportazione di cordoni di saldatura e lavorazioni in cui si richiede lunga durata del disco, oltre a sbavatura di lamiera.

DF4100-Z

DISCO LAMELLARE GRINDFLEX CLASSIC



Art.	€	Dimensioni	Grana	Max rpm	Pack
DF4100.112	€ 2,12	115 x 22 mm	40	13300	10
DF4100.114	€ 2,12	115 x 22 mm	60	13300	10
DF4100.115	€ 2,12	115 x 22 mm	80	13300	10
DF4100.117	€ 2,12	115 x 22 mm	120	13300	10
DF4100.122	€ 2,53	125 x 22 mm	40	12250	10
DF4100.124	€ 2,53	125 x 22 mm	60	12250	10
DF4100.125	€ 2,53	125 x 22 mm	80	12250	10
DF4100.127	€ 2,53	125 x 22 mm	120	12250	10
DF4100.182	€ 4,21	180 x 22 mm	40	8500	10
DF4100.184	€ 4,21	180 x 22 mm	60	8500	10
DF4100.185	€ 4,21	180 x 22 mm	80	8500	10
DF4100.187	€ 4,21	180 x 22 mm	120	8500	10



DF4150-Z

DISCO LAMELLARE GRINDFLEX CLASSIC



Art.	€	Dimensioni	Grana	Max rpm	Pack
DF4150.112	€ 2,12	115 x 22 mm	40	13300	10
DF4150.114	€ 2,12	115 x 22 mm	60	13300	10
DF4150.115	€ 2,12	115 x 22 mm	80	13300	10
DF4150.117	€ 2,12	115 x 22 mm	120	13300	10
DF4150.122	€ 2,53	125 x 22 mm	40	12250	10
DF4150.124	€ 2,53	125 x 22 mm	60	12250	10
DF4150.125	€ 2,53	125 x 22 mm	80	12250	10
DF4150.127	€ 2,53	125 x 22 mm	120	12250	10
DF4150.182	€ 4,21	180 x 22 mm	40	8500	10
DF4150.184	€ 4,21	180 x 22 mm	60	8500	10
DF4150.185	€ 4,21	180 x 22 mm	80	8500	10
DF4150.187	€ 4,21	180 x 22 mm	120	8500	10



**DN4100-Z****DISCO LAMELLARE GRINDFLEX CLASSIC**

Art.	€	Dimensioni	Grana	Max rpm	Pack
DN4100.112	€ 2,12	115 x 22 mm	40	13300	10
DN4100.114	€ 2,12	115 x 22 mm	60	13300	10
DN4100.115	€ 2,12	115 x 22 mm	80	13300	10
DN4100.122	€ 2,64	125 x 22 mm	40	12250	10
DN4100.124	€ 2,64	125 x 22 mm	60	12250	10

**DN4300-Z****DISCO LAMELLARE GRINDFLEX DUAL FLAP**

Art.	€	Dimensioni	Grana	Max rpm	Pack
DN4300.112	€ 2,12	115 x 22 mm	40	13300	10
DN4300.114	€ 2,12	115 x 22 mm	60	13300	10
DN4300.115	€ 2,12	115 x 22 mm	80	13300	10
DN4300.117	€ 2,12	115 x 22 mm	120	13300	10

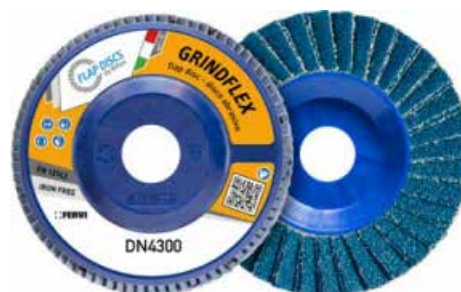
**DN4550-Z****DISCO LAMELLARE GRINDFLEX REAL FLAT**

Questi dischi lamellari sono fabbricati con uno speciale supporto di forma convessa grazie al quale si ottiene un disco perfettamente piano con lamelle larghe e con densità e durezza costante sia al centro che sul diametro esterno.



Art.	€	Dimensioni	Grana	Max rpm	Pack
DN4550.112	€ 2,95	115 x 22 mm	40	13300	10
DN4550.114	€ 2,95	115 x 22 mm	60	13300	10



DF4600-Z
DISCO LAMELLARE GRINDFLEX BIGGER

Con il disco lamellare bigger si smeriglia più a lungo, più velocemente, ottenendo una miglior finitura. La nuova struttura assicura migliori risultati se comparati ai dischi lamellari convenzionali o ad altri dischi abrasivi: 50% in più nella capacità di asportazione, con riduzione dei tempi di lavoro; doppia durata; ottimo rapporto qualità prezzo; taglio più freddo; riduzione dei tempi e dei costi.



Art.	€	Dimensioni	Grana	Max rpm	Pack
DF4600.112	€ 2,64	115 x 22 mm	40	13300	10
DF4600.114	€ 2,64	115 x 22 mm	60	13300	10
DF4600.115	€ 2,64	115 x 22 mm	80	13300	10
DF4600.117	€ 2,64	115 x 22 mm	120	13300	10
DF4600.122	€ 2,95	125 x 22 mm	40	12250	10
DF4600.124	€ 2,95	125 x 22 mm	60	12250	10
DF4600.182	€ 5,30	180 x 22 mm	40	8500	10
DF4600.184	€ 5,30	180 x 22 mm	60	8500	10



**DF4100-A****DISCO LAMELLARE GRINDFLEX CLASSIC**

Art.	€	Dimensioni	Grana	Max rpm	Pack
DF4100.212	€ 1,91	115 x 22 mm	40	13300	10
DF4100.214	€ 1,91	115 x 22 mm	60	13300	10
DF4100.215	€ 1,91	115 x 22 mm	80	13300	10

**DF4150-A****DISCO LAMELLARE GRINDFLEX CLASSIC**

Art.	€	Dimensioni	Grana	Max rpm	Pack
DF4150.212	€ 1,91	115 x 22 mm	40	13300	10
DF4150.214	€ 1,91	115 x 22 mm	60	13300	10
DF4150.215	€ 1,91	115 x 22 mm	80	13300	10

**DN4100-A****DISCO LAMELLARE GRINDFLEX CLASSIC**

Art.	€	Dimensioni	Grana	Max rpm	Pack
DN4100.212	€ 2,01	115 x 22 mm	40	13300	10
DN4100.214	€ 2,01	115 x 22 mm	60	13300	10

**DN4300-A****DISCO LAMELLARE GRINDFLEX DUAL FLAP**

Art.	€	Dimensioni	Grana	Max rpm	Pack
DN4300.212	€ 1,91	115 x 22 mm	40	13300	10
DN4300.214	€ 1,91	115 x 22 mm	60	13300	10
DN4300.215	€ 1,91	115 x 22 mm	80	13300	10



VALUE FOR MONEY

Il miglior prezzo senza rinunciare alle prestazioni professionali. Per lavorazioni di asportazione e finitura.

Per usi comuni e basse produzioni - Pensato per hobbisti, cantieristica e piccoli artigiani (imprese individuali), che non vogliono rinunciare alle prestazioni. Ideale per asportazione di cordoni di saldatura, sbavatura di lamiere e finitura.

DF2100-Z

DISCO LAMELLARE SMARTFLEX CLASSIC



Art.	€	Dimensioni	Grana	Max rpm	Pack
DF2100.112	€ 1,91	115 x 22 mm	40	13300	10
DF2100.114	€ 1,91	115 x 22 mm	60	13300	10
DF2100.115	€ 1,91	115 x 22 mm	80	13300	10
DF2100.117	€ 1,91	115 x 22 mm	120	13300	10
DF2100.122	€ 2,33	125 x 22 mm	40	12250	10
DF2100.124	€ 2,33	125 x 22 mm	60	12250	10
DF2100.125	€ 2,33	125 x 22 mm	80	12250	10
DF2100.127	€ 2,33	125 x 22 mm	120	12250	10



DF2150-Z

DISCO LAMELLARE SMARTFLEX CLASSIC



Art.	€	Dimensioni	Grana	Max rpm	Pack
DF2150.112	€ 1,91	115 x 22 mm	40	13300	10
DF2150.114	€ 1,91	115 x 22 mm	60	13300	10
DF2150.115	€ 1,91	115 x 22 mm	80	13300	10
DF2150.117	€ 1,91	115 x 22 mm	120	13300	10
DF2150.122	€ 2,33	125 x 22 mm	40	12250	10
DF2150.124	€ 2,33	125 x 22 mm	60	12250	10
DF2150.125	€ 2,33	125 x 22 mm	80	12250	10
DF2150.127	€ 2,33	125 x 22 mm	120	12250	10



DN2100-Z

DISCO LAMELLARE SMARTFLEX CLASSIC



Art.	€	Dimensioni	Grana	Max rpm	Pack
DN2100.112	€ 1,91	115 x 22 mm	40	13300	10
DN2100.114	€ 1,91	115 x 22 mm	60	13300	10
DN2100.115	€ 1,91	115 x 22 mm	80	13300	10
DN2100.117	€ 1,91	115 x 22 mm	120	13300	10
DN2100.122	€ 2,33	125 x 22 mm	40	12250	10
DN2100.124	€ 2,33	125 x 22 mm	60	12250	10
DN2100.125	€ 2,33	125 x 22 mm	80	12250	10
DN2100.127	€ 2,33	125 x 22 mm	120	12250	10



**DN2300-Z****DISCO LAMELLARE SMARTFLEX DUAL FLAP**

Art.	€	Dimensioni	Grana	Max rpm	Pack
DN2300.112	€ 1,91	115 x 22 mm	40	13300	10
DN2300.114	€ 1,91	115 x 22 mm	60	13300	10
DN2300.115	€ 1,91	115 x 22 mm	80	13300	10
DN2300.117	€ 1,91	115 x 22 mm	120	13300	10
DN2300.122	€ 2,33	125 x 22 mm	40	12250	10
DN2300.124	€ 2,33	125 x 22 mm	60	12250	10
DN2300.125	€ 2,33	125 x 22 mm	80	12250	10
DN2300.127	€ 2,33	125 x 22 mm	120	12250	10



DF2100-A
DISCO LAMELLARE SMARTFLEX CLASSIC

Art.	€	Dimensioni	Grana	Max rpm	Pack
DF2100.212	€ 1,68	115 x 22 mm	40	13300	10
DF2100.214	€ 1,68	115 x 22 mm	60	13300	10
DF2100.215	€ 1,68	115 x 22 mm	80	13300	10

DF2150-A
DISCO LAMELLARE SMARTFLEX CLASSIC

Art.	€	Dimensioni	Grana	Max rpm	Pack
DF2150.212	€ 1,68	115 x 22 mm	40	13300	10
DF2150.214	€ 1,68	115 x 22 mm	60	13300	10
DF2150.215	€ 1,68	115 x 22 mm	80	13300	10

DN2100-A
DISCO LAMELLARE SMARTFLEX CLASSIC

Art.	€	Dimensioni	Grana	Max rpm	Pack
DN2100.212	€ 1,68	115 x 22 mm	40	13300	10
DN2100.214	€ 1,68	115 x 22 mm	60	13300	10
DN2100.215	€ 1,68	115 x 22 mm	80	13300	10





SPECIALTY INOX

Disco ideale per le lavorazioni di superfici in acciaio inossidabile, con tela zircoceramica con terzo strato refrigerante "top size".

Per applicazioni nei settori alimentare, farmaceutico e chimico. Pensato per gli specialisti dell'inox. Ideale per lavorazioni di lamiere sottili, importanti sbavature di cordoni di saldature e dove si richiede un prodotto che resista alla temperatura con elettrotensili da 1400 W e oltre.

SPECIALTY INOX è un **disco lamellare** costituito da una tela abrasiva **"TOP SIZE"** con una miscela di **zirconio** e **abrasivo ceramico**. Questi materiali di elevata qualità consentono una **altissima velocità** di taglio assieme ad una **eccezionale durata** del disco. L'ulteriore strato **"TOP SIZE"** riduce drasticamente il surriscaldamento del disco e del pezzo da lavorare con **evidenti benefici nelle lavorazioni degli acciai inossidabili**. Il colore azzurro è per sua natura privo di ossidi di ferro in modo da prevenire la contaminazione degli acciai inossidabili ($\geq 0,1\%$ Fe, S, Cl).

DF9100-ZC

DISCO LAMELLARE ZIRCO CER CLASSIC



Art.	€	Dimensioni	Grana	Max rpm	Pack
DF9100.312	€ 3,38	115 x 22 mm	40+	13300	10
DF9100.314	€ 3,38	115 x 22 mm	60	13300	10
DF9100.322	€ 3,80	125 x 22 mm	40+	12250	10
DF9100.324	€ 3,80	125 x 22 mm	60	12250	10



DF9150-ZC

DISCO LAMELLARE ZIRCO CER CLASSIC



Art.	€	Dimensioni	Grana	Max rpm	Pack
DF9150.312	€ 3,38	115 x 22 mm	40+	13300	10
DF9150.314	€ 3,38	115 x 22 mm	60	13300	10
DF9150.322	€ 3,80	125 x 22 mm	40+	12250	10
DF9150.324	€ 3,80	125 x 22 mm	60	12250	10



DN9100-ZC
DISCO LAMELLARE ZIRCO CER CLASSIC

Art.	€	Dimensioni	Grana	Max rpm	Pack
DN9100.312	€ 3,38	115 x 22 mm	40+	13300	10
DN9100.314	€ 3,38	115 x 22 mm	60	13300	10
DN9100.322	€ 3,80	125 x 22 mm	40+	12250	10
DN9100.324	€ 3,80	125 x 22 mm	60	12250	10

DF9800-ZC
DISCO LAMELLARE ZIRCO CER RAPTOR

Raptor ha una particolare costruzione che esalta le caratteristiche di velocità di asportazione.



Art.	€	Dimensioni	Grana	Max rpm	Pack
DF9800.312	€ 3,06	115 x 22 mm	40	13300	10
DF9800.322	€ 3,38	125 x 22 mm	40	12250	10





SPECIALTY CER

Disco ideale per le lavorazioni di superfici in acciaio inossidabile, soprattutto per forti asportazioni con la più alta velocità di taglio, con tela in abrasivo 100% ceramico con terzo strato refrigerante "top size".

Per applicazioni nei settori alimentare, farmaceutico e chimico. Pensato per gli specialisti dell'inox. Ideale per lavorazioni di lamiera sottili, importanti sbavature di cordoni di saldature e dove si richiede un prodotto che resista alla temperatura con elettrotensili da 1400 W e oltre.

SPECIALTY CER è un **disco lamellare** costituito da una tela abrasiva **"TOP SIZE"** con un **abrasivo 100% ceramico**. Questi materiali di elevata qualità consentono una **massima velocità** di taglio assieme ad una **eccezionale durata** del disco. L'ulteriore strato **"TOP SIZE"** riduce drasticamente il surriscaldamento del disco e del pezzo da lavorare con **evidenti benefici nelle lavorazioni degli acciai inossidabili**. Il tessuto in polycotton particolarmente resistente permette **forti pressioni di lavoro**.

DF9101-C

DISCO LAMELLARE CERAMICO CLASSIC



Art.	€	Dimensioni	Grana	Max rpm	Pack
DF9101.312	€ 4,17	115 x 22 mm	40	13300	10
DF9101.314	€ 4,17	115 x 22 mm	60	13300	10
DF9101.322	€ 5,30	125 x 22 mm	40	12250	10
DF9101.324	€ 5,30	125 x 22 mm	60	12250	10



DN9101-C

DISCO LAMELLARE CERAMICO CLASSIC



Art.	€	Dimensioni	Grana	Max rpm	Pack
DN9101.312	€ 4,17	115 x 22 mm	40	13300	10
DN9101.314	€ 4,17	115 x 22 mm	60	13300	10
DN9101.322	€ 5,30	125 x 22 mm	40	12250	10
DN9101.324	€ 5,30	125 x 22 mm	60	12250	10



DF9801-C

DISCO LAMELLARE CERAMICO RAPTOR

Raptor ha una particolare costruzione che esalta le caratteristiche di velocità di asportazione.



Art.	€	Dimensioni	Grana	Max rpm	Pack
DF9801.312	€ 4,17	115 x 22 mm	40	13300	10
DF9801.322	€ 5,30	125 x 22 mm	40	12250	10



LOW TEMPERATURES, HIGH PERFORMANCE.

Disco ideale per le lavorazioni di superfici in alluminio, con tela Abranet®.

Per lavorazioni di sbavatura e finitura su alluminio e materiali non ferrosi come rame, zinco, ottone, magnesio, oltre che legno e materiali compositi e dove si potrebbe presentare il problema dell'intasamento.

SPECIALTY ALU è un disco speciale realizzato per le lavorazioni dell'Alluminio e, in genere, di tutti i metalli non ferrosi e materiali compositi. È realizzato con uno speciale supporto a rete in poliammide che evita l'intasamento dell'abrasivo e permette la lavorazione del materiale a bassa temperatura.

DF9103-M

DISCO LAMELLARE SPECIALTY ALU CLASSIC



Art.	€	Dimensioni	Grana	Max rpm	Pack
DF9103.512	€ 4,20	115 x 22 mm	40	13300	10
DF9103.514	€ 4,20	115 x 22 mm	60	13300	10
DF9103.515	€ 4,20	115 x 22 mm	80	13300	10
DF9103.517	€ 4,20	115 x 22 mm	120	13300	10
DF9103.522	€ 5,40	125 x 22 mm	40	12250	10
DF9103.524	€ 5,40	125 x 22 mm	60	12250	10
DF9103.525	€ 5,40	125 x 22 mm	80	12250	10
DF9103.527	€ 5,40	125 x 22 mm	120	12250	10



DF9153-M

DISCO LAMELLARE SPECIALTY ALU CLASSIC



Art.	€	Dimensioni	Grana	Max rpm	Pack
DF9153.512	€ 4,20	115 x 22 mm	40	13300	10
DF9153.514	€ 4,20	115 x 22 mm	60	13300	10
DF9153.515	€ 4,20	115 x 22 mm	80	13300	10
DF9153.517	€ 4,20	115 x 22 mm	120	13300	10
DF9153.522	€ 5,40	125 x 22 mm	40	12250	10
DF9153.524	€ 5,40	125 x 22 mm	60	12250	10
DF9153.525	€ 5,40	125 x 22 mm	80	12250	10
DF9153.527	€ 5,40	125 x 22 mm	120	12250	10



**MFDXZ****MINI DISCO LAMELLARE**

Ad attacco rapido. Lunga durata e finitura costante, per asportare con precisione e per lavorare in piccole aree e sui bordi.

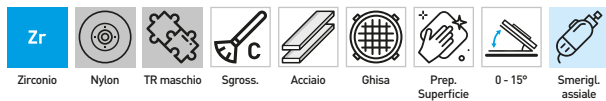

Art.	€	Diametro ø	Grana	Max rpm	Pack
MFD050/040Z	€ 2,44	50 mm	40	25000	10
MFD050/060Z	€ 2,44	50 mm	60	25000	10
MFD050/080Z	€ 2,44	50 mm	80	25000	10
MFD050/120Z	€ 2,44	50 mm	120	25000	10
MFD075/040Z	€ 4,11	75 mm	40	20000	10
MFD075/060Z	€ 4,11	75 mm	60	20000	10
MFD075/080Z	€ 4,11	75 mm	80	20000	10
MFD075/120Z	€ 4,11	75 mm	120	20000	10

**MFDXZC****MINI DISCO LAMELLARE CERAMICO**

Ad attacco rapido. Abrasivo ceramico estremamente duro e tenace, ancora più performante dello zirconio per durata e capacità d'asportazione.

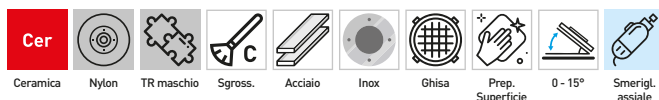

Art.	€	Diametro ø	Grana	Max rpm	Pack
MFD050/040ZC	€ 2,64	50 mm	40	25000	10
MFD050/060ZC	€ 2,64	50 mm	60	25000	10
MFD050/080ZC	€ 2,64	50 mm	80	25000	10

MCDXZ**MINI DISCO LAMELLARE A TAZZA**

Ad attacco rapido. Più flessibile della forma piana, si adatta a superfici sagomate.

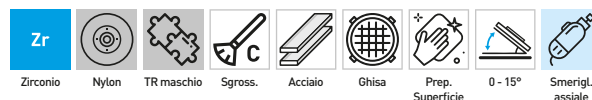
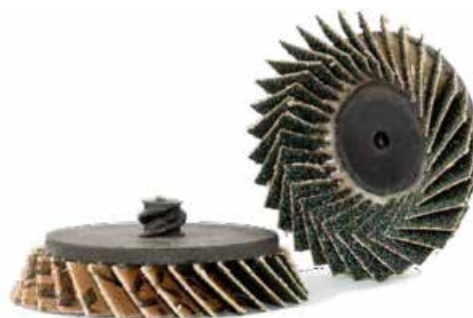

Art.	€	Diametro ø	Grana	Max rpm	Pack
MCD050/040Z	€ 3,62	50 mm	40	25000	10
MCD050/060Z	€ 3,62	50 mm	60	25000	10
MCD050/080Z	€ 3,62	50 mm	80	25000	10
MCD050/120Z	€ 3,62	50 mm	120	25000	10

SGFX**SUPPORTO IN GOMMA**

Monoblocco, adatto a tutti i tipi di fast lock.



Art.	€	Diametro ø	Gambo	Max rpm
SGF050/06	€ 9,60	50 mm	6 mm	30000
SGF075/06	€ 11,10	75 mm	6 mm	28000

SFFX**SUPPORTO IN GOMMA**

In due parti sia con attacco M14 che con perno, adatto a tutti i tipi di fast-lock.

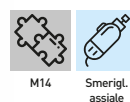

Art.	€	Diametro ø	Filetto	Gambo	Max rpm
SFF050/M14	€ 14,50	50 mm	M14	6 mm	30000
SFF075/M14	€ 16,40	75 mm	M14	6 mm	28000

RMTX
MICRO RUOTE LAMELLARI
ADR3/6 € 11,00
**ADATTATORE GAMBO
DA 3 mm A 6 mm**

RGTX
RUOTE LAMELLARI CON GAMBO IN TELA ALL' OSSIDO DI ALLUMINIO

Art.	€	Diámetro ø	H	Gambo	Grana	Max rpm	Pack
RMT1010/060	€ 2,60	10 mm	10 mm	3 mm	60	26000	25
RMT1010/080	€ 2,60	10 mm	10 mm	3 mm	80	26000	25
RMT1010/120	€ 2,60	10 mm	10 mm	3 mm	120	26000	25
RMT1515/060	€ 2,18	15 mm	15 mm	3 mm	60	26000	25
RMT1515/080	€ 2,18	15 mm	15 mm	3 mm	80	26000	25
RMT1515/120	€ 2,18	15 mm	15 mm	3 mm	120	26000	25



Art.	€	Dimensioni	Gambo	Grana	Max rpm	Pack
RGT2010/40	€ 2,37	20 x 10 mm	6 mm	40	26000	10
RGT2010/60	€ 2,37	20 x 10 mm	6 mm	60	26000	10
RGT2010/80	€ 2,37	20 x 10 mm	6 mm	80	26000	10
RGT2010/120	€ 2,37	20 x 10 mm	6 mm	120	26000	10
RGT2015/40	€ 2,37	20 x 15 mm	6 mm	40	25000	10
RGT2015/60	€ 2,37	20 x 15 mm	6 mm	60	25000	10
RGT2015/80	€ 2,37	20 x 15 mm	6 mm	80	25000	10
RGT2015/120	€ 2,37	20 x 15 mm	6 mm	120	25000	10
RGT2515/60	€ 2,25	25 x 15 mm	6 mm	60	25000	10
RGT2515/80	€ 2,25	25 x 15 mm	6 mm	80	25000	10
RGT2515/120	€ 2,25	25 x 15 mm	6 mm	120	25000	10
RGT2525/40	€ 2,24	25 x 25 mm	6 mm	40	25000	10
RGT2525/60	€ 2,24	25 x 25 mm	6 mm	60	25000	10
RGT2525/80	€ 2,24	25 x 25 mm	6 mm	80	25000	10
RGT2525/120	€ 2,24	25 x 25 mm	6 mm	120	25000	10
RGT3010/40	€ 2,16	30 x 10 mm	6 mm	40	25500	10
RGT3010/60	€ 2,16	30 x 10 mm	6 mm	60	25500	10
RGT3010/80	€ 2,16	30 x 10 mm	6 mm	80	25500	10
RGT3010/120	€ 2,16	30 x 10 mm	6 mm	120	25500	10
RGT3015/40	€ 2,37	30 x 15 mm	6 mm	40	25500	10
RGT3015/60	€ 2,37	30 x 15 mm	6 mm	60	25500	10
RGT3015/80	€ 2,37	30 x 15 mm	6 mm	80	25500	10
RGT3015/120	€ 2,37	30 x 15 mm	6 mm	120	22900	10
RGT3020/40	€ 2,51	30 x 20 mm	6 mm	40	22900	10
RGT3020/60	€ 2,51	30 x 20 mm	6 mm	60	22900	10
RGT3020/80	€ 2,51	30 x 20 mm	6 mm	80	22900	10
RGT3020/120	€ 2,51	30 x 20 mm	6 mm	120	25500	10
RGT4015/40	€ 2,53	40 x 15 mm	6 mm	40	19100	10
RGT4015/60	€ 2,53	40 x 15 mm	6 mm	60	19100	10
RGT4015/80	€ 2,61	40 x 15 mm	6 mm	80	19100	10
RGT4015/120	€ 2,61	40 x 15 mm	6 mm	120	19100	10
RGT4020/40	€ 2,61	40 x 20 mm	6 mm	40	19100	10
RGT4020/60	€ 2,61	40 x 20 mm	6 mm	60	19100	10
RGT4020/80	€ 2,61	40 x 20 mm	6 mm	80	19100	10
RGT4020/120	€ 2,61	40 x 20 mm	6 mm	120	19100	10
RGT4030/40	€ 2,98	40 x 30 mm	6 mm	40	17100	10
RGT4030/60	€ 2,98	40 x 30 mm	6 mm	60	17100	10
RGT4030/80	€ 2,98	40 x 30 mm	6 mm	80	17100	10
RGT4030/120	€ 2,98	40 x 30 mm	6 mm	120	17100	10
RGT5020/40	€ 2,72	50 x 20 mm	6 mm	40	15300	10
RGT5020/60	€ 2,72	50 x 20 mm	6 mm	60	15300	10
RGT5020/80	€ 2,72	50 x 20 mm	6 mm	80	15300	10
RGT5020/120	€ 2,72	50 x 20 mm	6 mm	120	15300	10
RGT5030/40	€ 3,21	50 x 30 mm	6 mm	40	15300	10
RGT5030/60	€ 3,21	50 x 30 mm	6 mm	60	15300	10
RGT5030/80	€ 3,21	50 x 30 mm	6 mm	80	15300	10
RGT5030/120	€ 3,21	50 x 30 mm	6 mm	120	15300	10
RGT6020/40	€ 3,60	60 x 20 mm	6 mm	40	12700	10
RGT6020/60	€ 3,60	60 x 20 mm	6 mm	60	12700	10
RGT6020/80	€ 3,60	60 x 20 mm	6 mm	80	12700	10
RGT6020/120	€ 3,60	60 x 20 mm	6 mm	120	12700	10
RGT6030/40	€ 3,95	60 x 30 mm	6 mm	40	12700	10
RGT6030/60	€ 3,95	60 x 30 mm	6 mm	60	12700	10
RGT6030/80	€ 3,95	60 x 30 mm	6 mm	80	12700	10
RGT6030/120	€ 3,95	60 x 30 mm	6 mm	120	12700	10

RGMX
RUOTE CON GAMBO MISTE IN TELA E PANNO ABRASIVO

Costituite da lamelle di panno abrasivo intercalate a lamelle di tela disposte in senso radiale.



Art.	€	Dimensioni	Gambo	Panno	Tela	Pack
RGM030/20M	€ 4,76	30 x 20 mm	6 mm	A/O-M	60	10
RGM030/20F	€ 4,76	30 x 20 mm	6 mm	A/O-F	100	10
RGM030/20VF	€ 4,76	30 x 20 mm	6 mm	A/O-VF	150	10
RGM040/20M	€ 5,70	40 x 20 mm	6 mm	A/O-M	60	10
RGM040/20F	€ 5,70	40 x 20 mm	6 mm	A/O-F	100	10
RGM040/20VF	€ 5,70	40 x 20 mm	6 mm	A/O-VF	150	10
RGM050/30M	€ 6,40	50 x 30 mm	6 mm	A/O-M	60	10
RGM050/30F	€ 6,40	50 x 30 mm	6 mm	A/O-F	100	10
RGM050/30VF	€ 6,40	50 x 30 mm	6 mm	A/O-VF	150	10
RGM060/30M	€ 7,20	60 x 30 mm	6 mm	A/O-M	60	10
RGM060/30F	€ 7,20	60 x 30 mm	6 mm	A/O-F	100	10
RGM060/30VF	€ 7,20	60 x 30 mm	6 mm	A/O-VF	150	10
RGM080/50M	€ 9,40	80 x 50 mm	6 mm	A/O-M	60	10
RGM080/50F	€ 9,40	80 x 50 mm	6 mm	A/O-F	100	10
RGM080/50VF	€ 9,40	80 x 50 mm	6 mm	A/O-VF	150	10



RFTX

RUOTE LAMELLARI CON FORO IN TELA ALL'OSSIDO DI ALLUMINIO

Le ruote si possono contro sagomare sul profilo del pezzo da lavorare. Lubrificando la ruota con olio o con grasso, si migliora il grado di finitura, la durata della ruota stessa e si svolge un'azione antipolvere.



Art.	€	Dimensioni	Grana	Max rpm
RFT165/25040	€ 22,20	165 x 25 x 54 mm	40	5200
RFT165/25060	€ 22,80	165 x 25 x 54 mm	60	5200
RFT165/25080	€ 23,00	165 x 25 x 54 mm	80	5200
RFT165/25120	€ 23,70	165 x 25 x 54 mm	120	5200
RFT165/25220	€ 30,00	165 x 25 x 54 mm	220	5200
RFT165/30040	€ 23,20	165 x 30 x 54 mm	40	5200
RFT165/30060	€ 37,40	165 x 30 x 54 mm	60	5200
RFT165/30080	€ 23,90	165 x 30 x 54 mm	80	5200
RFT165/30120	€ 24,90	165 x 30 x 54 mm	120	5200
RFT165/30220	€ 49,20	165 x 30 x 54 mm	220	5200
RFT165/50040	€ 43,90	165 x 50 x 54 mm	40	5200
RFT165/50060	€ 47,40	165 x 50 x 54 mm	60	5200
RFT165/50080	€ 48,40	165 x 50 x 54 mm	80	5200
RFT165/50120	€ 52,60	165 x 50 x 54 mm	120	5200
RFT165/50220	€ 45,20	165 x 50 x 54 mm	220	5200
RFT165/50040A	€ 32,20	165 x 50 x 25 mm	40	5200
RFT165/50060A	€ 32,70	165 x 50 x 25 mm	60	5200
RFT165/50080A	€ 33,90	165 x 50 x 25 mm	80	5200
RFT165/50120A	€ 35,00	165 x 50 x 25 mm	120	5200
RFT165/50220A	€ 45,20	165 x 50 x 25 mm	220	5200
RFT200/50040	€ 38,20	200 x 50 x 54 mm	40	3800
RFT200/50060	€ 42,00	200 x 50 x 54 mm	60	3800
RFT200/50080	€ 43,60	200 x 50 x 54 mm	80	3800
RFT200/50120	€ 45,00	200 x 50 x 54 mm	120	3800
RFT250/50040	€ 72,60	250 x 50 x 100 mm	40	3400
RFT250/50060	€ 77,30	250 x 50 x 100 mm	60	3400
RFT250/50080	€ 125,00	250 x 50 x 100 mm	80	3400
RFT250/50120	€ 129,00	250 x 50 x 100 mm	120	3400

FRFX

COPPIA DI FLANGE



Art.	€	Misura	Foro
FRFX54/20	€ 18,70	54 mm	20 mm
FRFX54/25	€ 18,70	54 mm	25 mm

RGPX

RUOTE CON GAMBO IN PANNO ABRASIVO

Costituite da lamelle disposte in senso radiale



Art.	€	Dimensioni	Gambo	Grana	Pack
RGPO30/20C	€ 4,13	30 x 20 mm	6 mm	COARSE	10
RGPO30/20M	€ 4,13	30 x 20 mm	6 mm	MEDIUM	10
RGPO30/20F	€ 4,13	30 x 20 mm	6 mm	FINE	10
RGPO30/20VF	€ 4,13	30 x 20 mm	6 mm	VERY FINE	10
RGPO40/20C	€ 4,41	40 x 20 mm	6 mm	COARSE	10
RGPO40/20M	€ 4,41	40 x 20 mm	6 mm	MEDIUM	10
RGPO40/20F	€ 4,41	40 x 20 mm	6 mm	FINE	10
RGPO40/20VF	€ 4,41	40 x 20 mm	6 mm	VERY FINE	10
RGPO50/30C	€ 5,60	50 x 30 mm	6 mm	COARSE	10
RGPO50/30M	€ 5,60	50 x 30 mm	6 mm	MEDIUM	10
RGPO50/30F	€ 5,60	50 x 30 mm	6 mm	FINE	10
RGPO50/30VF	€ 5,60	50 x 30 mm	6 mm	VERY FINE	10
RGPO60/30C	€ 5,80	60 x 30 mm	6 mm	COARSE	10
RGPO60/30M	€ 5,80	60 x 30 mm	6 mm	MEDIUM	10
RGPO60/30F	€ 5,80	60 x 30 mm	6 mm	FINE	10
RGPO60/30VF	€ 5,80	60 x 30 mm	6 mm	VERY FINE	10
RGPO80/50C	€ 9,00	80 x 50 mm	6 mm	COARSE	10
RGPO80/50M	€ 9,00	80 x 50 mm	6 mm	MEDIUM	10
RGPO80/50F	€ 9,00	80 x 50 mm	6 mm	FINE	10
RGPO80/50VF	€ 9,00	80 x 50 mm	6 mm	VERY FINE	10

RLFX

RUOTE LAMELLARI CON FORO FILETTATO

Per l'impiego con smerigliatrici angolari (foro filettato M14). Per rimuovere leggere saldature su superfici tonde e sagomate.



Art.	€	Misura	Filetto	Grana	Max rpm
RLF115/040	€ 14,40	Ø 115 x 20 mm	M14	40	9000
RLF115/060	€ 14,40	Ø 115 x 20 mm	M14	60	9000
RLF115/080	€ 14,40	Ø 115 x 20 mm	M14	80	9000
RLF115/120	€ 14,40	Ø 115 x 20 mm	M14	120	9000
RLF125/040	€ 15,70	Ø 115 x 20 mm	M14	40	9000
RLF125/060	€ 15,70	Ø 125 X 20 mm	M14	60	9000
RLF125/080	€ 15,70	Ø 125 X 20 mm	M14	80	9000
RLF125/120	€ 15,70	Ø 125 X 20 mm	M14	120	9000

RFPX
RUOTE CON FORO IN PANNO ABRASIVO

Costituite da lamelle di panno abrasivo disposte in senso radiale.

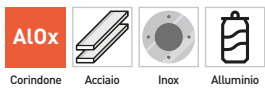

Art.	€	Dimensioni	Grana
RFP165/50M	€ 17,80	165 x 50 x 65 mm	Medium
RFP165/50F	€ 17,80	165 x 50 x 65 mm	Fine
RFP165/50VF	€ 17,80	165 x 50 x 65 mm	Very Fine
RFP200/50M	€ 24,90	200 x 50 x 110 mm	Medium
RFP200/50F	€ 24,90	200 x 50 x 110 mm	Fine
RFP200/50VF	€ 24,90	200 x 50 x 110 mm	Very Fine

RLMX
RUOTE LAMELLARI MISTE

Art.	€	Dimensioni	Panno	Tela	Diametro foro
RLM100/060C	€ 19,90	100 x 100 mm	A/C	60	19 mm
RLM100/080M	€ 19,90	100 x 100 mm	A/M	80	19 mm
RLM100/150F	€ 19,90	100 x 100 mm	A/F	150	19 mm

NAS100X-Z
NASTRI IN ZIRCONIO

Art.	€	Dimensioni	Grana
NAS100/040Z	€ 2,89	90 x 100 mm	40
NAS100/060Z	€ 2,89	90 x 100 mm	60
NAS100/080Z	€ 2,89	90 x 100 mm	80
NAS100/120Z	€ 2,89	90 x 100 mm	120

RLTX
RUOTE LAMELLARI IN TELA

Art.	€	Dimensioni	Grana	Diametro foro
RLT050/040	€ 16,70	100 x 50 mm	40	19 mm
RLT050/060	€ 16,70	100 x 50 mm	60	19 mm
RLT050/080	€ 16,70	100 x 50 mm	80	19 mm
RLT050/120	€ 16,70	100 x 50 mm	120	19 mm
RLT100/040	€ 24,30	100 x 100 mm	40	19 mm
RLT100/060	€ 24,30	100 x 100 mm	60	19 mm
RLT100/080	€ 25,40	100 x 100 mm	80	19 mm
RLT100/120	€ 25,40	100 x 100 mm	120	19 mm

RLPX
RUOTE LAMELLARI IN PANNO ABRASIVO

Colore diversificato in base alla grana.



Art.	€	Dimensioni	Grana	Diametro foro
RLP100/C	€ 17,60	100 x 100 mm	A/O-C	19 mm
RLP100/M	€ 16,60	100 x 100 mm	A/O-M	19 mm
RLP100/F	€ 16,60	100 x 100 mm	A/O-F	19 mm
RLP100/VF	€ 16,60	100 x 100 mm	A/O-VF	19 mm

NAS100X-A
NASTRI IN OSSIDO DI ALLUMINIO

Art.	€	Dimensioni	Grana
NAS100/180A	€ 2,61	90 x 100 mm	180
NAS100/240A	€ 2,61	90 x 100 mm	240



NAS100X-C

NASTRI CERAMICI



Art.	€	Dimensioni	Grana
NAS100/040C	€ 5,80	90 x 100 mm	40
NAS100/060C	€ 5,30	90 x 100 mm	60
NAS100/080C	€ 4,99	90 x 100 mm	80
NAS100/120C	€ 4,53	90 x 100 mm	120

NAT100X

NASTRI TRIZACT



Art.	€	Dimensioni	Grana
NAT100/A006	€ 9,30	90 x 100 mm	A6
NAT100/A016	€ 9,30	90 x 100 mm	A16
NAT100/A030	€ 9,30	90 x 100 mm	A30
NAT100/A045	€ 9,30	90 x 100 mm	A45
NAT100/A065	€ 9,30	90 x 100 mm	A65
NAT100/A100	€ 9,30	90 x 100 mm	A100
NAT100/A160	€ 9,30	90 x 100 mm	A160

SCSX

NASTRI SURFACE CONDITIONING

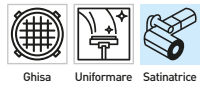

Art.	€	Dimensioni	Grana
SCS100/C	€ 14,90	90 x 100 mm	Coarse
SCS100/M	€ 14,20	90 x 100 mm	Medium
SCS100/VF	€ 14,20	90 x 100 mm	Very fine

RPW090

€ 98,60

ESPANSORE PNEUMATICO



Satinatrice



Dimensioni	90 x 90 mm
Foro	19.1 mm
Max rpm	6000

ERW100

€ 82,80

ESPANSORE CENTRIFUGO



Satinatrice



Dimensioni	90 x 100 mm
Foro	19.1 mm
Max rpm	6000

SWS100

€ 90,10

RUOTA IN FILI DI ACCIAIO OTTONATO

Per sbavare, sverniciare, eliminare ruggine e calamina e rusticare il legno.



Dimensioni	100 x 100 mm
Foro	19.1 mm
Filo	0.3 mm
Max rpm	6800

SWS100/M

€ 104,00

RUOTA IN FILI DI ACCIAIO OTTONATO

Adatto a macchine Makita, per sbavare, sverniciare, eliminare ruggine e calamina e rusticare il legno.



Dimensioni	100 x 100 mm
Foro	13 mm
Filo	0.3 mm
Max rpm	6800

NWS100

€ 156,00

RUOTE IN FILO DI NYLON ABRASIVO

Per pulire i metalli e rusticare il legno.



Dimensioni	100 x 100 mm
Foro	19.1 mm
Grana	80
Max rpm	6800

NWS100/M

€ 167,00

RUOTE IN FILO DI NYLON ABRASIVO

Adatto a macchine Makita, per pulire i metalli e rusticare il legno.



Dimensioni	100 x 100 mm
Foro	13 mm
Grana	80
Max rpm	6800



**FDCX****FIBRODISCO FLESSIBILE VIPER**

Disco flessibile innovativo a centro depresso con supporto in fibra integrato per una operazione di sbavatura veloce precisa e confortevole di superfici piane e curve, cordoni di saldatura e spigoli vivi.

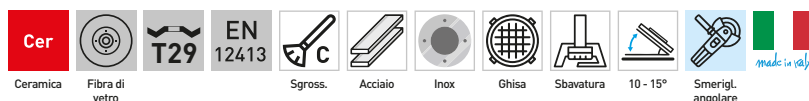

Art.	€	Dimensioni	Durezza	Max rpm	Pack
FDC115/036	€ 5,00	115x22,23 mm	SG 36	13300	25
FDC115/060	€ 5,00	115x22,23 mm	SG 60	13300	25
FDC115/120	€ 5,00	115x22,23 mm	SG 120	13300	25
FDC125/036	€ 5,20	125x22,23 mm	SG 36	12250	25

**DFVX-XZ****DISCHI IN FIBRA VULCANIZZATA CON SUPPORTO ADESIVO**

I dischi in fibra sono costituiti da un supporto di spessore 0,8 mm in fibra di cellulosa vulcanizzata sulla quale vengono depositi vari tipi di abrasivo. Questi sono legati con un doppio strato di resina termoindurente additivata con cariche attive che conferiscono ai prodotti proprietà raffreddanti e anti intasamento. Applicati ad un platello di supporto, vengono usati su levigatrici portatili.

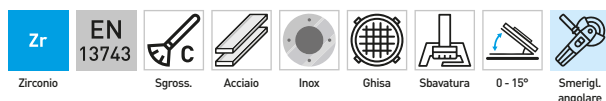

Art.	€	Dimensioni	Grana	Max rpm	Pack
DFV115/036Z	€ 0,91	115 x 22 mm	36	13300	25
DFV115/040Z	€ 0,81	115 x 22 mm	40	13300	25
DFV115/060Z	€ 0,75	115 x 22 mm	60	13300	25
DFV115/080Z	€ 0,69	115 x 22 mm	80	13300	25
DFV115/120Z	€ 0,60	115 x 22 mm	120	13300	25
DFV180/036Z	€ 2,05	180 x 22 mm	36	8600	25
DFV180/040Z	€ 1,83	180 x 22 mm	40	8600	25
DFV180/060Z	€ 1,57	180 x 22 mm	60	8600	25
DFV180/080Z	€ 1,51	180 x 22 mm	80	8600	25
DFV180/120Z	€ 1,34	180 x 22 mm	120	8600	25

**DFVX-XA****DISCHI IN FIBRA VULCANIZZATA CON SUPPORTO ADESIVO**

I dischi in fibra sono costituiti da un supporto di spessore 0,8 mm in fibra di cellulosa vulcanizzata sulla quale vengono depositi vari tipi di abrasivo. Questi sono legati con un doppio strato di resina termoindurente additivata con cariche attive che conferiscono ai prodotti proprietà raffreddanti e anti intasamento. Applicati ad un platello di supporto, vengono usati su levigatrici portatili.



Art.	€	Dimensioni	Grana	Max rpm	Pack
DFV115/024A	€ 0,65	115 x 22 mm	24	13300	25
DFV115/036A	€ 0,69	115 x 22 mm	36	13300	25
DFV115/060A	€ 0,65	115 x 22 mm	60	13300	25
DFV115/080A	€ 0,53	115 x 22 mm	80	13300	25
DFV115/120A	€ 0,53	115 x 22 mm	120	13300	25
DFV180/024A	€ 1,45	180 x 22 mm	24	8600	25
DFV180/036A	€ 1,40	180 x 22 mm	36	8600	25
DFV180/060A	€ 1,31	180 x 22 mm	60	8600	25
DFV180/080A	€ 1,24	180 x 22 mm	80	8600	25



PFBX
PLATORELLI DI SUPPORTO

Standard per dischi fibriati, di tipo professionale, duro.

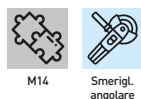

Art.	€	Diametro ø	Filetto	Max rpm
PFB115	€ 5,60	115 mm	M14	13300
PFB180	€ 9,70	180 mm	M14	8500

PFSX
PLATORELLI DI SUPPORTO

Per dischi fibriati. Le scanalature favoriscono una dispersione del calore e un contatto più aggressivo con la superficie. Adatto per lavorazioni con pressioni forti sul disco, per utilizzo di grane grosse. Molto duro.

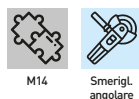

Art.	€	Diametro ø	Filetto	Max rpm
PFS115	€ 10,80	115 mm	M14	13300
PFS180	€ 19,30	180 mm	M14	8500

MDAXZT
FAST LOCK ZIRCONIO TOP SIZE

Ad attacco rapido. Lunga durata e finitura costante, per asportare con precisione e per lavorare in piccole aree e sui bordi.



Art.	€	Diametro ø	Grana	Max rpm	Pack
MDA050/036ZT	€ 0,84	50 mm	36	25000	25
MDA050/060ZT	€ 0,83	50 mm	60	25000	25
MDA050/080ZT	€ 0,83	50 mm	80	25000	25
MDA050/120ZT	€ 0,83	50 mm	120	25000	25
MDA075/036ZT	€ 1,40	75 mm	36	20000	25
MDA075/060ZT	€ 1,33	75 mm	60	20000	25
MDA075/080ZT	€ 1,33	75 mm	80	20000	25
MDA075/120ZT	€ 1,33	75 mm	120	20000	25

D17X
DISCHI ABRASIVI CON SUPPORTO ADESIVO

Art.	€	Misure	Grana	Pack
D174	€ 1,47	150 mm	60	10
D175	€ 1,47	150 mm	100	10
D178/060	€ 1,47	200 mm	60	10
D178/100	€ 1,47	200 mm	100	10
D176	€ 2,48	226 mm	60	10
D177	€ 2,48	226 mm	100	10



VDAX

NEW

DISCHI VELCRATI

Corindone resinato su carta pesante (peso F), cosparsione chiusa.



AlOx



Acciaio



Alluminio



Legno



Cuoio



Prep. Superficie



Levigatrice Orbitale

Art.	€	Diametro ø	Fori	Grana	Pack
VDA115/040	€ 0,33	115 mm	-	40	50
VDA115/060	€ 0,33	115 mm	-	60	100
VDA115/080	€ 0,33	115 mm	-	80	100
VDA115/100	€ 0,33	115 mm	-	100	100
VDA115/120	€ 0,33	115 mm	-	120	100
VDA115/180	€ 0,33	115 mm	-	180	100
VDA115/220	€ 0,33	115 mm	-	220	100
VDA125/40F8	€ 0,41	125 mm	8	40	50
VDA125/60F8	€ 0,37	125 mm	8	60	100
VDA125/80F8	€ 0,37	125 mm	8	80	100
VDA125/100F8	€ 0,37	125 mm	8	100	100
VDA125/120F8	€ 0,37	125 mm	8	120	100
VDA125/180F8	€ 0,37	125 mm	8	180	100
VDA125/220F8	€ 0,37	125 mm	8	220	100
VDA150/040	€ 0,52	150 mm	-	40	50
VDA150/060	€ 0,47	150 mm	-	60	100
VDA150/080	€ 0,47	150 mm	-	80	100
VDA150/100	€ 0,47	150 mm	-	100	100
VDA150/120	€ 0,47	150 mm	-	120	100
VDA150/180	€ 0,47	150 mm	-	180	100
VDA150/220	€ 0,47	150 mm	-	220	100
VDA150/040F6	€ 0,52	150 mm	6	40	50
VDA150/060F6	€ 0,47	150 mm	6	60	100
VDA150/080F6	€ 0,47	150 mm	6	80	100
VDA150/100F6	€ 0,47	150 mm	6	100	100
VDA150/120F6	€ 0,47	150 mm	6	120	100
VDA150/180F6	€ 0,47	150 mm	6	180	100
VDA150/220F6	€ 0,47	150 mm	6	220	100
VDA150/040F8	€ 0,38	150 mm	8	40	10
VDA150/060F8	€ 0,38	150 mm	8	60	10
VDA150/080F8	€ 0,38	150 mm	8	80	10
VDA150/100F8	€ 0,38	150 mm	8	100	10
VDA150/120F8	€ 0,38	150 mm	8	120	10
VDA150/180F8	€ 0,38	150 mm	8	180	10
VDA150/220F8	€ 0,38	150 mm	8	220	10

VDGX

DISCO VELCRATO GOLD

Corindone stearato doppia resina su carta leggera (peso C), cosparsione semi aperta. L'aggiunta di stearato di zinco previene l'intasamento.



AlOx



Alluminio



Legno



Vernici



Compositi



Prep. Superficie



A secco



Levigatrice Orbitale

Art.	€	Diametro	Grana	Fori	Pack
VDG150/060	€ 0,49	ø 150 mm	60	-	100
VDG150/080	€ 0,47	ø 150 mm	80	-	100
VDG150/120	€ 0,47	ø 150 mm	120	-	100
VDG150/150	€ 0,47	ø 150 mm	150	-	100
VDG150/180	€ 0,47	ø 150 mm	180	-	100
VDG150/220	€ 0,47	ø 150 mm	220	-	100
VDG150/320	€ 0,47	ø 150 mm	320	-	100
VDG150/400	€ 0,47	ø 150 mm	400	-	100
VDG150/600	€ 0,47	ø 150 mm	600	-	100
VDG150/800	€ 0,47	ø 150 mm	800	-	100
VDG150/060F6	€ 0,49	ø 150 mm	60	6	100
VDG150/080F6	€ 0,47	ø 150 mm	80	6	100
VDG150/120F6	€ 0,47	ø 150 mm	120	6	100
VDG150/150F6	€ 0,47	ø 150 mm	150	6	100
VDG150/180F6	€ 0,47	ø 150 mm	180	6	100
VDG150/220F6	€ 0,47	ø 150 mm	220	6	100
VDG150/320F6	€ 0,47	ø 150 mm	320	6	100
VDG150/400F6	€ 0,47	ø 150 mm	400	6	100
VDG150/600F6	€ 0,47	ø 150 mm	600	6	100
VDG150/800F6	€ 0,47	ø 150 mm	800	6	100
VDG150/060F8	€ 0,49	ø 150 mm	60	8	100
VDG150/080F8	€ 0,47	ø 150 mm	80	8	100
VDG150/120F8	€ 0,47	ø 150 mm	120	8	100
VDG150/150F8	€ 0,47	ø 150 mm	150	8	100
VDG150/180F8	€ 0,47	ø 150 mm	180	8	100
VDG150/220F8	€ 0,47	ø 150 mm	220	8	100
VDG150/320F8	€ 0,47	ø 150 mm	320	8	100
VDG150/400F8	€ 0,47	ø 150 mm	400	8	100
VDG150/600F8	€ 0,47	ø 150 mm	600	8	100
VDG150/800F8	€ 0,47	ø 150 mm	800	8	100

ZSAX
DISCHI VELCRATI

Corindone stearato doppia resina su carta leggera (peso C), cosparsione chiusa. L'aggiunta di stearato di zinco previene l'intasamento.

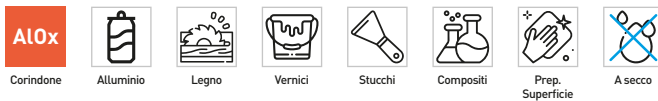
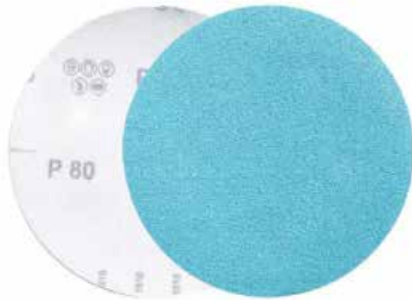

Art.	€	Diametro ø	Fori	Grana	Pack
ZSA150/080	€ 0,47	150 mm	-	80	100
ZSA150/120	€ 0,43	150 mm	-	120	100
ZSA150/180	€ 0,43	150 mm	-	180	100
ZSA150/240	€ 0,43	150 mm	-	240	100
ZSA150/320	€ 0,43	150 mm	-	320	100
ZSA150/400	€ 0,43	150 mm	-	400	100
ZSA150/80F6	€ 0,47	150 mm	6	80	100
ZSA150/120F6	€ 0,43	150 mm	6	120	100
ZSA150/180F6	€ 0,43	150 mm	6	180	100
ZSA150/240F6	€ 0,43	150 mm	6	240	100
ZSA150/320F6	€ 0,43	150 mm	6	320	100
ZSA150/400F6	€ 0,43	150 mm	6	400	100

VDRX
DISCHI IN RETE VELCRATI

Supporto fatto di rete permette di aspirare fino al 90% delle polveri generate dall'abrasione, resiste al calore rendendoli utilizzabili anche con smerigliatrici angolari, utilizzabile a secco e umido. Durata più lunga ed ambiente di lavoro più sano grazie all'aspirazione dei residui.

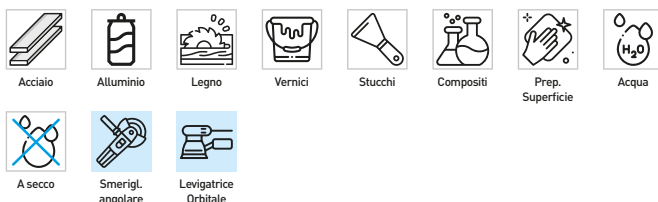
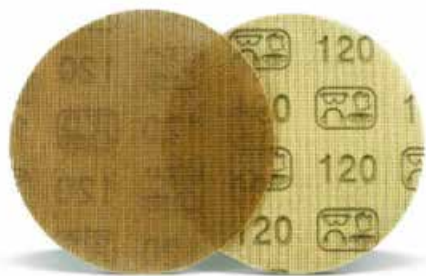

Art.	€	Diametro ø	Grana	Pack
VDR150/080	€ 0,90	150 mm	80	50
VDR150/120	€ 0,90	150 mm	120	50
VDR150/180	€ 0,90	150 mm	180	50
VDR150/240	€ 0,90	150 mm	240	50
VDR150/320	€ 0,90	150 mm	320	50
VDR150/400	€ 0,90	150 mm	400	50
VDR150/600	€ 0,90	150 mm	600	50

VDZX
NEW
DISCHI VELCRATI

Zirconio resinato su carta pesante (peso F), cosparsione chiusa. Qualità top, molto aggressivo e di lunga durata, il supporto resiste a sollecitazioni e velocità più elevate dei dischi di carta.

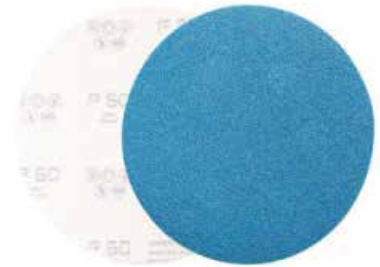

Art.	€	Diametro ø	Grana	Pack
VDZ115/040	€ 0,71	115 mm	40	50
VDZ115/060	€ 0,69	115 mm	60	100
VDZ115/080	€ 0,64	115 mm	80	100
VDZ115/120	€ 0,59	115 mm	120	100
VDZ125/040	€ 0,86	125 mm	40	100
VDZ125/060	€ 0,74	125 mm	60	100
VDZ125/080	€ 0,71	125 mm	80	100
VDZ125/120	€ 0,64	125 mm	120	100
VDZ150/040	€ 1,13	150 mm	40	50
VDZ150/060	€ 0,95	150 mm	60	100
VDZ150/080	€ 0,90	150 mm	80	100
VDZ150/120	€ 0,86	150 mm	120	100
VDZ150/040F8	€ 0,50	150 mm	40	10
VDZ150/060F8	€ 0,50	150 mm	60	10
VDZ150/080F8	€ 0,50	150 mm	80	10
VDZ150/100F8	€ 0,50	150 mm	100	10
VDZ150/120F8	€ 0,50	150 mm	120	10

PDBX
PLATORELLI SENZA MOUSSE

Per dischi velcrati.

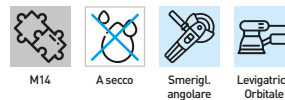

Art.	€	Diametro ø	Filetto	Max rpm
PDB115/M14	€ 10,10	115 mm	M14	13300
PDB125/M14	€ 11,50	125 mm	M14	12200
PDB150/M14	€ 15,50	150 mm	M14	10000

PDMX
PLATORELLI CON MOUSSE

Versione professionale, per dischi velcrati, per adattarsi meglio al pezzo da lavorare.



Art.	€	Diametro ø	Spessore	Filetto	Max rpm
PDM115/12M14	€ 18,00	115 mm	12 mm	M14	13300
PDM125/12M14	€ 20,50	125 mm	12 mm	M14	12200
PDM150/12M14	€ 23,40	150 mm	12 mm	M14	10000

**PMEX****PLATORELLI CON MOUSSE**

Per dischi velcrati, per adattarsi meglio al pezzo da lavorare.



M14



A secco



Smerigl. angolare



Levigatrice Orbitale



Art.	€	Diametro ø	Spessore	Filetto	Max rpm
PME125/18M14	€ 5,60	125 mm	18 mm	M14	6800
PME150/12M14	€ 7,90	150 mm	12 mm	M14	10000

PPSX**PLATORELLI IN POLIURETANO**

Per dischi velcrati, versione morbida.



M14



A secco



Smerigl. angolare



Levigatrice Orbitale



Art.	€	Diametro ø	Spessore	Filetto	Max rpm
PPS125/27M14	€ 22,10	125 mm	27 mm	M14	8000
PPS150/29M14	€ 23,70	150 mm	29 mm	M14	7000

PDVX-M14**PLATORELLO CON VENTILAZIONE**

Per dischi velcrati, le scanalature migliorano la dispersione del calore aumentando la vita dell'abrasivo evitando il surriscaldamento del pezzo da lavorare.



M14



A secco



Smerigl. angolare



Levigatrice Orbitale



Art.	€	Diametro ø	Filetto
PDV115/M14	€ 34,20	115 mm	M14
PDV125/M14	€ 35,10	125 mm	M14
PDV150/M14	€ 38,60	150 mm	M14

0459

€ 7,80

PLATORELLO CON FISSAGGIO A STRAPPO

Da 150 mm, con 6 fori, filetto maschio da 5/16"-24 filetti per pollice.



Append.



Diametro disco	150 mm - 6"
Velocità max di utilizzo	12000 rpm

PFLX**PLATORELLI PER LEVIGATRICI ROTORBITALI**

A secco



Levigatrice Orbitale

Art.	€	Diametro ø	Spessore	Gambo	Fori	Max rpm
PFL125/10F8	€ 16,10	125 mm	10 mm	5/16" mm	8	12000
PFL150/10	€ 18,80	150 mm	10 mm	5/16" mm	-	10000
PFL150/10F6	€ 20,20	150 mm	10 mm	5/16" mm	6	10000

**TEV120**

€ 10,80

BLOCCO PER DISCHI VELCRATI

Forma ergonomica, cambio rapido del foglio abrasivo.



A secco



Utilizzo Manuale



Misura	70 x 120 mm
--------	-------------

TDV

€ 19,60

BLOCCO PER DISCHI VELCRATI

Consente di usare a mano i dischi a strappo.



A secco



Utilizzo Manuale



Misura	150 mm
--------	--------

RASX
ROTOLI ANTI SPRECO

Tela extra flessibile doppia resina. Specifica per torneria, stampi, armi e per tutte le lavorazioni che necessitano di una tela ad elevata flessibilità e durata superiore

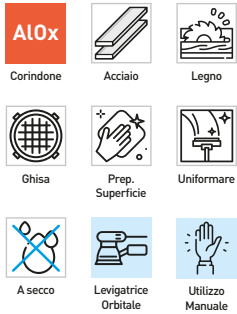

Art.	€	Dimensioni	Grana
RAS40	€ 29,50	50 mm x 25 m	40
RAS60	€ 26,60	50 mm x 25 m	60
RAS80	€ 25,20	50 mm x 25 m	80
RAS120	€ 22,10	50 mm x 25 m	120
RAS180	€ 22,10	50 mm x 25 m	180
RAS220	€ 22,10	50 mm x 25 m	220
RAS320	€ 22,10	50 mm x 25 m	320
RAS400	€ 22,10	50 mm x 25 m	400

RSSX
ROTOLI ANTI SPRECO IN SPUGNA

Carta auto lubrificante (peso C) al corindone accoppiata con spugna.

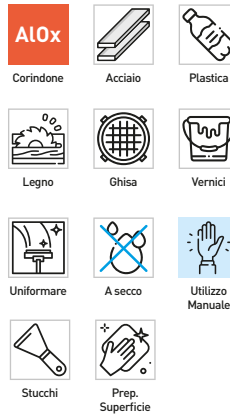

Art.	€	Dimensioni	Grana
RSS150	€ 73,70	115 mm x 25 m	150
RSS180	€ 73,70	115 mm x 25 m	180
RSS240	€ 73,70	115 mm x 25 m	240
RSS320	€ 73,70	115 mm x 25 m	320
RSS400	€ 73,70	115 mm x 25 m	400
RSS500	€ 73,70	115 mm x 25 m	500
RSS600	€ 73,70	115 mm x 25 m	600
RSS800	€ 73,70	115 mm x 25 m	800
RSS1000	€ 73,70	115 mm x 25 m	1000

RSRX
ROTOLI A STRAPPO VELCRATI DI CARTA RESINATA

Carta al corindone antistatica, cosparsione semi aperta, peso E. Uso a secco, adatta alla lavorazione di legno, pelle, stucchi e metallo.

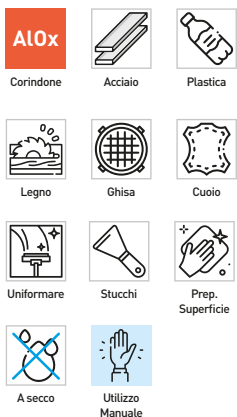

Art.	€	Dimensioni	Grana
RSR115/050/040	€ 67,40	115 x 25 m	40
RSR115/050/060	€ 58,30	115 x 25 m	60
RSR115/050/080	€ 54,00	115 x 25 m	80
RSR115/050/120	€ 52,80	115 x 25 m	120

RSAX
ROTOLI A STRAPPO VELCRATI DI CARTA AUTOLUBRIFICANTE

Corindone stearato su carta leggera (peso C), cosparsione semi aperta, uso a secco.

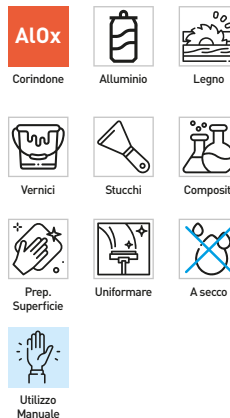

Art.	€	Dimensioni	Grana
RSA115/25/080	€ 51,90	115 mm x 25 m	80
RSA115/25/120	€ 51,90	115 mm x 25 m	120
RSA115/25/150	€ 51,90	115 mm x 25 m	150
RSA115/25/180	€ 51,90	115 mm x 25 m	180
RSA115/25/220	€ 51,90	115 mm x 25 m	220
RSA115/25/320	€ 51,90	115 mm x 25 m	320

**FTRX****FOGLI DI TELA RESINATA**

Tela flessibile con supporto in cotone.



Art.	€	Dimensioni	Grana	Pack
FTR230/040	€ 1,48	230 x 280 mm	40	50
FTR230/060	€ 1,33	230 x 280 mm	60	50
FTR230/080	€ 1,22	230 x 280 mm	80	50
FTR230/120	€ 1,08	230 x 280 mm	120	50
FTR230/180	€ 1,08	230 x 280 mm	180	50
FTR230/220	€ 1,08	230 x 280 mm	220	50
FTR230/320	€ 1,08	230 x 280 mm	320	50
FTR230/400	€ 1,08	230 x 280 mm	400	50
FTR230/600	€ 1,22	230 x 280 mm	600	50

RTFX**ROTTOLI DI TELA RESINATA**

Molto flessibile e resistente. Adatta per lavorare superfici sia piane che sagomate.



Art.	€	Dimensioni	Grana	Pack
RTF120/005/060	€ 7,90	115 mm x 5 m	60	10
RTF120/005/080	€ 7,90	115 mm x 5 m	80	10
RTF120/005/100	€ 7,90	115 mm x 5 m	100	10
RTF120/005/120	€ 7,90	115 mm x 5 m	120	10
RTF120/050/040	€ 64,70	115 mm x 50 m	40	10
RTF120/050/060	€ 64,70	115 mm x 50 m	60	10
RTF120/050/080	€ 64,70	115 mm x 50 m	80	10
RTF120/050/100	€ 64,70	115 mm x 50 m	100	10
RTF120/050/120	€ 64,70	115 mm x 50 m	120	10

CARX**NEW****CARTA ABRASIVA RETTANGOLARE**

Art.	€	Dimensioni	Fori	Grana	Pack
CAR115280/060	€ 0,52	280 x 115 mm	14	60	10
CAR115280/080	€ 0,52	280 x 115 mm	14	80	10
CAR115280/120	€ 0,52	280 x 115 mm	14	120	10

RCLX**ROTTOLI DI CARTA LATTICE**

Carta supporto lattice per finitura a secco o umido, impiegata per la finitura e levigatura di stampi metallici, pezzi di fibra di carbonio, fibra di vetro, materiali compositi e strumenti di precisione.



Art.	€	Dimensioni	Grana
RCL115/100/120	€ 128,00	115 mm x 100 m	120
RCL115/100/150	€ 128,00	115 mm x 100 m	150
RCL115/100/180	€ 128,00	115 mm x 100 m	180

RCSX
ROTTOLI DI CARTA STEARATA

Rotoli al corindone, anti intasamento, ideale per superfici verniciate. Flessibile e resistente. L'aggiunta di stearato di zinco previene l'intasamento.



Art.	€	Dimensioni	Grana
RCS115/050/150	€ 70,30	115 mm x 50 m	150
RCS115/050/180	€ 70,30	115 mm x 50 m	180
RCS115/050/240	€ 70,30	115 mm x 50 m	240
RCS115/050/320	€ 70,30	115 mm x 50 m	320
RCS115/050/400	€ 70,30	115 mm x 50 m	400
RCS115/050/600	€ 70,30	115 mm x 50 m	600

FLIX
CARTA LATTICE IMPERMEABILE

Carta supporto lattice al carburo di silicio di alta qualità, molto flessibile per finitura a secco o a umido. Per superfici verniciate, carrozzeria, elettronica, metalli preziosi, strumenti musicali, modellismo.

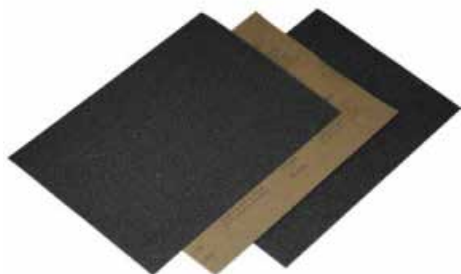

Art.	€	Dimensioni	Grana	Pack
FLI230/240	€ 0,66	230 x 280 mm	240	100
FLI230/320	€ 0,66	230 x 280 mm	320	100
FLI230/400	€ 0,66	230 x 280 mm	400	100
FLI230/600	€ 0,66	230 x 280 mm	600	100
FLI230/800	€ 0,66	230 x 280 mm	800	100
FLI230/1000	€ 0,66	230 x 280 mm	1000	100
FLI230/1200	€ 0,66	230 x 280 mm	1200	100

SPIXZ
ANELLI ABRASIVI RINFORZATI SPIRABANDS

Creati con strisce di tela abrasiva, avvolta e incollata su un supporto di cotone, ideali per la rettifica di alluminio o acciaio. Da utilizzare con i relativi portamicocotti in gomma. Per raggiungere parti difficilmente accessibili o mantenere le raggiate.



Art.	€	Dimensioni	Grana	Max rpm	Pack
SPI1020/040Z	€ 0,34	10 x 20 mm	40	36000	100
SPI1020/060Z	€ 0,33	10 x 20 mm	60	36000	100
SPI1020/080Z	€ 0,33	10 x 20 mm	80	36000	100
SPI1020/120Z	€ 0,33	10 x 20 mm	120	36000	100
SPI1530/040Z	€ 0,47	15 x 30 mm	40	26000	100
SPI1530/060Z	€ 0,45	15 x 30 mm	60	26000	100
SPI1530/080Z	€ 0,45	15 x 30 mm	80	26000	100
SPI1530/120Z	€ 0,45	15 x 30 mm	120	26000	100
SPI2030/040Z	€ 0,56	20 x 30 mm	40	18000	100
SPI2030/060Z	€ 0,53	20 x 30 mm	60	18000	100
SPI2030/080Z	€ 0,53	20 x 30 mm	80	18000	100
SPI2030/120Z	€ 0,53	20 x 30 mm	120	18000	100
SPI2220/040Z	€ 0,45	22 x 20 mm	40	17000	100
SPI2220/060Z	€ 0,45	22 x 20 mm	60	17000	100
SPI2220/080Z	€ 0,45	22 x 20 mm	80	17000	100
SPI2220/120Z	€ 0,45	22 x 20 mm	120	17000	100
SPI2525/040Z	€ 0,60	25 x 25 mm	40	15000	100
SPI2525/060Z	€ 0,56	25 x 25 mm	60	15000	100
SPI2525/080Z	€ 0,56	25 x 25 mm	80	15000	100
SPI2525/120Z	€ 0,56	25 x 25 mm	120	15000	100
SPI3030/040Z	€ 0,66	30 x 30 mm	40	13000	100
SPI3030/060Z	€ 0,65	30 x 30 mm	60	13000	100
SPI3030/080Z	€ 0,65	30 x 30 mm	80	13000	100
SPI3030/120Z	€ 0,65	30 x 30 mm	120	13000	100
SPI4530/040Z	€ 0,90	45 x 30 mm	40	8500	100
SPI4530/060Z	€ 0,81	45 x 30 mm	60	8500	100
SPI4530/080Z	€ 0,81	45 x 30 mm	80	8500	100
SPI4530/120Z	€ 0,81	45 x 30 mm	120	8500	100

SGCX
PORTAMANICOTTI

Portamanicotti ad espansione, per il fissaggio dei manicotti abrasivi.



Smerigl. assiale



Art.	€	Dimensioni	Gambo	Max rpm
SGC1020	€ 7,20	10 x 20 mm	6 mm	36000
SGC1530	€ 6,60	15 x 30 mm	6 mm	26000
SGC2030	€ 9,20	20 x 30 mm	6 mm	18000
SGC2220	€ 6,80	22 x 20 mm	6 mm	17000
SGC2525	€ 9,20	25 x 25 mm	6 mm	15000
SGC3030	€ 9,40	30 x 30 mm	6 mm	13300
SGC4530	€ 11,40	45 x 30 mm	6 mm	8500

CRDXT
RULLINI AVVOLTI

Utensili di piccole dimensioni per operazioni di smerigliatura in punti di difficile accesso, può lavorare anche di punta. La tela avvolta su se stessa dà all'utensile una maggiore durata rispetto ai manicotti tradizionali. Utilizzo universale su acciaio, metalli non ferrosi e plastica.



Art.	€	Dimensioni	Grana	Forma	Pack
CRD1038/060T	€ 0,84	10 x 38 mm	60	Conica	50
CRD1038/080T	€ 0,84	10 x 38 mm	80	Conica	50
CRD1038/120T	€ 0,84	10 x 38 mm	120	Conica	50
CRD1238/060T	€ 1,02	12 x 38 mm	60	Conica	50
CRD1238/080T	€ 1,02	12 x 38 mm	80	Conica	50
CRD1238/120T	€ 1,02	12 x 38 mm	120	Conica	50

CRDXC
RULLINI AVVOLTI

Utensili di piccole dimensioni per operazioni di smerigliatura in punti di difficile accesso, può lavorare anche di punta. La tela avvolta su se stessa dà all'utensile una maggiore durata rispetto ai manicotti tradizionali. Utilizzo universale su acciaio, metalli non ferrosi e plastica.



Art.	€	Dimensioni	Grana	Forma	Pack
CRD0638/060C	€ 0,56	6 x 38 mm	60	Cilindrica	50
CRD0638/080C	€ 0,56	6 x 38 mm	80	Cilindrica	50
CRD0638/120C	€ 0,56	6 x 38 mm	120	Cilindrica	50
CRD1038/040C	€ 0,75	10 x 38 mm	40	Cilindrica	50
CRD1038/060C	€ 0,75	10 x 38 mm	60	Cilindrica	50
CRD1038/080C	€ 0,75	10 x 38 mm	80	Cilindrica	50
CRD1038/120C	€ 0,75	10 x 38 mm	120	Cilindrica	50

PCR6338
€ 9,30
GAMBO PER RULLINI AVVOLTI

Smerigl. assiale

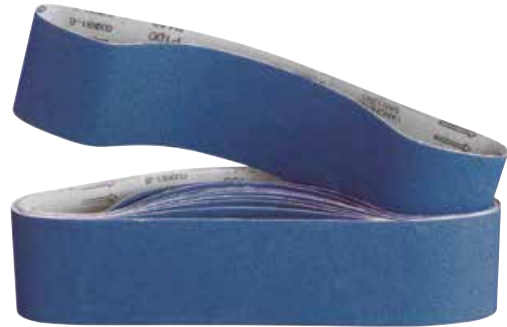

NTXA
NASTRI ABRASIVI

NTXZ
NASTRI ABRASIVI

Art.	€	Dimensioni	Grana	Pack
NT0440/035/040A	€ 1,96	440 x 35 mm	40	10
NT0440/035/060A	€ 1,96	440 x 35 mm	60	10
NT0440/035/080A	€ 1,96	440 x 35 mm	80	10
NT0440/035/120A	€ 1,96	440 x 35 mm	120	10
NT0533/075/040A	€ 3,73	533 x 75 mm	40	10
NT0533/075/060A	€ 3,73	533 x 75 mm	60	10
NT0533/075/080A	€ 3,73	533 x 75 mm	80	10
NT0533/075/120A	€ 3,73	533 x 75 mm	120	10
NT0686/050/040A	€ 5,50	686 x 50 mm	40	10
NT0686/050/060A	€ 5,50	686 x 50 mm	60	10
NT0686/050/080A	€ 5,50	686 x 50 mm	80	10
NT0686/050/100A	€ 5,50	686 x 50 mm	100	10
NT0686/050/120A	€ 5,50	686 x 50 mm	120	10
NT0914/100/040A	€ 7,70	914 x 100 mm	40	10
NT0914/100/060A	€ 7,70	914 x 100 mm	60	10
NT0914/100/080A	€ 7,70	914 x 100 mm	80	10
NT0914/100/100A	€ 7,70	914 x 100 mm	100	10
NT0914/100/120A	€ 7,70	914 x 100 mm	120	10
NT1000/100/040A	€ 7,90	1000 x 100 mm	40	10
NT1000/100/060A	€ 7,90	1000 x 100 mm	60	10
NT1000/100/080A	€ 7,90	1000 x 100 mm	80	10
NT1000/100/120A	€ 7,90	1000 x 100 mm	120	10
NT1075/025/040A	€ 4,82	1075 x 25 mm	40	10
NT1075/025/060A	€ 4,82	1075 x 25 mm	60	10
NT1075/025/080A	€ 4,82	1075 x 25 mm	80	10
NT1075/025/100A	€ 4,82	1075 x 25 mm	100	10
NT1075/025/120A	€ 4,82	1075 x 25 mm	120	10
NT1219/152/040A	€ 8,70	1219 x 152 mm	40	10
NT1219/152/060A	€ 8,70	1219 x 152 mm	60	10
NT1219/152/080A	€ 8,70	1219 x 152 mm	80	10
NT1219/152/100A	€ 8,70	1219 x 152 mm	100	10
NT1219/152/120A	€ 8,70	1219 x 152 mm	120	10
NT1500/120/040A	€ 7,40	1500 x 120 mm	40	10
NT1500/120/060A	€ 7,40	1500 x 120 mm	60	10
NT1500/120/080A	€ 7,40	1500 x 120 mm	80	10
NT1500/120/120A	€ 7,40	1500 x 120 mm	120	10
NT1750/150/040A	€ 10,80	1750 x 150 mm	40	10
NT1750/150/060A	€ 10,80	1750 x 150 mm	60	10
NT1750/150/080A	€ 10,80	1750 x 150 mm	80	10
NT1750/150/120A	€ 10,80	1750 x 150 mm	120	10

Art.	€	Dimensioni	Grana	Pack
NT0330/010/040Z	€ 0,83	330 x 10 mm	40	10
NT0330/010/060Z	€ 0,72	330 x 10 mm	60	10
NT0330/010/080Z	€ 0,72	330 x 10 mm	80	10
NT0330/010/120Z	€ 0,72	330 x 10 mm	120	10
NT520/020/040Z	€ 1,12	520 x 20 mm	40	10
NT520/020/060Z	€ 0,95	520 x 20 mm	60	10
NT520/020/080Z	€ 0,84	520 x 20 mm	80	10
NT520/020/120Z	€ 0,75	520 x 20 mm	120	10
NT0610/100/040Z	€ 4,20	610 x 100 mm	40	10
NT0610/100/060Z	€ 3,70	610 x 100 mm	60	10
NT0610/100/080Z	€ 3,50	610 x 100 mm	80	10
NT0610/100/120Z	€ 3,43	610 x 100 mm	120	10
NT0760/040/040Z	€ 2,27	760 x 40 mm	40	10
NT0760/040/060Z	€ 1,96	760 x 40 mm	60	10
NT0760/040/080Z	€ 1,96	760 x 40 mm	80	10
NT0760/040/120Z	€ 1,96	760 x 40 mm	120	10
NT0914/100/040Z	€ 5,50	914 x 100 mm	40	10
NT0914/100/060Z	€ 5,30	914 x 100 mm	60	10
NT0914/100/080Z	€ 5,30	914 x 100 mm	80	10
NT0914/100/120Z	€ 5,30	914 x 100 mm	120	10
NT1000/100/040Z	€ 5,40	1000 x 100 mm	40	10
NT1000/100/060Z	€ 4,55	1000 x 100 mm	60	10
NT1000/100/080Z	€ 4,55	1000 x 100 mm	80	10
NT1000/100/120Z	€ 4,44	1000 x 100 mm	120	10
NT1219/152/040Z	€ 11,40	1219 x 152 mm	40	10
NT1219/152/060Z	€ 9,30	1219 x 152 mm	60	10
NT1219/152/080Z	€ 9,30	1219 x 152 mm	80	10
NT1219/152/120Z	€ 9,30	1219 x 152 mm	120	10
NT1500/120/040Z	€ 9,10	1500 x 120 mm	40	10
NT1500/120/060Z	€ 7,70	1500 x 120 mm	60	10
NT1500/120/080Z	€ 7,70	1500 x 120 mm	80	10
NT1500/120/120Z	€ 7,70	1500 x 120 mm	120	10
NT1750/150/040Z	€ 9,30	1750 x 150 mm	40	10
NT1750/150/060Z	€ 8,50	1750 x 150 mm	60	10
NT1750/150/080Z	€ 8,50	1750 x 150 mm	80	10
NT1750/150/120Z	€ 8,50	1750 x 150 mm	120	10
NT2000/050/040Z	€ 5,20	2000 x 50 mm	40	10
NT2000/050/060Z	€ 4,14	2000 x 50 mm	60	10
NT2000/050/080Z	€ 4,14	2000 x 50 mm	80	10
NT2000/050/120Z	€ 4,14	2000 x 50 mm	120	10
NT2000/150/040Z	€ 16,60	2000 x 150 mm	40	10
NT2000/150/060Z	€ 14,50	2000 x 150 mm	60	10
NT2000/150/080Z	€ 14,50	2000 x 150 mm	80	10
NT2000/150/120Z	€ 14,50	2000 x 150 mm	120	10

SURFACE CONDITIONING

SCDX

DISCHI LAMELLARI SURFACE CONDITIONING

Composto da lamelle di surface conditioning. Finitura satinata, uniforme e controllata, ridotto sviluppo di calore, ridotto intasamento.

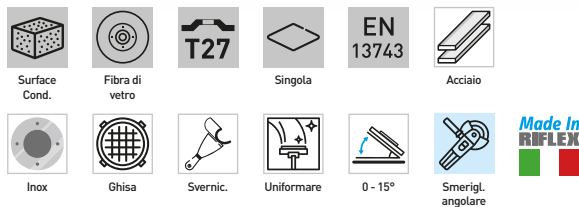

Art.	€	Dimensioni	Grana	Max rpm	Pack
SCD115/C	€ 7,10	Ø 115 x 22 mm	Coarse	13300	10
SCD115/M	€ 7,10	Ø 115 x 22 mm	Medium	13300	10
SCD115/VF	€ 7,10	Ø 115 x 22 mm	Very Fine	13300	10
SCD125/C	€ 8,80	Ø 125 x 22 mm	Coarse	12200	10
SCD125/M	€ 8,80	Ø 125 x 22 mm	Medium	12200	10
SCD125/VF	€ 8,80	Ø 125 x 22 mm	Very Fine	12200	10

SPA115/M14

€ 21,80

PLATORELLO DI SUPPORTO

Per dischi surface conditioning.



Diametro Ø	115 mm
Filetto	M14
Max rpm	13300

VSCX

DISCHI SURFACE CONDITIONING

Prodotto ideale per preparare le superfici alla verniciatura, per mascherare i difetti lasciando una finitura satinata e uniforme. Rimuove ossidazioni, graffi, vernici, segni di saldatura.



Art.	€	Diametro Ø	Grana	Max rpm	Pack
VSC115/080C	€ 4,17	115 mm	Coarse (80)	5100	10
VSC115/120M	€ 4,17	115 mm	Medium (120)	5100	10
VSC115/240VF	€ 4,17	115 mm	Very Fine (240)	5100	10

MSCX

FAST LOCK SURFACE CONDITIONING

Rimuove ossidazioni, graffi, vernici, segni di saldatura.

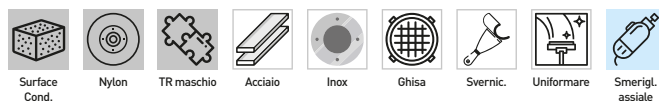

Art.	€	Diametro Ø	Grana	Max rpm	Pack
MSC050/C	€ 2,15	50 mm	Coarse	25000	10
MSC050/M	€ 2,15	50 mm	Medium	25000	10
MSC050/VF	€ 2,05	50 mm	Very Fine	25000	10
MSC075/C	€ 2,73	75 mm	Coarse	20000	25
MSC075/M	€ 2,73	75 mm	Medium	20000	25
MSC075/VF	€ 2,73	75 mm	Very Fine	20000	25

PARX
ROTOLI NON TESSUTO

Composti di fibra sintetica non tessuta, unita a particelle di grana abrasiva tramite resina. Resistenti ad acqua e lubrificanti, adatti per satinare, levigare, rimuovere residui di vernice o graffi, impiegati in settori diversi: metallo, legno, vernici, materie plastiche, ceramica.

FPA120-
FOGLI IN PANNO ABRASIVO

Composti di fibra sintetica non tessuta, unita a particelle di grana abrasiva tramite resina. Resistenti ad acqua e lubrificanti, adatti per satinare, levigare, rimuovere residui di vernice o graffi, impiegati in settori diversi: metallo, legno, vernici, materie plastiche, ceramica.



Art.	€	Dimensioni	Grana
PAR115/120AM	€ 45,10	115 mm x 10 m	A.Medium (120)
PAR115/180AF	€ 45,10	115 mm x 10 m	A.Fine (180)
PAR115/320AVF	€ 45,10	115 mm x 10 m	A.Very Fine (320)
PAR115/600AUF	€ 45,10	115 mm x 10 m	A.Ultra Fine (600)



Art.	€	Dimensioni	Grana	Pack
FPA120/M	€ 1,84	115 x 280 mm	A.Medium (120)	10
FPA120/F	€ 1,84	115 x 280 mm	A.Fine (180)	10
FPA120/VF	€ 1,84	115 x 280 mm	A.Very Fine (320)	10
FPA120/UF	€ 1,84	115 x 280 mm	S.Ultra Fine (600)	10





CSCD-

DISCHI IN NYLON ABRASIVO



Art.	€	Dimensioni	Max rpm	Pack
CSCD/F115	€ 6,80	115 x 22 mm	11000	5
CSCD/F180	€ 9,90	180 x 22 mm	7000	5
CSCD/F115HD	€ 7,50	115 x 22 mm	11000	5

ADF-

ALBERINI DI FISSAGGIO

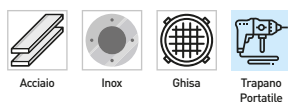

Art.	€	Dimensioni	Tipo	Pack
ADF/01	€ 2,15	10 x 6 mm	25	10
ADF/02	€ 2,25	12,8 x 8 mm	24	10

CSDS-

DISCHI PIANI CON FORO PER TRAPANO



Art.	€	Diametro	Max rpm
CSDS/100	€ 4,51	100 mm	8000
CSDS/150	€ 7,40	150 mm	5350
CSDS/200	€ 11,30	200 mm	4000

CSF-

BLACK CLEANER IN NYLON ABRASIVO

Attacco rapido. Per rimuovere ruggine, vernice, colle, ossidazioni, calamine.

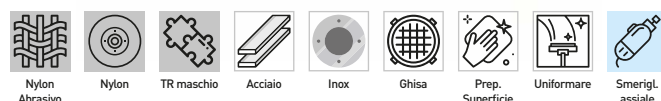

Art.	€	Diametro Ø	Max rpm	Pack
CSF/050	€ 3,21	50 mm	12000	10
CSF/075	€ 4,95	75 mm	8000	10



UNITIZED

UNCD-

DISCHI NON-WOVEN PER FINITURA

Dischi in tessuto non tessuto abrasivo compresso ed imbevuto di resina.



Art.	€	Dimensioni	Grana	Max rpm	Pack
UNCD/F115F	€ 15,90	115 x 22 mm	S/C-F	11000	5
UNCD/F115M	€ 15,90	115 x 22 mm	S/C-M	11000	5
UNCD/F115C	€ 15,90	115 x 22 mm	A/O-C	11000	5



UNPX

DISCO NON TESSUTO COMPRESSO

Lo spessore sottile permette di svolgere la finitura e la pulizia degli angoli interni con smerigliatrici angolari a basso numero di giri. Il prodotto deve lavorare di testa, non esercitare pressioni laterali.



Art.	€	Diametro ø	Spessore	Foro	Grana	Max rpm	Pack
UNP115/6/3SF	€ 12,30	115 mm	6 mm	22 mm	3 S.Fine	5000	5
UNP115/6/6SM	€ 14,30	115 mm	6 mm	22 mm	6 S.Medium	5000	5
UNP125/6/3SF	€ 14,30	125 mm	6 mm	22 mm	3 S.Fine	5000	5
UNP125/6/6SM	€ 16,60	125 mm	6 mm	22 mm	6 S.Medium	5000	5



UNFX

DISCO NON TESSUTO COMPRESSO

3am durezza media, grana media. Sbavatura di piccole bave, mascheratura di passaggi precedenti con l'abrasivo, rimozione ossidazioni. 6ac dura, grana grossa. Sbavatura, mascheratura di graffi profondi lasciati dall'abrasivo, rimozione di ossidazioni. 6sf molto dura, grana fine. Si adatta meno alla sagoma del pezzo ma dura di più ed è più resistente in presenza di leggere bave.



Art.	€	Diametro Ø	Spessore	Foro	Grana	Max rpm	Pack
UNF150/6/3AM	€ 20,30	150 mm	6 mm	25 mm	3 A.Medium	5000	5
UNF150/6/6SF	€ 20,50	150 mm	6 mm	25 mm	6 S.Fine	5000	5
UNF150/6/6AC	€ 24,10	150 mm	6 mm	25 mm	6 A.Coarse	5000	5

MDUX

FAST LOCK UNITIZED

Sbavatura e finitura di bordi e angoli, saldature, rimozione di graffi e ossidazioni leggere.

Finitura superficiale di qualità superiore.



Art.	€	Diametro Ø	Grana	Max rpm
MDU075/2SF	€ 11,40	75 mm	2SF	20000
MDU075/6SF	€ 13,10	75 mm	6SF	20000
MDU075/6AM	€ 15,40	75 mm	6AM	20000



PAS-

PASTE ABRASIVE

Rosa: pasta medio/grassa per lucidare e brillantare; accompagna la tela nel secondo passaggio e nella lucidatura di ottone, argento, alluminio, cromo e zama.
Verde: pasta medio grassa per accompagnare il sisal nella finitura dell'inox.
Bianca: pasta grassa per accompagnare la sgrossatura ed il primo passaggio con sisal, tampico, filo di acciaio o filo di nylon. Per ottone, argento, zama, inox.
Gialla: molto tagliente per eliminare graffi da preziosi e argenteria.



Finitura



Art.	€	Colore
PAS/W	€ 7,00	Bianco
PAS/P	€ 9,00	Rosa
PAS/Y	€ 7,90	Giallo
PAS/G	€ 7,60	Verde

DLFX

DISCHI LAMELLARI IN FELTRO

Per la lucidatura a specchio accompagnata da pasta abrasiva o compound, le lamelle in feltro sono flessibili e aiutano a prevenire il surriscaldamento.



Feltro



Fibra di vetro



T27



EN 13743



Finitura



Acciaio



Inox



Alluminio



Ghisa



0-15°



Smerigl. angolare



made in italy



Art.	€	Dimensioni	Max rpm	Pack
DLF115	€ 5,40	Ø 115 x 22 mm	6000	10
DLF125	€ 6,40	Ø 125 x 22 mm	6000	10

S169

€ 10,30

SET PASTE PER LUCIDATURA METALLI

Verde e rosa: pasta per l'esecuzione di lucidature di finitura sulle principali categorie di metalli. Marrone e nero: per l'esecuzione di lucidature di finitura grossa/media su materiali come ottone, alluminio e zinco. Bianca: per l'esecuzione di lucidature di finitura grossa/media su materiali come ferro, inox e rame.



5 Pcs



Blister



Acciaio



Inox



Alluminio



Leghe non ferrose



Ghisa



Utilizzo Manuale

MDFX

FAST LOCK FELTRO

Per la lucidatura a specchio accompagnata da pasta abrasiva o compound.



Feltro



Nylon



TR maschio



Finitura



Acciaio



Inox



Alluminio



Ghisa



Smerigl. assiale



Art.	€	Diametro Ø	Max rpm	Pack
MDF050	€ 2,90	50 mm	25000	10
MDF075	€ 3,98	75 mm	20000	10

RGFX

RUOTE LAMELLARI IN FELTRO

Per la lucidatura a specchio accompagnata da pasta abrasiva o compound. Le lamelle in feltro sono flessibili e aiutano a prevenire il surriscaldamento oltre ad adattarsi alla superficie da lavorare, garantendo un impatto morbido e controllato.



Feltro



Finitura



Acciaio



Inox



Alluminio



Ghisa



Smerigl. assiale



Art.	€	Diametro Ø	Spessore	Gambo	Max rpm	Pack
RGF030/30	€ 5,40	30 mm	30 mm	6 mm	12500	10
RGF040/30	€ 6,00	40 mm	30 mm	6 mm	9500	10
RGF050/30	€ 6,90	50 mm	30 mm	6 mm	7500	10
RGF060/30	€ 7,60	60 mm	30 mm	6 mm	6000	10
RGF080/30	€ 10,20	80 mm	30 mm	6 mm	4500	10

DFFX
DISCHI IN FELTRO

Per pulitura e lucidatura a specchio. Velocità raccomandata 5-10 m/s.



Art.	€	Diametro ø	Spessore	Foro
DFF100/13	€ 7,00	100 mm	13 mm	10 mm
DFF150/13	€ 12,50	150 mm	13 mm	15 mm
DFF150/25	€ 22,60	150 mm	25 mm	15 mm
DFF200/13	€ 19,30	200 mm	13 mm	15 mm
DFF200/25	€ 39,50	200 mm	25 mm	15 mm

VDFX
DISCO VELCRATO IN FELTRO

Per pulitura e lucidatura a specchio. Da usare con pasta abrasiva o diamantata.



Art.	€	Diametro ø	Spessore	Max rpm	Pack
VDF075	€ 4,24	75 mm	5 mm	6000	10
VDF115	€ 4,94	115 mm	5 mm	4000	10
VDF125	€ 5,60	125 mm	5 mm	3500	10
VDF150	€ 7,80	150 mm	5 mm	3000	10
VDF180	€ 10,30	180 mm	5 mm	2500	10

MFGX
FELTRINI SU GAMBO

Per pulitura e lucidatura a specchio. Si usano per lucidare gli stampi, accompagnati da pasta diamantata. Velocità raccomandata 5-10 m/s.

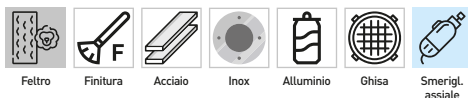

Art.	€	Forma	Diametro ø	Spessore	Gambo	Pack
MFG0610/03A	€ 1,40	A	6 mm	10 mm	3 mm	10
MFG0810/03A	€ 1,40	A	8 mm	10 mm	3 mm	10
MFG1014/06A	€ 1,47	A	10 mm	14 mm	6 mm	10
MFG1520/06A	€ 1,57	A	15 mm	20 mm	6 mm	10
MFG0812/03K	€ 1,48	K	8 mm	12 mm	3 mm	10
MFG1018/06K	€ 1,57	K	10 mm	18 mm	6 mm	10
MFG1530/06K	€ 2,69	K	15 mm	30 mm	6 mm	10
MFG1530/06C	€ 2,68	C	15 mm	30 mm	6 mm	10
MFG2025/06C	€ 2,83	C	20 mm	25 mm	6 mm	10
MFG2530/06C	€ 4,24	C	25 mm	30 mm	6 mm	10
MFG2025/06L	€ 2,73	L	20 mm	25 mm	6 mm	10
MFG2530/06L	€ 3,71	L	25 mm	30 mm	6 mm	10

DFC115/M14
€ 19,80
DISCO IN FELTRO CONICO

Per pulitura e lucidatura a specchio. Da usare con pasta abrasiva o diamantata.



Diametro ø	115 mm
Spessore	12 mm
Filetto	M14
Max rpm	12500

RFF100
€ 59,90
RUOTA CON FORO IN FELTRO

Dimensioni	110 x 100 mm
Diametro foro	19 mm



DCK100

€ 4,85

DISCHETTI IN COTONE VENTILATI

Per la lucidatura a specchio di inox, rame, ottone, alluminio. 10 dischi per comporre un blocco di spessore 100 mm.



Diametro ø	100 mm
Foro	19,1 mm
Pack	10

DSK100

€ 7,70

DISCHETTI IN SISAL E COTONE

Per eliminare i segni dell'abrasivo e preparare la superficie per la lucidatura con panno o feltro. 7 dischi per comporre un blocco di spessore 100 mm.

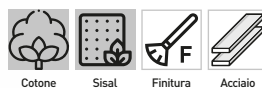

Diametro ø	100 mm
Foro	19,1 mm
Pack	10

DCTX

DISCHI IN COTONE TRAPUNTATO

Dischi in cotone cuciti tra loro. Da usare con pasta abrasiva per lucidare.



Art.	€	Diametro ø	Foro
DCT150	€ 5,30	150 mm	12 mm
DCT200	€ 8,50	200 mm	20 mm
DCT250	€ 15,50	250 mm	20 mm

DSCX

DISCHI IN SISAL E COTONE

Per eliminare i segni dell'abrasivo e preparare la superficie per la lucidatura con panno o feltro. Accompagnare con pasta abrasiva.



Art.	€	Diametro ø	Foro
DSC150	€ 7,00	150 mm	20 mm
DSC200	€ 13,60	200 mm	20 mm
DSC250	€ 17,30	250 mm	20 mm

DSTX

DISCHI TRAPUNTATI IN SISAL

Per eliminare i segni dell'abrasivo e preparare la superficie per la lucidatura con panno o feltro. Accompagnare con pasta abrasiva.



Art.	€	Diametro ø	Foro
DST150	€ 7,20	150 mm	20 mm
DST200	€ 14,30	200 mm	20 mm
DST250	€ 20,70	250 mm	20 mm

DCVX

DISCHI VENTILATI

Dischi ventilati in cotone



Art.	€	Diametro ø	Foro	Falde
DCV150	€ 4,67	150 mm	20 mm	8
DCV200	€ 12,50	200 mm	20 mm	16

DMV150
€ 5,40
DISCHI VENTILATI

Dischi ventilati in sisal e cotone.



Diametro ø	150 mm
Foro	20 mm
Falde	2

DNW100
€ 3,07
DISCO NON TESSUTO BIANCO

Diametro ø	100 mm
Foro	10 mm
Pack	10

FCGX
COTONE A FUNGO CON GAMBO

Art.	€	Diametro ø	Gambo	Pack
FCG50	€ 4,65	50 mm	6 mm	10
FCG75	€ 7,00	75 mm	6 mm	10

DC200
€ 23,70
DISCHI ONDULATI

In cotone con nucleo di cartone.



Diametro ø	200 mm
Foro	20 mm
Falde	14

DCGX
DISCHI IN COTONE CON GAMBO

Per lucidare, da usare con la pasta abrasiva. Velocità periferica ottimale 5-10 m/s.



Art.	€	Diametro ø	Spessore	Gambo	Pack
DCG050	€ 3,83	50 mm	12 mm	6 mm	10
DCG080	€ 4,84	80 mm	12 mm	6 mm	10
DCG100	€ 5,80	100 mm	12 mm	6 mm	10

CCGX
CONO DI COTONE

Per lucidare, da usare con la pasta abrasiva. Velocità periferica ottimale 5-10 m/s.



Art.	€	Diametro ø	Gambo	Pack
CCG50	€ 6,90	50 mm	6 mm	5
CCG75	€ 10,80	75 mm	6 mm	5



PNS € 2,35

PERNO

Perno per dischi DNW.



Smerigl
assiale



PLV175 € 28,10

PLATORELLO PER DISCHI IN LANA

Platorello di supporto specifico per VLA200.



M14 Levigatrice
Orbitale



Diametro ø	175 mm
Filetto	M14

VSPX

PLATORELLI IN POLIURETANO

Platorelli morbidi ad alto e medio profilo per la lucidatura dei bordi. Pur molded, morbido, buon rimbalzo e durata. Ideale per lucidatura frontale dell'auto, pezzi in fibra di vetro, barca, pavimenti ecc. , consigliato per lavorare con dischi in lana, spugna e dischi abrasivi.



M14 Levigatrice
Orbitale



Art.	€	Diametro ø	Filetto	Max rpm
VSP075	€ 9,80	75 mm	M14	12200
VSP115	€ 10,60	115 mm	M14	10000
VSP125	€ 11,10	125 mm	M14	10000
VSP150	€ 12,70	150 mm	M14	7000
VSP180	€ 13,40	180 mm	M14	5000

VLA200 € 20,90

DISCO IN LANA ATTORCIGLIATA

Per lucidare superfici verniciate e marmo



Diametro ø	200 mm
------------	--------

VDLX

DISCHI IN LANA VELCRATI

Disco in lana merinos per lucidare superfici verniciate, con attacco velcrato.

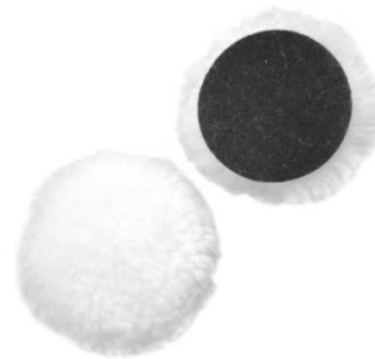

Art.	€	Diametro ø
VDL075	€ 6,40	75 mm
VDL115	€ 7,80	115 mm
VDL125	€ 8,80	125 mm
VDL150	€ 10,60	150 mm
VDL180	€ 13,40	180 mm



BSAX
BLOCCHETTI DI SPUGNA ABRASIVA

Spugna semirigida, si adatta alla sagoma della superficie da lavorare e mantiene la forma piana sui quattro lati. Impiegato nella lavorazione del legno, per porte e finestre, per angoli e scanalature. Si può usare a secco e ad umido e si può risciacquare dopo l'uso.



Art.	€	Dimensioni	Grana	Pack
BSA100/060C	€ 0,99	98 x 69 x 26 mm	Coarse (60)	20
BSA100/100M	€ 0,99	98 x 69 x 26 mm	Medium (100)	20
BSA100/180F	€ 0,99	98 x 69 x 26 mm	Fine (180)	20

FSAX
FOGLI DI SPUGNA ABRASIVA

Molto flessibile, si adatta alla sagoma della superficie da lavorare. Impiegato nella lavorazione del legno, nell'industria del mobile, nelle carrozzerie. Si può usare a secco e ad umido e si può risciacquare dopo l'uso.



Art.	€	Dimensioni	Grana	Pack
FSA120/060C	€ 0,92	120 x 98 x 13 mm	Coarse (60)	20
FSA120/100M	€ 0,92	120 x 98 x 13 mm	Medium (100)	20
FSA120/180F	€ 0,92	120 x 98 x 13 mm	Fine (180)	20

BGAX
BLOCCHETTI IN GOMMA

Utilizzabili per varie operazioni di pulizia e finitura manuale



Art.	€	Dimensioni	Grana
BGA8050/036	€ 10,10	80 x 50 x 20 mm	36
BGA8050/060	€ 10,10	80 x 50 x 20 mm	60
BGA8050/120	€ 10,10	80 x 50 x 20 mm	120
BGA8050/240	€ 10,10	80 x 50 x 20 mm	240

SALX
SPUGNE PER LUCIDARE

Disponibile in diverse durezza e porosità, per accompagnare le varie paste nelle fasi di lucidatura. Giallo: prima lucidatura, durezza media, porosa. Blu: prima lucidatura, durezza media, fine. Arancione: lucidatura, durezza media, fine. Nera: super morbido, fine, lucidatura finale.

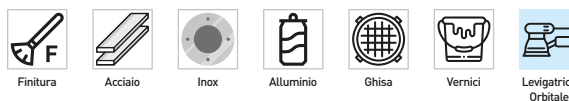

Art.	€	Diametro Ø	Spessore	Colore	Max rpm
SAL80Y	€ 5,20	80 mm	25 mm	Giallo	8000
SAL80B	€ 3,94	80 mm	25 mm	Blu	8000
SAL800	€ 3,92	80 mm	25 mm	Arancione	8000
SAL80K	€ 3,70	80 mm	25 mm	Nero	8000
SAL150Y	€ 14,40	150 mm	50 mm	Giallo	4500
SAL150B	€ 11,20	150 mm	50 mm	Blu	4500
SAL1500	€ 10,90	150 mm	50 mm	Arancione	4500
SAL150K	€ 9,00	150 mm	50 mm	Nero	4500



SRFX

SPAZZOLA CIRCOLARE CON FILI ONDULATI

Per spazzolatura fatta con macchine stazionarie e mole da banco. Per applicazioni medie e gravose: lunga vita, aggressive, molto resistenti.



Art.	€	Dimensioni	Foro	Filo	Max rpm
SRF125/25	€ 7,70	Ø 125 x 20 mm	16, 12,7 mm	0,3 mm	6000
SRF150/25	€ 9,30	Ø 150 x 32 mm	25, 22, 20, 16, 12,7 mm	0,3 mm	6000
SRF175/25	€ 10,60	Ø 175 x 32 mm	25, 22, 20, 16 mm	0,3 mm	6000
SRF200/25	€ 13,30	Ø 200 x 32 mm	25, 22, 20, 16, 13 mm	0,3 mm	4500
SRF250/25	€ 25,50	Ø 250 x 32 mm	25, 22, 20, 16 mm	0,3 mm	3000

SRFXI

SPAZZOLA CIRCOLARE CON FILI ONDULATI

Per spazzolatura fatta con macchine stazionarie e mole da banco. Per applicazioni medie e gravose: lunga vita, aggressive, molto resistenti

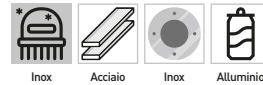

Art.	€	Dimensioni	Foro	Filo	Max rpm
SRF125/25I	€ 13,70	Ø 125 x 20 mm	16, 12,7 mm	0,3 mm	6000
SRF150/25I	€ 16,90	Ø 150 x 32 mm	25, 22, 20, 16, 12,7 mm	0,3 mm	6000
SRF175/25I	€ 20,20	Ø 175 x 32 mm	25, 22, 20, 16 mm	0,3 mm	6000
SRF200/25I	€ 24,70	Ø 200 x 32 mm	25, 22, 20, 16 mm	0,3 mm	4500
SRF250/25I	€ 37,90	Ø 250 x 32 mm	25, 22, 20, 16 mm	0,3 mm	3000

STFX

SPAZZOLA A TAZZA A FILI ONDULATI

Per l'uso con smerigliatrici angolari, per bave, adatta a spazzolare grandi superfici.

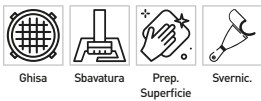
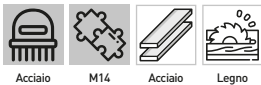

Art.	€	Diametro Ø	Filetto	Filo	Max rpm
STF060	€ 3,79	60 mm	M14	0,3 mm	12500
STF080	€ 4,49	80 mm	M14	0,3 mm	11000
STF100	€ 6,60	100 mm	M14	0,3 mm	8500
STF120	€ 11,70	120 mm	M14	0,3 mm	6500

STFXI

SPAZZOLA A TAZZA A FILI ONDULATI

Per l'uso con smerigliatrici angolari, per bave, adatta a spazzolare grandi superfici.

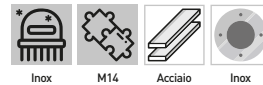

Art.	€	Diametro Ø	Filetto	Filo	Max rpm
STF060I	€ 6,70	60 mm	M14	0,3 mm	12500
STF080I	€ 8,30	80 mm	M14	0,3 mm	11000
STF100I	€ 11,70	100 mm	M14	0,3 mm	8500
STF120I	€ 17,20	120 mm	M14	0,3 mm	6500

SCFX

SPAZZOLA CONICA A FILI ONDULATI

Per l'uso con smerigliatrici angolari.



Art.	€	Filetto	Filo	Max rpm	Diametro Ø
SCF090	€ 4,39	M14	0,3 mm	125000	90 mm
SCF120	€ 5,90	M14	0,3 mm	125000	120 mm
SCF150	€ 11,50	M14	0,3 mm	6500	150 mm

SCFXI

SPAZZOLA CONICA A FILI ONDULATI

Per l'uso con smerigliatrici angolari.



Art.	€	Filetto	Filo	Max rpm	Diametro Ø
SCF090I	€ 6,60	M14	0,3 mm	125000	90 mm
SCF120I	€ 8,90	M14	0,3 mm	125000	120 mm
SCF150I	€ 17,20	M14	0,3 mm	6000	150 mm

SRRX
SPAZZOLA CIRCOLARE A MAZZETTI RITORTI

Per lavorazioni gravose, pulizia cordoni di saldatura, per ottenere una superficie con tracce più evidenti.

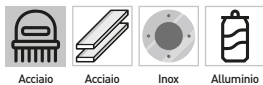

Art.	€	Diametro ø	Foro	Filo	Max rpm
SRR100	€ 6,80	100 mm	22 mm	0,5 mm	12500
SRR150	€ 13,30	150 mm	22 mm	0,5 mm	9000
SRR200	€ 19,00	200 mm	22 mm	0,5 mm	6000

SRRX-M14
SPAZZOLA CIRCOLARE A MAZZETTI RITORTI

Per lavorazioni gravose, pulizia cordoni di saldatura, per ottenere una superficie con tracce più evidenti.

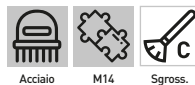

Art.	€	Diametro ø	Filetto	Filo	Max rpm
SRR100/M14	€ 6,70	100 mm	M14	0,5 mm	12500
SRR115/M14	€ 8,20	115 mm	M14	0,5 mm	12500
SRR125/M14	€ 9,90	125 mm	M14	0,5 mm	11000

STRX
SPAZZOLA A TAZZA A MAZZETTI RITORTI

Per la lavorazione di grandi superfici, per eliminare la calamina, la vernice, la ruggine.

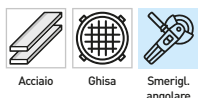
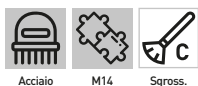

Art.	€	Diametro ø	Filetto	Filo	Max rpm
STR065	€ 7,50	65 mm	M14	0,5 mm	12500
STR075	€ 8,70	75 mm	M14	0,5 mm	8500
STR080	€ 10,10	80 mm	M14	0,5 mm	8500
STR100	€ 13,30	100 mm	M14	0,5 mm	8500
STR120	€ 17,20	120 mm	M14	0,5 mm	6500

STRXI
SPAZZOLA A TAZZA A MAZZETTI RITORTI

Per la lavorazione di grandi superfici, per eliminare la calamina, la vernice, la ruggine.



Art.	€	Diametro ø	Filetto	Filo	Max rpm
STR065I	€ 10,80	65 mm	M 14	0,5 mm	12500
STR075I	€ 13,40	75 mm	M 14	0,5 mm	8500
STR080I	€ 17,90	80 mm	M 14	0,5 mm	8500
STR100I	€ 21,00	100 mm	M 14	0,5 mm	8500
STR120I	€ 27,10	120 mm	M 14	0,5 mm	6500

SCRX
SPAZZOLA CONICA A MAZZETTI RITORTI

Per la lavorazione di grandi superfici, per eliminare la calamina, la vernice, la ruggine. Indicata per raggiungere meglio gli angoli.



Art.	€	Diametro ø	Filetto	Filo	Max rpm
SCR100	€ 7,10	100 mm	M14	0,5 mm	12500
SCR120	€ 10,10	120 mm	M14	0,5 mm	12500

SCRXI
SPAZZOLA CONICA A MAZZETTI RITORTI

Per la lavorazione di grandi superfici, per eliminare la calamina, la vernice, la ruggine. Indicata per raggiungere meglio gli angoli.



Art.	€	Diametro ø	Filetto	Filo	Max rpm
SCR100I	€ 10,80	100 mm	M14	0,5 mm	12500
SCR120I	€ 15,00	120 mm	M14	0,5 mm	12500



SRGX

SPAZZOLA CIRCOLARE CON GAMBO

Per pulizia di saldature, per leggere bave, sverniciature, calamine, ruggine.



Art.	€	Diametro ø	Spessore	Gambo	Filo	Max rpm
SRG030/05	€ 1,06	30 mm	5 mm	6 mm	0,3 mm	4500
SRG040/05	€ 1,17	40 mm	5 mm	6 mm	0,3 mm	4500
SRG050/06	€ 1,43	50 mm	6 mm	6 mm	0,3 mm	4500
SRG060/06	€ 1,63	60 mm	6 mm	6 mm	0,3 mm	4500
SRG070/08	€ 1,91	70 mm	8 mm	6 mm	0,3 mm	4500
SRG080/08	€ 2,08	80 mm	8 mm	6 mm	0,3 mm	4500
SRG100/10	€ 2,25	100 mm	10 mm	6 mm	0,3 mm	4500
SRG100/15	€ 3,65	100 mm	15 mm	6 mm	0,3 mm	4500

SRGXI

SPAZZOLA CIRCOLARE CON GAMBO

Per pulizia di saldature, per leggere bave, sverniciature, calamine, ruggine.



Art.	€	Diametro ø	Spessore	Gambo	Filo	Max rpm
SRG030/05I	€ 1,76	30 mm	5 mm	6 mm	0,3 mm	4500
SRG040/05I	€ 1,89	40 mm	5 mm	6 mm	0,3 mm	4500
SRG050/06I	€ 2,46	50 mm	6 mm	6 mm	0,3 mm	4500
SRG060/06I	€ 2,57	60 mm	6 mm	6 mm	0,3 mm	4500
SRG070/08I	€ 2,97	70 mm	8 mm	6 mm	0,3 mm	4500
SRG080/08I	€ 4,13	80 mm	8 mm	6 mm	0,3 mm	4500
SRG100/10I	€ 4,49	100 mm	10 mm	6 mm	0,3 mm	4500
SRG100/15I	€ 6,00	100 mm	15 mm	6 mm	0,3 mm	4500

SNGX

SPAZZOLA CIRCOLARE IN NYLON CON GAMBO

Più flessibile e resistente alla rottura del filo d'acciaio. Sui metalli rimuove l'ossido e i residui di vernice graffiando meno ed evitando la ruggine, sui legni prepara la superficie.



Art.	€	Diametro ø	Gambo	Grana	Colore	Max rpm
SNG075/080R	€ 6,40	75 mm	6 mm	80	Rosso	4500
SNG075/180B	€ 6,40	75 mm	6 mm	180	Blu	4500
SNG100/080R	€ 7,40	100 mm	6 mm	80	Rosso	4500
SNG100/180B	€ 7,60	100 mm	6 mm	180	Blu	4500

SGR075

€ 4,24

SPAZZOLA CON GAMBO A MAZZETTI RITORTI

Per pulire, eliminare ruggine, per cordoni di saldatura.



Diametro ø	75 mm
Gambo	6 mm
Filo	0,5 mm
Max rpm	12000

SGR075I

€ 5,30

SPAZZOLA CON GAMBO A MAZZETTI RITORTI

Per pulire, eliminare ruggine, per cordoni di saldatura.

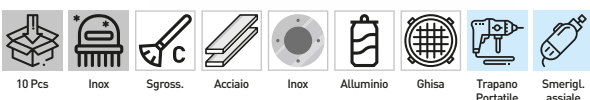

Diametro ø	75 mm
Gambo	6 mm
Filo	0,5 mm
Max rpm	12000

SCG090

€ 4,49

SPAZZOLA CONICA CON GAMBO

Per pulizia di punti difficili da raggiungere di saldature, per leggere bave, sverniciature, calamine, ruggine.



Diametro ø	90 mm
Gambo	6 mm
Filo	0,3 mm
Max rpm	12500

SCG090I

€ 6,50

SPAZZOLA CONICA CON GAMBO

Per pulizia di punti difficili da raggiungere di saldature, per leggere bave, sverniciature, calamine, ruggine.



Diametro ø	90 mm
Gambo	6 mm
Filo	0,3 mm
Max rpm	12500

STGX

SPAZZOLA A TAZZA CON GAMBO

Per pulizia frontale di saldature, per leggere bave, sverniciature, calamine, ruggine.



Art.	€	Diametro ø	Gambo	Filo	Max rpm
STG050I	€ 2,69	50 mm	6 mm	0,3 mm	6500
STG070I	€ 3,42	70 mm	6 mm	0,3 mm	4500

SFGXI

SPAZZOLA FRONTALE

Per lavorazioni frontali e in aree di difficile accesso.



Art.	€	Diametro ø	Gambo	Filo	Max rpm
SFG010I	€ 1,95	10 mm	6 mm	0,3 mm	20000
SFG015I	€ 2,75	15 mm	6 mm	0,3 mm	20000
SFG020I	€ 3,39	20 mm	6 mm	0,3 mm	20000
SFG025I	€ 3,65	25 mm	6 mm	0,3 mm	20000
SFG030I	€ 5,40	30 mm	6 mm	0,3 mm	20000

STGX

SPAZZOLA A TAZZA CON GAMBO

Per pulizia frontale di saldature, per leggere bave, sverniciature, calamine, ruggine.



Art.	€	Diametro ø	Gambo	Filo	Max rpm
STG050	€ 1,77	50 mm	6 mm	0,3 mm	6500
STG070	€ 2,28	70 mm	6 mm	0,3 mm	4500

SFGX

SPAZZOLA FRONTALE

Per lavorazioni frontali e in aree di difficile accesso.



Art.	€	Diametro ø	Gambo	Filo	Max rpm
SFG010	€ 1,50	10 mm	6 mm	0,3 mm	20000
SFG015	€ 1,98	15 mm	6 mm	0,3 mm	20000
SFG020	€ 2,46	20 mm	6 mm	0,3 mm	20000
SFG025	€ 2,77	25 mm	6 mm	0,3 mm	20000
SFG030	€ 3,65	30 mm	6 mm	0,3 mm	20000

SFPX

SPAZZOLA FRONTALE A PUNTA

Per lavorazioni frontali e in aree di difficile accesso.



Art.	€	Diametro ø	Gambo	Filo	Max rpm
SFP012	€ 2,33	12 mm	6 mm	0,3 mm	20000
SFP024	€ 3,39	24 mm	6 mm	0,3 mm	20000



SFPXI

SPAZZOLA FRONTALE A PUNTA

Per lavorazioni frontali e in aree di difficile accesso.



Art.	€	Diametro ø	Gambo	Filo	Max rpm
SFP012I	€ 1,76	12 mm	6 mm	0.3 mm	20000
SFP024I	€ 4,25	24 mm	6 mm	0.3 mm	20000

SFRX

SPAZZOLA FRONTALE A MAZZETTI RITORTI

Per lavorazioni frontali e in aree di difficile accesso.



Art.	€	Diametro ø	Gambo	Filo	Max rpm
SFR019	€ 4,55	19 mm	6 mm	0,5 mm	20000
SFR022	€ 5,00	22 mm	6 mm	0,5 mm	20000

SFRXI

SPAZZOLA FRONTALE A MAZZETTI RITORTI

Per lavorazioni frontali e in aree di difficile accesso.

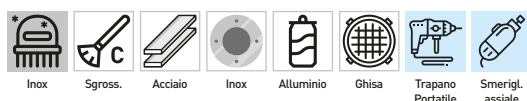

Art.	€	Diametro ø	Gambo	Filo	Max rpm
SFR019I	€ 7,00	19 mm	6 mm	0,5 mm	20000
SFR022I	€ 7,70	22 mm	6 mm	0,5 mm	20000

0331

€ 34,60

SET SPAZZOLE PER L'OFFICINA E L'AUTORIPARATORE

Con prolunga e manico in plastica.



Misure	Ø 9 - 11 - 13 - 15 - 17 - 19 mm
Materiale	Nylon - Acciaio - Ottone

SMC275

€ 1,83

SPAZZOLA A MANO

Per svariate operazioni di pulizia manuale.



Misura	275 mm
--------	--------

SMC275I

€ 3,69

SPAZZOLA A MANO

Per svariate operazioni di pulizia manuale.



Misura	275 mm
--------	--------

COSTRUZIONE DEL DISCO

<p>Un disco abrasivo è costituito da grani abrasivi (~75%) legati insieme con resine (~25%) e reti in fibra di vetro per aumentare la resistenza del prodotto. I minerali usati nella produzione degli abrasivi vengono scelti sulla base della loro durezza, tenacità, resistenza al calore, composizione e forma del grano da cui dipende la capacità di taglio propria di quell'abrasivo.</p>	
<p>Gli abrasivi comunemente utilizzati nella produzione di un disco abrasivo sono i seguenti:</p> <ul style="list-style-type: none"> - Corindone modificato allo zirconio: è dotato di un'elevata tenacità e la proprietà di spezzarsi ad elevate temperature facendo sì che il grano si rigeneri creando nuovi "spigoli" taglienti. Questa tipologia di abrasivo si ottiene mettendo nell'elettrofusione ossido di zirconio. Questo abrasivo è uno dei più efficaci e duraturi in commercio: ha elevatissima tenacità e resistenza alle più gravose sollecitazioni. Inoltre, grazie alla capacità di autorinnovare i propri spigoli taglienti, si ottiene un'altissima velocità di taglio. - Corindone Rosso Bruno: si tratta del più comune degli abrasivi: ha un livello medio di tenacità e friabilità. E' formato da un cristallo di ossido di alluminio contenente una piccola percentuale di ossido di ferro e di ossido di titanio che ne migliorano le caratteristiche della tenacità dello stesso. 	

GUIDA ALLA SCELTA DELLO SPESSORE DEL DISCO DA TAGLIO

Diametro del disco	Spessore	Tipologia di utilizzo
75 - 125 mm	1.0 mm	Spessore finalizzato alla rapidità di lavorazione, comfort di utilizzo e qualità del taglio.
	1.3 - 1.6 mm	Spessore finalizzato alla durata del disco e al confort di utilizzo.
	≥ 2 mm	Utilizzo Gravoso
150 - 230 mm	2 mm	Spessore finalizzato alla durata del disco e al confort di utilizzo.
	≥ 3 mm	Utilizzo Gravoso

I nostri test sono effettuati utilizzando un elettrotensile da 1200W tagliando un tubo sezione rettangolare 40 x 15 x 1.5 in AISI 304 utilizzando dischi diametro 125 mm e spessore nominale 1.0 mm effettuando tutti i tagli possibili con il disco fino a fine vita dello stesso.



**ZTD8X****DISCO DA TAGLIO PROFESSIONAL ALLO ZIRCONIO**

Dischi a cupola stretta, per massimizzare l'area piana di lavoro. Consente di effettuare più tagli e più profondi rispetto ad un disco a centro depresso, ha la stessa durata e la stessa capacità di taglio di un disco piano, con il vantaggio della maggiore rigidità data dalla forma a centro depresso e dalla cupola. Lo spessore estremamente sottile permette l'esecuzione di tagli con minima formazione di bave.

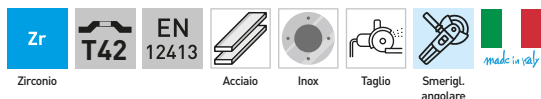

Art.	€	Dimensioni	Specifica	Pack
ZTD8115/1.0	€ 2,53	115 x 1,0 x 22 mm	ZA-60-SXBF	25
ZTD8125/1.0	€ 2,77	125 x 1,0 x 22 mm	ZA-60-SXBF	25

**MTP8X****DISCO DA TAGLIO PROFESSIONAL**

Per usi specifici. Pensato per professionisti che necessitano di un numero elevato di tagli di alta qualità. Vantano una conformazione a coste elicoidali su entrambi i lati, che permette di avere un taglio più veloce e più freddo. La massima evoluzione dei dischi da taglio sottili.



Art.	€	Dimensioni	Specifica	Pack
MTP8115/1.0	€ 1,80	115 x 1,0 x 22 mm	A60S	25
MTP8115/1.3	€ 1,84	115 x 1,3 x 22 mm	A60S	25
MTP8115/1.6	€ 1,91	115 x 1,6 x 22 mm	A60S	25
MTP8125/1.0	€ 1,92	125 x 1,0 x 22 mm	A60S	25
MTP8125/1.3	€ 1,96	125 x 1,3 x 22 mm	A60S	25
MTP8230/2.0	€ 4,02	230 x 2,0 x 22 mm	A60S	25
MTP8125/1.6	€ 2,13	125 x 1,6 x 22 mm	A60S	25

**MTP6X****DISCO DA TAGLIO PERFORMANCE**

Per usi generici. Pensato per artigiani e piccole aziende. Buona qualità del taglio.

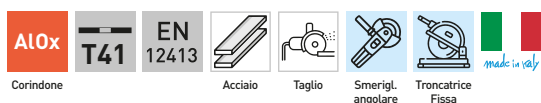

Art.	€	Dimensioni	Specifica	Pack
MTP6075/1.5	€ 1,62	75 x 1,5 x 10 mm	A46-S-BF 80	25
MTP6115/1.0	€ 1,43	115 x 1,0 x 22 mm	A46-R-BF 80	25
MTP6115/1.3	€ 1,43	115 x 1,3 x 22 mm	A46-R-BF 80	25
MTP6115/1.6	€ 1,43	115 x 1,6 x 22 mm	A46-R-BF 80	25
MTP6125/1.0	€ 1,53	125 x 1,0 x 22 mm	A46-S5-BF	25
MTP6125/1.3	€ 1,53	125 x 1,3 x 22 mm	A46-S5-BF	25
MTP6125/1.6	€ 1,53	125 x 1,6 x 22 mm	A46-S5-BF	25
MTP6230/2.0	€ 3,75	230 x 2,0 x 22 mm	A30-R-BF 80	25
MTP6350/3.0	€ 11,30	350 x 3,0 x 25,4 mm	A46-S-BF 80	25



MTD6X
DISCO DA TAGLIO PERFORMANCE

Corindone.



Art.	€	Dimensioni	Specifica	Pack
MTD6115/3.0	€ 1,62	115 x 3,0 x 22 mm	A30-R-BF 80	25
MTD6125/3.2	€ 1,92	125 x 3,2 x 22 mm	A30-S-BF	25
MTD6230/3.0	€ 3,25	230 x 3,0 x 22 mm	A30-R-BF 80	25

MTP4X
DISCO DA TAGLIO STRONG CUT

Per usi generici. Pensato per hobbisti, artigiani e piccole aziende. Ideale sia su acciaio che su inox. Ottimo rapporto qualità/prezzo.

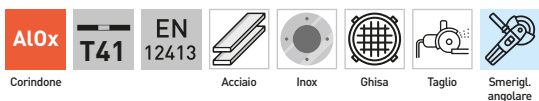

Art.	€	Dimensioni	Specifica	Pack
MTP4075/1.5	€ 1,01	75 x 1,5 x 9,53 mm	A60TBF	100
MTP4115/1.0	€ 0,91	115 x 1,0 x 22 mm	A60TBF	50
MTP4115/1.3	€ 0,91	115 x 1,3 x 22 mm	A60TBF	50
MTP4115/1.6	€ 0,91	115 x 1,6 x 22 mm	A46TBF	50
MTP4125/1.0	€ 1,01	125 x 1,0 x 22 mm	A60TBF	50
MTP4125/1.3	€ 1,01	125 x 1,3 x 22 mm	A60TBF	50
MTP4125/1.6	€ 1,01	125 x 1,6 x 22 mm	A46TBF	50
MTP4230/2.0	€ 3,25	230 x 2,0 x 22 mm	A46TBF	25
MTP4350/3.0	€ 8,70	350 x 3,0 x 22 mm	A30SBF	10

MTD4X
DISCO DA TAGLIO STRONG CUT

Per usi generici. Pensato per hobbisti, artigiani e piccole aziende. Ideale sia su acciaio che su inox. Ottimo rapporto qualità/prezzo.

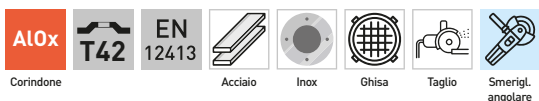

Art.	€	Dimensioni	Specifica	Pack
MTD4115/3.0	€ 1,22	115 x 3,0 x 22 mm	A30SBF	50
MTD4125/3.0	€ 1,53	125 x 3,0 x 22 mm	A30SBF	50
MTD4180/3.0	€ 2,23	180 x 3,0 x 22 mm	A30SBF	25
MTD4230/3.0	€ 2,94	230 x 3,0 x 22 mm	A30SBF	25



**MTP9X****DISCO DA TAGLIO INOX**

Per usi specifici. Pensato per professionisti dell'inox che necessitano di un numero elevato di tagli di alta qualità. Vantano una conformazione a coste elicoidali su entrambi i lati che permette di avere un taglio più veloce e più freddo.

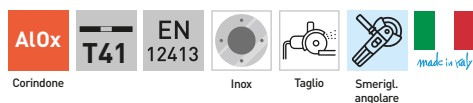

Art.	€	Dimensioni	Specifica	Pack
MTP9115/1.0	€ 1,94	115 x 1,0 x 22 mm	A60SX	25
MTP9115/1.3	€ 2,06	115 x 1,3 x 22 mm	A60SX	25
MTP9115/1.6	€ 2,15	115 x 1,6 x 22 mm	A60SX	25
MTP9125/1.0	€ 2,13	125 x 1,0 x 22 mm	A60SX	25
MTP9125/1.3	€ 2,32	125 x 1,3 x 22 mm	A60SX	25
MTP9125/1.6	€ 2,37	125 x 1,6 x 22 mm	A60SX	25
MTP9230/2.0	€ 4,96	230 x 2,0 x 22 mm	A60SX	25

**MTP7X****DISCO DA TAGLIO PER ALLUMINIO**

Per usi specifici. Pensato per professionisti dell'alluminio e serramentisti. Ideale su cassonati in alluminio, in fonderie di leghe leggere e si necessita di un numero elevato di tagli di alta qualità. Vanta una conformazione a coste elicoidali su entrambi i lati che permette di avere un taglio più veloce e più freddo, con basso intasamento.



Art.	€	Dimensioni	Specifica	Pack
MTP7115/1.3	€ 1,99	115 x 1,3 x 22 mm	A-60-QAL	25
MTP7125/1.3	€ 2,44	125 x 1,3 x 22 mm	A-60-QAL	25

**MTD7X****DISCO DA TAGLIO PER ALLUMINIO**

Per usi specifici. Pensato per professionisti dell'alluminio e serramentisti. Ideale su cassonati in alluminio, in fonderie di leghe leggere e si necessita di un numero elevato di tagli di alta qualità. Lunga durata e prestazioni costanti grazie all'aggiunta di additivi specifici anti intasanti.



Art.	€	Dimensioni	Specifica	Pack
MTD7230/3.2	€ 5,50	230 x 3,2 x 22 mm	A-30-36-QAL	25



ZSD8X
DISCO DA SBAVO PROFESSIONAL ALLO ZIRCONIO

Per usi specifici e gravosi. Pensato per un uso professionale. Ideale per asportazioni veloci di cordoni di saldatura, cianfrinatura, asportazione di calamina e tubi (vedi oil & gas). Trova applicazione su ghisa, acciaio inox, materiali forgiati.



Art.	€	Dimensioni	Specifica	Pack
ZSD8115/7.0	€ 4,56	115 x 7,0 x 22 mm	ZA-60-SXBF	25
ZSD8125/7.0	€ 5,30	125 x 7,0 x 22 mm	ZA-60-SXBF	25
ZSD8230/7.0	€ 14,50	230 x 7,0 x 22 mm	ZA-60-SXBF	25

MSD8X
DISCO DA SBAVO PROFESSIONAL

Per usi specifici. Pensato per professionisti che necessitano di alta capacità di asportazione e resistenza alla fatica. Ideale su lamiere con calamina, per l'asportazione di cordoni importanti e bave da ossitaglio.



Art.	€	Dimensioni	Specifica	Pack
MSD8115/6.5	€ 2,73	115 x 6,5 x 22 mm	A-Q	25
MSD8125/6.5	€ 3,01	125 x 6,5 x 22 mm	A-Q	25
MSD8230/7.0	€ 7,40	230 x 7,0 x 22 mm	A-Q	25

MSD6X
DISCO DA SBAVO PERFORMANCE

Per usi generici. Pensato per artigiani e piccole aziende. Con una buona qualità su cordoni di saldatura, lamiere con calamina e sbavatura in genere.



Art.	€	Dimensioni	Specifica	Pack
MSD6115/6.0	€ 2,23	115 x 6,0 x 22 mm	A24-R-BF 80	25
MSD6125/6.5	€ 2,64	125 x 6,5 x 22 mm	A30-S-BF	25
MSD6230/6.0	€ 6,30	230 x 6,0 x 22 mm	A24-R-BF 80	25

MSD4X
DISCO DA SBAVO STRONG CUT

Per usi generici. Pensato per hobbisti, artigiani e piccole aziende. Ideale sia su acciaio che su inox. Ottimo rapporto qualità/prezzo.

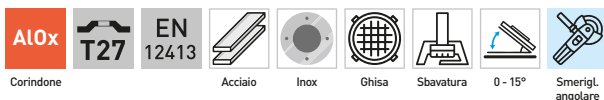

Art.	€	Dimensioni	Specifica	Pack
MSD4115/6.0	€ 1,72	115 x 6,0 x 22 mm	A24RBF	25
MSD4125/6.0	€ 2,13	125 x 6,0 x 22 mm	A24RBF	25
MSD4180/6.0	€ 4,36	180 x 6,0 x 22 mm	A24RBF	20
MSD4230/6.0	€ 5,60	230 x 6,0 x 22 mm	A24RBF	15



**M16X****MOLE ABRASIVE**

Corindone rosa.

**AlOx**

Corindone

Art.	€	Dimensioni	Specifiche
M159	€ 8,50	Ø 100 x 4,5 x 10 mm	GR80
M160	€ 8,50	Ø 100 x 3,2 x 10 mm	GR80
M163	€ 15,50	Ø 145 x 3,2 x 22,3 mm	GR 80
M162	€ 15,50	Ø 145 x 4,7 x 22,3 mm	GR80

MGX**MOLA ABRASIVA IN CORINDONE GRIGIO**

Per sgrossatura acciai, dotata di riduttori concentrici per adattarsi a tutte le macchine fisse.

**AlOx**

Corindone



Sgross.



Acciaio



Inox



Sbavatura

Smerigl.
Fissa

Art.	€	Dimensioni	Grana	Velocità max di utilizzo		Adattatori
MG01/36	€ 8,00	150 x 20 x 32 mm	36	4500 rpm 35 m/s	12,7 - 16 - 20 - 25 mm	
MG01/46	€ 8,00	150 x 20 x 32 mm	46	4500 rpm 35 m/s	12,7 - 16 - 20 - 25 mm	
MG01/60	€ 8,00	150 x 20 x 32 mm	60	4500 rpm 35 m/s	12,7 - 16 - 20 - 25 mm	
MG01/80	€ 8,00	150 x 20 x 32 mm	80	4500 rpm 35 m/s	12,7 - 16 - 20 - 25 mm	
MG02/36	€ 8,60	200 x 20 x 32 mm	36	3350 rpm 35 m/s	12,7 - 16 - 20 - 25 mm	
MG02/46	€ 8,60	200 x 20 x 32 mm	46	3350 rpm 35 m/s	12,7 - 16 - 20 - 25 mm	
MG02/60	€ 8,60	200 x 20 x 32 mm	60	3350 rpm 35 m/s	12,7 - 16 - 20 - 25 mm	
MG02/80	€ 8,60	200 x 20 x 32 mm	80	3350 rpm 35 m/s	12,7 - 16 - 20 - 25 mm	
MG03/36	€ 11,30	200 x 25 x 32 mm	36	3350 rpm 35 m/s	12,7 - 16 - 20 - 25 mm	
MG03/46	€ 11,30	200 x 25 x 32 mm	46	3350 rpm 35 m/s	12,7 - 16 - 20 - 25 mm	
MG03/60	€ 11,30	200 x 25 x 32 mm	60	3350 rpm 35 m/s	12,7 - 16 - 20 - 25 mm	
MG03/80	€ 11,30	200 x 25 x 32 mm	80	3350 rpm 35 m/s	12,7 - 16 - 20 - 25 mm	
MG04/36	€ 17,10	250 x 25 x 32 mm	36	3350 rpm 35 m/s	12,7 - 16 - 20 - 25 mm	
MG04/46	€ 17,10	250 x 25 x 32 mm	46	2650 rpm 35 m/s	12,7 - 16 - 20 - 25 mm	
MG04/60	€ 17,10	250 x 25 x 32 mm	60	2650 rpm 35 m/s	12,7 - 16 - 20 - 25 mm	
MG04/80	€ 17,10	250 x 25 x 32 mm	80	2650 rpm 35 m/s	12,7 - 16 - 20 - 25 mm	
MG06/80	€ 21,20	200 x 40 x 20 mm	80	3350 rpm 35 m/s	-	

MXV**MOLA ABRASIVA IN CARBURO DI SILICIO**

Per la sbavatura metalli non ferrosi, dotata di riduttori concentrici per adattarsi a tutte le macchine fisse.

**SiC**

Carburo di Silicio



Alluminio



HM

Smerigl.
Fissa

Art.	€	Dimensioni	Grana	Velocità max di utilizzo		Adattatori
MV01/80	€ 13,40	150 x 20 x 32 mm	80	4500 rpm 35 m/s	12,7 - 16 - 20 - 25 mm	
MV02/80	€ 15,90	200 x 20 x 32 mm	80	3350 rpm 35 m/s	12,7 - 16 - 20 - 25 mm	
MV03/80	€ 19,40	200 x 25 x 32 mm	80	3350 rpm 35 m/s	12,7 - 16 - 20 - 25 mm	
MV04/80	€ 30,60	250 x 25 x 32 mm	80	2650 rpm 35 m/s	12,7 - 16 - 20 - 25 mm	

MBX**MOLA ABRASIVA IN CORINDONE BIANCO**

Per finitura acciai, dotata di riduttori concentrici per adattarsi a tutte le macchine fisse.

**AlOx**

Corindone



Finitura



Acciaio



Inox



HSS



Sbavatura

Smerigl.
Fissa

Art.	€	Dimensioni	Grana	Velocità max di utilizzo		Adattatori
MB01/60	€ 8,50	150 x 20 x 32 mm	60	4500 rpm 35 m/s	12,7 - 16 - 20 - 25 mm	
MB02/60	€ 8,90	200 x 20 x 32 mm	60	3350 rpm 35 m/s	12,7 - 16 - 20 - 25 mm	
MB03/60	€ 12,00	200 x 25 x 32 mm	60	3350 rpm 35 m/s	12,7 - 16 - 20 - 25 mm	
MB04/60	€ 24,50	250 x 25 x 32 mm	60	2650 rpm 35 m/s	12,7 - 16 - 20 - 25 mm	

MCGXA
MOLE VETRIFICATE ROSA

Forma cilindrica "A" impiegate per sgrossare, smerigliare e finire piccole superfici di difficile accesso. Le molette vetrificate sono indicate per acciai teneri, bassolegati, ghisa.

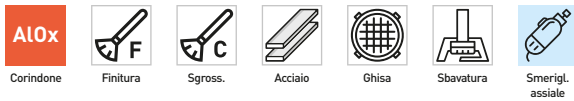

Art.	€	Misura	Gambo	Max rpm	Pack
MCG0306/03A	€ 0,58	Ø 3 x 6 mm	3 mm	50000	25
MCG0408/03A	€ 0,58	Ø 4 x 8 mm	3 mm	50000	25
MCG0510/03A	€ 0,58	Ø 5 x 10 mm	3 mm	50000	25
MCG0610/03A	€ 0,58	Ø 6 x 10 mm	3 mm	47750	25
MCG0610/06A	€ 0,58	Ø 6 x 10 mm	6 mm	47750	25
MCG0810/03A	€ 0,58	Ø 8 x 10 mm	3 mm	38590	25
MCG0810/06A	€ 0,58	Ø 8 x 10 mm	6 mm	38590	25
MCG1010/03A	€ 0,69	Ø 10 x 10 mm	3 mm	28640	25
MCG1010/06A	€ 0,91	Ø 10 x 10 mm	6 mm	28640	25
MCG1020/06A	€ 0,95	Ø 10 x 20 mm	6 mm	28640	25



Art.	€	Misura	Gambo	Max rpm	Pack
MCG1520/06A	€ 1,02	Ø 15 x 20 mm	6 mm	19000	25
MCG1530/06A	€ 1,31	Ø 15 x 30 mm	6 mm	19000	25
MCG2020/06A	€ 1,31	Ø 20 x 20 mm	6 mm	14320	25
MCG2025/06A	€ 1,53	Ø 20 x 25 mm	6 mm	14320	25
MCG2030/06A	€ 1,65	Ø 20 x 30 mm	6 mm	14320	25
MCG2525/06A	€ 1,53	Ø 25 x 25 mm	6 mm	11460	25
MCG3030/06A	€ 2,12	Ø 30 x 30 mm	6 mm	9540	25
MCG4020/06A	€ 2,75	Ø 40 x 20 mm	6 mm	7150	25
MCG4040/06A	€ 3,97	Ø 40 x 40 mm	6 mm	7150	25
MCG5010/06A	€ 2,75	Ø 50 x 10 mm	6 mm	5750	25

MCGXC
MOLE VETRIFICATE ROSA

Forma conica "C" impiegate per sgrossare, smerigliare e finire piccole superfici di difficile accesso. Le molette vetrificate sono indicate per acciai teneri, bassolegati, ghisa.



Art.	€	Misura	Gambo	Max rpm	Pack
MCG1020/06C	€ 1,10	10 x 20 mm	6 mm	28640	25
MCG1520/06C	€ 1,20	15 x 20 mm	6 mm	19000	25
MCG1540/06C	€ 1,99	15 x 40 mm	6 mm	19000	25
MCG2030/06C	€ 1,65	20 x 30 mm	6 mm	14320	25
MCG2540/06C	€ 2,96	25 x 40 mm	6 mm	11460	25
MCG3040/06C	€ 2,68	30 x 40 mm	6 mm	9540	25

MCGXS
MOLE VETRIFICATE ROSA

Forma sferica "s" impiegate per sgrossare, smerigliare e finire piccole superfici di difficile accesso. Le molette vetrificate sono indicate per acciai teneri, bassolegati, ghisa.



Art.	€	Misura	Gambo	Max rpm	Pack
MCG10/06S	€ 1,20	Ø 10 mm	6 mm	28640	25
MCG15/06S	€ 1,08	Ø 15 mm	6 mm	19000	25
MCG20/06S	€ 1,49	Ø 20 mm	6 mm	14320	25
MCG25/06S	€ 2,16	Ø 25 mm	6 mm	11460	25
MCG30/06S	€ 2,34	Ø 30 mm	6 mm	9540	25

MCG2050/06G
€ 2,64
MOLE VETRIFICATE ROSA

Forma ogiva "G" impiegate per sgrossare, smerigliare e finire piccole superfici di difficile accesso. Le molette vetrificate sono indicate per acciai teneri, bassolegati, ghisa.



Misura	Ø 20 x 50 mm
Gambo	6 mm
Max rpm	14320
Pack	25

MBGXA
MOLE RESINOIDI IN BAKELITE

Forma conica "C" impiegate per sgrossare, smerigliare e finire piccole superfici di difficile accesso. Le molette in bakelite sono indicate per acciai teneri, bassolegati, ghisa.



Art.	€	Misura	Gambo
MBG1030/06A	€ 1,65	Ø 10 x 30 mm	6 mm
MBG1530/06A	€ 1,80	Ø 15 x 30 mm	6 mm
MBG2020/06A	€ 1,61	Ø 20 x 20 mm	6 mm
MBG2030/06A	€ 1,85	Ø 20 x 30 mm	6 mm
MBG2040/06A	€ 2,36	Ø 20 x 40 mm	6 mm
MBG2525/06A	€ 1,85	Ø 25 x 25 mm	6 mm
MBG2535/06A	€ 2,22	Ø 25 x 35 mm	6 mm
MBG3010/06A	€ 1,53	Ø 30 x 10 mm	6 mm
MBG3030/06A	€ 2,14	Ø 30 x 30 mm	6 mm
MBG4020/06A	€ 2,71	Ø 40 x 20 mm	6 mm
MBG4035/06A	€ 3,53	Ø 40 x 35 mm	6 mm
MBG5010/06A	€ 2,71	Ø 50 x 10 mm	6 mm



**MBGXC****MOLE RESINOIDI IN BAKELITE**

Forma conica "C" impiegate per sgrassare, smerigliare e finire piccole superfici di difficile accesso. Le molette in bakelite sono indicate per acciai teneri, bassolegati, ghisa.

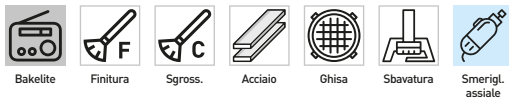

Art.	€	Misura	Gambo
MBG1540/06C	€ 2,81	Ø 15 x 40 mm	6 mm
MBG2040/06C	€ 3,03	Ø 20 x 40 mm	6 mm
MBG2535/06C	€ 2,81	Ø 25 x 35 mm	6 mm

0163

€ 9,10

SET MOLE ABRASIVE

10 Pcs

Gambo

Ø 3 - 6 mm

0816

€ 7,00

PIETRA PER AFFILARE IN CARBURO DI SILICIO GRANA MEDIA E GRANA FINE

SiC

Carburo di Silicio

Dimensioni 200 x 50 x 25h mm

0817

€ 6,70

PIETRA PER AFFILARE IN OSSIDO DI ALLUMINIO GRANA MEDIA E GRANA FINE

AlOx

Corindone

Dimensioni 200 x 50 x 25h mm

D100

€ 50,70

DIAMANTE PER RAVVIVARE MOLE

Tipo naturale.



Diamante

Gambo Ø 10 mm
Lunghezza 48 mm
Carati 1

D100/S

€ 35,00

DIAMANTE PER RAVVIVARE MOLE

Tipo sintetico.



Diamante

Gambo Ø 10 mm
Lunghezza 48 mm
Carati 1

D045-**DISCHI DIAMANTATI CORONA CONTINUA**

Uso generale, per il taglio di marmo, piastrelle e ceramica con acqua.



Art.	€	Diametro	Foro	Altezza diamante	Spessore taglio	Max rpm
D045/115	€ 5,50	Ø 115 mm	Ø 22,2 mm	5 mm	2.0	13300
D045/180	€ 16,00	Ø 180 mm	Ø 22,2 mm	5 mm	2.4	8500
D045/230	€ 22,60	Ø 230 mm	Ø 22,2 mm	5 mm	2.8	6600



D070-
DISCHI DIAMANTATI PER GRES PORCELLANATO PROFESSIONALI

Speciali per il taglio di gres porcellanato, klinker, travertino, cotto, ceramica dura, piastrelle, marmo con acqua e senz'acqua.



Art.	€	Diametro	Foro	Altezza diamante	Spessore taglio	Max rpm
D070/115	€ 30,00	Ø 115 mm	Ø 22,2 mm	10 mm	1.3 mm	13300
D070/180	€ 61,90	Ø 180 mm	Ø 22,2 mm	10 mm	1.6 mm	8500
D070/230	€ 87,60	Ø 230 mm	Ø 22,2 mm	10 mm	2.0 mm	6600

D060-
DISCHI DIAMANTATI VENTILATI PROFESSIONALI

Long life, per il taglio di muro, cemento, piastrelle, pietra, marmo con e senz'acqua.



Art.	€	Diametro	Foro	Altezza diamante	Spessore taglio	Max rpm
D060/115	€ 15,30	Ø 115 mm	Ø 22,2 mm	10 mm	1.4 mm	13300
D060/180	€ 54,10	Ø 180 mm	Ø 22,2 mm	10 mm	1.8 mm	8500
D060/230	€ 75,60	Ø 230 mm	Ø 22,2 mm	10 mm	2.4 mm	6600

D059-
DISCHI DIAMANTATI VENTILATI

Usò generale, per il taglio di muro, cemento, piastrelle, pietra, marmo con acqua e senz'acqua.



Art.	€	Diametro	Foro	Altezza diamante	Spessore taglio	Max rpm
D059/115	€ 8,90	Ø 115 mm	Ø 22,2 mm	7 mm	2.0 mm	13300
D059/180	€ 22,60	Ø 180 mm	Ø 22,2 mm	7 mm	2.4 mm	8500
D059/230	€ 42,00	Ø 230 mm	Ø 22,2 mm	7 mm	2.8 mm	6600

D055-
DISCHI DIAMANTATI VENTILATI A SEGMENTI PROFESSIONALI

Long life, per il taglio di muro, cemento, pietra, marmo senz'acqua.



Art.	€	Diametro	Foro	Altezza diamante	Segmenti	Spessore taglio	Max rpm
D055/115	€ 17,00	Ø 115 mm	Ø 22,2 mm	10 mm	9	1.9 mm	13300
D055/180	€ 49,50	Ø 180 mm	Ø 22,2 mm	10 mm	14	2.2 mm	8500
D055/230	€ 75,60	Ø 230 mm	Ø 22,2 mm	10 mm	18	2.6 mm	6600



**D054-****DISCHI DIAMANTATI VENTILATI A SEGMENTI**

Usò generale, per il taglio di muro, cemento, pietra, marmo senz'acqua



Art.	€	Diametro	Foro	Altezza diamante	Segmenti	Spessore taglio	Max rpm
D054/115	€ 6,90	ø 115 mm	ø 22,2 mm	7 mm	9	2.0	13300
D054/180	€ 19,60	ø 180 mm	ø 22,2 mm	7 mm	14	2.4	8500
D054/230	€ 29,10	ø 230 mm	ø 22,2 mm	7 mm	18	2.8	6600

**0350****DISCO DIAMANTATO TURBO VENTILATO**

€ 51,40

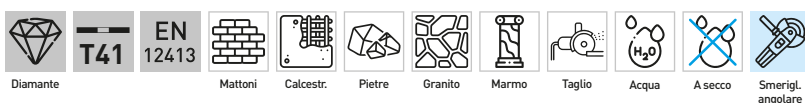

Dimensioni	ø 230 mm
Foro	ø 22,2 mm

**0709****DISCO DIAMANTATO TURBO VENTILATO**

€ 14,00

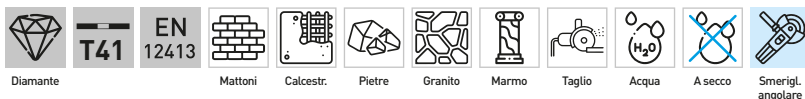

Dimensioni	ø 115 mm
Foro	ø 22,2 mm

**0833****PLATORELLO DIAMANTATO TURBO A TAZZA PER GRANITO E PIETRE**

€ 68,90

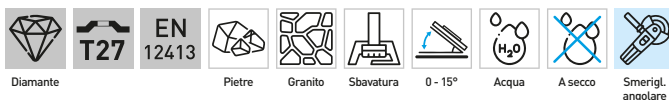

Dimensioni	ø 100 mm
Foro	ø 22,2 mm

**D040-****PLATORELLO DIAMANTATO A SEGMENTI**

Usò generale, per gres porcellanato, klinker, travertino, cotto, ceramica dura, piastrelle, marmo con acqua e senz'acqua.







Art.	€	Diametro	Foro	Segmenti	Max rpm
D040/115	€ 29,40	ø 115 mm	ø 22,2 mm	8 + 8	13300
D040/180	€ 59,00	ø 180 mm	ø 22,2 mm	14 + 14	8500







**ARREDAMENTO
DA OFFICINA**

- p. 319  Arredamenti modulari
- p. 327  Banchi da lavoro
- p. 329  Armadietti e contenitori
- p. 333  Carrelli portautensili
- p. 337  Cassette e valigette



**MORSE DA BANCO
E INCUDINI**

- p. 342  Morse da banco
- p. 344  Morsetti
- p. 345  Incudini





**MACCHINE PER
TRATTAMENTI E FINITURE**

- p. 348  Sabbiatrici
- p. 355  Lavapezzi
- p. 358  Aspirapolvere
aspiraliquidi
- p. 361  Marcatura



**PRESSE E
DIVARICATORI**

- p. 365  Presse idrauliche
- p. 367  Presse manuali
- p. 368  Pompe idrauliche



OFFICINA AUTO E MOTO

- p. 370  Cric a carrello
e cavalletti
- p. 372  Gruette
e supporti motore
- p. 374  Unità raccogli olio
- p. 375  Argani per auto
- p. 376  Sollevatori
da moto e quad
- p. 378  Carrellini sottauto



**SOLLEVAMENTO E
MOVIMENTAZIONE**

- p. 379  Cric idraulici
- p. 380  Carrelli
- p. 383  Paranchi
- p. 384  Accessori
per il sollevamento
- p. 387  Argani e tendi cavi
- p. 388  Movimentazione pallet



LA SOLUZIONE OTTIMALE PER ARREDARE LA TUA OFFICINA, IL TUO GARAGE O IL TUO ANGOLO RACING

SCEGLI TRA LE COMPOSIZIONI CREATE PER TE DA FERVI O CONFIGURA IL TUO ARREDAMENTO DA OFFICINA MODULARE ED AUTOPORTANTE SECONDO LE TUE ESIGENZE.

A007/07

PROFILO DI GIUNZIONE PER PANNELLI FORATI
NECESSARI PER COLLEGARE I MODULI

A007/02

ARMADIO ALTO
CON 3 PIANI INTERNI

A007/10

PANNELLO FORATO

A007/01

ARMADIO PENSILE
DA FISSARE AL PANNELLO FORATO

A007/11

TERMINALE PER PANNELLI FORATI
PER TERMINARE LA CONFIGURAZIONE SENZA ARMADIO

A007/09

PIANI DI LAVORO
DISPONIBILI IN 3 MISURE E 2 MATERIALI

A007/03

ARMADIO BASSO A DUE ANTE
CON UN PIANO INTERNO

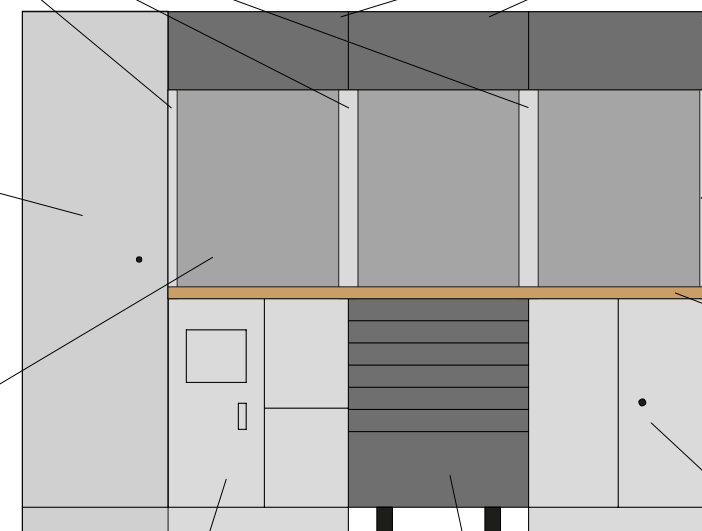

A007/06

ARMADIO BASSO MULTIFUNZIONE

A007/16

CASSETTIERA A CARRELLO
DEVE ESSERE INSERITA NELLO SPAZIO CENTRALE DI UN PIANO A 3 MODULI

ESEMPIO DI CONFIGURAZIONE A TRE MODULI CON ARMADIO

A007A
€ 4920,00
ARREDAMENTO MODULARE PER OFFICINA

La soluzione ottimale per arredare la tua officina, il tuo garage o il tuo angolo racing.

- 4 ARMADI PENSILI CON AMMORTIZZATORI A GAS [A007/01]
- 2 ARMADI ALTI CON 3 PIANI INTERNI [A007/02]
- 1 ARMADIO BASSO A DUE ANTE CON UN PIANO INTERNO [A007/03]
- 1 CASSETTIERA A 4 CASSETTI SU CUSCINETTI [A007/04]
- 2 CASSETTIERE A 5 CASSETTI SU CUSCINETTI [A007/05]
- 5 PROFILI DI GIUNZIONE PER PANNELLI FORATI [A007/07]
- 2 PIANI IN LEGNO [A007/08]
- 4 PANNELLI FORATI [A007/10]

Dimensioni 3920 x 498 x 2000h mm

A008A € 5170,00
CON PIANO IN ACCIAIO INOX
A007B
€ 4820,00
ARREDAMENTO MODULARE PER OFFICINA

La soluzione ottimale per arredare la tua officina, il tuo garage o il tuo angolo racing.

- 4 ARMADI PENSILI CON AMMORTIZZATORI A GAS [A007/01]
- 2 ARMADI ALTI CON 3 PIANI INTERNI [A007/02]
- 1 ARMADIO BASSO A DUE ANTE CON UN PIANO INTERNO [A007/03]
- 2 CASSETTIERE A 5 CASSETTI SU CUSCINETTI [A007/05]
- 1 ARMADIO BASSO MULTIFUNZIONE [A007/06]
- 5 PROFILI DI GIUNZIONE PER PANNELLI FORATI [A007/07]
- 2 PIANI IN LEGNO [A007/08]
- 4 PANNELLI FORATI [A007/10]

Dimensioni 3920 x 498 x 2000h mm

A008B € 5040,00
CON PIANO IN ACCIAIO INOX
A007C
€ 2370,00
ARREDAMENTO MODULARE PER OFFICINA

La soluzione ottimale per arredare la tua officina, il tuo garage o il tuo angolo racing.

- 2 ARMADI PENSILI CON AMMORTIZZATORI A GAS [A007/01]
- 1 ARMADIO ALTO CON 3 PIANI INTERNI [A007/02]
- 1 ARMADIO BASSO A DUE ANTE CON UN PIANO INTERNO [A007/03]
- 1 CASSETTIERA A 5 CASSETTI SU CUSCINETTI [A007/05]
- 2 PROFILI DI GIUNZIONE PER PANNELLI FORATI [A007/07]
- 1 PIANO IN LEGNO [A007/08]
- 2 PANNELLI FORATI [A007/10]
- 1 PROFILO PER PANNELLI FORATI [A007/11]

Dimensioni 1960 x 498 x 2000h mm

A008C € 2490,00
CON PIANO IN ACCIAIO INOX
A007D
€ 3300,00
ARREDAMENTO MODULARE PER OFFICINA

La soluzione ottimale per arredare la tua officina, il tuo garage o il tuo angolo racing.

- 3 ARMADI PENSILI CON AMMORTIZZATORI A GAS [A007/01]
- 1 ARMADIO ALTO CON 3 PIANI INTERNI [A007/02]
- 1 ARMADIO BASSO A DUE ANTE CON UN PIANO INTERNO [A007/03]
- 1 CASSETTIERA A 4 CASSETTI SU CUSCINETTI [A007/04]
- 1 CASSETTIERA A 5 CASSETTI SU CUSCINETTI [A007/05]
- 3 PROFILI DI GIUNZIONE PER PANNELLI FORATI [A007/07]
- 1 PIANO IN LEGNO [A007/09]
- 3 PANNELLI FORATI [A007/10]
- 1 PROFILO PER PANNELLO FORATO [A007/11]

Dimensioni 2640 x 498 x 2000h mm

A008D € 3460,00
CON PIANO IN ACCIAIO INOX

A007E
€ 2720,00
ARREDAMENTO MODULARE PER OFFICINA

La soluzione ottimale per arredare la tua officina, il tuo garage o il tuo angolo racing.

- 3 ARMADI PENSILI CON AMMORTIZZATORI [A007/01]
- 1 ARMADIO ALTO CON 3 PIANI INTERNI [A007/02]
- 1 ARMADIO BASSO A DUE ANTE CON PIANO INTERNO [A007/03]
- 1 ARMADIO BASSO MULTIFUNZIONE [A007/06]
- 3 PROFILI DI GIUNZIONE PER PANNELLI FORATI [A007/07]
- 1 PIANO IN LEGNO [A007/09]
- 3 PANNELLI FORATI [A007/10]
- 1 CASSETTIERA A CARRELLO CON 7 CASSETTI SU CUSCINETTI [A007/16]

 Dimensioni 2640 x 498 x 2000h mm

A007F
€ 1270,00
ANGOLO PER ARREDAMENTO MODULARE DA OFFICINA

La soluzione ottimale per arredare la tua officina, il tuo garage o il tuo angolo racing.

- 2 PROFILI DI GIUNZIONE PER PANNELLI FORATI [A007/07]
- 2 PROFILI PER PANNELLO FORATO [A007/11]
- 2 PANNELLI FORATI PER ANGOLO [A007/12]
- 1 ARMADIO PENSILE PER ANGOLO CON AMMORTIZZATORI A GAS [A007/13]
- 1 PIANO IN LEGNO PER ANGOLO [A007/14]
- 1 ARMADIO BASSO ANGOLARE CON UN PIANO INTERNO [A007/15]

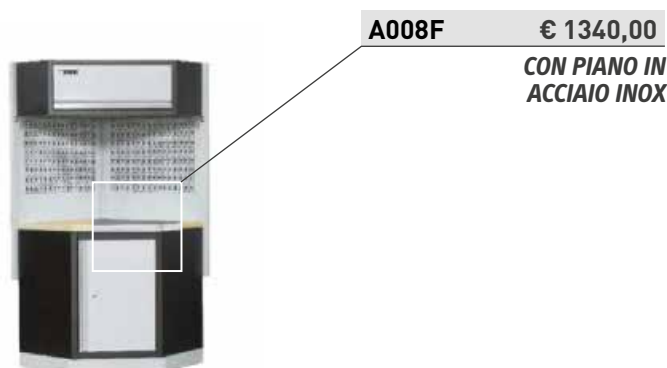
 Dimensioni 864 x 864 x 2000h mm

A007G
€ 2810,00
ARREDAMENTO MODULARE PER OFFICINA

La soluzione ottimale per arredare la tua officina, il tuo garage o il tuo angolo racing.

- 3 ARMADI PENSILI CON AMMORTIZZATORI [A007/01]
- 1 ARMADIO ALTO CON 3 PIANI INTERNI [A007/02]
- 1 ARMADIO BASSO A DUE ANTE CON UN PIANO INTERNO [A007/03]
- 1 ARMADIO BASSO MULTIFUNZIONE [A007/06]
- 3 PROFILI DI GIUNZIONE PER PANNELLI FORATI [A007/07]
- 1 PIANO IN LEGNO [A007/09]
- 3 PANNELLI FORATI [A007/10]
- 1 PROFILO PER PANNELLI FORATI [A007/11]
- 1 CASSETTIERA CON 7 CASSETTI SU CUSCINETTI [A007/17]

 Dimensioni 2640 x 498 x 2000h mm

A007H
€ 5320,00
ARREDAMENTO MODULARE PER OFFICINA

La soluzione ottimale per arredare la tua officina, il tuo garage o il tuo angolo racing.

- 5 ARMADI PENSILI CON AMMORTIZZATORI [A007/01]
- 1 ARMADIO ALTO CON 3 PIANI INTERNI [A007/02]
- 1 ARMADIO BASSO A DUE ANTE CON UN PIANO INTERNO [A007/03]
- 1 CASSETTIERA A 4 CASSETTI SU CUSCINETTI [A007/04]
- 1 CASSETTIERA A 5 CASSETTI SU CUSCINETTI [A007/05]
- 1 ARMADIO BASSO MULTIFUNZIONE [A007/06]
- 6 PROFILI DI GIUNZIONE PER PANNELLI FORATI [A007/07]
- 1 PIANO IN LEGNO [A007/08]
- 1 PIANO IN LEGNO [A007/09]
- 5 PANNELLI FORATI [A007/10]
- 3 PROFILI PER PANNELLI FORATI [A007/11]
- 2 PANNELLI FORATI PER ANGOLARE [A007/12]
- 1 ARMADIO ANGOLARE PENSILE CON AMMORTIZZATORI [A007/13]
- 1 PIANO IN LEGNO ANGOLARE [A007/14]
- 1 ARMADIO BASSO ANGOLARE CON UN PIANO INTERNO [A007/15]
- 1 CASSETTIERA A CARRELLO CON 7 CASSETTI SU CUSCINETTI [A007/16]

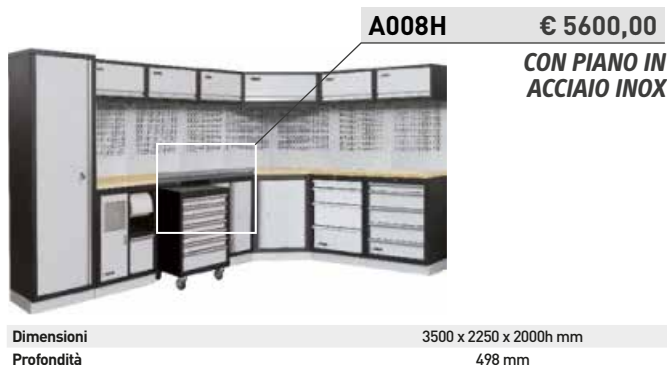

A007I
€ 2550,00
ARREDAMENTO MODULARE PER OFFICINA

La soluzione ottimale per arredare la tua officina, il tuo garage o il tuo angolo racing.

- 2 ARMADI PENSILI CON AMMORTIZZATORI A GAS [A007/01]
- 1 ARMADIO ALTO CON 3 PIANI INTERNI [A007/02]
- 1 ARMADIO BASSO MULTIFUNZIONE [A007/06]
- 2 PROFILI DI GIUNZIONE PER PANNELLI FORATI [A007/07]
- 1 PIANO IN LEGNO [A007/08]
- 2 PANNELLI FORATI [A007/10]
- 1 PROFILO PER PANNELLI FORATI [A007/11]
- 1 CASSETTIERA A 7 CASSETTI SU CUSCINETTI [A007/17]

Dimensioni 1960 x 498 x 2000h mm

A008I
€ 2670,00
CON PIANO IN ACCIAIO INOX
A007L
€ 5610,00
ARREDAMENTO MODULARE PER OFFICINA

La soluzione ottimale per arredare la tua officina, il tuo garage o il tuo angolo racing.

- 4 ARMADI PENSILI CON AMMORTIZZATORI A GAS [A007/01]
- 2 ARMADI ALTI CON 3 PIANI INTERNI [A007/02]
- 1 ARMADIO BASSO A DUE ANTE CON UN PIANO INTERNO [A007/03]
- 1 CASSETTIERA A 4 CASSETTI SU CUSCINETTI [A007/04]
- 1 ARMADIO BASSO MULTIFUNZIONE [A007/06]
- 6 PROFILI DI GIUNZIONE PER PANNELLI FORATI [A007/07]
- 2 PIANI IN LEGNO [A007/08]
- 4 PANNELLI FORATI [A007/10]
- 2 PROFILI PER PANNELLI FORATI [A007/11]
- 2 PANNELLI FORATI PER ANGOLARE [A007/12]
- 1 ARMADIO ANGOLARE PENSILE CON AMMORTIZZATORI A GAS [A007/13]
- 1 PIANO IN LEGNO ANGOLARE [A007/14]
- 1 ARMADIO BASSO ANGOLARE CON UN PIANO INTERNO [A007/15]
- 1 CASSETTIERA A 7 CASSETTI SU CUSCINETTI [A007/17]

A008L
€ 5900,00
CON PIANO IN ACCIAIO INOX

 Dimensioni 2800 x 2800 x 2000h mm
 Profondità 498 mm

A007M
€ 1710,00
ARREDAMENTO MODULARE PER OFFICINA

La soluzione ottimale per arredare la tua officina, il tuo garage o il tuo angolo racing.

- 2 ARMADI PENSILI CON AMMORTIZZATORI A GAS [A007/01]
- 1 ARMADIO BASSO A DUE ANTE CON UN PIANO INTERNO [A007/03]
- 1 CASSETTIERA A 5 CASSETTI SU CUSCINETTI [A007/05]
- 2 PROFILI DI GIUNZIONE PER PANNELLI FORATI [A007/07]
- 1 PIANO IN LEGNO [A007/08]
- 2 PANNELLI FORATI [A007/10]
- 2 PROFILI PER PANNELLI FORATI [A007/11]

Dimensioni 1360 x 498 x 2000h mm

A008M
€ 1810,00
CON PIANO IN ACCIAIO INOX
A007N
€ 2750,00
ARREDAMENTO MODULARE PER OFFICINA

La soluzione ottimale per arredare la tua officina, il tuo garage o il tuo angolo racing.

- 3 ARMADI PENSILI CON AMMORTIZZATORI A GAS [A007/01]
- 1 ARMADIO BASSO A DUE ANTE CON UN PIANO INTERNO [A007/03]
- 1 CASSETTIERA A 4 CASSETTI SU CUSCINETTI [A007/04]
- 1 CASSETTIERA A 5 CASSETTI SU CUSCINETTI [A007/05]
- 3 PROFILI DI GIUNZIONE PER PANNELLI FORATI [A007/07]
- 1 PIANO IN LEGNO [A007/09]
- 3 PANNELLI FORATI [A007/10]
- 2 PROFILI PER PANNELLI FORATI [A007/11]

Dimensioni 2040 x 498 x 2000h mm

A008N
€ 2890,00
CON PIANO IN ACCIAIO INOX

A007P
€ 5160,00
ARREDAMENTO MODULARE PER OFFICINA

La soluzione ottimale per arredare la tua officina, il tuo garage o il tuo angolo racing.

- 4 ARMADI PENSILI CON AMMORTIZZATORI A GAS [A007/01]
- 2 ARMADI ALTI CON 3 PIANI INTERNI [A007/02]
- 1 ARMADIO BASSO A DUE ANTE CON UN PIANO INTERNO [A007/03]
- 1 ARMADIO BASSO MULTIFUNZIONE [A007/06]
- 5 PROFILI DI GIUNZIONE PER PANNELLI FORATI [A007/07]
- 1 PIANO IN LEGNO [A007/09]
- 4 PANNELLI FORATI [A007/10]
- 1 CASSETTIERA A CARRELLO CON 7 CASSETTI SU CUSCINETTI [A007/16]
- 1 PIANO IN LEGNO [A007/19]
- 1 CASSETTIERA A 9 CASSETTI SU CUSCINETTI [A007/20]

Dimensioni 3920 x 498 x 2000h mm

A008P
€ 5390,00
CON PIANO IN ACCIAIO INOX

A007Q
€ 2670,00
ARREDAMENTO MODULARE PER OFFICINA

La soluzione ottimale per arredare la tua officina, il tuo garage o il tuo angolo racing.

- 2 ARMADI PENSILI CON AMMORTIZZATORI A GAS [A007/01]
- 1 ARMADIO ALTO CON 3 PIANI INTERNI [A007/02]
- 1 CASSETTIERA A 4 CASSETTI SU CUSCINETTI [A007/04]
- 2 PROFILI DI GIUNZIONE PER PANNELLI FORATI [A007/07]
- 1 PIANO IN LEGNO [A007/08]
- 2 PANNELLI FORATI [A007/10]
- 1 PROFILO PER PANNELLI FORATI [A007/11]
- 1 CASSETTIERA A 9 CASSETTI SU CUSCINETTI [A007/20]

Dimensioni 1960 x 498 x 2000h mm

A008Q
€ 2780,00
CON PIANO IN ACCIAIO INOX

A007R
€ 1140,00
ARREDAMENTO MODULARE PER OFFICINA

La soluzione ottimale per arredare la tua officina, il tuo garage o il tuo angolo racing.

- 1 ARMADIO PENSILE CON AMMORTIZZATORI A GAS [A007/01]
- 2 PROFILI DI GIUNZIONE PER PANNELLI FORATI [A007/07]
- 1 PANNELLO FORATO [A007/10]
- 2 PROFILI PER PANNELLI FORATI [A007/11]
- 1 PIANO IN LEGNO [A007/19]
- 1 CASSETTIERA A 9 CASSETTI SU CUSCINETTI [A007/20]

Dimensioni 680 x 498 x 2000h mm

A008R
€ 1210,00
CON PIANO IN ACCIAIO INOX

A007S
€ 3090,00
ARREDAMENTO MODULARE PER OFFICINA

La soluzione ottimale per arredare la tua officina, il tuo garage o il tuo angolo racing.

- 3 ARMADI PENSILI CON AMMORTIZZATORI [A007/01]
- 1 ARMADIO ALTO CON 3 PIANI INTERNI [A007/02]
- 1 ARMADIO BASSO A DUE ANTE CON UN PIANO INTERNO [A007/03]
- 3 PROFILI DI GIUNZIONE PER PANNELLI FORATI [A007/07]
- 1 PIANO IN LEGNO [A007/09]
- 3 PANNELLI FORATI [A007/10]
- 1 PROFILO PER PANNELLI FORATI [A007/11]
- 1 CASSETTIERA A 9 CASSETTI [A007/20]
- 1 CARRELLO A 3 RIPIANI [A007/22]

Dimensioni 2640 x 498 x 2000h mm

A008S
€ 3200,00
CON PIANO IN ACCIAIO INOX

A007T
€ 2470,00
ARREDAMENTO MODULARE PER OFFICINA

La soluzione ottimale per arredare la tua officina, il tuo garage o il tuo angolo racing.

- 2 ARMADI PENSILI CON AMMORTIZZATORI A GAS [A007/01]
- 1 ARMADIO BASSO A DUE ANTE CON UN PIANO INTERNO [A007/03]
- 1 CASSETTIERA A 5 CASSETTI SU CUSCINETTI [A007/05]
- 2 PROFILI DI GIUNZIONE PER PANNELLI FORATI [A007/07]
- 1 PIANO IN LEGNO [A007/08]
- 2 PANNELLI FORATI [A007/10]
- 1 PROFILO PER PANNELLI FORATI [A007/11]
- 1 ARMADIO ALTO A 2 ANTE CON 3 PIANI INTERNI [A007/23]

Dimensioni 2275 x 498 x 2000h mm

A008T
€ 2580,00
CON PIANO IN ACCIAIO INOX
A007U
€ 3250,00
ARREDAMENTO MODULARE PER OFFICINA

La soluzione ottimale per arredare la tua officina, il tuo garage o il tuo angolo racing.

- 3 ARMADI PENSILI CON AMMORTIZZATORI [A007/01]
- 1 ARMADIO ALTO CON 3 PIANI INTERNI [A007/02]
- 1 ARMADIO BASSO A DUE ANTE CON UN PIANO INTERNO [A007/03]
- 3 PROFILI DI GIUNZIONE PER PANNELLI FORATI [A007/07]
- 1 PIANO IN LEGNO [A007/09]
- 3 PANNELLI FORATI [A007/10]
- 1 PROFILO PER PANNELLI FORATI [A007/11]
- 1 CASSETTIERA CON 7 CASSETTI SU CUSCINETTI [A007/17]
- 1 ARMADIO BASSO PER ARROTOLATORI [A007/18]

Dimensioni 2640 x 498 x 2000h mm

A008U
€ 3380,00
CON PIANO IN ACCIAIO INOX
A007UF
€ 3560,00
ARREDAMENTO MODULARE PER OFFICINA

La soluzione ottimale per arredare la tua officina, il tuo garage o il tuo angolo racing.

- 3 ARMADI PENSILI CON AMMORTIZZATORI [A007/01]
- 1 ARMADIO ALTO CON 3 PIANI INTERNI [A007/02]
- 1 ARMADIO BASSO A DUE ANTE CON UN PIANO INTERNO [A007/03]
- 3 PROFILI DI GIUNZIONE PER PANNELLI FORATI [A007/07]
- 1 PIANO IN LEGNO [A007/09]
- 3 PANNELLI FORATI [A007/10]
- 1 PROFILO PER PANNELLI FORATI [A007/11]
- 1 CASSETTIERA CON 7 CASSETTI SU CUSCINETTI [A007/17]
- 1 ARMADIO BASSO PER ARROTOLATORI [A007/18]
- 1 AVVOLGICAVO AUTO RIENTRANTE [0621/A3]
- 1 AVVOLGITUBO AUTO RIENTRANTE PER ARIA [0481/15]

Dimensioni 2640 x 498 x 2000h mm



A008UF
€ 3660,00
CON PIANO IN ACCIAIO INOX

A007V
€ 5160,00
ARREDAMENTO MODULARE PER OFFICINA

La soluzione ottimale per arredare la tua officina, il tuo garage o il tuo angolo racing.

- 4 ARMADI PENSILI CON AMMORTIZZATORI A GAS [A007/01]
- 2 ARMADI ALTI CON 3 PIANI INTERNI [A007/02]
- 1 CASSETTIERA A 5 CASSETTI SU CUSCINETTI [A007/05]
- 1 ARMADIO BASSO MULTIFUNZIONE [A007/06]
- 5 PROFILI DI GIUNZIONE PER PANNELLI FORATI [A007/07]
- 1 PIANO IN LEGNO [A007/08]
- 4 PANNELLI FORATI [A007/10]
- 1 CASSETTIERA GRANDE ALL'AMERICANA [A007/21]

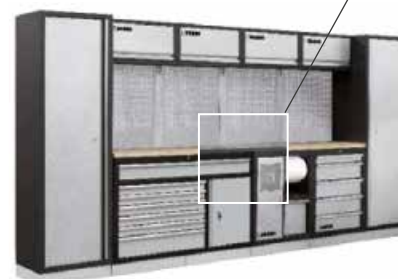
Dimensioni 3920 x 498 x 2000h mm

A008V
€ 5370,00
CON PIANO IN ACCIAIO INOX

A007/02
€ 685,00
ARMADIO ALTO

Con 3 piani interni.



Dimensioni	600 x 458 x 2000 mm
Dimensioni sportello	510 x 1810 mm
Profondità interna	410 mm
Portata max	180 kg

A007/23
€ 868,00
ARMADIO ALTO A 2 ANTE

Con 5 piani interni.



Dimensioni	915 x 458 x 2000 mm
Dimensioni sportello	510 x 1810 mm
Profondità interna	410 mm
Portata max	300 kg

A007/03
€ 343,00
ARMADIO BASSO A DUE ANTE

Con un piano interno.



Dimensioni	680 x 458 x 910 mm
Dimensioni sportello	710 x 295 mm
Profondità interna	445 mm
Portata max	60 kg

A007/06
€ 432,00
ARMADIO BASSO MULTIFUNZIONE

Dimensioni	680 x 458 x 910 mm
Dimensioni sportello	710 x 295 mm
Profondità interna	445 mm
Dimensioni cassetto	240 x 300 mm
Altezza massima rotolo carta	240 mm
Portata max	90 kg

A007/18
€ 528,00
ARMADIO BASSO PER ARROTOLATORI

Dimensioni	680 x 458 x 910 mm
Portata cassetto	30 kg

A007/04
€ 553,00
CASSETTIERA A 4 CASSETTI

Su cuscinetti.



Dimensioni	680 x 458 x 910 mm
Dimensioni cassetto	550 x 400 mm
Altezza cassette	1 x 68 mm - 1 x 145 mm - 2 x 214 mm
Portata cassetto	30 kg

A007/05
€ 591,00
CASSETTIERA A 5 CASSETTI

Su cuscinetti.



Dimensioni	680 x 458 x 910 mm
Dimensioni cassetto	550 x 400 mm
Altezza cassette	1 x 68 mm - 4 x 145 mm
Portata cassetto	30 kg

A007/17
€ 636,00
CASSETTIERA A 7 CASSETTI

Su cuscinetti.



Dimensioni	680 x 458 x 910 mm
Dimensioni cassetto	550 x 400 mm
Altezza cassette	5 x 74.5 mm - 2 x 153.5 mm
Portata cassetto	30 kg

**A007/20****€ 729,00****CASSETTIERA A 9 CASSETTI**

Su cuscinetti.



Dimensioni	680 x 458 x 910 mm
Dimensioni cassetto	550 x 400 mm
Altezza cassette	9 x 74,5 mm
Portata cassetto	30 kg

A007/16**€ 685,00****CASSETTIERA A CARRELLO**

Con 7 cassette su cuscinetti.



Dimensioni	660 x 455 x 860 mm
Dimensioni cassetto	525 x 400 mm
Profondità interna	6 x 68 mm - 1 x 145 mm
Portata cassetto	30 kg

A007/211**€ 1250,00****CASSETTIERA GRANDE AMERICANA**

Con piano in acciaio.



Dimensioni	1360 x 458 x 948,5 mm
Dimensioni sportello	535 x 430 mm
Dimensioni cassetto	1 - 1285 x 400 mm 6 - 810 x 400 mm
Altezza cassette	1 x 123,5 mm - 5 x 74,5 mm - 1 x 153,5 mm
Portata cassetto	30 kg

A007/10**€ 97,20****PANNELLO FORATO**

Dimensioni	1052 x 614,5 x 24 mm
Portata max	10 kg

A007/22**€ 278,00****CARRELLO**

A 3 ripiani.



Dimensioni	648 x 458 x 865 mm
------------	--------------------

A007/21**€ 1140,00****CASSETTIERA GRANDE AMERICANA**

Con piano in legno.



Dimensioni	1360 x 458 x 945 mm
Dimensioni sportello	535 x 430 mm
Dimensioni cassetto	1 - 1285 x 400 mm 6 - 810 x 400 mm
Altezza cassette	1 x 123,5 mm - 5 x 74,5 mm - 1 x 153,5 mm
Portata cassetto	30 kg

A007/01**€ 198,00****ARMADIO PENSILE**

Con ammortizzatori a gas.

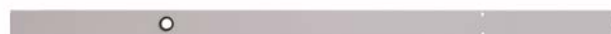

Dimensioni	680 x 281 x 350 mm
Dimensioni sportello	610 x 280 mm
Profondità interna	280 mm
Portata max	15 kg

A007/07**€ 24,40****PROFILO DI GIUNZIONE PER PANNELLI FORATI****A007/11****€ 22,00****TERMINALE PER PANNELLI FORATI**

A007-xP
PIANI DI LAVORO

Art.	€	Modulo	Materiale	Dimensioni	Spessore
A007/08	€ 178,00	2	Legno	1360 x 460 mm	35 mm
A007/08I	€ 289,00	2	Acciaio Inox	1360 x 460 mm	35 mm
A007/09	€ 281,00	3	Legno	2040 x 460 mm	35 mm
A007/09I	€ 409,00	3	Acciaio Inox	2040 x 460 mm	35 mm
A007/19	€ 101,00	1	Legno	680 x 460 mm	35 mm
A007/19I	€ 173,00	1	Acciaio Inox	680 x 460 mm	35 mm

A007/LED
€ 45,10
ILLUMINAZIONE LED PER ARREDAMENTO DA OFFICINA

Con nastro bi-adesivo, da utilizzare in accoppiata con il caricabatterie A007/LED/C.
Due strisce Led possono essere collegate in serie.



Scatola

A007/LED/C
€ 19,80
ALIMENTATORE PER ILLUMINAZIONE LED

Scatola

P40VD
€ 11,00
PEDANE

Componibili, piastrella autobloccante drenante verde.

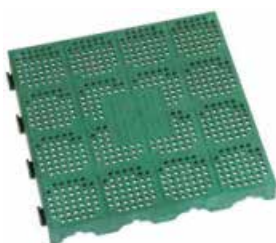

Poliprop.

Dimensioni 400 x 400 x 48 mm
Pz. - Pallet 120 = 20 m²

PSV-F
€ 7,90
SCIVOLO IN POLIPROPILENE

Per pedane, verde, femmina (senza ganci).



Poliprop.

Dimensioni 205 x 400 x 48 mm

PSV-M
€ 7,90
SCIVOLO IN POLIPROPILENE

Per pedane, verde, maschio (con ganci).

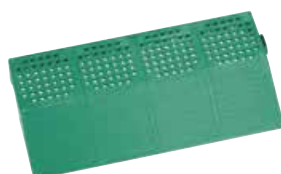

Poliprop.

Dimensioni 205 x 400 x 48 mm

PAV
€ 11,10
SCIVOLI AD ANGOLO

Per pedane in polipropilene componibili, kit composto da 4 angolari verdi.



4 Pcs

Poliprop.

Dimensioni 200 x 200 x 270 x 48 mm

**B015**

€ 601,00

BANCO DA LAVORO IN KIT DI MONTAGGIO

Con piano in lamiera e due cassetti con chiave.



Dimensioni banco	1500 x 645 x 865h mm
Spessore gambe	1 mm
Spessore piano	2 mm
Portata	800 kg
Dimensioni cassetto	433 x 347 x 122h mm
Portata cassetto	30 kg
Peso netto	62 kg

B015/10

€ 336,00

BANCO DA LAVORO IN KIT DI MONTAGGIO

Con piano in lamiera e cassetto con chiave.



Dimensioni	1000 x 640 x 865h mm
Spessore gambe	2 mm
Spessore piano	2 mm
Portata	600 kg
Dimensioni cassetto	433 x 347 x 122h mm
Portata cassetto	30 kg
Peso netto	55 kg

B022/10

€ 393,00

BANCO DA LAVORO IN KIT DI MONTAGGIO

Con piano in legno pressato e cassetto con chiave.



Dimensioni	1000 x 640 x 865h mm
Spessore gambe	2 mm
Spessore piano	38 mm
Portata	350 kg
Dimensioni cassetto	400 x 344 x 125h mm
Portata cassetto	50 kg
Peso netto	47 kg

B022/15

€ 566,00

BANCO DA LAVORO IN KIT DI MONTAGGIO

Con piano in legno pressato e 2 cassetti con chiave.



Dimensioni	1500 x 640 x 865h mm
Spessore gambe	2 mm
Spessore piano	38 mm
Portata	350 kg
Dimensioni cassetto	400 x 344 x 125h mm
Portata cassetto	50 kg
Peso netto	75 kg

B017/C

€ 81,00

CASSETTO IN ACCIAIO CON SERRATURA

Su guide a cuscinetti costruito in acciaio, adattabile su banchi di altre marche.



Dimensioni ingombro	680 x 270 x 130 mm
Dimensioni interne	640 x 260 x 90 mm
Portata	18,5 kg
Peso netto	4,3 kg



B009/A1 € 566,00
BANCO DA LAVORO IN KIT DI MONTAGGIO

Con piano in legno pressato, 3 cassetti con chiave e ripiano, piedini regolabili.



Dimensioni	1200 x 600 x 865h mm
Spessore gambe	2 mm
Spessore piano	36 mm
Portata	350 kg
Peso netto	62 kg

B009/B1 € 659,00
BANCO DA LAVORO IN KIT DI MONTAGGIO

Con piano in legno pressato, 3 cassetti con chiave e anta con ripiano, piedini regolabili.



Dimensioni	1200 x 600 x 865h mm
Spessore gambe	2 mm
Spessore piano	36 mm
Portata	350 kg
Peso netto	64,5 kg

B009/A2 € 892,00
BANCO DA LAVORO IN KIT DI MONTAGGIO

Con piano in legno pressato, 3 cassetti con chiave, anta e ripiano, piedini regolabili.



Dimensioni	1690 x 600 x 865 mm
Spessore gambe	2 mm
Spessore piano	36 mm
Portata	350 kg
Peso netto	84 kg

B009/B2 € 937,00
BANCO DA LAVORO IN KIT DI MONTAGGIO

Con piano in legno pressato, 3 cassetti con chiave e 2 ante con ripiano, piedini regolabili.



Dimensioni	1690 x 600 x 865 mm
Spessore gambe	2 mm
Spessore piano	36 mm
Portata	350 kg
Peso netto	90 kg

B019 € 601,00
BANCO CHIUDIBILE IN ACCIAIO

Con piano richiudibile aiutato da 2 ammortizzatori ad aria, pannello porta attrezzi 1195 x 458 x 20 mm, altezza massima 1380 mm, larghezza massima 1280 mm, profondità banco aperto 648 mm, profondità banco chiuso 130 mm ad un'altezza di 330 mm, bloccaggi per piano aperto e chiuso, pannello con fori Ø 4 mm, interasse fori 25 mm per ganci con filo di Ø 3 mm.



Dimensioni piano	1195 x 648 x 41 mm
Interasse fori	25 mm
Portata	225 kg
Peso netto	45 kg

B019/G030 € 12,60
SERIE GANCI

10 Pcs

Lunghezza	30 mm
Interasse dei perni	25 mm

Gx
SERIE GANCI

10 Pcs

Art.	€	Interasse dei perni	Lunghezza
G050	€ 12,60	30 mm	80 mm
G130	€ 17,70	30 mm	155 mm



**P009**

€ 210,00

ARMADIETTO DA PARETE IN KIT DI MONTAGGIO

Con 18 ganci in dotazione.

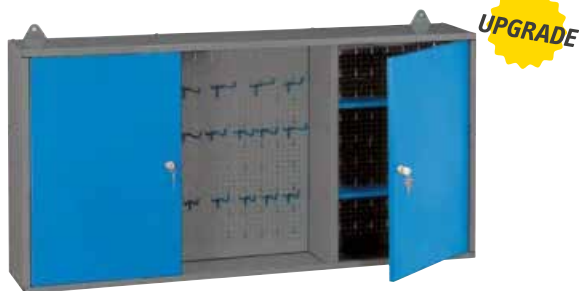

Dimensioni armadietto	1200 x 200 x 600h mm
Spessore lamiera	0,8 mm
Ripiani interni	4
Ganci	18 (6 + 6 + 6)
Interasse fori	30 mm
Peso netto	17 kg

A100

€ 302,00

ARMADIETTO

Con 1 cassetto su sfere con serratura.



Dimensioni armadietto	500 x 460 x 1000h mm
Spessore lamiera	1 mm
Ripiani interni	2
Portata max	100 kg
Portata ripiano	25 kg
Peso netto	35 kg

A300

€ 483,00

ARMADIETTO

Con 2 cassetti su sfere con serratura.



Dimensioni armadietto	1000 x 460 x 1000h mm
Spessore lamiera	1 mm
Ripiani interni	2
Portata max	150 kg
Portata ripiano	25 kg
Peso netto	62 kg

C800

€ 1040,00

CASSETTIERA PORTA UTENSILI

Con 8 cassetti su cuscinetti con serratura, senza divisorie.



Portata cassetto	50 kg
Dimensioni esterne	630 x 550 x 930h mm
Dimensioni cassetto	517 x 440 mm
Altezza cassetti	8 x 73 mm
Peso netto	58 kg

C600

€ 838,00

CASSETTIERA PORTA UTENSILI

Con 6 cassetti su cuscinetti con serratura, senza divisorie.



Portata cassetto	50 kg
Dimensioni esterne	630 x 550 x 930h mm
Dimensioni cassetto	517 x 440 mm
Altezza cassetti	6 x 115 mm
Peso netto	53 kg

C603

€ 1010,00

CASSETTIERA PORTA UTENSILI

Con 6 cassetti su cuscinetti con serratura, senza divisorie.



Portata cassetto	50 kg
Dimensioni esterne	630 x 550 x 930h mm
Dimensioni cassetto	517 x 440 mm
Altezza cassetti	3 x 73 mm - 2 x 115 mm - 1 x 175 mm
Peso netto	53,5 kg

C800-
SEPARATORI PER CASSETTO "A"

Esempi di composizione dei separatori.



10 Pcs

Art.	€	Separatore longitudinale	Separatore trasversale
C800/CC	€ 62,20	440 x 70h mm	-
C800/LL	€ 68,50	-	517 x 70h mm

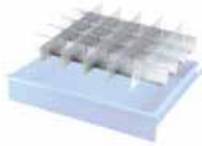
C600-
SEPARATORI PER CASSETTO "B"

Esempi di composizione dei separatori.



10 Pcs

Art.	€	Separatore longitudinale	Separatore trasversale
C600/C	€ 135,00	440 x 110h mm	-
C600/L	€ 31,20	-	120 x 110h mm

C603-
SEPARATORI PER CASSETTO "C"

Esempi di composizione dei separatori.



10 Pcs

Art.	€	Separatore longitudinale	Separatore trasversale
C603/C	€ 178,00	440 x 165h mm	-
C603/L	€ 37,20	-	120 x 165h mm

C080-
CASSETTIERE CON CASSETTI ESTRAIBILI TRASPARENTI

Modulari ed impilabili

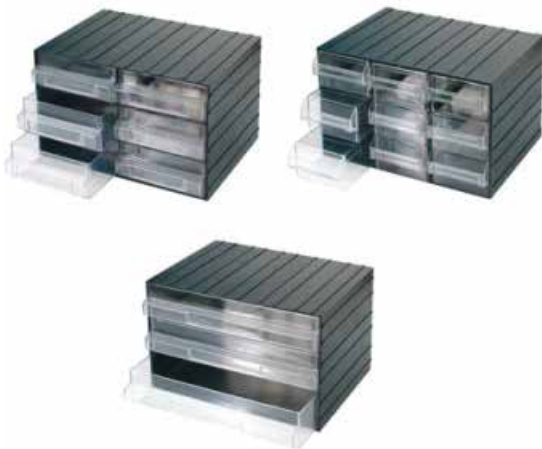

Art.	€	Dimensioni esterne	Dimensioni cassetto	Numero cassette
C080/3	€ 66,90	382 x 290 x 230h mm	372 x 285 x 73h mm	3
C080/6	€ 66,50	382 x 290 x 230h mm	184 x 285 x 73h mm	6
C080/9	€ 67,80	382 x 290 x 230h mm	122 x 285 x 73h mm	9

C700
€ 678,00
CASSETTIERA IN ACCIAIO CON VALIGETTE IN PLASTICA

Vano inferiore con serratura, vano superiore con 7 valigette con serratura centrale 4 x C360 + 3 x C371.



Dimensioni	490 x 343 x 987h mm
Peso netto	27 kg

C085-
CASSETTIERE CON CASSETTI ESTRAIBILI TRASPARENTI

Modulari ed impilabili.



Art.	€	Dimensioni esterne	Dimensioni cassetto	Numero cassette
C085/12	€ 40,60	382 x 148 x 230h mm	122 x 145 x 55h mm	12
C085/16	€ 40,60	382 x 148 x 230h mm	90 x 145 x 55h mm	16
C085/24	€ 45,70	382 x 148 x 230h mm	59 x 145 x 55h mm	24

**C086/01C**

€ 18,40

CASSETTIERA MODULARE CON CASSETTI ESTRAIBILI

Collegabile con altre cassettiere tramite guide per creare combinazioni infinite. Dotata di bloccaggio dei cassetti per evitare la caduta accidentale del contenuto e fori di fissaggio posteriori per l'aggancio a muro. Costruita in plastica resistente è adatta all'utilizzo in cantiere, domestico e per l'officina.



Dimensioni	295 x 165 x 200h mm
Numero cassetti	1
Dimensioni cassetto	250 x 150 x 150 mm

**C086/01T**

€ 18,40

CASSETTIERA MODULARE CON VASSOI ESTRAIBILI

Collegabile con altre cassettiere tramite guide per creare combinazioni infinite. Dotata di bloccaggio dei vassoi per evitare la caduta accidentale del contenuto e fori di fissaggio posteriori per l'aggancio a muro. Costruita in plastica resistente è adatta all'utilizzo in cantiere, domestico e per l'officina.



Dimensioni	295 x 165 x 200h mm
Numero cassetti	1
Dimensioni cassetto	250 x 160 x 150 mm

C086/02C

€ 20,90

CASSETTIERA MODULARE CON CASSETTI ESTRAIBILI

Collegabile con altre cassettiere tramite guide per creare combinazioni infinite. Dotata di bloccaggio dei cassetti per evitare la caduta accidentale del contenuto e fori di fissaggio posteriori per l'aggancio a muro. Costruita in plastica resistente è adatta all'utilizzo in cantiere, domestico e per l'officina.



Dimensioni	295 x 165 x 200h mm
Numero cassetti	2
Dimensioni cassetto	250 x 160 x 70 mm

C086/02T

€ 21,40

CASSETTIERA MODULARE CON VASSOI ESTRAIBILI

Collegabile con altre cassettiere tramite guide per creare combinazioni infinite. Dotata di bloccaggio dei vassoi per evitare la caduta accidentale del contenuto e fori di fissaggio posteriori per l'aggancio a muro. Costruita in plastica resistente è adatta all'utilizzo in cantiere, domestico e per l'officina.

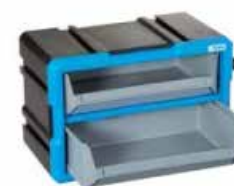

Dimensioni	295 x 165 x 200h mm
Numero cassetti	2
Dimensioni cassetto	250 x 160 x 70 mm

C086/04C

€ 22,00

CASSETTIERA MODULARE CON CASSETTI ESTRAIBILI

Collegabile con altre cassettiere tramite guide per creare combinazioni infinite. Dotata di bloccaggio dei cassetti per evitare la caduta accidentale del contenuto e fori di fissaggio posteriori per l'aggancio a muro. Costruita in plastica resistente è adatta all'utilizzo in cantiere, domestico e per l'officina.



Dimensioni	295 x 165 x 200h mm
Numero cassetti	4
Dimensioni cassetto	120 x 160 x 70 mm

C086/04T

€ 24,40

CASSETTIERA MODULARE CON VASSOI ESTRAIBILI

Collegabile con altre cassettiere tramite guide per creare combinazioni infinite. Dotata di bloccaggio dei vassoi per evitare la caduta accidentale del contenuto e fori di fissaggio posteriori per l'aggancio a muro. Costruita in plastica resistente è adatta all'utilizzo in cantiere, domestico e per l'officina.

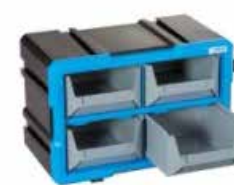

Dimensioni	295 x 165 x 200h mm
Numero cassetti	4
Dimensioni cassetto	120 x 160 x 70 mm

C086/12C

€ 25,50

CASSETTIERA MODULARE CON CASSETTI ESTRAIBILI

Collegabile con altre cassettiere tramite guide per creare combinazioni infinite. Dotata di bloccaggio dei cassetti per evitare la caduta accidentale del contenuto e fori di fissaggio posteriori per l'aggancio a muro. Costruita in plastica resistente è adatta all'utilizzo in cantiere, domestico e per l'officina.



Dimensioni	295 x 165 x 200h mm
Numero cassetti	12
Dimensioni cassetto	60 x 160 x 50 mm

C086/04C/D

€ 2,08

KIT DIVISORI PER CASSETTIERA MODULARE

4 Pcs

Dimensioni	111 x 63 mm
Pack	5

**C086/12C/D**

€ 3,34

KIT DIVISORI PER CASSETTIERA MODULARE

12 Pcs

Dimensioni	49.5 x 41 mm
Pack	5



C090-
CONTENITORE UNIVERSALE

Modulare ed impilabile.



Art.	€	Dimensioni
C090/2	€ 2,92	108 x 167 x 75h mm
C090/3	€ 5,80	151 x 237 x 126h mm
C090/4	€ 13,00	213 x 350 x 164h mm
C090/5	€ 21,40	310 x 490 x 190h mm
C090/6	€ 43,00	380 x 610 x 250h mm

0849
€ 262,00
SERIE BAULI IN ALLUMINIO

Con maniglie ergonomiche e serratura con chiave.

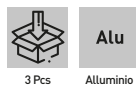

Dimensioni bauli	730 x 380 x 360h mm - 680 x 310 x 320h mm - 475 x 260 x 210h mm
Peso netto	14 kg

0382-
BAULI IN ALLUMINIO

Con serratura con chiave.



Art.	€	Dimensioni esterne	Dimensioni interne	Peso netto
0382	€ 1100,00	760 x 335 x 250h mm, 1240 x 385 x 385h mm, 1445 x 520 x 460h mm	710 x 285 x 225h mm, 1185 x 335 x 365h mm, 1395 x 435 x 440h mm	40 kg
0382/02	€ 198,00	760 x 335 x 250h mm	745 x 310 x 225h mm	6 kg
0382/03	€ 336,00	1240 x 385 x 385h mm	1185 x 335 x 365h mm	14 kg
0382/04	€ 596,00	1445 x 520 x 460h mm	1405 x 435 x 440h mm	21 kg

C087
€ 250,00
CARRELLO PORTA UTENSILI

Separabile in 3 pezzi.



Dimensioni	560 x 350 x 770h mm
Portata	40 kg
Peso netto	14 kg

0363-
BAULE IN ACCIAIO

Lucchettabili.

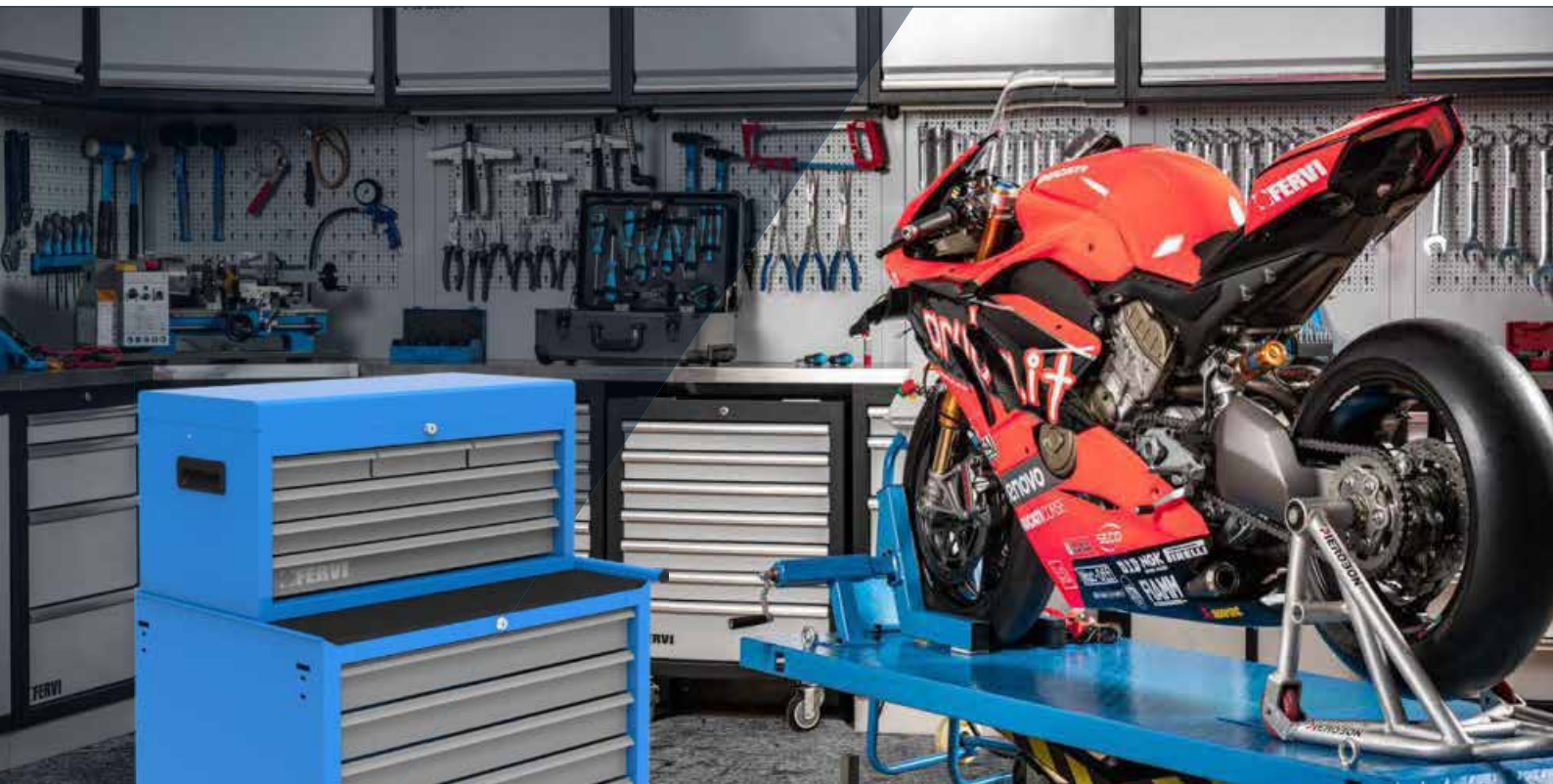

Art.	€	Dimensioni esterne	Dimensioni interne	Peso netto
0363	€ 1140,00	770 x 420 x 305h mm, 915 x 440 x 565h mm, 1220 x 620 x 700h mm	750 x 400 x 300h mm, 825 x 350 x 410h mm, 1130 x 520 x 550h mm	107 kg
0363/30	€ 208,00	770x420x305h mm	750 x 400 x 300h mm	14,5 kg
0363/36	€ 267,00	915 x 440 x 565h mm	825 x 350 x 410h mm	35 kg
0363/48	€ 753,00	1220 x 620 x 700h mm	1130 x 520 x 550h mm	57 kg

C900/B
€ 481,00
CARRELLO PORTA UTENSILI

Con maniglia laterale, protezione superiore in polipropilene espanso, 6 cassetti con guide telescopiche a sfera e tappetino interno anti-olio, serratura centralizzata frontale con 2 chiavi ripiegabili, 2 ruote fisse e 2 pivotanti con freno ad azionamento pedale in gomma termoplastica antiurto e antiscivolo.

UPGRADE

C900/A
€ 313,00
CASSETTA ATTREZZI

Utilizzabile in combinazione con le cassettiere, con maniglie laterali a scomparsa, 6 cassetti con guide telescopiche a sfera, vassoio portatile, e serratura centralizzata frontale con 2 chiavi ripiegabili.

UPGRADE

Dimensioni	661 x 309 x 363h mm
Dimensioni cassetto	3: 174 x 267 x 45h mm 2: 578 x 267 x 45h mm 1: 578 x 267 x 60h mm
Dimensioni del vano	655 x 250 x 80h mm
Portata cassetto	25 kg
Peso netto	20 kg

Dimensioni	744 x 461 x 964h mm
Dimensioni cassetto	569 x 406 mm
Altezza cassetti	4 x 70 mm - 1 x 145 mm - 1 x 225 mm
Portata cassetto	25 kg
Peso netto	44 kg

I DETTAGLI FANNO LA DIFFERENZA

Abbiamo pensato a soddisfare le vostre esigenze. Come? Curando i dettagli e la scelta degli optional installabili, rendendo la cassettiere lo strumento personale con il quale lavorare ogni giorno facilmente ed agevolmente.

Così sono nate le nuove cassettiere FERVI. Semplici e di facile composizione, grazie alla compatibilità degli accessori per le diverse tipologie di cassettiere disponibili. Puoi configurarla in base alle tue necessità e al tuo modo di lavorare.

Il nostro obiettivo è fornirti la TUA cassettiere, non una cassettiere qualunque!

C960/PF € 87,80 **NEW**
PANNELLO FORATO

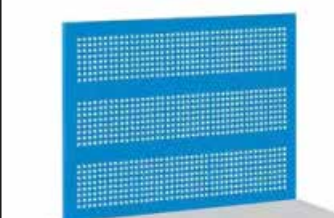

Dimensioni	678 x 535 x 25h mm
Dimensioni piano di lavoro	678 x 535 mm
Diametro foro	Ø 5 mm
Interasse fori	15 mm

C960/PL € 61,50 **NEW**
PIANO DI LAVORO IN LAMINATO



Dimensioni piano	670 x 454 mm
Spessore piano	9 mm

C960/MP € 31,80 **NEW**
MENSOLA PIEGHEVOLE



Dimensioni	338 x 261 x 35h mm
Spessore lamiera	1,50 mm



C960/PC € 16,50 **NEW**
PORTA CARTA PER ROTOLI



Dimensioni	386 x 167 mm
Diametro tubo	15 mm
Diametro max. rotolo	280 mm

C960/PD € 32,90 **NEW**
PORTA DOCUMENTI



Dimensioni interne	270 x 60 x 330h mm
Spessore lamiera	2 mm

C960/PG € 11,50 **NEW**
PORTA GIRAVITI



Dimensioni	330 x 76 x 88h mm
Dimensioni interne	328 x 75 x 75h mm
Diametro foro	8 x Ø 8,5 mm

**C960/F6**

€ 590,00

CARRELLO PORTA UTENSILI A 6 CASSETTI

Con maniglia laterale, piano in polipropilene espanso, corpo in lamiera d'acciaio con protezioni antiurto e pannelli laterali forati, 6 cassette a estrazione totale con guide telescopiche a sfera e tappetino anti-olio, funzione antiribaltamento, serratura centralizzata laterale con 2 chiavi ripiegabili, 2 ruote fisse e 2 pivotanti con freno. Accessori opzionali: porta-giraviti, porta-documenti, mensola, porta-rotolo, pannello forato posteriore e piano in laminato.

Dimensioni	770 x 460 x 985h mm
Dimensioni cassetto	566 x 405 mm
Altezza cassette	4 x 68 mm - 1 x 147 mm - 1 x 199 mm
Portata cassetto	5 x 25 kg - 1 x 40 kg
Interasse fori	15 mm
Diametro foro	Ø 5 mm
Peso netto	55 kg

**C960/F7**

€ 648,00

CARRELLO PORTA UTENSILI A 7 CASSETTI

Con maniglia laterale, piano in polipropilene espanso, corpo in lamiera d'acciaio con protezioni antiurto e pannelli laterali forati, 7 cassette a estrazione totale con guide telescopiche a sfera e tappetino anti-olio, funzione antiribaltamento, serratura centralizzata frontale con 2 chiavi ripiegabili, 2 ruote fisse e 2 pivotanti con freno. Accessori opzionali: porta-giraviti, porta-documenti, mensola, porta-rotolo, pannello forato posteriore e piano in laminato.

Dimensioni	770 x 460 x 985h mm
Dimensioni cassetto	566 x 405 mm
Altezza cassette	6 x 68 mm - 1 x 199 mm
Portata cassetto	6 x 25 kg - 1 x 40 kg
Interasse fori	15 mm
Diametro foro	Ø 5 mm
Peso netto	58 kg

**C960/F8**

€ 706,00

CARRELLO PORTA UTENSILI A 8 CASSETTI

Con maniglia laterale, piano in polipropilene espanso, corpo in lamiera d'acciaio con protezioni antiurto e pannelli laterali forati, 8 cassette a estrazione totale con guide telescopiche a sfera e tappetino anti-olio, funzione antiribaltamento, serratura centralizzata frontale con 2 chiavi ripiegabili, 2 ruote fisse e 2 pivotanti con freno. Accessori opzionali: porta-giraviti, porta-documenti, mensola, porta-rotolo, pannello forato posteriore e piano in laminato.

Dimensioni	770 x 460 x 985h mm
Dimensioni cassetto	566 x 405 mm
Altezza cassette	7 x 68 mm - 1 x 120 mm
Portata cassetto	25 kg
Interasse fori	15 mm
Diametro foro	Ø 5 mm
Peso netto	60 kg



C980
€ 1130,00
CARRELLO PORTA UTENSILI

A 7 cassetti, con due armadi laterali provvisti di 12 ganci e 10 contenitori portaminuteria estraibili, bloccaggio di sicurezza su ogni cassetto, guide su cuscinetti, serratura centrale, 2 ruote fisse e 2 girevoli.



Portata cassetto	25 kg
Dimensioni cassettiera	890 x 530 x 1030h mm
Dimensioni cassetto	565 x 405 mm
Altezza cassetti	3 x 50 mm - 3 x 105 mm - 1 x 165 mm
Peso netto	100 kg

0466/4V
€ 38,80
SERIE VASSOI MAGNETICI

In acciaio verniciato, per organizzare al meglio lo spazio di lavoro.

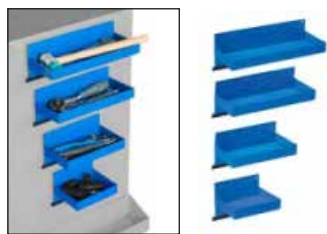

Dimensioni ingombro	310 x 130 x 120h mm; 270 x 130 x 120h mm; 210 x 130 x 120h mm; 150 x 130 x 120h mm
Capacità	1,17 kg; 1 kg; 0,77 kg; 0,6 kg
Spessore lamiera	0,7 mm

0466/CV
€ 16,20
VASSOIO MAGNETICO CON PORTA GIRAVITI

In acciaio verniciato, per organizzare al meglio lo spazio di lavoro.

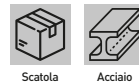

Dimensioni	360 x 130 x 110h mm
Dimensioni cassetto	305 x 115 x 30h mm
Fori	6 x Ø 10 mm
Capacità	3,18 kg
Spessore lamiera	1 mm

0466/PB
€ 9,30
PORTA BUSSOLE MAGNETICO

In acciaio verniciato, per organizzare al meglio lo spazio di lavoro.



Dimensioni ingombro	280 x 45 x 90h mm
Misure bussolte	1/4" - 3/8" - 1/2"
Spessore lamiera	0,9 mm

0466/SC
€ 18,40
SUPPORTO MAGNETICO PER 3 BOMBOLETTE SPRAY E 7 GIRAVITI

In acciaio verniciato, per organizzare al meglio lo spazio di lavoro.



Dimensioni ingombro	130 x 300 x 130h mm
Fori	3 x Ø 75 mm; 2 x Ø 12 mm; 1 x Ø 11 mm; 1 x Ø 10 mm; 1 x Ø 9 mm; 2 x Ø 7,5 mm
Capacità	1,19 kg
Spessore lamiera	0,8 mm



0323/45

€ 53,90

CASSETTA ATTREZZI

A 5 scomparti.



Acciaio

Dimensioni
Peso netto450 x 200 x 205 h mm
4 kg

0323/55

€ 61,10

CASSETTA ATTREZZI

A 5 scomparti.



Acciaio

Dimensioni
Peso netto550 x 210 x 205h mm
4,5 kg

0423/1

€ 36,00

VALIGETTA PORTAMINUTERIA

Con 16 contenitori plastici estraibili piccoli e 4 medi, con dimensioni rispettivamente di 54 x 52 x 43h mm e 54 x 105 x 43h mm. La valigetta, ideale per riporre minuteria, ha due chiusure di sicurezza per evitare il rovesciamento involontario della minuteria.



Acciaio

Plastic



Dimensioni

334 x 240 x 45 mm

0423/2

€ 42,50

VALIGETTA PORTAMINUTERIA

Con 29 contenitori plastici estraibili piccoli e 3 medi, con dimensioni rispettivamente di 54 x 52 x 43h mm e 54 x 105 x 43h mm. La valigetta, ideale per riporre minuteria, ha una chiusura di sicurezza centrale per evitare il rovesciamento involontario della minuteria.



Acciaio

Plastic



Dimensioni

388 x 295 x 45 mm

0422-

SERIE CONTENITORI BIVALVE

Pratiche per immagazzinare piccoli oggetti come viti, bulloni, dadi, gancetti, chiodi



20 Pcs

Plastic



Art.

€

Dimensioni

0422/B1 € 10,10
0422/B3 € 17,7065 x 47 x 30 mm
75 x 60 x 40 mm

C315

€ 14,50

VALIGETTA PORTA MINUTERIA

Con 21 scomparti e divisorie rimovibili, per poter immagazzinare oggetti più grandi dello scomparto originale.

Plastic



Dimensioni

380 x 310 x 60 mm

C313

€ 81,00

CASSETTIERA CON 4 VALIGETTE PORTA MINUTERIA

Cassettera modulare, con 13 vaschette estraibili di varie dimensioni dotata di incastri laterali per la sovrapposizione e fori posteriori per il fissaggio a muro.

Plastic



Dimensioni

377 x 265 x 310 mm

C360

€ 27,30

VALIGETTA PORTA MINUTERIA

Con 23 scomparti e 16 separatori rimovibili.



Scatola

Plastic



made in Italy



Dimensioni

443 x 317 x 80h mm

C371
€ 44,60
VALIGETTA PORTA MINUTERIA

Con 2 vaschette grandi, 3 vaschette medie, 6 vaschette piccole estraibili.

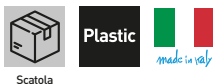

Dimensioni 443 x 317 x 107h mm

C163
€ 16,80
VALIGETTA PER UTENSILI

Lucchettabile, 16", con vaschetta mobile e 2 scomparti porta minuteria nel coperchio.

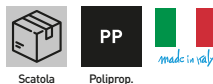

Dimensioni 394 x 160 x 195h mm

C165
€ 31,80
VALIGETTA PER UTENSILI

20" con vaschetta mobile e 2 scomparti porta minuteria nel coperchio.

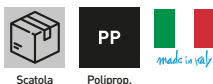

Dimensioni 514 x 225 x 260h mm

C648
€ 61,70
VALIGETTA PER UTENSILI

Con vaschetta mobile.



Dimensioni 510 x 280 x 220h mm

M13x
VALIGIA RESISTENTE ALL'ACQUA

Valigia porta strumenti a tenuta stagna, con valvola di depressurizzazione, interno personalizzabile con spugna pretagliata a cubetti per alloggiare qualsiasi tipo di strumento.



Art.	€	Dimensioni esterne	Dimensioni interne	Peso netto
M138	€ 73,30	465 x 360 x 175h mm	425 x 287 x 115h mm	2,9 kg
M139	€ 101,00	570 x 410 x 215h mm	505 x 353 x 140h mm	4,5 kg

M138

M139

M300/B
€ 98,30
VALIGIA RESISTENTE ALL'ACQUA

Con valvola di depressurizzazione, interno personalizzabile con spugna pretagliata a cubetti per alloggiare qualsiasi tipo di oggetto. La sua superiore resistenza agli urti, acqua e polvere la rende adatta a vari settori di utilizzo ed applicazioni.

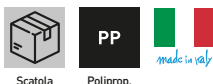

Dimensioni esterne	336 x 300 x 148 mm	Temperatura di esercizio	-30 / 90°C (-22 / 194°F)
Dimensioni interne	300 x 225 x 132 mm	Peso netto	1,6 kg
Volume interno	8.91 l		

M430/B
€ 133,00
VALIGIA RESISTENTE ALL'ACQUA

Con valvola di depressurizzazione, interno personalizzabile con spugna pretagliata a cubetti per alloggiare qualsiasi tipo di oggetto. La sua superiore resistenza agli urti, acqua e polvere la rende adatta a vari settori di utilizzo ed applicazioni.

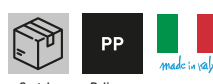

Dimensioni esterne	464 x 366 x 176 mm	Temperatura di esercizio	-30 / 90°C (-22 / 194°F)
Dimensioni interne	426 x 290 x 159 mm	Peso netto	2,8 kg
Volume interno	19.64 l		

**M505/B**

€ 203,00

VALIGIA RESISTENTE ALL'ACQUA

Con valvola di depressurizzazione, interno personalizzabile con spugna pretagliata a cubetti per alloggiare qualsiasi tipo di oggetto. La sua superiore resistenza agli urti, acqua e polvere la rende adatta a vari settori di utilizzo ed applicazioni.



Scatola

PP

Poliprop.



made in italy

Dimensioni esterne	555 x 428 x 211 mm
Dimensioni interne	500 x 350 x 194 mm
Volume interno	33.95 l
Temperatura di esercizio	-30 / 90°C (-22 / 194°F)
Peso netto	3,9 kg

M540/BT

€ 330,00

VALIGIA RESISTENTE ALL'ACQUA CON TROLLEY

Con valvola di depressurizzazione, interno personalizzabile con spugna pretagliata a cubetti per alloggiare qualsiasi tipo di oggetto. La sua superiore resistenza agli urti, acqua e polvere la rende adatta a vari settori di utilizzo ed applicazioni.



Scatola

PP

Poliprop.



made in italy

Dimensioni esterne	594 x 473 x 270 mm
Dimensioni interne	538 x 405 x 245 mm
Volume interno	53.38 l
Temperatura di esercizio	-30 / 90°C (-22 / 194°F)
Peso netto	5,2 kg

0682

€ 108,00

VALIGIA PORTA UTENSILI IN ABS

Utensili non inclusi.



Scatola

ABS

A	460 mm
B	330 mm
C	150 mm
D	98 mm
E	52 mm
Portata	25 kg
Peso netto	2,9 kg

0683

€ 184,00

VALIGIA PORTA UTENSILI IN ABS CON CARRELLO

Utensili non inclusi.



Scatola

ABS

A	460 mm
B	330 mm
C	190 mm
D	98 mm
E	92 mm
Portata	25 kg
Peso netto	4,5 kg

068x**VALIGIA PORTA UTENSILI IN ALLUMINIO**

Utensili non inclusi.

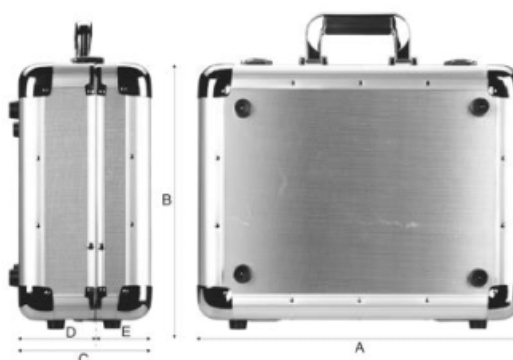

Art.	€	A	B	C	D	E	Portata	Peso netto
0680	€ 150,00	510 mm	375 mm	185 mm	110 mm	75 mm	30 kg	5 kg
0681	€ 129,00	440 mm	390 mm	185 mm	110 mm	75 mm	30 kg	4,8 kg

0901
€ 49,00 NEW
ZAINO MULTIFUNZIONE

Realizzato in poliestere 600 denari, con schienale traspirante, portautensili estraibile, tasca porta computer imbottita, tasche capienti e robuste per alloggiare un gran numero di utensili.



Poliestere

Dimensioni esterne

380 x 130 x 460 mm

Peso netto

1,25 kg

0907
€ 86,00 NEW
TROLLEY PORTAUTENSILI SEMI MORBIDO

Trolley portautensili in poliestere 600 denari, robusto manico telescopico per una ottima movimentazione, comoda apertura frontale a strappo, molteplici tasche capienti e robuste.



Poliestere

Dimensioni

390 x 290 x 390 mm

Peso netto

3,1 Kg

0902
€ 23,00 NEW
BORSA PORTAUTENSILI MORBIDA

Realizzata in poliestere 600 denari, con comoda tracolla, tasche capienti e robuste per alloggiare un gran numero di utensili.



Poliestere

Dimensioni

370 x 203 x 254 mm

Peso netto

1,25 Kg

0903
€ 26,00 NEW
BORSA PORTAUTENSILI MORBIDA

Realizzata in poliestere 600 denari, con comoda tracolla, tasche capienti e robuste per alloggiare un gran numero di utensili.



Poliestere

Dimensioni

450 x 280 x 220 mm

Peso netto

2,05 Kg

0904
€ 21,00 NEW
BORSA PORTAUTENSILI SEMI MORBIDA

Realizzata in poliestere 600 denari, con manico rigido per una facile movimentazione, comoda tracolla, tasche capienti e robuste.



Poliestere

Dimensioni

406 x 203x 254 mm

Peso netto

1,3 Kg

**0905**€ 25,00 **NEW****BORSA PORTAUTENSILI SEMI MORBIDA**

Realizzata in poliestere 600 denari, con manico rigido per una facile movimentazione, comoda tracolla, tasche capienti e robuste.



Poliestere

Dimensioni

450 x 228 x 280 mm

Peso netto

2,3 Kg

0906€ 38,00 **NEW****BORSA PORTAUTENSILI SEMI MORBIDA**

Realizzata in poliestere 600 denari, con manico rigido per una facile movimentazione, comoda tracolla, tasche capienti e robuste.



Poliestere

Dimensioni

450 x 228 x 330 mm

Peso netto

1,6 Kg

0390

€ 50,10

BORSA PORTA UTENSILI

Con tracolla in poliestere 1680 denari, tasche capienti e robuste per alloggiare un gran numero di utensili.



Poliestere

Tasche

14

Dimensioni

400 x 225 x 250h mm

0409

€ 13,00

BORSA PORTA UTENSILI

A 10 tasche con cintura, costruita in poliestere. Si può usare per contenere piccoli tester, pinze, forbici, cacciaviti e utensili vari.



Poliestere

Dimensioni

250 x 210 x 70 mm

0254

€ 9,60

BORSA INSTALLATORE

In pelle con cintura.



Tasche

5

0264

€ 19,40

BORSA INSTALLATORE

In pelle con cintura.



Tasche

11

0036-
MORSA IN ACCIAIO

Regolazione laterale dello scorrimento.



Scatola Acciaio

Art.	€	Ganasce	Apertura	Altezza utile	Interasse fori	Peso netto
0036/100	€ 125,00	100 mm	105 mm	60 mm	85 mm	4,9 kg
0036/125	€ 185,00	125 mm	138 mm	75 mm	110 mm	9,5 kg
0036/150	€ 313,00	150 mm	180 mm	90 mm	150 mm	19 kg

0036-xG
MORSA GIREVOLE IN ACCIAIO

Regolazione laterale dello scorrimento. Dotata di base girevole.



Scatola Acciaio

Art.	€	Ganasce	Apertura	Peso netto
0036/100G	€ 147,00	100 mm	105 mm	5,5 kg
0036/125G	€ 202,00	125 mm	124 mm	11 kg
0036/150G	€ 347,00	150 mm	180 mm	22 kg

0135-
MORSA IN ACCIAIO FORGIATA

Regolazione laterale dello scorrimento.



Scatola Acciaio

Art.	€	Ganasce	Apertura	Altezza utile	Interasse fori	Peso netto
0135/100	€ 134,00	100 mm	125 mm	60 mm	98 mm	5,8 kg
0135/125	€ 190,00	125 mm	160 mm	70 mm	111 mm	9,8 kg
0135/150	€ 302,00	150 mm	190 mm	85 mm	136 mm	17,8 kg

0140-
MORSA IN ACCIAIO

Regolazione laterale dello scorrimento. Dotata di stringitubo. Consigliata per utilizzi gravosi.



Scatola Acciaio

Art.	€	Ganasce	Apertura	Altezza utile	Interasse fori	Peso netto
0140/080	€ 50,30	80 mm	80 mm	60 mm	80 mm	4 kg
0140/100	€ 58,70	100 mm	100 mm	65 mm	80 mm	5,5 kg
0140/125	€ 86,70	125 mm	125 mm	90 mm	100 mm	10 kg
0140/150	€ 109,00	150 mm	150 mm	95 mm	125 mm	14 kg

0591-
MORSA IN ACCIAIO

Regolazione laterale dello scorrimento. Dotata di cuscinetto sulla vite, stringitubo e ganasce intercambiabili.



Scatola Acciaio

Art.	€	Ganasce	Apertura	Peso netto
0591/100	€ 166,00	100 mm	95 mm	5,3 kg
0591/125	€ 234,00	125 mm	130 mm	11 kg

0145-
MORSA IN ACCIAIO

Dotata di stringitubo.



Scatola Acciaio

Art.	€	Ganasce	Apertura	Altezza utile	Interasse fori	Peso netto
0145/80	€ 42,50	80 x 20 mm	80 mm	58 mm	80 mm	3,7 kg
0145/100	€ 47,20	100 x 20 mm	100 mm	70 mm	80 mm	5,2 kg
0145/125	€ 62,80	125 x 20 mm	125 mm	75 mm	100 mm	7,4 kg
0145/150	€ 102,00	150 x 27 mm	150 mm	95 mm	120 mm	12 kg

0174-
MORSA DA BANCO IN GHISA SFEROIDALE

Dotata di ganasce intercambiabili.



Scatola Ghisa

Art.	€	Ganasce	Apertura	Altezza utile	Interasse fori	Peso netto
0174/100	€ 67,00	100 x 20 mm	100 mm	50 mm	85 mm	4,8 kg
0174/125	€ 83,60	125 x 22 mm	130 mm	60 mm	95 mm	7,7 kg
0174/150	€ 105,00	150 x 22 mm	150 mm	60 mm	105 mm	10 kg

0427-
MORSA PARALLELA DA BANCO IN GHISA SFEROIDALE

Si attacca direttamente al bordo del banco di lavoro per garantire un'elevata stabilità. Dotata di ganasce intercambiabili e guide prismatiche.



Scatola Ghisa

Art.	€	Ganasce	Apertura	Peso netto
0427/080	€ 78,30	80 mm	80 mm	6,5 kg
0427/100	€ 101,00	100 mm	100 mm	10 kg
0427/125	€ 134,00	135 mm	125 mm	12 kg

0146/60 € 27,70

MORSA GIREVOLE CON MORSETTO



Ghisa

Ganasce	60 mm
Apertura	60 mm
Capacità morsetto	51 mm
Peso netto	1,5 kg

0520-xG

COPPIA DI COPRIGANASCE MAGNETICHE IN ALLUMINIO RIVESTITE IN GOMMA

Con gomma resistente.



2 Pcs



Blister



Alu

Alluminio

Art.	€	Lunghezza	Altezza	Spessore
0520/100G	€ 15,50	100 mm	28,7 mm	10,0 mm
0520/125G	€ 17,60	125 mm	28,7 mm	10,0 mm
0520/150G	€ 19,50	150 mm	28,7 mm	10,0 mm

0520-xP

COPPIA DI COPRIGANASCE PRISMATICHE MAGNETICHE

Con ganasce trapezoidali.



2 Pcs



Blister



Alu

Alluminio

Art.	€	Lunghezza	Altezza	Spessore
0520/100P	€ 15,50	100 mm	28,5 mm	9,8 mm
0520/125P	€ 17,60	125 mm	28,5 mm	9,8 mm
0520/150P	€ 19,50	150 mm	28,5 mm	9,8 mm

0520-xS

SERIE DI COPPIE DI COPRIGANASCE MAGNETICHE IN ALLUMINIO

Comprende gli articoli 0520-xA, 0520-xF, 0520-xG, 0520-xP.



8 Pcs



Blister



Alu

Alluminio

Art.	€	Lunghezza
0520/100S	€ 46,40	100 mm
0520/125S	€ 52,70	125 mm
0520/150S	€ 58,70	150 mm

0042-

COPPIA DI COPRIGANASCE MAGNETICHE IN ALLUMINIO

Rigate con scanalature.



2 Pcs



Alu

Alluminio

Art.	€	Ganasce	Altezza	Spessore
0042/100	€ 13,90	100 mm	28 mm	7.5 mm
0042/125	€ 21,50	125 mm	28.5 mm	7.5 mm
0042/150	€ 22,10	150 mm	28.5 mm	7.5 mm

0520-xA

COPPIA DI COPRIGANASCE MAGNETICHE IN ALLUMINIO

Rigate con scanalature.



2 Pcs



Blister



Alu

Alluminio

Art.	€	Lunghezza	Altezza	Spessore
0520/100A	€ 15,50	100 mm	28,3 mm	8,9 mm
0520/125A	€ 17,60	125 mm	28,3 mm	8,9 mm
0520/150A	€ 19,50	150 mm	28,3 mm	8,9 mm

0520-xF

COPPIA DI COPRIGANASCE MAGNETICHE RIVESTITE IN FIBRA

Con fibra resistente.



2 Pcs



Blister



Alu

Alluminio

Art.	€	Lunghezza	Altezza	Spessore
0520/100F	€ 15,50	100 mm	28,7 mm	10,3 mm
0520/125F	€ 17,60	125 mm	28,7 mm	10,3 mm
0520/150F	€ 19,50	150 mm	28,7 mm	10,3 mm



0205
€ 34,30
MORSA PER SALDARE PROFILATI A 90°

Ganascia regolabile.

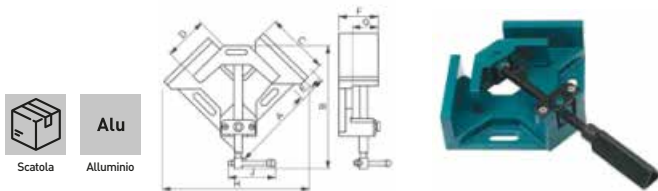
 Scatola
Alu
 Alluminio

Capacità	70 mm + 70 mm
Altezza utile	35 mm
A	150 mm
B	Min 250 mm - Max 345 mm
C	97 mm
D	60 mm
E	70 mm
F	55 mm
G	49 mm
H	217 mm
J	92 mm

0205/120
€ 119,00
MORSA PER SALDARE PROFILATI A 90°

Ganascia regolabile.

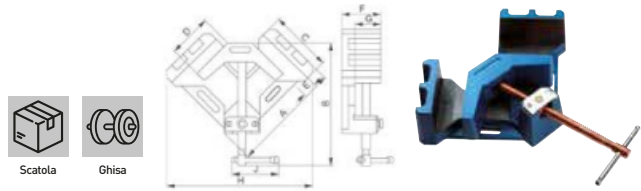
 Scatola
Ghisa

Capacità	110 mm + 110 mm
Altezza utile	60 mm
A	257 mm
B	Min 290 mm - Max 458 mm
C	135 mm
D	109 mm
E	126 mm
F	90 mm
G	77 mm
H	340 mm
J	112 mm

M006-
MORSETTO IN ACCIAIO TEMPERATO PER MECCANICA

 Acciaio
 Temprato

Art.	€	Apertura x Profondità	Stelo	Forza massima
M006/200	€ 29,90	200 x 120 mm	22 x 10,5 mm	550 kg
M006/300	€ 41,80	300 x 140 mm	25 x 12 mm	600 kg
M006/400	€ 42,40	420 x 120 mm	25 x 12 mm	650 kg
M006/500	€ 47,10	500 x 120 mm	25 x 12 mm	650 kg
M006/600	€ 67,60	600 x 120 mm	25 x 12 mm	650 kg
M006/800	€ 81,20	800 x 120 mm	25 x 12 mm	650 kg
M006/1000	€ 96,50	1000 x 120 mm	25 x 12 mm	650 kg

M007-
MORSETTO IN ACCIAIO TEMPERATO PER MECCANICA

A serraggio rapido.

 Acciaio
 Temprato

Art.	€	Apertura x Profondità	Stelo
M007/250	€ 58,50	250 x 120 mm	22 x 10,5 mm
M007/300	€ 67,60	300 x 140 mm	25 x 12 mm
M007/400	€ 73,70	400 x 120 mm	25 x 12 mm
M007/500	€ 79,40	500 x 120 mm	25 x 12 mm
M007/600	€ 88,40	600 x 120 mm	25 x 12 mm

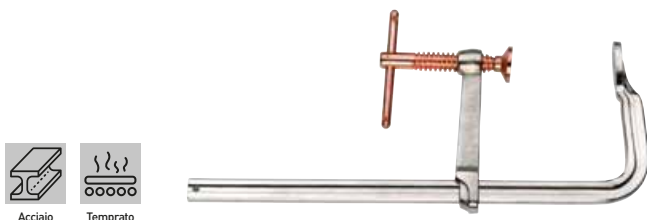
M018-
MORSETTO IN ACCIAIO TEMPERATO PER MECCANICA E FALEGNAMERIA

 Acciaio
 Temprato

Art.	€	Apertura x Profondità	Stelo
M018/0200	€ 22,40	200 x 100 mm	19 x 9,5 mm
M018/0300	€ 26,90	300 x 100 mm	19 x 9,5 mm
M018/0400	€ 30,60	400 x 120 mm	21,5 x 10,5 mm
M018/0500	€ 33,60	500 x 120 mm	21,5 x 10,5 mm
M018/0600	€ 33,60	600 x 120 mm	21,5 x 10,5 mm
M018/0800	€ 39,10	800 x 120 mm	21,5 x 10,5 mm
M018/1000	€ 44,70	1000 x 120 mm	21,5 x 10,5 mm
M018/1200	€ 50,30	1200 x 120 mm	21,5 x 10,5 mm

0167-
MORSETTO PER FALEGNAME

Alu
 Alluminio

Art.	€	Apertura x Profondità
0167/150	€ 3,75	150 x 50 mm
0167/200	€ 7,00	200 x 80 mm
0167/250	€ 7,80	250 x 100 mm
0167/400	€ 10,60	400 x 100 mm
0167/500	€ 13,40	500 x 120 mm

0394-

MORSETTO RAPIDO AUTOMATICO



ABS

Art.	€	Apertura x Profondità	Stelo	Forza massima
0394/150	€ 8,30	150 x 63 mm	18 x 5,5 mm	60 kg
0394/300	€ 11,20	300 x 63 mm	18 x 5,5 mm	60 kg
0394/450	€ 13,00	450 x 63 mm	18 x 5,5 mm	60 kg
0394/600	€ 15,70	600 x 63 mm	18 x 5,5 mm	60 kg

0353/085

€ 7,70

SERIE MORSETTI A MOLLA IN POLIPROPILENE

Con lunghezza di 85 mm, utili in laboratorio per facilitare gli incollaggi e lavori simili.



12 Pcs
Appendibile
Poliprop.

Lunghezza	85 mm
Apertura	35 mm

035x

MORSETTO A MOLLA

Utili in laboratorio per facilitare gli incollaggi e lavori simili.



Appendibile
Nylon

Art.	€	Lunghezza	Apertura
0353/150	€ 3,61	150 mm	55 mm
0354/225	€ 4,96	225 mm	100 mm

0250

€ 48,10

MORSETTO 4 DIREZIONI

Fornito in kit di montaggio, per porte o tavoli in legno (listelli di legno non inclusi).



Scatola
Plastic

Spessore max	150 mm
--------------	--------

0353/110

€ 8,20

SERIE MORSETTI A MOLLA IN POLIPROPILENE

Con lunghezza di 110 mm, utili in laboratorio per facilitare gli incollaggi e lavori simili.



8 Pcs
Appendibile
Poliprop.

Lunghezza	110 mm
Apertura	40 mm

0265/05

€ 38,40

INCUDINE IN GHISA

Struttura robusta, foro rotondo e foro quadrato per punzonatura e piegatura

Scatola
Ghisa

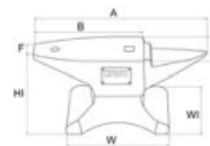

A	230 mm	WI	85 mm
B	160 mm	HI	95 mm
E	57 mm	Tolleranza	±5%
F	10,5 mm	Peso netto	5 kg
W	112 mm		

0157-

INCUDINI IN ACCIAIO INDURITO

Struttura robusta, foro rotondo e foro quadrato per punzonatura e piegatura.

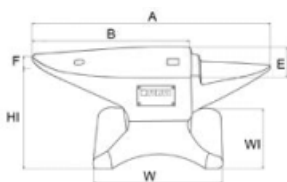

Scatola
C50



Art.	€	A	B	E	W	WI	HI	Tolleranza	Peso netto
0157/10	€ 123,00	345 mm	235 mm	80 mm	150 mm	100 mm	120 mm	±5%	10 kg
0157/30	€ 295,00	535 mm	360 mm	110 mm	215 mm	150 mm	160 mm	±5%	30 kg
0157/50	€ 430,00	620 mm	410 mm	140 mm	240 mm	175 mm	190 mm	±5%	50 kg
0157/100	€ 899,00	805 mm	520 mm	175 mm	315 mm	230 mm	240 mm	±5%	100 kg

COS'E' LA SABBIATURA?

La sabbiatura è un processo industriale di pulizia delle superfici che avviene attraverso la forza meccanica del materiale abrasivo spinto da un getto d'aria. La sabbia agisce per scalfittura e penetrazione: il materiale abrasivo si miscela al getto d'aria compressa e lavora meccanicamente sul pezzo. Questa miscela passando attraverso l'ugello, accelera portando la sua velocità ad un livello utile per effettuare l'azione abrasiva richiesta.



Sabbiatura per sverniciatura



Operazione di sabbiatura con sfere di vetro (pallinatura)

TIPI DI SABBIATRICI

Sono disponibili 2 tipologie di macchine da sabbiatura: cabina di sabbiatura a depressione e cabina di sabbiatura a pressione. Ognuna ha caratteristiche diverse in base all'impiego necessario all'utilizzatore finale. Le sabbiatrici sono dotate di ugelli intercambiabili per adattarli meglio al materiale da trattare: su materiali tenero è consigliato scegliere un ugello di grandi dimensioni che permette di avere un'elevata portata di miscela abrasivo/aria ad una bassa velocità, mentre per materiali duri o pezzi molto spessi è consigliato un ugello piccolo che permette di avere velocità della miscela più elevata ad una portata inferiore.



CABINA DI SABBIATURA A DEPRESSIONE

Ideale per oggetti metallici da sabbiare di piccole/medie dimensioni. Sfrutta il "principio Venturi" che permette alla sabbia di essere aspirata da un contenitore e miscelata ad aria compressa.

- PRO**
- Consumo minore di aria
 - Usura minore dell'abrasivo
 - Manutenzione contenuta

- CONTRO**
- Resa di lavorazione minore
 - Tempi di lavorazione più lunghi



CABINA DI SABBIATURA A PRESSIONE

A differenza del sistema a depressione, la cabina a pressione spinge verso il basso l'aria e l'abrasivo, proiettando la miscela di questi componenti in un'unica soluzione. Il getto risulta così più potente e più efficace.

- PRO**
- Alta resa di lavorazione
 - Tempi di lavorazione ridotti
 - Possibilità regolazione miscela aria/abrasivo

- CONTRO**
- Consumo maggiore di aria
 - Maggiore manutenzione
 - Usura maggiore dell'abrasivo dato dalla maggiore potenza del getto

COME SCEGLIERE L'ABRASIVO

La scelta dell'abrasivo per sabbiatrici è frequentemente dettata da esperienza e facilità di utilizzo. La sabbiatura con macchine manuali è infatti un processo contraddistinto da tante variabili in gioco e per riuscire ad avere un risultato ottimale si deve cercare di trovare un giusto bilanciamento. Di seguito vi indichiamo 5 buone regole per la scelta ottimale della tipologia di abrasivo:

1) Utilizza sempre l'abrasivo meno aggressivo possibile in grado di effettuare il lavoro richiesto. Non ha senso utilizzare un abrasivo molto aggressivo per poi dover fare un ulteriore processo di finitura. Puoi sempre aggiungere un abrasivo più duro, ma è molto più faticoso annullare il lavoro di un abrasivo troppo duro.	
2) Il vetro è lucido, ma fa brillare anche le superfici: se hai bisogno di un aspetto lucido, le microsfele di vetro sono un ottimo punto di partenza. Sono una finitura fantastica e lasceranno le superfici lisce e luminose.	
3) Il corindone rimuove la vernice: è necessario rimuovere la vernice da un oggetto? Con la sua struttura dura e angolare e la riutilizzabilità, il corindone è l'abrasivo giusto. In alternativa è possibile utilizzare il Garnet, un abrasivo naturale ed ecologico e più economico.	
4) Per un lavoro rapido e aggressivo, usa il carburo di silicio. È l'abrasivo più tenace sul mercato. Fa un rapido lavoro di incisione e rimozione di ruggine e vernice indesiderate.	
5) Le microsfele di acciaio sono adatte per la pallinatura e la lucidatura e per la rimozione della vernice. Valutare attentamente perché questo tipo di abrasivo a contatto con l'oggetto da lavorare modifica la struttura meccanica dello stesso. Questo tipo di abrasivo è idoneo per sabbiatrici industriali.	

SABBIATRICI



Dimensioni interne (mm)

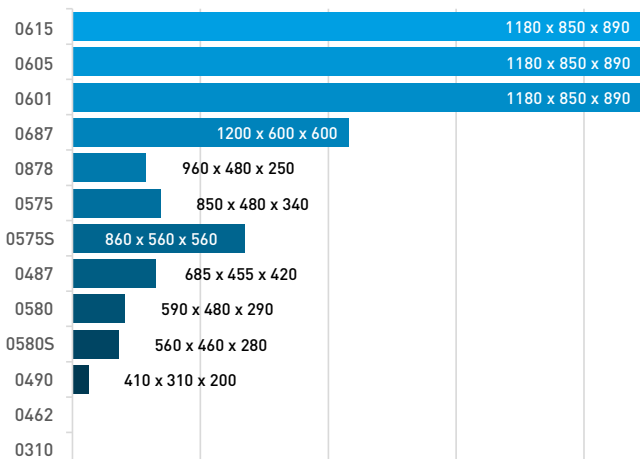

Consumo d'aria teorico (l/min)

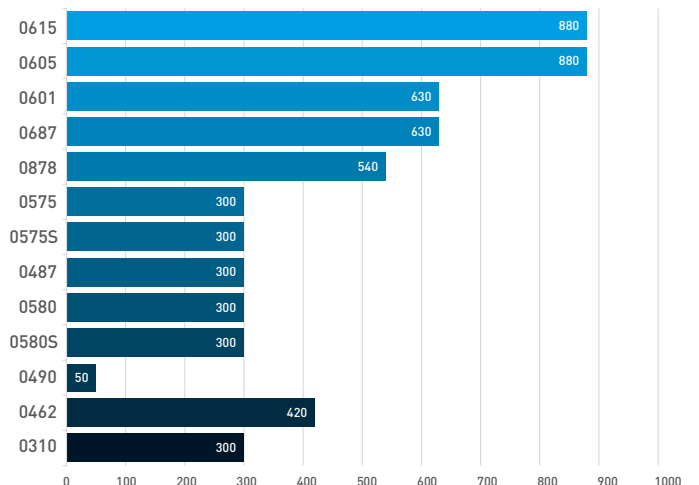

0615
€ 4730,00
SABBIATRICE A PRESSIONE

Con separatore polveri, filtro in HEPA, apertura frontale e plafoniera con 3 lampade fluorescenti.



Dimensioni interne	1180 x 850 x 890 h mm
Portata max	150 kg
Pressione di esercizio	6 ÷ 8 Bar
Consumo aria	31 SCFM 880 l / min
Ugelli pistola	Ø 6 - 7 mm

Aspiratore elettrico	230 V 50 Hz 0.7 kW
Capacità filtrante	8 micron
Dotata di illuminazione	Sì
Dimensioni ingombro	1330 x 1515 x 2070 h mm
Peso netto	300 kg

0605
€ 4180,00
SABBIATRICE A PRESSIONE CON 2 ASPIRATORI

Con serbatoio in pressione per aver un maggior effetto abrasivo, doppio aspiratore a ciclone, filtro in carta, apertura frontale e plafoniera con 3 lampade fluorescenti.

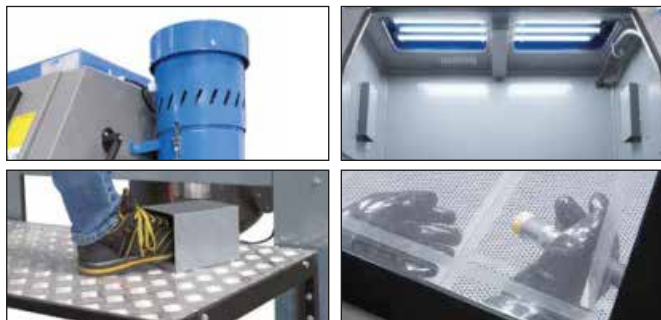

Dimensioni utili interne	1180 x 850 x 890 h mm
Portata max	150 kg
Pressione di esercizio	6 ÷ 8 Bar
Consumo aria	31 SCFM 880 l / min
Ugelli pistola	Ø 6 - 7 mm

Aspiratore elettrico	2 x 230 V 50 Hz 1.2 kW
Capacità filtrante	5 micron
Dotata di illuminazione	Sì
Dimensioni ingombro	1800 x 1515 x 2070 h mm
Peso netto	245 kg

0601
€ 3420,00
SABBIATRICE CON ASPIRATORE

A ciclone, filtro in carta, apertura frontale e plafoniera con 3 lampade fluorescenti.



Dimensioni utili interne	1180 x 850 x 890h mm
Portata max	150 kg
Pressione di esercizio	6 ÷ 8 Bar
Consumo aria	21 SCFM 630 l / min
Ugelli pistola	Ø 6 - 7 mm

Aspiratore elettrico	230 V 50 Hz 1.2 kW
Capacità filtrante	5 micron
Dotata di illuminazione	Sì
Dimensioni ingombro	1330 x 1240 x 1770 h mm
Peso netto	180 kg

0687

€ 2440,00

SABBIATRICE CON ASPIRATORE

Con filtro in carta.



Dimensioni utili interne	1200 x 600 x 600 h mm
Portata max	120 kg
Pressione di esercizio	6.5 ÷ 7.5 Bar
Consumo aria	21 SCFM 630 l / min
Ugelli pistola	Ø 6 - 7 mm
Aspiratore elettrico	230 V 50 Hz 1.2 kW
Capacità filtrante	5 micron
Dimensioni ingombro	1220 x 910 x 1740 h mm
Peso netto	149 kg

0878

€ 1940,00

SABBIATRICE CON ASPIRATORE

Con filtro in carta.

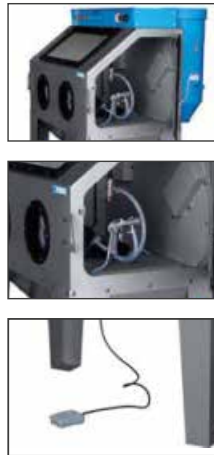

Dimensioni utili interne	960 x 480 x 250 ÷ 470 h mm
Pressione di esercizio	6.5 ÷ 7.5 bar
Consumo aria	18 SCFM 540 l / min
Ugelli pistola	Ø 4 - 5 - 6 - 7 mm
Aspiratore elettrico	230 V 50 Hz 1.2 kW
Capacità filtrante	5 micron
Dimensioni ingombro	1030 x 850 x 1640 h mm
Peso netto	100 kg

0575

€ 816,00

SABBIATRICE



Dimensioni utili interne	850 x 480 x 340 ÷ 540 h mm
Pressione di esercizio	6.5 ÷ 7.5 Bar
Consumo aria	8 ÷ 10 SCFM (240 ÷ 300 l / min)
Ugelli pistola	Ø 4 - 5 - 6 - 7 mm
Dimensioni ingombro	890 x 560 x 1385 h mm
Peso netto	46 kg

0575S

€ 757,00

SABBIATRICE

Fornita smontata.



Dimensioni utili interne	860 x 560 x 560 h mm
Pressione di esercizio	6.5 ÷ 7.5 bar
Consumo aria	8 ÷ 10 SCFM (240 ÷ 300 l / min)
Ugelli pistola	Ø 4 - 5 - 6 - 7 mm
Dimensioni ingombro	905 x 620 x 1390 h mm
Peso netto	44 kg

0487
€ 334,00
SABBIATRICE DA BANCO

Con predisposizione per il collegamento di un'aspirapolvere, illuminazione con lampada basso consumo, pistola e guanti.



Dimensioni utili interne	685 x 455 x 420 h mm
Pressione di esercizio	6,5 ÷ 7,5 Bar
Consumo aria	8 ÷ 10 SCFM (240 ÷ 300 l / min)
Ugelli pistola	Ø 4 - 5 - 6 - 7 mm
Dotata di illuminazione	230 V 50 Hz; 6 W 12 V
Dimensioni ingombro	755 x 495 x 720 h mm
Peso netto	26,5 kg

0580
€ 316,00
SABBIATRICE DA BANCO

Con predisposizione per il collegamento di un'aspiratore, illuminazione con lampada a basso consumo, pistola e guanti.



Dimensioni ingombro	630 x 510 x 490 h mm
Dimensioni utili interne	590 x 480 x 290 h mm
Pressione di esercizio	6,5 ÷ 7,5 Bar
Consumo aria	8 ÷ 10 SCFM (240 ÷ 300 l / min)
Ugelli pistola	Ø 4 - 5 - 6 - 7 mm
Peso netto	13 kg

0580S
€ 281,00
SABBIATRICE DA BANCO

Fornita smontata.



Dimensioni ingombro	585 x 485 x 495 h mm
Dimensioni utili interne	560 x 460 x 280 h mm
Pressione di esercizio	6,5 ÷ 7,5 Bar
Consumo aria	8 ÷ 10 SCFM (240 ÷ 300 l / min)
Ugelli pistola	Ø 4 - 5 - 6 - 7 mm
Peso netto	16 kg

0490
€ 476,00
MINI SABBIATRICE DA BANCO

Con comando a pedale e pistola fissa, per sabbiare parti piccole nel settore orafa, odontoiatrico e fai da te.



Dimensioni utili interne	410 x 310 x 200 h mm
Pressione di esercizio	4 - 7,5 bar
Ugelli pistola	Ø 3,5 mm
Dotata di illuminazione	50 Hz, 6 W 12 V
Dimensioni ingombro	475 x 370 x 370 h mm
Peso netto	12 kg
Volume interno	32 L
Dimensioni apertura	420 x 260 mm

0462
€ 869,00
SABBIATRICE PER ESTERNO CON ASPIRATORE

Per oggetti metallici arrugginiti o da sverniciare che non possono essere inseriti in una sabbiatrice tradizionale, se l'oggetto da trattare è piano. L'aspiratore consente di non perdere la maggior parte di abrasivo che si sta usando. Le quattro ruote permettono all'operatore di portare la macchina vicino all'oggetto da sabbicare.

Lunghezza tubi	2.5 m
Motore	230 V 50 Hz 1.2 kW
Capacità di aspirazione	13 ÷ 15 kPa
Pressione di esercizio	8 Bar
Consumo aria	420 l / min
Dimensioni	404 x 612 x 1046 h mm
Peso netto	30 kg

0310
€ 221,00
SABBIATRICE A BICARBONATO DI SODIO

Per uso esterno, leggera, facile da trasportare, indicata per la rimozione di vernici, ruggine, graffiti ecc...

Dimensioni ingombro	350 x 400 x 788 h mm
Capacità	18 l
Pressione di esercizio	2.5 ÷ 6.2 bar
Consumo aria	8 ÷ 10 SCFM (240 ÷ 300 l / min)
Ugelli pistola	Ø 2 - 3 mm
Peso netto	13 kg

SA01-CTRx
TAVOLA GIREVOLE PER SABBIATRICE

Con carrello.



Art.	€	Portata	Diametro	Dimensioni ingombro	Peso netto
SA01/CTR1	€ 564,00	150 kg	580 mm	920 x 580 x 1070h mm	43,5 kg
SA01/CTR2	€ 564,00	150 kg	580 mm	920 x 580 x 1335h mm	45 kg

SA01/TR
€ 124,00
TAVOLA GIREVOLE

Per sabbiatrici.

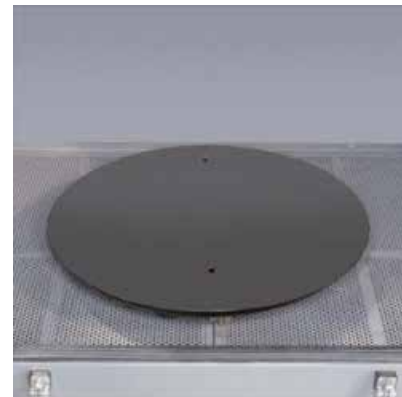

Diametro	380 mm
Dimensioni ingombro	380 x 43h mm
Peso netto	7 kg

SA01/C
€ 1240,00
CICLONE PER SABBIATRICI

A due stadi.



Capacità filtrante	8 micron
Portata d'aria	13500 l/min
Potenza massima	230 V 50 Hz 0,55 kW
Dimensioni ingombro	540 x 1000 x 1450h mm
Peso netto	55 kg

SA01/A
€ 390,00
ASPIRATORE PER SABBIATRICI

Cilindrico con filtro in carta, con batti filtro manuale e apertura nella parte inferiore.



Aspiratore elettrico	230 V 50 Hz 1,2 kW
Capacità filtrante	5 micron
Permeabilità all'aria	185 l/(m²s)
Diametro aspirazione	Ø 55 mm
Interasse fori	305 X 240 mm
Dimensioni	Ø 290 X 730 mm

0582-
CORINDONE

Si distingue per essere spigoloso ed estremamente stabile combinando le proprietà di durezza e densità. La sua longevità e riutilizzabilità lo rendono il materiale più usato per la sabbiatura. Essendo composto per la maggior parte da ossido di alluminio è praticamente privo di ferro. Particolarmente indicato per la pulitura di superfici metalliche, rimozione di ruggine e strati di ossido e rimozione di colori di rinvenimento.



Art.	€	Grana	Durezza	Peso netto
0582/36	€ 105,00	36	9 Mohs	25 kg
0582/80	€ 105,00	80	9 Mohs	25 kg

0578-
CARBURO DI SILICIO

Il Carburo di silicio nero è il materiale più duro utilizzato per la sabbiatura, facendolo la soluzione ideale per tutte le lavorazioni più impegnative. Praticamente privo di ferro, le sue proprietà abrasive lo rendono molto aggressivo e veloce nella rimozione delle impurità. La sua conformazione permette ai grani di rompersi continuamente creando nuovi bordi affilati e taglienti, aumentando la finezza della granulometria. Molto duraturo e molto riutilizzabile. Tende ad incorporarsi nel materiale.



Art.	€	Grana	Durezza	Peso netto
0578/36	€ 145,00	36	9.1 Mohs	25 kg
0578/80	€ 145,00	80	9.1 Mohs	25 kg

0579-
GARNET

Il Garnet è uno degli ultimi abrasivi naturali ancora in utilizzo. È una pietra naturale, e quindi ecologica, con eccellenti proprietà abrasive che permette di creare profili privi di incorporazione dell'abrasivo, produrre poca polvere e avere un consumo relativamente basso. È eccellente per rimuovere rivestimenti duri, vernice, ruggine e scaglie di laminazione. Può essere usato sia per sabbiatura a secco che ad acqua. Il suo basso costo lo rende un'alternativa al corindone.



Art.	€	Grana	Durezza	Peso netto
0579/30	€ 57,90	36 ÷ 60	7.5 Mohs	25 kg
0579/80	€ 57,90	80	7.5 Mohs	25 kg

0569
SFERE DI ACCIAIO

Grazie alla loro superficie sferica e durezza permettono di ottenere superfici brillanti. Ottime per rimozione di vernici, imperfezioni, bave e ruggine. La loro bassa frantumazione non crea polvere all'interno della cabina di sabbiatura e permette una lunga durata dell'abrasivo. Utilizzabili sia come mezzo per pallinatura che per sabbiatura sia a secco che ad acqua.



Grana	S390
Durezza	40 ÷ 50 HRC
Peso netto	25 kg

€ 90,50
0581
MICROSFERE DI VETRO

Grazie alla loro forma sferica sono perfette per effettuare la finitura superficiale. Creano superfici lisce e luminose, lasciando un effetto satinato ineguagliabile. Non contenendo ferro sono molto indicate per lavorazioni su acciaio Inox ad utilizzo alimentare ed alluminio. Le microsfere non danneggeranno il substrato del materiale in lavorazione ma lasceranno un profilo di ancoraggio per una successiva verniciatura, soprattutto su materiali morbidi come ottone, alluminio, plastiche etc...



Grana	50 ÷ 70 (0,3 ÷ 0,2 mm)
Durezza	5-7 Mohs
Peso netto	25 kg

0310B
BICARBONATO DI SODIO PER SABBIARE

Composto salino a base di bicarbonato sintetico, adatto per trattare acciaio, alluminio, fibra di vetro, plastica, mattoni ecc...



Grana	36 ÷ 80 (0,5 ÷ 0,3 mm)
Durezza	2,5 - 3 Mohs
Temperatura di decomposizione	> 50°C
Peso netto	25 kg

€ 81,20

0490/11

€ 24,80

GUANTI PER SABBIATRICE



Diametro guanti 100 mm

05x

COPPIA GUANTI

Morbidi e confortevoli.



Art.	€	Lunghezza	Diametro guanti
0575/29	€ 43,80	600 mm	180 mm
0580/21	€ 43,80	450 mm	145 mm

0490/03

€ 27,00

SERIE PROTEZIONI FINESTRA

Per sabbiatrici.



5 Pcs

0601/24

€ 24,80

SERIE PROTEZIONI FINESTRA

Per sabbiatrici, 670 x 300 mm.



5 Pcs

Misura 670 x 300 mm

0601/30

€ 18,00

SERIE PROTEZIONI PLAFONIERA

Per sabbiatrici, 900 x 260 mm.



5 Pcs

Misura 900 x 260 mm

0687/005

€ 30,30

SERIE PROTEZIONI PLAFONIERA

Per sabbiatrici, 600 x 100 mm.



10 Pcs

Misura 600 x 100 mm

0575/04

€ 47,60

SERIE PROTEZIONI FINESTRA

Per sabbiatrici, 550 x 250 mm.



10 Pcs

Misura 550 x 250 mm

0580/01-6

€ 30,30

SERIE PROTEZIONI FINESTRA

Per sabbiatrici, 400 x 300 mm.



5 Pcs

Misura 400 x 300 mm

SA01/F

€ 174,00

FILTRO PER CICLONE

In HEPA.



Diametro 320 mm
Altezza 600 mm

0687/029

€ 81,80

FILTRO CICLONE



Diametro 170 mm
Altezza 305 mm

0687/041
€ 112,00
PISTOLA SABBIAATRICE

Per sabbiatriche 0687.

0290
€ 41,40
PISTOLA SABBIAATRICE

Pistola in metallo, con ugelli in ceramica.



Ugelli in ceramica	Ø 4 - 5 - 6 - 7 mm
Lunghezza tubo in gomma	1,5 m
Attacco aria	G 1/4"
Livello pressione acustica	< 70 dB(A)
Vibrazioni	< 2.5 m/s ²
Pressione di esercizio	0.6 MPa

0577/17
€ 48,30
PISTOLA FISSA

U003
€ 115,00
UGELLO IN CARBURO DI BORO

Per sabbiatriche e pallinatriche, lunga durata.



Diametro ugello

Ø 7,5 mm

U004
€ 73,30
UGELLO IN MATERIALE COMPOSITO

Per sabbiatriche e pallinatriche, lunga durata.



4 Pcs

Diametro ugello

Ø 3,5 mm

0490/20
€ 10,10
SERIE UGELLI IN CERAMICA

0462/55
€ 39,50
SERIE UGELLI IN CERAMICA

5 Pcs

Diametro ugello

Ø 7,5 mm

0575/0580/12
€ 19,00
SERIE UGELLI IN CERAMICA

4 pz, diametro Ø 4,5,6,7 mm.



4 Pcs

Diametro ugello

Ø 4 - 5 - 6 - 7 mm

0687/102
€ 20,50
SERIE UGELLI IN CERAMICA

4 Pcs

Diametro ugello

Ø 6 - 7 mm

0305
€ 835,00
LAVAPEZZI AD ACQUA CALDA

Per lavaggi con acqua calda fino a 60° C, con pistola pneumatica ad effetto Venturi.



Capacità serbatoio	8 + 14 l
Consumo aria stimato	5 SCFM 145 l / min
Area di lavoro	760 x 560 x 380 mm
Pressione di lavaggio	5 ÷ 8 Bar
Potenza	1350 W
Dimensioni	790 x 610 x 1260 h mm
Peso netto	49 kg

0486
€ 598,00
VASCA DI LAVAGGIO DOPPIO USO

Capacità 150 l, con pompa 26 W, spazzola di pulizia e tubo flessibile, vassoio porta pezzi.



Dimensioni interne vasca sinistra	470 x 520 x 270 mm
Dimensioni interne vasca destra	590 x 520 x 270 mm
Capacità vasca	150 l
Pompa	230V 50Hz 26 + 26 W
Portata pompa	10 ÷ 12 l/min
Ingombro	1140 x 550 x 880 h mm
Peso netto	43 kg

0203
€ 639,00
LAVAPEZZI DA BANCO

Per lavaggi con acqua/solventi, con pistola pneumatica ad effetto Venturi.



Dimensioni	770 x 595 x 700h mm
Capacità serbatoio	4 + 9 l
Consumo aria stimato	5 SCFM 145 l / min
Area di lavoro	765 x 560 x 380 mm
Potenza	30 W
Pressione di lavaggio	5 ÷ 8 Bar
Alimentazione	230 V 50 Hz
Peso netto	32 kg

0038
€ 311,00
VASCA DI LAVAGGIO

Capacità 75 l, con pompa 26 W, spazzola di pulizia e tubo flessibile, vassoio porta pezzi.



Dimensioni interne vasca	710 x 480 x 260h mm
Capacità vasca	75 l
Pompa	230 V 50 Hz 26 W
Portata pompa	10÷12 l / min
Dimensioni	775 x 540 x 880 h mm
Peso netto	25 kg

0232
€ 392,00
VASCA DI LAVAGGIO SU CARRELLO

Dimensioni interne vasca	710 x 480 x 200 h mm
Capacità vasca	60 l
Pompa	230 V 50 Hz 26 W
Portata pompa	10 ÷ 12 l / min
Dimensioni	970 x 540 x 930 h mm
Peso netto	35 kg

0632
€ 883,00
VASCA DI LAVAGGIO PNEUMATICA

Dimensioni interne vasca	710 x 480 x 200 h mm
Altezza	1015 mm
Capacità serbatoio	50 l
Capacità vasca	65 l
Pressione di alimentazione	6 Bar
Pressione massima serbatoio	0.5 Bar
Peso netto	38 kg

0392
€ 421,00
VASCA DI LAVAGGIO DA BANCO

Per montaggio a parete.



Capacità	14 l
Luce al neon	24 V 8 W
Pompa	230 V 50 Hz 26 W
Portata pompa	10 ÷ 12 l / min
Dimensioni	560 x 545 x 635 h mm
Peso netto	25 kg

0211
€ 557,00
BANCO MOBILE PER SMONTAGGI CON RECUPERO LIQUIDI

Fornito in kit di montaggio, con cassetto dotato di serratura, vasca estraibile e ruote pivotanti di cui due dotate di freno.



Dimensioni	1200 x 640 x 872h mm
Dimensioni piano di lavoro	1190 x 635 x 15h mm
Dimensioni cassetto	420 x 340 x 120h mm
Dimensioni interne vasca	360 x 260 x 115h mm
Altezza mensola interna	445 mm
Portata massima con ruote	280 kg
Portata massima senza ruote	350 kg
Peso netto	64 kg

0233
€ 286,00
VASCA DI LAVAGGIO PORTATILE

Costruita in ABS con guarnizioni in gomma NBR.



Dimensioni interne vasca	460 x 660 x 260 mm
Capacità	9 l
Pompa	230 V 50 Hz 16 W

0632/01
€ 9,90
PENNELLO PER LAVAPEZZI

Non idoneo per prodotti a base di idrocarburi.



Lunghezza	280 mm
Diametro	35 mm
Attacco	20 mm x Ø10 mm

0305/0203/1118
€ 38,40
COPPIA GUANTI PER LAVAPEZZI

Non idoneo per prodotti a base di idrocarburi.



Lunghezza	540 mm
-----------	--------

UC01-
NEW
LAVAPEZZI A ULTRASUONI

La vasca di lavaggio a ultrasuoni è ideale per la pulizia profonda di parti di ricambio, ricambi in metallo in generale, componenti meccanici/elettronici ed utensili. Grazie ai comandi LCD è facile la regolazione di tempo e temperatura. Per una pulizia generale è sufficiente l'utilizzo di acqua; per una pulizia più profonda utilizzare detersivi specifici. La vasca, interamente realizzata in acciaio inox, è igienica e facile da pulire. Cestello di lavaggio interno incluso.



Art.	€	Alimentazione	Potenza ultrasuoni	Potenza di riscaldamento	Capacità Litri	Modalità di svuotamento	Regolazione tempo di lavaggio	Temperatura	Dimensioni esterne	Dimensioni del vano	Peso netto
UC01/20	€ 176,00	230V 50Hz	60 W	100 W	2 L	Manuale	0 - 99 min	0C° - 80C°	190 x 170 x 195 mm	150 x 140 x 100 mm	2,1 Kg
UC01/32	€ 241,00	230V 50Hz	120 W	100 W	3,2L	Manuale	0 - 99 min	0C° - 80C°	270 x 170 x 220 mm	240 x 140 x 100 mm	3,2 Kg
UC01/65	€ 384,00	230V 50Hz	180 W	300 W	6,5 L	Rubinetto	0 - 99 min	0C° - 80C°	330 x 180 x 280 mm	300 x 155 x 150 mm	5,2 Kg
UC01/100	€ 483,00	230V 50Hz	240 W	300 W	10 L	Rubinetto	0 - 99 min	0C° - 80C°	330 x 270 x 280 mm	300 x 240 x 150 mm	6,55 Kg
UC01/150	€ 636,00	230V 50Hz	360 W	400 W	15 L	Rubinetto	0 - 99 min	0C° - 80C°	360 x 330 x 280 mm	330 x 300 x 150 mm	8,3 Kg

0632-
LIQUIDO LAVAPEZZI

Art.	€	Contenuto	Specifica
0632/D	€ 157,00	25 l	A base solvente
0632/DA	€ 210,00	25 l	Diluibile con acqua max. 50%
0632/DCF	€ 115,00	25 l	Diluibile con acqua max. 20%, utilizzo a caldo

0632/DCF05
€ 31,30 NEW
LIQUIDO LAVAPEZZI

Contenuto	5 l
Specifica	Diluibile con acqua max. 20%, utilizzo a caldo o ultrasuoni



A024/10
€ 76,70
ASPIRAPOLVERE ASPIRALIQUIDI 10L

Con serbatoio in ABS, funzione soffiaggio, completo di accessori.



Potenza	1,2 kW
Capienza	10 l
Motore	230 V 50 Hz
Portata d'aria	30 ± 2 l/s
Peso netto	3,7 kg

A025/30
€ 114,00
ASPIRAPOLVERE ASPIRALIQUIDI 30L

Con serbatoio in acciaio inox, funzione soffiaggio, completo di accessori.



Potenza	1,2 kW
Capienza	30 l
Motore	230 V 50 Hz
Portata d'aria	28 l / s
Peso netto	6 kg

A040/30A
€ 200,00
ASPIRAPOLVERE ASPIRALIQUIDI 30L

Per uso industriale completo di accessori - con funzione di soffiatore d'aria e dotato di presa per elettrotensili con accensione e spegnimento automatico.



Potenza	1,4 kW
Capienza	30 l
Motori	1 (230 V 50 Hz)
Portata d'aria	35 l / s
Presa elettrotensile	1600 W
Peso netto	7,5 kg

A040/60A
€ 325,00
ASPIRAPOLVERE ASPIRALIQUIDI 60L

Per uso industriale completo di accessori - con funzione di soffiatore d'aria e dotato di presa per elettrotensili con accensione e spegnimento automatico.



Potenza	1,4 kW
Capienza	60 l
Motori	1 (230 V 50 Hz)
Portata d'aria	46 l / s
Presa elettrotensile	1600 W
Peso netto	13 kg

A024/602

€ 315,00

ASPIRAPOLVERE ASPIRALIQUIDI 60L CON 2 MOTORI

Con serbatoio in ABS, completo di accessori.



Potenza	2,8 kW
Capienza	60 l
Motori	2 (230 V 50 Hz)
Portata d'aria	30 ±2 l/s
Peso netto	12,5 kg

A040/802

€ 569,00

ASPIRAPOLVERE ASPIRALIQUIDI 80L 2 MOTORI

Per uso industriale completo di accessori - con funzione di soffiatore d'aria.



Potenza	2 kW
Capienza	80 l
Motori	2 (230 V 50 Hz)
Portata d'aria	75 l/s
Dimensioni	600 x 580 x 950 mm
Peso netto	25 kg

A040/803

€ 704,00

ASPIRAPOLVERE ASPIRALIQUIDI 80L 3 MOTORI

Per uso industriale completo di accessori - con funzione di soffiatore d'aria.



Potenza	3 kW
Capienza	80 l
Motori	3 (230 V 50 Hz)
Portata d'aria	96 l/s
Dimensioni	600 x 580 x 950 mm
Peso netto	28 kg



ACAS/001 € 11,20

SERIE DI FILTRI
IN SPUGNA PER
ASPIRAPOLVERE



ACAS/002 € 15,80

FILTRO HEPA PER
ASPIRAPOLVERE



ACAS/003 € 11,20

TUBO FLESSIBILE PER
ASPIRAPOLVERE



Ricambi Tubo da 1,5 m

ACAS/004 € 15,80

TUBO IN METALLO
ALLUNGABILE PER
ASPIRAPOLVERE



ACAS/005 € 11,20

COPIA DI TUBI
IN PLASTICA PER
ASPIRAPOLVERE



ACAS/006 € 11,20

SERIE DI FILTRI
IN SPUGNA PER
ASPIRAPOLVERE



ACAS/007 € 11,20

FILTRO PER
ASPIRAPOLVERE



ACAS/008 € 24,80

SERIE DI SACCHETTI
IN CARTA PER
ASPIRAPOLVERE



ACAS/009 € 11,20

TUBO FLESSIBILE PER
ASPIRAPOLVERE



ACAS/010 € 11,20

SPAZZOLA GRANDE PER
ASPIRAPOLVERE



ACAS/011 € 6,80

SPAZZOLA MULTI
FUNZIONE PER
ASPIRAPOLVERE



ACAS/012 € 23,30

SERIE DI SACCHETTI
IN CARTA PER
ASPIRAPOLVERE



ACAS/013 € 22,60

SERIE SACCHETTI
In carta per aspirapolvere.



ACAS/014 € 11,20

TUBO IN PLASTICA
Per aspirapolvere.



ACAS/015 € 10,10

SPAZZOLA PICCOLA
Per aspiratore.



ACAS/017 € 11,20

SERIE FILTRI IN SPUGNA
Per aspiratore.



A040/8037 € 20,30

TUBO FLESSIBILE PER
ASPIRAPOLVERE



A040/8040 € 29,30

COPIA TUBI IN METALLO
PER ASPIRAPOLVERE



Lettera F
Ricambi Coppia tubi in metallo

A040/8047U € 15,80

SPAZZOLA DA UMIDO
PER ASPIRAPOLVERE



A040/8047S € 14,60

SPAZZOLA DA SECCO PER
ASPIRAPOLVERE



A040/8029 € 16,90

FILTRO PER
ASPIRAPOLVERE



A040/8046 € 5,60

LANCIA CORTA PER
ASPIRAPOLVERE



A040/8048 € 9,10

SPAZZOLA ROTONDA PER
ASPIRAPOLVERE



Lettera D
Ricambi Lancia corta

M041

€ 8000,00

MACCHINA MARCATRICE A MICROPUNTI PORTATILE

Completa di computer con touch screen.



Area di marcatura	110 x 40 mm
Velocità di scrittura	3 - 5 Caratteri / sec
Massima durezza del pezzo	≤ HRC62
Peso netto	12 kg

M040

€ 6640,00

MACCHINA MARCATRICE A MICROPUNTI, PNEUMATICA

Con connessione usb, software per windows xp e windows 7 32 bit.



Area di marcatura	110 x 80 mm
Velocità di scrittura	30 - 40 mm / sec
Dimensioni tavola	320 x 300 mm
Massima durezza del pezzo	≤ HRC62
Peso netto	60 kg

M040/CF € 146,00

COMANDO A FILO PER MARCATRICE

M040/CP € 315,00

COMANDO A PEDALE PER MARCATRICE

M040/D € 2120,00

DIVISORE PER MARCATRICE

M040/SA € 169,00

SUPPORTO PER ALBERI PER MARCATRICE

M040/SP € 386,00

SUPPORTO PER TARGHETTE PER MARCATRICE

M040/ST € 146,00

SUPPORTO PER TUBI PER MARCATRICE

P012-L
LETTERE HRC 58-60

Art.	€	Dimensioni carattere	Dimensioni gambo
P012/L03	€ 19,00	3 mm	6 x 6 x 60h mm
P012/L04	€ 19,80	4 mm	7 x 7 x 61h mm
P012/L05	€ 22,20	5 mm	7,5 x 7,5 x 61h mm
P012/L06	€ 24,80	6 mm	8,8 x 8,8 x 63h mm
P012/L08	€ 32,40	8 mm	10 x 10 x 66h mm

P012-LxP
LETTERE HRC 58-60

Micro stress.



Art.	€	Dimensioni carattere	Dimensioni gambo
P012/L03P	€ 41,40	3 mm	7 x 7 x 61h mm
P012/L04P	€ 45,00	4 mm	7,5 x 7,5 x 61h mm
P012/L05P	€ 50,00	5 mm	8,8 x 8,8 x 63h mm
P012/L06P	€ 58,60	6 mm	10 x 10 x 66h mm
P012/L08P	€ 99,10	8 mm	12 x 12 x 70h mm

P012-N
NUMERI HRC 58-60

Art.	€	Dimensioni carattere	Dimensioni gambo
P012/N03	€ 10,40	3 mm	6 x 6 x 60h mm
P012/N04	€ 11,60	4 mm	7 x 7 x 61h mm
P012/N05	€ 12,60	5 mm	7,5 x 7,5 x 61h mm
P012/N06	€ 13,90	6 mm	8,8 x 8,8 x 63h mm
P012/N08	€ 15,30	8 mm	10 x 10 x 66h mm

P012-NxP
NUMERI HRC 58-60

Micro stress.



Art.	€	Dimensioni carattere	Dimensioni gambo
P012/N03P	€ 19,00	3 mm	7 x 7 x 61h mm
P012/N04P	€ 22,70	4 mm	7,5 x 7,5 x 61h mm
P012/N05P	€ 28,40	5 mm	8,8 x 8,8 x 63h mm
P012/N06P	€ 32,60	6 mm	10 x 10 x 66h mm
P012/N08P	€ 39,00	8 mm	12 x 12 x 70h mm

P021
€ 27,90
PENNA ELETTRICA A BATTERIA

Rotativa, con 2 punte diamantate Ø 2,35 mm, maneggevole e leggera, adatta all'incisione di vetro, ceramica, plastica, legno, inox, ottone, alluminio, acciai teneri.



Velocità	20000 rpm
Lunghezza	160 mm
Batterie non incluse	2 x 1,5V AAA

P002
€ 4,50
PUNTE PER TRACCIARE CON CUSPIDE IN METALLO DURO

Lunghezza	153 mm
-----------	--------

P005
€ 5,20
PUNTA PER TRACCIARE IN ACCIAIO

Lunghezza	270 mm
-----------	--------



P039

€ 7,90

PUNTE PER TRACCIARE

Con cuspidi in metallo duro.



Punta a scomparsa

Lunghezza

150 mm

P039/PR

€ 5,60

SET PUNTE DI RICAMBIO IN METALLO DURO



2 Pcs



Lunghezza

40 mm

P020

€ 31,30

PENNA ELETTRICA A VIBRAZIONE

Con regolazione della vibrazione, adatta all'incisione di vetro, ceramica, plastica, legno, inox, ottone, alluminio, acciai teneri.



Vibrazioni

7200 / min

Alimentazione

230 V 50 Hz 13 W

P020/P

€ 8,70

SERIE PUNTE DI RICAMBIO



2 Pcs



PRESSE



Portata (Kg x1000)

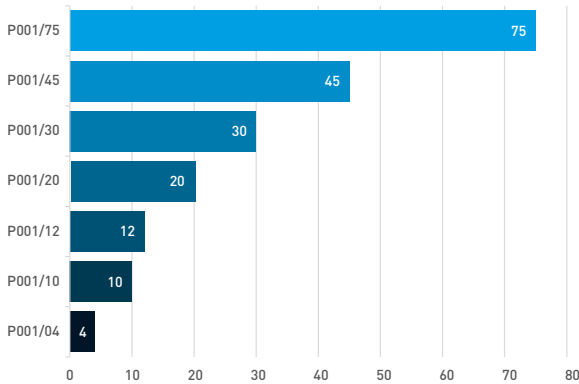

Corsa del pistone (mm)

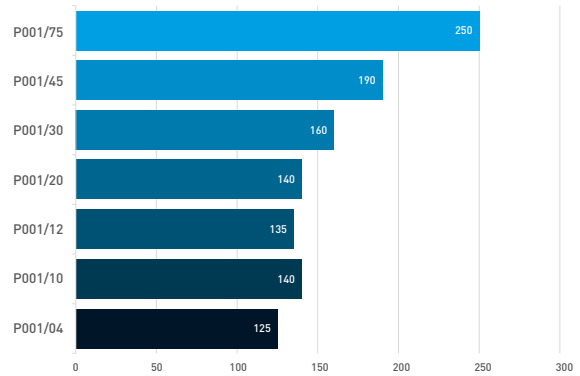

Area di lavoro

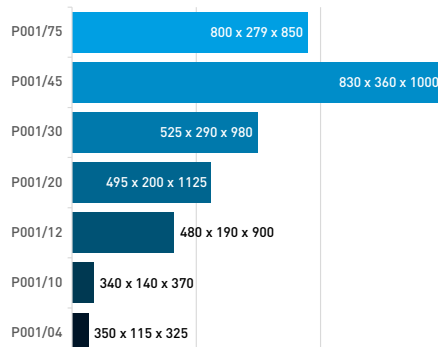

P001/75
€ 6010,00
PRESSA IDRAULICA MANUALE E PNEUMATICA

Dotata di pistone mobile carrellato, con argano per movimentazione banco, comando manuale a due velocità e servopompa pneumatica con comando a pedale



Portata	75000 kg
Area di lavoro	800 x 279 x 850 h mm
Ø cilindro	125 mm
Ø pistone	78 mm
Corsa pistone	250 mm
Pressione di esercizio	0,75 ÷ 0,85 MPa
Dimensioni	1140 x 800 x 1896 h mm
Peso netto	460 kg

P001/45
€ 3140,00
PRESSA IDRAULICA MANUALE E PNEUMATICA

Con argano manuale per movimentazione banco, dotata di comando manuale e servopompa pneumatica con comando a mano.



Portata	45000 kg
Area di lavoro	830 x 360 x 1000 h mm
Ø cilindro	90 mm
Ø pistone	58 mm
Corsa pistone	190 mm
Pressione di esercizio	7÷ 8 Bar
Pressione massima	63,5 MPa
Dimensioni	1400 x 800 x 1700 h mm
Peso netto	330 kg

P001/30
€ 1240,00
PRESSA MANUALE IDRAULICA

Con pompa a due velocità e pistone mobile.



Portata	30000 kg
Area di lavoro	525 x 290 x 980 h mm
Ø cilindro	92 mm
Ø pistone	56 mm
Corsa pistone	160 mm
Pressione massima	69 MPa
Dimensioni	875 x 700 x 1780 h mm
Peso netto	145 kg



P001/20
€ 1010,00
PRESSA MANUALE IDRAULICA

Con pistone mobile.



Portata	20000 kg
Area di lavoro	495 x 200 x 1125 h mm
Ø cilindro	75 mm
Ø pistone	48 mm
Corsa pistone	140 mm
Pressione massima	69.3 MPa
Dimensioni	690 x 600 x 1830 h mm
Peso netto	94 kg

P001/12
€ 613,00
PRESSA MANUALE IDRAULICA

Con pistone mobile.



Portata	12000 kg
Area di lavoro	480 x 190 x 900 h mm
Ø cilindro	56 mm
Ø pistone	38 mm
Corsa pistone	135 mm
Pressione massima	69 MPa
Dimensioni	730 x 550 x 1600 h mm
Peso netto	60 kg

P001/10
€ 501,00
PRESSA MANUALE IDRAULICA

Da banco con pistone mobile.



Portata	10000 kg
Area di lavoro	340 x 140 x 370 h mm
Ø cilindro	56 mm
Ø pistone	38 mm
Corsa pistone	140 mm
Pressione massima	69 MPa
Dimensioni	565 x 500 x 1040 h mm
Peso netto	52 kg

P001/04
€ 335,00
PRESSA MANUALE IDRAULICA

Da banco, 4 ton, per cuscinetti.



Portata	4000 kg
Area di lavoro	350 x 115 x 325 h mm
Ø cilindro	40 mm
Ø pistone	25 mm
Corsa pistone	125 mm
Pressione massima	51 MPa
Dimensioni	450 x 400 x 655 h mm
Peso netto	30 kg

P022-

PRESSA MANUALE A CREMAGLIERA

Con tavola girevole estraibile.



Art.	€	Forza	Altezza max pezzo	Max Ø pezzo	Sezione albero	Peso netto
P022/05	€ 101,00	5000 N	90 mm	160 mm	19 x 19 mm	8 kg
P022/10	€ 143,00	10000 N	100 mm	180 mm	25 x 25 mm	12 kg
P022/20	€ 334,00	20000 N	170 mm	260 mm	30 x 30 mm	27 kg

P029-

PRESSA MANUALE A CREMAGLIERA

Con tavola girevole estraibile.



Art.	€	Forza	Dimensioni	Altezza max pezzo	Max Ø pezzo	Sezione albero	Peso netto
P029/2	€ 381,00	15000 N	390 x 160 x 720h mm	190 mm	180 mm	30 x 30 mm foro 10 mm	42 kg
P029/3	€ 482,00	25000 N	450 x 200 x 870h mm	290 mm	250 mm	37,5 x 37,5 mm foro 13.80 mm	60 kg

P028-

PRESSA MANUALE

Con molla di ritorno.



Art.	€	Forza	Dimensioni	Altezza max pezzo	Max Ø pezzo	Corsa albero	Peso netto
P028/07	€ 150,00	1500 N	240 x 155 x 335h mm	230 mm	150 mm	50 mm	8,5 kg
P028/14	€ 255,00	2000 N	280 x 170 x 760h mm	275 mm	180 mm	70 mm	18 kg

0485

€ 110,00

SERIE DI PUNZONI PER PRESSE



8 Pcs

Dimensione testa dei perni 24,7 mm

0054/10
€ 422,00
UNITÀ IDRAULICA IN KIT

Capacità	10 ton
Lunghezza pistone	330 mm
Corsa pistone	130 mm
Peso netto	30 kg

0054/4
€ 340,00
UNITÀ IDRAULICA IN KIT

Capacità	4 ton
Lunghezza pistone	270 mm
Corsa pistone	120 mm
Peso netto	19 kg

0664
€ 383,00
POMPA IDRAULICA CON COMANDO PNEUMATICO A PEDALE

Adatta per presse, cric e pistoni.



Pressione nominale	70 MPa
Pressione di esercizio	7 ÷ 8 bar
Capacità olio	690 ml
Consumo aria	10 SCFM
Peso netto	8 kg

0271
€ 156,00
POMPA IDRAULICA

Con pedale di azionamento pompa.



Pressione nominale	63,7 MPa
Capacità olio	790 ml
Lunghezza tubo	1500 mm
Peso netto	7 kg

0663
€ 139,00
TIRANTE IDRAULICO

Portata	5 ton
Lunghezza Chiuso	560 mm
Lunghezza Aperto	690 mm
Stelo	ø 33 mm
Corsa	130 mm
Peso netto	5,5 kg



0567
€ 113,00
CRIC A PROFILO RIBASSATO

Da 2 ton, costruito in acciaio, con maniglie di sollevamento.



Capacità	2 ton
Alzata	90 ÷ 385 mm
Dimensioni	580 x 165 x 235 h mm
Peso netto	13 kg

0457
€ 632,00
CRIC A PROFILO RIBASSATO

Da 2 ton, costruito in acciaio, con impugnatura circolare.



Capacità	2 ton
Alzata	70 ÷ 500 mm
Dimensioni	785 x 350 x 152 mm
Peso netto	41 kg

0369
€ 393,00
CRIC A PROFILO RIBASSATO

A doppio pompante con sella smontabile e tampone in gomma.



Capacità	3,5 ton
Dimensioni	745 x 335 x 180 mm
Alzata	110 ÷ 560 mm
Peso netto	46 kg

0375A
€ 324,00
CRIC A PROFILO RIBASSATO

Da 2.5 ton, avvicinamento veloce con doppia pompa, con limitatore di carico.



Capacità	2.5 ton
Alzata	75 ÷ 500 mm
Dimensioni	680 x 345 x 220 h mm
Peso netto	32,5 kg

0065A
€ 273,00
CRIC A CARRELLO

Con sella smontabile.



Capacità	3 ton
Dimensioni	660 x 345 x 260 mm
Alzata	140 ÷ 515 mm
Peso netto	33 kg

C038/30
€ 203,00
CRIC A CARRELLO

Capacità	3 ton
Dimensioni	572 x 328 x 175h mm
Alzata	130 ÷ 465 mm
Peso netto	28 kg



**0060****€ 83,50****CRIC A CARRELLO**

Telaio in acciaio. Maniglia per il trasporto a mano. Leva allungabile.



Portata	2 ton
Dimensioni	535 x 225 x 145 mm
Alzata	135 ÷ 385 mm
Peso netto	11 kg

C039/25**€ 346,00****CRIC A CARRELLO**

Cric a carrello in alluminio e acciaio a doppio pompante, avvicinamento rapido.



Capacità	2,5 ton
Dimensioni	659 x 289 x 165 h mm
Alzata	110 ÷ 460 mm
Peso netto	27 kg

C039/15**€ 250,00****CRIC A CARRELLO**

Cric a carrello in alluminio e acciaio a doppio pompante, avvicinamento rapido.



Capacità	1,5 ton
Dimensioni	490 x 270 x 130 h mm
Alzata	90 ÷ 358 mm
Peso netto	15 kg

0658**€ 941,00****SOLLEVATORE IDRAULICO**

Capacità	10 ton
Sollevamento sul piede	30 ÷ 260 mm
Sollevamento sulla testa	420 ÷ 665 mm
Peso netto	30 kg

0067**€ 32,00****COPPIA DI CAVALLETTI**

Altezza regolabile con perno di fissaggio.



Portata	2 ton
Altezze	240 - 270 - 320 - 365 mm
Peso netto	3 kg

0069-**COPPIA DI CAVALLETTI**

Art.	€	Portata	Altezza min - max	Dimensioni base	Peso netto
0069/3	€ 52,90	3 ton	298 ÷ 428 mm	190 x 210 mm	6,5 kg
0069/6	€ 98,30	6 ton	400 ÷ 610 mm	260 x 285 mm	13 kg
0069/10	€ 216,00	10 ton	468 ÷ 718 mm	290 x 328 mm	29 kg

0021/1
€ 608,00
GRUETTA IDRAULICA PIEGHEVOLE

Con due ruote pivotanti dotate di freno, ruote in fusione di ghisa. Sistema di discesa e leva di pompaggio laterali. La possibilità di piegare le gambe quando non in utilizzo permette di immagazzinarla in spazi ristretti.



Portata	1000 kg
Dimensioni	1555 x 1010 x 1455h mm
Dimensioni chiusa	720 x 490 x 1520h mm
Sbraccio min/max	715 ÷ 990 mm
Altezza gancio con braccio alzato	1800 mm @ 1000 kg 1970 mm @ 250 kg
Altezza gancio con braccio abbassato	160 mm @ 250 kg 400 mm @ 1000 kg
Apertura anteriore	890 mm
Peso netto	64,5 kg

0021/2
€ 744,00
GRUETTA IDRAULICA PIEGHEVOLE

Con due ruote pivotanti dotate di freno, ruote in fusione di ghisa. Sistema di discesa e leva di pompaggio laterali. La possibilità di piegare le gambe quando non in utilizzo permette di immagazzinarla in spazi ristretti.



Portata	2000 kg
Dimensioni	1730 x 1025 x 1400h mm
Dimensioni chiusa	760 x 760 x 1635h mm
Sbraccio min/max	750÷ 1280 mm
Altezza gancio con braccio alzato	1870 mm @ 2000 kg 2280 mm @ 500 kg
Altezza gancio con braccio abbassato	0 mm @ 500 kg 430 mm @ 2000 kg
Apertura anteriore	910 mm
Peso netto	90,5 kg

0063
€ 763,00
GRUETTA IDRAULICA PIEGHEVOLE

Con due ruote pivotanti e freno posteriore a tampone, sistema di discesa e leva di pompaggio posteriore, ruote in fusione di ghisa. La possibilità di piegare le gambe quando non in utilizzo permette di immagazzinarla in spazi ristretti.



Portata	1000 kg
Dimensioni	1800 x 1000 x 1500h mm
Dimensioni chiusa	800 x 860 x 1600h mm
Sbraccio min/max	680 ÷ 1220 mm
Altezza gancio con braccio alzato	2100 mm @ 1000 kg 2550 mm @ 250 kg
Altezza gancio con braccio abbassato	0 mm @ 250 kg 480 mm @ 1000 kg
Apertura anteriore	800 mm
Peso netto	90 kg

0094
€ 382,00
SOLLEVATORE IDRAULICO PER FOSSA E SOTTOPONTE

Con limitatore di carico, supporto a croce e supporto inclinabile per allineare e posizionare meglio cambi e differenziali.



Portata	500 kg
Dimensioni	1190 x 700 x 660 mm
Altezza di sollevamento	1190 ÷ 2000 mm
Peso netto	32,5 kg

**S033**

€ 180,00

SUPPORTO MOTORE

2 ruote girevoli con freno e 2 ruote fisse in ghisa, possibilità di inclinare il motore.
Dotato di piano porta minuteria girevole.



Portata	600 kg
Dimensioni	1200 x 840 x 930 mm
Peso netto	27,5 kg
A	720 mm
B	840 mm
C	170 mm

S068

€ 229,00

SUPPORTO MOTORE

2 ruote girevoli con freno e 2 ruote fisse in ghisa, possibilità di inclinare il motore. La possibilità di piegarlo quando non in utilizzo permette di immagazzinarla in spazi ristretti.



Portata	680 kg
Dimensioni	860 x 830 x 900 mm
Peso netto	31 kg
A	820 mm
B	810 mm
C	180 mm
D	680 mm

S019

€ 163,00

SUPPORTO MOTORE

2 ruote girevoli con freno e 2 ruote fisse, possibilità di inclinare il motore.



Portata	450 kg	B	810 mm
Dimensioni	865 x 810 x 870 mm	C	150 mm
Peso netto	21 kg	D	450 mm
A	780 mm		

S024

€ 157,00

STAFFE DI SOLLEVAMENTO MOTORE

Staffe a ponte per sostenere il motore nel vano dell'auto, viene usato quando si smonta il cambio o il differenziale. Pratiche protezioni in gomma morbida di appoggio nelle canaline dei parafranghi, regolazioni precise e immediate per sostenere il motore all'interno dei parafranghi. Staffe girevoli e inclinabili.



Capacità	500 kg
Regolazione	205 mm
Lunghezza utile	730 ÷ 1480 mm
Peso netto	13 kg

0147

€ 65,50

LIVELLATORE DI CARICO

Per gruette o carro ponte, per bilanciare e sollevare pesi leggermente sbilanciati.



Capacità	680 kg
Larghezza	440 mm
Max spostamento della slitta	330 mm
Catena	350 mm
Peso netto	5 kg

R015

€ 184,00

SET RAMPE PER AUTO

Set composto da due solide rampe per facilitare il lavoro sotto i veicoli. Queste piccole rampe sono adatte ai modelli più comuni di utilitarie e SUV o anche ai veicoli più lunghi. Prodotti in polipropilene, i cunei sono decisamente più affidabili rispetto alle rampe in acciaio. Inoltre, grazie alla loro struttura antiscivolo, offrono un'ottima stabilità. Leggere e ben sagomate, le rampe sono facili da trasportare e salvaspazio.



Dimensioni	905 x 330 x 218 mm
Capacità	2,5 ton
Larghezza max pneumatico	240 mm
Altezza di sollevamento	170 mm
Inclinazione	15°
Peso netto	8 kg

0649-
RAMPE IN ALLUMINIO

In alluminio con pavimenti antisdrucciolo. Portata 170kg.



Art.	€	Dimensioni	Portata	Pendenza max	Dislivello max	Peso netto
0649/1500	€ 417,00	1520 x 735 mm	170 kg	12,5 % (7°)	180 mm	13,5 kg
0649/1800	€ 518,00	1800 x 735 mm	150 kg	12,5 % (7°)	220 mm	16 kg

0594
€ 161,00
CARRELLINO RACCOGLI OLIO SENZA SERBATOIO

Per uso sotto ponte.



Dimensioni base	390 x 390 mm
Altezza massima	1700 mm
Peso netto	13 kg

0595
€ 324,00
UNITÀ RACCOGLI OLIO

Carrellata con serbatoio per uso sotto ponte.



Capacità serbatoio	70 l
Altezza min - max	1170 ÷ 1860 mm
Pressione massima serbatoio	0.45 bar
Peso netto	23 kg

0596
€ 519,00
UNITÀ ASPIRA OLIO PNEUMATICA

Carrellata, per olio esausto, con sonde di aspirazione di vario diametro, anche per uso sotto ponte.



Capacità serbatoio	70 l
Capacità serbatoio graduato	10 l
Altezza massima	1500 mm
Sonda in metallo	2 x ø6 mm x 695 mm
Sonda in nylon	2 x ø6 mm x 680 mm 2 x ø8 mm x 700 mm
Aspirazione	ø6 x 4,5 mm - 0,4 ÷ 0,8 l/min ø8 x 6,5 mm - 1 ÷ 1,6 l/min
Lunghezza tubo in gomma	Aspirazione 1500 mm Scarico 2050 mm
Pressione di alimentazione	8 ÷ 10 bar
Pressione massima serbatoio	0.45 bar
Peso netto	25 kg

0630/2720

€ 1150,00

ARGANO ELETTRICO A 12V IN CORRENTE CONTINUA

Motore a magneti permanenti, telaio in metallo, cavo resistente, con dispositivo anti svolgimento del cavo e guida cavo. Da utilizzare esclusivamente per il tiro orizzontale, non adatto al sollevamento.

Tiro nominale orizzontale	2720 kg
Velocità	1,3 - 4,5 m / min
Motore	12 V 1,3 kW 1,8 hp
Riduzione	294:1
Dimensioni cavo	Ø 7,2 mm x 32 m
Dimensioni tamburo	Ø 63 x 228 mm
Dimensioni ingombro	520 x 180 x 175h mm
Peso netto	29 kg

**0630/2200**

€ 851,00

ARGANO ELETTRICO A 12V IN CORRENTE CONTINUA

Motore a magneti permanenti, telaio in metallo, cavo resistente, con dispositivo anti svolgimento del cavo e guida cavo. Da utilizzare esclusivamente per il tiro orizzontale, non adatto al sollevamento.

Tiro nominale orizzontale	2000 kg
Velocità	1,5 - 3,6 m / min
Motore	12 V 1,0 kW 1,3 hp
Rapporto riduzione ingranaggi	172:1
Dimensioni cavo	Ø 6,4 mm x 14,5 m
Dimensioni tamburo	Ø 45 x 97 mm
Dimensioni ingombro	364 x 126 x 141h mm
Peso netto	13 kg

**0630/0900**

€ 345,00

ARGANO ELETTRICO A 12V IN CORRENTE CONTINUA

Motore a magneti permanenti, telaio in metallo, gancio con puleggia per tiro doppio, cavo resistente, con dispositivo anti svolgimento del cavo e guida cavo. Da utilizzare esclusivamente per il tiro orizzontale, non adatto al sollevamento.

Tiro nominale orizzontale	450 / 900 kg
Velocità	1,3 - 3,2 m / min
Motore	12 V 0,7 kW 0,9 hp
Rapporto riduzione ingranaggi	153:1
Dimensioni cavo	Ø 4 mm x 15 m
Dimensioni tamburo	Ø 31,5 x 73 mm
Dimensioni ingombro	285 x 105 x 105h mm
Peso netto	6,7 kg



S029
€ 2890,00
SOLLEVATORE PER MOTO ELETTROIDRAULICO

Capacità di sollevamento	600 kg
Dimensioni piattaforma	2200 x 750 mm
Lunghezza totale	2995 mm
Dimensione botola	550 x 340 mm
Altezza di sollevamento	260 - 520 - 625 - 710 - 780 - 840 mm
Morsa	330 x 320 mm
Apertura morsa	40 ÷ 180 mm
Motore	230 V 50 Hz 550 W
Peso netto	225 kg

S029P
€ 3130,00
SOLLEVATORE PER MOTO ELETTROIDRAULICO

Con pompa e sistema di comando separato che danno la possibilità di posizionarlo a filo pavimento.



Capacità di sollevamento	600 kg
Dimensioni piattaforma	2200 x 750 mm
Lunghezza totale	2995 mm
Dimensione botola	550 x 340 mm
Altezza di sollevamento	215 - 520 - 625 - 710 - 780 - 840 mm
Morsa	330 x 320 mm
Apertura morsa	40 ÷ 180 mm
Motore	230 V 50 Hz 550 W
Peso netto	240 kg

S027
€ 2630,00
SOLLEVATORE PER MOTO ELETTROIDRAULICO

Capacità di sollevamento	600 kg
Dimensioni piattaforma	1800 x 600 mm
Lunghezza totale	2600 mm
Dimensione botola	550 x 340 mm
Altezza di sollevamento	260 ÷ 880 mm
Morsa	330 x 320 mm
Apertura morsa	40 ÷ 200 mm
Motore	230 V 50 Hz 550 W
Peso netto	150 kg

S027ATV
€ 3500,00
SOLLEVATORE PER MOTO E QUAD ELETTROIDRAULICO

Capacità di sollevamento	600 kg
Dimensioni piattaforma	1800 x 1200 mm
Lunghezza totale	2600 mm
Dimensione botola	550 x 340 mm
Altezza di sollevamento	260 ÷ 880 mm
Morsa	330 x 320 mm
Apertura morsa	40 ÷ 200 mm
Motore	230 V 50 Hz 550 W
Peso netto	235 kg

**S008/M**

€ 1060,00

SOLLEVATORE IDRAULICO

Per moto con pompa a pedale.



Capacità di sollevamento	400 kg
Dimensioni piattaforma	1825 x 660 mm
Lunghezza totale	2500 mm
Altezza di sollevamento	195 ÷ 750 mm
Morsa	410 x 100 mm
Apertura morsa	210 x 50 mm
Peso netto	133 kg

0452

€ 174,00

SOLLEVATORE A PANTOGRAFO PER MOTO

Da usare su ponte o a terra per riparare o fare manutenzione alla moto, con 2 supporti scorrevoli regolabili in altezza e removibili.



Capacità di sollevamento	400 kg
Dimensioni piattaforma	450 x 150 mm
Altezza di sollevamento	95 ÷ 400 mm
Altezza supporto	55 - 80 mm
Esagono	22 mm
Peso netto	14 kg

0241

€ 113,00

CAVALLETTO ANTERIORE PER MOTO

Struttura solida, comoda e di semplice utilizzo, regolazione dimensione ruota, bloccaggio di sicurezza.



Diametro esterno ruota	381 - 533 mm
Dimensioni ingombro	730 x 468 x 440h mm
Peso netto	10 kg

S013

€ 2080,00

SOLLEVATORE IDRAULICO

Per moto e quad con pompa a pedale e pneumatica.



Capacità di sollevamento	600 kg
Dimensioni piattaforma	2000 x 1220 mm
Lunghezza totale	2575 mm
Altezza di sollevamento	185 ÷ 825 mm
Peso netto	230 kg

0430

€ 292,00

CARRELLO SPOSTA MOTO

In acciaio, verniciato a polvere, idoneo per le moto e gli scooter con cavalletto laterale.



Portata max	300 kg
Lunghezza	1929 mm
Peso netto	33 kg

0217

€ 226,00

SOLLEVATORE POSIZIONATORE PER AUTO

Con freni di bloccaggio posizionatore.



Capacità	680 kg
Corsa laterale	370 mm
Distanza di lavoro	710 - 340 mm
Larghezza max pneumatico	325 mm
Dimensioni ingombro	730 x 468 x 440h mm
Peso netto	15 kg

S017
€ 252,00
SUPPORTO UNIVERSALE TELESCOPICO

Regolabile in altezza ed in lunghezza, costruito in tubi quadrati di acciaio, dopo l'uso si può riporre in poco spazio, piani di appoggio rivestiti in gomma antigraffio, 4 ruote girevoli di cui 2 con freno, adatto a lavori di carrozzeria per riparazioni, preparazione e verniciatura.



Altezza min - max	840 ÷ 1320 mm
Lunghezza	225 ÷ 1380 mm
Larghezza	860 mm
Portata	100 kg
Peso netto	26 kg

0645/CC
€ 105,00
SGABELLO CON 3 CASSETTI

Dotato di 3 cassette su cuscinetti, 3 portabombole e vassoio porta minuterie, 4 ruote pivotanti.



Dimensioni	370 x 400 x 367h mm
Dimensioni cassetto	3 - 150 x 300 x 40 h mm
Peso netto	8 kg

0645/C
€ 69,50
CARRELLO SOTTAUTO A 6 RUOTE

Dimensioni	1030 x 420 x 100h mm
Peso netto	6,5 kg

0645/S
€ 62,20
SGABELLO PER OFFICINA

Con ruote pivotanti, basamento porta attrezzi, seduta con imbottitura.



Dimensioni	440 x 375 x 400 mm
Peso netto	4,2 kg

0645/CP
€ 77,40
CARRELLO SOTTAUTO IN PLASTICA

Antiurto, con 6 ruote.



Dimensioni	1000 x 470 x 120h mm
Peso netto	4,8 kg

0645/SS
€ 76,40
CARRELLO SGABELLO SOTTAUTO 2 IN 1

Dimensioni carrello	1020 x 410 x 150h mm
Dimensioni sgabello	550 x 410 x 500h mm
Peso netto	9 kg



0256-

CRIC IDRAULICO A PROFILO RIBASSATO



Art.	€	Portata max	Pressione di esercizio	Altezza min-max sollevabile	Stelo	Corsa pistone	Dimensioni	Peso netto
0256/05	€ 63,60	5 ton	63 Mpa	33 ÷ 39 mm	ø 24 mm	6 mm	45 x 95 mm	0,6 kg
0256/10	€ 108,00	10 ton	63.7 Mpa	44 ÷ 55 mm	ø 38 mm	11 mm	56 x 118 mm	1,3 kg
0256/20	€ 133,00	20 ton	63.7 Mpa	52 ÷ 63 mm	ø 50 mm	11 mm	76 x 138 mm	2,6 kg
0256/30	€ 146,00	30 ton	63.7 Mpa	60 ÷ 72 mm	ø 63 mm	12 mm	95 x 158 mm	4,4 kg
0256/50	€ 208,00	50 ton	63.7 Mpa	66 ÷ 78 mm	ø 70 mm	12 mm	118 x 186 mm	6,7 kg

0062-

CRIC A BOTTIGLIA

Cric idraulico, garantisce un'ottima stabilità grazie alle sue ridotte dimensioni, facile da trasportare e da utilizzare.



Art.	€	Portata	Altezza min.	Alzata	Regolazione	Dimensioni base	Diametro pistone	Peso netto
0062/2	€ 28,90	2 ton	181 mm	116 mm	48 mm	90 x 85 mm	ø 22 mm	2,7 kg
0062/5	€ 45,00	5 ton	220 mm	127 mm	70 mm	115 x 100 mm	ø 32 mm	4,3 kg
0062/10	€ 60,50	10 ton	230 mm	150 mm	80 mm	125 x 110 mm	ø 40 mm	6,5 kg
0062/15	€ 89,20	15 ton	230 mm	150 mm	80 mm	140 x 135 mm	ø 48 mm	8,3 kg
0062/20	€ 102,00	20 ton	242 mm	150 mm	60 mm	155 x 145 mm	ø 53 mm	10,5 kg
0062/32	€ 195,00	32 ton	285 mm	180 mm	-	170 x 160 mm	ø 56 mm	13,5 kg
0062/50	€ 336,00	50 ton	295 mm	180 mm	-	215 x 175 mm	ø 85 mm	29 kg



0010
€ 936,00
CARRELLO REGOLABILE IN ALTEZZA

A pantografo con maniglia ripiegabile, dotato di sistema di bloccaggio meccanico della piattaforma e ruote pivotanti con freno.



Portata	500 kg
Dimensioni tavola	850 x 500 x 50 mm
Alzata	290 ÷ 880 mm
Peso netto	86 kg

0075
€ 856,00
CARRELLO REGOLABILE IN ALTEZZA

A pantografo con maniglia ripiegabile dotato di sistema di bloccaggio meccanico della piattaforma, ruote pivotanti con freno.



Portata	300 kg
Dimensioni tavola	850 x 500 x 50 mm
Alzata	290 ÷ 880 mm
Peso netto	78 kg

0467
€ 1110,00
CARRELLO REGOLABILE IN ALTEZZA

A doppio pantografo con maniglia fissa. Dotato di sistema di bloccaggio meccanico della piattaforma e ruote pivotanti con freno.



Portata	350 kg
Dimensioni tavola	910 x 500 x 53 mm
Alzata	370 ÷ 1300 mm
Peso netto	92 kg





C650

€ 198,00

CARRELLO A 3 VASCHE

Robusto e pratico da assemblare, 2 ruote fisse e 2 ruote girevoli.



Dimensioni	800 x 450 x 800h mm
Spessore lamiera	1,5 mm
Ruote	ø 80 mm
Portata	100 kg
Peso netto	17 kg

C750

€ 325,00

CARRELLO A 3 VASCHE

Robusto e pratico da assemblare, 2 ruote fisse e 2 ruote girevoli.



Dimensioni	940 x 600 x 870h mm
Spessore lamiera	2,3 mm
Ruote	ø 150 mm
Portata	200 kg
Peso netto	52 kg

C065/2

€ 208,00

CARRELLO A 2 VASCHE POLIPROPILENE

Leggero, robusto e pratico da assemblare, 2 ruote fisse e 2 ruote girevoli.



Dimensioni	1010 x 440 x 840h mm
Ruote	ø 125 mm
Portata	250 kg
Temperatura di esercizio	-20°C a +50°C
Peso netto	15,5 kg

C075/2

€ 273,00

CARRELLO A 2 VASCHE POLIPROPILENE

Leggero, robusto e pratico da assemblare, 2 ruote fisse e 2 ruote girevoli.



Dimensioni	1170 x 652 x 840h mm
Ruote	ø 125 mm
Portata	250 kg
Peso netto	22,5 kg

C009

€ 439,00

CARRELLO CON PIANO IN LEGNO

In acciaio, con 2 ruote fisse e 2 ruote girevoli con freno.



Dimensioni ingombro	1000 x 800 x 810 h mm
Spessore lamiera	2 mm
Spessore piano	36 mm
Ruote	ø 150 mm
Portata	150 kg
Peso netto	52 kg

Cx

CARRELLO CON PIATTAFORMA IN PVC

Manico pieghevole, 2 ruote fisse e 2 ruote girevoli.



Art.	€	Ruote	Portata	Dimensioni piattaforma	Altezza	Peso netto
C150	€ 77,40	Ø 100 mm	150 kg	700 x 450 mm	820 mm	7,8 kg
C300	€ 205,00	Ø 125 mm	300 kg	900 x 600 mm	890 mm	13,4 kg

C170P
€ 52,30 NEW
CARRELLO IN ALLUMINIO SALVASPAZIO

In posizione chiusa ruote e pedana sono ripiegate sul carrello. Apertura semplice tramite pressione sulla pedana. Blocco automatico in posizione aperta. Struttura telescopica e pedana in alluminio.



Dimensioni ruota	Ø 125 x 28 mm
Diametro foro	6 mm
Portata	70 kg
Dimensioni pala	385 x 275 mm
Peso netto	3,00 kg
Dimensioni	385 x 410 x 985 h mm
Dimensioni ingombro	385 x 55 x 635 h mm

C1101
€ 47,00 NEW
CARRELLO CON RUOTE PIENE

Per vasi e scatole, con manopole antinfortunistiche, verniciatura epossidica.



Dimensioni ruota	Ø 200 x 40 mm
Diametro foro	12 mm
Portata	80 kg
Dimensioni pala	350 x 180 mm
Peso netto	5,70 kg
Dimensioni	460 x 370 x 1000 h mm

C1102
€ 102,00 NEW
CARRELLO GOMMATO

Per vasi e scatole, con manopole antinfortunistiche, verniciatura epossidica.



Ruote pneumatiche	Ø 260 x 85 mm
Portata	200 kg
Dimensioni pala	450 x 215 mm
Peso netto	8,5 kg

C182
€ 208,00
CARRELLO GOMMATO

In alluminio.



Ruote pneumatiche	Ø 260 x 85 mm
Portata	200 kg
Dimensioni pala	300 x 205 mm
Peso netto	6 kg

C189
€ 104,00
CARRELLO MULTIUSO

Gommato per il trasporto di legna, vasi, scatole e oggetti vari. Robusto, maneggevole e versatile. Manici di sicurezza in plastica.



Ruote pneumatiche	Ø 260 x 85 mm
Portata	150 kg
Dimensioni pala	400 x 250 mm
Dimensioni pala mobile	340 x 390 mm
Peso netto	11,5 kg

C183
€ 115,00 NEW
CARRELLO SALISCALE CON 3 RUOTE

Con manopole antinfortunistiche, verniciatura epossidica.



Dimensioni ruota	Ø 155 x 42 mm
Diametro foro	16 mm
Portata	200 kg
Dimensioni pala	310 x 220 mm
Peso netto	13,5 kg
Dimensioni	500 x 620 x 1180 h mm



C184 € 105,00 **NEW**

CARRELLO 2-IN-1

Utilizzabile in due posizioni per agevolare la movimentazione di carichi pesanti e voluminosi.



Ruote pneumatiche	Ø 260 x 83 mm
Ruote sterzanti	Ø 100 x 23 mm
Diametro foro	20 mm - 10 mm
Portata	250 kg
Dimensioni pala	390 x 140 mm
Dimensioni pala mobile	325 x 335 mm
Dimensioni piattaforma	380 x 850 mm
Peso netto	12 kg
Dimensioni	590 x 420 x 1117 h mm - 590 x 1117 x 1050 h mm

P019 € 184,00

PIATTAFORMA ANTISCIVOLO PIEGHEVOLE

In alluminio, professionale e di facile uso, ideale per una vasta gamma di lavori in diversi settori, da quello domestico a quello auto.



Portata	150 kg
Dimensioni	1260x380x500 mm
Dimensioni piattaforma	950x300 mm
Peso netto	7,5 kg

0237-
PARANCO A LEVA



Art.	€	Portata	Alzata	Peso netto
0237/05	€ 208,00	500 kg	1500 mm	5 kg
0237/15	€ 309,00	1500 kg	1500 mm	10 kg

0461 € 22,80

RUOTA IN POLIURETANO

Non perforabile di dimensioni 260 x 85 mm, con cuscinetti a rulli, foro Ø 20 mm e riduzione da 20 mm a 18 mm, per carrelli con albero ruota 18-20 mm.



Dimensioni ruota	250 x 75 mm
Dimensioni foro	Ø 20 - 18 x 74 mm

0056-
PARANCO A CATENA



Art.	€	Portata	Alzata	Peso netto
0056/1	€ 172,00	1000 kg	3000 mm	11 kg
0056/2	€ 256,00	2000 kg	3000 mm	20 kg

0236 € 101,00
SUPPORTO A BANDIERA



Portata	300 kg
Lunghezza braccio	750 mm
Interasse fori	380 mm
Sezione	45 X 45 mm ²
Peso netto	6 kg

0602
€ 315,00
PARANCO ELETTRICO

Con fune in acciaio e finecorsa meccanico.



Portata	200 / 400 kg
Lunghezza cavo	18 m
Velocità	8 m/min
Motore	230 V 50 Hz 1 kW
Peso netto	16,7 kg

0600
€ 351,00
PARANCO ELETTRICO

Con fune in acciaio e finecorsa meccanico.



Portata	200 / 400 kg
Lunghezza cavo	18 m
Velocità	8 m / min
Motore	230 V 50 Hz 0,75 kW
Peso netto	16,7 kg

Sx
SOLLEVATORE MAGNETICO

Neodimio.

Art.	€	Portata max	Portata barre tonde	Diametro min-max sollevabile	Dimensioni	Peso netto
S0300	€ 636,00	300 kg	100 kg	50 ÷ 300 mm	189 x 163 x 92 (B) mm	9,5 kg
S0600	€ 995,00	600 kg	200 kg	70 ÷ 400 mm	267 x 198 x 129 (B) mm	19 kg
S1000	€ 1500,00	1000 kg	330 kg	75 ÷ 450 mm	350 x 277 x 156 (B) mm	36 kg

PDC4-
PENDENTI DI CATENA

"Nera" in acciaio legato a 4 bracci gr 80 con gancio accorciatore, coefficiente di sicurezza 4:1, la portata verticale è calcolata solo su 3 bracci in quanto il quarto braccio è solo per equilibrare il carico. EN 818-4.



Art.	€	Lunghezza	Portata 0°	Portata 45°	Catena	Gancio
PDC4/7/2	€ 466,00	2000 mm	3150	2240	ø 7 mm	SLF
PDC4/7/3	€ 538,00	3000 mm	3150	2240	ø 7 mm	SLF
PDC4/7/4	€ 607,00	4000 mm	3150	2240	ø 7 mm	SLF
PDC4/10/2	€ 926,00	2000 mm	6700	4750	ø 10 mm	SLF
PDC4/10/3	€ 1020,00	3000 mm	6700	4750	ø 10 mm	SLF
PDC4/10/4	€ 1160,00	4000 mm	6700	4750	ø 10 mm	SLF





PDC2-

PENDENTI DI CATENA

“Nera” in acciaio legato a 2 bracci gr 80, con ganci accorciatori, coefficiente di sicurezza 4:1. EN 818-4.



Art.	€	Lunghezza	Portata 0°	Portata 45°	Catena	Gancio
PDC2/7/2	€ 226,00	2000 mm	2120	1500	ø 7 mm	SLF
PDC2/7/3	€ 240,00	3000 mm	2120	1500	ø 7 mm	SLF
PDC2/7/4	€ 271,00	4000 mm	2120	1500	ø 7 mm	SLF
PDC2/10/2	€ 346,00	2000 mm	4250	3150	ø 10 mm	SLF
PDC2/10/3	€ 382,00	3000 mm	4250	3150	ø 10 mm	SLF
PDC2/10/4	€ 459,00	4000 mm	4250	3150	ø 10 mm	SLF



PDC1-

PENDENTI DI CATENA

“Nera” in acciaio legato a 1 braccio gr 80, con gancio accorciatore, coefficiente di sicurezza 4:1. EN 818-4.



Art.	€	Lunghezza	Portata verticale	Catena	Gancio
PDC1/7/1	€ 91,80	1000 mm	1500 kg	ø 7 mm	SLF
PDC1/7/2	€ 105,00	2000 mm	1500 kg	ø 7 mm	SLF
PDC1/10/1	€ 137,00	1000 mm	3150 kg	ø 10 mm	SLF
PDC1/10/2	€ 161,00	2000 mm	3150 kg	ø 10 mm	SLF



06x

SISTEMA DI ANCORAGGIO CON NASTRO IN POLIESTERE

EN 12195-2.



Art.	€	Nastro con tenditore	Larghezza nastro	Portata	Ganci
0635	€ 32,30	5,50 + 0,50 m	35 mm	1000 kg	2
0650	€ 45,00	8,00 + 0,50 m	50 mm	2000 kg	2
0675	€ 226,00	10,00 + 1,00 m	75 mm	3000 kg	2

0635/25

€ 15,70

SISTEMA DI ANCORAGGIO CON NASTRO IN POLIESTERE

EN 12195-2.



Nastro da mm 25 con tenditore e 2 ganci	4,00 + 0,30 m
Portata	250 kg

AN2G/12/1

€ 97,40

PENDENTE A 2 BRACCI IN ACCIAIO



Fune	ø 12 mm
Lunghezza	1000 mm
Portata	30° 2600 kg
Portata	90° 2100 kg

x-1000
BRACHE PIATTE IN POLIESTERE COLORATO

Brache piatte in poliestere colorato a doppio strato, asole rivestite, coefficiente di sicurezza 7:1. EN 1492-1.

Art.	€	m	Larghezza	Colore	Lungh. asole	Portata verticale	Portata canestro	Portata canestro β 45° kg	Portata canestro β 60° kg	Portata cappio
1/1000	€ 15,60	1	50 mm	Viola	250 mm	1000 kg	2000 kg	1400	1000	800 kg
2/1000	€ 20,90	2	50 mm	Viola	250 mm	1000 kg	2000 kg	1400	1000	800 kg
3/1000	€ 24,70	3	50 mm	Viola	250 mm	1000 kg	2000 kg	1400	1000	800 kg
4/1000	€ 29,90	4	50 mm	Viola	250 mm	1000 kg	2000 kg	1400	1000	800 kg

x-2000
BRACHE PIATTE IN POLIESTERE COLORATO

A doppio strato, asole rivestite, coefficiente di sicurezza 7:1. EN 1492-1.

Art.	€	m	Larghezza	Colore	Lungh. asole	Portata verticale	Portata canestro	Portata canestro β 45° kg	Portata canestro β 60° kg	Portata cappio
1/2000	€ 20,00	1	60 mm	Verde	250 mm	2000 kg	4000 kg	2800	2000	1600 kg
2/2000	€ 28,60	2	60 mm	Verde	250 mm	2000 kg	4000 kg	2800	2000	1600 kg
3/2000	€ 37,20	3	60 mm	Verde	250 mm	2000 kg	4000 kg	2800	2000	1600 kg
4/2000	€ 45,00	4	60 mm	Verde	250 mm	2000 kg	4000 kg	2800	2000	1600 kg
5/2000	€ 56,60	5	60 mm	Verde	250 mm	2000 kg	4000 kg	2800	2000	1600 kg
6/2000	€ 66,30	6	60 mm	Verde	250 mm	2000 kg	4000 kg	2800	2000	1600 kg

x-3000
BRACHE PIATTE IN POLIESTERE COLORATO

A doppio strato, asole rivestite, coefficiente di sicurezza 7:1. EN 1492-1.

Art.	€	m	Larghezza	Colore	Lungh. asole	Portata verticale	Portata canestro	Portata canestro β 45° kg	Portata canestro β 60° kg	Portata cappio
1/3000	€ 27,30	1	90 mm	Giallo	300 mm	3000 kg	6000 kg	4200	3000	2400 kg
2/3000	€ 38,60	2	90 mm	Giallo	300 mm	3000 kg	6000 kg	4200	3000	2400 kg
3/3000	€ 54,00	3	90 mm	Giallo	300 mm	3000 kg	6000 kg	4200	3000	2400 kg
4/3000	€ 66,30	4	90 mm	Giallo	300 mm	3000 kg	6000 kg	4200	3000	2400 kg
5/3000	€ 76,40	5	90 mm	Giallo	300 mm	3000 kg	6000 kg	4200	3000	2400 kg
6/3000	€ 89,20	6	90 mm	Giallo	300 mm	3000 kg	6000 kg	4200	3000	2400 kg

FTx-1000
FUNI TONDE IN POLIESTERE

Anello chiuso con calza esterna, coefficiente di sicurezza 7:1. EN 1492-2.

Art.	€	Anello	Colore	Verticale	Portata canestro	Portata canestro β 45° kg	Portata canestro β 60° kg	Portata cappio
FT1/1000	€ 7,90	1 m	Viola	1000 kg	2000 kg	1400	1000	800 kg
FT2/1000	€ 11,10	2 m	Viola	1000 kg	2000 kg	1400	1000	800 kg
FT3/1000	€ 15,70	3 m	Viola	1000 kg	2000 kg	1400	1000	800 kg
FT4/1000	€ 20,20	4 m	Viola	1000 kg	2000 kg	1400	1000	800 kg
FT5/1000	€ 24,70	5 m	Viola	1000 kg	2000 kg	1400	1000	800 kg
FT6/1000	€ 29,40	6 m	Viola	1000 kg	2000 kg	1400	1000	800 kg

FTx-2000
FUNI TONDE IN POLIESTERE

Anello chiuso con calza esterna, coefficiente di sicurezza 7:1. EN 1492-2.

Art.	€	Anello	Colore	Verticale	Portata canestro	Portata canestro β 45° kg	Portata canestro β 60° kg	Portata cappio
FT1/2000	€ 11,10	1 m	Verde	2000 kg	4000 kg	2800	2000	1600 kg
FT2/2000	€ 13,70	2 m	Verde	2000 kg	4000 kg	2800	2000	1600 kg
FT3/2000	€ 23,00	3 m	Verde	2000 kg	4000 kg	2800	2000	1600 kg
FT4/2000	€ 29,20	4 m	Verde	2000 kg	4000 kg	2800	2000	1600 kg
FT5/2000	€ 32,40	5 m	Verde	2000 kg	4000 kg	2800	2000	1600 kg
FT6/2000	€ 38,60	6 m	Verde	2000 kg	4000 kg	2800	2000	1600 kg

FTx-3000
FUNI TONDE IN POLIESTERE

Anello chiuso con calza esterna coefficiente di sicurezza 7:1. EN 1492-2.

Art.	€	Anello	Colore	Verticale	Portata canestro	Portata canestro β 45° kg	Portata canestro β 60° kg	Portata cappio
FT1/3000	€ 13,70	1 m	Giallo	3000 kg	6000 kg	4200	3000	2400 kg
FT2/3000	€ 20,30	2 m	Giallo	3000 kg	6000 kg	4200	3000	2400 kg
FT3/3000	€ 29,20	3 m	Giallo	3000 kg	6000 kg	4200	3000	2400 kg
FT4/3000	€ 38,00	4 m	Giallo	3000 kg	6000 kg	4200	3000	2400 kg
FT5/3000	€ 44,30	5 m	Giallo	3000 kg	6000 kg	4200	3000	2400 kg
FT6/3000	€ 55,50	6 m	Giallo	3000 kg	6000 kg	4200	3000	2400 kg





0791-

ARGANO MANUALE A FUNE

Per il tiro ed il sollevamento.



Art.	€	Tiro massimo	Cavo	Peso netto
0791/08	€ 409,00	800 kg	ø 8,3 mm x 20m	11 kg
0791/16	€ 553,00	1600 kg	ø 11 mm x 20m	24 kg
0791/32	€ 1080,00	3200 kg	ø 16 mm x 20m	50 kg

0066

€ 38,30

TENDI CAVO CON DOPPIO CRICCHETTO



Tiro massimo	800 kg
Diametro cavo	ø 5 mm
Lunghezza massima	2 m
Peso netto	2,7 kg

0070/C

€ 50,30

ARGANO MANUALE

Zincato con cavo e gancio. Manovella ergonomica.



Tiro massimo	500 kg
Larghezza gola	50 mm
Diametro esterno rocchetto	133 mm
Diametro minimo rocchetto	40 mm
Dimensioni cavo	ø 4,5 mm x 10 m
Dimensioni base	140 x 90 mm

0070

€ 38,70

ARGANO MANUALE

Struttura in acciaio zincato. Manovella ergonomica.



Tiro massimo	500 kg
Larghezza gola	50 mm
Diametro esterno rocchetto	133 mm
Diametro minimo rocchetto	40 mm
Dimensioni base	140 x 90 mm

0590

€ 81,20

ARGANO MANUALE CON FRENO



Tiro massimo	450 kg
Larghezza gola	49 mm
Diametro esterno rocchetto	110 mm
Diametro minimo rocchetto	45 mm
Dimensioni ingombro senza leva	170 x 150 x 125h mm



0068/S
€ 3850,00
TRANSPALLET CON BILANCIA E STAMPANTE

Non idonei nei rapporti con terzi, funzione tara alimentazione con batteria ricaricabile, battistrada in poliuretano.



Portata	2000 kg
Capacità pesatura	2000 kg
Altezza forche	88 ÷ 200 mm
Dimensioni forche	1150 x 568 mm
Lettura	1 kg
Precisione	±2 kg
Stampante	Si
Ruota anteriore	Doppia
Peso netto	160 kg

0068L
€ 2570,00
TRANSPALLET CON BILANCIA

Transpallet con bilancia non idonei nei rapporti con terzi, funzione tara alimentazione con batterie sostituibili.



Portata	2000 kg
Capacità pesatura	2000 kg
Altezza forche	85 ÷ 175 mm
Dimensioni forche	1150 x 570 mm
Lettura	0,5 kg
Precisione	±0,05% kg
Ruota anteriore	Doppia
Peso netto	125 kg

0028R
€ 753,00
TRANSPALLET MANUALE RIBASSATO

Con battistrada in poliuretano.



Portata	2500 kg
Altezza forche	63 ÷ 165 mm
Dimensioni forche	1150 x 540 mm
Spessore telaio	3 mm
Ruota anteriore	Doppia
Peso netto	68,5 kg

0028
€ 655,00
TRANSPALLET MANUALE

Con battistrada in poliuretano.



Portata	2500 kg
Altezza forche	85 ÷ 200 mm
Dimensioni forche	1150 x 540 mm
Spessore telaio	3 mm
Ruota anteriore	Doppia
Peso netto	71,5 kg

0028-XL
NEW
TRANSPALLET MANUALE A FORCHE LUNGHE

Con battistrada in poliuretano.



Art.	€	Portata	Altezza forche	Dimensioni forche	Spessore telaio	Ruota anteriore	Peso netto
0028/1500	€ 865,00	2000 kg	85 ÷ 200 mm	1500 x 540 mm	3 mm	Doppia	86 kg
0028/1800	€ 887,00	2000 kg	85 ÷ 200 mm	1800 x 540 mm	3 mm	Doppia	96 kg
0028/2000	€ 911,00	2000 kg	85 ÷ 200 mm	2000 x 540 mm	3 mm	Doppia	102 kg



0064

€ 757,00

TRANSPALLET MANUALE

Con battistrada in poliuretano.



Portata	2500 kg
Altezza forche	85 ÷ 200 mm
Dimensioni forche	900 x 540 mm
Spessore telaio	3 mm
Ruota anteriore	Singola
Peso netto	68,5 kg

S2/800

€ 1310,00

SOLLEVATORE PER PALLETS

A pantografo.



Portata	1000 kg
Altezza forche	85 ÷ 800 mm
Dimensioni forche	1170 x 540 mm
Battistrada	Poliuretano
Ruota anteriore	Singola
Peso netto	117 kg

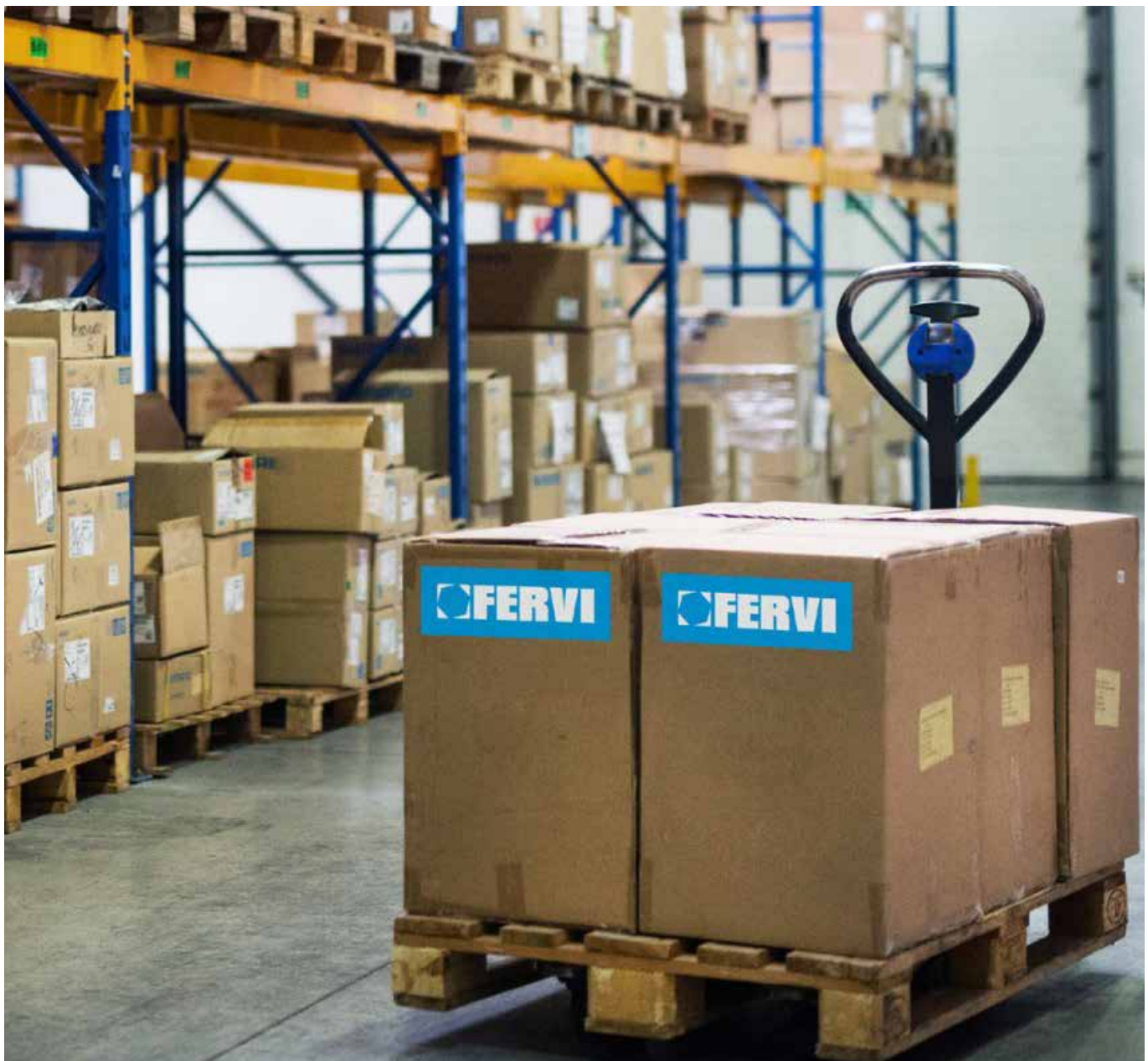

0782
€ 1240,00
SOLLEVATORE CON PIATTAFORMA E FORCHE

Portata	400 kg
Altezza forche	85 ÷ 1500 mm
Dimensioni forche	545 x 650 mm
Piattaforma	576 x 650 mm
Ruote sterzanti	Ø 127 x 40 mm
Ruote fisse	Ø 75 x 40 mm
Battistrada	Poliuretano
Dimensioni	1100 x 600 x 1725h mm
Peso netto	95 kg

0143A
€ 2100,00
SOLLEVATORE PER PALLET

Con freno e pedale di sollevamento.



Portata	1000 kg
Altezza forche	90 ÷ 1600 mm
Dimensioni forche	1150 x 550 mm
Sezione forche	160 x 55 mm
Altezza montante	2100 mm
Battistrada	Poliuretano
Ruota anteriore	Doppia
Dimensioni	920 x 1670 x 2100h mm
Peso netto	250 kg

0143/25
€ 2320,00
SOLLEVATORE MANUALE PER PALLET

Con montante telescopico doppio, freno e pedale di sollevamento.



Portata	1000 / 800 kg
Altezza forche	75 ÷ 1600 ÷ 2500 mm
Dimensioni forche	1150 x 550 mm
Sezione forche	160 x 55 mm
Altezza montante	1840 mm
Battistrada	Poliuretano
Ruota anteriore	Doppia
Dimensioni	1670 x 920 x 1840h mm
Peso netto	310 kg





0654-xL

CARRELLI DA TRASPORTO

Carrelli da trasporto con ruote in nylon dotato di occhiello per traino.



Art.	€	Capacità	Altezza utile	Dimensioni rulli	Ruote	Dimensioni appoggio	Lunghezza timone	Angolo di sterzata	Dimensioni	Peso netto
0654/06L	€ 627,00	6 Ton	110 mm	85 x 85 mm	8	Ø 170 mm	1080 mm	±90°	610 x 520 mm	41 kg
0654/09L	€ 702,00	9 Ton	110 mm	85 x 85 mm	12	Ø 170 mm	1080 mm	±90°	840 x 583 mm	59 kg
0654/12L	€ 978,00	12 Ton	110 mm	85 x 85 mm	16	Ø 170 mm	1080 mm	±90°	1030 x 620 mm	80 kg

0654-xF

CARRELLI DA TRASPORTO

Con ruote in nylon.



Art.	€	Capacità	Altezza utile	Dimensioni rulli	Ruote	Dimensioni appoggio	Lunghezza barra	Peso netto
0654/06F	€ 427,00	6 Ton	110 mm	85 x 85 mm	4	200 x 220 mm	640 ÷ 1030 mm	30 kg
0654/09F	€ 571,00	9 Ton	110 mm	85 x 85 mm	6	200 x 320 mm	840 ÷ 1230 mm	43 kg
0654/12F	€ 650,00	12 Ton	110 mm	85 x 85 mm	8	200 x 407 mm	1104 ÷ 1430 mm	52 kg

C030-

CONTENITORE RIBALTABILE PER TRUCIOLI CON RUOTE

Disponibili ulteriori colorazioni ed accessori su richiesta.

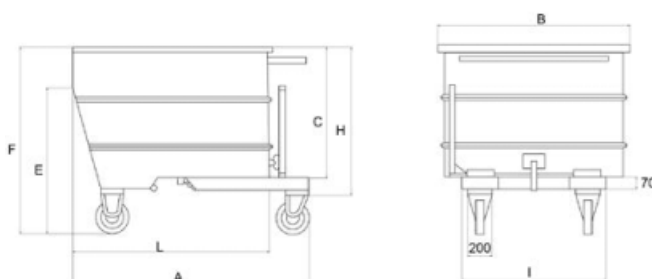











Art.	€	Litri	A	B	C	E	F	H	I	L	Portata	Ruote	Peso netto
C030/0300	€ 1670,00	300	1280 mm	820 mm	395 mm	530 mm	650 mm	490 mm	700 mm	1010 mm	600 kg	Ø 125 mm x 165h mm	95 kg
C030/0500	€ 1890,00	500	1280 mm	920 mm	600 mm	750 mm	915 mm	710 mm	800 mm	1010 mm	1000 kg	Ø 180 mm x 210h mm	130 kg
C030/0750	€ 2080,00	750	1280 mm	1070 mm	730 mm	800 mm	1035 mm	830 mm	800 mm	1055 mm	1350 kg	Ø 180 mm x 210h mm	150 kg
C030/1000	€ 2240,00	1000	1510 mm	1070 mm	870 mm	925 mm	1220 mm	975 mm	800 mm	1255 mm	1700 kg	Ø 200 mm x 245h mm	182 kg
C030/1350	€ 2580,00	1350	1510 mm	1320 mm	870 mm	925 mm	1220 mm	975 mm	800 mm	1255 mm	2000 kg	Ø 200 mm x 245h mm	205 kg





CHIAVI DI MANOVRA

- p. 394  --- Chiavi a cricchetto
- p. 395  --- Chiavi fisse
- p. 396  --- Chiavi combinate
- p. 398  --- Chiavi poligonali
- p. 401  --- Chiavi a tubo
- p. 403  --- Chiavi esagonali
- p. 405  --- Chiavi torx
- p. 407  --- Chiavi a T
- p. 408  --- Chiavi per filtro
- p. 409  --- Chiavi dinamometriche





CHIAVI A BUSSOLA ED ESTRATTORI

- p. 412  --- Leve a cricchetto
- p. 414  --- Chiavi a bussola
- p. 428  --- Chiavi a bussola ad impatto
- p. 436  --- Estrattori









GIRAVITI E RIVETTATRICI

- p. 437  --- Giraviti a bussola
- p. 439  --- Giraviti
- p. 443  --- Giraviti di precisione
- p. 445  --- Inserti e portainseriti
- p. 450  --- Rivettatrici a leva







PINZE, MARTELLI, LIME, LEVE E SCALPELLI

- p. 452  --- Pinze
- p. 456  --- Pinze grip e a morsetto
- p. 457  --- Pinze idrauliche e giratubo
- p. 458  --- Martelli e mazzuoli
- p. 461  --- Cacciaspine e scalpelli
- p. 464  --- Lime
- p. 466  --- Leve



CUTTER, SBAVATORI E FORBICI

- p. 467  --- Cutter
- p. 469  --- Sbavatori
- p. 471  --- Seghetti
- p. 472  --- Forbici e cesoie
- p. 473  --- Tagliatubi



ASSORTIMENTI E FISSAGGIO

- p. 476  --- Punti per fissatrici e chiodatrici
- p. 476  --- Assortimenti



EDILIZIA ED IMBALLAGGIO

- p. 481  --- Pistole per prodotti chimici
- p. 482  --- Cazzuole, spatole e frattoni
- p. 483  --- Materiale per imballaggio



SERIE DI UTENSILI

- p. 484  --- Carrelli con utensili
- p. 490  --- Serie di utensili in termoformati
- p. 499  --- Valigette con utensili

0690-
CHIAVE COMBINATA CON TESTA A CRICCHETTO SNODATA

Art.	€	Misura	Lunghezza
0690/08	€ 11,40	8 mm	150 mm
0690/09	€ 11,40	9 mm	150 mm
0690/10	€ 14,20	10 mm	160 mm
0690/11	€ 14,20	11 mm	170 mm
0690/12	€ 14,20	12 mm	170 mm
0690/13	€ 14,20	13 mm	185 mm
0690/14	€ 18,10	14 mm	205 mm
0690/15	€ 18,10	15 mm	205 mm
0690/16	€ 18,10	16 mm	230 mm
0690/17	€ 19,40	17 mm	230 mm
0690/18	€ 20,50	18 mm	250 mm
0690/19	€ 21,80	19 mm	250 mm

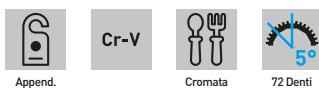
0700-
CHIAVI A CRICCHETTO

Art.	€	Misura	Lunghezza
0700/08	€ 9,00	8 mm	140 mm
0700/09	€ 9,10	9 mm	150 mm
0700/10	€ 9,20	10 mm	160 mm
0700/11	€ 10,10	11 mm	165 mm
0700/12	€ 10,50	12 mm	172 mm
0700/13	€ 11,20	13 mm	180 mm
0700/14	€ 12,00	14 mm	190 mm
0700/15	€ 12,70	15 mm	220 mm
0700/16	€ 13,50	16 mm	221 mm
0700/17	€ 14,90	17 mm	225 mm
0700/18	€ 15,30	18 mm	238 mm
0700/19	€ 15,90	19 mm	248 mm

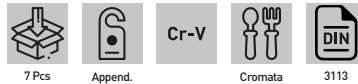
0690/07P
€ 104,00
SERIE CHIAVI COMBINATE CON TESTA A CRICCHETTO SNODATA

Misure

8 - 10 - 11 - 13 - 15 - 17 - 19 mm

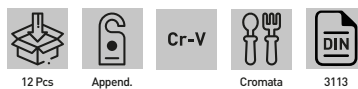
0690/12P
€ 166,00
SERIE CHIAVI COMBINATE CON TESTA A CRICCHETTO SNODATA

Misure

8 - 9 - 10 - 11 - 12 - 13 - 14 - 15 - 16 - 17 - 18 - 19 mm

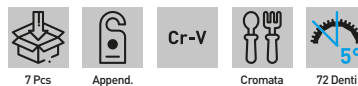
0700/07P
€ 72,80
SERIE CHIAVI COMBINATE CON TESTA A CRICCHETTO

Misure

8 - 10 - 11 - 13 - 15 - 17 - 19 mm

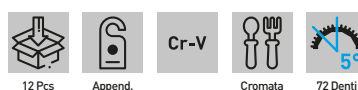
0700/12P
€ 131,00
SERIE CHIAVI COMBINATE CON TESTA A CRICCHETTO

Misure

8 - 9 - 10 - 11 - 12 - 13 - 14 - 15 - 16 - 17 - 18 - 19 mm





0546

€ 55,20

SERIE CHIAVI COMBinate SATINATE



Misure 6 - 7 - 8 - 9 - 10 - 11 - 12 - 13 - 14 - 17 - 19 - 22 mm

0544

€ 145,00

SERIE CHIAVI COMBinate SATINATE



Misure 6-7-8-9-10-11-12-13-14-15-16-17-18-19-20-21-22-23-24-25-26-27-28-30-32 mm

0201-

CHIAVI FISSE CROMATE, LUCIDATE A SPECCHIO



Art.	€	Misura	Lunghezza
0201/06X07	€ 2,09	6x7 mm	122 mm
0201/08X09	€ 2,73	8x9 mm	140 mm
0201/10X11	€ 2,73	10x11 mm	156 mm
0201/12X13	€ 3,93	12x13 mm	172 mm
0201/14X15	€ 3,93	14x15 mm	190 mm
0201/16X17	€ 4,86	16x17 mm	190 mm
0201/18X19	€ 5,90	18x19 mm	225 mm
0201/20X22	€ 6,70	20x22 mm	235 mm
0201/21X23	€ 7,90	21x23 mm	250 mm
0201/24X27	€ 8,50	24x27 mm	265 mm

Art.	€	Misura	Lunghezza
0201/25X28	€ 10,70	25x28 mm	280 mm
0201/30X32	€ 11,30	30x32 mm	300 mm
0201/32X36	€ 12,50	32x36 mm	325 mm
0201/34X36	€ 13,30	34x36 mm	325 mm
0201/35X38	€ 14,40	35x38 mm	330 mm
0201/36X41	€ 16,30	36x41 mm	360 mm
0201/41X46	€ 27,70	41x46 mm	400 mm
0201/46X50	€ 37,30	46x50 mm	450 mm
0201/50X55	€ 54,40	50x55 mm	485 mm
0201/55X60	€ 62,00	55x60 mm	520 mm

0200

€ 33,50

SERIE CHIAVI FISSE CROMATE, LUCIDATE A SPECCHIO



Misure 6x7 - 8x9 - 10x11 - 12x13 - 14x15 - 16x17 - 18x19 - 20x22 mm

0201

€ 77,50

SERIE CHIAVI FISSE CROMATE, LUCIDATE A SPECCHIO

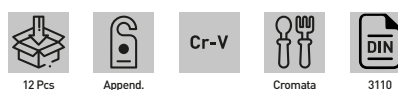

Misure 6x7 - 8x9 - 10x11 - 12x13 - 14x15 - 16x17 - 18x19 - 20x22 - 21x23 - 24x27 - 25x28 - 30x32 mm

0208-
CHIAVI COMBinate CROMATE, LUCIDATE A SPECCHIO

Art.	€	Misura	Lunghezza
0208/06	€ 3,93	6 mm	100 mm
0208/07	€ 3,93	7 mm	110 mm
0208/08	€ 3,93	8 mm	120 mm
0208/09	€ 3,93	9 mm	130 mm
0208/10	€ 4,02	10 mm	140 mm
0208/11	€ 4,02	11 mm	150 mm
0208/12	€ 4,02	12 mm	160 mm
0208/13	€ 4,02	13 mm	170 mm
0208/14	€ 6,00	14 mm	180 mm
0208/15	€ 6,00	15 mm	190 mm
0208/16	€ 6,00	16 mm	200 mm
0208/17	€ 6,70	17 mm	210 mm
0208/18	€ 6,70	18 mm	220 mm
0208/19	€ 7,90	19 mm	230 mm
0208/20	€ 9,80	20 mm	240 mm
0208/21	€ 9,80	21 mm	250 mm
0208/22	€ 11,30	22 mm	260 mm
0208/23	€ 11,90	23 mm	270 mm
0208/24	€ 12,80	24 mm	280 mm
0208/25	€ 12,80	25 mm	290 mm
0208/26	€ 12,80	26 mm	300 mm
0208/27	€ 14,00	27 mm	310 mm
0208/28	€ 14,00	28 mm	320 mm
0208/30	€ 14,00	30 mm	340 mm
0208/32	€ 16,00	32 mm	360 mm
0208/34	€ 17,10	34 mm	380 mm
0208/36	€ 18,20	36 mm	400 mm
0208/38	€ 20,10	38 mm	400 mm
0208/41	€ 25,80	41 mm	440 mm
0208/46	€ 35,30	46 mm	490 mm
0208/50	€ 41,20	50 mm	530 mm

0199P-
CHIAVI COMBinate CROMATE, LUCIDATE A SPECCHIO

Misure in pollici.



Art.	€	Misura	Lunghezza
0199P/1/4	€ 2,32	1/4"	100 mm
0199P/5/16	€ 2,54	5/16"	120 mm
0199P/3/8	€ 3,17	3/8"	140 mm
0199P/7/16	€ 3,28	7/16"	150 mm
0199P/1/2	€ 3,28	1/2"	170 mm
0199P/9/16	€ 4,13	9/16"	180 mm
0199P/5/8	€ 4,77	5/8"	200 mm
0199P/11/16	€ 4,98	11/16"	210 mm
0199P/3/4	€ 5,70	3/4"	230 mm
0199P/13/16	€ 6,70	13/16"	250 mm
0199P/7/8	€ 7,40	7/8"	260 mm
0199P/15/16	€ 10,70	15/16"	280 mm
0199P/1	€ 11,20	1"	290 mm

0199

€ 55,20

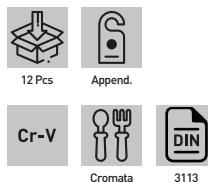
SERIE CHIAVI COMBinate CROMATE, LUCIDATE A SPECCHIO

Misure 6 - 7 - 8 - 9 - 10 - 11 - 12 - 13 - 14 - 17 - 19 - 22 mm

0208

€ 132,00

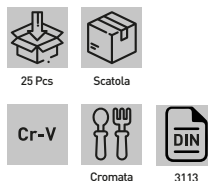
SERIE CHIAVI COMBinate CROMATE, LUCIDATE A SPECCHIO

Misure 6-7-8-9-10-11-12-13-14-15-16-17-18-19-20-21-22-23-24-25-26-27-28-30-32 mm

0204

€ 169,00

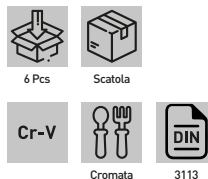
SERIE CHIAVI COMBinate CROMATE, LUCIDATE A SPECCHIO

Misure 34 - 36 - 38 - 41 - 46 - 50 mm

0199P

€ 65,30

SERIE CHIAVI COMBinate CROMATE, LUCIDATE A SPECCHIO

Misure in pollici.

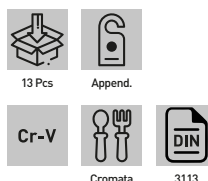

Misure 1/4" - 5/16" - 3/8" - 7/16" - 1/2" - 9/16" - 5/8" - 11/16" - 3/4" - 13/16" - 7/8" - 15/16" - 1"



0222-

CHIAVI FISSE



Cr-V

Satinata 3110

Art.	€	Misura	Lunghezza
0222/06X07	€ 1,44	6x7 mm	122 mm
0222/08X09	€ 1,67	8x9 mm	140 mm
0222/10X11	€ 1,90	10x11 mm	155 mm
0222/12X13	€ 2,14	12x13 mm	170 mm
0222/14X15	€ 2,27	14x15 mm	190 mm
0222/16X17	€ 2,74	16x17 mm	205 mm
0222/18X19	€ 3,10	18x19 mm	220 mm
0222/20X22	€ 3,57	20x22 mm	235 mm
0222/21X23	€ 4,77	21x23 mm	250 mm
0222/24X27	€ 7,90	24x27 mm	265 mm
0222/25X28	€ 7,90	25x28 mm	280 mm
0222/30X32	€ 8,60	30x32 mm	300 mm

0224-

CHIAVI COMBinate



Cr-V

Satinata 3113

Art.	€	Misura	Lunghezza
0224/06	€ 1,31	6 mm	100 mm
0224/07	€ 1,31	7 mm	110 mm
0224/08	€ 1,31	8 mm	120 mm
0224/09	€ 1,38	9 mm	130 mm
0224/10	€ 1,44	10 mm	140 mm
0224/11	€ 1,75	11 mm	150 mm
0224/12	€ 1,75	12 mm	160 mm
0224/13	€ 1,75	13 mm	170 mm
0224/14	€ 2,17	14 mm	180 mm
0224/15	€ 2,17	15 mm	190 mm
0224/16	€ 2,17	16 mm	200 mm
0224/17	€ 2,17	17 mm	210 mm
0224/18	€ 2,17	18 mm	220 mm
0224/19	€ 3,70	19 mm	230 mm
0224/20	€ 5,50	20 mm	240 mm
0224/21	€ 5,70	21 mm	250 mm
0224/22	€ 5,70	22 mm	260 mm
0224/23	€ 5,80	23 mm	270 mm
0224/24	€ 5,80	24 mm	280 mm
0224/25	€ 6,40	25 mm	290 mm
0224/26	€ 7,20	26 mm	300 mm
0224/27	€ 8,30	27 mm	310 mm
0224/28	€ 9,80	28 mm	320 mm
0224/30	€ 10,40	30 mm	340 mm
0224/32	€ 11,90	32 mm	360 mm
0224/34	€ 12,80	34 mm	380 mm
0224/36	€ 18,20	36 mm	400 mm

0221

SERIE CHIAVI FISSE

€ 17,50



8 Pcs Append. Cromata 3110

Misure 6x7 - 8x9 - 10x11 - 12x13 - 14x15 - 16x17 - 18x19 - 20x22 mm

0222

SERIE CHIAVI FISSE

€ 42,40



12 Pcs Append. Cromata 3110

Misure 6x7 - 8x9 - 10x11 - 12x13 - 14x15 - 16x17 - 18x19 - 20x22 - 21x23 - 24x27 - 25x28 - 30x32 mm

0073

SERIE CHIAVI COMBinate

€ 19,00



12 Pcs Append. Cromata 3113

Misure 6 - 7 - 8 - 9 - 10 - 11 - 12 - 13 - 14 - 17 - 19 - 22 mm

0223

SERIE CHIAVI COMBinate

€ 75,20



25 Pcs Scatola Cromata 3113

Misure 6-7-8-9-10-11-12-13-14-15-16-17-18-19-20-21-22-23-24-25-26-27-28-30-32 mm

0476-
CHIAVI POLIGONALI CROMATE, LUCIDATE A SPECCHIO

Art.	€	Misura	Lunghezza
0476/06X07	€ 2,40	6 x 7 mm	165 mm
0476/08X09	€ 2,61	8 x 9 mm	180 mm
0476/10X11	€ 2,73	10 x 11 mm	195 mm
0476/12X13	€ 2,85	12 x 13 mm	215 mm
0476/14X15	€ 3,50	14 x 15 mm	240 mm
0476/16X17	€ 3,93	16 x 17 mm	260 mm
0476/18X19	€ 4,35	18 x 19 mm	320 mm
0476/20X22	€ 6,10	20 x 22 mm	320 mm
0476/21X23	€ 6,60	21 x 23 mm	325 mm
0476/24X27	€ 8,50	24 x 27 mm	335 mm
0476/25X28	€ 9,80	25 x 28 mm	345 mm
0476/30X32	€ 11,90	30 x 32 mm	360 mm

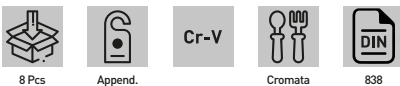
0477
€ 29,50
SERIE CHIAVI POLIGONALI CROMATE, LUCIDATE A SPECCHIO

Misure 6x7 - 8x9 - 10x11 - 12x13 - 14x15 - 16x17 - 18x19 - 20x22 mm

0476
€ 67,60
SERIE CHIAVI POLIGONALI CROMATE, LUCIDATE A SPECCHIO

Misure 6x7 - 8x9 - 10x11 - 12x13 - 14x15 - 16x17 - 18x19 - 20x22 - 21x23 - 24x27 - 25x28 - 30x32 mm

0895-
CHIAVI A FORCHETTA A PERCUSSIONE

Art.	€	Misura	Lunghezza
0895/24	€ 13,50	24 mm	160 mm
0895/27	€ 14,60	27 mm	180 mm
0895/30	€ 16,30	30 mm	195 mm
0895/32	€ 17,50	32 mm	195 mm
0895/36	€ 20,70	36 mm	215 mm
0895/38	€ 23,20	38 mm	215 mm
0895/41	€ 26,50	41 mm	235 mm
0895/46	€ 30,10	46 mm	255 mm
0895/50	€ 41,20	50 mm	280 mm
0895/55	€ 47,70	55 mm	310 mm
0895/60	€ 57,10	60 mm	320 mm
0895/65	€ 80,40	65 mm	345 mm
0895/70	€ 101,00	70 mm	370 mm

0896-
CHIAVI POLIGONALI A PERCUSSIONE

Art.	€	Misura	Lunghezza
0896/24	€ 13,50	24 mm	160 mm
0896/27	€ 14,60	27 mm	180 mm
0896/30	€ 16,30	30 mm	195 mm
0896/32	€ 17,50	32 mm	195 mm
0896/36	€ 20,70	36 mm	205 mm
0896/38	€ 23,20	38 mm	215 mm
0896/41	€ 26,50	41 mm	230 mm
0896/46	€ 30,10	46 mm	240 mm
0896/50	€ 37,10	50 mm	255 mm
0896/55	€ 42,30	55 mm	270 mm
0896/60	€ 51,90	60 mm	280 mm
0896/65	€ 75,20	65 mm	300 mm
0896/70	€ 94,30	70 mm	325 mm



0196-

CHIAVI COMBinate CORTE CROMATE, LUCIDATE A SPECCHIO

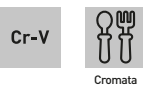

Art.	€	Misura	Lunghezza
0196/10	€ 2,44	10 mm	95 mm
0196/11	€ 2,65	11 mm	105 mm
0196/12	€ 2,86	12 mm	105 mm
0196/13	€ 3,17	13 mm	110 mm
0196/14	€ 3,39	14 mm	115 mm
0196/15	€ 3,71	15 mm	115 mm
0196/16	€ 3,92	16 mm	125 mm
0196/17	€ 4,02	17 mm	130 mm
0196/18	€ 4,35	18 mm	140 mm
0196/19	€ 4,44	19 mm	140 mm

0134-

CHIAVI POLIGONALI PIATTE



Art.	€	Misura	Lunghezza
0134/06X07	€ 3,81	6 x 7 mm	100 mm
0134/08X09	€ 4,23	8 x 9 mm	115 mm
0134/10X11	€ 4,44	10 x 11 mm	130 mm
0134/12X13	€ 4,77	12 x 13 mm	145 mm
0134/14X15	€ 5,20	14 x 15 mm	160 mm
0134/16X17	€ 5,70	16 x 17 mm	170 mm
0134/18X19	€ 6,10	18 x 19 mm	185 mm
0134/20X22	€ 6,80	20 x 22 mm	205 mm

0196

€ 27,70

SERIE CHIAVI COMBinate CORTE CROMATE, LUCIDATE A SPECCHIO



Misure 10-11-12-13-14-15-16-17-18-19 mm

0134S

€ 33,50

SERIE CHIAVI POLIGONALI PIATTE

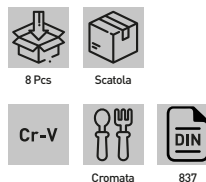

Misure 100 - 6x7 mm, 115 - 8x9 mm, 130 - 10x11 mm, 145 - 12x13 mm, 160 - 14x15 mm, 170 - 16x17 mm, 185 - 18x19 mm, 205 - 20x20 mm

0187

€ 40,20

SERIE CHIAVI COMBinate MULTILOCK

Adatte per dadi e bulloni metrici, a pollici, torx e XZN.

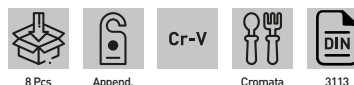

Misure 8 - 10 - 11 - 12 - 13 - 14 - 17 - 19 mm
 Misure in pollici 5/16" - 3/8" - 7/16" - 15/32" - 1/2" - 9/16" - 11/16" - 3/4"
 Misure torx E10 - E12 - E14 - E16 - E18 - E22 - E24
 Misure XZN M8 - M10 - M11 - M12 - M13 - M14 - M17 - M19

0541S

€ 30,80

SERIE CHIAVI PER RACCORDI

Da 8 mm a 14 mm esagonali, da 17 mm a 22 mm poligonali.

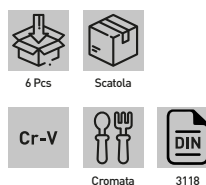

Misure 140-8x10 mm, 150-9x11 mm, 175-11x13 mm, 175-12x14 mm, 210-17x19 mm, 220-19x22 mm

0614-
CHIAVI A MEZZALUNA

Art.	€	Misura
0614/08X10	€ 4,77	8 x 10 mm
0614/10X12	€ 5,20	10 x 12 mm
0614/11X13	€ 5,60	11 x 13 mm
0614/13X15	€ 6,00	13 x 15 mm
0614/14X17	€ 7,10	14 x 17 mm
0614/16X18	€ 8,80	16 x 18 mm
0614/19X22	€ 9,60	19 x 22 mm

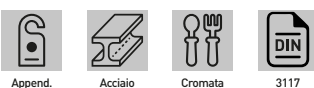
0084-
CHIAVI INGLESIS CROMATE

Art.	€	Misura	Apertura
0084/150	€ 5,70	6"-150 mm	20 mm
0084/250	€ 10,10	10"-250 mm	30 mm
0084/375	€ 28,50	15"-375 mm	48 mm

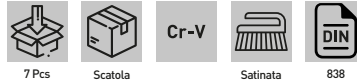
0614
€ 47,70
SERIE CHIAVI A MEZZALUNA

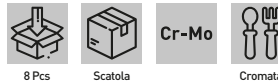
Misure 8x10 - 10x12 - 11x13 - 13x15 - 14x17 - 16x18 - 19x22 mm

0714
€ 125,00
SET CHIAVI A SETTORE

Serie 35 + 120
Misure 35+60 60+90 90+120

0266
€ 1,66
CHIAVE PER BOMBOLA GAS

Misura 25 mm
Pack 10

0340S
€ 61,30
**SERIE CHIAVI A DOPPIA
BUSSOLA SNODATE**

Ideali per svitare o avvitare dadi e bulloni situati in posizioni difficili da raggiungere.

Misure 8x9-10x11-12x13-14x15-16x17-18x19 mm



0393-

CHIAVI A PIPA DOPPIE ESAGONALI-POLIGONALI



Art.	€	Misura	Lunghezza
0393/06	€ 6,00	6 mm	100 mm
0393/07	€ 6,00	7 mm	105 mm
0393/08	€ 6,00	8 mm	115 mm
0393/09	€ 6,20	9 mm	120 mm
0393/10	€ 6,40	10 mm	130 mm
0393/11	€ 7,10	11 mm	135 mm
0393/12	€ 7,50	12 mm	145 mm
0393/13	€ 8,10	13 mm	150 mm
0393/14	€ 8,60	14 mm	160 mm
0393/15	€ 9,00	15 mm	170 mm
0393/16	€ 9,50	16 mm	180 mm
0393/17	€ 10,20	17 mm	185 mm
0393/18	€ 11,30	18 mm	200 mm
0393/19	€ 12,20	19 mm	200 mm
0393/20	€ 13,70	20 mm	210 mm
0393/21	€ 14,40	21 mm	220 mm
0393/22	€ 15,50	22 mm	230 mm

0442-

CHIAVI A TUBO ESAGONALI

Lucidate a specchio con corpo esagonale.

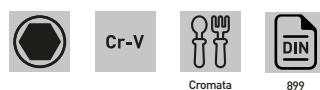

Art.	€	Misura	Lunghezza
0442/06X07	€ 7,10	6 x 7 mm	105 mm
0442/08X09	€ 7,70	8 x 9 mm	110 mm
0442/10X11	€ 8,30	10 x 11 mm	120 mm
0442/12X13	€ 9,20	12 x 13 mm	140 mm
0442/14X15	€ 10,40	14 x 15 mm	145 mm
0442/16X17	€ 11,90	16 x 17 mm	155 mm
0442/18X19	€ 14,50	18 x 19 mm	165 mm
0442/20X22	€ 18,20	20 x 22 mm	170 mm

0393/A

€ 108,00

SERIE CHIAVI A PIPA DOPPIE ESAGONALI-POLIGONALI



Misure 6-7-8-10-11-12-13-14-17-19

0393

€ 80,40

CHIAVI A PIPA DOPPIE ESAGONALI-POLIGONALI



Misure 6 - 7 - 8 - 10 - 11 - 12 - 13 - 14 - 17 - 19 - 22 mm

0442

€ 93,10

SERIE CHIAVI A TUBO ESAGONALI

Lucidate a specchio con corpo esagonale.



Misure 105 - 6x7 mm, 110 - 8x9 mm, 120 - 10x11 mm, 140 - 12x13 mm, 145 - 14x15 mm, 155 - 16x17 mm, 165 - 18x19 mm, 170 - 20x22 mm

0540-
CHIAVI A TUBO

Esagonali tipo leggero.



Acciaio

Satinata

Art.	€	Misura	Lunghezza
0540/06X07	€ 2,23	6 x 7 mm	110 mm
0540/08X09	€ 2,35	8 x 9 mm	120 mm
0540/10X11	€ 2,39	10 x 11 mm	125 mm
0540/12X13	€ 2,54	12 x 13 mm	135 mm
0540/14X15	€ 2,71	14 x 15 mm	135 mm
0540/16X17	€ 3,17	16 x 17 mm	150 mm
0540/18X19	€ 3,57	18 x 19 mm	160 mm
0540/20X22	€ 3,98	20 x 22 mm	170 mm

0540S
€ 19,40
SERIE DI CHIAVI A TUBO ESAGONALI

Tipo leggero, con spina di manovra a 3 diametri.



8 Pcs

Scatola



Acciaio

Cromata

Misure 6x7 8x9 10x11 12x13 14x15 16x17 18x19 20x22 mm

0540/3
€ 3,17
SPINA DI MANOVRA

A 3 diametri per chiavi a tubo.



Acciaio

Cromata

Lunghezza 165 mm
 ø 9,5 - 7,5 - 6 mm



0090-

CHIAVI MASCHIO ESAGONALI

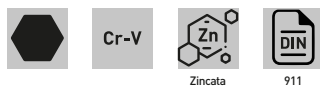

Art.	€	L1	L2	Pack
0090/015	€ 0,67	45 mm	14 mm	10
0090/02	€ 0,67	50 mm	16 mm	10
0090/025	€ 0,67	56 mm	18 mm	10
0090/03	€ 0,72	63 mm	20 mm	10
0090/04	€ 0,72	70 mm	25 mm	10
0090/05	€ 1,09	80 mm	28 mm	10
0090/06	€ 1,31	90 mm	32 mm	10
0090/08	€ 1,97	100 mm	36 mm	5
0090/10	€ 2,40	112 mm	40 mm	5
0090/12	€ 3,70	125 mm	45 mm	5
0090/14	€ 5,30	140 mm	56 mm	5
0090/17	€ 6,80	160 mm	63 mm	5
0090/19	€ 11,00	180 mm	70 mm	5

0558/GE

€ 14,60

SERIE CHIAVI ESAGONALI

Con testa a giravite ph o taglio, con manico multiuso utilizzabile sia come impugnatura a T che come estensione della chiave.



Misure	2 - 2,5 - 3 - 4 - 5 - 6 - 8 - 10 mm
Giravite a croce per meccanica	PH0 (3 mm) - PH1 (4 mm) - PH2 (5 mm)
Giravite a taglio per meccanica	6 mm

0215X

SERIE CHIAVI ESAGONALI LUNGHE CON PUNTA SFERICA



Art.	€	Misura
0215	€ 12,50	1,5 - 2 - 2,5 - 3 - 4 - 5 - 6 - 8 - 10
0215P	€ 12,50	1/16" - 5/64" - 3/32" - 1/8" - 5/32" - 3/16" - 1/4" - 5/16" - 3/8"

0090

€ 2,96

SERIE CHIAVI ESAGONALI



Misure	1,5 - 2 - 2,5 - 3 - 3,5 - 4 - 5 - 6 - 8 - 10 mm
--------	-------------------------------------------------

0269

€ 5,80

SERIE CHIAVI ESAGONALI



Misure	1,5 - 2 - 2,5 - 3 - 4 - 5 - 6 - 8 - 10 mm
--------	-------------------------------------------

0545/EF

€ 34,40

SERIE CHIAVI ESAGONALI COLORATE CON PUNTA SFERICA



Misure	1,5 - 2 - 2,5 - 3 - 4 - 5 - 6 - 8 - 10 mm
--------	-------------------------------------------

0558/EM
€ 18,40
SERIE CHIAVI ESAGONALI CON PUNTA DIAMANTATA

La punta diamantata consente una perfetta presa evitando di rovinare la testa della vite. Questa tipologia di punta è anche molto efficace con viti già rovinate.

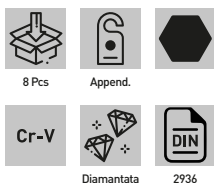
Misure 1,5 - 2 - 2,5 - 3 - 4 - 5 - 6 - 8 mm

0558/EP
€ 18,40
SERIE CHIAVI ESAGONALI CON PUNTA DIAMANTATA

La punta diamantata consente una perfetta presa evitando di rovinare la testa della vite. Questa tipologia di punta è anche molto efficace con viti già rovinate.

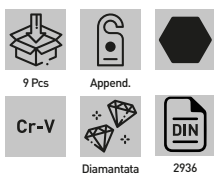
Misure 5/64" - 3/32" - 7/64" - 1/8" - 9/64" - 5/32" - 3/16" - 7/32" - 1/4"

C856-
CHIAVI ESAGONALI CON MANICO IN PLASTICA E PUNTA SFERICA



Art.	€	Misura	Lunghezza
C856/02.5	€ 4,23	2.5 mm	175 mm
C856/03	€ 4,23	3 mm	175 mm
C856/04	€ 4,44	4 mm	175 mm
C856/05	€ 4,77	5 mm	175 mm
C856/06	€ 6,70	6 mm	175 mm
C856/08	€ 7,40	8 mm	170 mm
C856/10	€ 10,20	10 mm	170 mm

0856-
CHIAVI ESAGONALI CON MANICO ANATOMICO IN PLASTICA E PUNTA SFERICA

Art.	€	Misura	Lunghezza
0856/02	€ 2,65	2 mm	100 mm
0856/02.5	€ 2,65	2,5 mm	100 mm
0856/03	€ 2,75	3 mm	100 mm
0856/04	€ 2,96	4 mm	100 mm
0856/05	€ 4,13	5 mm	150 mm
0856/06	€ 4,55	6 mm	150 mm
0856/08	€ 6,40	8 mm	200 mm
0856/10	€ 6,60	10 mm	200 mm

0400-
CHIAVI ESAGONALI MASCHIO A "T"

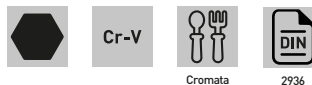
Con asta scorrevole che la rende versatile all'uso in situazioni difficili e in condizioni gravose.



Art.	€	Misura	Dimensioni
0400/02	€ 9,10	2 mm	125 x 65 mm
0400/025	€ 9,10	2,5 mm	125 x 65 mm
0400/03	€ 9,10	3 mm	125 x 65 mm
0400/035	€ 9,10	3,5 mm	125 x 65 mm
0400/04	€ 9,80	4 mm	180 x 90 mm
0400/045	€ 9,80	4,5 mm	180 x 90 mm
0400/05	€ 9,80	5 mm	180 x 90 mm
0400/06	€ 10,30	6 mm	210 x 105 mm
0400/07	€ 10,30	7 mm	250 x 105 mm
0400/08	€ 11,90	8 mm	250 x 125 mm
0400/09	€ 14,40	9 mm	300 x 145 mm
0400/10	€ 14,40	10 mm	300 x 145 mm
0400/12	€ 20,40	12 mm	320 x 165 mm
0400/14	€ 26,00	14 mm	340 x 170 mm



0400

€ 69,80

SERIE CHIAVI ESAGONALI MASCHIO A "T"

Con asta scorrevole che le rende versatili all'uso in situazioni difficili e in condizioni gravose.

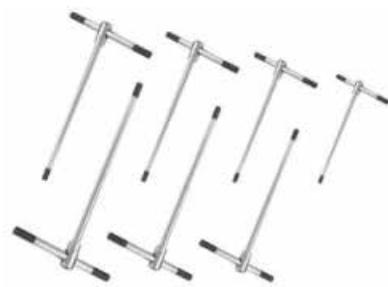
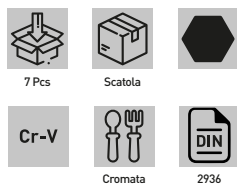

Misure 2 - 3 - 4 - 5 - 6 - 8 - 10 mm

0190

€ 78,30

SERIE CHIAVI ESAGONALI A T "SPEEDY"

Con pratica impugnatura girevole "speedy" per una maggiore velocità di utilizzo.



Misure 2 - 3 - 4 - 5 - 6 - 8 - 10 mm

0220

€ 14,70

SERIE CHIAVI TORX LUNGHE

Con foro di guida.



Misure T10 - T15 - T20 - T25 - T27 - T30 - T40 - T45 - T50

0220/C

€ 9,00

SERIE CHIAVI TORX CORTE

Con foro di guida.



Misure T10 - T15 - T20 - T25 - T27 - T30 - T40 - T45 - T50

0545/TF

€ 37,10

SERIE CHIAVI TORX COLORATE

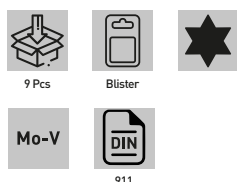

Misure T10 - T15 - T20 - T25 - T27 - T30 - T40 - T45 - T50

0558/TX

€ 18,40

SERIE CHIAVI TORX CON PUNTA DIAMANTATA

DIN ISO 2936, la punta diamantata consente una perfetta presa evitando di rovinare la testa della vite. Questa tipologia di punta è anche molto efficace con viti già rovinate.

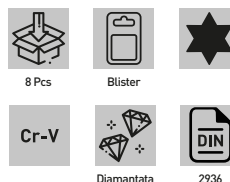

Misure T9 - T10 - T15 - T20 - T25 - T27 - T30 - T40

0855-
CHIAVI TORX CON MANICO ANATOMICO IN PLASTICA

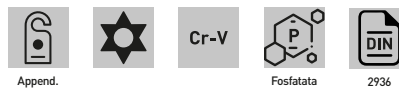

Art.	€	Misura	Lunghezza
0855/T10	€ 2,65	T10	100 mm
0855/T15	€ 2,65	T15	100 mm
0855/T20	€ 2,96	T20	100 mm
0855/T25	€ 3,50	T25	100 mm
0855/T30	€ 4,13	T30	150 mm
0855/T40	€ 5,30	T40	150 mm

C855-
CHIAVI TORX CON MANICO IN PLASTICA

Art.	€	Misura	Lunghezza
C855/T10	€ 4,23	T10	175 mm
C855/T15	€ 4,23	T15	175 mm
C855/T20	€ 4,77	T20	175 mm
C855/T25	€ 5,70	T25	175 mm
C855/T27	€ 5,70	T27	175 mm
C855/T30	€ 6,70	T30	175 mm
C855/T40	€ 8,50	T40	170 mm
C855/T50	€ 10,10	T50	170 mm

0405-
CHIAVE TORX MASCHIO A "T"

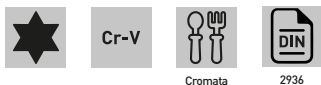
Con asta scorrevole che la rende versatile all'uso in situazioni difficili e in condizioni gravose.



Art.	€	Misura	Lunghezza
0405/T06	€ 10,40	T06	125 mm
0405/T07	€ 10,40	T07	125 mm
0405/T08	€ 10,40	T08	125 mm
0405/T09	€ 10,40	T09	125 mm
0405/T10	€ 10,40	T10	125 mm
0405/T15	€ 10,40	T15	125 mm
0405/T20	€ 10,40	T20	125 mm
0405/T25	€ 10,70	T25	180 mm
0405/T27	€ 10,70	T27	180 mm
0405/T30	€ 10,70	T30	180 mm
0405/T40	€ 12,80	T40	210 mm
0405/T45	€ 14,00	T45	210 mm
0405/T50	€ 15,00	T50	210 mm

0405
€ 70,80
SERIE CHIAVI TORX MASCHIO A "T"

Con asta scorrevole che la rende versatile all'uso in situazioni difficili e in condizioni gravose.

Misure T8-T9-T10-T15-T20-T25-T30

0190T
€ 74,60 NEW
SERIE CHIAVI TORX A T "SPEEDY"

Chiavi esagonali in alluminio spazzolato e in acciaio al Cr-V ad alta resistenza, ideali per viti torx incassate.

Pratica impugnatura girevole "speedy" per una presa più salda e una maggiore facilità e rapidità di utilizzo.

Misure da T10 a T40.

Misure T10 - T15 - T20 - T25 - T27 - T30 - T40



0359-

CHIAVE CANDELA



Art.	€	Misura	Lunghezza
0359/14L	€ 24,40	14 mm	530 mm
0359/16L	€ 24,40	16 mm	530 mm
0359/21L	€ 26,50	20,8 mm	530 mm
0359/16	€ 20,10	16 mm	275 mm

007X

CHIAVE PER CANDELA



Art.	€	Misura	Lunghezza
0078	€ 7,40	20,8	500 mm
0079	€ 7,40	16 mm	510 mm

C395-

CHIAVE A T CON BUSSOLA ESAGONALE SNODATA MAGNETICA



Art.	€	Misura	Lunghezza
C395/06	€ 18,60	6 mm	390 mm
C395/07	€ 18,60	7 mm	390 mm
C395/08	€ 18,60	8 mm	390 mm
C395/09	€ 18,60	9 mm	390 mm
C395/10	€ 21,00	10 mm	500 mm
C395/11	€ 21,00	11 mm	500 mm
C395/12	€ 21,00	12 mm	500 mm
C395/13	€ 21,90	13 mm	500 mm
C395/14	€ 21,90	14 mm	500 mm
C395/15	€ 24,90	15 mm	500 mm
C395/16	€ 24,90	16 mm	500 mm
C395/17	€ 24,90	17 mm	500 mm
C395/18	€ 25,90	18 mm	500 mm
C395/19	€ 27,50	19 mm	500 mm

C245-

CHIAVE A T CON BUSSOLA ESAGONALE PROFONDA

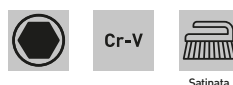

Art.	€	Misura	Lunghezza
C245/06	€ 14,90	6 mm	320 mm
C245/07	€ 14,90	7 mm	320 mm
C245/08	€ 14,90	8 mm	320 mm
C245/09	€ 14,90	9 mm	320 mm
C245/10	€ 15,30	10 mm	320 mm
C245/11	€ 15,30	11 mm	320 mm
C245/12	€ 15,90	12 mm	320 mm
C245/13	€ 15,90	13 mm	320 mm
C245/14	€ 16,90	14 mm	320 mm
C245/17	€ 19,50	17 mm	320 mm
C245/19	€ 24,40	19 mm	320 mm

C391-

CHIAVE A T CON BUSSOLA ESAGONALE SNODATA

Per servizio gravoso.



Art.	€	Misura	Lunghezza
C391/06	€ 21,20	6 mm	395 mm
C391/07	€ 21,20	7 mm	395 mm
C391/08	€ 21,20	8 mm	395 mm
C391/09	€ 21,20	9 mm	400 mm
C391/10	€ 23,20	10 mm	400 mm
C391/11	€ 23,20	11 mm	400 mm
C391/12	€ 23,20	12 mm	400 mm
C391/13	€ 25,40	13 mm	432 mm
C391/14	€ 25,40	14 mm	432 mm
C391/15	€ 30,80	15 mm	450 mm
C391/16	€ 30,80	16 mm	450 mm
C391/17	€ 30,80	17 mm	450 mm
C391/18	€ 30,80	18 mm	450 mm
C391/19	€ 33,90	19 mm	500 mm

0352-
CHIAVE FILTRO A NASTRO

Art.	€	Diametro massimo filtro	Nastro
0352/01	€ 21,00	180 mm	610 mm
0352/02	€ 22,80	220 mm	800 mm

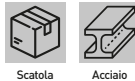
0357-
CHIAVE PER FILTRO A NASTRO REGOLABILE IN ACCIAIO

Art.	€	Diametro massimo filtro	Nastro
0357/01	€ 24,20	70 mm	180 mm
0357/02	€ 26,30	120 mm	200 mm

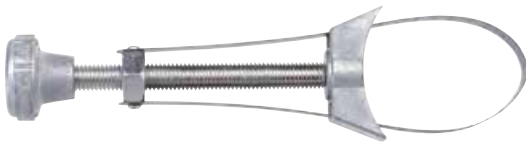
0076
€ 4,77
CHIAVE FILTRO A NASTRO

Diametro massimo filtro	120 mm
Nastro	195 mm

0077
€ 6,40
CHIAVE FILTRO A CATENA

Diametro massimo filtro	110 mm
Nastro	380 mm

0018/15
€ 67,60
SERIE CHIAVI PER FILTRI OLIO

Utili per lo smontaggio dei filtri dell'olio di molte autovetture. Adattatore da 3/8" maschio e 1/2" femmina incluso nel set.



Misure (ø mm - lati)	65 mm - 14, 65/67 mm - 14, 68 mm - 14, 74 mm - 15, 74/76 mm - 15, 75/77 mm - 15, 76 mm - 14, 76 mm - 30, 80 mm - 15, 80/82 mm
Attacco adattatore	1/2" (F) 3/8" (M)

0018/30
€ 150,00
SERIE CHIAVI PER FILTRI OLIO

Utili per lo smontaggio dei filtri dell'olio di molte autovetture. Adattatore da 3/8" maschio e 1/2" femmina e chiave a 3 griffe inclusi nel set.



Misure (ø mm - lati)	65 mm - 14, 65/67 mm - 14, 66 mm - 6, 68 mm - 14, 73 mm - 14, 74 mm - 15, 74/76 mm - 15, 75/77 mm - 15, 76 mm - 8, 76 mm - 12, 76 mm - 14, 76 mm - 30, 78 mm - 15, 80 mm - 15, 80/82 mm - 15, 86 mm - 16, 86 mm - 18, 90 mm - 15, 92 mm - 10, 93 mm - 15, 93 mm - 36, 93 mm
Attacco adattatore	1/2" (F) 3/8" (M)
Chiave a 3 griffe	65 ÷ 120 mm



0080

€ 9,80

CHIAVE A CROCE



Misure	17 - 19 - 21 mm
Dimensioni	381 x 16 mm

0426-

CHIAVE A CROCE

Per autocarro, con bussole fisse esagonali.



Art.	€	Misure	Dimensioni
0426/30	€ 35,30	24 - 27 - 30 mm	550 x 20 mm
0426/32	€ 44,70	24 - 27 - 32 mm	700 x 22 mm

0806/200

€ 467,00

CHIAVE DINAMOMETRICA ELETTRONICA DIGITALE, LETTURA DI COPPIA E ANGOLO

Permette serraggi in senso orario e antiorario e una diagnostica luminosa e sonora dello stato coppia/angolo.



SCALE DI MISURAZIONE:	Nm / kgf-cm / lbf-ft / lbf-in	Precisione angolo	±1%
Capacità	20 ÷ 200 Nm	Modalità operativa	Peak / Track
Lettura	0,1 Nm	Memorie coppia - angolo	5
Precisione	±2%, 10% @ 200 Nm	Lunghezza	605 mm
Angolo di misurazione	0 ÷ 360°	Batteria	4x 1,5 V AAA

0809-

CHIAVE DINAMOMETRICA ELETTRONICA DIGITALE

Permette serraggi in senso orario e antiorario e una diagnostica luminosa e sonora dello stato della coppia.



Art.	€	SCALE DI MISURAZIONE:	Capacità	Lettura	Precisione	Modalità operativa	Memorie	Attacco quadro	Lunghezza	Batteria
0809/030	€ 111,00	Nm / kgf-cm / lbf-ft / lbf-in	6 ÷ 30 Nm	0,01 Nm	±4%	Peak / Track	50	1/4"	200 mm	2 x 3 V CR2032
0809/080	€ 119,00	Nm / kgf-m / lbf-ft / lbf-in	16 ÷ 80 Nm	0,1 Nm	±3%	Peak / Track	50	3/8"	230 mm	2 x 3 V CR2032
0809/100	€ 125,00	Nm / kgf-m / lbf-ft / lbf-in	20 ÷ 100 Nm	0,1 Nm	±2%	Peak / Track	50	1/2"	275 mm	2 x 3 V CR2032

0806/020
€ 114,00
GIRAVITE DINAMOMETRICO DIGITALE

ISO 6789-2017, serraggio in senso orario ed antiorario, diagnostica sonora e a vibrazione della coppia raggiunta preimpostata.



SCALE DI MISURAZIONE:	Nm / lbft / lbin
Capacità	0 ÷ 20 Nm
Lettura	0,01 Nm
Precisione	±2%
Modalità operativa	Peak / Track
Autospegnimento	5 min.
Lunghezza	175 mm
Batteria	2 x 1,5 V AAA
Temperatura di esercizio	0 °C - 40 °C
Temperatura stoccaggio	-5 °C - 45 °C

0268A
€ 102,00
MISURATORE DIGITALE DI COPPIA

Strumento di monitoraggio della torsione. Applicato ad una chiave a cricco può essere usato come chiave dinamometrica. Schermo LCD retroilluminato, modalità operativa Picco e Traccia. Funzione di autospegnimento.

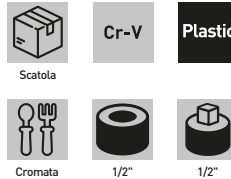

Modalità operativa	Picco/traccia
SCALE DI MISURAZIONE:	Nm/kgm/kgcm/lbft/lbin
Capacità	40 ÷ 200 Nm
Lettura	0,1 Nm
Memorie	50
Precisione	±2%
Dimensioni	75 x 44 mm
Batteria	2 x AAA
Temperatura di esercizio	-10°C-60 °C [14°F-139.9 °F]
Temperatura stoccaggio	-20°C -70°C [-4 °F-157.9°F]

0137
€ 64,10
CHIAVE DINAMOMETRICA

Capacità	28 ÷ 210 Nm
Prolunga	120 mm

0815-
CHIAVI DINAMOMETRICHE

ISO 6789-2017, finestra di lettura.



Art.	€	Attacco quadro	Capacità	Risoluzione	Precisione	Lunghezza
0815/100	€ 169,00	3/8"	20 ÷ 100 Nm	0,5 Nm	±4%	460 mm
0815/200	€ 223,00	1/2"	40 ÷ 200 Nm	1,0 Nm	±4%	515 mm
0815/800	€ 772,00	3/4"	100 ÷ 800 Nm	5,0 Nm	±4%	1100 mm



0803-

CHIAVI DINAMOMETRICHE

ISO 6789-2017.



Valigetta



Satinata



Art.	€	Attacco	Capacità	Risoluzione	Precisione	Lunghezza
0803/110	€ 145,00	3/8"	20 - 110 Nm	0,5 Nm	±4%	380 mm
0803/210	€ 208,00	1/2"	40 - 210 Nm	1 Nm	±4%	535 mm
0803/700	€ 677,00	3/4"	140 - 700 Nm	2,5 Nm	±4%	1085 mm

0803/S210

€ 333,00

CHIAVE DINAMOMETRICA IN SET

ISO 6789-2017.



11 Pcs



Valigetta



Satinata

Attacco chiavi	14 x 18 mm
Testa reversibile	1/2"
Capacità	40 ÷ 210 Nm
Precisione	±4%
Risoluzione	1 Nm
Chiavi	13 - 14 - 15 - 17 - 19 - 22 - 24 - 27 - 30 mm

0803/S080

€ 226,00

CHIAVE DINAMOMETRICA IN SET

ISO 6789-2017.



8 Pcs



Valigetta



Satinata

Attacco chiavi	14x 18 mm
Testa reversibile	3/8"
Capacità	15 ÷ 80 Nm
Precisione	±4%
Chiavi	17 - 22 - 24 - 26 - 27 - 30 mm
Risoluzione	0,5 Nm

0329

€ 180,00

MOLTIPLICATORE DI FORZA

Smontaruote per autocarro.



7 Pcs



3113



1"



Valigetta

Bussole da 1"	32 - 33 mm
Rapporto	1:60
Forza massima	3200 Nm
Forza di lavoro	1200 Nm
Peso netto	7,5 kg

0360

€ 81,60

MOLTIPLICATORE DI FORZA

Smontaruote per autocarro, fornito in valigetta di plastica.



7 Pcs



3113



1"



Valigetta

Bussole da 1"	32 - 33 mm
Rapporto	1 : 56
Forza massima	3000 Nm
Forza di lavoro	1000 Nm
Peso netto	7 kg

CN450N0/0 € 48,90

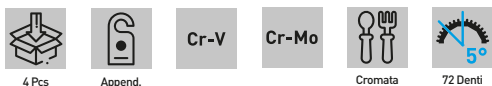
CRICCHETTO REVERSIBILE A CAMBIO RAPIDO 3 IN 1

Lunghezza	230 mm
Attacco	1/2" - 3/8" - 1/4"
Denti	72

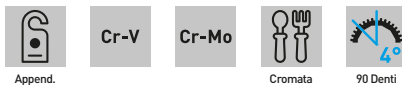
G090-
CRICCHETTO ERGONOMICO

Art.	€	Lunghezza	Attacco quadro
G090/1/4	€ 22,60	145 mm	1/4"
G090/3/8	€ 27,40	195 mm	3/8"
G090/1/2	€ 31,30	265 mm	1/2"

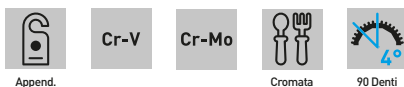
F090-
CRICCHETTO ERGONOMICO

Art.	€	Lunghezza	Attacco quadro
F090/1/4	€ 22,60	145 mm	1/4"
F090/3/8	€ 27,40	195 mm	3/8"
F090/1/2	€ 31,30	265 mm	1/2"

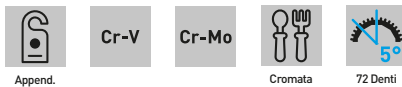
0494-
CRICCHETTO ERGONOMICO CON TESTA ANTISPORCO

Art.	€	Lunghezza	Attacco quadro
0494/1/4	€ 27,40	165 mm	1/4"
0494/3/8	€ 31,30	215 mm	3/8"
0494/1/2	€ 37,70	276 mm	1/2"

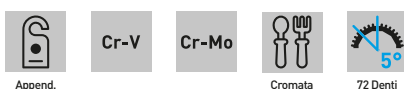
CN450NX
CRICCHETTO ERGONOMICO

Art.	€	Lunghezza	Attacco quadro
CN450N1/4A	€ 27,30	150 mm	1/4"
CN450N3/8A	€ 31,60	205 mm	3/8"
CN450N1/2A	€ 32,70	250 mm	1/2"

0439-
CRICCHETTO ERGONOMICO

Art.	€	Attacco quadro	Lunghezza	Denti
0439/1/4	€ 18,70	1/4"	155 mm	72
0439/3/8	€ 26,40	3/8"	200 mm	72
0439/1/2	€ 31,60	1/2"	260 mm	72



0019-
LEVA A CRICCO REVERSIBILE CON ESTRATTORE

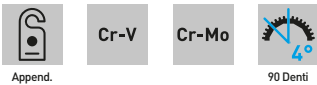

Art.	€	Lunghezza	Attacco quadro
0019/1/4	€ 16,50	154 mm	1/4"
0019/3/8	€ 23,60	215 mm	3/8"
0019/1/2	€ 30,00	275 mm	1/2"

0308 € 37,60
CRICCHETTO REVERSIBILE

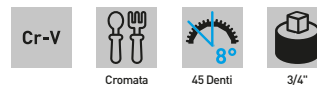

Lunghezza 490 mm

0228 € 11,70
CRICCHETTO REVERSIBILE



Lunghezza 220 mm

0173 € 5,00
IMPUGNATURA PER BUSSOLE DA 1/4"
Con attacco quadro femmina da 1/4" per essere utilizzata anche come prolunga.

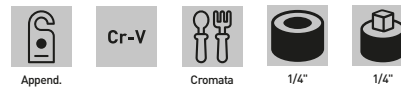

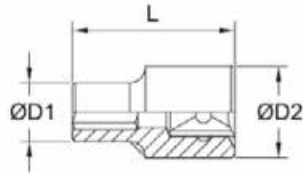
BN4E5NX
CHIAVE A BUSSOLA ESAGONALE, SERIE NORMALE

Art.	€	Misura	D1	D2	Lunghezza
BN4E5N004A	€ 1,56	4 mm	6,8 mm	12 mm	25 mm
BN4E5N0045A	€ 1,56	4,5 mm	7,2 mm	12 mm	25 mm
BN4E5N005A	€ 1,56	5 mm	7,8 mm	12 mm	25 mm
BN4E5N0055A	€ 1,56	5,5 mm	8,4 mm	12 mm	25 mm
BN4E5N006A	€ 1,56	6 mm	9,3 mm	12 mm	25 mm
BN4E5N007A	€ 1,56	7 mm	10,8 mm	12 mm	25 mm
BN4E5N008A	€ 1,81	8 mm	12 mm	11 mm	25 mm
BN4E5N009A	€ 1,81	9 mm	13 mm	12 mm	25 mm
BN4E5N010A	€ 1,81	10 mm	14,6 mm	12 mm	25 mm
BN4E5N011A	€ 2,03	11 mm	16 mm	12,5 mm	25 mm
BN4E5N012A	€ 2,03	12 mm	17 mm	13,5 mm	25 mm
BN4E5N013A	€ 2,24	13 mm	18 mm	13,5 mm	25 mm
BN4E5N014A	€ 2,47	14 mm	19 mm	14,5 mm	25 mm

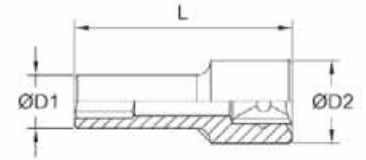
BN4E5LX
CHIAVE A BUSSOLA ESAGONALE LUNGA

Art.	€	Misura	D1	D2	Lunghezza
BN4E5L004A	€ 3,71	4 mm	6,8 mm	12 mm	50 mm
BN4E5L0045A	€ 3,71	4,5 mm	7,2 mm	12 mm	50 mm
BN4E5L005A	€ 3,71	5 mm	7,8 mm	12 mm	50 mm
BN4E5L0055A	€ 3,71	5,5 mm	8,4 mm	12 mm	50 mm
BN4E5L006A	€ 3,71	6 mm	9,3 mm	12 mm	50 mm
BN4E5L007A	€ 3,71	7 mm	10,8 mm	12 mm	50 mm
BN4E5L008A	€ 3,71	8 mm	12 mm	11 mm	50 mm
BN4E5L009A	€ 3,71	9 mm	13 mm	12 mm	50 mm
BN4E5L010A	€ 3,71	10 mm	14,6 mm	12 mm	50 mm
BN4E5L011A	€ 4,03	11 mm	16 mm	13 mm	50 mm
BN4E5L012A	€ 4,03	12 mm	17 mm	13 mm	50 mm
BN4E5L013A	€ 4,25	13 mm	18 mm	13 mm	50 mm
BN4E5L014A	€ 4,25	14 mm	19 mm	14,5 mm	50 mm

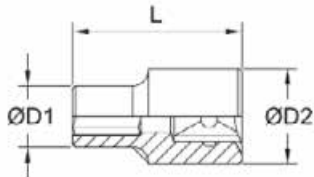
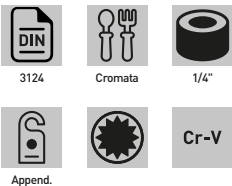
BN4P5NX
CHIAVE A BUSSOLA POLIGONALE, SERIE NORMALE

Art.	€	Misura	D1	D2	Lunghezza
BN4P5N004A	€ 1,48	4 mm	6,8 mm	12 mm	25 mm
BN4P5N005A	€ 1,48	5 mm	7,8 mm	12 mm	25 mm
BN4P5N0055A	€ 1,48	5,5 mm	8,4 mm	12 mm	25 mm
BN4P5N006A	€ 1,48	6 mm	9,3 mm	12 mm	25 mm
BN4P5N007A	€ 1,48	7 mm	10,8 mm	12 mm	25 mm
BN4P5N008A	€ 1,68	8 mm	12 mm	11 mm	25 mm
BN4P5N009A	€ 1,68	9 mm	13 mm	12 mm	25 mm
BN4P5N010A	€ 1,68	10 mm	14,6 mm	12 mm	25 mm
BN4P5N011A	€ 1,91	11 mm	16 mm	12,5 mm	25 mm
BN4P5N012A	€ 1,91	12 mm	17 mm	13,5 mm	25 mm
BN4P5N013A	€ 2,14	13 mm	18 mm	13,5 mm	25 mm
BN4P5N014A	€ 2,24	14 mm	19 mm	14,5 mm	25 mm

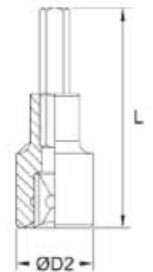
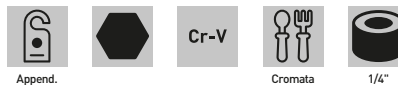
BN415NX
BUSSOLA CON INSERTO ESAGONALE

Art.	€	Misura	D2	Lunghezza
BN415N003A	€ 2,81	3 mm	12 mm	37 mm
BN415N004A	€ 2,81	4 mm	12 mm	37 mm
BN415N005A	€ 2,81	5 mm	12 mm	37 mm
BN415N006A	€ 2,81	6 mm	12 mm	37 mm
BN415N008A	€ 2,81	8 mm	12 mm	37 mm



BN425NX

BUSSOLA CON INSERTO TORX

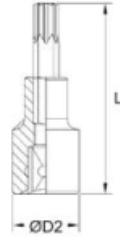

Art.	€	Misura	D2	Lunghezza
BN425N008A	€ 2,81	T8	12 mm	37 mm
BN425N009A	€ 2,81	T9	12 mm	37 mm
BN425N010A	€ 2,81	T10	12 mm	37 mm
BN425N015A	€ 2,81	T15	12 mm	37 mm
BN425N020A	€ 2,81	T20	12 mm	37 mm
BN425N025A	€ 2,81	T25	12 mm	37 mm
BN425N027A	€ 2,81	T27	12 mm	37 mm
BN425N030A	€ 2,81	T30	12 mm	37 mm
BN425N040A	€ 2,81	T40	12 mm	37 mm

BN445NX

BUSSOLA CON INSERTO XZN

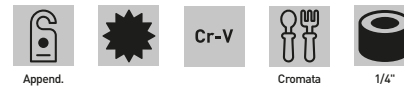
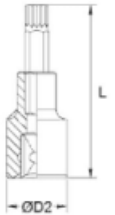

Art.	€	Misura	D2	Lunghezza
BN445N004A	€ 9,50	M 4	15 mm	37 mm
BN445N005A	€ 9,50	M 5	15 mm	37 mm
BN445N006A	€ 9,50	M 6	15 mm	37 mm
BN445N008A	€ 9,50	M 8	15 mm	37 mm
BN445N009A	€ 9,50	M 9	15 mm	37 mm
BN445N010A	€ 9,50	M 10	15 mm	37 mm

RN4054NA

€ 3,36

RACCORDO



Lunghezza 26 mm



JN405NA

€ 6,10

SNODO A CARDANO

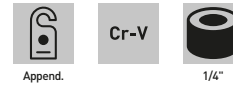

Lunghezza 38 mm



PN405NX

PROLUNGA

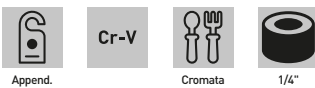

Art.	€	Lunghezza
PN405N050A	€ 3,36	50 mm
PN405N075A	€ 3,59	75 mm
PN405N150A	€ 5,40	150 mm

EN405NX

PROLUNGA A TESTA SFERICA

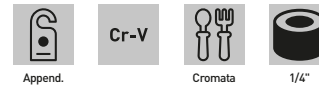

Art.	€	Lunghezza
EN405N050A	€ 4,46	50 mm
EN405N075A	€ 5,10	75 mm
EN405N150A	€ 5,60	150 mm

LN400N1/4A

€ 5,10

LEVA A T SCORREVOLE



Lunghezza 115 mm

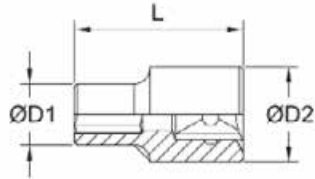

BN4E4NX
CHIAVE A BUSSOLA ESAGONALE, SERIE NORMALE

Art.	€	Misura	D1	D2	Lunghezza
BN4E4N006A	€ 2,69	6 mm	9,3 mm	17 mm	28 mm
BN4E4N007A	€ 2,69	7 mm	10,6 mm	17 mm	28 mm
BN4E4N008A	€ 2,69	8 mm	11,8 mm	17 mm	28 mm
BN4E4N009A	€ 2,69	9 mm	13,2 mm	17 mm	28 mm
BN4E4N010A	€ 2,69	10 mm	14,5 mm	17 mm	28 mm
BN4E4N011A	€ 2,69	11 mm	15,7 mm	17 mm	28 mm
BN4E4N012A	€ 2,69	12 mm	17 mm	16,4 mm	28 mm
BN4E4N013A	€ 2,69	13 mm	18 mm	17 mm	28 mm
BN4E4N014A	€ 3,36	14 mm	20 mm	17 mm	28 mm
BN4E4N015A	€ 3,36	15 mm	20,9 mm	18 mm	28 mm
BN4E4N016A	€ 3,36	16 mm	22 mm	18 mm	28 mm
BN4E4N017A	€ 3,36	17 mm	24 mm	18 mm	30 mm
BN4E4N018A	€ 4,03	18 mm	26 mm	18 mm	30 mm
BN4E4N019A	€ 4,25	19 mm	26 mm	20 mm	30 mm
BN4E4N020A	€ 5,00	20 mm	27,1 mm	20 mm	30 mm
BN4E4N021A	€ 5,00	21 mm	28 mm	20 mm	30 mm
BN4E4N022A	€ 5,90	22 mm	30 mm	20 mm	32 mm

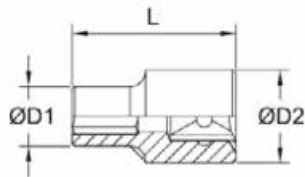
BN4P4NX
CHIAVE A BUSSOLA POLIGONALE, SERIE NORMALE

Art.	€	Misura	D1	D2	Lunghezza
BN4P4N006A	€ 2,47	6 mm	9,3 mm	17 mm	28 mm
BN4P4N007A	€ 2,47	7 mm	10,6 mm	17 mm	28 mm
BN4P4N008A	€ 2,47	8 mm	11,8 mm	17 mm	28 mm
BN4P4N009A	€ 2,47	9 mm	13,2 mm	17 mm	28 mm
BN4P4N010A	€ 2,47	10 mm	14,5 mm	17 mm	28 mm
BN4P4N011A	€ 2,47	11 mm	15,7 mm	17 mm	28 mm
BN4P4N012A	€ 2,47	12 mm	17 mm	16,4 mm	28 mm
BN4P4N013A	€ 2,47	13 mm	18 mm	17 mm	28 mm
BN4P4N014A	€ 3,14	14 mm	20 mm	17 mm	28 mm
BN4P4N015A	€ 3,14	15 mm	20,9 mm	18 mm	28 mm
BN4P4N016A	€ 3,14	16 mm	22 mm	18 mm	28 mm
BN4P4N017A	€ 3,14	17 mm	24 mm	18 mm	30 mm
BN4P4N018A	€ 3,80	18 mm	26 mm	18 mm	30 mm
BN4P4N019A	€ 4,03	19 mm	26 mm	20 mm	30 mm
BN4P4N020A	€ 4,58	20 mm	28 mm	20 mm	30 mm
BN4P4N021A	€ 4,58	21 mm	28 mm	20 mm	30 mm
BN4P4N022A	€ 5,50	22 mm	30 mm	20 mm	32 mm

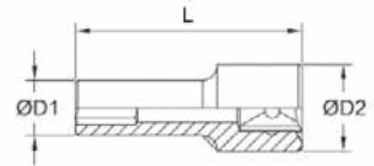
BN4E4LX
CHIAVE A BUSSOLA ESAGONALE LUNGA

Art.	€	Misura	D1	D2	Lunghezza
BN4E4L006A	€ 5,90	6 mm	9,3 mm	17 mm	63 mm
BN4E4L007A	€ 5,90	7 mm	10,6 mm	17 mm	62 mm
BN4E4L008A	€ 5,90	8 mm	11,8 mm	17 mm	63 mm
BN4E4L009A	€ 5,90	9 mm	13,2 mm	17 mm	63 mm
BN4E4L010A	€ 5,90	10 mm	14,5 mm	17 mm	63 mm
BN4E4L011A	€ 5,90	11 mm	15,7 mm	17 mm	63 mm
BN4E4L012A	€ 5,90	12 mm	17 mm	16,4 mm	63 mm
BN4E4L013A	€ 5,90	13 mm	18 mm	17 mm	63 mm
BN4E4L014A	€ 6,60	14 mm	19,6 mm	17 mm	63 mm
BN4E4L015A	€ 6,60	15 mm	20,9 mm	18 mm	63 mm
BN4E4L016A	€ 6,60	16 mm	22 mm	18 mm	63 mm
BN4E4L017A	€ 6,60	17 mm	23,4 mm	18 mm	63 mm
BN4E4L018A	€ 7,70	18 mm	24,6 mm	20 mm	63 mm
BN4E4L019A	€ 7,70	19 mm	26 mm	20 mm	63 mm
BN4E4L020A	€ 7,70	20 mm	27,1 mm	20 mm	63 mm
BN4E4L021A	€ 9,00	21 mm	28 mm	20 mm	63 mm
BN4E4L022A	€ 9,00	22 mm	30 mm	20 mm	63 mm





BN414NX

BUSSOLA CON INSERTO ESAGONALE



Art.	€	Misura	D2	Lunghezza
BN414N003A	€ 6,40	3 mm	18 mm	48 mm
BN414N004A	€ 6,40	4 mm	18 mm	48 mm
BN414N005A	€ 6,40	5 mm	18 mm	48 mm
BN414N006A	€ 6,40	6 mm	18 mm	48 mm
BN414N007A	€ 6,40	7 mm	18 mm	48 mm
BN414N008A	€ 6,40	8 mm	18 mm	48 mm
BN414N009A	€ 6,40	9 mm	20 mm	48 mm
BN414N010A	€ 6,40	10 mm	20 mm	48 mm
BN414N012A	€ 6,50	12 mm	20 mm	48 mm

BN414LX

BUSSOLA CON INSERTO ESAGONALE LUNGO

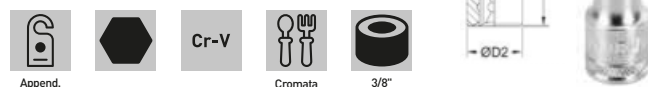

Art.	€	Misura	D2	Lunghezza
BN414L003A	€ 9,20	3 mm	18 mm	95 mm
BN414L004A	€ 9,20	4 mm	18 mm	95 mm
BN414L005A	€ 9,20	5 mm	18 mm	95 mm
BN414L006A	€ 9,20	6 mm	18 mm	95 mm
BN414L007A	€ 9,50	7 mm	18 mm	95 mm
BN414L008A	€ 9,50	8 mm	18 mm	95 mm
BN414L009A	€ 9,50	9 mm	20 mm	95 mm
BN414L010A	€ 9,50	10 mm	20 mm	95 mm
BN414L012A	€ 10,70	12 mm	20 mm	95 mm

BN424NX

BUSSOLA CON INSERTO TORX



Art.	€	Misura	D2	Lunghezza
BN424N010A	€ 6,80	T10	18 mm	48 mm
BN424N015A	€ 6,80	T15	18 mm	48 mm
BN424N020A	€ 6,80	T20	18 mm	48 mm
BN424N025A	€ 6,80	T25	18 mm	48 mm
BN424N027A	€ 6,80	T27	18 mm	48 mm
BN424N030A	€ 6,80	T30	18 mm	48 mm
BN424N040A	€ 6,80	T40	18 mm	48 mm
BN424N045A	€ 6,80	T45	18 mm	48 mm
BN424N050A	€ 7,70	T50	20 mm	48 mm
BN424N055A	€ 9,00	T55	20 mm	48 mm

BN424LX

BUSSOLA CON INSERTO TORX LUNGO



Art.	€	Misura	D2	Lunghezza
BN424L015A	€ 11,20	T15	18 mm	95 mm
BN424L020A	€ 11,20	T20	18 mm	95 mm
BN424L025A	€ 11,20	T25	18 mm	95 mm
BN424L027A	€ 11,20	T27	18 mm	95 mm
BN424L030A	€ 11,20	T30	18 mm	95 mm
BN424L040A	€ 11,20	T40	18 mm	95 mm
BN424L045A	€ 15,00	T45	18 mm	95 mm

BN434NX

BUSSOLA CON INSERTO RIBE



Art.	€	Misura	D2	Lunghezza
BN434N004A	€ 14,40	M 4	18 mm	50 mm
BN434N005A	€ 14,60	M 5	18 mm	50 mm
BN434N006A	€ 14,90	M 6	18 mm	50 mm
BN434N007A	€ 15,10	M 7	18 mm	50 mm
BN434N008A	€ 15,40	M 8	18 mm	50 mm
BN434N009A	€ 16,10	M 9	18 mm	50 mm
BN434N010A	€ 17,50	M 10	20 mm	50 mm

BN434LX

BUSSOLA CON INSERTO RIBE LUNGO

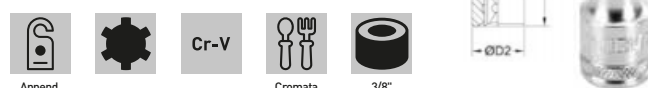

Art.	€	Misura	D2	Lunghezza
BN434L004A	€ 15,40	M 4	18 mm	95 mm
BN434L005A	€ 15,60	M 5	18 mm	95 mm
BN434L006A	€ 16,00	M 6	18 mm	95 mm
BN434L007A	€ 16,00	M 7	18 mm	95 mm
BN434L008A	€ 16,80	M 8	18 mm	95 mm
BN434L009A	€ 16,80	M 9	18 mm	95 mm
BN434L010A	€ 20,70	M 10	20 mm	95 mm

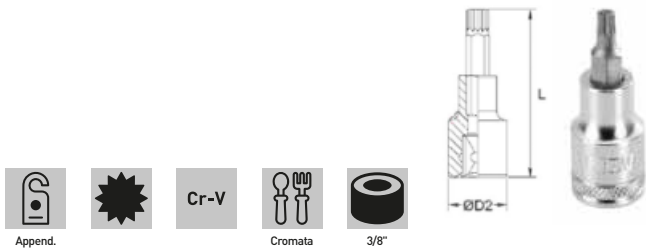
BN444NX
BUSSOLA CON INSERTO XZN

Art.	€	Misura	D2	Lunghezza
BN444N004A	€ 11,20	M 4	18 mm	48 mm
BN444N005A	€ 11,20	M 5	18 mm	48 mm
BN444N006A	€ 11,20	M 6	18 mm	48 mm
BN444N008A	€ 11,20	M 8	18 mm	48 mm
BN444N009A	€ 11,20	M 9	20 mm	48 mm
BN444N010A	€ 11,20	M 10	20 mm	48 mm
BN444N012A	€ 11,90	M 12	20 mm	48 mm
BN444N014A	€ 12,70	M 14	20 mm	48 mm

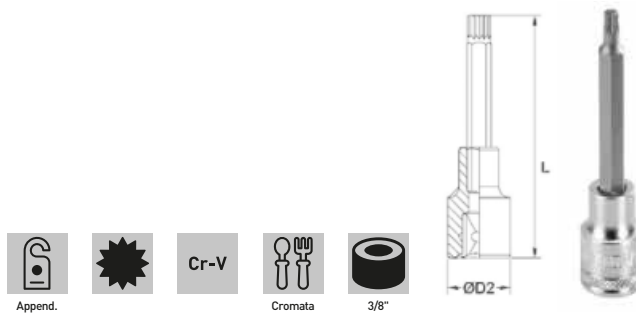
BN444LX
BUSSOLA CON INSERTO XZN LUNGO

Art.	€	Misura	D2	Lunghezza
BN444L004A	€ 12,30	M 4	18 mm	95 mm
BN444L005A	€ 12,30	M 5	18 mm	95 mm
BN444L006A	€ 12,30	M 6	18 mm	95 mm
BN444L008A	€ 12,30	M 8	18 mm	95 mm
BN444L009A	€ 12,30	M 9	20 mm	95 mm
BN444L010A	€ 12,70	M 10	20 mm	95 mm
BN444L012A	€ 13,50	M 12	20 mm	95 mm
BN444L014A	€ 14,50	M 14	20 mm	95 mm

BN4C4LX
CHIAVE A BUSSOLA PER CANDELA



Art.	€	Misura	Lunghezza
BN4C4L016A	€ 5,60	16 mm	63 mm
BN4C4L018A	€ 7,90	18 mm	63 mm
BN4C4L021A	€ 8,50	21 mm	65 mm

LN400N3/8A
€ 9,80
LEVA A T SCORREVOLE

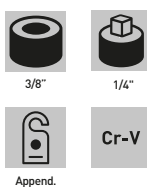

Lunghezza 200 mm

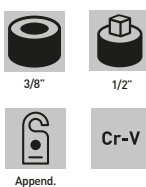
RN4045NA
€ 3,36
RACCORDO

Lunghezza 27 mm

RN4043NA
€ 3,92
RACCORDO

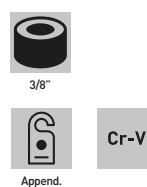
Lunghezza 35 mm

JN404NA
€ 7,70
SNODO A CARDANO

Lunghezza 54 mm

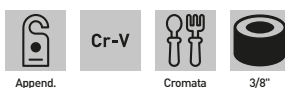
PN404NX
PROLUNGA

Art.	€	Lunghezza
PN404N050A	€ 3,80	50 mm
PN404N075A	€ 5,20	75 mm
PN404N150A	€ 6,30	150 mm

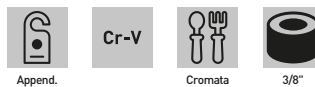
EN404NX
PROLUNGA A TESTA SFERICA

Art.	€	Lunghezza
EN404N038A	€ 4,46	38 mm
EN404N075A	€ 5,60	75 mm
EN404N150A	€ 6,80	150 mm
EN404N250A	€ 11,00	250 mm





BN4E3NX

CHIAVE A BUSSOLA ESAGONALE, SERIE NORMALE



Art.	€	Misura	D1	D2	Lunghezza
BN4E3N008A	€ 3,36	8 mm	12,2 mm	22 mm	38 mm
BN4E3N009A	€ 3,36	9 mm	13,5 mm	22 mm	38 mm
BN4E3N010A	€ 3,36	10 mm	15 mm	22 mm	38 mm
BN4E3N011A	€ 3,36	11 mm	16,3 mm	22 mm	38 mm
BN4E3N012A	€ 3,36	12 mm	17,6 mm	22 mm	38 mm
BN4E3N013A	€ 3,36	13 mm	18,8 mm	22 mm	38 mm
BN4E3N014A	€ 3,36	14 mm	20,4 mm	22 mm	38 mm
BN4E3N015A	€ 3,48	15 mm	21 mm	22 mm	38 mm
BN4E3N016A	€ 3,77	16 mm	22 mm	20,5 mm	38 mm
BN4E3N017A	€ 4,03	17 mm	24 mm	22 mm	38 mm
BN4E3N018A	€ 4,37	18 mm	25,4 mm	22 mm	38 mm
BN4E3N019A	€ 4,37	19 mm	26 mm	22 mm	38 mm
BN4E3N020A	€ 4,66	20 mm	28 mm	22 mm	38 mm
BN4E3N021A	€ 4,88	21 mm	28 mm	22 mm	38 mm
BN4E3N022A	€ 5,50	22 mm	30 mm	26 mm	38 mm
BN4E3N023A	€ 5,60	23 mm	31,6 mm	26 mm	38 mm
BN4E3N024A	€ 5,60	24 mm	32 mm	26 mm	38 mm
BN4E3N025A	€ 6,20	25 mm	34 mm	26 mm	42 mm
BN4E3N026A	€ 6,30	26 mm	35,4 mm	28 mm	42 mm
BN4E3N027A	€ 6,30	27 mm	36 mm	28 mm	42 mm
BN4E3N028A	€ 6,60	28 mm	38 mm	28 mm	42 mm
BN4E3N029A	€ 6,90	29 mm	38 mm	28 mm	43 mm
BN4E3N030A	€ 6,90	30 mm	40 mm	28 mm	43 mm
BN4E3N032A	€ 6,90	32 mm	42 mm	28 mm	44 mm

BN4E3LX

CHIAVE A BUSSOLA ESAGONALE LUNGA



Art.	€	Misura	D1	D2	Lunghezza
BN4E3L010A	€ 7,40	10 mm	15 mm	22 mm	77 mm
BN4E3L011A	€ 7,40	11 mm	16,3 mm	22 mm	77 mm
BN4E3L012A	€ 7,40	12 mm	17,6 mm	22 mm	77 mm
BN4E3L013A	€ 7,40	13 mm	18,8 mm	22 mm	77 mm
BN4E3L014A	€ 7,70	14 mm	20,4 mm	22 mm	77 mm
BN4E3L015A	€ 7,70	15 mm	21 mm	22 mm	77 mm
BN4E3L016A	€ 7,70	16 mm	22 mm	20,5 mm	77 mm
BN4E3L017A	€ 7,90	17 mm	24 mm	22 mm	77 mm
BN4E3L018A	€ 8,50	18 mm	25,4 mm	22 mm	77 mm
BN4E3L019A	€ 8,50	19 mm	26 mm	22 mm	77 mm
BN4E3L020A	€ 8,90	20 mm	28 mm	22 mm	77 mm
BN4E3L021A	€ 9,20	21 mm	28 mm	22 mm	77 mm
BN4E3L022A	€ 9,20	22 mm	30 mm	26 mm	77 mm
BN4E3L023A	€ 11,10	23 mm	31,6 mm	26 mm	77 mm
BN4E3L024A	€ 11,70	24 mm	32 mm	26 mm	77 mm
BN4E3L027A	€ 16,30	27 mm	36 mm	28 mm	77 mm
BN4E3L030A	€ 17,60	30 mm	40 mm	28 mm	77 mm
BN4E3L032A	€ 17,60	32 mm	42 mm	28 mm	77 mm

BN4P3NX

CHIAVE A BUSSOLA POLIGONALE, SERIE NORMALE



Art.	€	Misura	D1	D2	Lunghezza
BN4P3N008A	€ 3,14	8 mm	12,2 mm	22 mm	38 mm
BN4P3N009A	€ 3,14	9 mm	13,5 mm	22 mm	38 mm
BN4P3N010A	€ 3,14	10 mm	15 mm	22 mm	38 mm
BN4P3N011A	€ 3,14	11 mm	16,3 mm	22 mm	38 mm
BN4P3N012A	€ 3,14	12 mm	17,6 mm	22 mm	38 mm
BN4P3N013A	€ 3,14	13 mm	18,8 mm	22 mm	38 mm
BN4P3N014A	€ 3,14	14 mm	20,4 mm	22 mm	38 mm
BN4P3N015A	€ 3,26	15 mm	21 mm	22 mm	38 mm
BN4P3N016A	€ 3,48	16 mm	22 mm	20,5 mm	38 mm
BN4P3N017A	€ 3,80	17 mm	24 mm	22 mm	38 mm
BN4P3N018A	€ 4,14	18 mm	25,4 mm	22 mm	38 mm
BN4P3N019A	€ 4,14	19 mm	26 mm	22 mm	38 mm
BN4P3N020A	€ 4,37	20 mm	28 mm	22 mm	38 mm
BN4P3N021A	€ 4,58	21 mm	28 mm	22 mm	38 mm
BN4P3N022A	€ 5,20	22 mm	30 mm	26 mm	38 mm
BN4P3N023A	€ 5,30	23 mm	31,6 mm	26 mm	38 mm
BN4P3N024A	€ 5,30	24 mm	32 mm	26 mm	38 mm
BN4P3N025A	€ 6,20	25 mm	34 mm	26 mm	42 mm
BN4P3N026A	€ 6,30	26 mm	35,4 mm	28 mm	42 mm
BN4P3N027A	€ 6,30	27 mm	36 mm	28 mm	42 mm
BN4P3N028A	€ 6,60	28 mm	38 mm	28 mm	43 mm
BN4P3N029A	€ 6,90	29 mm	38 mm	28 mm	43 mm
BN4P3N030A	€ 6,90	30 mm	40 mm	28 mm	43 mm
BN4P3N032A	€ 6,90	32 mm	42 mm	28 mm	44 mm

BN4P3LX

CHIAVE A BUSSOLA POLIGONALE LUNGA

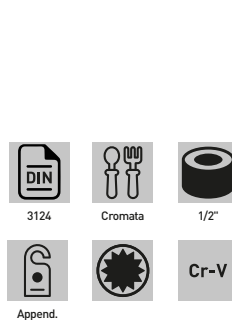

Art.	€	Misura	D1	D2	Lunghezza
BN4P3L010A	€ 6,90	10 mm	15 mm	22 mm	77 mm
BN4P3L011A	€ 6,90	11 mm	16,3 mm	22 mm	77 mm
BN4P3L012A	€ 6,90	12 mm	17,6 mm	22 mm	77 mm
BN4P3L013A	€ 6,90	13 mm	18,8 mm	22 mm	77 mm
BN4P3L014A	€ 7,10	14 mm	20,4 mm	22 mm	77 mm
BN4P3L015A	€ 7,10	15 mm	21 mm	22 mm	77 mm
BN4P3L016A	€ 7,10	16 mm	22 mm	20,5 mm	77 mm
BN4P3L017A	€ 7,50	17 mm	24 mm	22 mm	77 mm
BN4P3L018A	€ 8,00	18 mm	25,4 mm	22 mm	77 mm
BN4P3L019A	€ 8,00	19 mm	26 mm	22 mm	77 mm
BN4P3L020A	€ 8,40	20 mm	28 mm	22 mm	77 mm
BN4P3L021A	€ 8,70	21 mm	28 mm	22 mm	77 mm
BN4P3L022A	€ 9,20	22 mm	30 mm	26 mm	77 mm
BN4P3L023A	€ 11,10	23 mm	31,6 mm	26 mm	77 mm
BN4P3L024A	€ 11,10	24 mm	32 mm	26 mm	77 mm
BN4P3L027A	€ 16,30	27 mm	36 mm	28 mm	77 mm
BN4P3L030A	€ 17,60	30 mm	40 mm	28 mm	77 mm
BN4P3L032A	€ 17,60	32 mm	42 mm	28 mm	77 mm

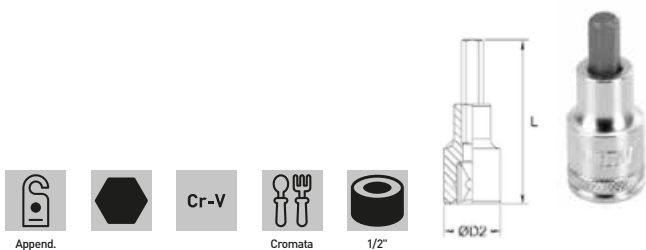
BN413NX
BUSSOLA CON INSERTO ESAGONALE

Art.	€	Misura	D2	Lunghezza
BN413N004A	€ 6,40	4 mm	22 mm	55 mm
BN413N005A	€ 6,40	5 mm	22 mm	55 mm
BN413N006A	€ 6,40	6 mm	22 mm	55 mm
BN413N007A	€ 7,00	7 mm	22 mm	55 mm
BN413N008A	€ 7,00	8 mm	22 mm	55 mm
BN413N010A	€ 7,00	10 mm	22 mm	55 mm
BN413N012A	€ 7,00	12 mm	22 mm	55 mm
BN413N014A	€ 8,40	14 mm	24 mm	55 mm
BN413N017A	€ 9,00	17 mm	26 mm	55 mm
BN413N019A	€ 9,00	19 mm	28 mm	55 mm

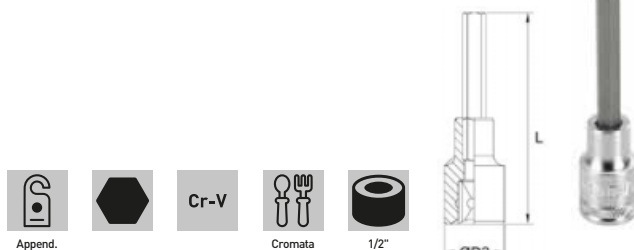
BN413LX
BUSSOLA CON INSERTO ESAGONALE LUNGO

Art.	€	Misura	D2	Lunghezza
BN413L004A	€ 8,40	4 mm	22 mm	100 mm
BN413L005A	€ 8,40	5 mm	22 mm	100 mm
BN413L006A	€ 8,40	6 mm	22 mm	100 mm
BN413L007A	€ 8,40	7 mm	22 mm	100 mm
BN413L008A	€ 8,40	8 mm	22 mm	100 mm
BN413L010A	€ 8,40	10 mm	22 mm	100 mm
BN413L012A	€ 8,50	12 mm	22 mm	100 mm
BN413L014A	€ 8,50	14 mm	24 mm	100 mm
BN413L017A	€ 12,30	17 mm	26 mm	100 mm
BN413L019A	€ 13,20	19 mm	28 mm	100 mm

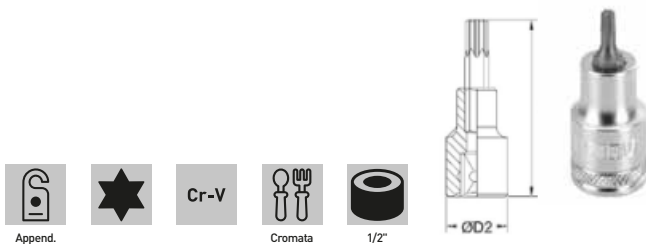
BN423NX
BUSSOLA CON INSERTO TORX

Art.	€	Misura	D2	Lunghezza
BN423N020A	€ 8,00	T20	22 mm	55 mm
BN423N025A	€ 8,00	T25	22 mm	55 mm
BN423N027A	€ 8,00	T27	22 mm	55 mm
BN423N030A	€ 8,00	T30	22 mm	55 mm
BN423N040A	€ 8,60	T40	22 mm	55 mm
BN423N045A	€ 8,60	T45	22 mm	55 mm
BN423N050A	€ 8,60	T50	22 mm	55 mm
BN423N055A	€ 9,70	T55	22 mm	55 mm
BN423N060A	€ 10,20	T60	22 mm	55 mm
BN423N070A	€ 12,50	T70	22 mm	55 mm

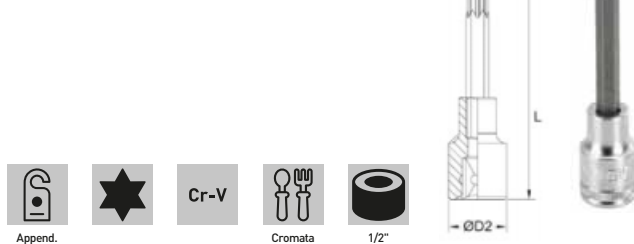
BN423LX
BUSSOLA CON INSERTO TORX LUNGO

Art.	€	Misura	D2	Lunghezza
BN423L020A	€ 9,00	T20	22 mm	100 mm
BN423L025A	€ 9,00	T25	22 mm	100 mm
BN423L027A	€ 9,00	T27	22 mm	100 mm
BN423L030A	€ 9,00	T30	22 mm	100 mm
BN423L040A	€ 9,50	T40	22 mm	100 mm
BN423L045A	€ 9,50	T45	22 mm	100 mm
BN423L050A	€ 9,50	T50	22 mm	100 mm
BN423L055A	€ 11,20	T55	22 mm	100 mm
BN423L060A	€ 11,20	T60	22 mm	100 mm
BN423L070A	€ 15,10	T70	22 mm	100 mm

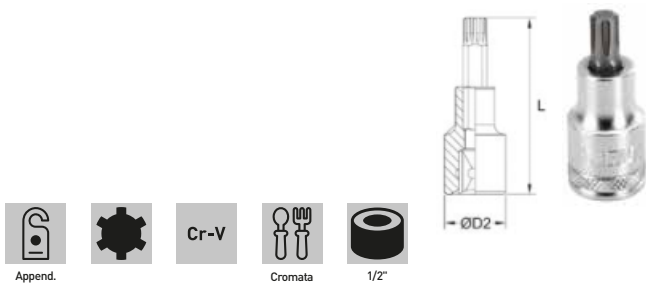
BN433NX
BUSSOLA CON INSERTO RIBE

Art.	€	Misura	D2	Lunghezza
BN433N008A	€ 8,60	M 8	22 mm	55 mm
BN433N009A	€ 8,60	M 9	22 mm	55 mm
BN433N010A	€ 8,60	M 10	22 mm	55 mm
BN433N012A	€ 9,50	M 12	22 mm	55 mm
BN433N013A	€ 10,10	M 13	24 mm	55 mm
BN433N014A	€ 10,10	M 14	24 mm	55 mm

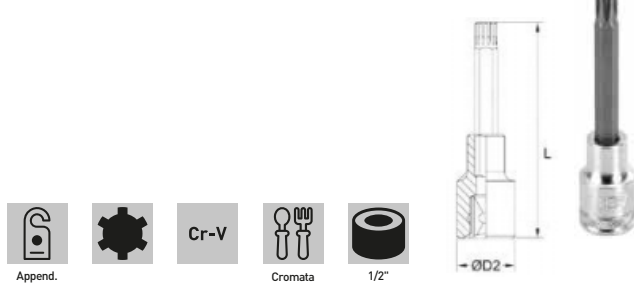
BN433LX
BUSSOLA CON INSERTO RIBE LUNGO

Art.	€	Misura	D2	Lunghezza
BN433L008A	€ 10,70	M 8	24 mm	100 mm
BN433L009A	€ 10,70	M 9	24 mm	100 mm
BN433L010A	€ 10,70	M 10	24 mm	100 mm
BN433L012A	€ 11,70	M 12	24 mm	100 mm
BN433L013A	€ 11,70	M 13	24 mm	100 mm
BN433L014A	€ 13,50	M 14	24 mm	100 mm



BN443NX

BUSSOLA CON INSERTO XZN

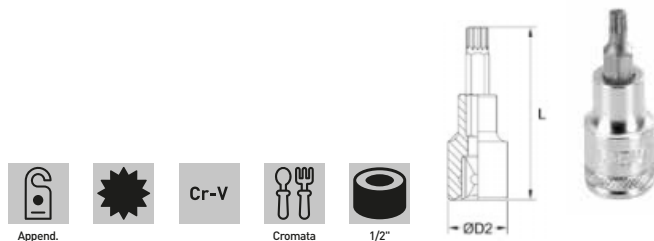

Art.	€	Misura	D2	Lunghezza
BN443N005A	€ 9,00	M 5	22 mm	55 mm
BN443N006A	€ 9,00	M 6	22 mm	55 mm
BN443N008A	€ 9,00	M 8	22 mm	55 mm
BN443N009A	€ 9,00	M 9	22 mm	55 mm
BN443N010A	€ 9,00	M 10	22 mm	55 mm
BN443N012A	€ 10,20	M 12	22 mm	55 mm
BN443N014A	€ 10,20	M 14	24 mm	55 mm
BN443N016A	€ 10,30	M 16	24 mm	55 mm

BN443LX

BUSSOLA CON INSERTO XZN LUNGO

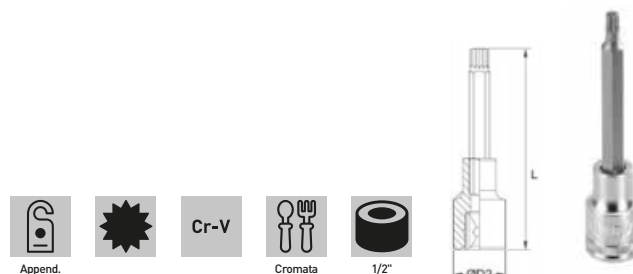

Art.	€	Misura	D2	Lunghezza
BN443L005A	€ 10,30	M 5	22 mm	100 mm
BN443L006A	€ 10,30	M 6	22 mm	100 mm
BN443L008A	€ 10,30	M 8	22 mm	100 mm
BN443L009A	€ 10,80	M 9	22 mm	100 mm
BN443L010A	€ 10,80	M 10	22 mm	100 mm
BN443L012A	€ 11,30	M 12	22 mm	100 mm
BN443L014A	€ 12,00	M 14	24 mm	100 mm
BN443L016A	€ 12,40	M 16	24 mm	100 mm

BN4C3LX

CHIAVE A BUSSOLA PER CANDELA



Art.	€	Misura	Lunghezza
BN4C3L016A	€ 5,20	16 mm	65 mm
BN4C3L018A	€ 6,10	18 mm	65 mm
BN4C3L021A	€ 7,40	21 mm	65 mm



PN403NX

PROLUNGA



Art.	€	Lunghezza
PN403N050A	€ 5,40	50 mm
PN403N075A	€ 6,80	75 mm
PN403N150A	€ 9,60	150 mm
PN403N250A	€ 11,80	250 mm



EN403NX

PROLUNGA A TESTA SFERICA

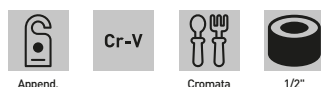

Art.	€	Attacco quadro	Lunghezza
EN403N050A	€ 6,30	1/2"	50 mm
EN403N075A	€ 6,80	1/2"	75 mm
EN403N125A	€ 9,60	1/2"	125 mm
EN403N250A	€ 16,30	1/2"	250 mm
EN403N500A	€ 27,30	1/2"	500 mm

LN400N1/2A

€ 13,20

LEVA A T SCORREVOLE



Lunghezza 300 mm

RN4034NA

€ 3,92

RACCORDO



Lunghezza 36 mm



RN4032NA

€ 9,00

RACCORDO



Lunghezza 46 mm



JN403NA

€ 11,10

SNODO A CARDANO

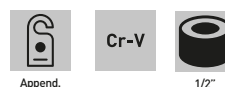

Lunghezza 75 mm

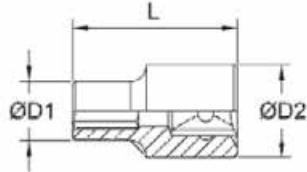

BN4E2NX
CHIAVE A BUSSOLA ESAGONALE, SERIE NORMALE

Art.	€	Misura	D1	D2	Lunghezza
BN4E2N019	€ 8,50	19 mm	30 mm	36 mm	50 mm
BN4E2N020	€ 8,50	20 mm	31 mm	36 mm	50 mm
BN4E2N021	€ 8,50	21 mm	32 mm	36 mm	50 mm
BN4E2N022	€ 8,50	22 mm	33 mm	36 mm	50 mm
BN4E2N023	€ 8,50	23 mm	34 mm	36 mm	50 mm
BN4E2N024	€ 8,50	24 mm	35 mm	36 mm	50 mm
BN4E2N025	€ 8,50	25 mm	36 mm	35 mm	52 mm
BN4E2N026	€ 8,50	26 mm	37 mm	36 mm	52 mm
BN4E2N027	€ 10,10	27 mm	38 mm	36 mm	52 mm
BN4E2N028	€ 10,10	28 mm	39 mm	38 mm	52 mm
BN4E2N029	€ 10,10	29 mm	40 mm	38 mm	52 mm
BN4E2N030	€ 10,10	30 mm	42 mm	38 mm	54 mm
BN4E2N032	€ 10,10	32 mm	43 mm	38 mm	56 mm
BN4E2N033	€ 10,70	33 mm	44 mm	38 mm	56 mm
BN4E2N034	€ 10,70	34 mm	46 mm	38 mm	56 mm
BN4E2N035	€ 11,00	35 mm	47 mm	42 mm	56 mm
BN4E2N036	€ 11,00	36 mm	48 mm	42 mm	58 mm
BN4E2N038	€ 13,20	38 mm	50 mm	42 mm	58 mm
BN4E2N041	€ 14,90	41 mm	52 mm	45 mm	60 mm
BN4E2N046	€ 16,50	46 mm	56 mm	45 mm	64 mm
BN4E2N050	€ 19,80	50 mm	62 mm	48 mm	68 mm
BN4E2N055	€ 24,20	55 mm	68 mm	48 mm	72 mm
BN4E2N060	€ 30,00	60 mm	74 mm	48 mm	76 mm

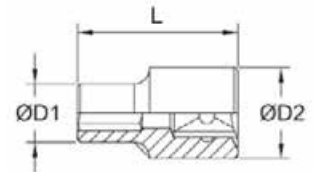
BN4P2NX
CHIAVE A BUSSOLA POLIGONALE, SERIE NORMALE

Art.	€	Misura	D1	D2	Lunghezza
BN4P2N019	€ 7,90	19 mm	30 mm	36 mm	50 mm
BN4P2N020	€ 7,90	20 mm	31 mm	36 mm	50 mm
BN4P2N021	€ 7,90	21 mm	32 mm	36 mm	50 mm
BN4P2N022	€ 7,90	22 mm	33 mm	36 mm	50 mm
BN4P2N023	€ 7,90	23 mm	34 mm	36 mm	50 mm
BN4P2N024	€ 7,90	24 mm	35 mm	36 mm	50 mm
BN4P2N025	€ 7,90	25 mm	36 mm	35 mm	52 mm
BN4P2N026	€ 7,90	26 mm	37 mm	36 mm	52 mm
BN4P2N027	€ 9,60	27 mm	38 mm	36 mm	52 mm
BN4P2N028	€ 9,60	28 mm	39 mm	38 mm	52 mm
BN4P2N029	€ 9,60	29 mm	40 mm	38 mm	52 mm
BN4P2N030	€ 9,60	30 mm	42 mm	38 mm	54 mm
BN4P2N032	€ 9,60	32 mm	43 mm	38 mm	56 mm
BN4P2N033	€ 10,10	33 mm	44 mm	38 mm	56 mm
BN4P2N034	€ 10,70	34 mm	46 mm	38 mm	56 mm
BN4P2N035	€ 10,70	35 mm	47 mm	42 mm	56 mm
BN4P2N036	€ 10,70	36 mm	48 mm	42 mm	58 mm
BN4P2N038	€ 12,50	38 mm	50 mm	42 mm	58 mm
BN4P2N041	€ 14,10	41 mm	52 mm	45 mm	60 mm
BN4P2N046	€ 15,60	46 mm	56 mm	45 mm	64 mm
BN4P2N050	€ 18,80	50 mm	62 mm	48 mm	68 mm
BN4P2N055	€ 24,20	55 mm	68 mm	48 mm	72 mm
BN4P2N060	€ 30,00	60 mm	74 mm	48 mm	76 mm

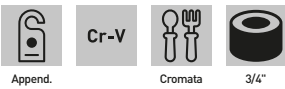
PN402NX
PROLUNGA

Art.	€	Lunghezza
PN402N200A	€ 19,80	200 mm
PN402N400A	€ 30,50	400 mm

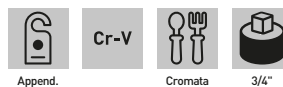
LN400N3/4A
€ 32,70
LEVA A T SCORREVOLE

Lunghezza	500 mm
-----------	--------

RN4023NA
€ 9,00
RACCORDO

Lunghezza	50 mm
-----------	-------

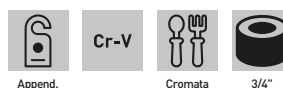
JN402NA
€ 45,20
SNODO A CARDANO

Lunghezza	110 mm
-----------	--------



0795/2

€ 67,20

SERIE CHIAVI MULTILOCK

Adatte per dadi e bulloni metrici, a pollici, torx e XZN.



19 Pcs



Valigetta



Cr-V



Cromata



1/2"



Misure 8 - 9 - 10 - 11 - 12 - 13 - 14 - 15 - 16 - 17 - 18 - 19 - 20 - 21 - 22 - 24 - 27 - 30 - 32 mm

Misure in pollici 3/8" - 7/16" - 15/32" - 1/2" - 19/32" - 5/8" - 3/4" - 25/32" - 13/16" - 7/8" - 15/16" - 1-1/16" - 1-13/16" - 1-1/4"

Misure torx E12 - E14 - E16 - E18 - E20 - E22 - E24 - E26 - E28 - E30 - E34 - E38 - E40

Misure XZN M12 - M14 - M16 - M18

0195

€ 48,90

SERIE CHIAVI A BUSSOLA TORX

Adatte per bulloni torx.



28 Pcs



Valigetta



Cr-V



Cromata



1/4" | 3/8" | 1/2"



Misure torx 1/4": E4 - E5 - E6 - E7 - E8 - E10 - E11 3/8": E4 - E5 - E6 - E7 - E8 - E10 - E11 - E12 - E14 - E16 - E18 - E20 1/2": E10 - E11 - E12 - E14 - E16 - E18 - E20 - E22 - E24

SN4E4C013

€ 81,40

SERIE BUSSOLE A PROFILO RIBASSATO

Composto da 12 bussole e 1 cricchetto reversibile ribassato a 60 denti, di altezza ridotta per poter operare in piccoli spazi.



13 Pcs



Scatola



Cr-V



Cromata



3/8"



Bussole 8, 9, 10, 11, 12, 13, 14, 15, 16, 17, 18, 19 mm

0795/1

€ 24,40

SERIE CHIAVI MULTILOCK

Adatte per dadi e bulloni metrici, a pollici, torx e XZN.



13 Pcs



Valigetta



Cr-V



Cromata



1/4"



Misure 4 - 4,5 - 5 - 5,5 - 6 - 7 - 8 - 9 - 10 - 11 - 12 - 13 - 14 mm

Misure in pollici 5/32" - 7/32" - 1/4" - 5/16" - 11/32" - 3/8" - 7/16" - 15/32" - 1/2"

Misure torx E5 - E6 - E8 - E10 - E12 - E14 - E16 - E18

Misure XZN M5 - M6 - M8 - M9 - M10 - M12 - M14 - M16 - M18

SN4E5C012

€ 62,30

SERIE BUSSOLE A PROFILO RIBASSATO

Composto da 11 bussole e 1 cricchetto reversibile ribassato a 60 denti, di altezza ridotta per poter operare in piccoli spazi.



12 Pcs



Scatola



Cr-V



Cromata



1/4"



Bussole 4, 5, 6, 7, 8, 9, 10, 11, 12, 13, 14 mm

SN4E3C015

€ 104,00

SERIE BUSSOLE A PROFILO RIBASSATO

Composto da 14 bussole e 1 cricchetto reversibile ribassato a 60 denti, di altezza ridotta per poter operare in piccoli spazi.



15 Pcs



Scatola



Cr-V



Cromata



1/2"



Bussole 8, 10, 11, 12, 13, 14, 15, 17, 18, 19, 21, 22, 23, 24 mm

0589
€ 75,10
SERIE BUSSOLE MULTIPROFILO RIBASSATE

Con foro passante, composto da 11 bussole, 1 cricchetto reversibile ribassato con foro passante e accessori, adatte a esagoni metrici, in pollici, torx, XZN, barre filettate e prigionieri, di altezza ridotta per poter operare in piccoli spazi.

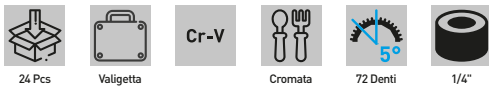

Bussole	4.5 - 5 - 5.5 - 6 - 7 - 8 - 9 - 10 - 11 - 12 - 13 mm
Cricchetto reversibile	
Prolunga	50 mm
Adattatore	1/4"
Adattatore inserti	
Inserti	PH: 1 - 2 - 3 (S2) Torx: T10-T15-T20-T25-T30-T40 (S2)

0624
€ 70,70
SERIE CHIAVI A BUSSOLA DA 1/4"

Bussole da 1/4"	4 - 4.5 - 5 - 5.5 - 6 - 7 - 8 - 9 - 10 - 11 - 12 - 13 - 14 mm
Bussole con inserti	1/4" : T8 - T10 - T15 - T20 - T25 - T30 - T40 - H3 - H4 - H5 - H6 - H7 - H8 - SL4 - SL5.5 - SL7 - PH1 - PH2 - PH3 - PZ1 - PZ2 - PZ3
Cricchetto reversibile	1/4"
Prolunga flessibile	1/4" - 150 mm
Prolunghe da 1/4"	50 - 100 mm
Manico per bussole	1/4"
Snodo universale	1/4"
Leva a T scorrevole	1/4"
Chiavi esagonali	1,27 - 1,5 - 2 - 2.5 mm

S520
€ 43,10
SERIE BUSSOLE ESAGONALI A POLLICE DA 1/4"

Bussole da 1/4"	5/32", 3/16", 7/32", 1/4", 9/32" 5/16", 11/32", 3/8", 13/32", 7/16", 15/32", 1/2", 9/16"
Snodo universale	1/4"
Prolunghe da 1/4"	2", 4", 6"
Leva a T scorrevole	1/4"
Manico per bussole	1/4"
Cricchetto reversibile	1/4"

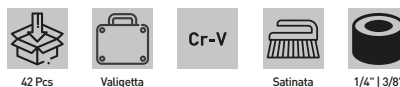
0679
€ 80,90
SERIE CHIAVI A BUSSOLA DA 3/8" E 1/4"

Bussole da 3/8"	9 - 10 - 11 - 12 - 13 - 14 - 15 - 17 - 19 mm
Misure bussole per candela	3/8" : 16 - 21 mm
Prolunghe da 3/8"	75 - 150 mm
Snodo universale	3/8"
Raccordo	F. 1/2" - M. 3/8"
Cricchetto reversibile	3/8"
Bussole da 1/4"	4 - 4.5 - 5 - 5.5 - 6 - 7 - 8 - 9 - 10 - 11 - 12 - 13 mm
Manico per bussole	1/4"
Raccordo	F. 3/8" - M. 1/4"
Bussola porta inserti	1/4"
Inserti	PH1 - PH2 - PH3 - H3 - H4 - H5 - H6 - H7 - SL4 - SL5.5 - SL7



S328

€ 141,00

SERIE CHIAVI A BUSSOLA DA 1/2"



Bussole da 1/2"	8 - 9 - 10 - 11 - 12 - 13 - 14 - 15 - 16 - 17 - 18 - 19 - 20 - 21 - 22 - 23 - 24 - 27 - 30 - 32 mm
Misure bussole per candela	1/2" : 16 - 21 mm
Prolunghe da 1/2"	75 - 150 - 250 mm
Snodo universale	1/2"
Raccordo	F. 3/8" - M. 1/2"
Cricchetto reversibile	1/2"

SN4P3N027

€ 125,00

SERIE BUSSOLE ESAGONALI A POLLICE DA 1/2"

Composta da 20 bussole normali, 2 bussole per candela, 1 cricchetto reversibile, 1 snodo universale, 2 prolunghe e 1 leva a T scorrevole.



Misure bussole normali	5/16", 3/8", 7/16", 15/32", 1/2", 9/16", 19/32", 5/8", 11/16", 3/4", 25/32", 13/16", 7/8", 15/16", 1", 1-1/16", 1-3/16", 1-1/4", 23/32", 1-1/8"
Misure bussole per candela	5/8", 13/16"
Misure prolunghe	3", 10"

0620

€ 125,00

SERIE CHIAVI A BUSSOLA DA 1/2"



Bussole da 1/2"	10 - 11 - 12 - 13 - 14 - 15 - 16 - 17 - 18 - 19 - 20 - 21 - 22 - 23 - 24 - 27 - 30 - 32 mm
Misure bussole per candela	1/2" : 21 mm
Prolunghe da 1/2"	125 - 250 mm
Snodo universale	1/2"
Leva a T scorrevole	1/2"
Cricchetto reversibile	1/2"

0181

€ 167,00

SERIE CHIAVI A BUSSOLA DA 3/4"



Misure	19 - 21 - 22 - 23 - 24 - 26 - 27 - 30 - 32 - 34 - 36 - 38 - 41 - 46 - 48 - 50 mm
Cricchetto reversibile	3/4"
Leva a T scorrevole	3/4"
Prolunghe	3/4" : 100 - 200 mm

0622
€ 53,20
SERIE BUSSOLE CON INSERTI TORX

Misure T20 - T25 - T27 - T30 - T40 T45 - T50 - T55 - T60 - T70

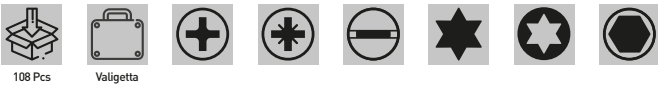
S108
€ 188,00
SERIE CHIAVI A BUSSOLA

Bussole da 1/4"	4 - 4.5 - 5 - 5.5 - 6 - 7 - 8 - 9 - 10 - 11 - 12 - 13 - 14 mm
Bussole lunghe da 1/4"	6 - 7 - 8 - 9 - 10 - 11 - 12 - 13 mm
Bussole lunghe da 1/4"	Torx: E4 - E5 - E6 - E7 - E8 mm
Bussole da 1/2"	10 - 11 - 12 - 13 - 14 - 15 - 16 - 17 - 18 - 19 - 20 - 21 - 22 - 24 - 27 - 30 - 32 mm
Bussole lunghe da 1/2"	14 - 15 - 17 - 19 - 22 mm
Bussole da 1/2"	Torx: E10 - E11 - E12 - E14 - E16 - E18 - E20 - E24
Bussole con inserti	1/4" : T8 - T10 - T15 - T20 - T25 - T27 - T30 - H3 - H4 - H5 - H6 - SL4 - SL5.5 - SL6.5 - PH1 - PH2 - PZ1 - PZ2
Misure bussole per candela	1/2" : 16 - 21 mm
Bussole porta inserti	1/2"
Inserti	5/16" x 30 mm : H7 - H8 - H10 - H12 - H14 - SL8 - SL10 - SL12 - PH3 - PH4 - PZ3 - PZ4 - T40 - T45 - T50 - T55 - T60
Prolunghe da 1/4"	50 - 85 mm
Prolunghe da 1/2"	125 - 250 mm
Manico per bussole	1/4"
Raccordo	F. 3/8" - M. 1/2"
Snodo universale	1/4"
Snodo universale	1/2"
Leva a T scorrevole	1/4"
Cricchetto reversibile	1/4"
Cricchetto reversibile	1/2"
Chiavi esagonali	1.5 - 2 - 2.5 mm

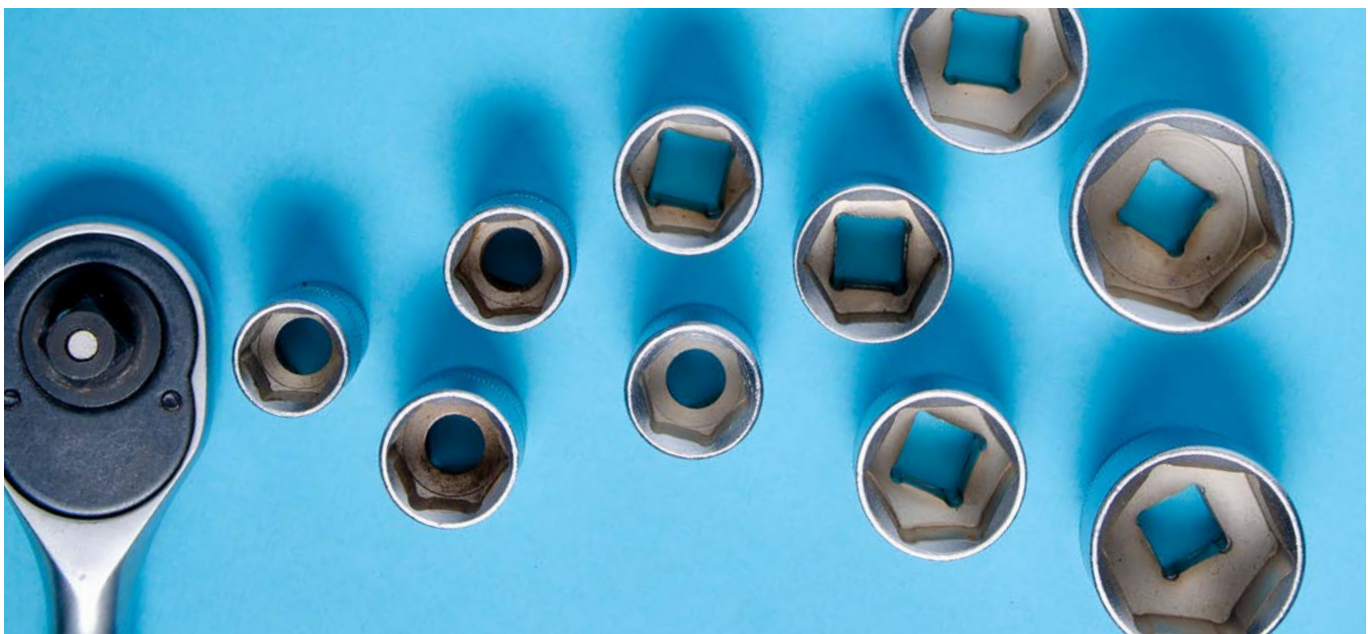



0618

€ 208,00

SERIE CHIAVI A BUSSOLA DA 1/2" E 1/4"



Bussole da 1/4"	4 - 4.5 - 5 - 5.5 - 6 - 7 - 8 - 9 - 10 - 11 - 12 - 13 - 14 mm
Bussole lunghe da 1/4"	6 - 7 - 8 - 9 - 10 - 11 - 12 - 13 mm
Adattatore maschio con quadro da 1/4" e esagono da 1/4"	
Bussole da 1/2"	10 - 11 - 12 - 13 - 14 - 15 - 16 - 17 - 18 - 19 - 20 - 21 - 22 - 23 - 24 - 27 - 30 - 32 mm
Bussole lunghe da 1/2"	14 - 15 - 17 - 19 mm
Prolunga flessibile	1/4" - 150 mm
Bussole con inserti	1/4" : T8 - T10 - T15 - T20 - T25 - T30 - H3 - H4 - H5 - H6 - SL4 - SL5.5 - SL7 - PH1 - PH2 - PZ1 - PZ2
Misure bussole per candela	1/2" : 16 - 21 mm
Bussole per inserti da 5/16"	1/2"
Inserti	5/16" x 30 mm : H8 - H10 - H12 - H14 - SL8 - SL10 - SL12 - PH3 - PH4 - PZ3 - PZ4 - T40 - T45 - T50 - T55
Prolunghe da 1/4"	50 - 100 mm
Prolunghe da 1/2"	125 - 250 mm
Manico per bussole	1/4"
Raccordo	F. 3/8" - M. 1/2"
Snodo universale	1/4"
Snodo universale	1/2"
Leva a T scorrevole	1/4"
Cricchetto reversibile	1/4"
Cricchetto reversibile	1/2"
Chiavi esagonali	1.5 - 2 - 2.5 mm



S179

€ 322,00

SERIE CHIAVI A BUSSOLA



Bussole da 1/4"	4 - 4.5 - 5 - 5.5 - 6 - 7 - 8 - 9 - 10 - 11 - 12 - 13 - 14 mm
Bussole lunghe da 1/4"	6 - 7 - 8 - 9 - 10 mm
Bussole lunghe da 1/4"	Torx: E4 - E5 - E6 - E7 - E8 mm
Prolunghe da 1/4"	50 - 100 mm
Leva a T scorrevole	1/4"
Bussole porta inserti	1/4"
Bussole con inserti	1/4" - Torx: T8 - T9 - T10 - T15 - T20 - T25 - T27 - T30
Bussole con inserti con foro	1/4" - Torx: T8H - T9H - T10H - T15H - T20H - T25H - T27H - T30H
Bussole con inserti	1/4" : PH0 - PH1 - PH2
Bussole con inserti	1/4" : PZ0 - PZ1 - PZ2
Bussole con inserti esagonali	1/4" : 3 - 4 - 5 - 6 mm
Bussole con inserti a taglio	1/4" : 4 - 5.5 - 6.5 - 7 mm
Snodo universale	1/4"
Manico per bussole	1/4"
Cricchetto reversibile	1/4"
Bussole da 3/8"	10 - 11 - 12 - 13 - 14 - 15 - 16 - 17 - 18 - 19 mm
Bussole da 3/8"	Torx: E10 - E11 - E12 - E13
Bussole lunghe da 3/8"	10 - 11 - 12 - 13 - 14 - 15 mm
Misure bussole per candela	3/8" - 18 mm
Prolunghe da 3/8"	150 mm
Bussole per inserti da 5/16"	3/8"
Snodo universale	3/8"
Cricchetto reversibile	3/8"
Bussole da 1/2"	10 - 11 - 12 - 13 - 14 - 15 - 16 - 17 - 18 - 19 - 20 - 21 - 22 - 24 - 27 - 30 - 32 mm
Bussole lunghe da 1/2"	16 - 17 - 18 - 19 - 22 mm
Bussole da 1/2"	Torx: E16 - E18 - E20 - E24
Misure bussole per candela	1/2" : 16 - 21 mm
Prolunghe da 1/2"	125 - 250 mm



Bussole per inserti da 5/16"	1/2"
Snodo universale	1/2"
Raccordo	F. 3/8" - M. 1/2"
Cricchetto reversibile	1/2"
Inserti	1/4" x 25 mm XZN: M5 - M6 - M8
Inserti	1/4" x 25 mm Torx: T5 - T6 - T7 - T8 - T9 - T10 - T15 - T20 - T25 - T27 - T30
Inserti	1/4" x 25 mm Ribe: RM5 - RM6 - RM7 - RM8 - RM9
Inserti	1/4" x 25 mm Torx "5": TS7 - TS10 - TS15 - TS20 - TS25 - TS27 - TS30 - TS40 - TS45
Inserti	5/16" x 30 mm Torx: T40 - T45 - T50 - T55 - T60 - T70
Inserti con foro	5/16" x 30 mm Torx: T40H - T45H - T50H - T55H - T60H - T70H
Inserti esagonali	5/16" x 30 mm: 7 - 8 - 10 - 12 - 14 mm
Inserti	5/16" x 30 mm: PH3 - PH4
Inserti	5/16" x 30 mm: PZ3 - PZ4
Inserti a taglio	5/16" x 30 mm: 8 - 10 - 12 mm
Chiavi esagonali	1.3 - 1.5 - 2 - 2.5 - 3 - 4 - 5 mm

BI4E3NX
CHIAVE A BUSSOLA AD IMPATTO, SERIE NORMALE

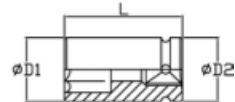
Cr-Mo

Art.	€	Misura	D1	D2	Lunghezza
BI4E3N008	€ 4,24	8 mm	15 mm	24 mm	38 mm
BI4E3N009	€ 4,24	9 mm	16 mm	24 mm	38 mm
BI4E3N010	€ 4,24	10 mm	17,5 mm	24 mm	38 mm
BI4E3N011	€ 4,24	11 mm	18,5 mm	24 mm	38 mm
BI4E3N012	€ 4,24	12 mm	19,5 mm	24 mm	38 mm
BI4E3N013	€ 4,24	13 mm	20,5 mm	24 mm	38 mm
BI4E3N014	€ 4,24	14 mm	22 mm	24 mm	38 mm
BI4E3N015	€ 4,79	15 mm	24 mm	24 mm	38 mm
BI4E3N016	€ 4,79	16 mm	24 mm	24 mm	38 mm
BI4E3N017	€ 4,79	17 mm	26 mm	26 mm	38 mm
BI4E3N018	€ 4,79	18 mm	28 mm	28 mm	38 mm
BI4E3N019	€ 4,79	19 mm	28 mm	28 mm	38 mm
BI4E3N020	€ 5,80	20 mm	30 mm	30 mm	38 mm
BI4E3N021	€ 5,80	21 mm	30 mm	30 mm	38 mm
BI4E3N022	€ 5,80	22 mm	32 mm	30 mm	38 mm
BI4E3N023	€ 6,10	23 mm	34 mm	30 mm	38 mm
BI4E3N024	€ 6,10	24 mm	34 mm	30 mm	38 mm
BI4E3N025	€ 6,10	25 mm	36 mm	30 mm	38 mm
BI4E3N026	€ 6,80	26 mm	36 mm	30 mm	38 mm
BI4E3N027	€ 6,80	27 mm	38 mm	30 mm	42 mm
BI4E3N028	€ 8,10	28 mm	40 mm	30 mm	42 mm
BI4E3N029	€ 8,10	29 mm	42 mm	30 mm	42 mm
BI4E3N030	€ 8,70	30 mm	42 mm	30 mm	42 mm
BI4E3N031	€ 8,90	31 mm	44 mm	30 mm	42 mm
BI4E3N032	€ 9,80	32 mm	44 mm	30 mm	44 mm

BI4E3LX
CHIAVE A BUSSOLA AD IMPATTO LUNGA

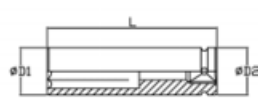
Cr-Mo

Art.	€	Misura	D1	D2	Lunghezza
BI4E3L008	€ 7,00	8 mm	15 mm	24 mm	78 mm
BI4E3L009	€ 7,00	9 mm	16 mm	24 mm	78 mm
BI4E3L010	€ 7,00	10 mm	17,5 mm	24 mm	78 mm
BI4E3L011	€ 7,00	11 mm	18,5 mm	24 mm	78 mm
BI4E3L012	€ 7,00	12 mm	19,5 mm	24 mm	78 mm
BI4E3L013	€ 7,00	13 mm	20,5 mm	24 mm	78 mm
BI4E3L014	€ 7,00	14 mm	22 mm	24 mm	78 mm
BI4E3L015	€ 8,40	15 mm	24 mm	24 mm	78 mm
BI4E3L016	€ 8,40	16 mm	24 mm	24 mm	78 mm
BI4E3L017	€ 8,40	17 mm	26 mm	26 mm	78 mm
BI4E3L018	€ 8,40	18 mm	28 mm	28 mm	78 mm
BI4E3L019	€ 8,40	19 mm	28 mm	28 mm	78 mm
BI4E3L020	€ 8,40	20 mm	30 mm	30 mm	78 mm
BI4E3L021	€ 8,40	21 mm	30 mm	30 mm	78 mm
BI4E3L022	€ 8,70	22 mm	32 mm	30 mm	78 mm
BI4E3L023	€ 8,90	23 mm	34 mm	30 mm	78 mm
BI4E3L024	€ 10,20	24 mm	34 mm	30 mm	78 mm
BI4E3L025	€ 11,10	25 mm	36 mm	30 mm	78 mm
BI4E3L026	€ 11,30	26 mm	36 mm	30 mm	78 mm
BI4E3L027	€ 11,30	27 mm	38 mm	30 mm	78 mm
BI4E3L028	€ 12,00	28 mm	40 mm	30 mm	78 mm
BI4E3L029	€ 12,00	29 mm	42 mm	30 mm	78 mm
BI4E3L030	€ 12,00	30 mm	42 mm	30 mm	78 mm
BI4E3L031	€ 12,40	31 mm	44 mm	30 mm	78 mm
BI4E3L032	€ 12,40	32 mm	44 mm	30 mm	78 mm





BI413LOX

BUSSOLA ESAGONALE MASCHIO AD IMPATTO

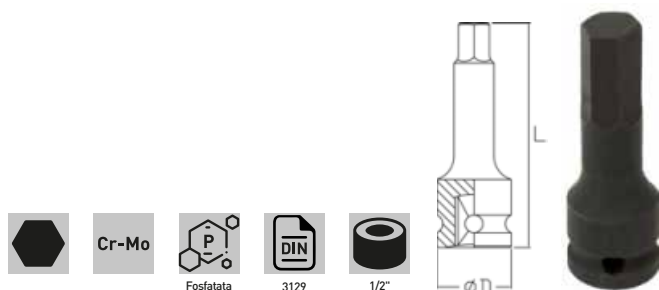

Art.	€	Misura	D	Lunghezza
BI413L004	€ 6,60	4 mm	25 mm	78 mm
BI413L005	€ 6,60	5 mm	25 mm	78 mm
BI413L006	€ 6,60	6 mm	25 mm	78 mm
BI413L008	€ 6,60	8 mm	25 mm	78 mm
BI413L010	€ 6,60	10 mm	25 mm	78 mm
BI413L012	€ 6,60	12 mm	25 mm	78 mm
BI413L014	€ 6,60	14 mm	25 mm	78 mm
BI413L017	€ 7,50	17 mm	25 mm	78 mm
BI413L019	€ 8,10	19 mm	25 mm	78 mm

BI423LX

BUSSOLA TORX MASCHIO AD IMPATTO

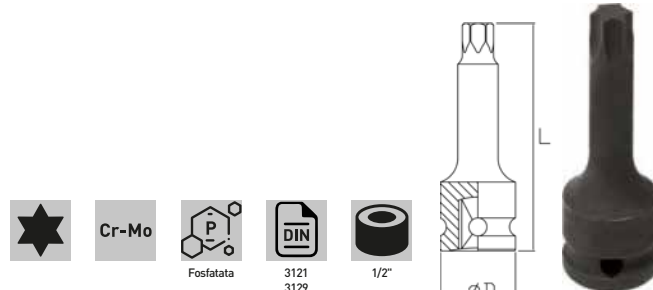

Art.	€	Misura	D	Lunghezza
BI423L025	€ 7,50	T25	25 mm	78 mm
BI423L027	€ 7,50	T27	25 mm	78 mm
BI423L030	€ 7,50	T30	25 mm	78 mm
BI423L040	€ 8,00	T40	25 mm	78 mm
BI423L045	€ 8,10	T45	25 mm	78 mm
BI423L050	€ 8,10	T50	25 mm	78 mm
BI423L060	€ 10,50	T60	25 mm	78 mm
BI423L070	€ 11,80	T70	25 mm	78 mm
BI423L080	€ 12,20	T80	25 mm	78 mm

BI433MX

BUSSOLA RIBE MASCHIO AD IMPATTO

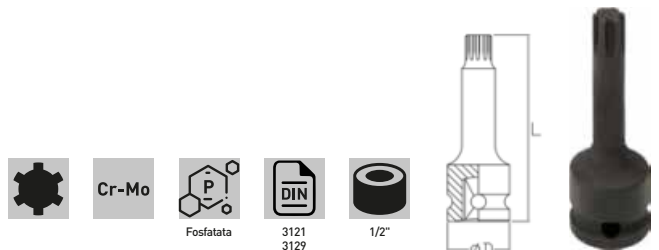

Art.	€	Misura	D	Lunghezza
BI433M004	€ 6,50	4	25 mm	60 mm
BI433M005	€ 6,50	5	25 mm	60 mm
BI433M006	€ 6,50	6	25 mm	60 mm
BI433M007	€ 6,50	7	25 mm	60 mm
BI433M008	€ 6,50	8	25 mm	60 mm
BI433M009	€ 6,50	9	25 mm	60 mm
BI433M010	€ 6,50	10	25 mm	60 mm
BI433M012	€ 7,50	12	25 mm	60 mm
BI433M014	€ 8,10	14	25 mm	60 mm
BI433M016	€ 8,40	16	25 mm	60 mm
BI433M018	€ 8,70	18	25 mm	60 mm

BI443MX

BUSSOLA XZN MASCHIO AD IMPATTO

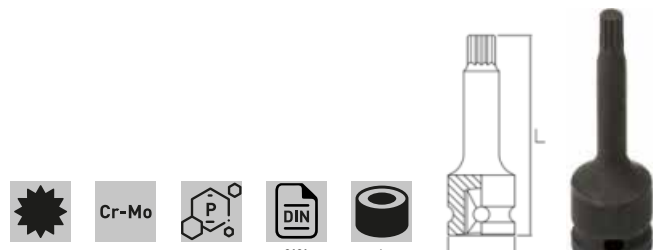

Art.	€	Misura	D	Lunghezza
BI443M004	€ 6,50	4	25 mm	60 mm
BI443M005	€ 6,50	5	25 mm	60 mm
BI443M006	€ 6,50	6	25 mm	60 mm
BI443M008	€ 6,50	8	25 mm	60 mm
BI443M010	€ 6,50	10	25 mm	60 mm
BI443M012	€ 6,50	12	25 mm	60 mm
BI443M014	€ 6,80	14	25 mm	60 mm
BI443M016	€ 7,00	16	25 mm	60 mm
BI443M018	€ 7,60	18	25 mm	60 mm
BI443M020	€ 8,10	20	25 mm	60 mm

PI403X

PROLUNGA AD IMPATTO

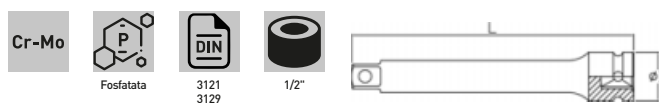

Art.	€	D	Lunghezza
PI403075	€ 8,40	25 mm	75 mm
PI403125	€ 9,10	25 mm	125 mm
PI403150	€ 11,10	25 mm	150 mm
PI403250	€ 13,80	25 mm	250 mm

PI453X

PROLUNGA A SGANCIO RAPIDO AD IMPATTO



Art.	€	D	Lunghezza
PI453075	€ 19,80	25 mm	75 mm
PI453150	€ 21,40	25 mm	125 mm
PI453250	€ 24,20	25 mm	250 mm

BI4E2NX
CHIAVE A BUSSOLA AD IMPATTO, SERIE NORMALE

Art.	€	Misura	D1	D2	Lunghezza
BI4E2N018	€ 11,10	18 mm	30 mm	44 mm	51 mm
BI4E2N019	€ 11,10	19 mm	32 mm	44 mm	51 mm
BI4E2N020	€ 11,10	20 mm	33 mm	44 mm	51 mm
BI4E2N021	€ 11,10	21 mm	35 mm	44 mm	51 mm
BI4E2N022	€ 11,10	22 mm	36 mm	44 mm	51 mm
BI4E2N023	€ 11,10	23 mm	38 mm	44 mm	51 mm
BI4E2N024	€ 11,10	24 mm	39 mm	44 mm	51 mm
BI4E2N025	€ 11,10	25 mm	41 mm	44 mm	54 mm
BI4E2N026	€ 11,10	26 mm	41 mm	44 mm	54 mm
BI4E2N027	€ 11,10	27 mm	42 mm	44 mm	54 mm
BI4E2N028	€ 11,90	28 mm	44 mm	44 mm	54 mm
BI4E2N029	€ 11,90	29 mm	46 mm	44 mm	54 mm
BI4E2N030	€ 11,90	30 mm	46 mm	44 mm	54 mm
BI4E2N032	€ 13,20	32 mm	48 mm	44 mm	57 mm
BI4E2N033	€ 13,20	33 mm	50 mm	44 mm	57 mm
BI4E2N034	€ 14,30	34 mm	52 mm	44 mm	57 mm
BI4E2N035	€ 14,40	35 mm	52 mm	44 mm	57 mm
BI4E2N036	€ 14,60	36 mm	54 mm	44 mm	57 mm
BI4E2N038	€ 17,00	38 mm	56 mm	44 mm	57 mm
BI4E2N041	€ 18,90	41 mm	60 mm	44 mm	58 mm
BI4E2N046	€ 20,80	46 mm	66 mm	44 mm	68 mm
BI4E2N050	€ 32,30	50 mm	71 mm	54 mm	68 mm
BI4E2N055	€ 39,60	55 mm	77 mm	54 mm	73 mm
BI4E2N060	€ 42,90	60 mm	84 mm	54 mm	75 mm
BI4E2N065	€ 48,10	65 mm	88 mm	54 mm	78 mm

BI4E2LX
CHIAVE A BUSSOLA AD IMPATTO LUNGA

Art.	€	Misura	D1	D2	Lunghezza
BI4E2L018	€ 19,80	18 mm	30 mm	44 mm	90 mm
BI4E2L019	€ 19,80	19 mm	32 mm	44 mm	90 mm
BI4E2L020	€ 19,80	20 mm	33 mm	44 mm	90 mm
BI4E2L021	€ 19,80	21 mm	35 mm	44 mm	90 mm
BI4E2L022	€ 19,80	22 mm	36 mm	44 mm	90 mm
BI4E2L023	€ 19,80	23 mm	38 mm	44 mm	90 mm
BI4E2L024	€ 19,80	24 mm	39 mm	44 mm	90 mm
BI4E2L025	€ 19,80	25 mm	41 mm	44 mm	90 mm
BI4E2L026	€ 19,80	26 mm	41 mm	44 mm	90 mm
BI4E2L027	€ 19,80	27 mm	42 mm	44 mm	90 mm
BI4E2L028	€ 19,80	28 mm	44 mm	44 mm	90 mm
BI4E2L029	€ 19,80	29 mm	46 mm	44 mm	90 mm
BI4E2L030	€ 19,80	30 mm	46 mm	44 mm	90 mm
BI4E2L032	€ 21,30	32 mm	48 mm	44 mm	90 mm
BI4E2L033	€ 21,30	33 mm	50 mm	44 mm	90 mm
BI4E2L034	€ 21,80	34 mm	52 mm	44 mm	90 mm
BI4E2L035	€ 21,80	35 mm	52 mm	44 mm	90 mm
BI4E2L036	€ 21,80	36 mm	54 mm	44 mm	90 mm
BI4E2L038	€ 25,80	38 mm	56 mm	44 mm	90 mm
BI4E2L041	€ 27,30	41 mm	60 mm	44 mm	90 mm
BI4E2L046	€ 35,50	46 mm	66 mm	44 mm	90 mm
BI4E2L050	€ 44,10	50 mm	71 mm	54 mm	90 mm

PI402X
PROLUNGA AD IMPATTO

Art.	€	D	Lunghezza
PI402175	€ 31,60	44 mm	175 mm
PI402200	€ 34,90	44 mm	200 mm
PI402300	€ 45,70	44 mm	300 mm
PI402400	€ 64,60	44 mm	400 mm





BI4E1NX

CHIAVE A BUSSOLA AD IMPATTO



Art.	€	Misura	D1	D2	Lunghezza
BI4E1N021	€ 20,50	21 mm	38 mm	54 mm	58 mm
BI4E1N022	€ 20,50	22 mm	39 mm	54 mm	58 mm
BI4E1N023	€ 20,50	23 mm	41 mm	54 mm	58 mm
BI4E1N024	€ 20,50	24 mm	42 mm	54 mm	58 mm
BI4E1N025	€ 20,50	25 mm	43 mm	54 mm	58 mm
BI4E1N026	€ 20,50	26 mm	44 mm	54 mm	58 mm
BI4E1N027	€ 20,50	27 mm	46 mm	54 mm	58 mm
BI4E1N028	€ 20,50	28 mm	47 mm	54 mm	58 mm
BI4E1N029	€ 20,50	29 mm	48 mm	54 mm	58 mm
BI4E1N030	€ 20,50	30 mm	49 mm	54 mm	62 mm
BI4E1N031	€ 20,50	31 mm	50 mm	54 mm	62 mm
BI4E1N032	€ 20,50	32 mm	52 mm	54 mm	62 mm
BI4E1N033	€ 20,50	33 mm	54 mm	54 mm	62 mm
BI4E1N034	€ 22,70	34 mm	54 mm	54 mm	62 mm
BI4E1N035	€ 22,70	35 mm	54 mm	54 mm	62 mm
BI4E1N036	€ 23,50	36 mm	56 mm	54 mm	65 mm
BI4E1N037	€ 24,00	37 mm	57 mm	54 mm	65 mm
BI4E1N038	€ 27,00	38 mm	58 mm	54 mm	65 mm
BI4E1N039	€ 27,00	39 mm	59 mm	54 mm	65 mm
BI4E1N040	€ 27,00	40 mm	60 mm	54 mm	65 mm
BI4E1N041	€ 27,00	41 mm	61 mm	54 mm	68 mm
BI4E1N042	€ 30,20	42 mm	64 mm	54 mm	68 mm
BI4E1N043	€ 30,20	43 mm	66 mm	54 mm	68 mm
BI4E1N044	€ 30,20	44 mm	66 mm	54 mm	68 mm
BI4E1N045	€ 30,20	45 mm	67 mm	54 mm	68 mm
BI4E1N046	€ 30,20	46 mm	68 mm	54 mm	72 mm
BI4E1N047	€ 33,80	47 mm	69 mm	54 mm	72 mm
BI4E1N048	€ 33,80	48 mm	70 mm	54 mm	72 mm
BI4E1N050	€ 33,80	50 mm	74 mm	54 mm	75 mm
BI4E1N052	€ 42,00	52 mm	75 mm	54 mm	75 mm
BI4E1N054	€ 42,00	54 mm	78 mm	54 mm	80 mm
BI4E1N055	€ 43,60	55 mm	80 mm	54 mm	83 mm
BI4E1N056	€ 46,80	56 mm	81 mm	54 mm	83 mm
BI4E1N060	€ 46,80	60 mm	86 mm	54 mm	87 mm
BI4E1N065	€ 51,00	65 mm	92 mm	54 mm	90 mm
BI4E1N070	€ 57,40	70 mm	97 mm	54 mm	93 mm
BI4E1N075	€ 67,90	75 mm	104 mm	86 mm	95 mm
BI4E1N080	€ 95,70	80 mm	112 mm	86 mm	95 mm
BI4E1N085	€ 110,00	85 mm	115 mm	86 mm	100 mm
BI4E1N090	€ 123,00	90 mm	124 mm	86 mm	105 mm
BI4E1N095	€ 154,00	95 mm	130 mm	86 mm	105 mm
BI4E1N100	€ 191,00	100 mm	135 mm	86 mm	105 mm

BI4E1LX

CHIAVE A BUSSOLA AD IMPATTO LUNGA

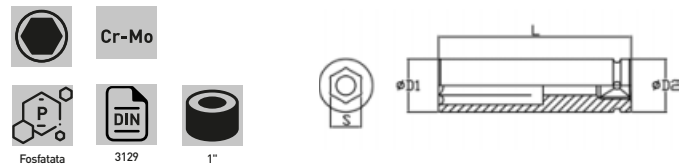

Art.	€	Misura	D1	D2	Lunghezza
BI4E1L021	€ 28,50	21 mm	38 mm	54 mm	90 mm
BI4E1L022	€ 28,50	22 mm	39 mm	54 mm	90 mm
BI4E1L023	€ 28,50	23 mm	41 mm	54 mm	90 mm
BI4E1L024	€ 28,50	24 mm	42 mm	54 mm	90 mm
BI4E1L027	€ 28,50	27 mm	46 mm	54 mm	90 mm
BI4E1L028	€ 28,50	28 mm	47 mm	54 mm	90 mm
BI4E1L030	€ 28,50	30 mm	49 mm	54 mm	90 mm
BI4E1L032	€ 28,50	32 mm	52 mm	54 mm	90 mm
BI4E1L033	€ 28,50	33 mm	54 mm	54 mm	90 mm
BI4E1L034	€ 28,80	34 mm	54 mm	54 mm	90 mm
BI4E1L035	€ 29,00	35 mm	54 mm	54 mm	90 mm
BI4E1L036	€ 29,00	36 mm	56 mm	54 mm	90 mm
BI4E1L038	€ 33,40	38 mm	58 mm	54 mm	95 mm
BI4E1L039	€ 35,00	39 mm	59 mm	54 mm	95 mm
BI4E1L040	€ 35,00	40 mm	60 mm	54 mm	95 mm
BI4E1L041	€ 35,90	41 mm	61 mm	54 mm	95 mm
BI4E1L042	€ 35,90	42 mm	64 mm	54 mm	95 mm
BI4E1L043	€ 38,00	43 mm	66 mm	54 mm	95 mm
BI4E1L044	€ 38,00	44 mm	66 mm	54 mm	95 mm
BI4E1L045	€ 38,70	45 mm	67 mm	54 mm	95 mm
BI4E1L046	€ 38,70	46 mm	68 mm	54 mm	95 mm
BI4E1L048	€ 47,40	48 mm	70 mm	54 mm	100 mm
BI4E1L049	€ 48,90	49 mm	72 mm	54 mm	100 mm
BI4E1L050	€ 48,90	50 mm	74 mm	54 mm	100 mm
BI4E1L051	€ 50,50	51 mm	74 mm	54 mm	100 mm
BI4E1L052	€ 51,30	52 mm	74 mm	54 mm	100 mm
BI4E1L054	€ 51,30	54 mm	78 mm	54 mm	100 mm
BI4E1L055	€ 55,20	55 mm	80 mm	54 mm	105 mm
BI4E1L057	€ 57,50	57 mm	82 mm	54 mm	105 mm
BI4E1L060	€ 76,20	60 mm	86 mm	54 mm	110 mm
BI4E1L065	€ 91,60	65 mm	92 mm	54 mm	115 mm
BI4E1L070	€ 91,20	70 mm	97 mm	54 mm	120 mm
BI4E1L075	€ 133,00	75 mm	104 mm	86 mm	135 mm
BI4E1L080	€ 144,00	80 mm	112 mm	86 mm	135 mm
BI4E1L085	€ 151,00	85 mm	115 mm	86 mm	140 mm
BI4E1L090	€ 198,00	90 mm	124 mm	86 mm	140 mm
BI4E1L095	€ 258,00	95 mm	130 mm	86 mm	140 mm

I340 € 247,00
SERIE BUSSOLE AD IMPATTO, SERIE NORMALE E LUNGHE

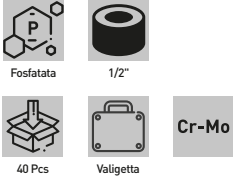

Bussole da 1/2"	9 - 10 - 11 - 12 - 13 - 14 - 15 - 16 - 17 - 18 - 19 - 20 - 21 - 22 - 23 - 24 - 26 - 27 - 30 mm
Bussole lunghe da 1/2"	9 - 10 - 11 - 12 - 13 - 14 - 15 - 16 - 17 - 18 - 19 - 20 - 21 - 22 - 23 - 24 - 26 - 27 - 30 mm
Snodo universale	1/2"
Prolunghe da 1/2"	125 mm

SI4E3N013 € 62,30
SERIE BUSSOLE AD IMPATTO, SERIE NORMALE

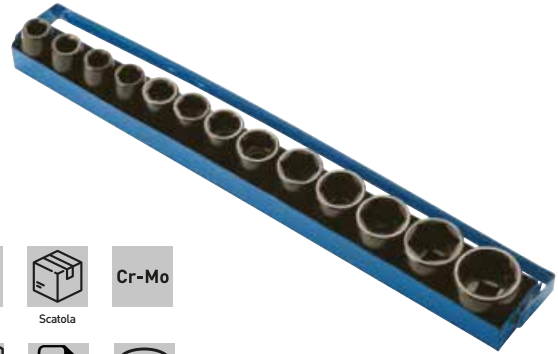

Bussole	10, 11, 12, 13, 14, 16, 17, 19, 21, 22, 24, 27, 30 mm
---------	-------------------------------------------------------

SI413M006 € 54,40
SERIE BUSSOLE ESAGONALI MASCHIO AD IMPATTO



Bussole	8, 10, 12, 14, 17, 19 mm
Lunghezza	60 mm

SI423M006 € 62,30
SERIE BUSSOLE TORX MASCHIO AD IMPATTO



Lunghezza	60 mm
Bussole	T40, T45, T50, T55, T60, T70

0341-X
CHIAVI BUSSOLA ESAGONALI IMPACT RIVESTITE IN PLASTICA

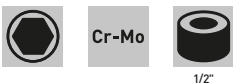

Art.	€	Misura	Lunghezza
0341/17	€ 9,20	17 mm	87 mm
0341/19	€ 9,20	19 mm	87 mm
0341/21	€ 9,20	21 mm	87 mm
0341/22	€ 11,40	22 mm	87 mm
0341/24	€ 13,00	24 mm	87 mm

0341 € 38,70
SERIE CHIAVI BUSSOLA ESAGONALI IMPACT RIVESTITE IN PLASTICA

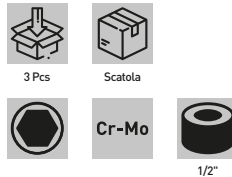

Misure	17 - 19 - 21 mm
Lunghezza	87 mm



0341/5S

€ 54,40

SERIE CHIAVI BUSSOLA ESAGONALI IMPACT RIVESTITE IN PLASTICA



5 Pcs



Scatola



Cr-Mo



1/2"

Misure	17 - 19 - 21 - 22 - 24 mm
Lunghezza	87 mm

0341/3LS

€ 59,70

SERIE CHIAVI BUSSOLA ESAGONALI IMPACT RIVESTITE IN PLASTICA



3 Pcs



Scatola



Cr-Mo



1/2"

Misure	17 - 19 - 21 mm
Lunghezza	150 mm

I306

€ 74,00

SERIE CHIAVI A BUSSOLA LUNGHE AD IMPATTO



3 Pcs



Scatola



Cr-Mo



Cromata



1/2"

Misure	17 - 19 - 21 mm
Lunghezza	150 mm

0341-XL

CHIAVI BUSSOLA LUNGHE ESAGONALI IMPACT RIVESTITE IN PLASTICA



Cr-Mo



1/2"

Art.	€	Misura	Lunghezza
0341/17L	€ 18,10	17 mm	150 mm
0341/19L	€ 18,10	19 mm	150 mm
0341/21L	€ 18,10	21 mm	150 mm

0341-SX

RIVESTIMENTO IN PLASTICA PER BUSSOLE IMPACT



Plastic

Art.	€	Misura
0341/S19	€ 1,08	19 mm
0341/S21	€ 1,08	21 mm
0341/S22	€ 1,08	22 mm
0341/S24	€ 1,08	24 mm

I217

€ 326,00

SERIE BUSSOLE AD IMPATTO, SERIE NORMALE



17 Pcs



Valigetta



Cr-Mo



Fosfatata



3/4"

Misure	19 - 21 - 22 - 24 - 27 - 30 - 32 - 33 - 34 - 35 - 36 - 38 - 40 - 41 - 46 - 50 - 55 mm
--------	---------------------------------------------------------------------------------------

SI4E2N008 € 116,00

SERIE BUSSOLE AD IMPATTO, SERIE NORMALE



8 Pcs Scatola Cr-Mo Fosfatata 3129

Bussole 26, 27, 29, 30, 32, 35, 36, 38 mm

SI4E1N008 € 170,00

SERIE BUSSOLE AD IMPATTO, SERIE NORMALE



8 Pcs Scatola Cr-Mo Fosfatata 3129

Bussole 24, 27, 30, 32, 33, 36, 38, 41 mm

PI401X

PROLUNGA AD IMPATTO



Cr-Mo Fosfatata 3121 3129 1"

Art.	€	D	Lunghezza
PI401175	€ 43,50	54 mm	175 mm
PI401200	€ 46,70	54 mm	200 mm
PI401250	€ 56,50	54 mm	250 mm
PI401300	€ 60,20	54 mm	300 mm
PI401400	€ 76,20	54 mm	400 mm

JI40XN

SNODO A CARDANO AD IMPATTO

Con attacco quadro maschio e femmina, costruito in acciaio legato 42crmo2.



Cr-Mo Fosfatata

Art.	€	Attacco quadro	D	Lunghezza
JI401N	€ 88,90	1"	54 mm	115 mm
JI402N	€ 55,70	3/4"	44 mm	90 mm
JI403N	€ 23,50	1/2"	30 mm	63 mm

I109 € 186,00

SERIE BUSSOLE AD IMPATTO



9 Pcs Valigetta Cr-Mo Fosfatata 3129 1"

Bussole da 1" 21 - 22 - 24 - 26 - 30 - 38 mm
Bussole lunghe da 1" 27 - 28 - 32 mm

SI40N006 € 39,20

SERIE RACCORDI AD IMPATTO



6 Pcs Scatola Cr-Mo Fosfatata

Misure 1/4" int. - 3/8" ext.; 3/8" int. - 1/4" ext.; 3/8" int. - 1/2" ext.; 1/2" int. - 3/8" ext.; 1/2" int. - 3/4" ext.
Valigetta in plastica 126 x 100 x 52 mm

JI40XL

SNODO A CARDANO AD IMPATTO

Serie pesante, con attacco quadro maschio e femmina, costruito in acciaio legato 42CRM02.



Cr-Mo Fosfatata

Art.	€	Attacco quadro	Lunghezza	D
JI401L	€ 88,90	1"	130 mm	54 mm
JI402L	€ 55,70	3/4"	105 mm	44 mm

RI40X

RACCORDO AD IMPATTO



Cr-Mo Fosfatata 3121

Art.	€	Attacco femmina	Attacco maschio	D	Lunghezza
RI4012N	€ 20,70	1"	3/4"	54 mm	70 mm
RI4021N	€ 16,50	3/4"	1"	44 mm	63 mm
RI4023N	€ 12,80	3/4"	1/2"	44 mm	58 mm
RI4032N	€ 9,10	1/2"	3/4"	30 mm	48 mm



0088

€ 18,10

ESTRATTORE MAGNETICO FLESSIBILE LUMINOSO



Misure $\varnothing 9 / 17 \times 430$ mm
Batterie non incluse 2 x 1.5 VAA

0456

€ 6,20

SERIE GANCI PER OR

Dotato di impugnatura esagonale con magnete.



Dimensioni manico 8 x 90 mm

E001

€ 14,80

SERIE ESTRATTORI PER VITI



num. 1	M3 - M6
num. 2	M6 - M8
num. 3	M8 - M11
num. 4	M11 - M14
num. 5	M14 - M18

0471

€ 6,20

SERIE GANCI PER RIMOZIONE OR

Ganci adatti anche per rimozioni guarnizioni su motori.

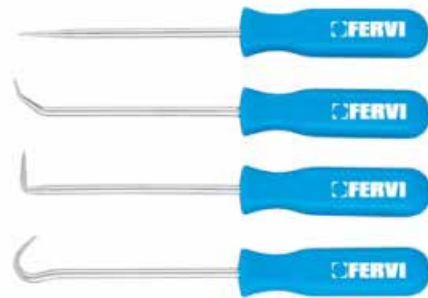

Lunghezza 135 mm

E003

€ 22,60

SERIE ESTRATTORI IN HSS



num. 0	2-3 mm
num. 1	4-5 mm
num. 2	6-8 mm
num. 3	8-10 mm
num. 4	10-12 mm

E005

€ 37,00

SERIE DI ESTRATTORI

Per dadi e bulloni con esagono esterno.



Misure 9 - 10 - 11 - 12 - 13 - 14 - 15 - 16 - 17 - 19 mm
Altezza 27 mm

E191-

ESTRATTORE A 3 GRIFFE



Art.	€	Dimensioni
E191/120	€ 60,50	Max Ø 120 mm - h 101 mm
E191/200	€ 113,00	Max Ø 200 mm - h 150 mm

E190-

ESTRATTORE A 2 GRIFFE



Art.	€	Dimensioni
E190/080	€ 31,50	Max Ø 80 mm - h 100 mm
E190/130	€ 41,20	Max Ø 130 mm - h 100 mm
E190/160	€ 50,60	Max Ø 160 mm - h 150 mm
E190/200	€ 54,60	Max Ø 200 mm - h 150 mm

E190-BX

GRIFFA PROLUNGATA



Art.	€	Lunghezza
E190/B2	€ 30,20	300 mm

**CB01-****CHIAVE A BUSSOLA CON IMPUGNATURA**

Ansi, con foro.



Art.	€	Misura	L	L1	L2	L3	L4	A	B	C
CB01/04	€ 6,10	4 mm	185 mm	75 mm	4 ~ 5 mm	20,5 mm	110 mm	ø 5,9 mm	ø 7 mm	ø 3,3 mm
CB01/05	€ 6,10	5 mm	185 mm	75 mm	4,5 ~ 5,5 mm	20 mm	110 mm	ø 5,9 mm	ø 8,3 mm	ø 3,7 mm
CB01/055	€ 6,10	5,5 mm	185 mm	75 mm	5,5 ~ 6,5 mm	19 mm	110 mm	ø 5,9 mm	ø 9 mm	ø 3,7 mm
CB01/06	€ 6,10	6 mm	185 mm	75 mm	6,5 ~ 7,5 mm	18 mm	110 mm	ø 5,9 mm	ø 9,5 mm	ø 3,7 mm
CB01/07	€ 6,50	7 mm	185 mm	75 mm	7,5 ~ 8,5 mm	17 mm	110 mm	ø 5,9 mm	ø 10,5 mm	ø 3,7 mm
CB01/08	€ 6,50	8 mm	185 mm	75 mm	8,5 ~ 9,5 mm	16 mm	110 mm	ø 7,2 mm	ø 11,9 mm	ø 5 mm
CB01/09	€ 6,50	9 mm	185 mm	75 mm	8,5 ~ 9,5 mm	16 mm	110 mm	ø 7,2 mm	ø 12,8 mm	ø 5 mm
CB01/10	€ 7,00	10 mm	185 mm	75 mm	10,5 ~ 11,5 mm	14 mm	110 mm	ø 9,3 mm	ø 14,1 mm	ø 7 mm
CB01/11	€ 7,00	11 mm	185 mm	75 mm	10,5 ~ 11,5 mm	14 mm	110 mm	ø 9,3 mm	ø 15 mm	ø 7 mm
CB01/12	€ 7,00	12 mm	185 mm	75 mm	10,5 ~ 11,5 mm	14 mm	110 mm	ø 9,3 mm	ø 16 mm	ø 7 mm
CB01/13	€ 7,00	13 mm	185 mm	75 mm	11,5 ~ 12,5 mm	14 mm	110 mm	ø 11 mm	ø 17 mm	ø 8,5 mm

CB02-**CHIAVE A BUSSOLA CON IMPUGNATURA**

Ansi, con foro profondo.



Art.	€	Misura	L	L1	L2	L3	L4	A	B	C
CB02/04	€ 7,70	4 mm	185 mm	75 mm	4 ~ 5 mm	105,5 mm	110 mm	ø 7,2 mm	ø 7 mm	ø 3,3 mm
CB02/05	€ 7,70	5 mm	185 mm	75 mm	4,5 ~ 5,5 mm	105 mm	110 mm	ø 7,2 mm	ø 8,3 mm	ø 3,7 mm
CB02/055	€ 7,70	5,5 mm	185 mm	75 mm	5,5 ~ 6,5 mm	104 mm	110 mm	ø 7,2 mm	ø 9 mm	ø 3,7 mm
CB02/06	€ 7,70	6 mm	185 mm	75 mm	6,5 ~ 7,5 mm	103 mm	110 mm	ø 7,2 mm	ø 9,5 mm	ø 3,7 mm
CB02/07	€ 8,10	7 mm	185 mm	75 mm	7,5 ~ 8,5 mm	102 mm	110 mm	ø 7,2 mm	ø 10,5 mm	ø 3,7 mm
CB02/08	€ 8,10	8 mm	185 mm	75 mm	8,5 ~ 9,5 mm	101 mm	110 mm	ø 9,3 mm	ø 11,9 mm	ø 5 mm
CB02/09	€ 8,10	9 mm	185 mm	75 mm	8,5 ~ 9,5 mm	101 mm	110 mm	ø 9,3 mm	ø 12,8 mm	ø 5 mm
CB02/10	€ 8,10	10 mm	185 mm	75 mm	10,5 ~ 11,5 mm	100 mm	110 mm	ø 9,3 mm	ø 14,1 mm	ø 7 mm
CB02/11	€ 9,10	11 mm	185 mm	75 mm	10,5 ~ 11,5 mm	100 mm	110 mm	ø 11 mm	ø 15 mm	ø 7 mm
CB02/12	€ 9,10	12 mm	185 mm	75 mm	10,5 ~ 11,5 mm	100 mm	110 mm	ø 11 mm	ø 16 mm	ø 7 mm
CB02/13	€ 10,10	13 mm	185 mm	75 mm	11,5 ~ 12,5 mm	99 mm	110 mm	ø 11 mm	ø 17 mm	ø 8,5 mm

CBF1-**CHIAVE A BUSSOLA FLESSIBILE CON IMPUGNATURA**

Ansi.

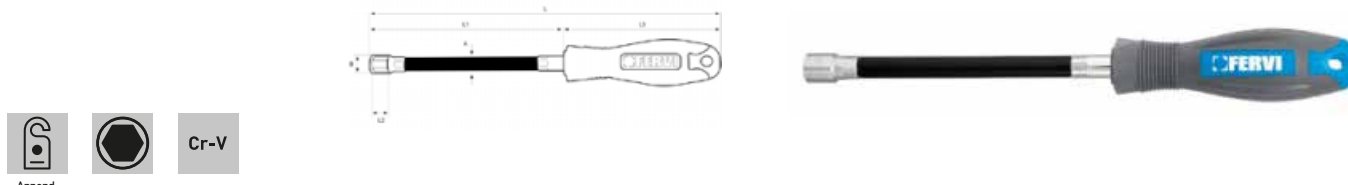

Art.	€	Misura	L	L1	L2	L3	A	B
CBF1/05	€ 7,70	5 mm	265 mm	150 mm	9,5 mm	115 mm	ø 11 mm	ø 11,8 mm
CBF1/055	€ 7,70	5,5 mm	265 mm	150 mm	9,5 mm	115 mm	ø 11 mm	ø 11,8 mm
CBF1/06	€ 7,70	6 mm	265 mm	150 mm	9,5 mm	115 mm	ø 11 mm	ø 11,8 mm
CBF1/07	€ 7,70	7 mm	265 mm	150 mm	9,5 mm	115 mm	ø 11 mm	ø 11,8 mm
CBF1/08	€ 7,70	8 mm	265 mm	150 mm	9,5 mm	115 mm	ø 11 mm	ø 11,8 mm
CBF1/09	€ 7,80	9 mm	265 mm	150 mm	9,5 mm	115 mm	ø 11 mm	ø 13 mm
CBF1/10	€ 8,10	10 mm	265 mm	150 mm	10 mm	115 mm	ø 11 mm	ø 14,5 mm
CBF1/11	€ 8,60	11 mm	265 mm	150 mm	9 mm	115 mm	ø 11 mm	ø 15,9 mm
CBF1/12	€ 8,60	12 mm	265 mm	150 mm	9 mm	115 mm	ø 11 mm	ø 17 mm
CBF1/13	€ 8,60	13 mm	265 mm	150 mm	8,5 mm	115 mm	ø 11 mm	ø 17,8 mm

CBF1/10P
€ 74,80
SERIE CHIAVI A BUSSOLA FLESSIBILI CON IMPUGNATURA

Ansi, bicomponente.

Misure 5 - 5.5 - 6 - 7 - 8 - 9 - 10 - 11 - 12 - 13 mm

CB01/04P
€ 27,70
SERIE CHIAVI A BUSSOLA CON IMPUGNATURA

Ansi, bicomponente.

Misure 10 - 11 - 12 - 13 mm

CB01/07P
€ 42,40
SERIE CHIAVI A BUSSOLA CON IMPUGNATURA

Ansi, bicomponente.

Misure 4 - 5 - 5.5 - 6 - 7 - 8 - 9 mm

CB01/11P
€ 68,70
SERIE CHIAVI A BUSSOLA CON IMPUGNATURA

Ansi, bicomponente.

Misure 4 - 5 - 5.5 - 6 - 7 - 8 - 9 - 10 - 11 - 12 - 13 mm

CB02/04P
€ 35,40
SERIE CHIAVI A BUSSOLA CON IMPUGNATURA

Ansi, bicomponente con foro profondo.

Misure 10 - 11 - 12 - 13 mm

CB02/07P
€ 55,40
SERIE CHIAVI A BUSSOLA CON IMPUGNATURA

Ansi, bicomponente con foro profondo.

Misure 4 - 5 - 5.5 - 6 - 7 - 8 - 9 - 10 mm

CB02/11P
€ 89,90
SERIE CHIAVI A BUSSOLA CON IMPUGNATURA

Ansi, bicomponente con foro profondo.

Misure 4 - 5 - 5.5 - 6 - 7 - 8 - 9 - 10 - 11 - 12 - 13 mm



DIN 2380-1, con lama nera e manico tricomponente realizzato in resina TPR altamente elastica e materiale polipropilene resistente all'olio. La punta diamantata consente una perfetta presa evitando di rovinare la testa della vite. Questa tipologia di punta è anche molto efficace con viti già rovinate.

**D883-****GIRAVITE A TAGLIO ELETTRICISTA CON PUNTA DIAMANTATA**

Art.	€	Misura	Lunghezza asta	Lunghezza totale
D883/3075	€ 3,13	3 mm	75 mm	115 mm
D883/4100	€ 4,24	4 mm	100 mm	145 mm

D884/6038**€ 3,94****GIRAVITE A TAGLIO CON PUNTA DIAMANTATA**

Misura	6 mm
Lunghezza asta	38 mm
Lunghezza totale	70 mm

D882/2038**€ 4,03****GIRAVITE A CROCE PH CON PUNTA DIAMANTATA**

Misura	PH 2
Lunghezza asta	38 mm
Lunghezza totale	70 mm

D885/2038**€ 3,94****GIRAVITE A CROCE PZ CON PUNTA DIAMANTATA**

Misura	PZ 2
Lunghezza asta	38 mm
Lunghezza totale	70 mm

D884-**GIRAVITE A TAGLIO CON PUNTA DIAMANTATA**

Art.	€	Misura	Lunghezza asta	Lunghezza totale
D884/3075	€ 3,33	3 mm	75 mm	115 mm
D884/4100	€ 4,03	4 mm	100 mm	180 mm
D884/5125	€ 4,55	5 mm	125 mm	230 mm
D884/6150	€ 5,30	6 mm	150 mm	260 mm
D884/8150	€ 6,40	8 mm	150 mm	210 mm

D882-**GIRAVITE A CROCE PH CON PUNTA DIAMANTATA**

Art.	€	Misura	Lunghezza asta	Lunghezza totale
D882/1075	€ 4,55	PH 1	75 mm	180 mm
D882/2100	€ 5,90	PH 2	100 mm	210 mm
D882/3150	€ 6,60	PH 3	150 mm	270 mm

D885-**GIRAVITE A CROCE PZ CON PUNTA DIAMANTATA**

Art.	€	Misura	Lunghezza asta	Lunghezza totale
D885/1075	€ 4,55	PZ 1	75 mm	120 mm
D885/2100	€ 5,80	PZ 2	100 mm	150 mm
D885/3150	€ 6,60	PZ 3	150 mm	210 mm

D880/006**€ 25,10****SERIE GIRAVITI DIAMANTATI**

Misure Taglio	(-) 4 x 100 mm, (-) 5 x 125 mm, (-) 6 x 150 mm
Croce	(+) PH 1 x 75 mm, (+) PH 2 x 100 mm, (+) PH 3 x 150 mm

C883-
GIRAVITE ELETTRICISTA, APPENDIBILE

A taglio, con punta magnetica fosfatata nera diritta e manico realizzato in resina TPR altamente elastica e materiale polipropilene resistente all'olio.



Art.	€	Misura	Lunghezza asta
C883/3075	€ 1,82	3 mm	75 mm
C883/4100	€ 2,68	4 mm	100 mm

C884-
GIRAVITE A TAGLIO, APPENDIBILE

A taglio, con punta magnetica fosfatata nera diritta e manico realizzato in resina TPR altamente elastica e materiale polipropilene resistente all'olio.

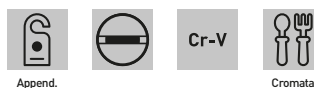

Art.	€	Misura	Lunghezza asta
C884/3075	€ 1,82	3 mm	75 mm
C884/4100	€ 2,80	4 mm	100 mm
C884/5125	€ 3,33	5 mm	125 mm
C884/6150	€ 3,74	6 mm	150 mm
C884/8150	€ 4,36	8 mm	150 mm

C884/6038
€ 2,91
GIRAVITE A TAGLIO, APPENDIBILE

Con punta magnetica fosfatata nera e manico realizzato in resina TPR altamente elastica e materiale polipropilene resistente all'olio.

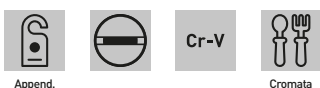

Misura	6 mm
Lunghezza asta	38 mm

C882-
GIRAVITE A CROCE PH, APPENDIBILE

Con punta magnetica fosfatata nera e manico realizzato in resina TPR altamente elastica e materiale polipropilene resistente all'olio.



Art.	€	Misura	Lunghezza asta
C882/1075	€ 3,33	PH 1	75 mm
C882/2100	€ 4,36	PH 2	100 mm
C882/3150	€ 4,64	PH 3	150 mm

C882/2038
€ 2,91
GIRAVITE A CROCE PH, APPENDIBILE

Con punta magnetica fosfatata nera e manico realizzato in resina TPR altamente elastica e in polipropilene resistente all'olio.



Misura	PH 2
Lunghezza asta	38 mm

C885-
GIRAVITE A CROCE PZ, APPENDIBILE

Con punta magnetica fosfatata nera e manico realizzato in resina TPR altamente elastica e materiale polipropilene resistente all'olio.



Art.	€	Misura	Lunghezza asta
C885/1075	€ 3,33	PZ 1	75 mm
C885/2100	€ 4,36	PZ 2	100 mm
C885/3150	€ 4,64	PZ 3	150 mm

**C885/2038**

€ 2,91

GIRAVITE A CROCE PZ, APPENDIBILE

Con punta magnetica fosfatata nera e manico realizzato in resina TPR altamente elastica e materiale polipropilene resistente all'olio.



Misura	PZ 2
Lunghezza asta	38 mm

C880/006

€ 17,00

SERIE GIRAVITI

Con punta magnetica fosfatata nera e manico realizzato in resina TPR altamente elastica e materiale polipropilene resistente all'olio.

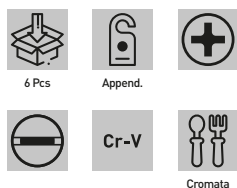

Misure Taglio	(-) 4 x 100 mm, (-) 5 x 125 mm, (-) 6 x 150 mm
Croce	(+) PH 1 x 75 mm, (+) PH 2 x 100 mm, (+) PH 3 x 150 mm

0633

€ 15,90

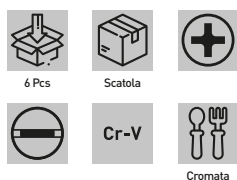
SERIE GIRAVITI A LAME PASSANTI

Misure Taglio	(-) 5,0x1,0x75 mm, (-) 6,0x1,2x100 mm, (-) 6,0x1,2x125 mm, (-) 8,0x1,2x150 mm
Croce	(+) PH 1x5x75 mm, (+) PH 2x6x100 mm

C881-**GIRAVITE TORX, APPENDIBILE**

Con punta magnetica fosfatata nera e manico realizzato in resina TPR altamente elastica e materiale polipropilene resistente all'olio.



Art.	€	Misure	Lunghezza asta	Lunghezza totale
C881/07075	€ 1,21	T7	75 mm	160 mm
C881/08075	€ 1,21	T8	75 mm	160 mm
C881/10075	€ 1,21	T10	75 mm	160 mm
C881/15100	€ 1,76	T15	100 mm	200 mm
C881/20100	€ 1,76	T20	100 mm	200 mm
C881/25125	€ 1,93	T25	125 mm	225 mm
C881/27125	€ 1,93	T27	125 mm	225 mm
C881/30150	€ 2,51	T30	150 mm	260 mm
C881/35150	€ 3,01	T35	150 mm	260 mm
C881/40150	€ 3,01	T40	150 mm	260 mm

C881/006

€ 11,00

SERIE GIRAVITI TORX

Con punta magnetica fosfatata nera e manico realizzato in resina TPR altamente elastica e materiale polipropilene resistente all'olio.

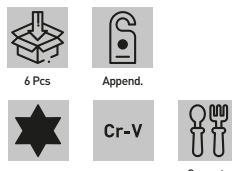

Misure torx	T10x75 mm, T15x100 mm, T20x100 mm, T25x125 mm, T27x125 mm, T30x150 mm
-------------	-----------------------------------------------------------------------

0634

€ 12,50

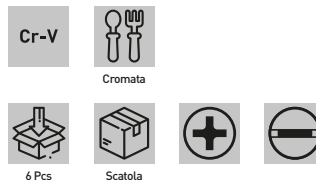
SERIE GIRAVITI

Misure Taglio	(-) 4x0,8x75 mm, (-) 5,5x1,0x100 mm, (-) 6,5x1,2x150 mm
Croce	(+) PH 0x3x75 mm, (+) PH 1x5x100 mm, (+) PH 2x6x125 mm

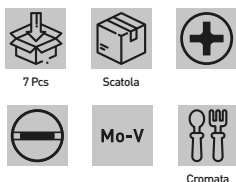
0880/307
€ 20,40
SERIE GIRAVITI

Taglio (-) 3,0x0,5x75 mm, (-) 4,0x0,8x100 mm, (-) 5,5x1,0x125 mm, (-) 6,5x1,2x150 mm, (-) 8,0x1,2x150 mm

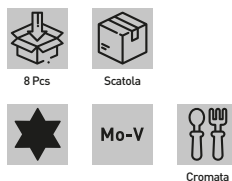
Croce (+) PH 1x80 mm, (+) PH 2x100 mm

0881/008
€ 17,00
SERIE GIRAVITI TORX

Torx T 7x60 - T 8x60 - T 9x60 - T 10x80 - T 15x80 - T 20x100 - T 25x100 - T 30x115 mm

C182-
GIRAVITE A CROCE ISOLATO

1000V IEC 60900, con punta magnetica fosfatata nera e manico bi-colore in polipropilene resistente all'olio.



Art.	€	Misura	Lunghezza asta	Lunghezza totale
C182/0060	€ 3,02	PH0 x 3 mm	60 mm	160 mm
C182/1080	€ 3,94	PH1 x 4.5 mm	80 mm	185 mm
C182/2100	€ 4,64	PH2 x 6 mm	100 mm	210 mm
C182/3150	€ 7,70	PH3 x 8 mm	150 mm	265 mm

C183-
GIRAVITE A TAGLIO ISOLATO

1000V IEC 60900, con punta magnetica fosfatata nera e manico bi-colore in polipropilene resistente all'olio.



Art.	€	Misura	Lunghezza asta	Lunghezza totale
C183/25075	€ 3,02	0.4 x 2.5 mm	75 mm	175 mm
C183/30100	€ 3,94	0.6 x 3 mm	100 mm	200 mm
C183/40100	€ 3,94	0.8 x 4 mm	100 mm	200 mm
C183/55125	€ 4,24	1 x 5.5 mm	125 mm	230 mm
C183/65150	€ 5,60	1.2 x 6.5 mm	150 mm	260 mm
C183/80175	€ 7,40	1.6 x 8 mm	175 mm	290 mm

C180/006
€ 22,80
SERIE GIRAVITI ISOLATI

1000V IEC 60900, con punta magnetica fosfatata nera e manico bi-colore in polipropilene resistente all'olio.

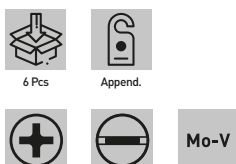
Misure Taglio (-) 0,6 x 3 x 100 mm, (-) 0,8 x 4 x 100 mm, (-) 1 x 5,5 x 125 mm
Croce (+) PH 0 x 3 x 60 mm, (+) PH 1 x 4,5 x 80 mm, (+) PH 2 x 6 x 100 mm

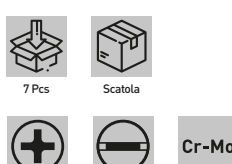
0355
€ 19,70
SERIE GIRAVITI ELETTRICISTA

Misure Taglio (-) 0,4x2,5x85 mm, (-) 0,8x4,0x100 mm, (-) 1,0x5,5x125 mm, (-) 1,2x6,5x150 mm
Croce (+) PH 0x75 mm, (+) PH 1x100 mm, (+) PH 2x100 mm



0083

€ 11,90

GIRAVITE A PERCUSSIONE

Fornito in astuccio di plastica.



7 Pcs



Scatola



Acciaio



Satinata

Dimensioni	165 x 42 mm
Inserti	6
Attacco	5/16"

P882-

GIRAVITE DI PRECISIONE PH

Con punta magnetica brunita, impugnatura in materiale bicomponente con parte terminale libera di ruotare per un perfetto grip.



Cr-V



Fosfatata



8764

Art.	€	Misura	Lunghezza asta	Lunghezza totale
P882/0150	€ 2,82	PH 1	50 mm	140 mm
P882/1050	€ 2,82	PH 0	50 mm	140 mm
P882/2050	€ 2,82	PH 00	50 mm	140 mm

P886-

GIRAVITE DI PRECISIONE ESAGONALE

Con punta magnetica brunita, impugnatura in materiale bicomponente con parte terminale libera di ruotare per un perfetto grip.



Cr-V



Fosfatata



2936

Art.	€	Misura	Lunghezza asta	Lunghezza totale
P886/1350	€ 2,82	1,3 mm	50 mm	140 mm
P886/1550	€ 2,82	1,5 mm	50 mm	140 mm
P886/2050	€ 2,82	2,0 mm	50 mm	140 mm
P886/2550	€ 2,82	2,5 mm	50 mm	140 mm
P886/3050	€ 2,82	3,0 mm	50 mm	140 mm

P883-

GIRAVITE DI PRECISIONE A TAGLIO

Con punta magnetica brunita, impugnatura in materiale bicomponente con parte terminale libera di ruotare per un perfetto grip.



Cr-V



Fosfatata



2380-1

Art.	€	Misura	Lunghezza asta	Lunghezza totale
P883/1250	€ 2,82	1,2 mm	50 mm	140 mm
P883/1650	€ 2,82	1,6 mm	50 mm	140 mm
P883/1850	€ 2,82	1,8 mm	50 mm	140 mm
P883/2050	€ 2,82	2,0 mm	50 mm	140 mm
P883/2450	€ 2,82	2,4 mm	50 mm	140 mm
P883/3050	€ 2,82	3,0 mm	50 mm	140 mm
P883/3550	€ 2,82	3,5 mm	50 mm	140 mm
P883/4050	€ 2,82	4,0 mm	50 mm	140 mm

P881-

GIRAVITE DI PRECISIONE TORX

Con punta magnetica brunita, impugnatura in materiale bicomponente con parte terminale libera di ruotare per un perfetto grip.



Cr-V



Fosfatata

Art.	€	Misura	Lunghezza asta	Lunghezza totale
P881/0550	€ 2,82	T5	50 mm	140 mm
P881/0650	€ 2,82	T6	50 mm	140 mm
P881/0750	€ 2,82	T7	50 mm	140 mm
P881/0850	€ 2,82	T8	50 mm	140 mm
P881/0950	€ 2,82	T9	50 mm	140 mm
P881/1050	€ 2,82	T10	50 mm	140 mm
P881/1550	€ 2,82	T15	50 mm	140 mm



P880/06S

€ 15,60

SERIE GIRAVITI DI PRECISIONE

Con punta magnetica brunita, impugnatura in materiale bicomponente con parte terminale libera di ruotare per un perfetto grip.



Taglio	1.2 x 50 mm, 2.0 x 50 mm, 3.0 x 50 mm
Croce	PH 00 x 50 mm, PH 0 x 50 mm, PH 1 x 50 mm

0207

€ 15,10

SERIE DI MINI GIRAVITI CON DOPPIA LAMA



Lunghezza lama	110 mm
Lunghezza manico	170 mm

0082

€ 1,54

SERIE GIRAVITI PRECISIONE



4 a taglio	4 Pcs 1,4x20 mm - 2x23 mm - 2,4x24 mm - 3x27 mm
2 a croce	2 Pcs PH 1x30 mm - PH 0x25 mm

0888

€ 22,70

PORTA INSERTI AD ANGOLO 90°

Manico porta bit.



P. 444

P881/06S

€ 15,60

SERIE GIRAVITI DI PRECISIONE TORX

Con punta magnetica brunita, impugnatura in materiale bicomponente con parte terminale libera di ruotare per un perfetto grip.



Torx	T5 x 50 mm, T6 x 50 mm, T7 x 50 mm, T8 x 50 mm, T9 x 50 mm, T10
------	-----------------------------------------------------------------

0829

€ 6,30

SERIE GIRAVITI E CHIAVI DI PRECISIONE

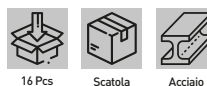

0466/DM

€ 2,03

MAGNETIZZATORE/DEMAGNETIZZATORE PER GIRAVITI



Dimensioni	52 x 50 x 28.5 mm
------------	-------------------

PIF1

€ 8,60

PORTA INSERTI FLESSIBILE MAGNETICO

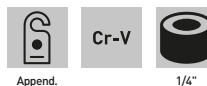
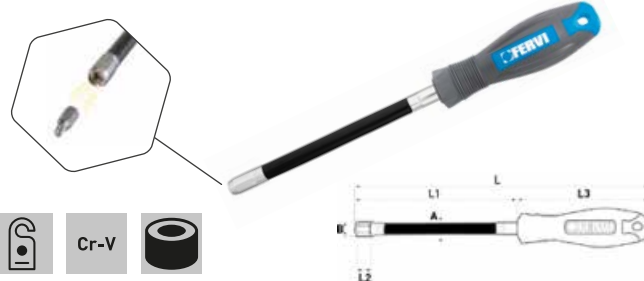

L	265 mm	L3	115 mm
L1	150 mm	A	10 mm
L2	9,5 mm	B	11,8 mm



0562

€ 6,00

PORTA INSERTI MAGNETICO

Manico tricomponente realizzato in resina TPR altamente elastica e materiale polipropilene resistente all'olio.



Append.



Cromata

1/4"



Lunghezza 200 mm

0562N

€ 4,87

PORTA INSERTI MAGNETICO NANO

Manico tricomponente realizzato in resina TPR altamente elastica e materiale polipropilene resistente all'olio.



Append.



Cromata

1/4"



Lunghezza 110 mm

0304

€ 7,20

PORTA INSERTI MAGNETICO

Append.



Cromata

1/4"

0406

€ 3,64

PORTA INSERTI ESAGONALI A CAMBIO RAPIDO

Espositore



Cromata

1/4"

Lunghezza 60 mm

0548

€ 13,10

PORTA INSERTO A CRICCHETTO

Porta inserti corto a cricchetto reversibile, con un inserto, di dimensioni molto ridotte per avvitare e svitare in poco spazio.



Append.



Satinata



72 Denti



1/4"

Dimensioni ø 29 x 60 mm

0407

€ 4,03

PORTA INSERTI

Con impugnatura dritta e a 90°, utile ad agevolare il lavoro in piccoli spazi.



8 Pcs

Append.

Lunghezza 105 mm

Phillips 1 - 2

Pozi-driv 1 - 2

Taglio 2 - 3 - 4 mm

0089

€ 1,88

SERIE INSERTI

7 Pcs

Append.

Phillips 1 - 2

Pozi-driv 1 - 2

Taglio 4 - 6 mm



0358
€ 32,30
SERIE INSERTI, BUSSOLE E PORTA INSERTI



Inserti	
Phillips	0 - 1 - 2 (x5 Pz/Pcs) - 3
Pozi-driv	0 - 1 - 2 (x5 Pz/Pcs) - 3
Taglio	3 - 4 - 4,5 - 5 - 5,5 - 6 - 6,5 - 7 - 8 mm
Spanner	4 - 6 - 8 - 10
Torx	8 - 10 - 15 - 20 - 25 - 27 - 30 - 40 - 45
Triplay	1 - 2 - 3 - 4
Torx con foro	8 - 10 - 15 - 20 - 25 - 27 - 30 - 35 - 40
Torq-set	6 - 8 - 10
Esagonali metrici	1,5 - 2 - 2,5 - 3 - 4 - 5 - 5,5 - 6 - 8 mm
Robertson	0 - 1 - 2 - 3
Esagonali pollici	1/16 - 5/64 - 3/32 - 7/64 - 1/8 - 9/64 - 5/32 - 3/16 - 7/32 - XZN M5 - M6 - M8
Esagonali con foro	2 - 2,5 - 3 - 4 - 5 - 6 - 5/64 - 3/32 - 7/64 - 1/8 - 9/64 - 5/32
Clutch	1 - 2 - 3
Adattatore maschio con quadro da 1/4" e esagono da 1/4"	25 mm



Adattatore maschio con quadro da 1/4" e esagono da 1/4"	50 mm
Inserto a "Y"	1 Pz
Adattatore inserti	1 Pz
Porta inserti magnetico	60 mm
Porta inserti	1 Pz
Inserti a bussola	4 - 5 - 6 - 7 - 8 - 9 - 10 - 11 - 12 - 13 - 5/32 - 3/13 - 7/32 -

0626L
€ 21,70
SERIE INSERTI LUNGI

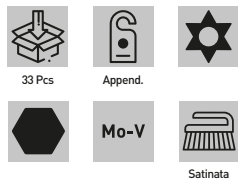
Con porta inserto magnetico.



Lunghezza	50 mm
Inserti	
Torx con foro	T7 - T8 - T10 - T15 - T20 - T25 - T30 - T35 - T40
Esagonali con foro	6 - 5 - 4 - 3 - 2,5 - 2 mm
Esagonali con foro	5/32 - 9/64 - 1/8 - 7/64 - 3/32 - 5/64
Spanner	4 - 6 - 8 - 10
Torq-set	6 - 8 - 10
Tri-wing	1 - 2 - 3 - 4

0626
€ 9,80
SERIE INSERTI

Con porta inserto magnetico.

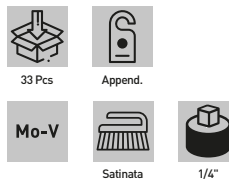

Inserti	
Torx	T7 - T8 - T10 - T15 - T20 - T25 - T30 - T35 - T40
Esagonali	
Metrici	6 - 5 - 4 - 3 - 2,5 - 2 mm
Pollici	5/32 - 9/64 - 1/8 - 7/64 - 3/32 - 5/64
Spanner	4 - 6 - 8 - 10
Torq-set	6 - 8 - 10
Tri-wing	1 - 2 - 3 - 4

PI063
€ 27,10
KIT PORTA INSERTI MULTIUSO PER RIPARAZIONI

Kit di 62 inserti più manico magnetizzato con tappo girevole per la riparazione di precisione dei tuoi apparecchi, inclusi smartphones, orologi ed elettrodomestici. La scatola porta inserti magnetizzata e la funzione click-clack, consentono di mantenere organizzate le punte senza perderle.



Porta inserti magnetico	1
Phillips	PH00000 - PH0000 - PH000 - PH00 - PH0 - PH1 - PH2
Taglio	1.0 - 1.3 - 1.5 - 2.0 - 2.5 - 3.0 - 4.0
Esagonali	0.7 - 0.9 - 1.3 - 1.5 - 2.0 - 2.5 - 3.0 - 3.5 - 4.0
Pozi-driv	PZ000 - PZ00 - PZ0 - PZ1
Robertson	0 - 1 - 2
Inserto a "Y"	Y0.6 - Y1.5 - Y2.3 - Y3.0
Inserto a stella	0.8 - 1.2 - 1.5 - 2.0
Inserto a triangolo	2.0 - 2.3 - 3.0
Inserto a U	U2.3 - U2.6
G	G3.8 - G4.5
M	M2.5 - M3.0 - M4.0
MID	
ICS	





0732

€ 11,00 **NEW****SERIE DI INSERTI CON PORTA INSERTI**

Composto da 30 inserti, 1 adattatore e 1 porta inserti



32 Pcs



Blister

Cr-V



1/4"



1/4"

Adattatore	25 mm
Porta inserti magnetico	1
Taglio	3 - 4 - 5,5 - 7 mm
Esagonali	3 - 4 - 5 - 6
Phillips	PH1 - PH2 - PH3 - PH4
Pozi-driv	PZ1 - PZ2 - PZ3 - PZ4
Torx	T10 - T15 - T20 - T25 - T30 - T35 - T40
Torx con foro	T10 - T15 - T20 - T25 - T30 - T35 - T40

0403

€ 17,50

SERIE BUSSOLE E INSERTI ESAGONALI

Composto da 6 bussole, 18 inserti, 1 adattatore per bussole e 1 giravite a cricchetto.



26 Pcs



Blister

Cr-V

Mo-V



Nichelata



1/4"



1/4"

Porta inserti a cricchetto	1
Porta inserti magnetico	1
Adattatore	25 mm
Bussole	5 - 6 - 7 - 8 - 9 - 10 mm
Taglio	3 - 4 - 5 - 6 - 7 mm
Phillips	0 - 1 - 2 - 3
Pozi-driv	0 - 1 - 2 - 3
Punta quadrata	S0 - S1 - S2 - S3

0404

€ 15,40

SERIE BUSSOLE E INSERTI ESAGONALI

Bussole in CR-V e inserti esagonali in acciaio S2, rivestiti di nichel, con porta inserto a cambio rapido.



35 Pcs



Blister

Cr-V

Mo-V



Nichelata



1/4"



1/4"

Adattatore	25 mm
Porta inserti magnetico	1
Prolunga per bussole	1
Bussole	5 - 6 - 7 - 8 - 9 - 10 - 11 - 12 mm
Taglio	3 - 4 - 5 - 5,5 - 6 - 7 mm
Phillips	0 - 1 - 2 - 3
Pozi-driv	0 - 1 - 2 - 3
Punta quadrata	S0 - S1 - S2 - S3
Torx	T10 - T15 - T20 - T25 - T30 - T40

0402

€ 18,20

SERIE INSERTI ESAGONALI

In acciaio s2 e rivestiti di nichel, composto da 40 inserti e 1 cricchetto reversibile a 72 denti.



41 Pcs



Blister

Cr-V

Mo-V



Nichelata



1/4"



1/4"

Attacco	1/4"
Taglio	3 - 4 - 5 - 5,5 - 6 - 7 mm
Phillips	2 x 0 - 2 x 1 - 2 x 2 - 2 x 3
Pozi-driv	2 x 0 - 2 x 1 - 2 x 2 - 2 x 3
Punta quadrata	S0 - S1 - S2 - S3
Torx	T10 - T15 - T20 - T25 - T27 - T30 - T40
Esagonali	2 - 2,5 - 3 - 4 - 5 - 5,5 - 6 mm

0104
€ 37,10
SERIE INSERTI

1 Bussola porta inserti 1/2"	1/2" - 1 x 10 mm
1 Bussola porta inserti 3/8"	3/8" - 1 x 10 mm
7 Inserti esagonali 4-5-6-7-8-10-12 mm	30 mm
7 Inserti esagonali 4-5-6-7-8-10-12 mm	75 mm
5 Inserti "XZN" 5-6-8-10-12 mm	30 mm
5 Inserti "XZN" 5-6-8-10-12 mm	75 mm
7 Inserti TORX T20-T25-T30-T40-T45-T50-T55	30 mm
7 Inserti TORX T20-T25-T30-T40-T45-T50-T55	75 mm

0277
€ 33,30
SERIE BUSSOLE E INSERTI

Con giravite e cricchetto.

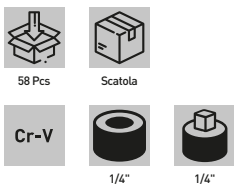

Inserti	25 mm
Phillips (25 mm)	1 - 2 - 3
Pozi-driv	1 - 2 - 3
Taglio	3,5 - 4,5 - 5,5 - 6,5 mm
Spanner	4 - 6 - 8
Torx	10 - 15 - 20 - 25 - 27 - 30 - 40
Tri-wing	1 - 2 - 3 - 4
Torq-set	6 - 8 - 10
Esagonali	2 - 3 - 4 - 5 - 6 - 8 mm
Robertson	1 - 2 - 3
XZN	5 - 6 - 8
Clutch	1 - 2 - 3
Bussole esagonali	5 - 6 - 7 - 8 - 10 mm
Bussole esagonali	3/16 - 1/4 - 9/32 - 5/16 - 3/8
Adattatore	1/4"
Inserto a "Y"	1
Adattatore	1
Porta inserti magnetico	1
Porta inserti	1
Cricchetto reversibile	1/4"

0640
€ 22,70
SERIE INSERTI

Inserti

Phillips	0 - 1 - 2 (x5 Pz/Pcs) - 3
Pozi-driv	0 - 1 - 2 (x5 Pz/Pcs) - 3
Taglio	3 - 4 - 4,5 - 5 - 5,5 - 6 - 6,5 - 7 - 8 mm
Spanner	4 - 6 - 8 - 10
Torx	8 - 10 - 15 - 20 - 25 - 27 - 30 - 40 - 45
Tripley	1 - 2 - 3 - 4
Torx con foro	8 - 10 - 15 - 20 - 25 - 27 - 30 - 35 - 40
Torq-set	6 - 8 - 10
Esagonali metrici	1,5 - 2 - 2,5 - 3 - 4 - 5 - 5,5 - 6 - 8 mm
Robertson	0 - 1 - 2 - 3
Esagonali pollici	1/16 - 5/64 - 3/32 - 7/64 - 1/8 - 9/64 - 5/32 - 3/16 - 7/32 - 1/4
XZN	M5 - M6 - M8
Esagonali con foro	2 - 2,5 - 3 - 4 - 5 - 6 - 5/64 - 3/32 - 7/64 - 1/8 - 9/64 - 5/32
Clutch	1 - 2 - 3

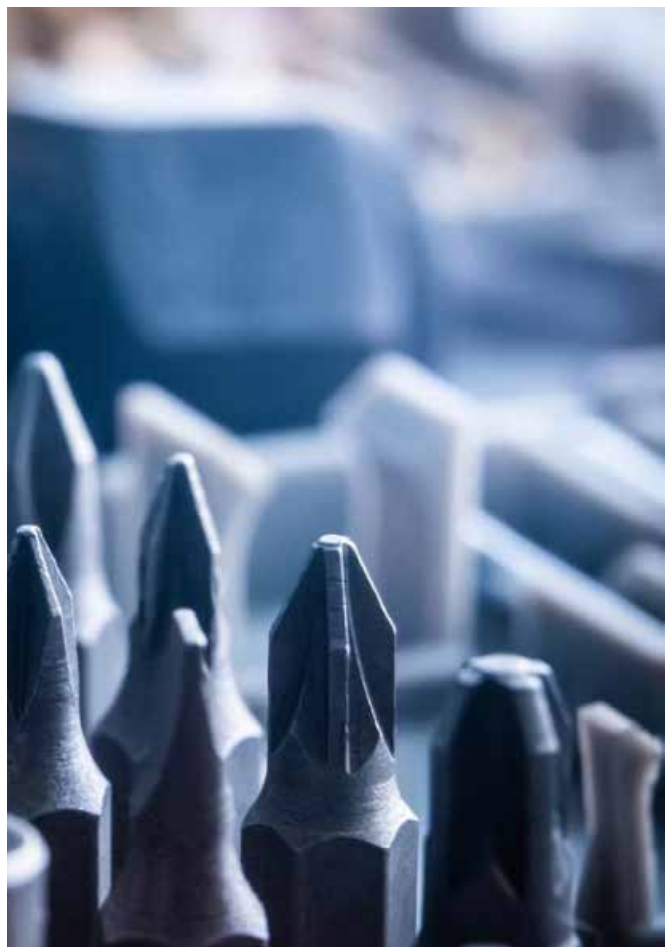

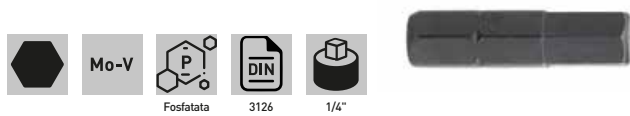
**IS25-ESX****INSERTI ESAGONALI**

Art.	€	Misura	Lunghezza	Pack
IS25/ES2	€ 0,57	2 mm	25 mm	10
IS25/ES25	€ 0,57	2.5 mm	25 mm	10
IS25/ES3	€ 0,57	3 mm	25 mm	10
IS25/ES4	€ 0,57	4 mm	25 mm	10
IS25/ES5	€ 0,57	5 mm	25 mm	10
IS25/ES6	€ 0,57	6 mm	25 mm	10
IS25/ES8	€ 0,86	8 mm	25 mm	10
IS25/ES10	€ 1,38	10 mm	25 mm	10

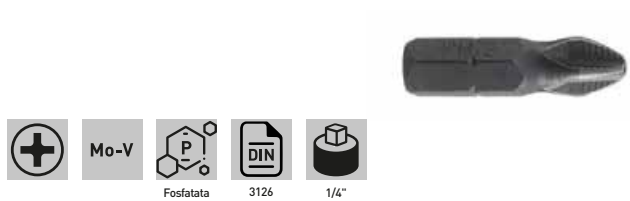
IS25-PHXAS**INSERTI A CROCE PH ANTI SLIP**

Art.	€	Misura	Lunghezza	Pack
IS25/PH1AS	€ 0,61	PH 1	25 mm	10
IS25/PH2AS	€ 0,61	PH 2	25 mm	10
IS25/PH3AS	€ 0,61	PH 3	25 mm	10

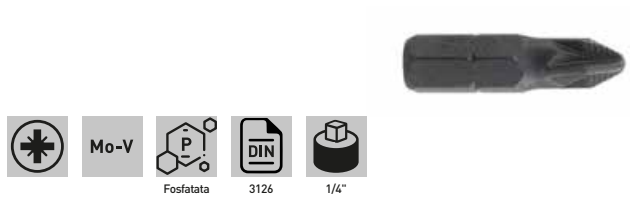
IS25-PZXAS**INSERTI A CROCE PZ ANTI SLIP**

Art.	€	Misura	Lunghezza	Pack
IS25/PZ1AS	€ 0,61	PZ 1	25 mm	10
IS25/PZ2AS	€ 0,61	PZ 2	25 mm	10
IS25/PZ3AS	€ 0,61	PZ 3	25 mm	10

IS25-TXX**INSERTI TORX**

Art.	€	Misura	Lunghezza	Pack
IS25/TX10	€ 0,46	T10	25 mm	10
IS25/TX15	€ 0,46	T15	25 mm	10
IS25/TX20	€ 0,46	T20	25 mm	10
IS25/TX25	€ 0,46	T25	25 mm	10
IS25/TX30	€ 0,46	T30	25 mm	10
IS25/TX35	€ 0,46	T35	25 mm	10
IS25/TX40	€ 0,46	T40	25 mm	10
IS25/TX45	€ 1,21	T45	25 mm	10
IS25/TX50	€ 1,21	T50	25 mm	10
IS25/TX55	€ 1,38	T55	25 mm	10

IS25-PHX**INSERTI A CROCE PH**

Art.	€	Misura	Lunghezza	Pack
IS25/PH0	€ 0,38	PH 0	25 mm	20
IS25/PH1	€ 0,38	PH 1	25 mm	20
IS25/PH2	€ 0,38	PH 2	25 mm	20
IS25/PH3	€ 0,38	PH 3	25 mm	20

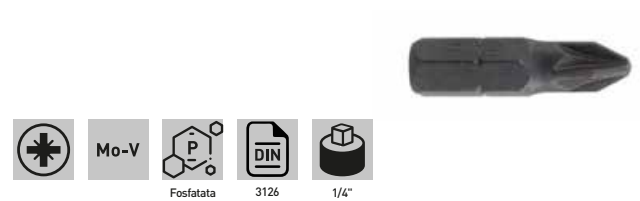
IS25-PZX**INSERTI A CROCE PZ**

Art.	€	Misura	Lunghezza	Pack
IS25/PZ1	€ 0,38	PZ 1	25 mm	20
IS25/PZ2	€ 0,38	PZ 2	25 mm	20
IS25/PZ3	€ 0,38	PZ 3	25 mm	20

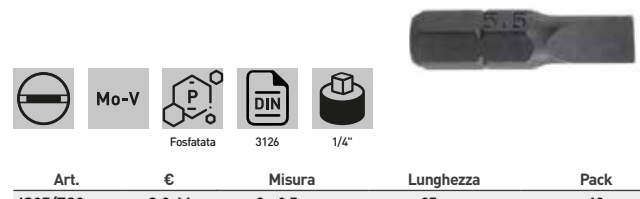
IS25-TGX**INSERTI A TAGLIO**

Art.	€	Misura	Lunghezza	Pack
IS25/TG3	€ 0,46	3 x 0.5 mm	25 mm	10
IS25/TG4	€ 0,46	4 x 0.8 mm	25 mm	10
IS25/TG5.5	€ 0,46	5.5 x 0.8 mm	25 mm	10
IS25/TG6	€ 0,46	6 x 1 mm	25 mm	10
IS25/TG8	€ 0,81	8 x 1.2 mm	25 mm	10

IS50-ESX**INSERTI ESAGONALI**

Corpo a diametro ridotto.

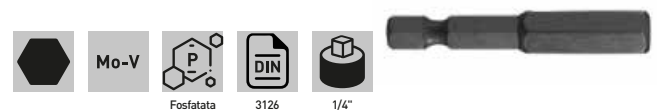

Art.	€	Misura	Lunghezza	Pack
IS50/ES2	€ 1,17	2 mm	50 mm	5
IS50/ES25	€ 0,96	2.5 mm	50 mm	5
IS50/ES3	€ 0,96	3 mm	50 mm	5
IS50/ES4	€ 0,96	4 mm	50 mm	5
IS50/ES5	€ 0,96	5 mm	50 mm	5
IS50/ES6	€ 0,96	6 mm	50 mm	5
IS50/ES8	€ 1,21	8 mm	50 mm	5
IS50/ES10	€ 1,21	10 mm	50 mm	5

IS50-PHX
INSERTI A CROCE PH

Corpo a diametro ridotto.



Art.	€	Misura	Lunghezza	Pack
IS50/PH1	€ 0,77	PH 1	50 mm	10
IS50/PH2	€ 0,77	PH 2	50 mm	10
IS50/PH3	€ 0,77	PH 3	50 mm	10

IS50-PZX
INSERTI A CROCE PZ

Corpo a diametro ridotto.



Art.	€	Misura	Lunghezza	Pack
IS50/PZ1	€ 0,77	PZ 1	50 mm	10
IS50/PZ2	€ 0,77	PZ 2	50 mm	10
IS50/PZ3	€ 0,77	PZ 3	50 mm	10

IS50-TGX
INSERTI A TAGLIO

Corpo a diametro ridotto.



Art.	€	Misura	Lunghezza	Pack
IS50/TG3	€ 1,21	3 x 0.5 mm	50 mm	5
IS50/TG4	€ 1,21	4 x 0.8 mm	50 mm	5
IS50/TG5.5	€ 1,21	5.5 x 0.8 mm	50 mm	5
IS50/TG6	€ 1,21	6 x 1 mm	50 mm	5
IS50/TG8	€ 1,38	8 x 1.2 mm	50 mm	5

IS50-TXX
INSERTI TORX

Corpo a diametro ridotto.



Art.	€	Misura	Lunghezza	Pack
IS50/TX10	€ 1,38	T10	50 mm	5
IS50/TX15	€ 1,38	T15	50 mm	5
IS50/TX20	€ 1,38	T20	50 mm	5
IS50/TX25	€ 1,38	T25	50 mm	5
IS50/TX30	€ 1,38	T30	50 mm	5
IS50/TX35	€ 1,38	T35	50 mm	5
IS50/TX40	€ 1,38	T40	50 mm	5

S018
€ 90,80
SET RIVETTATRICI CON RIVETTI

Rivetti	50 x ø2,4 mm - 50 x ø3,2 mm - 50 x ø4,0 mm - 50 x ø4,8 mm
Rivetti filettati	50 x M3 - 50 x M4 - 25 x M5 - 25 x M6 - 20 x M8
Descrizione	330 x 170 x 150 mm

**0455****€ 100,00****RIVETTATRICE A DOPPIA LEVA PER INSERTI FILETTATI**

Leve lunghe per lavorare senza sforzo. Completa di 7 tiranti filettati e 7 testine.

Tiranti filettati M3 - M4 - M5 - M6 - M8 - M10 - M12
Lunghezza 400 mm**0469****€ 55,40****RIVETTATRICE PER INSERTI FILETTATI**Completa di 4 tiranti filettati e 4 testine.
Manici ergonomici.Tiranti filettati M3 - M4 - M5 - M6
Lunghezza 200 mm**0453****€ 44,80****RIVETTATRICE A DOPPIA LEVA**

Leve lunghe per lavorare senza sforzo, anche con rivetti da 6.4 mm. Serbatoio in plastica per recupero chiodo tranciato.

Rivetti Ø 3,2 - 4,0 - 4,8 - 6,0 - 6,4 mm
Lunghezza 400 mm**0454****€ 50,50****RIVETTATRICE A DOPPIA LEVA A CAMBIO RAPIDO**

Leve lunghe per lavorare senza sforzo, anche con rivetti da 6.4 mm. Serbatoio in plastica per recupero chiodo tranciato. Con testina rotante a 4 posizioni.

Rivetti Ø 3,2 - 4,0 - 4,8 - 6,4 mm
Lunghezza 400 mm**0470****€ 18,20****RIVETTATRICE A CAMBIO RAPIDO**

Con testina rotante a 4 posizioni.



Rivetti 2,4 mm - 3,2 mm - 4,0 mm - 4,8 mm

0789**€ 18,20****RIVETTATRICE MANUALE**Rivetti 2,4 mm - 3,2 mm - 4,0 mm - 4,8 mm
Lunghezza 255 mm

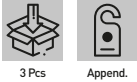
0872/P
€ 68,60
SERIE PINZE LUNGHE A DOPPIO SNODO

3 Pcs

Append.

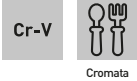

Cr-V

Cromata

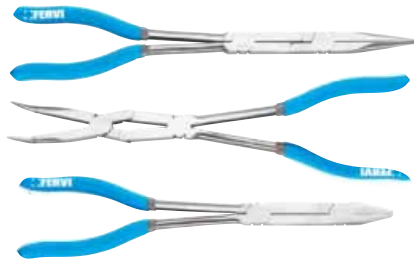

Lunghezza	335 mm
Spessore	10 mm

0872/PDD
€ 25,70
PINZA LUNGA A DOPPIO FULCRO DRITTA

Append.

Cr-V



Cromata



Lunghezza	335 mm
Spessore	10 mm

0872/PCD
€ 25,70
PINZA LUNGA A DOPPIO FULCRO A 45°

Append.

Cr-V



Cromata



Lunghezza	335 mm
Spessore	10 mm

0872/OPD
€ 26,80
PINZA LUNGA A DOPPIO FULCRO

Append.

Cr-V



Cromata



Lunghezza	335 mm
Spessore	10 mm

0873-U
PINZE UNIVERSALI

Append.

Cr-V



Cromata



Art.	€	Lunghezza	Spessore
0873/U6	€ 8,40	160 mm	11 mm
0873/U7	€ 8,90	180 mm	10,5 mm
0873/U8	€ 10,10	200 mm	12 mm

0873-BD
PINZA A BECCHI MEZZITONDI

Append.

Cr-V



Cromata



Art.	€	Lunghezza	Spessore
0873/BD6	€ 7,20	160 mm	9 mm
0873/BD8	€ 9,10	200 mm	10 mm

0873-BC
PINZA A BECCHI MEZZITONDI PIEGATI 45°

Append.

Cr-V



Cromata



Art.	€	Lunghezza	Spessore
0873/BC6	€ 7,20	160 mm	9 mm
0873/BC8	€ 9,10	200 mm	10 mm

0873/TL
€ 7,90
TRONCHESE A TAGLIENTE LATERALE

Append.

Cr-V



Cromata



Lunghezza	160 mm
Spessore	9 mm



0873/TF

€ 10,00

TRONCHESE A TAGLIENTE FRONTALE



Blister



Cr-V



Cromata



Lunghezza

160 mm

Spessore

11 mm

0020/1

€ 5,40

PINZA PER ELETTRONICA A BECCHI EXTRA LUNGH



Blister



Acciaio



Cromata



Lunghezza

150 mm

0020/2

€ 4,03

PINZA PER ELETTRONICA A BECCHI CURVI



Blister



Acciaio



Cromata



Lunghezza

125 mm

0020/3

€ 4,39

PINZA PER ELETTRONICA A BECCHI PIATTI



Blister



Acciaio



Cromata



Lunghezza

125 mm

0020/4

€ 4,29

PINZA PER ELETTRONICA A BECCHI LUNGH



Blister



Acciaio



Cromata



Lunghezza

125 mm

0020/5

€ 4,84

TRONCHESINA PER ELETTRONICA A TAGLIO FRONTALE



Blister



Acciaio



Cromata



Lunghezza

110 mm

0020/6

€ 4,67

TRONCHESINA PER ELETTRONICA A TAGLIO LATERALE



Blister



Acciaio



Cromata

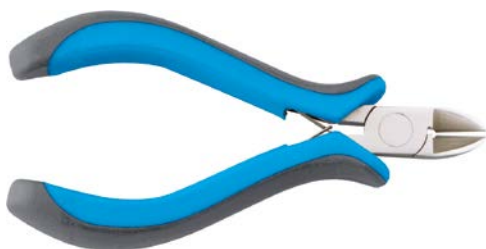

Lunghezza

110 mm

0020

€ 16,60

SERIE PINZE PER ELETTRONICA



5 Pcs



Blister



Acciaio



Bakelite



Cromata

Lunghezza

110 ÷ 125 mm

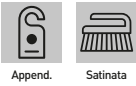
08X
PINZE UNIVERSALI

Art.	€	Lunghezza	Spessore
0810	€ 5,80	160 mm	11 mm
0811	€ 7,10	180 mm	11 mm
0850	€ 7,90	200 mm	13 mm

0813
€ 6,40
PINZE A BECCHI MEZZITONDI PIEGATI 45°

Lunghezza	160 mm
Spessore	10 mm

0841
€ 22,80
PINZE A CRICCHETTO

Con leva di sbloccaggio.



Per capicorda preisolati	Ø 0,8 ÷ 3,5 mm / 0,25 ÷ 6 mm ² AWG 22-10
Lunghezza	230 mm
Spessore	12 mm

0847
€ 74,30
PINZA PER TERMINALI DRITTI PREISOLATI

Con leva di sbloccaggio.

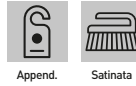

Terminali	0,25 ÷ 6 mm ² AWG 23-10
Lunghezza	175 mm
Spessore	12 mm

0812
€ 5,90
PINZE A BECCHI MEZZITONDI

Lunghezza	160 mm
Spessore	10 mm

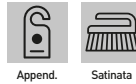
0814
€ 5,40
TRONCHESE A TAGLIENTE LATERALE

Lunghezza	160 mm
Spessore	10 mm

0843
€ 23,70
PINZE A CRICCHETTO

Con leva di sbloccaggio.



Per capicorda non isolati	Ø 1 ÷ 3,5 mm / 0,5 ÷ 6 mm ² AWG 20-10
Lunghezza	230 mm
Spessore	12 mm

0628
€ 18,00
PINZA PER CONNETTORI

Con manopola di sbloccaggio.



Connettori	RJ-11 (6P4C); RJ-12 (6P6C); RJ-45 (8P8C)
------------	------------------------------------------

**0826****€ 29,10****PINZA FASTONATRICE E SPELLAFILO**

Pinza fastonatrice per faston piccoli non isolati e spellafilo per fili sottili, settore auto e computer.



Lunghezza	215 mm
Terminali	AWG 30-26 - AWG 24-20 - AWG 18-14
Capacità di taglio	Ø 0,25 - 0,3 - 0,4 - 0,5 - 0,65 - 0,8 - 1,0 mm AWG30 - AWG28 - AWG26 - AWG24 - AWG22 - AWG20 - AWG18

024XE**PINZE PER ANELLI ELASTICI DI SICUREZZA**

Dritta per esterni.



Art.	€	Anelli elastici	Lunghezza
0246	€ 11,30	Ø 19 ÷ 60 mm	185 mm
0636	€ 9,60	Ø 10 ÷ 25 mm	160 mm
0674	€ 8,60	Ø 3 ÷ 10 mm	150 mm
0676	€ 10,90	Ø 32 ÷ 80 mm	225 mm

063XE**PINZE PER ANELLI ELASTICI DI SICUREZZA**

Curva per esterni.



Art.	€	Anelli elastici	Lunghezza
0247	€ 11,30	Ø 19 ÷ 60 mm	175 mm
0637	€ 9,60	Ø 10 ÷ 25 mm	150 mm
0108	€ 8,60	Ø 3 ÷ 10 mm	135 mm
0324	€ 10,90	Ø 32 ÷ 80 mm	215 mm

0136**€ 23,90****SERIE PINZE IN NYLON**

Per stringere tubi per liquidi auto.



Lunghezza	158 - 185 - 254 mm
Diametro tubo	10 - 15 - 24 mm

0122**€ 9,80****PINZA FASTONATRICE UNIVERSALE IN KIT**

Con terminali isolati.



Lunghezza	220 mm
-----------	--------

024XI**PINZE PER ANELLI ELASTICI DI SICUREZZA**

Dritta per interni.



Art.	€	Anelli elastici	Lunghezza
0248	€ 11,30	Ø 19 ÷ 60 mm	175 mm
0638	€ 9,60	Ø 8 ÷ 25 mm	150 mm
0619	€ 8,60	Ø 3 ÷ 10 mm	135 mm
0631	€ 10,90	Ø 32 ÷ 80 mm	225 mm

063XI**PINZE PER ANELLI ELASTICI DI SICUREZZA**

Curva per interni.



Art.	€	Anelli elastici	Lunghezza
0249	€ 11,30	Ø 19 ÷ 60 mm	165 mm
0639	€ 9,60	Ø 8 ÷ 25 mm	150 mm
0340	€ 8,60	Ø 3 ÷ 10 mm	135 mm
0364	€ 10,90	Ø 32 ÷ 80 mm	215 mm

0603**€ 102,00****SERIE PINZE PER FASCETTE AUTO**

Lunghezza	158 - 185 - 254 mm
Diametro tubo	10 - 15 - 24 mm



0118 € 4,99

PINZA IDRAULICO

6 posizioni.



Append. Acciaio

Lunghezza 240 mm

0834-

TENAGLIA CEMENTISTA



Append. Acciaio 9242

Art.	€	Lunghezza
0834	€ 5,80	220 mm
0834/200	€ 4,89	200 mm
0834/250	€ 6,10	250 mm
0834/280	€ 7,70	280 mm

0121 € 24,90

PINZA GRIP A MORSETTO



Scatola Acciaio Satinata

Lunghezza 230 mm
Regolabile 0 ÷ 155 mm

0119 NEW

PINZA GRIP



Scatola Acciaio Satinata

Art.	€	Lunghezza
0119/5	€ 5,00	130 mm
0119/7	€ 6,00	180 mm
0119	€ 7,10	220 mm

0831-

PINZA IDRAULICO

7 posizioni.



Append. 8976/C

Art.	€	Lunghezza
0831/175	€ 8,10	175 mm
0831/250	€ 9,60	250 mm
0831/300	€ 11,80	300 mm

0206 € 6,80

TENAGLIA DA FALEGNAME



Append. Acciaio

Lunghezza 200 mm

0120 € 9,80

PINZA REGOLABILE A GINOCCHIERA 4 POSIZIONI



Scatola Acciaio Satinata

Lunghezza 230 mm
Apertura 18 - 39 - 43 mm

0379 € 12,20

PINZA GRIP CON GANASCE A FORCELLA



Scatola Acciaio Satinata

Lunghezza 225 mm

**0368-****PINZA A MORSETTO AUTOMATICA**

Scatola

Cr-V



Satinata

Art.	€	Lunghezza
0368/7	€ 27,50	160 mm
0368/10	€ 35,20	230 mm

0370-**PINZA A MORSETTO AUTOMATICA CON BECCHI LUNGH**

Scatola

Cr-V



Satinata

Art.	€	Lunghezza
0370/8	€ 29,90	200 mm
0370/11	€ 42,70	275 mm

0373-**PINZA A MORSETTO AUTOMATICA CON BECCHI A "C"**

Scatola

Cr-V



Satinata

Art.	€	Lunghezza	Apertura
0373/9	€ 34,30	210 mm	65 mm
0373/11	€ 41,50	300 mm	95 mm

0130-**GIRATUBO AMERICANO**

Cr-V

Art.	€	Dimensioni	Apertura max
0130/350	€ 15,90	350 mm - 14"	50 mm
0130/600	€ 24,50	600 mm - 24"	90 mm

0225-**GIRATUBO A 45°**

Cr-V

Art.	€	Dimensioni	Apertura max
0225/340	€ 20,10	340 mm - 1"	46 mm
0225/440	€ 30,10	440 mm - 1,5"	62 mm
0225/580	€ 37,40	580 mm - 2"	72 mm
0225/700	€ 50,80	700 mm - 3"	100 mm

0227-**GIRATUBO A 90°**

Cr-V

Art.	€	Dimensioni	Apertura max
0227/340	€ 20,10	330 mm - 1" mm	38 mm
0227/440	€ 28,70	415 mm - 1,5" mm	52 mm
0227/580	€ 41,50	580 mm - 2" mm	75 mm
0227/700	€ 56,50	700 mm - 3" mm	100 mm

0511 € 37,90

MAZZA

Con manico di sicurezza in fibra di vetro e plastica, rivestito in gomma antiscivolo.



Fibra di vetro

Lunghezza	820 mm
Peso della testa	3,50 kg
Peso netto	4,45 kg

0780 € 10,10

MARTELLO CARPENTIERE

Con manico di sicurezza in fibra di vetro e plastica, rivestito in gomma antiscivolo.



Fibra di vetro

Peso netto	500 g
------------	-------

0154-

MARTELLO TIPO TEDESCO



Legno



1041

Art.	€	Peso netto
0154/100DIN	€ 2,84	100 g
0154/200DIN	€ 4,02	200 g
0154/300DIN	€ 4,22	300 g
0154/400DIN	€ 5,60	400 g
0154/500DIN	€ 5,90	500 g
0154/600DIN	€ 6,50	600 g
0154/800DIN	€ 7,20	800 g
0154/1000DIN	€ 10,70	1000 g
0154/1500DIN	€ 11,90	1500 g
0154/2000DIN	€ 15,10	2000 g

0781 € 12,80

MAZZETTA PER MURATORE

Con manico di sicurezza in fibra di vetro e plastica, rivestito in gomma antiscivolo.



Fibra di vetro



6475

Lunghezza	260 mm
Peso netto	1000 g

0514-

MARTELLO TIPO TEDESCO

Con manico di sicurezza in fibra di vetro e plastica, rivestito in gomma antiscivolo.



Fibra di vetro



1041

Art.	€	Peso netto
0514/200	€ 5,40	200 g
0514/300	€ 6,60	300 g
0514/400	€ 7,90	400 g
0514/500	€ 9,50	500 g
0514/1000	€ 14,10	1000 g

0153-

MAZZETTA PER MURATORE



Legno



6475

Art.	€	Peso netto
0153/800DIN	€ 7,20	800 g
0153/1000DIN	€ 8,00	1000 g
0153/1250DIN	€ 9,80	1250 g
0153/1500DIN	€ 11,30	1500 g

**0169-****MARTELO CARPENTIERE**

Con porta chiodo magnetico.



Legno

Art.	€	Peso netto
0169/300	€ 7,20	300 g
0169/400	€ 8,70	400 g

0216/400**€ 8,40****MARTELLINA MALEPEGGIO**

Con manico in legno.



Legno

Lunghezza manico	380 mm
Peso netto	400 g

0239/400**€ 10,40****MARTELLINA MALEPEGGIO**

Con manico in fibra di vetro e plastica rivestita in gomma antiscivolo.



Fibra di vetro

Lunghezza manico	380 mm
Peso netto	400 g

0148/500**€ 4,33****MAZZUOLO GOMMA**

Legno

Testa	ø 65 mm
Peso netto	500 g

0243-**MAZZUOLO GOMMA E FIBRA**

Fibra di vetro

Art.	€	Testa	Peso netto
0243/30	€ 5,70	ø 30 mm	350 g
0243/40	€ 8,00	ø 40 mm	500 g

0794-**MAZZUOLO GOMMA**

E manico in fibra di vetro.



Fibra di vetro

Art.	€	Testa	Peso netto
0794/350	€ 5,80	ø 55 mm	350 g
0794/450	€ 8,10	ø 58 mm	500 g

0808-**MAZZUOLO**

In alluminio con manico anatomico e teste in polietilene.



Legno

Art.	€	Testa	Peso netto
0808/35	€ 19,10	ø 35 mm	350 g
0808/60	€ 45,40	ø 60 mm	800 g

033X**MAZZUOLO ANTIRIMBALZO**

Art.	€	Testa	Peso netto
0336	€ 12,50	ø 45 mm	500 g
0337	€ 14,10	ø 50 mm	900 g

0839-

MAZZUOLO ANTIRIMBALZO

In nylon, teste di ricambio.



Art.	€	Testa	Peso netto
0839/40	€ 52,60	ø 40 mm	750 g
0839/50	€ 61,20	ø 50 mm	1000 g
0839/60	€ 68,60	ø 60 mm	1500 g

0839-XT

TESTA DI RICAMBIO

Per mazzuolo antirimbalo 0839-.



Art.	€	Testa
0839/40T	€ 12,40	ø 40 mm
0839/50T	€ 12,40	ø 50 mm
0839/60T	€ 18,10	ø 60 mm

072X

MAZZUOLO ANTIRIMBALZO

Con teste in nylon, corpo monoblocco in lega antiurto. Manico anatomico in rubinia anticivolo. Massa interna composta da sfere di piombo. Percussori sostituibili in nylon indeformabile.



Art.	€	Testa	Peso netto
0726	€ 73,90	ø 40 mm	550 g
0727	€ 86,50	ø 50 mm	900 g
0728	€ 94,30	ø 60 mm	1100 g

073X

TESTA DI RICAMBIO

Per mazzuolo antirimbalo 072x.



Art.	€	Testa	Pack
0729	€ 21,90	ø 40 mm	2
0730	€ 26,10	ø 50 mm	2
0731	€ 33,90	ø 60 mm	2

G009

€ 16,60

CAVO A SPIRALE DI SICUREZZA PER UTENSILI

Con ganci, per mettere in sicurezza utensili quando si lavora su scale o ponteggi.



Capacità	5 kg
Lunghezza	430 ÷ 1600 mm

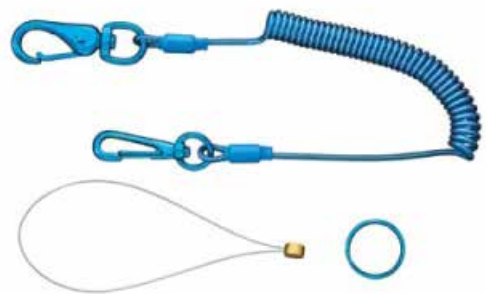



B006-

BULINO

Con stelo ottagonale.

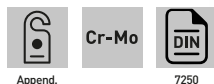

Art.	€	Misure	Lunghezza
B006/4	€ 4,15	4 mm	120 mm
B006/5	€ 5,70	5 mm	150 mm

S022-

SCALPELLO PER METALLO

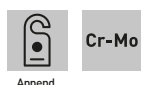

Art.	€	Dimensioni	Lunghezza
S022/18	€ 8,40	18 mm	150 mm
S022/21	€ 11,40	21 mm	200 mm
S022/25	€ 15,50	25 mm	250 mm
S022/26	€ 15,10	26 mm	240 mm

C015

SERIE DI CACCIASPINE

Con stelo ottagonale e paramano.

€ 63,20



Misure \varnothing 2 - 3 - 4 - 5 - 6 - 7 - 8 mm



0127

SERIE SCALPELLI, PUNZONI E BULINO CON SUPPORTO IN PLASTICA

€ 15,20

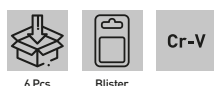

Lunghezza 120 - 150 mm



C012-

CACCIASPINE

Con stelo ottagonale.



Append.

Art.	€	Dimensioni	Lunghezza
C012/02	€ 4,78	\varnothing 2 mm	150 mm
C012/03	€ 4,78	\varnothing 3 mm	150 mm
C012/04	€ 4,78	\varnothing 4 mm	150 mm
C012/05	€ 5,40	\varnothing 5 mm	150 mm
C012/06	€ 5,90	\varnothing 6 mm	150 mm
C012/08	€ 6,50	\varnothing 8 mm	150 mm

C015-

CACCIASPINE

Con stelo ottagonale e paramano.

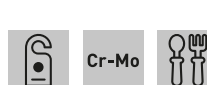

Art.	€	Misura	Lunghezza
C015/2	€ 7,50	\varnothing 2 x 8 mm	140 mm
C015/3	€ 7,90	\varnothing 3 x 8 mm	150 mm
C015/4	€ 8,50	\varnothing 4 x 10 mm	180 mm
C015/5	€ 8,80	\varnothing 5 x 10 mm	220 mm
C015/6	€ 10,40	\varnothing 6 x 12 mm	210 mm
C015/7	€ 10,40	\varnothing 7 x 12 mm	210 mm

0126

SERIE CACCIASPINE CON SUPPORTO IN PLASTICA

€ 14,60



Dimensioni \varnothing 3-4-5-6-8-10 mm
Lunghezza 150 mm



0396

SERIE SCALPELLI DA FERRO

€ 13,20



Dimensioni 10 x 8 x 140 mm, 13 x 9,5 x 150 mm, 16 x 12 x 170 mm



0381 € 8,70

SEGNACENTRO AUTOMATICO

A molla.



Lunghezza 125 mm

0733 € 10,00 **NEW**

SEGNACENTRO AUTOMATICO

A molla. Possibilità di regolazione della profondità di bulinatura.



Lunghezza 125 mm

0734- **NEW**

SEGNACENTRO PER FORI

Per eseguire centrature all'interno di fori già esistenti, grazie alla parte anteriore conica con movimento a molla si ha un centraggio accurato.

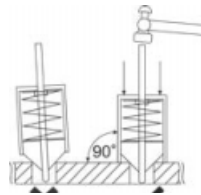

Art.	€	Lunghezza	Diametro foro
0734/1	€ 8,00	100 mm	Ø5 - Ø15 mm
0734/2	€ 13,00	82 mm	Ø5 - Ø30 mm

0391 € 32,40

SERIE SCALPELLI, PUNZONI E BULINO CON PARAMANO

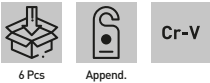

Scalpelli	10 x 135 mm, 13 x 150 mm, 16 x 160 mm
Bulini	04 x 130 mm
Cacciaspine conico	03 x 120 mm
Cacciaspine cilindrico	03 x 120 mm

0152 € 5,80

SERIE SCALPELLI CON PARAMANO

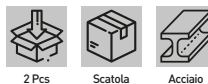

Dimensioni 16 x 250 mm

0258 € 4,33

SCALPELLO A TAGLIO CON PARAMANO



Dimensioni 16 x 300 mm

0259 € 4,15

SCALPELLO A PUNTA CON PARAMANO



Dimensioni 16 x 300 mm



0300

€ 18,70

SERIE SCALPELLI DA LEGNO



4 Pcs



Blister



Acciaio

Durezza HRC 58-60
Dimensioni 10-16-20-25 mm

0168

€ 11,00

SERIE SCALPELLI DA LEGNO



5 Pcs



Blister



Acciaio

Durezza HRC 58-60
Misure 240 x 6-10-16-20-24 mm

0162

€ 18,50

SERIE SGORBIE DA LEGNO PER TORNIO



3 Pcs



Blister



Acciaio

Durezza HRC 58-60
Lunghezza totale 370 mm

0301-

SCALPELLO PER FALEGNAME

Durezza HRC 58-60.



Blister



Acciaio

Art.	€	Dimensioni
0301/06	€ 4,48	6 mm
0301/10	€ 4,48	10 mm
0301/16	€ 5,40	16 mm
0301/20	€ 5,40	18.5 mm
0301/24	€ 6,50	25 mm

0306

€ 62,80

SERIE SGORBIE PER INTAGLIATORE



12 Pcs



Scatola



Acciaio



Cromata

Durezza HRC 58-60
Lunghezza 215 mm

0166

€ 19,70

PIALLA FALEGNAME CON DOPPIA LAMA



Scatola



Acciaio

Lunghezza pialla 225 mm
Larghezza lama 50 mm

0519 € 5,70

SERIE RASPE PER LEGNO CON MANICO IN PLASTICA



Dimensioni 200 mm - 8"



0160 € 17,40

SERIE LIME DA FERRO CON MANICO ANATOMICO



Dimensioni 200 mm - 8"



0219 € 5,60

SERIE LIME



Lunghezza totale 180 mm



0214 € 5,70

SERIE LIME AGO



Dimensioni Ø 3 x 140 mm



L011 € 26,80

SERIE LIME DIAMANTATE CURVE



Lunghezza 140 mm



L012 € 34,90

SERIE LIME DIAMANTATE

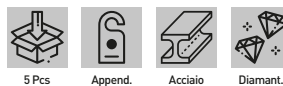

Lunghezza 180 mm



L013 € 22,80

SERIE LIME DIAMANTATE



Lunghezza 140 mm



L012/PIA € 9,60

LIMA PIATTA DIAMANTATA



Lunghezza 180 mm



**0737-****LIME PER MECCANICA**

Forma rettangolare. Complete di impugnatura, anatomica antistrucchiolo.



Art.	€	Taglio	Dimensioni	Pack
0737/150T2	€ 4,86	Mezzo dolce	150 mm - 6"	10
0737/150T3	€ 4,86	Dolce	150 mm - 6"	10
0737/200T2	€ 5,80	Mezzo dolce	200 mm - 8"	10
0737/200T3	€ 5,80	Dolce	200 mm - 8"	10
0737/250T2	€ 7,10	Mezzo dolce	250 mm - 10"	10
0737/250T3	€ 7,10	Dolce	250 mm - 10"	10

0738-**LIME PER MECCANICA**

Forma triangolare. Complete di impugnatura, anatomica antistrucchiolo.



Art.	€	Taglio	Dimensioni	Pack
0738/150T2	€ 4,86	Mezzo dolce	150 mm - 6"	10
0738/150T3	€ 4,86	Dolce	150 mm - 6"	10
0738/200T2	€ 5,80	Mezzo dolce	200 mm - 8"	10
0738/200T3	€ 5,80	Dolce	200 mm - 8"	10
0738/250T2	€ 7,10	Mezzo dolce	250 mm - 10"	10
0738/250T3	€ 7,10	Dolce	250 mm - 10"	10

0739-**LIME PER MECCANICA**

Forma mezza tonda. Complete di impugnatura, anatomica antistrucchiolo.



Art.	€	Taglio	Dimensioni	Pack
0739/150T2	€ 4,86	Mezzo dolce	150 mm - 6"	10
0739/150T3	€ 4,86	Dolce	150 mm - 6"	10
0739/200T2	€ 5,80	Mezzo dolce	200 mm - 8"	10
0739/200T3	€ 5,80	Dolce	200 mm - 8"	10
0739/250T2	€ 7,10	Mezzo dolce	250 mm - 10"	10
0739/250T3	€ 7,10	Dolce	250 mm - 10"	10

0740-**LIME PER MECCANICA**

Forma tonda. Complete di impugnatura, anatomica antistrucchiolo.



Art.	€	Taglio	Dimensioni	Pack
0740/150T2	€ 4,86	Mezzo dolce	150 mm - 6"	10
0740/150T3	€ 4,86	Dolce	150 mm - 6"	10
0740/200T2	€ 5,80	Mezzo dolce	200 mm - 8"	10
0740/200T3	€ 5,80	Dolce	200 mm - 8"	10
0740/250T2	€ 7,10	Mezzo dolce	250 mm - 10"	10
0740/250T3	€ 7,10	Dolce	250 mm - 10"	10

0741-**LIME PER MECCANICA**

Forma quadrata. Complete di impugnatura, anatomica antistrucchiolo.



Art.	€	Taglio	Dimensioni	Pack
0741/150T2	€ 4,86	Mezzo dolce	150 mm - 6"	10
0741/150T3	€ 4,86	Dolce	150 mm - 6"	10
0741/200T2	€ 5,80	Mezzo dolce	200 mm - 8"	10
0741/200T3	€ 5,80	Dolce	200 mm - 8"	10
0741/250T2	€ 7,10	Mezzo dolce	250 mm - 10"	10
0741/250T3	€ 7,10	Dolce	250 mm - 10"	10

0742-**IMPUGNATURA ANATOMICA ANTISTRUCCHILO**

Art.	€	Per lima	Pack
0742/4	€ 1,40	100 mm - 150 mm / 4" - 6"	12
0742/6	€ 1,40	150 mm - 250 mm / 6" - 10"	12
0742/10	€ 1,60	250 mm - 400 mm / 10" - 16"	12

0202 € 36,50

SERIE LEVE A BATTERE



4 Pcs



Blister



Acciaio

Dimensioni 230 mm/9" - 300 mm/12" - 450 mm/18" - 590 mm/24"

0192 € 147,00

SERIE LEVE A BATTERE

1 Pz dritta 910 mm/36", 1 Pz curva 45° 910 mm/36", 1 Pz curva 60° 610 mm/24", 1 Pz curva 90° 610 mm/24".



4 Pcs



Valigetta

Cr-V

L007 € 7,50

LEVA GOMMISTA PER MOTO



Scatola



Acciaio



Satinata

Dimensioni 215 x 16 X 5 mm

0320 € 6,60

LEVICINO CARPENTIERE IN ACCIAIO FORGIATO



Acciaio

Lunghezza totale 600 mm
Esagono 15,6 mm

0198 € 6,10

LEVA CON ESTREMITÀ A PUNTA

Leva con estremità a punta.



Acciaio

Lunghezza 400 mm
A 30 mm
B 23 mm
Pack 5

0267 € 9,60

LEVA GOMMISTA



Scatola



Acciaio



Satinata

Dimensioni 510 x 26 x 9 mm



**0623**

€ 5,40

**CUTTER CON GUIDALAMA IN ACCIAIO,
LAME DI RICAMBIO INCLUSE**

Con caricamento automatico della lama.



Blister



Acciaio

Lame in dotazione 3
Larghezza lama 18 mm**0627**

€ 4,15

**CUTTER CON GUIDALAMA IN ACCIAIO,
LAME DI RICAMBIO INCLUSE**

Con caricamento automatico della lama.



Blister



Acciaio

Lame in dotazione 5
Larghezza lama 9 mm**0617**

€ 2,61

**CUTTER CON GUIDALAMA IN ACCIAIO,
LAME DI RICAMBIO INCLUSE**

Espositore



Acciaio

Lame in dotazione 3
Larghezza lama 18 mm**0613**

€ 2,08

**CUTTER CON GUIDALAMA IN ACCIAIO
ISO 9001.**

Blister



Acciaio

Lame in dotazione 3
Larghezza lama 9 mm**0096**

€ 2,61

**CUTTER CON GUIDALAMA IN ACCIAIO,
LAME DI RICAMBIO INCLUSE**

Espositore



Acciaio

Lame in dotazione 3
Larghezza lama 18 mm**0612**

€ 3,12

CUTTER CON GUIDALAMA IN ACCIAIO

Blister



Acciaio

Lame in dotazione 3
Larghezza lama 9 mm

0611 € 2,91

CUTTER CON GUIDALAMA IN ACCIAIO



Lame in dotazione 3
Larghezza lama 9 mm

0035 € 6,50

CUTTER DI SICUREZZA, LAME DI RICAMBIO INCLUSE



Lame in dotazione 4
Lama trapezoidale 19 x 61 x 0,6 mm

0792 € 10,70

CUTTER AUTOMATICO CON GUIDALAMA IN ACCIAIO, LAME DI RICAMBIO INCLUSE



Lame in dotazione 5
Larghezza lama 25 mm

0696 € 8,00

CUTTER A SERRAMANICO, LAME DI RICAMBIO INCLUSE



Lame in dotazione 5
Larghezza lama 20 mm

0095 € 1,72

SERIE CUTTER

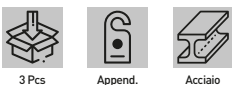
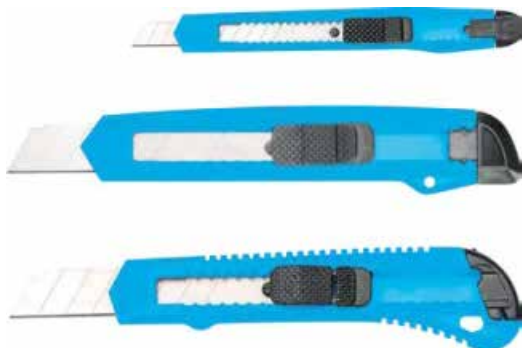

P. 468

0696/L € 1,97

SERIE LAME PER CUTTER

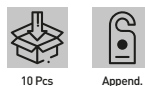

Lama trapezoidale 19 x 61 x 0,6 mm



0627/L € 2,15

SERIE LAME PER CUTTER



Larghezza lama 9 mm



**0096/L**

€ 2,15

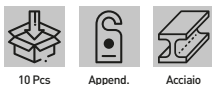
SERIE LAME PER CUTTER

Larghezza lama 18 mm

**0792/L**

€ 8,20

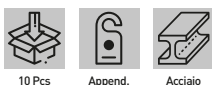
SERIE LAME PER CUTTER

Larghezza lama 25 mm

**0420**

€ 7,20

SBAVATORE CON 1 LAMA

Lunghezza	120 mm
Diametro massimo manico	9,2 mm
Lama	E100 - Ø 3,2 mm
Materiale lama	HSS

**0411**

€ 14,10

SBAVATORE CON 1 LAMA

Lunghezza	124 mm
Diametro massimo manico	29 mm
Lama	E100 - Ø 3,2 mm
Materiale lama	HSS

**0415**

€ 9,60

SBAVATORE CON 2 LAME

Lunghezza	125 mm
Diametro massimo manico	22 mm
Lama	E100 - E200 - Ø 3,2 mm
Materiale lama	HSS

**S002**

€ 15,20

SBAVATORE ESTENSIBILE CON 3 LAME

Lama	Ø 3,2 mm
Dimensioni lama	E100 - E200 - E300

0420/S

€ 22,30

SERIE SBAVATORI CON LAMA

Per sbavature interne ed esterne di materiali duri e morbidi. Comodi e pratici dotati di clip per portarli sempre con se ed averli disponibili nel momento giusto. Con impugnatura ergonomica e colorati diversamente per identificare subito lo sbavatore giusto per il materiale giusto: viola per l'alluminio, rosso per ottone e ghisa, blu per acciaio e giallo per plastica

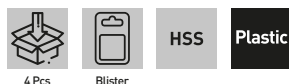

Lunghezza	120 mm
Lama	Ø 3,2 mm

S002/E100

€ 15,10

SERIE LAME IN HSS CON GAMBO LUNGO

Per sbavatura interna ed esterna di materiali a truciolo lungo come acciaio, alluminio, materie plastiche.

**S002/E200**

€ 14,10

SERIE LAME IN HSS BIDIREZIONALI

Con gambo lungo per sbavatura interna ed esterna di materiali a truciolo corto come ottone e ghisa.

**S002/E300**

€ 15,10

SERIE LAME IN HSS BIDIREZIONALI

Con gambo lungo per sbavatura interna ed esterna di fori fino a 4 mm di spessore.



S005 € 14,20

SBAVATORE DOPPIO CON DISCHI IN HSS

Per sbavare lamiere d'acciaio, alluminio, ottone, rame e plastica max 10 mm.



S005/R € 15,90

SERIE ROTELLINE



0384 € 6,50

SBAVATORE INTERNO ED ESTERNO PER TUBI

Per rame e metalli ferrosi.



Capacità 3 ÷ 32 mm 3/16" ÷ 1-1/2"

0647/25 € 17,40

RASCHIETTO CON LAMA IN METALLO DURO DA 25 MM A TRE TAGLIENTI



0647/50 € 18,20

RASCHIETTO CON LAMA IN METALLO DURO DA 50 MM A DUE TAGLIENTI



0647/65 € 19,80

RASCHIETTO CON LAMA IN METALLO DURO DA 65 MM A DUE TAGLIENTI



0647/25L € 14,20

SERIE 2 PZ LAME RICAMBIO



0647/50L € 14,50

SERIE 2 PZ LAME RICAMBIO



0647/65L € 14,50

SERIE 2 PZ LAME RICAMBIO





0367

€ 26,80

SERIE COLTELLI TAGLIABALSA

Con pietra a grana 240, 26 coltelli di ricambio.
Da usare su legno, polistirolo, EVA, gomma piuma.



34 Pcs



Blister



Acciaio



Pietra per affilare	1 - grana / grain 240
Giravite di precisione	1
Pinzetta	1
Manici a 2 colori	4
Coltelli di ricambio	26
Cofanetto	1, ABS+TPR

0226

€ 9,50

ARCHETTO CON LAMA, IMPUGNATURA IN ALLUMINIO

Con impugnatura supplementare per piccoli tagli. Corpo in alluminio e lama bimetallica.

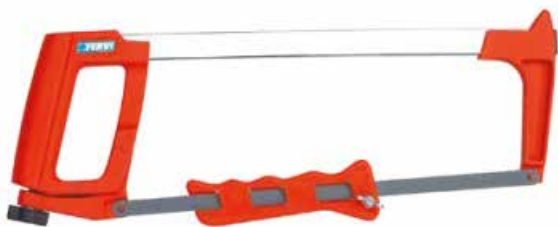

Lunghezza lama 310 mm

0161

€ 3,98

MINI ARCHETTO CON LAMA

Alu

Alluminio

Lunghezza lama 150 mm

0724/B

€ 1,99

LAMA BIMETALLICA

ISO 2336-1.



Scatola

HSS

Misure 300 x 12,7 x 0,62 mm x 24T - 12" x 1/2" x 0.025" x 24T
Pack 10

0869

€ 15,10

SEGACCIO DA FALEGNAME CON TRIPLA AFFILATURA A DIAMANTE

Acciaio

Lunghezza lama 400 mm

0629

€ 20,80

ARCHETTO CON LAMA

Corpo in alluminio e lama bimetallica.



Lunghezza lama 300 mm

0327

€ 7,90

SEGACCIO AD ARCO PER LEGNO

Acciaio



Lunghezza lama 530 mm / 21"

0159

€ 0,29

LAMA IN ACCIAIO AL CARBONIO

ISO 2336-1.



Scatola

Misure 300 x 12,7 x 0,62 mm x 24T - 12" x 1/2" x 0.025" x 24T
Pack 100

0670
€ 53,80
RODITRICE PER TRAPANO

A doppia testa con accessorio per tagli dritti e circolari.



Scatola

HSS
TiN
0670/U € 14,20
SERIE UTENSILI DI RICAMBIO

Capacità di taglio

Lamiere ferrose	1,8 mm
Lamiere acciaio inox	1,2 mm
Lamiere di rame e alluminio	2,0 mm
Materiali plastici	2,0 mm
Velocità di rotazione	1500 - 3000 rpm
Collare	Ø 43,2 mm
Cassetina di metallo	

0655/L
€ 9,90
CESOIA SINISTRA PER LAMIERA

Con lame microdentate indurite e manici anatomici.



Blister

Cr-V

Cromata

Lunghezza	245 mm
Durezza	50 - 52 HRC

0655/S
€ 9,90
CESOIA DRITTA PER LAMIERA

Con lame microdentate indurite e manici anatomici.



Blister

Cr-V

Cromata

Lunghezza	245 mm
Durezza	50 - 52 HRC

0655/R
€ 9,90
CESOIA DESTRA PER LAMIERA

Con lame microdentate indurite e manici anatomici.



Blister

Cr-V

Cromata

Lunghezza	245 mm
Durezza	50 - 52 HRC

0818/250
€ 11,00
FORBICE LAMIERA TIPO AMERICANO

Blister



Acciaio



Satinata

Lunghezza	265 mm
-----------	--------

0699/240
€ 6,50
FORBICE INOX

Con manico in nylon.



Blister

INOX

Satinata

Lunghezza	240 mm
-----------	--------

0672
€ 7,90
FORBICE PER ELETTRICISTA

Con lama a rasoio microdentata, manico ergonomico in abs.



Blister

INOX

Satinata

Lunghezza	140 mm
-----------	--------

**0672/B**

€ 10,70

FORBICE PER ELETTRICISTA

Con lama a rasoio microdentata, manico ergonomico bicolore antiscivolo.



Blister

INOX

Satinata

Lunghezza

140 mm

F018

€ 27,10

FORBICE PER ELETTRICISTA CON MANICI ISOLATI

1000V IEC 60900, con lama a rasoio microdentata, manico ergonomico in ABS.



Blister

INOX

Satinata

Lunghezza

6" - 160 mm

0325

€ 13,90

FORBICE MULTIUSO

Con lama a rasoio microdentata, manico ergonomico antiscivolo bicolore.



Blister

INOX

Satinata

Lunghezza

210 mm / 8" mm

0081

€ 32,90

SERIE FUSTELLE

9 Pcs



Valigetta



Acciaio



Satinata

Misure

ø 5 - 6 - 8 - 10 - 12,5 - 16 - 20 - 25 - 32 mm

0141

€ 11,70

FORBICE PER ELETTRICISTA

Blister

INOX

Satinata

Lunghezza

5" 1/2 - 140 mm

0673

€ 10,70

FORBICE MULTIUSO

Con lama a rasoio microdentata, manico ergonomico antiscivolo bicolore in plastica e gomma.



Blister

INOX

Satinata

Lunghezza

175 mm / 7" mm

0424

€ 12,80

FUSTELLATRICE RINFORZATA

Permette di eseguire piccoli fori su materiali di piccolo spessore come: carta, cartone, gomma e cuoio.



Blister



Acciaio

Lunghezza

250 mm

0093/22

€ 5,90

TAGLIATUBO PER RAME/PLASTICA

Con corpo in lega di zinco.



Blister



Acciaio



Temprato

Capacità di taglio

3÷22 mm, 1 / 8" ÷ 55 / 64"

0093/42 € 23,30
TAGLIATUBO PER RAME/FERRO

Con corpo in lega di alluminio.

Capacità di taglio 6÷42 mm , 15 / 64" ÷ 1-21 / 32"
Durezza HRC 58-60

0472 € 18,70
BORDATUBO PER RAME E ALLUMINIO

Tubo tondo 5 - 6 - 8 - 10 - 12 - 14 - 16 mm

0253 € 10,10
TAGLIATUBO PER POLIURETANO E GOMMA

Adatto per tagliare tubi in pe, pu e gomma. Manico bi-componente.

Apertura max 19 mm
Lunghezza 133 mm

0846/150 € 122,00
TAGLIACAVI MANUALE A CRICCHETTO

Per cavi elettrici.

Capacità di taglio 150 mm² (Al - Cu)
Lunghezza 250 mm

0092 € 6,50
TAGLIATUBO PER TUBI RAME

Capacità 3 ÷ 28 mm - 1/8" ÷ 1 1/8"

0844 € 10,70
TAGLIATUBO PER POLIURETANO E GOMMA

Taglio massimo Ø 25 mm

0287- € 10,10
TAGLIA BULLONI

Ideale per tranciare tondini di ferro, catene e una vasta tipologia di materiali ferrosi e non ferrosi.

Cr-V

Art.	€	Dimensioni
0287/300	€ 16,90	300 mm - 12"
0287/350	€ 19,30	350 mm - 14"
0287/450	€ 24,70	450 mm - 18"
0287/600	€ 31,20	600 mm - 24"
0287/750	€ 40,40	750 mm - 30"



0862

€ 7,20

SPELLAFILO AUTOMATICO REGOLABILE



Blister



Acciaio

Taglio massimo

Ø 0,8 ÷ 3,5 mm 0,25 ÷ 6 mm²

0513

€ 11,90

SCURETTO CON MANICO IN FIBRA DI VETRO



Fibra di vetro

0101/500

€ 9,30

SCURETTO



Legno

0515

€ 27,10

SCURE CON MANICO IN FIBRA DI VETRO



Fibra di vetro

Lunghezza

900 mm

0322

€ 46,70

TAGLIARAMI TELESCOPICO A CRICCHETTO CON LAMA TEMPERATA E RIVESTITA IN TEFLON

Impugnatura antiscivolo ed ergonomica.



Append.



Acciaio



Temprato

Lunghezza

690 - 1030 mm



0587-
PUNTI METALLICI

Art.	€	Serie	Misura
0587/8006	€ 7,20	80	12,9 x 6h mm
0587/8008	€ 8,40	80	12,9 x 8h mm
0587/8010	€ 9,10	80	12,9 x 10h mm
0587/8012	€ 10,00	80	12,9 x 12h mm
0587/8014	€ 10,70	80	12,9 x 14h mm
0587/8016	€ 11,70	80	12,9 x 16h mm

0584-
CHIODI METALLICI

Art.	€	Serie	Misura
0584/F10	€ 7,20	TI-PIN	1 x 10h mm
0584/F15	€ 8,40	TI-PIN	1 x 15h mm
0584/F20	€ 10,70	TI-PIN	1 x 20h mm
0584/F25	€ 11,40	TI-PIN	1 x 25h mm
0584/F30	€ 12,80	TI-PIN	1 x 30h mm
0584/F35	€ 14,10	TI-PIN	1 x 35h mm
0584/F40	€ 15,90	TI-PIN	1 x 40h mm
0584/F45	€ 16,10	TI-PIN	1 x 45h mm
0584/F50	€ 16,40	TI-PIN	1 x 50h mm

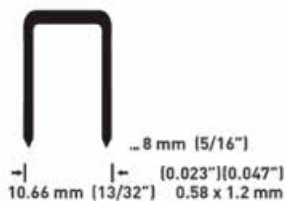
0151
GRAFFE
€ 3,14

Sezione 0,58 x 1,2 mm
0295
ASSORTIMENTO RIVETTI
€ 11,30

25 Pz 2.4x6.4 mm; 25 Pz 2.4x8 mm; 25 Pz 3.2x5 mm; 25 Pz 3.2x6.4 mm; 25 Pz 3.2x8 mm; 25 Pz 4x6.4 mm; 25 Pz 4x8 mm; 25 Pz 4.8x6.4 mm; 25 Pz 4.8x8 mm;

0585-
PUNTI METALLICI

Art.	€	Serie	Misura
0585/9013	€ 7,40	90	5,7 x 13h mm
0585/9019	€ 10,40	90	5,7 x 19h mm
0585/9032	€ 13,10	90	5,7 x 32h mm
0585/9040	€ 14,10	90	5,7 x 40h mm

0588-
SPILLI

Art.	€	Serie	Misura
0588/615	€ 7,90	0,60	0,63 x 15h mm
0588/620	€ 9,80	0,60	0,63 x 20h mm
0588/625	€ 11,40	0,60	0,63 x 25h mm

0376/AC
RIVETTI FILETTATI IN ACCIAIO
€ 10,40

Al carbonio, tropicalizzati, M3: 40 Pz - M4: 40 Pz - M5: 30 Pz - M6: 20 Pz - M8: 10 Pz - M10: 5 Pz - M12: 5 Pz.

Rivetti filettati M3 - M4 - M5 - M6 - M8 - M10 - M12

**0376/AL**

€ 13,00

RIVETTI FILETTATI IN ALLUMINIO

M4: 50 Pz - M5: 35 Pz - M6: 15 Pz - M8: 10 Pz - M10: 10 Pz.



120 Pcs



Append.

Alu

Alluminio

Rivetti filettati

M4 - M5 - M6 - M8 - M10

0376/AI

€ 36,40

RIVETTI FILETTATI IN ACCIAIO INOX

M3: 40 Pz - M4: 40 Pz - M5: 30 Pz - M6: 20 Pz - M8: 10 Pz - M10: 5 Pz - M12: 5 Pz.



150 Pcs



Append.

INOX

Rivetti filettati

M3 - M4 - M5 - M6 - M8 - M10 - M12

0178

€ 11,00

ASSORTIMENTO RONDELLE50 Pz Grower #6; 50 Pz Grower #8;
50 Pz Grower #10; 40 Pz Grower 1/4";
30 Pz Grower 5/16"; 20 Pz Grower 3/8";
50 Pz Dent. est. #6; 50 Pz Dent. est. #8;
50 Pz Dent. est. #10; 40 Pz Dent. est. 1/4";
30 Pz Dent. est. 5/16"; 20 Pz Dent. est. 3/8";
50 Pz Dent. int. #6; 50 Pz Dent. int. #8;
50 Pz Dent. int. #10; 40 Pz Dent. int. 1/4";
30 Pz Dent. int. 5/16"; 20 Pz Dent. int. 3/8".

720 Pcs



Scatola

Alu

Alluminio

0294

€ 11,70

ASSORTIMENTO COPPIGLIE150 Pz 1/16" x 1"; 150 Pz 3/32" x 1"; 100 Pz
3/32" x 1 - 1/2"; 1/8" x 1-1/4"; 50 Pz 1/8" x 2";
Pz 5/32" x 2-1/2".

555 Pcs



Scatola



Acciaio

0229

€ 16,40

ASSORTIMENTO RONDELLE IN RAME30 Pz M6; 25 Pz M8; 20 Pz M10; 15 Pz M12; 10
Pz M14; 10 Pz M16.

110 Pcs



Scatola

0298

€ 10,70

ASSORTIMENTO COPPIGLIE DI SICUREZZA42 Pz 3/32"x1-3/16"; 30 Pz 5/64"x1-5/16"; 25
Pz 5/64"x1-9/16"; 25 Pz 7/64"x1-5/18"; 20 Pz
9/64"x1-3/4"; 8 Pz 5/32"x2-15/16".

150 Pcs



Scatola



Acciaio

0231

€ 11,80

ASSORTIMENTO SPINE ELASTICHE4 Pz 4x16 mm; 4 Pz 4x26 mm; 4 Pz 4x40 mm;
4 Pz 6x16 mm; 4 Pz 6x32 mm; 4 Pz 6x45 mm;
4 Pz 8x20 mm; 4 Pz 8x40 mm; 4 Pz 8x50 mm;
4 Pz 2x6 mm; 4 Pz 2x14 mm; 4 Pz 2x26 mm; 4
Pz 1.5x5 mm; 4 Pz 1.5x20 mm; 4 Pz 1.5x8 mm;
4 Pz 2.5x16 mm; 4 Pz 2.5x24 mm; 4 Pz 2.5x32
mm; 5 Pz 3x16 mm; 5 Pz 3x26 mm; 5 Pz 3x32
mm; 2 Pz 10x20 mm; 2 Pz 10x40 mm; 2 Pz
10x50 mm; 4 Pz 5.5x32 mm; 4 Pz 5.5x45 mm;
4 Pz 5.5x16 mm; 5 Pz 5x16 mm; 5 Pz 5x26 mm;
5 Pz 5x32 mm.

120 Pcs



Scatola



Acciaio

0296

€ 11,70

ASSORTIMENTO ANELLI ELASTICI PER ESTERNI30 Pz 1/16"; 30 Pz 1/8"; 40 Pz 3/16"; 50 Pz 1/4";
50 Pz 3/8"; 40 Pz 1/2"; 20 Pz 5/8"; 20 Pz 3/4";
20 Pz 7/8";

300 Pcs



Scatola



Acciaio

0179
€ 10,70
ASSORTIMENTO ANELLI ELASTICI

3 Pz \varnothing 32; 5 Pz \varnothing 25; 5 Pz \varnothing 22; 10 Pz \varnothing 16; 10 Pz \varnothing 14; 10 Pz \varnothing 10; 5 Pz R14; 10 Pz R12; 10 Pz R10; 10 Pz \varnothing 9; 10 Pz \varnothing 8; 12 Pz \varnothing 6.

0257
€ 14,10
ASSORTIMENTO CHIAVETTE PARALLELE

5 Pz 6x6x20 mm; 4 Pz 3x3x20 mm; 4 Pz 3x3x25 mm; 5 Pz 8x5x32 mm; 5 Pz 5x5x20 mm; 5 Pz 8x7x36 mm; 5 Pz 5x5x25 mm; 5 Pz 10x8x40 mm; 5 Pz 5x5x36 mm; 5 Pz 10x8x50 mm; 5 Pz 6x6x36 mm; 2 Pz 12x8x40 mm; 5 Pz 6x6x50 mm.

0116P
€ 14,50
ASSORTIMENTO SFERE D'ACCIAIO CROMATE IN POLLICI

Grado DIN 5401, classe III 50 Pz 3/32"; 50 Pz 1/8"; 50 Pz 5/32"; 50 Pz 3/16"; 50 Pz 7/32"; 50 Pz 1/4"; 30 Pz 9/32"; 30 Pz 5/16"; 30 Pz 11/32"; 20 Pz 3/8"; 20 Pz 13/32".

0299
€ 22,20
ASSORTIMENTO OR METRICI

419 pezzi in 32 misure diverse realizzati in gomma nitrilica NBR di alta qualità, resistente al calore, resistente all'olio, resistente ai gas.

P. 478
0263
€ 14,10
ASSORTIMENTO CHIAVETTE A DISCO

10 Pz 4x7.5x19 mm; 10 Pz 5x7.5x19 mm; 10 Pz 3x5x13 mm; 10 Pz 3x6.5x16 mm; 10 Pz 4x5x13 mm; 10 Pz 4x6.5x16 mm; 10 Pz 5x9x22 mm; 10 Pz 6x9x22 mm.

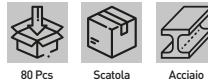
0116
€ 11,70
ASSORTIMENTO SFERE D'ACCIAIO CROMATE METRICHE

Grado DIN 5401, classe III 50 Pz 2.00 mm; 50 Pz 2.50 mm; 50 Pz 3.00 mm; 50 Pz 3.50 mm; 50 Pz 4.00 mm; 50 Pz 4.50 mm; 50 Pz 5.00 mm; 30 Pz 5.50 mm; 30 Pz 6.00 mm; 20 Pz 7.00 mm; 20 Pz 8.00 mm.

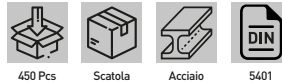
0180
€ 11,70
ASSORTIMENTO MOLLE

8 a Compress. 12 a Traz. 10Pz Comp.9/32"x 1/2"; 10Pz Ext.13/64"x 13/16"; 10Pz Comp.3/8"x 5/8"; 10Pz Ext.5/16"x 1-1/8"; 10Pz Comp.1/4"x 13/32"; 1Pz Ext.7/32"x 1"; 10Pz Comp.3/8"x 3/4"; 10Pz Comp.7/32"x 11/16"; 10Pz Ext.1/4"x 7/8"; 10Pz Ext.5/16"x 1-1/4"; 10Pz Ext.11/32"x 1-27/32"; 10Pz Ext.5/16"x 1-3/4"; 10Pz Ext.9/32"x 2"; 10Pz Ext.5/32"x 3-1/8"; 10Pz Comp.23/64"x 1-3/8"; 10Pz Ext.3/16"x 1-3/4"; 10Pz Comp.7/32"x 1-1/2"; 10Pz Ext.9/32"x 1-1/2"; 10Pz Comp.9/32"x 3/4"; 10Pz Ext.11/32"x 1-7/16".

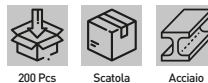
0299/P
€ 22,20
ASSORTIMENTO OR IN POLLICI

Assortimento realizzato in gomma nitrilica NBR di alta qualità, resistente al calore, resistente all'olio, resistente ai gas.



**0177**

€ 11,30

ASSORTIMENTO OR

10 Pz 3/32" x 15/64"; 20 Pz 1/8" x 1/4"; 20 Pz 5/32" x 9/32"; 20 Pz 3/16" x 5/16"; 15 Pz 7/32" x 11/32"; 15 Pz 1/4" x 3/8"; 10 Pz 9/16" x 3/4"; 10 Pz 5/8" x 13/16"; 10 Pz 11/16" x 7/8"; 10 Pz 3/4" x 15/16"; 10 Pz 3/4" x 1"; 10 Pz 13/16" x 11/16"; 15 Pz 5/16" x 7/16"; 10 Pz 3/8" x 1/2"; 10 Pz 5/8" x 3/4"; 10 Pz 3/8" x 9/16"; 10 Pz 7/16" x 5/8"; 10 Pz 1/2" x 11/16".



225 Pcs

Scatola



€ 9,30

0261

€ 9,80

SERIE FASCETTE

2 Pz 12.8x0.9x50-70 mm; 4 Pz 12.8x0.9x35-50 mm; 8 Pz 12.8x0.9x25-40 mm; 6 Pz 10x0.8x12-22 mm.



20 Pcs

Scatola

Acciaio

Dimensioni 10 x 0,8 x 12-22 mm; 12,8 x 0,9 x 25-40 mm; 12,8 x 0,9 x 35-50 mm; 12,8 x 0,9 x 50-70 mm

**0876**

€ 12,80

ASSORTIMENTO FASCETTE

650 Pcs

Scatola

300 Pz	2,5 x 100 mm
200 Pz	3,6 x 150 mm
150 Pz	4,8 x 200 mm

**0398**

€ 10,00

ASSORTIMENTO PIASTRINE A U CON VITI

Viti: 3x8 mm 40Pz 4x16 mm 20Pz 5x12 mm
15Pz 6x20 mm 10Pz Piastrine a U: 3 mm 20Pz
4 mm con tacca 20Pz 4 mm 20Pz 5 mm 15Pz
6 mm 10Pz.



170 Pcs

Scatola

Acciaio

**0465**

€ 9,30

ASSORTIMENTO PASSACAVI IN GOMMA

Misure passacavi: 5 Pz - D 21 mm - ID 15 mm - OD 26 mm - T 2,2 mm 40 Pz - D 9 mm - ID 6 mm - OD 13 mm - T 2,1 mm 5 Pz - D 15 mm - ID 12 mm - OD 19 mm - T 1,9 mm 40 Pz - D 5,8 mm - ID 2,5 mm - OD 7,9 mm - T 1,8 mm 40 Pz - D 7,5 mm - ID 4,8 mm - OD 9,8 mm - T 1,8 mm 20 Pz - D 12 mm - ID 10,5 mm - OD 15 mm - T 1,8 mm 25 Pz - D 11 mm - ID 8,5 mm - OD 14,5 mm - T 1,5 mm 5 Pz - D 25 mm - ID 18 mm - OD 32 mm - T 1,5 mm.



180 Pcs

Scatola

**0468**

€ 10,40

ASSORTIMENTO STAFFE PIATTE E AD ANGOLO CON VITI

4 Pz staffe ad angolo: 25x25x16x2,0 mm 8 Pz staffe ad angolo: 40x40x16x2,0 mm 4 Pz staffe ad angolo: 60x60x16x2,0 mm 4 Pz staffe ad angolo: 75x75x16x2,0 mm 4 Pz staffe piatte a L: 40x40x12x2,0 mm 4 Pz staffe piatte a L: 60x60x12x2,0 mm 4 Pz staffe piatte: 80x15x2,0 mm 4 Pz staffe piatte: 40x15x2,0 mm 144 Pz viti: 3x16 mm.



180 Pcs

Scatola

Acciaio

**0307/1**

€ 20,80

ASSORTIMENTO FUSIBILI IN VETRO

Rapidi: 10 x 1A F1, 10 x 1.25A F1, 10 x 1.6A F1, 10 x 2A F1, 10 x 2.5A F1, 10 x 4A F1, 10 x 5A F1, 10 x 6.3A F1, 10 x 10A F1, ritardati: 10 x 1A F1 T, 10 x 1.25A F1 T, 10 x 1.6A F1 T, 10 x 2A F1 T, 10 x 2.5A F1 T, 10 x 4A F1 T, 10 x 5A F1 T, 10 x 6.3A F1 T, 10 x 10A F1 T.



180 Pcs

Append.

Dimensioni 5 x 20 mm

**0307/2**

€ 23,40

ASSORTIMENTO FUSIBILI IN VETRO

Ritardati: 10 Pz 100mA T, 10 Pz 160mA T, 10 Pz 200mA T, 10 Pz 250mA T, 10 Pz 315mA T, 10 Pz 400mA T, 10 Pz 500mA T, 10 Pz 630mA T, 10 Pz 800mA T, rapidi: 10 Pz 100mA F, 10 Pz 160mA F, 10 Pz 200mA F, 10 Pz 250mA F, 10 Pz 315mA F, 10 Pz 400mA F, 10 Pz 500mA F, 10 Pz 630mA F, 10 Pz 800mA F.



180 Pcs

Append.

Dimensioni 5 x 20 mm



0317
€ 12,50
ASSORTIMENTO FUSIBILI AUTO

3A 15 Pz, 5A 15 Pz, 7.5A 15 Pz, 10A 15 Pz, 15A 15 Pz, 20A 15 Pz, 25A 15 Pz, 30A 15 Pz, Fuse puller 1 Pz.

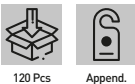
Dimensioni 19.1 x 5.1 x 18.5 mm

0318
€ 13,40
ASSORTIMENTO FUSIBILI AUTO

2 AMP x 10 pz; 3 AMP x 10 pz; 4 AMP x 10 pz; 5 AMP x 10 pz; 7.5 AMP x 20 pz; 10 AMP x 10 pz; 15 AMP x 20 pz; 20 AMP x 20 pz; 25 AMP x 20 pz; 30 AMP x 10 pz; Fuse Puller x 1

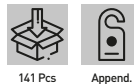
Dimensioni 10.9 x 3.6 x 16.3 mm

0293
€ 15,20
ASSORTIMENTO CAPICORDA

15 Pz FDD1-110 2.8x0.5/0.8 mm; 15 Pz FDD1-187 4.75x0.5/0.8 mm; 10 Pz FDD2-187 6.35x0.5/0.8 mm; 15 Pz FDD1-250 4.75x0.5/0.8 mm; 10 Pz FDD2-250 6.35x0.8 mm; 10 Pz FDD5-250 6.35x0.8 mm; 10 Pz BV1; 10 Pz BV2; 10 Pz BV5; 10 Pz MDD1-250; 10 Pz MDD2-250; 10 Pz MDD5-250; 10 Pz SVL1.25-3.7; 10 Pz SVL1.25-4; 10 Pz SVL1.25-5.3; 10 Pz SVM2-4; 10 Pz SVS2-5; 10 Pz SVL5-4; 10 Pz SVL5.5-4.

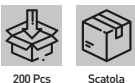

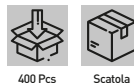
0877
€ 11,90
ASSORTIMENTO TERMINALI

 50 Pz 0.5 mm²; 100 Pz 0.75 mm²; 100 Pz 1.0 mm²; 100 Pz 1.5 mm²; 50 Pz 2.5 mm²;

Terminale Bianco	50 x 0,5 mm ²
Terminale Grigio	100 x 0,75 mm ²
Terminale Rosso	100 x 1 mm ²
Terminale Nero	100 x 1,5 mm ²
Terminale Blu	50 x 2,5 mm ²

0380
€ 10,70
ASSORTIMENTO GUAINE TERMORESTRINGENTI

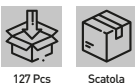
30 Pz 5/64"x1-9/16"; 25 Pz 3/32"x1-9/16"; 20 Pz 1/8"x1-9/16"; 30 Pz 3/16"x1-9/16"; 16 Pz 9/32"x3-1/8"; 8 Pz 3/8"x3-1/8"; 8 Pz 1/2"x3-3/8".

0176
€ 33,40
ASSORTIMENTO INGRASSATORI

Pz. 35 dritti M6x1; Pz. 15 dritti 1/8"-27; Pz. 5 45° 1/8"-27; Pz. 5 45° M6x1; Pz. 10 45° M8x1; Pz. 5 45° M10x1; Pz. 10 dritti M10x1; Pz. 10 dritti M8x1; Pz. 5 90° M6x1; Pz. 5 90° M8x1; Pz. 5 90° M10x1.

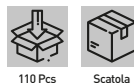
SR44W
€ 5,80
BATTERIE PER STRUMENTI DIGITALI

Vtaggio 1,5 V
Pack 10

CR20X
BATTERIE PER STRUMENTI DIGITALI

Art.	€	Vtaggio	Pack
CR2025	€ 8,00	3 V	10
CR2032	€ 8,00	3 V	10





0678

€ 21,10

PISTOLA PER SCHIUMA POLIURETANICA

Regolazione del flusso resina e della ghiera filettata di montaggio bombola.



Scatola

Lunghezza 290 mm

0085

€ 12,90

PISTOLA SILICONE SUPER RINFORZATA



Nichelata



0521

€ 10,40

PISTOLA SILICONE SUPER RINFORZATA



Nichelata



0234

€ 4,51

PISTOLA SILICONE A DOPPIO STELO RINFORZATA, ASTA ESAGONALE



Acciaio



0091

€ 3,94

PISTOLA SILICONE A CREMAGLIERA



0604

€ 21,10

PISTOLA PER TASSELLI CHIMICI DA 345 ML E 235 ML



Nichelata



0861 € 21,10

PISTOLA PER TASSELLI CHIMICI DA 380ML



Nichelata

0820-

CAZZUOLA PUNTA QUADRA



Acciaio



Art.	€	Lunghezza
0820/18	€ 5,10	180 mm
0820/20	€ 5,30	200 mm

0822 € 5,70

FRATTORE PER STUCCATORI CON MANICO IN ABS



Acciaio



Lunghezza	280 x 120 mm
-----------	--------------

0184-

SPATOLA CON MANICO IN PLASTICA LUCIDATA A SPECCHIO



INOX

Art.	€	Dimensioni lama
0184/01	€ 1,56	30 x 90h mm
0184/02	€ 1,56	50 x 95h mm
0184/03	€ 2,03	75 x 100h mm
0184/04	€ 3,11	100 x 100h mm

0819-

CAZZUOLA PUNTA TONDA



Acciaio



Art.	€	Lunghezza
0819/18	€ 5,10	180 mm
0819/20	€ 5,30	200 mm

0821/14 € 3,94

CAZZUOLINO PUNTA TONDA



Acciaio



Lunghezza	140 mm
-----------	--------

0823 € 5,70

FRATTORE PER COLLA CON MANICO IN ABS



Acciaio



Lunghezza	280 x 120 mm
-----------	--------------

0606 € 4,82

SECCHIO IN POLIETILENE



Dimensioni	ø 360 x 240h mm
Capacità	14 l

**0043**

€ 6,00

NASTRO SEGNALETICO ROSSO E BIANCO

Lunghezza	200 m
Altezza	70 mm

0747

€ 2,65

NASTRO PER IMBALLAGGIO IN PPL COLOR AVANA

Dimensioni nastro	50 mm x 66 m
Pack	6

PVC300/125

€ 5,50

FILM ESTENSIBILE PER IMBALLAGGIO

Dimensioni	0,125h x 100 m
Spessore	20 µm
Pack	48

PVC300

€ 20,60

FILM ESTENSIBILE PER IMBALLAGGIO

Dimensioni	0,5h x 300 m
Spessore	23 µm
Pack	6

0103

€ 9,10

DISPENSER PER NASTRI DA IMBALLAGGIO

Scatola

0760

€ 9,10

MANIGLIA PER FILM ESTENSIBILE**0748**

€ 10,80

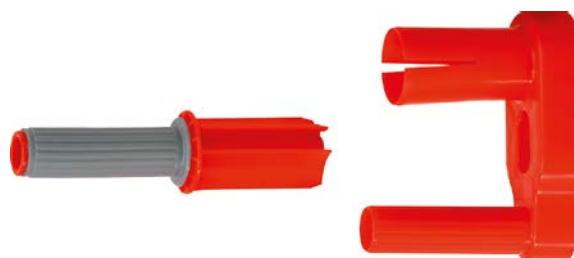
MANIGLIA PER FILM ESTENSIBILE**028X****TELO IN POLIETILENE PESANTE ANELLATO BORDATO, BICOLORE GRIGIO - BLU**

Stabilizzato ai raggi uv, telone tessuto in polietilene, 140/150 g/m2, occhielli metallici ogni 50cm.



Art.	€	Dimensioni	Peso netto
0281	€ 12,40	2,86 x 1,90 m	0,9 kg
0282	€ 35,80	4 x 5 m	2,8 kg
0283	€ 71,50	5 x 8 m	5,6 kg
0284	€ 93,20	6 x 10 m	8 kg

C980/CC01

€ 1690,00

CARRELLO COMPLETO DI UTENSILI

72 Pcs

Termoformati inclusi	TM01/002, TM01/005, TM01/008, TM01/009, TM01/020, TM01/029, TM01/042
Dimensioni cassetteria	890 x 530 x 1030h mm
Portata cassetto	25 kg
Dimensioni cassetto	565 x 405 mm
Altezza cassette	3 x 50 mm - 3 x 105 mm - 1 x 165 mm

C960/AM01

€ 1190,00

CARRELLO COMPLETO DI UTENSILI PER AUTOMOTIVE



142 Pcs

Termoformati inclusi	TM01/047, TM01/048, TM01/049
Dimensioni	770 x 460 x 985h mm
Dimensioni cassetto	566 x 405 mm
Altezza cassette	6 x 68 mm - 1 x 199 mm
Portata cassetto	6 x 25 kg - 1 x 40 kg



C960/CC01

€ 1190,00

CARRELLO COMPLETO DI UTENSILI



159 Pcs

Termoformati inclusi

TM01/002, TM01/010, TM01/012, TM01/014,
TM01/016, TM01/018, TM01/023, TM01/025,
TM01/030, TM01/033, TM01/042

Dimensioni

770 x 460 x 985h mm

Dimensioni cassetto

566 x 405 mm

Altezza cassettei

6 x 68 mm - 1 x 199 mm

Portata cassetto

6 x 25 kg - 1 x 40 kg

UPGRADE



C960/CC03

€ 1080,00 **NEW**

CARRELLO COMPLETO DI UTENSILI

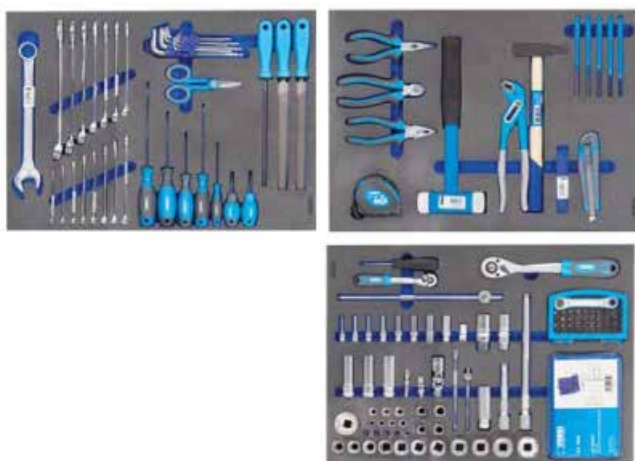

253 Pcs

Termoformati inclusi

TM01/068, TM01/069, TM01/070

Dimensioni

770 x 460 x 985h mm

Dimensioni cassetto

566 x 405 mm

Altezza cassettei

6 x 68 mm - 1 x 199 mm

Portata cassetto

6 x 25 kg - 1 x 40 kg



C960/CC04

 € 1340,00 **NEW**
CARRELLO COMPLETO DI UTENSILI

219 Pcs

Termoformati inclusi	TM01/058, TM01/063, TM01/064, TM01/061
Dimensioni	770 x 460 x 985h mm
Dimensioni cassetto	566 x 405 mm
Altezza cassettei	6 x 68 mm - 1 x 199 mm
Portata cassetto	6 x 25 kg - 1 x 40 kg

C960CA

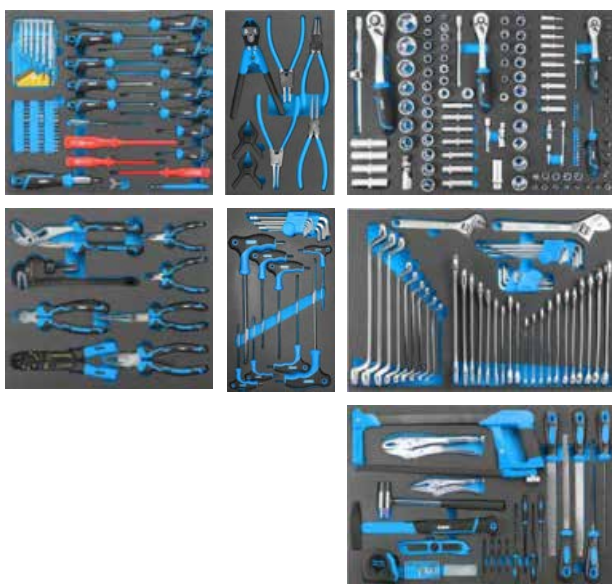
 € 854,00 **NEW**
CARRELLO COMPLETO DI UTENSILI

290 Pcs

Termoformati inclusi	C960/1A, C960/2A, C960/3A, C960/4A, C960/5A, C960/7A, C960/8A
Dimensioni	770 x 460 x 985h mm
Dimensioni cassetto	566 x 405 mm
Altezza cassettei	6 x 68 mm - 1 x 199 mm
Portata cassetto	6 x 25 kg - 1 x 40 kg



C960C3C

€ 663,00 **NEW**

CARRELLO COMPLETO DI UTENSILI

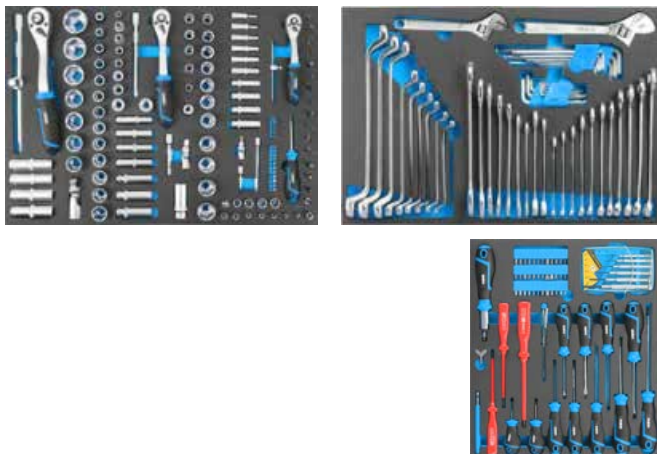

235 Pcs

Termoformati inclusi	C960/1A, C960/3A, C960/4A
Dimensioni	770 x 460 x 985h mm
Dimensioni cassetto	566 x 405 mm
Altezza cassette	6 x 68 mm - 1 x 199 mm
Portata cassetto	6 x 25 kg - 1 x 40 kg

C900/CC01

€ 720,00

CARRELLO COMPLETO DI UTENSILI



UPGRADE



113 Pcs

Termoformati inclusi	TM01/001, TM01/012, TM01/014, TM01/020, TM01/022, TM01/024, TM01/042
Dimensioni cassetteria	744 x 461 x 964h mm
Dimensioni cassetto	569 x 406 mm
Altezza cassette	4 x 45 mm - 1 x 145 mm - 1 x 225 mm
Portata cassetto	25 kg

C900/CC03

 € 882,00 **NEW**
CARRELLO COMPLETO DI UTENSILI

253 Pcs

Termoformati inclusi	TM01/068, TM01/069, TM01/070
Dimensioni	744 x 461 x 964h mm
Dimensioni cassetto	569 x 406 mm
Altezza cassette	4 x 45 mm - 1 x 145 mm - 1 x 225 mm
Portata cassetto	25 kg

C900/CC04

 € 1160,00 **NEW**
CARRELLO COMPLETO DI UTENSILI

219 Pcs

Termoformati inclusi	TM01/058, TM01/063, TM01/064, TM01/061
Dimensioni	744 x 461 x 964h mm
Dimensioni cassetto	569 x 406 mm
Altezza cassette	4 x 45 mm - 1 x 145 mm - 1 x 225 mm
Portata cassetto	25 kg



C900CA

€ 999,00 **NEW**

CARRELLO COMPLETO DI UTENSILI

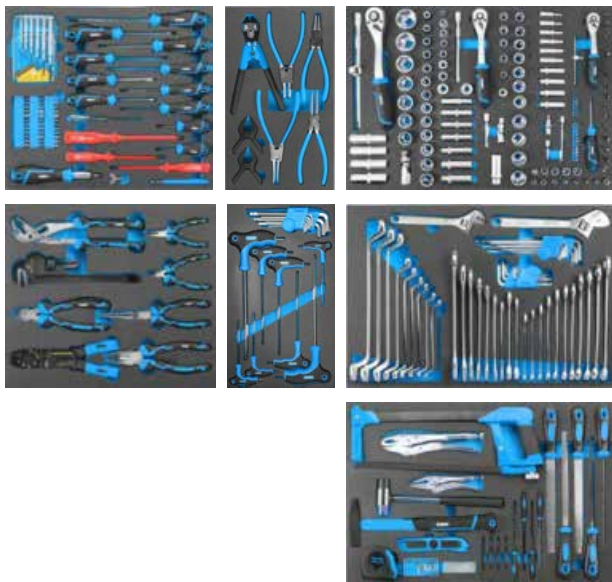

290 Pcs

Termoformati inclusi	C960/1A, C960/2A, C960/3A, C960/4A, C960/5A, C960/7A, C960/8A
Dimensioni	744 x 461 x 964h mm
Dimensioni cassetto	569 x 406 mm
Altezza cassette	4 x 70 mm - 1 x 145 mm - 1 x 225 mm
Portata cassetto	25 kg



C900C3C

€ 799,00 **NEW**

CARRELLO COMPLETO DI UTENSILI

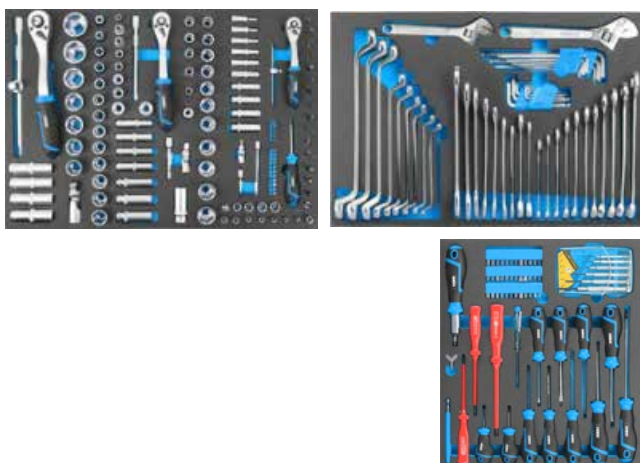

235 Pcs

Termoformati inclusi	C960/1A, C960/3A, C960/4A
Dimensioni	744 x 461 x 964h mm
Dimensioni cassetto	569 x 406 mm
Altezza cassette	4 x 70 mm - 1 x 145 mm - 1 x 225 mm
Portata cassetto	25 kg



C960/1A € 163,00 NEW

UTENSILI IN VASSOIO TERMOFORMATO PER CASSETTIERE

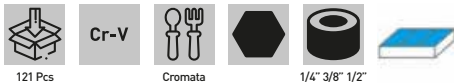
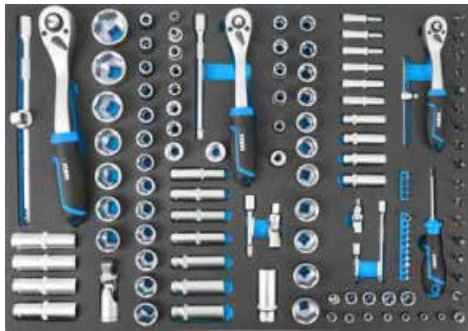

Bussole con inserti	1/4" - H3-H4-H5-H6; PH1-PH2-PH3; SL4-5.5-6.5; T8-T10-T15-T20-T30-T50
Leve a cricchetto	1/4", 3/8", 1/2"
Manico per bussole	1/4"
Adattatore	1/4", 1/2"
Snodi	1/4", 3/8", 1/2"
Leva a T scorrevole	1/4", 3/8", 1/2"
Prolunghe	1/4", 3/8", 1/2"
Bussole da 1/4"	Esagonali 4-4.5-5-5.5-6-7-8-9-10-11-12-13 mm
Bussole da 3/8"	Esagonali 8-9-10-11-12-13-14-15-16-17-18-19-20-21-22-24 mm Poligonali E8-E10-E11-E12-E14-E16-E18-E20
Bussole da 1/2"	Esagonali 8-9-10-11-12-13-14-15-16-17-18-19-20-21-22-23-24-27-30-32 mm
Bussole lunghe da 1/2"	Esagonali 14-15-17-19 mm
Bussole lunghe da 1/4"	Esagonali 4-5-6-7-8-9-10-11-12-13 mm
Inserti	SL3-4-5-6 mm; PZ0-PZ1-PZ2-PZ3; PH0-1-2-3

C960/2A € 72,00 NEW

UTENSILI IN VASSOIO TERMOFORMATO PER CASSETTIERE



Cutter	1 (+10 lame)
Bulini	1/32 - 2/32 - 3/32 - 4/32
Flessometro	5m/16ft
Lima	9 Pcs
Pinza grip	170 mm - 250 mm / 7" - 10"
Mazzuolo	1 Pc
Martello tedesco	1 Pc
Mini archetto con lama	1 Pc
Kit	Viti - Tasselli

C960/3A € 202,00 NEW

UTENSILI IN VASSOIO TERMOFORMATO PER CASSETTIERE



Chiavi fisse	6x7 - 8x9 - 10x11 - 12x13 - 14x15 - 16x17-18x19 - 20x22 - 21x23 - 24x27 mm
Chiavi poligonali	6x7 - 8x9 - 10x11 - 12x13 - 14x15 - 16x17 - 18x19 - 20x22 - 21x23 - 24x27 mm
Chiavi combinate	10-11-12-13-14-15-16-17-18-19-21-24 mm
Chiavi a cricchetto	13-14 mm
Chiavi esagonali	1.5 - 2 - 2.5 - 3 - 4 - 5 - 6 - 8 - 10 mm
Chiave inglese	8" - 10"

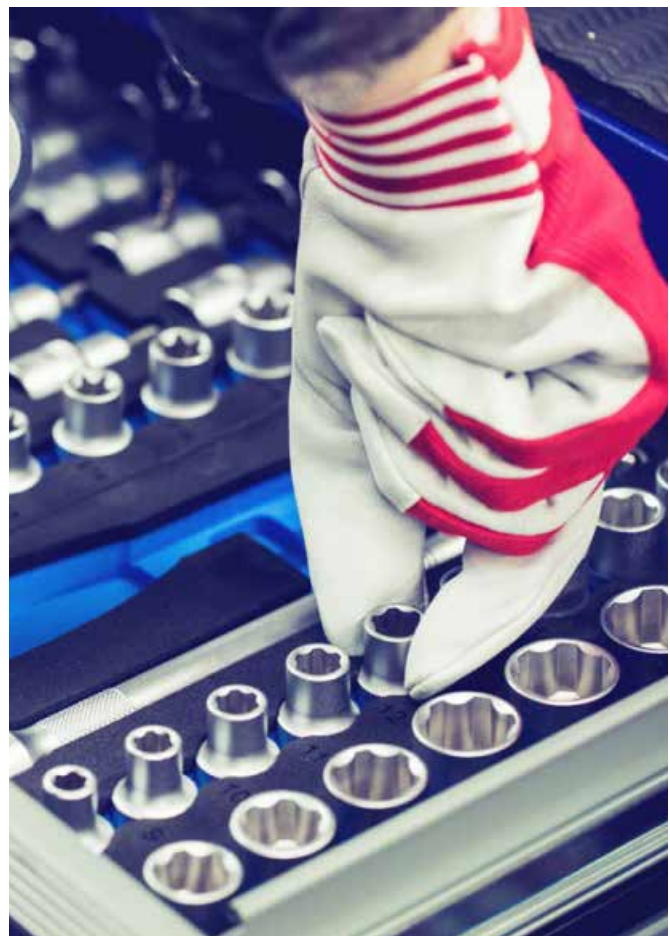



C960/4A € 47,00 **NEW**

UTENSILI IN VASSOIO TERMOFORMATO PER CASSETTIERE



Cr-V



60 Pcs

Giraviti	SL 3x75 - 5x75 - 6x38 - 3x100 PH 3x75 - 5x75 - 6x38 - 3x100 - 6x100 mm - 6x10 - 8x150 mm
Giraviti per elettricista	SL 4x100, SL 5.5x125, PH 4x10
Giravite di precisione	6 Pcs
Giravite cercafase	100-250V
Magnete	Telescopico
Accessori	Y bit

C960/5A € 57,00 **NEW**

UTENSILI IN VASSOIO TERMOFORMATO PER CASSETTIERE



Cr-V



8 Pcs

Cromata

Pinze a becchi mezzitondi	120 mm - 200 mm / 5" - 8"
Pinza fastonatrice	1 Pc
Tronchesi	115 mm - 200 mm / 4,5" - 8"
Pinza universale	1 Pc
Pinza idraulico	250 mm / 10"
Giratubi	250 mm / 10"

C960/7A € 28,00 **NEW**

UTENSILI IN VASSOIO TERMOFORMATO PER CASSETTIERE



Cr-V



17 Pcs

Cromata

Chiavi esagonali	T10-T15-T20-T25-T27-T30-T40-T45-T50
Chiavi a T	2x100, 2.5x100, 3x100, 4x150, 5x150, 6x150, 8x200, 10x200 mm

C960/8A € 39,00 **NEW**

UTENSILI IN VASSOIO TERMOFORMATO PER CASSETTIERE



Cr-V



7 Pcs

Cromata

Tronchesi	200 mm / 8"
Morsetti	90 mm / 3.5"
Pinze	Per anelli elastici

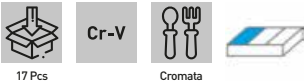
TM01/001
€ 60,80
SERIE DI CHIAVI COMBinate IN TERMOFORMATO MORBIDO

Dimensioni	188 x 405 x 33 mm
Misure	6 - 7 - 8 - 9 - 10 - 11 - 12 - 13 - 14 - 15 - 16 - 17 - 18 - 19 - 20 - 21 - 22 mm
Articoli inclusi	0224/..

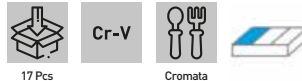
TM01/002
€ 125,00
SERIE DI CHIAVI COMBinate IN TERMOFORMATO MORBIDO

Dimensioni	188 x 405 x 33 mm
Misure	6 - 7 - 8 - 9 - 10 - 11 - 12 - 13 - 14 - 15 - 16 - 17 - 18 - 19 - 20 - 21 - 22 mm
Articoli inclusi	0208/..

TM01/005
€ 63,80
SERIE DI CHIAVI FISSE IN TERMOFORMATO MORBIDO

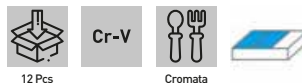

Dimensioni	376 x 405 x 33 mm
Misure	6x7 - 8x9 - 10x11 - 12x13 - 14x15 - 16x17 - 18x19 - 20x22 - 21x23 - 24x26 - 25x28 - 30x32 mm
Articoli inclusi	0222/..

TM01/006
€ 96,70
SERIE DI CHIAVI FISSE IN TERMOFORMATO MORBIDO

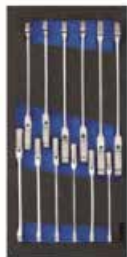
Dimensioni	376 x 405 x 33 mm
Misure	6x7 - 8x9 - 10x11 - 12x13 - 14x15 - 16x17 - 18x19 - 20x22 - 21x23 - 24x26 - 25x28 - 30x32 mm
Articoli inclusi	0201/..

TM01/056
€ 203,00
SERIE DI CHIAVI A CRICCHETTO COMBinate SNODATE IN TERMOFORMATO MORBIDO

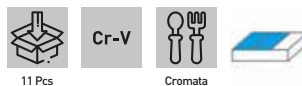
Dimensioni	188 x 405 x 33 mm
Misure	8 - 9 - 10 - 11 - 12 - 13 - 14 - 15 - 16 - 17 - 18 - 19 mm
Articoli inclusi	0690/..

TM01/008
€ 168,00
SERIE DI CHIAVI ESAGONALI MASCHIO A T IN TERMOFORMATO MORBIDO

Dimensioni	376 x 405 x 33 mm
Misure	2 - 3 - 4 - 5 - 6 - 7 - 8 - 9 - 10 - 12 - 14 mm
Articoli inclusi	0400/..

TM01/009
€ 173,00
SERIE DI CHIAVI TORX A T IN TERMOFORMATO MORBIDO

Dimensioni	188 x 405 x 33 mm
Misure	T6 - T7 - T8 - T9 - T10 - T15 - T20 - T25 - T27 - T30 - T40 - T45 - T50
Articoli inclusi	0405/..

TM01/010
€ 263,00
SERIE DI CHIAVI A T CON BUSSOLA ESAGONALE SNODATA IN TERMOFORMATO MORBIDO

Dimensioni	565 x 405 x 33 mm
Chiavi a T	7 - 8 - 10 - 12 - 13 - 14 - 17 - 19 mm
Chiavi esagonali	1,5 - 2 - 2,5 - 3 - 4 - 5 - 6 - 8 - 10 mm
Chiavi Torx	T10 - T15 - T20 - T25 - T27 - T30 - T40 - T45 - T50
Articoli inclusi	C395/.. - 0215 - 0220



TM01/011 € 290,00

SERIE DI CHIAVI A T CON BUSSOLA ESAGONALE SNODATA IN TERMOFORMATO MORBIDO

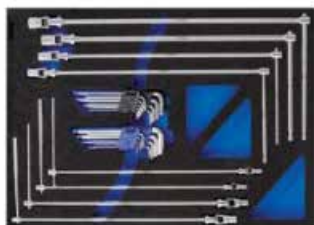

Dimensioni	565 x 405 x 33 mm
Chiavi a T	7 - 8 - 10 - 12 - 13 - 14 - 17 - 19 mm
Chiavi esagonali	1,5 - 2 - 2,5 - 3 - 4 - 5 - 6 - 8 - 10 mm
Chiavi Torx	T10 - T15 - T20 - T25 - T27 - T30 - T40 - T45 - T50
Articoli inclusi	C391/.. - 0215 - 0220

TM01/012 € 48,40

SERIE DI CHIAVI ESAGONALI CON MANICO ANATOMICO IN TERMOFORMATO MORBIDO

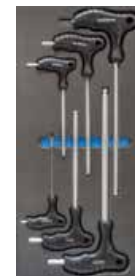

Dimensioni	188 x 405 x 33 mm
Misure	3 - 4 - 5 - 6 - 8 mm
Articoli inclusi	0856/..

TM01/014 € 48,40

SERIE DI CHIAVI TORX CON MANICO ANATOMICO IN TERMOFORMATO MORBIDO



Dimensioni	188 x 405 x 33 mm
Misure	T10 - T15 - T20 - T25 - T30 - T40
Articoli inclusi	0855/..

TM01/063 € 177,00 **NEW**

SERIE UTENSILI PER AUTOMOTIVE IN TERMOFORMATO MORBIDO

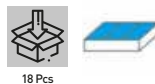

Dimensioni	565 x 405 x 33 mm
Articoli inclusi	D883/... - D884/..

TM01/068 € 89,00 **NEW**

SERIE UTENSILI PER AUTOMOTIVE IN TERMOFORMATO MORBIDO



Dimensioni	565 x 405 x 33 mm
Articoli inclusi	0215 - 0672 - 0224/...

TM01/016 € 42,20

SERIE DI GIRAVITI A TAGLIO IN TERMOFORMATO MORBIDO

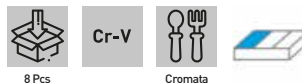

Dimensioni	188 x 405 x 33 mm
Giravite a taglio per meccanica	3 x 75 - 4 x 100 - 5 x 125 - 6 x 150 - 8 x 150 - 6 x 38 mm
Giravite a taglio elettricista	3 x 75 - 4 x 100 mm
Articoli inclusi	C883/.. - C884/..

TM01/018 € 48,40

SERIE DI GIRAVITI A CROCE IN TERMOFORMATO MORBIDO



Dimensioni	188 x 405 x 33 mm
Giravite a croce per meccanica	PH 1 x 75 - PH 2 x 100 - PH 3 x 150 - PH 2 x 38 mm
Giravite a croce per viti da legno	PZ 1 x 75 - PZ 2 x 100 - PZ 3 x 150 - PZ 2 x 38 mm
Articoli inclusi	C882/.. - C885/..

TM01/020 € 43,30

SERIE DI GIRAVITI MISTI IN TERMOFORMATO MORBIDO



Dimensioni	188 x 405 x 33 mm
Giravite a taglio per meccanica	3 x 75 - 4 x 100 - 5 x 125 - 6 x 150 - 6 x 38 mm
Giravite a croce per meccanica	PH 1 x 75 - PH 2 x 100 - PH 2 x 38 mm
Articoli inclusi	C882/.. - C884/..

TM01/044
€ 53,20
**SERIE DI GIRAVITI A TAGLIO
DIAMANTATI IN TERMOFORMATO
MORBIDO**

Dimensioni	188 x 405 x 33 mm
Giravite a taglio per meccanica	4 x 75 - 4 x 100 - 5 x 125 - 6 x 150 - 8 x 150 - 6 x 38 mm
Giravite a taglio elettricista	3 x 75 - 4 x 100 mm
Articoli inclusi	D883/.. - D884/..

TM01/046
€ 53,90
**SERIE DI GIRAVITI MISTI
DIAMANTATI IN TERMOFORMATO
MORBIDO**

Dimensioni	188 x 405 x 33 mm
Giravite a taglio per meccanica	3 x 75 - 4 x 100 - 5 x 125 - 6 x 150 - 6 x 38 mm
Giravite a croce per meccanica	PH 1 x 75 - PH 2 x 100 - PH 2 x 38 mm
Articoli inclusi	D882/.. - D884/..

TM01/070
€ 223,00 **NEW**
**SERIE UTENSILI PER AUTOMOTIVE IN TERMOFORMATO
MORBIDO**

Dimensioni	565 x 405 x 33 mm
Articoli inclusi	0173 - 0402 - BN4C3L...

TM01/023
€ 225,00
**SERIE DI BUSSOLE POLIGONALI IN
TERMOFORMATO MORBIDO**

Dimensioni	188 x 405 x 33 mm
Bussole	8 - 9 - 10 - 11 - 12 - 13 - 14 - 15 - 16 - 17 - 18 - 19 - 20 - 21 - 22 - 23 - 24 - 25 - 26 - 27 - 28 - 29 - 30 - 32 mm
Prolunghe	75 - 250 mm
Raccordo	Femmina 1/2", maschio 3/8"
Snodi a cardano	46 mm
Leva a T scorrevole	300 mm
Articoli inclusi	BN4P3N0.. - CN450N1/2A

TM01/045
€ 60,20
**SERIE DI GIRAVITI A CROCE DIAMANTATI
IN TERMOFORMATO MORBIDO**

Dimensioni	188 x 405 x 33 mm
Giravite a croce per meccanica	PH 1 x 75 - PH 2 x 100 - PH 3 x 150 - PH 2 x 38 mm
Giravite a croce per viti da legno	PZ 1 x 75 - PZ 2 x 100 - PZ 3 x 150 - PZ 2 x 38 mm
Articoli inclusi	D882/.. - D885/..

TM01/053
€ 271,00
**SERIE UTENSILI AGGIUNTIVI PER AUTOMOTIVE IN
TERMOFORMATO MORBIDO**

Dimensioni	565 x 405 x 33 mm
Articoli inclusi	L002/250 - 0136 - 0370/8 - 0368/10 - 0209

TM01/022
€ 230,00
**SERIE DI BUSSOLE ESAGONALI IN
TERMOFORMATO MORBIDO**

Dimensioni	188 x 405 x 33 mm
Bussole	8 - 9 - 10 - 11 - 12 - 13 - 14 - 15 - 16 - 17 - 18 - 19 - 20 - 21 - 22 - 23 - 24 - 25 - 26 - 27 - 28 - 29 - 30 - 32 mm
Prolunghe	75 - 250 mm
Raccordo	Femmina 1/2", maschio 3/8"
Snodi a cardano	46 mm
Leva a T scorrevole	300 mm
Articoli inclusi	BN4E3N0.. - CN450N1/2A

TM01/024
€ 233,00
**SERIE DI BUSSOLE ESAGONALI IN
TERMOFORMATO MORBIDO**

Dimensioni	188 x 405 x 33 mm
Bussole da 1/4"	4 - 5 - 6 - 7 - 8 - 9 - 10 - 11 - 12 - 13 - 14 mm
Bussole da 3/8"	7 - 8 - 9 - 10 - 11 - 12 - 13 - 14 - 15 - 16 - 17 - 18 - 19 - 20 - 21 - 22 mm
Articoli inclusi	BN4E5N0.. - BN4E4N0.. - CN450N1/4A - CN450N3/8A - JN40.. - LN400N.. - PN405N.. - PN404N.. - BN4C4L..



TM01/025 € 229,00

SERIE DI BUSSOLE POLIGONALI IN TERMOFORMATO MORBIDO



Dimensioni	188 x 405 x 33 mm
Bussole da 1/4"	4 - 5 - 6 - 7 - 8 - 9 - 10 - 11 - 12 - 13 - 14 mm
Bussole da 3/8"	7 - 8 - 9 - 10 - 11 - 12 - 13 - 14 - 15 - 16 - 17 - 18 - 19 - 20 - 21 - 22 mm
Articoli inclusi	BN4P5N0.. - BN4P4N0.. - CN450N1/4A - CN450N3/8A - JN40.. - LN400N.. - PN405N.. - PN404N.. - BN4C4L..

TM01/026 € 46,30

SERIE DI GIRAVITI ISOLATI IN TERMOFORMATO MORBIDO



Dimensioni	188 x 405 x 33 mm
Giravite a taglio isolato	3 x 100 - 4 x 100 - 5,5 x 125 - 6,5 x 150 mm
Giravite a croce isolato	PH 0 x 60 - PH 1 x 80 - PH 2 x 100 mm
Articoli inclusi	C182/.. - C183/.. - 0013/142

TM01/027 € 61,70

SERIE DI CHIAVI A BUSSELLA CON IMPUGNATURA IN TERMOFORMATO MORBIDO

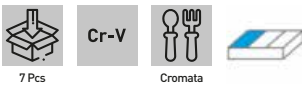

Dimensioni	188 x 405 x 33 mm
Misure	5,5 - 6 - 7 - 8 - 10 - 12 - 13 mm
Articoli inclusi	CB01/..

TM01/028 € 74,10

SERIE DI CHIAVI A BUSSELLA CON IMPUGNATURA IN TERMOFORMATO MORBIDO

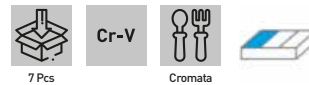

Dimensioni	188 x 405 x 33 mm
Misure	5,5 - 6 - 7 - 8 - 10 - 12 - 13 mm
Articoli inclusi	CB02/..

TM01/029 € 71,00

SERIE DI CHIAVI A BUSSELLA FLESSIBILI CON IMPUGNATURA IN TERMOFORMATO MORBIDO

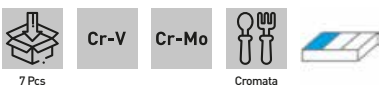

Dimensioni	188 x 405 x 33 mm
Misure	5,5 - 6 - 7 - 8 - 10 - 12 - 13 mm
Articoli inclusi	CBF1/..
Dimensioni	188 x 405 x 33 mm
Misure	Ø2x140 - Ø3x150 - Ø4x180 - Ø5x220 - Ø6x210 - Ø7x210 - Ø8x220 mm
Articoli inclusi	C015/..

TM01/030 € 45,40

SERIE DI CHIAVI POLIGONALI IN TERMOFORMATO MORBIDO



Dimensioni	188 x 405 x 33 mm
Misure	6x7 - 8x9 - 10x11 - 12x13 - 14x15 - 16x17 - 18x19 - 20x22 mm
Articoli inclusi	0476/..

TM01/031 € 53,40

SERIE DI CHIAVI POLIGONALI IN TERMOFORMATO MORBIDO



Dimensioni	188 x 405 x 33 mm
Misure	21x23 - 24x27 - 25x28 - 30x32 mm
Articoli inclusi	0476/..

TM01/032 € 53,40

SERIE DI CHIAVI COMBinate IN TERMOFORMATO MORBIDO

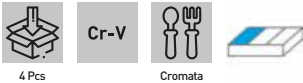

Dimensioni	188 x 405 x 33 mm
Misure	24 - 27 - 30 - 32 mm
Articoli inclusi	0224/..

TM01/033
€ 75,10
SERIE DI CHIAVI COMBinate IN TERMOFORMATO MORBIDO

Dimensioni	188 x 405 x 33 mm
Misure	24 - 27 - 30 - 32 mm
Articoli inclusi	0208/..

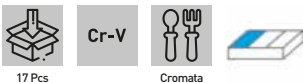
TM01/036
€ 81,30
SERIE DI CHIAVI A TUBO E POLIGONALI IN TERMOFORMATO MORBIDO

Dimensioni	188 x 405 x 33 mm
Chiavi a tubo	6x7 - 8x9 - 10x11 - 12x13 - 14x15 - 16x17 - 18x19 - 20x22 mm
Chiavi poligonali	100 - 6x7, 115 - 8x9, 130 - 10x11, 145 - 12x13, 160 - 14x15, 170 - 16x17, 185 - 18x19 - 205 - 20x22 mm
Articoli inclusi	0540/.. - 0134S

TM01/037
€ 84,30
SERIE DI CACCIASPINE IN TERMOFORMATO MORBIDO



Misure	Ø2x140 - Ø3x150 - Ø4x180 - Ø5x220 - Ø6x210 - Ø7x210 - Ø8x220 mm
Articoli inclusi	C015/..

TM01/064
€ 153,00 NEW
SERIE UTENSILI PER AUTOMOTIVE IN TERMOFORMATO MORBIDO

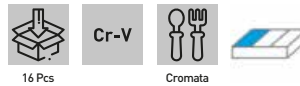

Dimensioni	565 x 405 x 33 mm
Articoli inclusi	0873/BD8 - 0873/U8 - 0873/TL - 0246 - 0248 - 0247 - 0249 - 0154/500DIN - 0839/40 - 0118 - B006/4 - S022/18 - C012/04

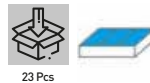
TM01/035
€ 143,00
SERIE DI CHIAVI A TUBO E POLIGONALI IN TERMOFORMATO MORBIDO

Dimensioni	188 x 405 x 33 mm
Chiavi a tubo	6x7 - 8x9 - 10x11 - 12x13 - 14x15 - 16x17 - 18x19 - 20x22 mm
Chiavi poligonali	100 - 6x7, 115 - 8x9, 130 - 10x11, 145 - 12x13, 160 - 14x15, 170 - 16x17, 185 - 18x19 - 205 - 20x22 mm
Articoli inclusi	0442/.. - 0134S

TM01/069
€ 139,00 NEW
SERIE UTENSILI PER AUTOMOTIVE IN TERMOFORMATO MORBIDO

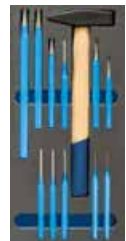
Dimensioni	565 x 405 x 33 mm
Articoli inclusi	0096/L - 0154/300DIN - 0617 - 0831/250 - 0839/40 - 0873/BD6 - 0873/TL - 0873/U6 - C012/.. - F265

TM01/038
€ 96,70
SERIE DI CACCIASPINE IN TERMOFORMATO MORBIDO

Dimensioni	188 x 405 x 33 mm
Cacciaspine cilindrico	Ø2x150 - Ø3x150 - Ø4x150 - Ø5x150 - Ø6x150 - Ø7x150 - Ø8x150 mm
Bulini	4x120 - 5x150 mm
Scalpellì	18x150 - 21x200 - 25x250 mm
Martello tedesco	400g
Articoli inclusi	C012/.. - B006/.. - S022/.. - 0154/400DIN

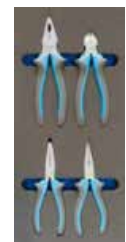
TM01/042
€ 45,40
SERIE DI PINZE MISTE IN TERMOFORMATO MORBIDO

Dimensioni	188 x 405 x 33 mm
Pinza universale	180 mm
Tronchese taglio laterale	160 mm
Pinza a becchi lunghi piegati	160 mm
Pinza a becchi lunghi dritti	160 mm
Articoli inclusi	0873/U7 - 0873/BD6 - 0873/BC6 - 0873/TL



TM01/043 € 194,00

**SERIE DI BUSSOLE IMPACT
IN TERMOFORMATO MORBIDO**



Dimensioni	188 x 405 x 33 mm
Bussole	10 - 11 - 12 - 13 - 14 - 16 - 17 - 18 - 19 - 21 - 22 - 23 - 24 mm
Prolunghe	75 - 150 - 250 mm
Articoli inclusi	BI4E3N.. - PI453..

TM01/047 € 190,00 **NEW**

**SERIE UTENSILI PER AUTOMOTIVE IN TERMOFORMATO
MORBIDO**



Dimensioni	565 x 405 x 33 mm
Articoli inclusi	0084/250 - 0190 - 0201/...

TM01/048 € 70,00 **NEW**

**SERIE UTENSILI PER AUTOMOTIVE IN TERMOFORMATO
MORBIDO**



Dimensioni	565 x 405 x 33 mm
Articoli inclusi	0623 - 0672 - 0873/BD6 ...

TM01/049 € 285,00 **NEW**

**SERIE UTENSILI PER AUTOMOTIVE IN TERMOFORMATO
MORBIDO**

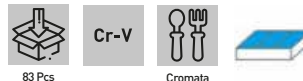

Dimensioni	565 x 405 x 33 mm
Articoli inclusi	0402 - 0839/40 - BN413NX ...

TM01/050 € 566,00

**STRUMENTI DI MISURA PER AUTOMOTIVE IN TERMOFORMATO
MORBIDO**



Dimensioni	565 x 405 x 33 mm
Articoli inclusi	C033/150 - C004 - 0212 - C058 - F685 - T053 - C070 - 0312

TM01/052 € 528,00

**SERIE PNEUMATICA PER AUTOMOTIVE IN TERMOFORMATO
MORBIDO**



Dimensioni	565 x 405 x 33 mm
Articoli inclusi	AP03 - BI4E3Nx - PI453150 - 0341 - JI403N - 0608

TM01/054 € 20,60

TERMOFORMATO PER A007/16



Dimensioni esterne	155 x 405 x 33 mm
Dimensioni interne	2: 103 x 166 x 25 mm

TM01/055 € 20,60

TERMOFORMATO PER A007/16



Dimensioni esterne	155 x 405 x 33 mm
Dimensioni interne	3: 103 x 104 x 25 mm

TM01/100 € 20,60

TERMOFORMATO MORBIDO PORTA MINUTERIA



Dimensioni 188 x 405 x 33 mm

TM01/110 € 30,90

TERMOFORMATO MORBIDO PORTA MINUTERIA



Dimensioni 376 x 405 x 33 mm

TM01/120 € 41,20

TERMOFORMATO MORBIDO PORTA MINUTERIA



Dimensioni 564 x 405 x 33 mm





0165

€ 268,00

VALIGIA CON UTENSILI ED ACCESSORI

175 utensili ed accessori realizzati in lega d'acciaio di cromo vanadio. Valigia con ruote e manico allungabile.



Cr-V

175 Pcs

Scatola

Leve a cricchetto	1/4" - 1/2"
Chiavi a bussola per candele 1\2"	16 mm - 21 mm
Riduzione	1/2" (M) - 3/8" (F)
Porta inserti a cricchetto	1/4"
Bussole da 1/4"	4-4,5-5-5,5-6-7-8-9-10-11-12-13 mm
Porta bussole	1/4"
Bussole da 1/2"	10-11-12-13-14-15-16-17-18-19-20-21-22 23-24-27-30 mm
Leve a "T"	1/4" - 1/2"
Prolunghe da 1/4"	50 - 100 mm
Snodi a cardano	1/4" - 1/2"
Prolunga flessibile	1/4" - 150 mm
Chiavi esagonali a punta sferica	1,5-2-2,5-3-4-5-6-8-10 mm
Cercafasa	100 ÷ 250 V
Giraviti di precisione	(-) 1 - 1,4 - 1,8 - 2,4 - (+) 0 - 1
Pinze	200 - 180 - 160 mm
Chiave a rullino	200 mm
Pinza idraulico	250 mm
Chiavi combinate	6-8-10-11-12-13-14-15-17-19 mm
Martello tedesco	300 g
Flessometro	5 m
Mini archetto con lama	1
Livella magnetica	250 mm
Torcia in alluminio	1
Pinza fastonatrice	200 mm
Capicorda	50
Cutter	1
Pinza grip	175 mm
Nastro isolante	1
Calamita telescopica	1
Calibro a corsoio	150 mm
Giraviti per elettricista	(-) 5 x 125 - 4 x 100 - (+) 3 x 75 mm
Giraviti	(-) 3 x 75 - 3 x 100 - 5 x 75 - 6 x 38 - 6 x 100 mm (+) 3 x 75 - 3 x 100 - 5 x 75 - 6 x 38 - 6 x 100 - 8 x 150 mm
Porta inserti magnetico	1
Inserti	25 1/4"
Dimensioni valigetta	500 x 440 x 200/270 mm trolley mm
Carrello	1
Peso netto	15 kg



0315

€ 184,00

VALIGIA CON UTENSILI E ACCESSORI

Manico valigia ergonomico.



Cr-V

132 Pcs

Scatola

Chiavi esagonali	1,5 - 2 - 2,5 - 3 - 4 - 5 - 6 - 8 - 10 mm
Cercafasa	100 ÷ 250 V
Giraviti di precisione	(-) 1 - 1,4 - 1,8 - 2,4 - (+) 0 - 1
Pinze	200 - 180 - 160 mm
Chiave a rullino	250 mm
Pinza idraulico	250 mm
Chiavi combinate	6 - 8 - 10 - 11 - 12 - 13 - 14 - 15 - 17 - 19 mm
Martello tedesco	300 g
Flessometro	5 m
Mini archetto con lama	1
Livella magnetica	250 mm
Torcia in alluminio	1
Pinza fastonatrice	200 mm
Capicorda	50
Cutter	1
Pinza grip	175 mm
Nastro isolante	1
Calamita telescopica	1
Calibro a corsoio	150 mm
Giraviti per elettricista	(-) 5 x 125 - 4 x 100 - (+) 3 x 75 mm
Giraviti	(-) 3 x 75 - 3 x 100 - 5 x 75 - 6 x 38 - 6 x 100 mm (+) 3 x 75 - 3 x 100 - 5 x 75 - 6 x 38 - 6 x 100 - 8 x 150 mm
Porta inserti magnetico	1
Inserti	25 - 1/4"
Dimensioni valigetta	500 x 440 x 150 mm
Peso netto	9 kg



0105T
€ 318,00
VALIGIA TROLLEY CON UTENSILI E ACCESSORI

UPGRADE

162 Pcs



Scatola

Cr-V

Chiavi esagonali	1,5-2-2,5-3-4-5-6-8-10 mm
Giraviti	(-) 5 x 75 - 6 x 100 mm - (+) 1 x 75 - 2 x 100 mm
Cercafasi	100 ÷ 250 V
Giraviti di precisione	(-) 2 x 140 - 2,4 x 140 - 3 x 140 - (+) 00 x 140 mm - 0 x 140 mm
Pinze	160 mm
Chiave a rullino	200 mm
Tronchese taglio laterale	160 mm
Pinze a becchi mezzitondi	160 mm
Tenaglia cementista	220 mm
Forbici multiuso	175 mm
Cacciaspine e scalpelli	5
Pinze per anelli elastici con 4 teste	4
Pinza idraulico	240 mm
Chiavi combinate	8-10-11-12-13-15-17-19-21 mm
Bussole da 1/4"	4-4,5-5-5,5-6-7-8-9-10-11-12-13-14 mm
Bussole da 1/2"	12-13-14-15-16-17-18-19-21-24-27-30-32 mm
Leva a T scorrevole	1/4"
Snodo universale	1/4" - 1/2"
Prolunghe da 1/4"	50 mm - 100 mm
Prolunghe da 1/2"	125 mm - 250 mm

Attacco da 1/2" per leva a T	1
Misure bussole per candela	16 mm - 21 mm
Leve a cricchetto	1/4" - 1/2"
Lima	200 mm
Martello tedesco	300 g
Flessometro	5 m
Mini archetto con lama	1
Lama	3
Torcia in alluminio	1
Pinza fastonatrice	200 mm
Capicorda	35
Cutter	1
Livella	300 mm
Calibro a corsoio	150 mm
Porta inserti magnetico	1
Inserti	30 - 1/4"
Porta inserti a cricchetto	1
Adattatore maschio con quadro da 1/4" e esagono da 1/4"	1
Dimensioni valigia	470 x 350 x 135 mm
Peso netto	12 kg

0110T
€ 269,00
VALIGIA CON TROLLEY, UTENSILI E ACCESSORI

UPGRADE

135 Pcs



Scatola

Cr-V

Chiavi esagonali	1,5-2-2,5-3-4-5-6-8 mm
Giraviti	(-) 3 x 75 - 5 x 75 - 6 x 100 - 8 x 150 mm - (+) 0 x 75 - 1 x 75
Giraviti di precisione	(-) 2,4 x 140 - (+) 00 x 140 mm - 0 x 140 mm
Pinze	180 mm
Pinza a 2 posizioni	150 mm
Tronchese taglio laterale	115 mm
Pinze a becchi mezzitondi	150 mm
Pinza spelafiti	160 mm
Forbici	200 mm
Pinza idraulico	240 mm
Chiavi combinate	6-8-10-13-14-15-17-19 mm
Bussole da 1/4"	4-5-6-7-8-9-10-11-12-13-14 mm
Bussole da 1/2"	8-9-10-11-12-13-14-15-16-17-18-19-20-21-22 mm
Leva a T scorrevole	1/4"
Snodo universale	1/4" - 1/2"
Prolunghe da 1/4"	100 mm
Prolunghe da 1/2"	250 mm

Attacco da 1/2" per leva a T	1
Misure bussole per candela	16 mm - 21 mm
Leve a cricchetto	1/4" - 1/2"
Prolunga flessibile	1/4" - 145 mm
Bussola porta inserti	1/4"
Martello tedesco	300 g
Flessometro	5 m
Mini archetto con lama	1
Capicorda	20
Cutter	1
Lama	5
Livella	300 mm
Manico per bussole	1/4"
Porta inserti magnetico	1/4"
Inserti	30 - 1/4"
Adattatore maschio con quadro da 1/4" e esagono da 1/4"	1
Dimensioni valigia	470 x 350 x 135 mm
Peso netto	10 kg



0105

€ 272,00

VALIGIA CON UTENSILI E ACCESSORI



UPGRADE



162 Pcs



Scatola

Cr-V

Chiavi esagonali	1,5-2-2,5-3-4-5-6-8-10 mm
Giraviti	(-) 5 x 75 - 6 x 100 mm - (+) 1 x 75 - 2 x 100 mm
Cercafasi	100 ÷ 250 V
Giraviti di precisione	(-) 2 x 140 - 2,4 x 140 - 3 x 140 - (+) 00 x 140 mm - 0 x 140 mm
Pinze	160 mm
Chiave a rullino	200 mm
Tronchese taglio laterale	160 mm
Pinze a becchi mezzitondi	160 mm
Tenaglia cementista	220 mm
Forbici multiuso	175 mm
Cacciaspine e scalpelli	5
Pinze per anelli elastici con 4 teste	4
Pinza idraulico	240 mm
Chiavi combinate	8-10-11-12-13-15-17-19-21 mm
Bussole da 1/4"	4-4,5-5-5,5-6-7-8-9-10-11-12-13-14 mm
Bussole da 1/2"	12-13-14-15-16-17-18-19-21-24-27-30-32 mm
Leva a T scorrevole	1/4"
Snodo universale	1/4" - 1/2"
Prolunghe da 1/4"	50 mm - 100 mm
Prolunghe da 1/2"	125 mm - 250 mm

Attacco da 1/2" per leva a T	1
Misure bussola per candela	16 mm - 21 mm
Leve a cricchetto	1/4" - 1/2"
Lima	200 mm
Martello tedesco	300 g
Flessometro	5 m
Mini archetto con lama	1
Lama	3
Torcia in alluminio	1
Pinza fastonatrice	200 mm
Capicorda	35
Cutter	1
Livella	300 mm
Calibro a corsoio	150 mm
Porta inserti magnetico	1
Inserti	30 - 1/4"
Porta inserti a cricchetto	1
Adattatore maschio con quadro da 1/4" e esagono da 1/4"	1
Dimensioni valigia	470 x 350 x 135 mm
Peso netto	11,5 kg

0110

€ 222,00

VALIGIA CON UTENSILI E ACCESSORI



UPGRADE



135 Pcs



Scatola

Cr-V

Chiavi esagonali	1,5-2-2,5-3-4-5-6-8 mm
Giraviti	(-) 3 x 75 - 5 x 75 - 6 x 100 - 8 x 150 mm - (+) 0 x 75 - 1 x 75 - 2 x 100 3 x 100 mm
Giraviti di precisione	(-) 2,4 x 140 - (+) 00 x 140 mm - 0 x 140 mm
Pinze	180 mm
Pinza a 2 posizioni	150 mm
Tronchese taglio laterale	115 mm
Pinze a becchi mezzitondi	150 mm
Pinza spelafili	160 mm
Forbici	200 mm
Pinza idraulico	240 mm
Chiavi combinate	6-8-10-13-14-15-17-19 mm
Bussole da 1/4"	4-5-6-7-8-9-10-11-12-13-14 mm
Bussole da 1/2"	8-9-10-11-12-13-14-15-16-17-18-19-20-21-22 mm
Leva a T scorrevole	1/4"
Snodo universale	1/4" - 1/2"
Prolunghe da 1/4"	100 mm
Prolunghe da 1/2"	250 mm

Attacco da 1/2" per leva a T	1
Misure bussola per candela	16 mm - 21 mm
Leve a cricchetto	1/4" - 1/2"
Prolunga flessibile	1/4" - 145 mm
Bussola porta inserti	1/4"
Martello tedesco	300 g
Flessometro	5 m
Mini archetto con lama	1
Capicorda	20
Cutter	1
Lama	5
Livella	300 mm
Manico per bussola	1/4"
Porta inserti magnetico	1/4"
Inserti	30 - 1/4"
Adattatore maschio con quadro da 1/4" e esagono da 1/4"	1
Dimensioni valigia	470 x 350 x 135 mm
Peso netto	9,5 kg

0399

€ 202,00

VALIGIA CON UTENSILI E ACCESSORI

87 Pcs



Scatola

Cr-V

Chiavi esagonali	1,5-2-2,5-3-4-5-6-8 mm
Giraviti	(-) 5 x 75 - 6 x 100 mm - (+) 1 x 75 - 2 x 100 mm
Pinze	150 mm
Chiave a rullino	250 mm
Tronchese taglio laterale	150 mm
Pinze a becchi mezzitondi	150 mm
Forbici multiuso	150 mm
Pinza idraulico	240 mm
Chiavi combinate	8-10-11-12-13-14-15-17 mm
Bussole da 1/4"	4-4,5-5-5,5-6-7-8-9-10-11-12-13-14 mm
Bussole da 1/2"	10-13-14-15-16-17-19-21-22 mm
Leva a T scorrevole	1/4"
Snodo universale	1/4" - 1/2"
Prolunghe da 1/4"	50 mm - 100 mm
Prolunghe da 1/2"	125 mm
Misure bussole per candela	16 mm - 21 mm
Leve a cricchetto	1/4" - 1/2"
Martello tedesco	300 g
Cutter	1
Porta inserti magnetico	1
Inserti	30
Adattatore inserti	1/4"
Porta inserti a cricchetto	1
Adattatore maschio con quadro da 1/4" e esagono da 1/4"	1
Dimensioni valigia	450 x 360 x 120 mm
Peso netto	7 kg

0434

€ 97,80

VALIGIA CON UTENSILI E ACCESSORI

53 Pcs



Scatola

Cr-V

Chiavi esagonali	1,5-2-2,5-3-4-5-6-8-10 mm
Giraviti	(-) 5 x 75 - 6 x 100 mm - (+) 1 x 75 - 2 x 100 mm
Pinze	150 mm
Chiave a rullino	200 mm
Pinze a becchi mezzitondi	150 mm
Pinza idraulico	240 mm
Adattatore maschio con quadro da 1/4" e esagono da 1/4"	1
Martello tedesco	300 g
Cutter	1
Porta inserti magnetico	1
Inserti	30 - 1/4"
Porta inserti a cricchetto	1
Flessometro	5 m
Dimensioni valigia	400 x 270 x 120 mm
Peso netto	3 kg

0164

 € 82,00 **NEW**
VALIGETTA IN TESSUTO CON UTENSILI E ACCESSORI

Funzionale valigetta in tessuto ultra-resistente con doppia maniglia superiore logata e pratica tracolla. Composta da 59 utensili e accessori.



59 Pcs

Cr-V

Pinza idraulico	250 mm
Chiavi esagonali	1,5 - 2 - 2,5 - 3 - 4 - 5 - 6 - 8 - 10 mm
Pinza universale	180 mm
Forbici	200 mm
Cutter	18 mm
Porta inserti magnetico	1
Inserti	30 - 1/4"
Porta inserti a cricchetto	1
Martello tedesco	300 g
Giraviti	(-) 3 x 75 - 5 x 100 mm - (+) 0 x 75 - 1 x 100 - 2 x 100 mm
Flessometro	5 m
Chiavi combinate	7 - 8 - 10 - 13 - 17 - 19 mm

**ELETTROUTENSILI**

p. 505

**Elettrotensili
a Batteria**

p. 513

**Elettrotensili
a Filo****PNEUMATICA**

p. 518

**Fissatrici**

p. 520

**Avvitatori**

p. 523

**Smerigliatrici**

p. 523

**Levigatrici**

p. 526

**Pistole per soffiaggio
e gonfiaggio**

p. 528

**Aerografi**

p. 531

**Avvolgitubo****SALDATORI, SVERNICIATORI
E PISTOLE TERMOCOLLANTI**

p. 532

**Saldatori**

p. 533

**Sverniciatori**

p. 534

**Pistole termocollanti****ATTREZZATURA PER
LIQUIDI E FLUIDI**

p. 535

**Oliatori**

p. 536

**Ingrassatori**

p. 537

**Spray**

p. 540

**Taniche**

p. 540

**Nebulizzatori**

p. 541

**Pompe di travaso****ILLUMINAZIONE E
RISCALDATORI**

p. 543

**Riscaldatori**

p. 544

**Faretti LED**

p. 545

**Lampade**

p. 547

**Lenti**

p. 547

**Torçe e lampade
a batteria**

p. 551

**Avvolgicavo e multiprese**



ELETTROUTENSILI FERVI

Progettata per portare la vostra esperienza di lavoro a un livello superiore ovvero più facile, veloce ed efficiente. Grazie alle tecnologie all'avanguardia e ai materiali di alta qualità, sono progettati per durare nel tempo e offrire prestazioni eccezionali.

POWER

I nostri elettrotensili sono dotati di motori potenti che vi permetteranno di affrontare anche le sfide più impegnative con facilità.



MORE POWER

Abbiamo progettato una vasta gamma di utensili per adattarsi alle vostre esigenze specifiche, che si tratti di lavori professionali che di bricolage o manutenzione domestica. La nostra tecnologia avanzata garantisce una maggiore efficienza energetica, contribuendo così a ridurre il consumo di energia.



EXTRAPOWER

Sono progettati pensando al vostro comfort, con impugnature ergonomiche e un design intuitivo per ridurre l'affaticamento durante l'uso. La nostra gamma è costruita per resistere all'usura e garantire una lunga durata, così potrete contare su di essi per molti anni a venire.



Una gamma completa composta dalla linea a batteria con piattaforma 20 V – F20VRANGE - e da quella a filo per rispondere alle tue esigenze applicative.

**FB12CD3AS-22B**€ 167,00 **NEW****TRAPANO AVVITATORE 12V**

Blocco automatico dell'albero, mandrino autoserrante senza chiave, 21 punti di frizione, selettore di velocità, regolazione elettronica della velocità, coppia variabile, 2 modalità: avvitamento e foratura, inversione della rotazione, ricarica rapida, gancio da cintura, puntatore led

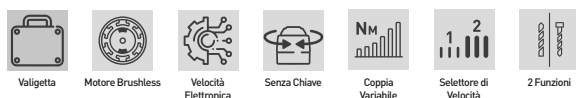
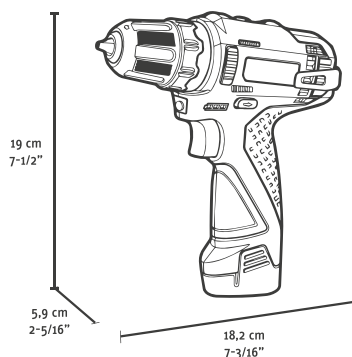

Velocità a vuoto	0-380 min-1 / 0-1250 min-1
Serraggio mandrino	0,8 - 10 mm
Coppia max	19 / 30 Nm
Capacità foratura acciaio	Max 10 mm



Capacità foratura legno	Max 28 mm
Diametro massimo vite	6 mm
Batterie	2 x 2Ah, 12V
Carica batterie	2A, 12V



Piattaforma F20VRANGE

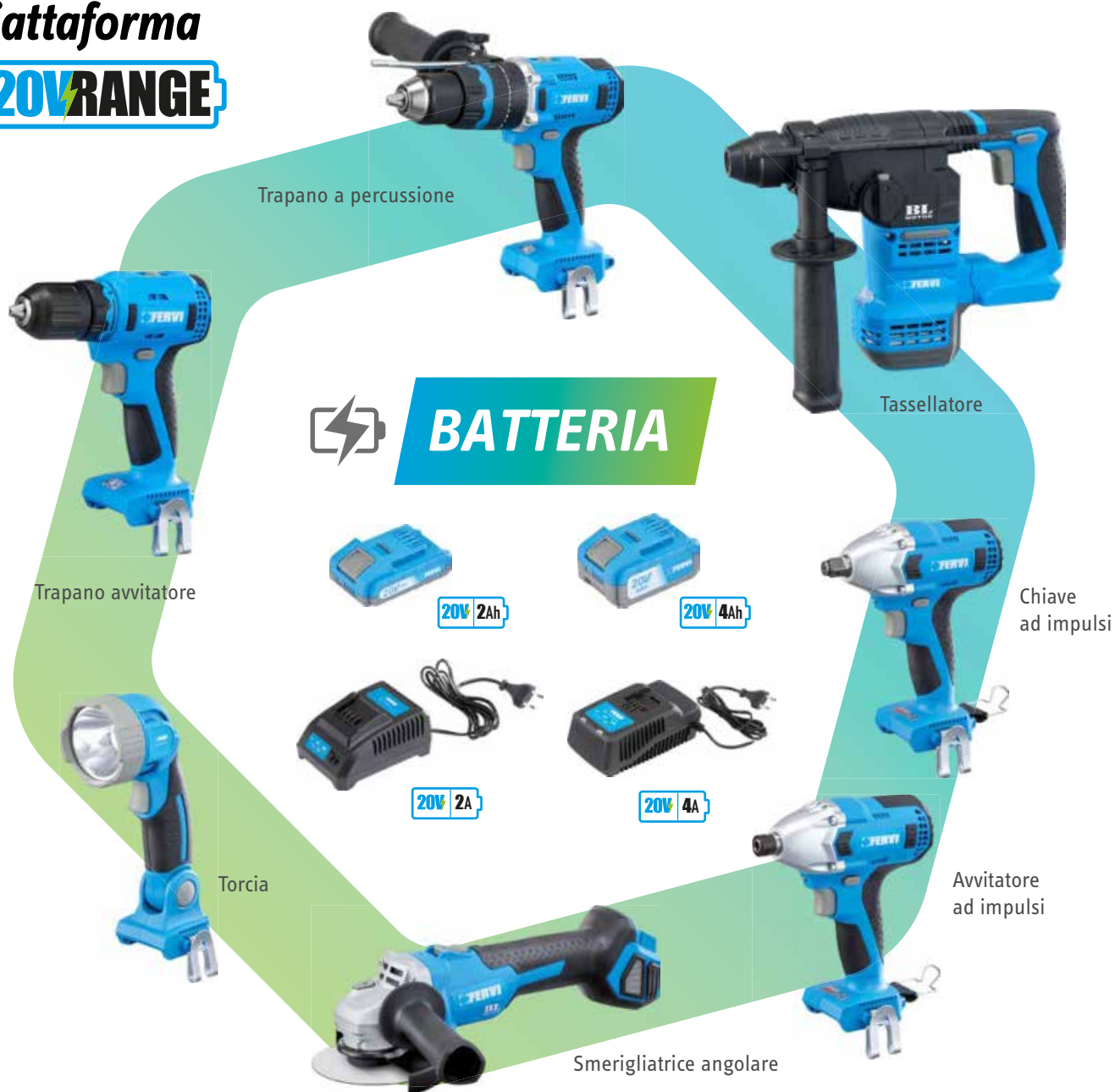

Motore Brushless dalle elevate prestazioni

La gamma F20VRange è composta da utensili con motore brushless con tecnologia avanzata che garantisce maggiori prestazioni, maggiore durata, utensili più leggeri e compatti.

Celle ottimizzate

Le nuove celle delle batterie al litio professionali hanno un'impedenza minore che garantisce maggiore potenza. Le nostre batterie 20V hanno autoscarica lenta che garantisce maggiore durata e un ridotto effetto memoria che garantisce cicli di vita più lunghi.

La gamma giusta al posto giusto

Una gamma importante in costante crescita, studiata per affrontare le applicazioni più impegnative.

2Ah, 4Ah

I 2 livelli di capacità ti permettono di scegliere la batteria più adatta in base alla tipologia di lavoro ed alla durata di impiego.

2A, 4A

I nostri caricabatterie rapidi ti permettono di essere sempre operativo ottimizzando il tuo lavoro.

FB20CD3AB-
NEW
TRAPANO AVVITATORE 20V

Motore brushless, blocco automatico dell'albero, mandrino autoserrante senza chiave, 21 punti di frizione, selettore di velocità, regolazione elettronica della velocità, coppia variabile, 2 modalità: avvitamento e foratura, inversione della rotazione, gancio da cintura, puntatore led, efficace sistema di raffreddamento del motore

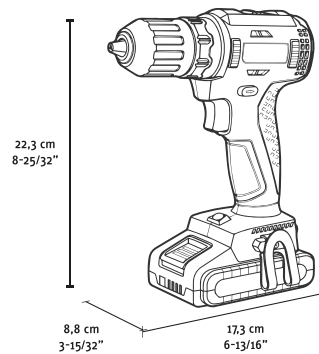

Velocità a vuoto	0-420 min-1 / 0-1400 min-1
Serraggio mandrino	2 - 13 mm
Coppia max	35 / 55 Nm
Capacità foratura acciaio	Max 13 mm
Capacità foratura legno	Max 40 mm
Diametro massimo vite	8 mm



Art.	€	Batterie	Carica batterie
FB20CD3AB-12B	€ 213,00	1 x 2Ah, 20V	2A, 20V
FB20CD3AB-14B	€ 274,00	1 x 4Ah, 20V	4A, 20V
FB20CD3AB-22B	€ 251,00	2 x 2Ah, 20V	2A, 20V
FB20CD3AB-24B	€ 366,00	2 x 4Ah, 20V	4A, 20V
FB20CD3AB-B	€ 121,00	Non incluso	Non incluso

FB20ID3AB-
NEW
TRAPANO A PERCUSSIONE 20V

Motore brushless, blocco automatico dell'albero, mandrino autoserrante in metallo senza chiave, 21 punti di frizione, selettore di velocità, regolazione elettronica della velocità, coppia variabile, 3 modalità: avvitatura / foratura / rotopercussione, inversione della rotazione, gancio da cintura, puntatore led, ampie prese di aerazione

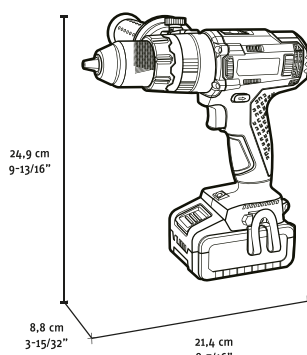

Velocità a vuoto	0-550 min-1 / 0-2000 min-1
Percussioni al minuto	0-7500 min-1 / 0-30000 min-1
Serraggio mandrino	1,5 - 13 mm
Coppia max	70 / 75 Nm
Capacità foratura cemento	Max 16 mm
Capacità foratura acciaio	Max 13 mm
Capacità foratura legno	Max 40 mm
Diametro massimo vite	10 mm



Art.	€	Batterie	Carica batterie
FB20ID3AB-12B	€ 259,00	1 x 2Ah, 20V	2A, 20V
FB20ID3AB-14B	€ 320,00	1 x 4Ah, 20V	4A, 20V
FB20ID3AB-22B	€ 335,00	2 x 2Ah, 20V	2A, 20V
FB20ID3AB-24B	€ 396,00	2 x 4Ah, 20V	4A, 20V
FB20ID3AB-B	€ 167,00	Non incluso	Non incluso

FB20RH3AB-
NEW
TASSELLATORE 20V

Motore brushless, mandrino sds-plus, sistema di stabilizzazione, velocità di rotazione a vuoto e sotto carico. 3 modalità: foratura / rotopercussione / demolizione, modalità vario-lock, sistema anti-vibrazioni, frizione di sicurezza per blocco motore da sovraccarichi, puntatore led, limitatore di profondità incluso.

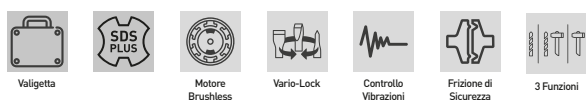
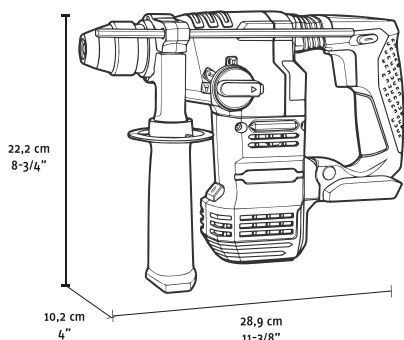

Velocità a vuoto	0-1400 min-1
Percussioni al minuto	0-4500 min-1
Serraggio mandrino	2,3 J
Coppia max	SDS-Plus
Capacità foratura cemento	Max 18 mm
Capacità foratura acciaio	Max 13 mm
Capacità foratura legno	Max 20 mm
Diametro massimo vite	10 mm

Art.	€	Batterie	Carica batterie
FB20RH3AB-24B	€ 565,00	2 x 4Ah, 20V	4A, 20V
FB20RH3AB-B	€ 305,00	Non incluso	Non incluso

FB20AG3AB-
NEW
SMERIGLIATRICE ANGOLARE 125 MM 20V

Motore brushless, partenza graduale per una maggiore sicurezza d'uso, protezione dalle ripartenze, interruttore a due posizioni on/off con blocco, frizione di sicurezza per blocco motore da sovraccarichi, sistema di protezione a regolazione rapida tramite pulsante, impugnatura in gomma morbida, filtro antipolvere in metallo su presa d'aria, corpo macchina di dimensioni contenute, impugnatura in spessa gomma morbida anti-vibrazioni, ampie prese di aerazione.

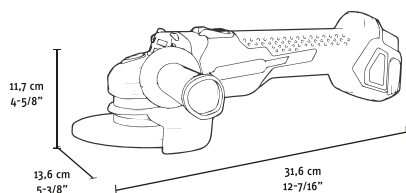

Velocità	8000 min-1
Attacco	M14
Ø max disco da taglio	125 mm
Ø max mola da levigatura	125 mm
Ø max piattello	125 mm
Ø max spazzola in ferro circolare	75 mm
Ø max spazzola in ferro conica	75 mm

Art.	€	Batterie	Carica batterie
FB20AG3AB-12B	€ 351,00	1 x 2Ah, 20V	2A, 20V
FB20AG3AB-14B	€ 381,00	1 x 4Ah, 20V	4A, 20V
FB20AG3AB-22B	€ 396,00	2 x 2Ah, 20V	2A, 20V
FB20AG3AB-24B	€ 473,00	2 x 4Ah, 20V	4A, 20V
FB20AG3AB-B	€ 213,00	Non incluso	Non incluso

**FB20IS3AB-K**€ 152,00 **NEW****AVVITATORE A IMPULSI 20V**

Motore brushless, attacco esagonale a 1/4", regolazione elettronica della velocità, selettore di velocità, inversione della rotazione, puntatore led (4 punti luce), gancio da cintura, coppia variabile: 35 nm / 130 nm / 200 nm / 260 nm, gancio supplementare antivibrante per batteria 4ah, testa in magnesio per una migliore dissipazione del calore, sistema di ventilazione per raffreddamento del motore.

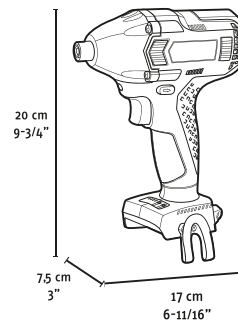

Velocità a vuoto	0-2100 min-1
Percussioni al minuto	0-3200 min-1
Coppia max	35 / 130 / 200 / 260 Nm
Porta utensili	1/4" esagonale
Ø min - max dado / vite	M12 - M22
Batterie	Non incluso
Carica batterie	Non incluso

**FB20IW3AB-K**€ 167,00 **NEW****CHIAVE AD IMPULSI 20V**

Motore brushless, attacco quadro a 1/2", regolazione elettronica della velocità, selettore di velocità, inversione della rotazione, puntatore led (4 punti luce), gancio da cintura, coppia variabile: 35 nm / 130 nm / 200 nm / 300 nm, gancio supplementare antivibrante per batteria 4ah, testa in magnesio per una migliore dissipazione del calore, sistema di ventilazione per raffreddamento del motore.



Velocità a vuoto	0-2100 min-1
Percussioni al minuto	0-3200 min-1
Coppia max	35 / 130 / 200 / 300 Nm
Porta utensili	1/2" quadro
Ø min - max dado / vite	M12 - M22
Batterie	Non incluso
Carica batterie	Non incluso

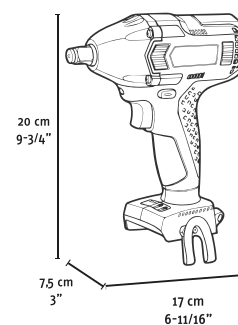

FB20LL3AX-K

€ 45,80 **NEW**

TORCIA 20V

Testa ad angolazione regolabile fino a 270°, impugnatura in gomma morbida, gancio da cintura, fascio di luce da 250 lm

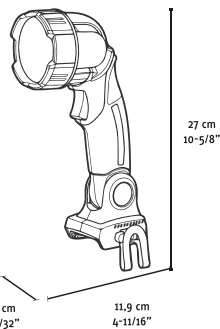

- Scatola
- Impugnatura
Morbida
- ~12h (2Ah) /
~24h (4Ah)
- Gancio da Cintura
- 270°
- LI-ION
BATTERY

Potenza LED	3 W
Flusso luminoso	250 lm
Autonomia	~12h (2Ah) / ~24h (4Ah)
Batterie	Non incluso
Carica batterie	Non incluso



**FB20BC3A2-K**€ 68,70 **NEW****CARICABATTERIE 2A 20V**

Compatibile con batterie Fervi FB20LB3A2 e FB20LB3A4.



Scatola

Potenza	55 W
Tensione di uscita	20 V
Corrente in uscita	2 A
Tempo di ricarica	60 min. (FB20LB3A2) / 120 min. (FB20LB3A4)

FB20BC3A4-K€ 91,70 **NEW****CARICABATTERIE 4A 20V**Compatibile con batterie Fervi FB20LB3A2 e FB20LB3A4.
Ricarica rapida con sistema di ventilazione.

Scatola

Potenza	100 W
Tensione di uscita	20 V
Corrente in uscita	4 A
Tempo di ricarica	35 min. (FB20LB3A2) / 60 min. (FB20LB3A4)

FB20LB3A2-E€ 79,40 **NEW****BATTERIA 2AH 20V**Compatibile con tutti gli articoli della linea Fervi F20VRange
Compatibile con caricabatterie Fervi FB20BC3A2 e FB20BC3A4.

Blister

Tipo batteria	Li-Ion
Voltaggio	20 V
Capacità	2 Ah
Tempo di ricarica	60 min. (FB20BC3A2) / 35 min (FB20BC3A4)

FB20LB3A4-E€ 110,00 **NEW****BATTERIA 4AH 20V**Compatibile con tutti gli articoli della linea Fervi F20VRange
Compatibile con caricabatterie Fervi FB20BC3A2 e FB20BC3A4.

Blister

Tipo batteria	Li-Ion
Voltaggio	20 V
Capacità	4 Ah
Tempo di ricarica	120 min. (FB20BC3A2) / 60 min (FB20BC3A4)

F20VRANGE**Tempi di ricarica****FB20BC3A2-K**
20V - 2Ah**FB20BC3A4-K**
20V - 4Ah**FB20LB3A2-E**
20V - 2Ah**60 minuti****35 minuti****FB20LB3A4-E**
20V - 4Ah**120 minuti****60 minuti**

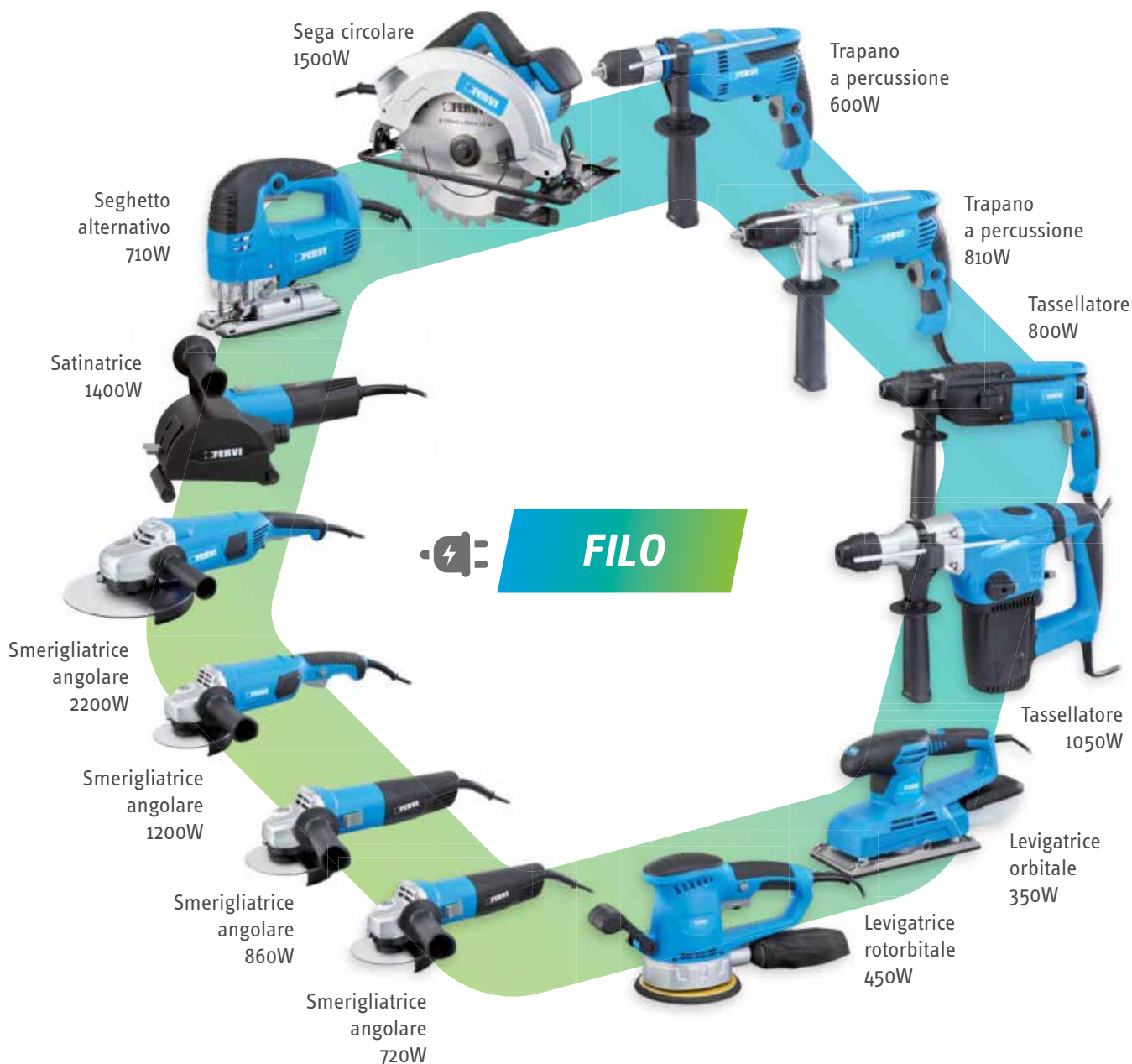

Elevato rapporto Prezzo/Prestazione

La linea a filo è dotata di motori altamente performanti dotati di elettronica a bordo per la regolazione della velocità, la gestione del surriscaldamento e la partenza graduale. Questa caratteristica permette di utilizzare un elettrodomestico prestazionale ad un prezzo incredibile.

Ergonomia e leggerezza

L'ergonomia e il peso degli elettrodomestici è stata studiata per permettere un utilizzo intensivo senza gravare sull'operatore.

Linea completa

Nel progettare la linea a filo, abbiamo cercato di venire in contro a tutte le applicazioni, pensando anche ai materiali da lavorare.

Per questo all'interno dell'attuale offerta trovate elettrodomestici per la lavorazione dei seguenti materiali:

- FERRO
- LEGNO
- ACCIAIO
- CEMENTO
- ALLUMINIO
- CALCESTRUZZO

**FFID06003A-K**€ 76,40 **NEW****TRAPANO A PERCUSSIONE 600W**

Mandrino autoserrante senza chiave con blocco a 2 stadi, velocità variabile, regolazione elettronica della velocità, 2 modalità: foratura / foratura con percussione, inversione della rotazione, funzione lock-on per un uso continuativo più confortevole, impugnatura in gomma morbida antiscivolo, limitatore di profondità e impugnatura supplementare inclusi.

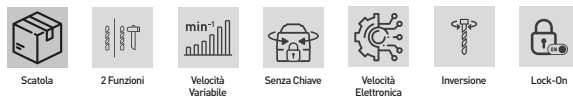
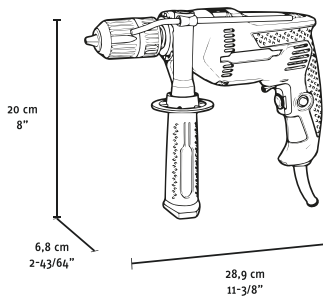

Potenza	600 W
Amperaggio a 220-230V	2,8 A
Velocità a vuoto	0-2800 min-1
Percussioni al minuto	0-44800 min-1
Serraggio mandrino	2 - 13 mm
Capacità foratura cemento	Max 13 mm
Capacità foratura acciaio	Max 13 mm
Capacità foratura legno	Max 20 mm

**FFID08103A-K**€ 122,00 **NEW****TRAPANO A PERCUSSIONE 810W**

Mandrino autoserrante in metallo senza chiave, velocità variabile, regolazione elettronica della velocità, 2 modalità: foratura / foratura con percussione, inversione della rotazione, funzione lock-on per un uso continuativo più confortevole, impugnatura in gomma morbida antiscivolo, limitatore di profondità e impugnatura supplementare inclusi.

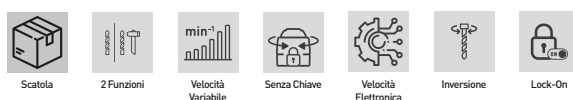
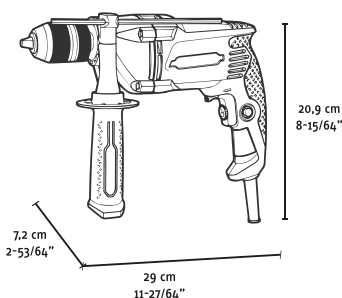

Potenza	810 W
Amperaggio a 220-230V	3,9 A
Velocità a vuoto	0-2800 min-1
Percussioni al minuto	0-44800 min-1
Serraggio mandrino	2 - 13 mm
Capacità foratura cemento	Max 16 mm
Capacità foratura acciaio	Max 13 mm
Capacità foratura legno	Max 30 mm



FFRH08003A-B
€ 213,00 NEW
TASSELLATORE 800W

Mandrino sds-plus, mandrino addizionale con chiave con adattatore sds-plus, regolazione elettronica della velocità, 3 modalità: foratura / rotopercussione / percussione, modalità vario-lock, inversione della rotazione, frizione di sicurezza per blocco motore da sovraccarichi, funzione lock-on per un uso continuativo più confortevole, impugnatura in gomma morbida, limitatore di profondità, impugnatura supplementare, 3 punte, scalpelli a punta e piatto, mandrino addizionale e chiave per flangia inclusi.

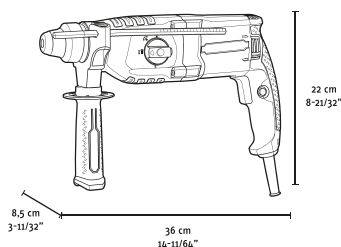

Potenza	800 W
Amperaggio a 220-230V	3,8 A
Velocità a vuoto	0-1200 min-1
Percussioni al minuto	0-5300 min-1
Energia di percussione	3,4 J
Mandrino	SDS-Plus
Capacità foratura cemento	Max 26 mm
Capacità foratura acciaio	Max 13 mm
Capacità foratura legno	Max 40 mm

FFRH10503A-B
€ 228,00 NEW
TASSELLATORE 1050W

Mandrino sds-plus, regolazione elettronica della velocità, 3 modalità: foratura / rotopercussione / percussione, sistema anti vibrazioni, frizione di sicurezza per blocco motore da sovraccarichi, impugnatura in gomma morbida, limitatore di profondità, impugnatura supplementare, 3 punte, scalpelli a punta e piatto, raccogli-polvere, contenitore con lubrificante, chiave per flangia inclusi.

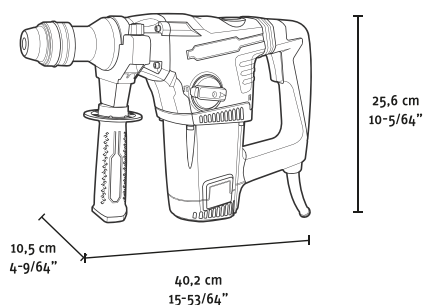

Potenza	1050 W
Amperaggio a 220-230V	4,9 A
Velocità a vuoto	0-750 min-1
Percussioni al minuto	0-2800 min-1
Energia di percussione	4,8 J
Mandrino	SDS-Plus
Capacità foratura cemento	Max 32 mm
Capacità foratura acciaio	Max 13 mm
Capacità foratura legno	Max 40 mm



FFAG07203A-115K
€ 76,40 NEW
SMERIGLIATRICE ANGOLARE 115 MM 720W

Filetto dell'albero m14, partenza graduale, blocco dell'albero, protezione delle ripartenze, interruttore a slitta a due posizioni on/off con blocco, impugnatura in gomma morbida di dimensioni contenute, scheda elettronica sul motore per evitare di sovraccaricare rotore e statore, chiave per flangia, impugnatura supplementare, guardia di protezione inclusi.

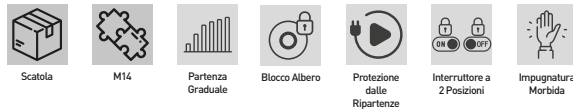

Potenza	720 W
Amperaggio a 220-230V	3,3 A
Velocità	0-11000 min-1
Attacco	M14
Ø max disco da taglio	115 mm
Ø max mola da levigatura	115 mm
Ø max piattello	115 mm
Ø max spazzola in ferro circolare	75 mm
Ø max spazzola in ferro conica	75 mm

FFAG08603A-125K
€ 91,70 NEW
SMERIGLIATRICE ANGOLARE 125 MM 860W

Filetto dell'albero m14, partenza graduale, blocco dell'albero, protezione delle ripartenze, interruttore a slitta a due posizioni on/off con blocco, impugnatura in gomma morbida di dimensioni contenute, scheda elettronica sul motore per evitare di sovraccaricare rotore e statore, chiave per flangia, impugnatura supplementare, guardia di protezione inclusi.

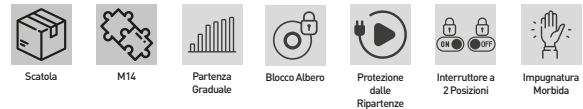

Potenza	860 W
Amperaggio a 220-230V	3,9 A
Velocità	0-11000 min-1
Attacco	M14
Ø max disco da taglio	125 mm
Ø max mola da levigatura	125 mm
Ø max piattello	125 mm
Ø max spazzola in ferro circolare	75 mm
Ø max spazzola in ferro conica	75 mm

FFAG12003V-125K
€ 99,30 NEW
SMERIGLIATRICE ANGOLARE 125 MM 1200W

Filetto dell'albero m14, partenza graduale, velocità variabile, blocco dell'albero, protezione delle ripartenze, funzione lock-off, impugnatura in gomma morbida di dimensioni contenute, ampie prese di aerazione, vano di ispezione carboncini di rapido accesso, chiave per flangia, impugnatura supplementare, guardia di protezione inclusi.

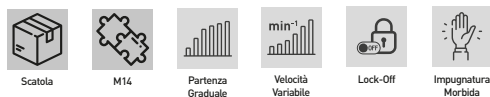

Potenza	1200 W
Amperaggio a 220-230V	5,4 A
Velocità	0-11000 min-1
Attacco	M14
Ø max disco da taglio	125 mm
Ø max mola da levigatura	125 mm
Ø max piattello	125 mm
Ø max spazzola in ferro circolare	75 mm
Ø max spazzola in ferro conica	75 mm

FFAG22003A-230K
€ 167,00 NEW
SMERIGLIATRICE ANGOLARE 230 MM 2200W

Filetto dell'albero m14, partenza graduale, blocco dell'albero, protezione delle ripartenze, funzione lock-off, impugnatura in gomma morbida di dimensioni contenute, scheda elettronica sul motore per evitare di sovraccaricare rotore e statore, 3 punti di ancoraggio per impugnatura supplementare, ampie prese di aerazione con flusso dell'aria in direzione anteriore, cavo in gomma da 8 mm, chiave per flangia, impugnatura supplementare, guardia di protezione inclusi.



Potenza	2200 W
Amperaggio a 220-230V	10,0 A
Velocità	0-6500 min-1
Attacco	M14
Ø max disco da taglio	230 mm
Ø max mola da levigatura	230 mm
Ø max piattello	230 mm
Ø max spazzola in ferro circolare	100 mm
Ø max spazzola in ferro conica	100 mm

FFSF14003A-110K
€ 213,00 NEW
SATINATRICE 110 MM 1400W

Velocità variabile, sistema di stabilizzazione della velocità di rotazione, partenza graduale, blocco dell'albero, protezione dalle ripartenze, interruttore a due posizioni on/off con blocco, sistema di regolazione della profondità della spazzola con cuffia, impugnatura supplementare, guardia di protezione, adattatore per aspirapolvere, chiave esagonale inclusi.

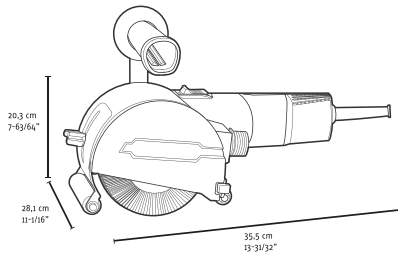

Potenza	1400 W
Amperaggio a 220-230V	6,6 A
Velocità	1000-4000 min-1
Diametro albero	19 mm
Ø max spazzola	110 mm
Larghezza max spazzola	100 mm

FFJS07103A-K
€ 121,00 NEW
SEGHETTO ALTERNATIVO 710W

Regolazione della frequenza di percussione, regolazione dell'angolo di taglio, pendolo a 4 modalità, cambio rapido della lama integrato nella difesa, funzione lock-on, ingranaggi in metallo, flusso d'aria frontale per tenere il taglio pulito, ideale per tagli a tuffo, lama, vite di fissaggio guida, perno di posizionamento, chiave esagonale, guida per taglio parallelo / circolare inclusi.

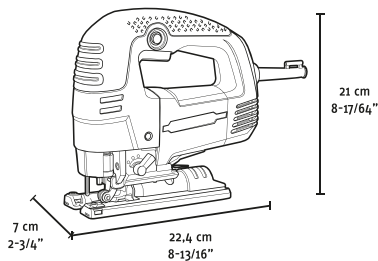

Potenza	710 W
Amperaggio a 220-230V	3,1 A
Frequenza corse a vuoto	700-3000 min-1
Lunghezza corsa	26 mm
Profondità di taglio nel legno	85 mm
Profondità di taglio nell'alluminio	20 mm
Profondità di taglio nell'acciaio	10 mm
Angolo di taglio	Max 45° / 45°

FFCS15003A-190K
€ 182,00 NEW
SEGA CIRCOLARE 1500W

Regolazione della profondità di taglio, regolazione dell'angolo di taglio, funzione lock-off, sistema di estrazione della polvere con canotto di scarico, protezione operatore, impugnatura in gomma morbida, lama, chiave, guida parallela inclusi.

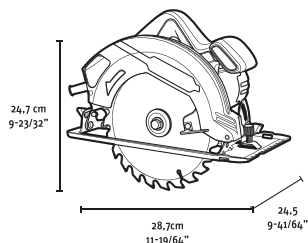

Potenza	1500 W
Amperaggio a 220-230V	6,8 A
Velocità a vuoto	5500 min-1
Ø min / max lama	185 / 190 mm
Diametro foro	20 mm
Spessore lama	2 mm
Profondità di taglio	Max 66 mm (90°) / 46 mm (45°)





FFOS03503A-K

€ 106,00 **NEW****LEVIGATRICE ORBITALE 350W**

Sistema bloccaggio carta abrasiva a molla, velocità variabile, sistema di estrazione della polvere con contenitore / compatibile con aspiratore, impugnatura posteriore "a D" in gomma morbida, sistema di pulizia del filtro, 3 pcs carta abrasiva e contenitore raccogli-polvere inclusi.

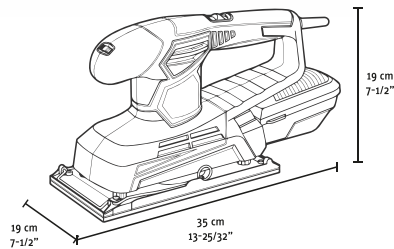

Potenza	350 W
Amperaggio a 220-230V	1,5 A
Velocità a vuoto	6000-11000 min-1
Velocità oscillazione a vuoto	12000-22000 min-1
Eccentricità	2,5 mm
Dimensioni carta abrasiva	115 x 280 mm
Dimensioni superficie abrasiva	115 x 230 mm

FFRS04503A-150K

€ 106,00 **NEW****LEVIGATRICE ROTORBITALE 150 MM 450W**

Fissaggio a velcro, velocità variabile, funzione lock-on per un utilizzo continuativo, sistema di estrazione della polvere con sacchetto / compatibile con aspiratore, impugnatura posteriore a d in gomma morbida, impugnatura frontale regolabile, 3 pcs carta abrasiva (grana 60, 80 e 120) e sacchetto raccogli-polvere inclusi.

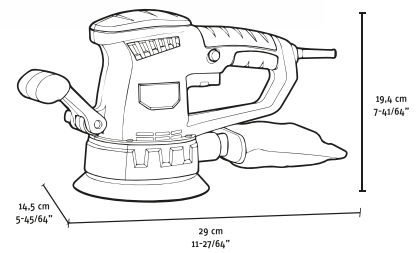

Potenza	450 W
Amperaggio a 220-230V	1,9 A
Velocità a vuoto	4000 min-1 / 13000 min-1
Velocità oscillazione a vuoto	8000-26000 min-1
Eccentricità	2 mm
Ø piattello abrasivo	150 mm



0149
€ 33,60
GRAFFATRICE CHIODATRICE MANUALE

Con 500 punti e 500 chiodi.



Blister

C586
€ 147,00
CHIODATRICE PNEUMATICA

Valigetta

Capacità caricatore	120
Pressione di esercizio	5 - 7 bar
Dimensioni	260 x 240 x 65 mm
Chiodi	F - 10 / 50 mm
Attacco aria	1/4"
Peso netto	1,3 kg

F588/6
€ 142,00
FISSATRICE PNEUMATICA PER SPILLI

Valigetta

Capacità caricatore	195
Pressione di esercizio	5 - 7 bar
Dimensioni	235 x 198 x 46 mm
Punti	0,60 - 12 / 25 mm
Attacco aria	1/4"
Peso netto	1 kg

F585
€ 153,00
FISSATRICE\CHIODATRICE PNEUMATICA

Valigetta

Capacità caricatore	100
Pressione di esercizio	5 - 7 bar
Dimensioni	255 x 230 x 67 mm
Chiodi	F - 10 / 50 mm
Punti	90 - 10 / 40 mm
Attacco aria	1/4"
Peso netto	1,4 kg

0587
€ 104,00
FISSATRICE PNEUMATICA

Valigetta

Capacità caricatore	100
Pressione di esercizio	5 - 7 bar
Dimensioni	225 x 165 x 45 mm
Punti	80 - 6 / 16 mm
Attacco aria	1/4"
Peso netto	0,9 kg

0585
€ 126,00
FISSATRICE\CHIODATRICE PNEUMATICA

Valigetta

Capacità caricatore	80
Pressione di esercizio	5 - 7 bar
Dimensioni	245 x 230 x 55 mm
Chiodi	F - 10 / 50 mm
Punti	90 - 10 / 40 mm
Attacco aria	1/4"
Peso netto	1,4 kg

**0586**

€ 115,00

CHIODATRICE PNEUMATICA

Valigetta

Capacità caricatore	110
Pressione di esercizio	5 - 7 bar
Dimensioni	245 x 225 x 55 mm
Chiodi	F - 10 / 50 mm
Attacco aria	1/4"
Peso netto	1,5 kg

0588/6

€ 98,20

FISSATRICE PNEUMATICA PER SPILLI

Valigetta

Capacità caricatore	130
Pressione di esercizio	5 - 7 bar
Dimensioni	225 x 170 x 45 mm
Punti	0,60 - 12 / 30 mm
Attacco aria	1/4"
Peso netto	1 kg

C589

€ 84,10

CHIODATRICE PALMARE PNEUMATICA

Scatola

Pressione di esercizio	5 - 7 bar
Dimensioni	111 x 115 x 70 mm
Chiodi	Ø 2.5 ÷ 4.1 - testa Ø 6.3 ÷ 8.7 - lungh. 38 ÷ 90 mm
Attacco aria	1/4"
Peso netto	0,5 kg



AP01
€ 261,00
AVVITATORE PNEUMATICO AD IMPULSI

Serie professionale. In materiale composito, impugnatura e testa in gomma antiurto. Leva di azionamento, cambio del senso di rotazione e regolazione della velocità azionabili con una mano. Alta potenza e grande affidabilità.

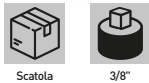
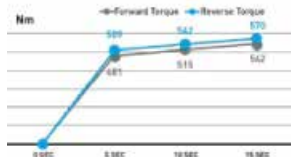

Velocità	8500 rpm
Coppia max	542 Nm 400 lb-ft
Consumo aria stimato	108 l/min 3.8 SCFM
Pressione di esercizio	6 bar 90 psi
Attacco aria	1/4"
Peso netto	1,2 kg

AP02
€ 271,00
AVVITATORE PNEUMATICO AD IMPULSI

Serie professionale. In materiale composito, impugnatura e testa in gomma antiurto. Leva di azionamento, cambio del senso di rotazione e regolazione della velocità azionabili con una mano. Alta potenza e grande affidabilità.



Velocità	7800 rpm
Coppia max	678 Nm 500 lb-ft
Consumo aria stimato	136 l/min 4.8 SCFM
Pressione di esercizio	6 bar 90 psi
Attacco aria	1/4"
Peso netto	1,2 kg

AP03
€ 280,00
AVVITATORE PNEUMATICO AD IMPULSI

Serie professionale. In materiale composito, impugnatura e testa in gomma antiurto. Leva di azionamento, cambio del senso di rotazione e regolazione della velocità azionabili con una mano. Alta potenza e grande affidabilità.

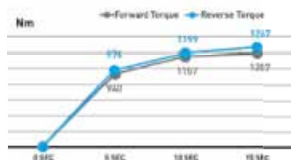

Velocità	7300 rpm
Coppia max	1085 Nm 800 lb-ft
Consumo aria stimato	153 l/min 5.4 SCFM
Pressione di esercizio	6 bar 90 psi
Attacco aria	1/4"
Peso netto	2 kg

AP04
€ 291,00
AVVITATORE PNEUMATICO AD IMPULSI

Serie professionale. In materiale composito, impugnatura e testa in gomma antiurto. Leva di azionamento, cambio del senso di rotazione e regolazione della velocità azionabili con una mano. Alta potenza e grande affidabilità.

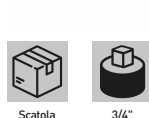
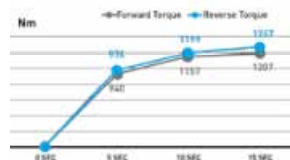

Velocità	7300 rpm
Coppia max	1085 Nm 800 lb-ft
Consumo aria stimato	153 l/min 5.4 SCFM
Pressione di esercizio	6 bar 90 psi
Attacco aria	1/4"
Peso netto	2,1 kg



AP05

€ 677,00

AVVITATORE PNEUMATICO AD IMPULSI

Serie professionale. In materiale composito, impugnatura e testa in gomma antiurto. Leva di azionamento, cambio del senso di rotazione e regolazione della velocità azionabili con una mano. Alta potenza e grande affidabilità.



Velocità	5300 rpm
Coppia max	1900 Nm 1400 lb-ft
Consumo aria stimato	224 l/min 8.1 SCFM
Pressione di esercizio	6 bar 90 psi
Attacco aria	3/8"
Peso netto	3,3 kg

AP05/150

€ 813,00

AVVITATORE PNEUMATICO AD IMPULSI

Con incudine di 150 mm serie professionale. In materiale composito, impugnatura e testa in gomma antiurto. Leva di azionamento, cambio del senso di rotazione e regolazione della velocità azionabili con una mano. Alta potenza e grande affidabilità.

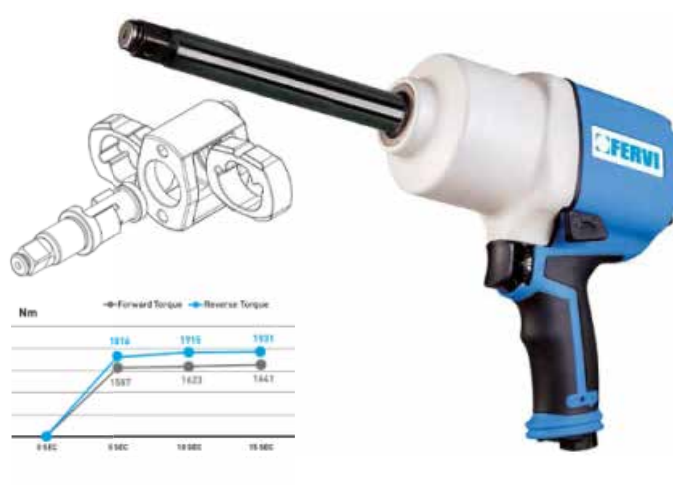

Velocità	5300 rpm
Coppia max	1900 Nm 1400 lb-ft
Consumo aria stimato	224 l/min 8.1 SCFM
Pressione di esercizio	6 bar 90 psi
Attacco aria	3/8"
Peso netto	4 kg

AP06

€ 261,00

AVVITATORE PNEUMATICO AD IMPULSI

Serie professionale. In materiale composito, impugnatura e testa in gomma antiurto. Leva di azionamento, cambio del senso di rotazione e regolazione della velocità azionabili con una mano. Alta potenza e grande affidabilità.



Velocità	9000 rpm
Coppia max	312 Nm 230 lb-ft
Consumo aria stimato	113 l/min 4 SCFM
Pressione di esercizio	6 bar 90 psi
Attacco aria	1/4"
Peso netto	1,1 kg



0571 € 178,00

AVVITATORE AD IMPULSI



Velocità	7000 rpm
Coppia max	610 Nm
Consumo aria stimato	5 SCFM (150 l/min)
Pressione di esercizio	6 bar / 90 psi
Attacco aria	1/4"
Peso netto	2,6 kg

0576 € 188,00

AVVITATORE AD IMPULSI



Velocità	7000 rpm
Coppia max	435 Nm
Consumo aria stimato	5 SCFM (150 l/min)
Pressione di esercizio	6 bar / 90 psi
Attacco aria	1/4"
Peso netto	2,5 kg

0786 € 315,00

AVVITATORE AD IMPULSI



Velocità	4200 rpm
Coppia max	950 Nm
Consumo aria stimato	8 SCFM (240 l/min)
Pressione di esercizio	6 bar / 90 psi
Attacco aria	1/4"
Peso netto	4,8 kg

0044 € 104,00

SET AVVITATORE AD IMPULSI

Con 10 bussole, una prolunga per bussole, ugello da 1/4".



Velocità	7000 rpm
Coppia max	320 Nm
Bussole	9-10-11-13-14-17-19-22-24-27 mm
Prolunga	125 mm
Consumo aria stimato	5 SCFM (150 l/min)
Pressione di esercizio	6 bar/90 psi
Livello pressione acustica	84.4 ± 2.94 dB(A)
Livello vibrazione trasmessa mano braccio	8.53 ± 2.05 m/s ²
Attacco aria	1/4"
Peso netto	4 kg

0045 € 62,40

AVVITATORE AD IMPULSI



Velocità	7000 rpm
Coppia max	320 Nm
Consumo aria stimato	5 SCFM (150 l/min)
Pressione di esercizio	6 bar / 90 psi
Attacco aria	1/4"
Peso netto	2,3 kg

0052 € 147,00

AVVITATORE AD IMPULSI



Velocità	4800 rpm
Coppia max	680 Nm
Consumo aria stimato	6 SCFM (180 l/min)
Pressione di esercizio	6 bar / 90 psi
Attacco aria	1/4"
Peso netto	4,7 kg

0413 € 33,80

MINI SMERIGLIATRICE PNEUMATICA ASSIALE

Con pinze da 3 mm e 6 mm. Scarico aria posteriore girevole. Corpo in materiale composito.



Scatola

Pinze	ø 3 mm - ø 6 mm
Velocità	25000 rpm
Consumo aria stimato	4 SCFM (113 l/min)
Pressione di esercizio	6 bar / 90 psi
Attacco aria	1/4"
Peso netto	0,4 kg

0416 € 60,10

SMERIGLIATRICE PNEUMATICA A 90°

Con pinze da 3 mm e 6 mm. Scarico aria posteriore girevole. Corpo in materiale composito.



Scatola

Pinze	ø 3 mm - ø 6 mm
Velocità	20000 rpm
Consumo aria stimato	4 SCFM (113 l/min)
Pressione di esercizio	6 bar / 90 psi
Attacco aria	1/4"
Peso netto	0,5 kg

0418 € 58,90

TRAPANO AD ARIA REVERSIBILE

Con mandrino da 10 mm a cremagliera. Scarico aria posteriore girevole. Corpo in materiale composito.



Scatola

Mandrino	ø 10 mm
Velocità	1800 rpm
Consumo aria stimato	4 SCFM (113 l/min)
Pressione di esercizio	6 bar / 90 psi
Attacco aria	1/4"
Peso netto	0,9 kg

0414 € 38,60

SMERIGLIATRICE PNEUMATICA ASSIALE

Con pinze da 3 mm e 6 mm, scarico aria posteriore girevole, corpo in materiale composito.



Scatola

Pinze	ø 3 mm - ø 6 mm
Velocità	22000 rpm
Consumo aria stimato	7 SCFM (198 l/min)
Pressione di esercizio	6 bar / 90 psi
Attacco aria	1/4"
Peso netto	0,6 kg

0417 € 66,40

SMERIGLIATRICE PNEUMATICA ASSIALE LUNGA

Con pinze da 3 e 6 mm, scarico aria posteriore girevole, corpo in materiale composito.



Scatola

Pinze	ø 3 mm - ø 6 mm
Lunghezza	295 mm
Velocità	20000 rpm
Consumo aria stimato	4 SCFM (113 l/min)
Pressione di esercizio	6 bar / 90 psi
Attacco aria	1/4"
Peso netto	0,6 kg

0419 € 99,40

LEVIGATRICE PNEUMATICA ROTORBITALE DA 150 MM CON ASPIRAZIONE

Regolazione della velocità, supporto disco a strappo, scarico aria posteriore girevole, corpo leggero in alluminio con impugnatura soffice ed ergonomica.



Scatola

Diametro disco	150 mm - 6"
Orbita	5 mm, 3/16"
Velocità	10500 rpm MAX.
Consumo aria stimato	3 SCFM (85 l/min)
Pressione di esercizio	6 bar / 90 psi
Attacco aria	1/4"
Lunghezza	200 mm
Peso netto	1 kg

0421 € 108,00

LEVIGATRICE PNEUMATICA ROTORBITALE DA 150 MM CON ASPIRAZIONE INTEGRATA

Regolazione della velocità, supporto disco a strappo, scarico aria posteriore girevole, corpo leggero in alluminio con impugnatura soffice ed ergonomica, tubo aspirazione e sacchetto raccogli polvere.



Scatola

Diametro disco	150 mm - 6"
Orbita	5 mm, 3/16"
Velocità	10500 rpm
Consumo aria stimato	3 SCFM (85 l/min)
Pressione di esercizio	6 bar / 90 psi
Attacco aria	1/4"
Lunghezza	200 mm
Peso netto	1 kg

0460 € 117,00

LEVIGATRICE PNEUMATICA ROTORBITALE DA 150 MM CON ASPIRAZIONE INTEGRATA

Regolazione della velocità, scarico aria posteriore girevole, corpo in alluminio ed impugnatura soffice ed ergonomica. Tubo aspirazione e sacchetto raccogli polvere.



Scatola

Diametro disco	150 mm - 6"
Orbita	2,5 mm - 3 / 32"
Velocità max di utilizzo	10500 rpm
Consumo aria stimato	3 SCFM (85 l/min)
Pressione di esercizio	6 bar / 90 psi
Attacco aria	1/4"
Lunghezza	200 mm
Peso netto	1 kg

0047 € 79,30

GIRAVITE PNEUMATICO REVERSIBILE

Scatola



1/4"

Velocità	9000 rpm
Vite	4-5 mm
Coppia max	2,3 - 6,8 Nm
Lunghezza	180 mm
Consumo aria stimato	5 SCFM (150 l/min.)
Pressione di esercizio	6 bar / 90 psi
Attacco aria	1/4"
Peso netto	0,8 kg

0458 € 99,40

LEVIGATRICE PNEUMATICA ROTORBITALE DA 150 MM CON ASPIRAZIONE

Regolazione della velocità, orbita 2,5 mm, supporto disco a strappo, scarico aria posteriore girevole, corpo leggero in alluminio impugnatura soffice ed ergonomica.



Scatola

Diametro disco	150 mm - 6"
Orbita	2,38 mm - 3 / 32"
Velocità max di utilizzo	10500 rpm
Consumo aria stimato	3 SCFM (85 l/min)
Pressione di esercizio	6 bar / 90 psi
Attacco aria	1/4"
Lunghezza	200 mm
Peso netto	1 kg

0046 € 98,20

AVVITORE A CRICCHETTO CON BUSSOLE

Con 7 bussole, una prolunga fissa da 75 mm per bussole, una prolunga da 75 mm con snodo per bussole, ugello da 1/4", tre punte cacciavite e una prolunga da 75 mm fissa per punte da cacciavite.

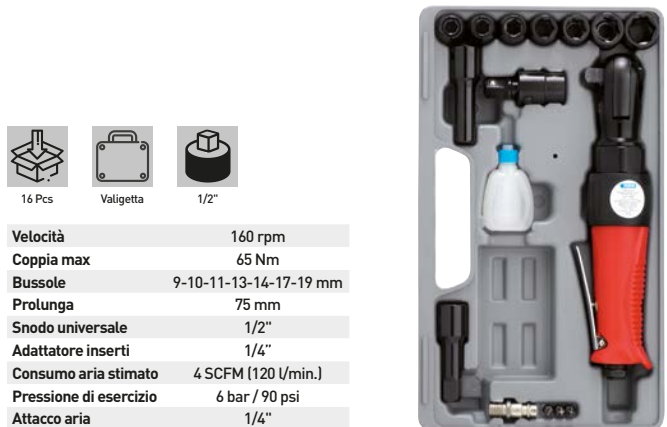

16 Pcs



Valigetta



1/2"

Velocità	160 rpm
Coppia max	65 Nm
Bussole	9-10-11-13-14-17-19 mm
Prolunga	75 mm
Snodo universale	1/2"
Adattatore inserti	1/4"
Consumo aria stimato	4 SCFM (120 l/min.)
Pressione di esercizio	6 bar / 90 psi
Attacco aria	1/4"
Peso netto	2,6 kg

0339 € 81,00

TRAPANO AD ARIA REVERSIBILE

Scatola

Mandrino	Ø 10 mm
Velocità	1800 rpm
Consumo aria stimato	5 SCFM (150 l/min.)
Pressione di esercizio	6 bar / 90 psi
Attacco aria	1/4"
Peso netto	1,1 kg

0574 € 108,00

TRAPANO AD ARIA REVERSIBILE



Scatola

Mandrino	Ø 10 mm
Velocità	1800 rpm
Consumo aria stimato	5 SCFM (150 l/min)
Pressione di esercizio	6 bar / 90 psi
Attacco aria	1/4"
Peso netto	1 kg

0050 € 47,50

SET SMERIGLIATRICE PNEUMATICA ASSIALE CON MOLLETTINE



13 Pcs



Valigetta

Pinze	Ø 3 mm - Ø 6 mm	Pressione di esercizio	6 bar / 90 psi
Mollettine	10 Pz / Pcs	Attacco aria	1/4"
Velocità	22000 rpm	Peso netto	1,2 kg
Consumo aria stimato	4 SCFM (120 l/min.)		

0570 € 109,00

SET SMERIGLIATRICE PNEUMATICA ASSIALE CON MOLLETTINE

Con 10 mollettine, 2 pinze, 1 ugello per l'attacco tubo di alimentazione.



14 Pcs



Valigetta

Pinze	Ø 3 mm - Ø 6 mm
Mollettine	10 Pz
Velocità	21000 rpm
Potenza	0,45 hp
Consumo aria stimato	5 SCFM (150 l/min.)
Pressione di esercizio	6 bar / 90 psi
Livello pressione acustica emesso nell'ambiente	77,9 ± 3,0 dB(A)
Attacco aria	1/4"
Peso netto	1 kg

0313 € 111,00

SMERIGLIATRICE PNEUMATICA ANGOLARE



Scatola

Disco	Ø 125 mm
Velocità	10000 rpm
Consumo aria stimato	5 SCFM (150 l/min)
Pressione di esercizio	6 bar / 90 psi
Attacco aria	1/4"
Peso netto	2 kg

0051 € 32,40

SMERIGLIATRICE PNEUMATICA ASSIALE



Scatola

Pinze	Ø 3 mm - Ø 6 mm
Velocità	22000 rpm
Consumo aria stimato	4 SCFM (120 l/min.)
Pressione di esercizio	6 bar / 90 psi
Attacco aria	1/4"
Peso netto	0,8 kg

0115 € 60,70

SMERIGLIATRICE PNEUMATICA ASSIALE



Scatola

Pinze	Ø 3 mm - Ø 6 mm
Velocità	20000 rpm
Lunghezza	295 mm
Consumo aria stimato	4 SCFM (120 l/min.)
Pressione di esercizio	6 bar / 90 psi
Attacco aria	1/4"
Peso netto	0,7 kg

0641 € 69,50

MICROSMERIGLIATRICE FLESSIBILE PNEUMATICA

Per smerigliature, molatura e smussature.

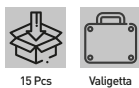

Capacità pinza	3 mm
Velocità	56000 rpm
Consumo aria stimato	2 SCFM (60 l/min.)
Pressione di esercizio	6 bar / 90 psi
Attacco aria	1/4"
Peso netto	0,7 kg

0644 € 44,90

TRONCATRICE PNEUMATICA



Disco	Ø 75 x 1,5 x Ø 10 mm	Pressione di esercizio	6 bar / 90 psi
Velocità	15000 rpm	Attacco aria	1/4"
Consumo aria stimato	5 SCFM (150 l/min.)	Peso netto	0,7 kg

0049 € 9,70

OLIATORE

Per utensili pneumatici.



W021PG € 19,90

PISTOLA GONFIAGGIO



Pressione massima	12 bar (170 psi)
Pressione di esercizio	2 - 4 bar (30 - 60 psi)
Precisione	±1%
Lunghezza tubo in gomma	440 mm
Attacco aria	1/4"

0784 € 81,50

LEVIGATRICE PNEUMATICA

Con nastri di ricambio. Corpo in metallo leggero.



Velocità	16000 rpm	Nastro	10 x 330 mm
Consumo aria stimato	6 SCFM (180 l/min.)	Attacco aria	1/4"
Pressione di esercizio	6 bar / 90 psi	Peso netto	0,9 kg

0059 € 38,00

MARTELLINO PESANTE CON 4 SCALPELLI ESAGONALI

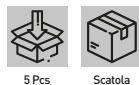

Velocità	BPM 3500	Pressione di esercizio	6 bar / 90 psi
Alesaggio-corsa	19 x 66 mm / 3/4" x 2 5/8"	Attacco aria	1/4"
Consumo aria stimato	4,5 SCFM (135 l/min)	Peso netto	1,5 kg

W021PA € 7,80

PISTOLA PER SOFFIAGGIO



Ugello	2.0 mm
Pressione di esercizio	2 - 6 bar
Attacco aria	1/4"

W021PN € 16,40

PISTOLA PER LAVAGGIO

Con corpo in alluminio e serbatoio in acciaio.



Capacità	900 ml
Ugello	4.5 mm
Pressione di esercizio	3 - 4 bar
Attacco aria	1/4"

**0607****€ 7,10****PISTOLA PER SOFFIAGGIO****Alu**

Blister

Alluminio

Ugello	2.0 mm
Pressione di esercizio	4-6 bar
Attacco aria	1/4"

**0608****€ 20,10****PISTOLA GONFIAGGIO**

Blister

Manometro	ø 63 mm
Letture	0÷12 bar 0÷174 psi
Lunghezza tubo in gomma	420 mm
Attacco aria	Rapido tipo tedesco

**0609****€ 49,20****PISTOLA GONFIAGGIO**

Blister

Manometro	ø 70 mm
Letture	0÷12 bar 0÷174 psi
Lunghezza tubo in gomma	1000 mm
Attacco aria	1/4"

**0725L****€ 10,00****PISTOLA LUNGA PER SOFFIAGGIO**

Blister

Lunghezza tubo	275 mm
Attacco aria	1/4"

**UPGRADE****0125****€ 41,00****PISTOLA GONFIAGGIO DIGITALE**

Con retroilluminazione e cambio unità di misura. Dotato di smonta valvola.



Blister

Pressione massima	8 bar (110 psi)
Pressione di esercizio	2 - 4 bar (30 - 60 psi)
Risoluzione	0,05 bar 0,7 psi
Batterie non incluse	2 x 1.5V AAA
Attacco aria	1/4"

**0610****€ 16,50****PISTOLA PER LAVAGGIO**

Scatola

Capacità	1000 ml
Attacco aria	1/4"

**0725****€ 7,40****PISTOLA PER SOFFIAGGIO**

Blister

Lunghezza tubo	100 mm
Attacco aria	1/4"

**UPGRADE****0412****€ 11,90****PISTOLA PER SOFFIAGGIO**

Di alta qualità con beccuccio in acciaio cromato da 100 mm. Corpo in plastica POM (Polioossimetilene). Valvola in ottone.



Blister

Lunghezza tubo	100 mm
Attacco aria	1/4"



TH601A
€ 166,00
AEROGRAFO CON SERBATOIO A GRAVITÀ

Aerografo HVLP con serbatoio da 600ml, serbatoio in nylon, costruito con macchine a controllo numerico, senza O-ring, ugello e spillo in acciaio inox, nebulizzatore in ottone, ghiera registri in alluminio. 1/4" HVLP = alto volume, bassa pressione.



Scatola

INOX

Cromata



Capacità	600 ml
Diametro ugello	1,3 mm
Portata del liquido	130 ml/min
Pressione di esercizio	2 bar (29 PSI)
Distanza di lavoro	200 mm
Ventaglio	280 - 300 mm
Attacco aria	1/4"
Peso netto	0,5 kg

TH602A
€ 135,00
AEROGRAFO CON SERBATOIO A GRAVITÀ

Aerografo HVLP con serbatoio da 100ml, serbatoio in nylon, costruito con macchine a controllo numerico, senza O-ring, ugello e spillo in acciaio inox, nebulizzatore in ottone, ghiera e registri in alluminio, raccordo maschio da 1/4" HVLP = alto volume, bassa pressione.



Scatola

INOX

Cromata



Capacità	100 ml
Diametro ugello	1,0 mm
Portata del liquido	50 ml/min
Pressione di esercizio	1,5 bar (20 PSI)
Distanza di lavoro	150 mm
Ventaglio	160 mm
Attacco aria	1/4"
Peso netto	0,3 kg

TH901A
€ 166,00
AEROGRAFO CON SERBATOIO A GRAVITÀ

Aerografo LVMP con serbatoio da 600ml, serbatoio in nylon, costruito con macchine a controllo numerico, senza O-ring, ugello e spillo in acciaio inox, nebulizzatore in ottone, ghiera registri in alluminio. LVMP = basso volume, media pressione.



Scatola

INOX

Cromata



Capacità	600 ml
Diametro ugello	1,3 mm
Portata del liquido	140 ml/min
Pressione di esercizio	2 ÷ 2,2 bar (29 ÷ 32 PSI)
Distanza di lavoro	200 mm
Ventaglio	270 - 300 mm
Attacco aria	1/4"
Peso netto	0,5 kg

A601DS
€ 111,00
AEROGRAFO CON SERBATOIO A CHIUSURA AUTOCLAVE

Aerografo HVLP, da 1000ml, serbatoio in alluminio, costruito con macchine a controllo numerico, senza O-ring, ugello e spillo in acciaio inox, nebulizzatore in ottone, ghiera e registri in alluminio. HVLP = alto volume, bassa pressione.



Scatola

INOX

Cromata



Ugello	Ø 1,4 mm
Capacità	1000 cc
Pressione di esercizio	2,5 - 3 bar
Attacco aria	1/4"
Peso netto	1,1 kg

A601A
€ 107,00
AEROGRAFO CON SERBATOIO A GRAVITÀ

Aerografo HVLP con serbatoio da 600ml, serbatoio in nylon, costruito con macchine a controllo numerico, senza O-ring, ugello e spillo in acciaio inox, nebulizzatore in ottone, ghiera e registri in alluminio. HVLP = alto volume, bassa pressione.



Scatola

INOX

Cromata



Ugello	Ø 1,4 mm
Capacità	600 cc
Pressione di esercizio	2,5 - 3,5 bar
Attacco aria	1/4"
Peso netto	1 kg

A602A
€ 68,90
AEROGRAFO CON SERBATOIO A GRAVITÀ

Aerografo HVLP con serbatoio da 100ml, serbatoio in nylon, costruito con macchine a controllo numerico, senza O-ring, ugello e spillo in acciaio inox, nebulizzatore in ottone, ghiera e registri in alluminio. HVLP = alto volume, bassa pressione.



Scatola

INOX

Cromata



Ugello	Ø 1,0 mm
Capacità	100 cc
Pressione di esercizio	2 - 2,5 bar
Attacco aria	1/4"
Peso netto	0,5 kg

A901A € 105,00

AEROGRAFO CON SERBATOIO A GRAVITÀ

Aerografo LVMP con serbatoio da 600ml, serbatoio in nylon, costruito con macchine a controllo numerico, senza O-ring, ugello e spillo in acciaio inox, nebulizzatore in ottone, ghiere in alluminio. LVMP = basso volume, media pressione.



Scatola

INOX



Cromata

Capacità	600 ml
Diametro ugello	1,4 mm
Portata del liquido	200-380 ml/min
Pressione massima	2-3 bar (30-43 PSI)
Attacco aria	1/4"
Peso netto	0,6 kg



A902A € 70,20

AEROGRAFO CON SERBATOIO A GRAVITÀ

Aerografo LVMP con serbatoio da 100ml, serbatoio in nylon, costruito con macchine a controllo numerico, senza O-ring, ugello e spillo in acciaio inox, nebulizzatore in ottone, ghiere in alluminio. LVMP = basso volume, media pressione.



Scatola

INOX



Cromata

Capacità	100 ml
Diametro ugello	1 mm
Portata del liquido	45 - 65 ml/min
Pressione massima	1.5 - 2.5 bar (22 - 36 PSI)
Attacco aria	1/4"
Peso netto	0,3 kg



A162DS € 42,00

AEROGRAFO CON SERBATOIO A CHIUSURA AUTOCLAVE

Copertura in alluminio.



Scatola

Alu

Alluminio

Ugello	Ø 1,8 mm
Capacità	1000 cc
Pressione di esercizio	4-8 bar
Consumo aria	100-200 l/min
Attacco aria	1/4"
Peso netto	0,9 kg



A162C € 29,90

AEROGRAFO CON SERBATOIO A CHIUSURA RAPIDA

Copertura in alluminio



Scatola

Alu

Alluminio

Ugello	Ø 1,8 mm
Capacità	1000 cc
Pressione di esercizio	4-8 bar
Consumo aria	100-200 l/min
Attacco aria	1/4"
Peso netto	0,8 kg



A162A € 25,20

AEROGRAFO CON SERBATOIO A GRAVITÀ



Scatola

Ugello	Ø 1,8 mm
Capacità	500 cc
Pressione di esercizio	4-8 bar
Consumo aria	100-200 l/min
Peso netto	0,5 kg



0048 € 19,10

MINI AEROGRAFO

Dotato di raccordo per bomboletta aria compressa e raccordo da 1/4" per compressore.



7 Pcs



Scatola

TH250
€ 16,90
REGOLATORE DI PRESSIONE

Con manometro per utensili ad aria.



Blister

Manometro	ø 40 mm
Lettura	0÷11 bar 0÷160 psi

TH500
€ 29,50
REGOLATORE DI PRESSIONE

Con manometro per utensili ad aria.



Blister

Manometro	ø 30 mm
Lettura	0÷10 bar 0÷145 psi

0777/2
€ 42,40
RIDUTTORE CON MANOMETRO E SEPARATORE

Scatola

Attacco	1/4" - 3/8" - 1/2"
Lettura	0÷10 bar 0÷140 psi

0777/3
€ 75,20
RIDUTTORE CON MANOMETRO, SEPARATORE E OLIAIORE

Scatola

Attacco	1/4" - 3/8" - 1/2"
Lettura	0÷10 bar 0÷140 psi

0785-XM
SET 2 RUBINETTI MASCHIO UNIVERSALI

Art.	€	Attacco
0785/1M	€ 11,00	1/4"
0785/2M	€ 11,00	3/8"

0785-XF
SET 2 RUBINETTI FEMMINA UNIVERSALI

Art.	€	Attacco
0785/1F	€ 11,00	1/4"
0785/2F	€ 11,00	3/8"

0783-XM
SET 2 INNESTI RAPIDI MASCHIO TIPO TEDESCO

Art.	€	Attacco
0783/1M	€ 3,12	1/4"
0783/2M	€ 3,12	3/8"

0783-XF
SET 2 INNESTI RAPIDI FEMMINA TIPO TEDESCO

Art.	€	Attacco
0783/1F	€ 2,87	1/4"
0783/2F	€ 2,87	3/8"

S075-
SPIRALE IN POLIURETANO CON RACCORDO GIREVOLE MASCHIO

Art.	€	Lunghezza	Diametro	Filetto
S075/08X5	€ 14,20	7,5 m	Ø 8 x 5 mm	1/4"
S075/10X6.5	€ 19,90	7,5 m	Ø 10 x 6,5 mm	1/4"
S100/08X5	€ 17,10	10 m	Ø 8 x 5 mm	1/4"
S100/10X6.5	€ 25,20	10 m	Ø 10 x 6,5 mm	1/4"
S100/12X8	€ 27,90	10 m	Ø 12 x 8 mm	1/4"



**A481/10****€ 80,50****AVVOLGITUBO AUTO RIENTRANTE PER ARIA**

In polipropilene, con tubo in poliuretano rinforzato, carrello per distribuire uniformemente il tubo all'interno dell'avvolgitubo, sfera di arresto regolabile senza attrezzi e staffa di montaggio girevole a 180°.



Scatola

PP

Poliprop.



Pressione massima	17 bar / 250 psi
Lunghezza tubo	10 + 1 m
Raccordi maschio	1/4" BSPT
Diametro tubo	ø 12 x 8 mm
Temperatura di esercizio	0 ÷ 45° C
Peso netto	2,9 kg

A481/15**€ 124,00****AVVOLGITUBO AUTO RIENTRANTE PER ARIA**

In polipropilene, con tubo in poliuretano rinforzato, carrello per distribuire uniformemente il tubo all'interno dell'avvolgitubo, sfera di arresto regolabile senza attrezzi e staffa di montaggio girevole a 180°.



Scatola

PP

Poliprop.



Pressione massima	16 bar / 250 psi
Lunghezza tubo	15 + 1 m
Raccordi maschio	1/4" BSPT
Diametro tubo	ø 12 x 8 mm
Temperatura di esercizio	0 ÷ 45° C
Peso netto	4,4 kg

A481/15H**€ 147,00****AVVOLGITUBO AUTO RIENTRANTE PER ARIA**

In polipropilene, con tubo in poliuretano rinforzato, carrello per distribuire uniformemente il tubo all'interno dell'avvolgitubo, sfera di arresto regolabile senza attrezzi e staffa di montaggio girevole a 180°.



Scatola

PP

Poliprop.



Pressione massima	17 bar / 246 psi
Lunghezza tubo	15 + 1 m
Raccordi maschio	3/8" BSPT
Diametro tubo	ø 13,5 x 9,5 mm
Temperatura di esercizio	0 ÷ 45° C
Peso netto	4,5 kg

A481/30H**€ 219,00****AVVOLGITUBO AUTO RIENTRANTE PER ARIA**

In polipropilene, con tubo in poliuretano rinforzato, carrello per distribuire uniformemente il tubo all'interno dell'avvolgitubo, sfera di arresto regolabile senza attrezzi, sistema di ritorno a bassa velocità e staffa di montaggio girevole a 180°.



Scatola

PP

Poliprop.



Pressione massima	17 bar / 260 psi
Lunghezza tubo	30 + 2 m
Raccordi maschio	3/8" BSPT
Diametro tubo	ø 13,5 x 9,5 mm
Temperatura di esercizio	0 ÷ 45° C
Peso netto	9 kg

0378/1510**€ 182,00****AVVOLGITUBO AUTO RIENTRANTE PER ARIA**

Tubo in poliuretano rinforzato e carrello per distribuire uniformemente il tubo all'interno dell'avvolgitubo.



Scatola

PP

Poliprop.



Pressione massima	18 bar / 260 psi
Lunghezza tubo	15 + 1 m
Raccordi maschio	3/8" BSPT
Diametro tubo	ø 13,5 x 9,5 mm
Temperatura di esercizio	0 ÷ 45° C
Peso netto	5 kg

0481/15**€ 139,00****AVVOLGITUBO AUTO RIENTRANTE PER ARIA**

Con tubo in poliuretano rinforzato, rubinetto femmina tipo tedesco, innesto rapido femmina tipo tedesco e carrello per distribuire uniformemente il tubo all'interno dell'avvolgitubo.



Scatola

ABS

Pressione massima	16 bar / 250 psi
Lunghezza tubo	15 + 1 m
Raccordi maschio	1/4" BSPT
Diametro tubo	ø 12 x 8 mm
Temperatura di esercizio	0 ÷ 45° C
Peso netto	4,5 kg

0793
€ 22,20
PIROGRAFO COMPLETO DI N°6 PUNTALINI

7 Pcs

Blister

Potenza 230 V 50 Hz 30 W

0031
€ 36,10
STAZIONE DI SALDATURA A TEMPERATURA CONTROLLATA

Temperatura regolabile 150°C - 420°C, punta di ferro con foro ø 6 mm.



Scatola



Fusione dello stagno comune	215°
Temperatura di esercizio	215 ÷ 300°C
Temperatura massima	450°C
Alimentazione	230 V, 50 Hz, 37 W

0027/40W
€ 15,80
SALDATORE STILO

Blister

Alimentazione	230 V 50 Hz 40 W
Temperatura di esercizio	450°C ± 10%

0037
€ 21,50
SET PER SALDATURA A STAGNO

Blister

Potenza 230V 50Hz 30W

0033A
€ 123,00
STAZIONE DI SALDATURA A TEMPERATURA CONTROLLATA

Temperatura regolabile 150°C-420°C, punta di ferro con foro ø 6 mm.



Scatola



Fusione dello stagno comune	215°
Temperatura di esercizio	215 ÷ 300°C
Temperatura massima	420°C
Alimentazione stazione	230 V 50 Hz
Alimentazione saldatore	24 V 48 W

0027/30W
€ 13,90
SALDATORE STILO

Blister

Alimentazione	230 V 50 Hz 30 W
Temperatura di esercizio	450°C ± 10%

0033A/TIP
€ 19,80
SERIE PUNTE PER SALDATORE A STAGNO

4 Pcs



Appendibile

0027/40W/TIP
€ 19,80
SERIE PUNTE PER SALDATORE A STAGNO

4 Pcs



Appendibile

0037/TIP
€ 17,60
SERIE PUNTE PER SALDATORE A STAGNO

Serie punte con foro ø 6 mm.



5 Pcs



Appendibile

**0864****€ 49,40****MINI SALDATORE A GAS**

Testa a saldare e a brasare con protezione e accensione.



Blister

Dimensioni

165 x 23 mm

**0026****€ 22,00****SALDATORE ISTANTANEO**

Con punta di ricambio e stagno.



Blister

Potenza

230 V 50 Hz 100 W

**0443****€ 61,80****SALDATORE A PISTOLA MULTIFUNZIONE**

Con regolazione della temperatura, funzione: coltello a caldo, saldatore e pirografo.



Valigetta

Alimentazione

230V 50Hz 200W

Temperatura

70 °C ÷ 500 °C

**0024****€ 33,00****SVERNICIATORE**

Scatola

Temperatura

300 °C - 500 °C

Flusso d'aria

280 l/min - 480 l/min

Potenza

230 V 50Hz 1,5 kW

**0694****€ 48,90****SET SVERNICIATORE**

A 2 temperature, con spatola, raschietti e diffusori.



10 Pcs



Valigetta

Temperatura

[2] 300 °C - 600 °C

Flusso d'aria

500 l/min - 650 l/min

Potenza

230 V 50 Hz 1 - 2 kW

**0444****€ 92,20****SET SVERNICIATORE DIGITALE**

Con regolazione elettronica della temperatura, indicazione della temperatura mediante schermo lcd, 2 livelli di flusso aria, ideale per scaldare, piegare, curvare, sverniciare.



6 Pcs



Scatola

ABS

Alimentazione

230 V, 50 Hz, 2000 W

Temperatura

I 50°C - II 70°C ÷ 600°C - III 70°C ÷ 600°C

Flusso d'aria

I 300L/min - II 300L/min - III 500L/min

**0865****€ 69,70****ACCENDI BARBECUE ELETTRICO**

Accende la carbonella nella griglia o nel camino senza bisogno di prodotti chimici o fiammiferi. Calore generato 600°C, 30 - 60 secondi per accendere.



Scatola

Alimentazione

230 V, 50 Hz, 2000 W

Temperatura

600° C

**0441****€ 76,70****COLTELLO A CALDO TAGLIA POLISTIROLO CON TEMPERATURA REGOLABILE**

Per polistirolo, plastica, gomma piuma, spugna, profondità di taglio regolabile, supporto in metallo.



Scatola

Alimentazione

230 V, 50 Hz, 220 W

Temperatura

120 - 220 - 330 - 400 - 450 °C

Capacità di taglio con regolazione

20 ÷ 90 mm

Taglio massimo

150 mm



0321 € 52,20

COLTELLO A CALDO TAGLIA POLISTIROLO CON TEMPERATURA REGOLABILE

Per polistirolo, plastica, gomma piuma, spugna, profondità di taglio regolabile.



Scatola

Alimentazione	230 V, 50 Hz, 130 W
Temperatura	Max 450 °C
Capacità di taglio con regolazione	14 ÷ 97 mm
Taglio massimo	120 mm

0333 € 122,00

COLTELLO A CALDO TAGLIA POLISTIROLO CON TEMPERATURA REGOLABILE

Per polistirolo, plastica, gomma piuma, spugna, profondità di taglio regolabile, supporto lama in metallo.



Valigetta

Alimentazione	230 V, 50 Hz, 150 W
Temperatura	Max 500 °C
Taglio massimo	150 mm

0706 € 40,10

PISTOLA TERMOCOLLANTE AUTOMATICA



Valigetta

Alimentazione	230 V 40W 300 °C
Colla in stick	Ø 12 mm

0431 € 19,80

PISTOLA TERMOCOLLANTE AUTOMATICA

Con avanzamento automatico, segnale collegamento rete elettrico a Led.



Blister

Alimentazione	230 V, 35 W, 200 °C
Colla in stick	Ø 12 mm
Flusso colla	16 ÷ 20 g/min

0333/150 € 19,80

LAMA DI RICAMBIO



0034 € 5,60

CANDELETTE DI COLLA PER PISTOLA TERMOCOLLANTE



10 Pcs



Blister

Dimensioni	Ø 12 x 200 mm Tot. 200 gr
------------	---------------------------

0071 € 5,90

CANDELETTE DI COLLA PER PISTOLA TERMOCOLLANTE



10 Pcs



Blister

Dimensioni	Ø 12 x 200 mm 200 gr mm
------------	-------------------------

**0156-****OLIATORE IN METALLO CON CANNA FLESSIBILE**

Art.	€	Capacità
0156/200	€ 6,60	200 cc
0156/500	€ 8,20	500 cc

0164/250**€ 8,60****OLIATORE CON CANNA VERTICALE FLESSIBILE**

Plastic

Capacità	250 cc
----------	--------

0171-**BROCCA GRADUATA**

Con beccuccio flessibile, coperchio avvitabile e tappo di chiusura anti-sgocciolamento.



Plastic

Art.	€	Capacità
0171/2	€ 12,40	2 l
0171/3	€ 12,20	3 l
0171/5	€ 16,70	5 l

0172/150**€ 9,40****IMBUTO IN PLASTICA**

Chiusura a vite, beccuccio flessibile, coperchi per le estremità antigocciolamento e maniglia superiore per l'apprensione.



Plastic

Diametro	Ø150 mm
Altezza	435 mm

0158/500**€ 10,00****OLIATORE CON CANNA FLESSIBILE**Plastic 

Capacità	500 ml
----------	--------

0473-**BACINELLA PER CAMBIO OLIO**

Con beccuccio e maniglie, costruita in polietilene ad alta densità, resistente agli urti.



Art.	€	Capacità	Dimensioni
0473/10	€ 21,50	10 l	Ø400 x 120h mm
0473/15	€ 23,50	15 l	Ø500 x 130h mm

0183/750**€ 3,95****RABBOCCATORE**Plastic 

Capacità	750 ml
----------	--------

0677/500 € 19,80

INGRASSATORE MANUALE A LEVA 500CC

 Composto da serbatoio e pompa in metallo, testina regolabile e tubo flessibile in PVC di 300 mm, per utilizzo con grasso sfuso o cartucce di grasso di diametro \varnothing 53 mm.

Scatola

Capacità	500 cc
Dimensioni tubo flessibile	\varnothing 8 x 300 mm

0677 € 45,00

INGRASSATORE MANUALE

 Composto da serbatoio e pompa in metallo, testina regolabile e tubo flessibile in PVC di 450 mm, per utilizzo cartucce di grasso di \varnothing 55 mm o grasso sfuso (adattatore fornito montato).

Scatola

Capacità	1000 cc
Dimensioni tubo flessibile	\varnothing 9 x 450 mm

0677/1A € 307,00

INGRASSATORE PNEUMATICO

 Utilizzo con cartuccia \varnothing 55 mm o grasso sfuso - con 2 cartucce di grasso, tubo rinforzato di 400 mm e testina regolabile a 4 griffe.

Scatola

Capacità	800 cc
Dimensioni	\varnothing 60 x 500 mm
Pressione di esercizio	4 - 6 bar
Pressione massima	10 bar

0677/500CG € 10,20

CARTUCCIA DI GRASSO

A base di sapone di litio, punto di goccia > 185°C, resistente agli alti carichi



Scatola

Capacità	500cc
Dimensioni	\varnothing 53 mm

0677/CG € 11,60

CARTUCCIA DI GRASSO

A base di sapone di litio, punto di goccia > 185°C, resistente agli alti carichi



Scatola

Capacità	650 cc
Dimensioni	\varnothing 55 mm

0677/SO € 31,40

SIRINGA IN PLASTICA PER OLIO

Scatola

Plastic

Capacità	500 g
Dimensioni	\varnothing 50 x 500 mm

**G030-****LUBROREFRIGERANTE EMULSIONABILE**

Di elevata qualità, miscelabile con acqua in queste percentuali: rettifica: 2,5-3,5%, tornitura e fresatura: 3,00-4,00%, foratura profonda: 4,00-7,00%, filettatura, maschiatura e stampaggio leggero: 7-15%.



Art.	€	Quantità
G030/01	€ 13,70	1 l
G030/05	€ 55,50	5 l
G030/25	€ 263,00	25 l

S401/00

€ 8,60

SPRAY MULTIFUNZIONE

È un prodotto dalle molteplici funzioni: lubrifica, protegge, sblocca. È idrorepellente e anticorrosivo. Protegge dalle ossidazioni le parti sottoposte all'azione lavante dell'acqua, rispondendo così alle esigenze della nautica grazie all'elevato potere impermeabilizzante e idrorepellente di cui è dotato. Ideale per la manutenzione di qualsiasi parte meccanica.



Capacità 400 ml

S401/01

€ 7,20

ZINCO CHIARO

Zincante a freddo ad alto peso molecolare a base di resine di tipo sintetico. Solidifica chimicamente producendo un rivestimento metallico di elevata durezza. Protegge tutte le superfici metalliche dall'ossidazione. Forma uno strato uniforme e resistente che può essere verniciabile o lasciato come protezione finale. È ideale nei ritocchi, nella rifinitura e riparazione di parti galvanizzate.



Capacità 400 ml

S401/02

€ 6,50

GRASSO MULTIUSO

Spray composto da grassi saponificati di elevata qualità. Si tratta di un grasso ad ampio settore d'impiego, presenta una buona stabilità chimica, idrorepellenza e adesività. Protegge dall'acqua, è particolarmente stabile e resistente in ambienti salini, polverosi, alle soluzioni basiche ed acide, agli agenti atmosferici. Ideale per la lubrificazione di cuscinetti, bronzine, mozzi, snodi, perni, guide ed in generale nel settore degli autoveicoli, macchine agricole ed industriali.



Capacità 400 ml

S401/03

€ 5,80

SBLOCCANTE E SOLVENTE

Fluido sintetico penetrante ad alto potere solvente e sbloccante, libera rapidamente dadi, bulloni, giunti, filetti, cerniere ed ogni altra parte meccanica dalla ruggine e dalle ossidazioni. Rilascia inoltre un velo protettivo durevole, idrofugo e idrorepellente.



Capacità 400 ml

S401/04

€ 6,40

SILICONE LUBRIFICANTE

Soluzione a base di puro olio di silicone che possiede proprietà antiadesive distaccanti e lubrificanti sui più svariati materiali. Inoltre conferisce una buona idrorepellenza sui materiali trattati prevenendo l'accumulo di cariche elettrostatiche. È efficace come lucidante e protettivo sulle parti plastiche e protegge le guarnizioni da screpolature aumentandone la tenuta e la durata.



Capacità 400 ml

S401/05
€ 6,30
ANTIADESIVO PER SALDATURE

Prodotto a base di polimeri sintetici filmogeni che, grazie alle loro specifiche proprietà, impediscono il grippaggio delle gocce di saldatura a qualsiasi supporto. Inoltre il film impedisce la formazione di ossidi ed eventuali corrosioni da parte di agenti chimici. È idoneo per saldature autogene, elettriche ed a base di gas inerti. Il compost è privo di sostanze silconiche.



Capacità 400 ml

S401/06
€ 10,40
INOX SPRAY

È un rivestimento zincante, a base di resine alchidiche e silconiche che forma uno strato protettivo. Il prodotto è stato studiato per rimanere inalterato nel tempo e presenta una spiccata resistenza chimica alla corrosione, all'azione aggressiva degli agenti atmosferici ed inoltre una resistenza meccanica. Protettivo a rapida essiccazione.



Capacità 400 ml

S401/08
€ 11,00
LUBRIFICANTE SECCO AL PTFE (TEFLON)

È un lubrificante antiadesivo idrorepellente asciutto. Non trattiene la polvere, non macchia. La sua applicazione forma sulla parte trattata una pellicola di PTFE asciutta, flessibile, che aderisce tenacemente ai metalli, al legno, alla plastica, ecc.. Resiste ad una temperatura tra i -80°C e i +260°C. Protegge dalla corrosione. Ideale per catene di trasmissione, filettature, rulli, nastri, guide e utensili ad alto carico, ecc.



Capacità 400 ml

S401/09
€ 7,90
GRASSO AL RAME

È un prodotto composto da particelle ultra fini di rame lamellare e da speciali inibitori di corrosione. Possiede un'azione lubrificante e protettiva adatta a temperature elevate. La resistenza all'alta temperatura (1000°C), l'elevata adesività ed il potere anticorrosivo lo rendono idoneo per tutti i casi dove il calore o l'ambiente altamente corrosivo possono creare bloccaggi irreversibili: perni collettori di scarico, raccordi letati, valvole d'iniezione, rulli e catene trasportatori per forni, ecc.



Capacità 400 ml

S401/10
€ 7,40
OLIO DA TAGLIO

Si tratta di un nuovo prodotto studiato per applicazioni professionali specifiche nel settore della lavorazione e taglio dei metalli ad elevata durezza. L'olio utilizzato è costituito da basi minerali paraffiniche arricchite con speciali additivi EP antisaldanti. Ideale per operazioni gravose di maschiatura e filettatura di acciai particolarmente duri e legati. Adatto anche per il settore idraulico.



Capacità 400 ml

S401/11
€ 5,60
ARIA SPRAY

Elimina immediatamente la polvere depositata sulle superfici meno accessibili. È indicato per la pulizia di lenti, obiettivi, computer, orologeria e meccanica in genere.



Capacità 400 ml



**S401/12**

€ 6,10

DISSODIANTE PER CONTATTI ELETTRICI ED ELETTRONICI

Prodotto specifico per la pulizia a fondo di contatti elettrici, elettronici ed elettromagnetici. Rimuove istantaneamente l'umidità e le sostanze untuose presenti in superficie quali grasso, olio, morchie, cera e colla, lasciando la parte trattata pulita e sgrassata. Se utilizzato su superfici particolarmente delicate, potrebbe risultare aggressivo intaccando le stesse.



made in italy

Capacità 400 ml

**S401/13**

€ 6,80

OLIO DI VASELINA

Olio ad alto grado di purezza studiato appositamente per le applicazioni che necessitano di una manutenzione periodica di lubrificazione. Indicato per lubrificare meccanismi delicati. La sua speciale formula esercita inoltre un potere protettivo duraturo.



made in italy

Capacità 400 ml

**S401/07**

€ 6,00

PULITORE FRENI, CARBURATORI E CORPI FARFALLATI

Detergente speciale di ultima generazione particolarmente efficace per tutte le parti meccaniche che necessitano di essere sgrassate senza risciacquo come freni e frizioni. Adatto per pulire corpi farfallati e collettori di aspirazione realizzati con materiale plastico. Scioglie e rimuove rapidamente olio, grasso e ogni altro tipo di sporco. Elimina i depositi carboniosi ed oleosi dal corpo farfallato e dall'intero impianto di aspirazione. Riduce l'emissione di gas di scarico nocivi.



made in italy

Capacità 500 ml

**S401/14**

€ 7,10

ZINCO PURO

Zincante a freddo ad alto peso molecolare a base di resine di tipo sintetico. Solidifica chimicamente producendo un rivestimento metallico di elevata durezza. Protegge tutte le superfici metalliche dall'ossidazione. Forma uno strato uniforme e resistente che può essere verniciabile o lasciato come protezione finale. Resistente agli agenti atmosferici. È ideale nei ritocchi, nella rifinitura e riparazione di parti galvanizzate.



made in italy

Capacità 400 ml

**S401/15**

€ 7,40

LUBRIFICANTE ADESIVO PER CATENE

Lubrificante ad elevate prestazioni per la lubrificazione della catena. Prodotto testato per il settore agonistico delle competizioni di moto da corsa (strada e fuoristrada), garantisce la lubrificazione per periodi di utilizzo continuo estremamente lunghi e gravosi. Protegge da acqua e polveri. Riduce l'usura della catena, della corona, del pignone e delle parti meccaniche in movimento.



made in italy

Capacità 400 ml

**S401/16**

€ 7,20

GRASSO AL LITIO

Contiene ossidi di litio e titanio che lo rendono idoneo e specifico nel settore nautico. Il prodotto esercita una azione lubrificante durevole in presenza di ambienti salini ed aggressivi. Resistente all'ossidazione. Il prodotto protegge la superficie da agenti corrosivi ed è indicato per agire sia a temperature elevate (220°C) che rigide (-40°C). Ideale per la lubrificazione di perni, snodi, trasmissioni, leve, sospensioni, cerniere, ed organi meccanici esposti dei motori fuori bordo e delle imbarcazioni.



made in italy

Capacità 400 ml



0660-
TANICA IN MATERIALE PLASTICO

Con tubo flessibile, per il trasporto di liquidi infiammabili, con omologazione "un" in accordo con la direttiva europea.

Plastic

Art.	€	Capacità Litri	Dimensioni	Peso netto
0660/05	€ 12,40	5	260 x 120 x 250h mm	0,5 kg
0660/10	€ 17,90	10	330 x 160 x 300h mm	0,7 kg
0660/20	€ 23,50	20	400 x 200 x 360h mm	1 kg

0189-
TANICA IN METALLO

Per il trasporto di liquidi infiammabili, con omologazione "un" in accordo con la direttiva europea.



Art.	€	Capacità Litri	Peso netto
0189/05C	€ 46,40	5	1,5 kg
0189/10C	€ 47,10	10	2,5 kg
0189/20C	€ 53,70	20	3,7 kg

0189/G
€ 2,00
GUARNIZIONE PER TANICHE

Pack

10

0194
€ 14,80
BECCUCCIO IN METALLO

Pack

5

0356
€ 69,50
NEBULIZZATORE CARRELLATO CON LANCIA IN OTTONE

Con guarnizioni in FPM.



Scatola

Capacità 16 L

0303
€ 47,40
NEBULIZZATORE CON LANCIA IN OTTONE

Con manometro e guarnizioni in FPM.



Scatola

Capacità 8 L

**0274**

€ 9,20

NEBULIZZATORE CON UGELLO IN OTTONE

Con guarnizioni in FPM.



Capacità 2 l

0289

€ 6,70

NEBULIZZATORE CON UGELLO IN OTTONE

Guarnizioni in gomma.



Capacità 2 l

P024/06

€ 57,80

POMPA TRAVASO A LEVA

Per travaso fusti olio lubrificante, gasolio, kerosene, e antigelo con tubo rigido in acciaio Ø 16 x 700 mm con filetto M16 x 1 e tubo di mandata in plastica.



Scatola

Alu

Alluminio

Portata	6 l/min
Portata ogni pompata	0.10 l
Filetto pompa	2" / 1-1/2"

P024/15

€ 68,60

POMPA TRAVASO A LEVA

Per travaso fusti olio lubrificante, gasolio, kerosene e antigelo con tubo rigido in acciaio Ø 20 x 820 mm con filetto gas da 1/2" e tubo di mandata in plastica.



Scatola

Alu

Alluminio

Portata	15 l/min
Portata ogni pompata	0.35 l
Filetto pompa	2" / 1-1/2"

0385

€ 59,90

POMPA ROTATIVA

Per travaso fusti olio lubrificante, gasolio, kerosene e antigelo con tubo di pesca telescopico.



Scatola

Alu

Alluminio

Portata	20 l/min
Filetto pompa	2"

0386

€ 42,80

POMPA A LEVA

Per travaso fusti olio lubrificante, gasolio, kerosene e antigelo con tubo di pesca telescopico.



Scatola

Portata	18 l/min
Filetto pompa	2" / 1-1/2"

0474/PP
€ 17,20
PISTOLA PER TRAVASO GASOLIO IN PVC

Scatola

Portata	60÷80 l/min
Boccaglio	Ø25 mm
Attacco di entrata	1" BSP

0474/PE
€ 33,30
PISTOLA PER TRAVASO GASOLIO

Con raccordo girevole.



Scatola

Alu

Alluminio

Portata	60÷120 l/min
Boccaglio	Ø25 mm
Attacco di entrata	1" BSP

0474/PA
€ 82,20
PISTOLA PER TRAVASO GASOLIO AUTOMATICA

Scatola

Portata	90 l/min
Boccaglio	Ø25 mm
Attacco di entrata	1" BSP

0272
€ 16,10
POMPA TRAVASO PER TRAPANO

Per liquidi non infiammabili, esplosivi, corrosivi e oleosi. Utilizzo idoneo per mandrini a cremagliera.



Blister

Plastic

Prevalenza	30 m
Portata pompa	40 l/min
Pressione massima	0.3 MPa
Velocità max di utilizzo	3400 rpm
Temperatura massima	40°C
Diametro tubo	19 mm 3/4"

0755
€ 108,00
POMPA 12V PER GASOLIO

In corrente continua, per travaso gasolio e oli minerali.



Scatola

Motore	DC 12 V, 175 W
Velocità motore	4500 rpm
Portata pompa	40 l/min
Prevalenza	2 m
Aspirazione	4 m
Attacco di entrata	25 mm
Ingombro	200 x 120 x 155 mm
Tempo di utilizzo	Max 30 min

**R608****€ 271,00****RISCALDATORE ELETTRICO A RAGGI INFRAROSSI**

Da 2000 W con supporto per montaggio a parete, corpo in metallo con griglia di protezione in metallo e controllo remoto.



Scatola

Alimentazione

230 V, 2000 W

R609**€ 128,00****RISCALDATORE ELETTRICO A RAGGI INFRAROSSI**

Con supporto per montaggio a parete, corpo in metallo con griglia di protezione in metallo.



Scatola

Alimentazione

230 V, 1300 W

R60XA**RISCALDATORE ELETTRICO A RAGGI INFRAROSSI CON TREPPIEDE**

Corpo in metallo con griglia di protezione in metallo.



Scatola

Art.	€	Alimentazione	Altezza treppiede senza riscaldatore
R609A	€ 158,00	230 V 1,3 kW	600 ÷ 1500 mm
R610A	€ 227,00	230 V 2 kW	600 ÷ 1500 mm

R610**€ 178,00****RISCALDATORE ELETTRICO A RAGGI INFRAROSSI**

Con supporto per montaggio a parete, corpo in metallo con griglia di protezione in metallo.



Scatola

Alimentazione

230 V, 2000 W

R60XB**RISCALDATORE ELETTRICO A RAGGI INFRAROSSI CON SUPPORTO**

Corpo in metallo con griglia di protezione in metallo



Scatola



Art.	€	Alimentazione
R609B	€ 162,00	230 V 1,3 kW
R610B	€ 213,00	230 V 2 kW

T609**€ 52,50****TRIPODE REGOLABILE IN ALTEZZA**

Utilizzabile per faretto, riscaldatori.



Scatola

Altezza	600 ÷ 1500 mm
Fissaggio superiore	M 8

B609**€ 33,90****BULBO A RAGGI INFRAROSSI**

230V, 1300 W.



Scatola

Lunghezza 250 mm

B610**€ 44,80****BULBO A RAGGI INFRAROSSI**

230V, 2000 W.



Scatola

Lunghezza 340 mm

0218-
FARETTO LED

Alloggiamento pressofuso in alluminio super slim, vetro temperato.

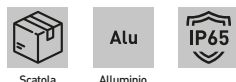

Art.	€	Alimentazione	Flusso luminoso	Temperatura colore	Numero dei LED	Cavo	Dimensioni
0218/10	€ 15,40	230 V, 50 Hz, 10 W	800 lm	4000 K	15 SMD LED	30 cm, H05RN-F 3x1.0 mm ² mm	150 x 95 mm
0218/20	€ 22,50	230 V, 50 Hz, 20 W	1600 lm	4000 K	28 SMD LED	30 cm, H05RN-F 3x1.0 mm ² mm	145 x 120 mm
0218/30	€ 36,70	230 V, 50 Hz, 30 W	2400 lm	4000 K	42 SMD LED	30 cm, H05RN-F 3x1.0 mm ² mm	180 x 150 mm
0218/50	€ 52,00	230 V, 50 Hz, 50 W	4000 lm	4000 K	56 SMD LED	30 cm, H05RN-F 3x1.0 mm ² mm	210 x 180 mm

0218-XB
FARETTO LED CON SUPPORTO

Alloggiamento pressofuso in alluminio super slim, vetro temperato.



Art.	€	Alimentazione	Flusso luminoso	Temperatura colore	Cavo
0218/10B	€ 34,50	230 V, 50 Hz, 10 W	800 lm	4000 K	2 m, 3x1 mm ² H05V-F
0218/20B	€ 41,30	230 V, 50 Hz, 20 W	1600 lm	4000 K	2 m, 3x1 mm ² H05V-F
0218/30B	€ 50,00	230 V, 50 Hz, 30 W	2400 lm	4000 K	2 m, 3x1 mm ² H05V-F
0218/50B	€ 70,70	230 V, 50 Hz, 50 W	4000 lm	4000 K	2 m, 3x1 mm ² H05V-F

0218-XS
FARETTO LED CON SENSORE DI MOVIMENTO E LUMINOSITÀ

Alloggiamento pressofuso in alluminio super slim, vetro temperato.



Art.	€	Alimentazione	Flusso luminoso	Temperatura colore	Cavo
0218/10S	€ 29,90	230 V, 50 Hz, 10 W	800 lm	4000 K	30 cm, 3x1 mm ² H05V-F
0218/20S	€ 35,60	230 V, 50 Hz, 20 W	1600 lm	4000 K	30 cm, 3x1 mm ² H05V-F
0218/30S	€ 47,10	230 V, 50 Hz, 30 W	2400 lm	4000 K	30 cm, 3x1 mm ² H05V-F
0218/50S	€ 63,80	230 V, 50 Hz, 50 W	4000 lm	4000 K	30 cm, 3x1 mm ² H05V-F

**0218/50T****€ 102,00****FARETTO LED 50W E TREMPIEDE**

Alloggiamento pressofuso in alluminio super slim, vetro temperato.



Scatola

Alu

Alluminio



IP65

Alimentazione	220 - 240 V, 50 Hz, 50W
Flusso luminoso	4000 lm
Temperatura colore	4000 K
Cavo	2 m, 3x1 mm ² H05VV-F

0713/18**€ 82,70****FARO A LED CON BASE MAGNETICA**

Da applicare sul tetto o sul cofano delle auto, dei camper, dei fuoristrada, delle barche, delle macchine agricole e delle macchine movimento terra, con fusibile 3A e spina per accendisigari, fascio di luce medio.



Scatola



Alimentazione	DC 9 ÷ 32 V (12 V, 24 V) 18 W
Numero dei LED	6 x 3 W
Flusso luminoso	1260 lm
Temperatura colore	6000 K
Distanza di illuminazione	5 m - 45 lux; 12 m - 10 lux m
Lunghezza cavo	2 m
Dimensione faro	Ø 116 mm
Dimensioni base	Ø 86,50 mm
Interasse dei fori posteriori	87 x 28 mm M6 mm
Dimensioni ingombro	116 x 86,50 x 165 mm

0343**€ 28,80****LAMPADA SNODATA**

Scatola



IP20

Alimentazione	110 / 230 V 50 / 60 Hz
Lampadina	Max 40 W, E27 - non inclusa
Raggio d'azione	800 mm
Capacità morsetto	35 mm

0713/15**€ 73,20****FARO A LED CON BASE MAGNETICA**

Da applicare sul tetto o sul cofano delle auto, dei camper, dei fuoristrada, delle barche, delle macchine agricole e delle macchine movimento terra, con fusibile da 3A e spina per accendisigari, fascio di luce ampio.



Scatola



Alimentazione	DC 9 ÷ 32 V (12 V, 24 V) 15 W
Numero dei LED	5 x 3 W
Flusso luminoso	1050 lm
Temperatura colore	6000 K
Distanza di illuminazione	5 m - 23 lux; 8,5 m - 10 lux m
Lunghezza cavo	2 m
Dimensione faro	108 x 108 mm
Dimensioni base	Ø 86,50 mm
Interasse dei fori posteriori	87 x 28 mm M6 mm
Dimensioni ingombro	108 x 86,50 x 160 mm

0713/27**€ 127,00****FARO A LED CON BASE MAGNETICA**

Da applicare sul tetto o sul cofano delle auto, dei camper, dei fuoristrada, delle barche, delle macchine agricole e delle macchine movimento terra, con fusibile 3A e spina per accendisigari, fascio di luce profondo.



Scatola



Alimentazione	DC 9 ÷ 32 V (12 V, 24 V) 27 W
Numero dei LED	9 x 3 W
Flusso luminoso	1890 lm
Temperatura colore	6000 K
Distanza di illuminazione	5 m - 85 lux; 15,5 m - 10 lux m
Lunghezza cavo	2 m
Dimensione faro	Ø 116 mm
Dimensioni base	Ø 86,50 mm
Interasse dei fori posteriori	87 x 28 mm M6 mm
Dimensioni ingombro	116 x 86,50 x 165 mm

0366**€ 127,00****LAMPADA A 56 LED**

Con lente.



Scatola



IP20

Alimentazione	230 V 50 Hz 8 W
Ingrandimenti	2x
Flusso luminoso	600 lm
Temperatura colore	6500 K
Lente	Ø 120 mm
Raggio d'azione	810 mm
Capacità morsetto	70 mm

0530
€ 131,00
LAMPADA A BASSO CONSUMO ENERGETICO

Con lente.



Scatola

Alimentazione	230 V 50 Hz 22 W
Ingrandimenti	3x
Lente	Ø 120 mm
Raggio d'azione	810 mm
Capacità morsetto	70 mm
Flusso luminoso	1000lm

0530A
€ 109,00 NEW
LAMPADA A BASSO CONSUMO ENERGETICO

Con lente.



Scatola

Alimentazione	250V 50 Hz 11W
Ingrandimenti	3x
Lente	127 mm
Capacità morsetto	75 mm
Flusso luminoso	1000 lm
Temperatura colore	6000 K

0891A
€ 153,00 NEW
LAMPADA A BASSO CONSUMO ENERGETICO

Lampada led con due lenti, pulsanti touch dimmerabili, 6 luci UV Led e un punto luce super luminoso e orientabile. Durata fino a 25.000 ore.



Alimentazione	250V 50 Hz 11W
Ingrandimenti	2x + 6x
Lente	138 mm
Capacità morsetto	75 mm
Flusso luminoso	1000 lm
Temperatura colore	6000 K

0516
€ 180,00
LAMPADA A BASSO CONSUMO ENERGETICO

Con lente.



Scatola

Alimentazione	230V 50Hz 2 x 9W
Ingrandimenti	2x
Lente	190 x 157 mm
Raggio d'azione	810 mm
Capacità morsetto	70 mm
Flusso luminoso	1000 lm

0344
€ 37,10
LAMPADA SNODATA

Con lente. Lampadina non inclusa.



Scatola

Alimentazione	230 V 50/60 Hz
Lampadina	Max 60 W, E27 - non inclusa
Ingrandimenti	2x
Lente	Ø 100 mm
Raggio d'azione	800 mm
Capacità morsetto	35 mm

0661
€ 55,70
LAMPADA DA TAVOLO

Con lente.



Scatola

Alimentazione	230 V 50 Hz 11 W
Ingrandimenti	2x
Lente	Ø 89 mm

0625 € 36,30

SET LENTI A VISIERA

Scatola

Moltiplicatore	Distanza del fuoco (mm)
1,2x	520 ÷ 620
1,8x	230 ÷ 320
2,5x	150 ÷ 250
3,5x	80 ÷ 120
Lampadina	2,2 V - 0,25 A
Batteria	2x AAA

L006 € 11,30

LENTE IN CRISTALLO CON LED

Scatola

Lente	50 x 50 mm
Ingrandimenti	3x
LED	5 - 9000 mcd
LED	1
Batteria	4x LR1130
Pack	10

0482/3 € 62,00

LAMPADA DA TESTA CON SENSORE

Funzione di accensione e spegnimento passando con la mano davanti alla lampada.



Scatola



LED	3 W COB
Flusso luminoso	Max 300 lm
Temperatura colore	6500 K
Batteria	3.7 V 1500 mAh Li-ion
Autonomia	4h
Tempo di ricarica	3h

0493/2 € 26,00

LUCE A LED DA CASCO

120lm, con fascia elastica regolabile, 2 funzionalità: luce fissa e lampeggiante, da utilizzare con 3 batterie di tipo AAA.



Scatola



Batterie non incluse	3 x AAA
Luminosità	120 lm
Misure	Ø 75 x 45 x 45 mm
Autonomia	5 h

0659 € 42,40

SERIE DI LENTI IN CRISTALLO

12 Pcs



Espositore

Contenuto	Ingrandimenti
3 Pz Ø 50	3x - 10x mm
3 Pz Ø 60	3x - 8x mm
3 Pz Ø 75	3x - 8x mm
3 Pz Ø 90	3x - 8x mm

0437 € 27,00

FARETTO A LED AD ALTA POTENZA

A lunga autonomia, distanza di illuminazione più di 150m.



Scatola

Batterie non incluse	4x C
Potenza LED	3 W
Autonomia	25 h / 100 %

0493/1 € 10,10

LUCE A LED DA CASCO

80lm, in ABS e rivestimento in gomma, con fascia elastica regolabile, 2 funzionalità: luce fissa e lampeggiante, da utilizzare con 3 batterie di tipo AAA.



Scatola



Batterie non incluse	3 x AAA
Luminosità	80 lm
Misure	Ø 50 x 42 x 58 mm
Autonomia	10 h

0209 € 41,30

LAMPADA MAGNETICA INCLINABILE CON 10 + 1 LED

Con testa rotante, Led in sommità e 10 Led frontali con 2 livelli di luminosità.



Blister

 Alu
Alluminio

IP20



Flusso luminoso	50 - 300 lm
Temperatura colore	6500 K
Batterie non incluse	3x AAA
Testa inclinabile	180°
Rotazione	180°
Dimensioni	35 x 330 mm

0128A € 8,60

TORCIA TASCABILE MAGNETICA LED COB + 1 LED

Con clip magnetico e girevole. Le piccole dimensioni e la grande luminosità la rendono indispensabile sia nel professionale che nel fai da te.



Misure	174 x 43 x 22 mm
Flusso luminoso	140 lm
Batterie non incluse	3x AAA

0787 € 23,20

TORCIA IN ALLUMINIO

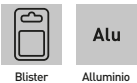

Batterie non incluse	2x C
Numero dei LED	8 LED 11000 mcd
Misure	Ø 48,5 x 31 x 215 mm

0107 € 8,70

LAMPADA MAGNETICA CON 30 + 7 LED

Con magnete e gancio nella parte posteriore.



Vita per singolo LED	100000 ore
Luminosità	50 lm
Batterie non incluse	3x AA
Dimensioni	40 x 35 x 203 mm

0291 € 10,10

LAMPADA MAGNETICA CON 24 + 3 LED

Con magnete e gancio nella parte posteriore.



Vita per singolo LED	100000 ore
Batterie non incluse	3x AAA

0671/1P € 7,70

TORCIA CON LED A LUCE BIANCA AD ALTA LUMINOSITÀ



Batterie non incluse	2x AAA
Numero dei LED	1 - 9000 mcd
Misure	Ø 12,5 x 141 mm

0492 € 13,00

TORCIA A LED CON MAGNETE TELESCOPICO

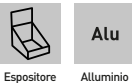

Batteria a bottone	4 x LR44
Numero dei LED	6
Luminosità	6 x 10 lm
Misure	Ø 30 x 21 x 180 mm
Lunghezza massima	710 mm
Autonomia	3 h

0311 € 12,30

LAMPADA MAGNETICA CON 24 LED

Con magnete e gancio nella parte posteriore.



Vita per singolo LED	100000 ore
Batterie non incluse	3x AA

0338 € 46,00

TORCIA IN ALLUMINIO CON 1 LED E FUNZIONE ZOOM MANUALE

3 tipi di luce: forte, media e lampeggiante; adattatore per funzionamento con 3 batterie di tipo AAA e scatola.



Batteria	1 li-ion 3.7V/ 1800 mAh
LED	Q3 3 W
Misure	Ø 34,5 x 28 x 135 mm
Carica batteria	110 / 230 V 50 / 60 Hz
Autonomia	4 h



0597

€ 31,90

LAMPADA A LED RICARICABILE

Con caricabatteria 12Vdc e 230Vac, pieghevole, appendibile e magnetica.



Scatola



Batteria	3.7 V 1800 mAh
LED	8 SMD + 5 LED
Tempo di ricarica	8 ÷ 10 h
Autonomia	7 ÷ 8 h



0889

€ 65,90

LAMPADA A LED RICARICABILE MAGNETICA

Con caricabatteria 12VDC e 230VAC, pieghevole, appendibile e magnetica.



Scatola



Batteria	3,7 V - 1100 mAh - Li-ion
LED	21 + 5 - 9000 mcd
Tempo di ricarica	4 ÷ 5 h
Autonomia	4 ÷ 6 h



0693A

€ 92,20

LAMPADA A LED RICARICABILE

Con postazione caricabatteria, pieghevole, appendibile e magnetica



Scatola



Batteria	3,7V - 2600mAh - Li-ion
LED	6W COB LED - 1W SMD 6500K
Flusso luminoso	600 lm
Tempo di ricarica	4h
Autonomia	4.5h Eco mode
Temperatura di esercizio	-10°C÷ 40°C



0401

€ 80,20

LAMPADA RICARICABILE CON TECNOLOGIA LED COB

Dorso magnetico per l'uso senza l'aiuto delle mani, appoggio flessibile e magnetico. Luce potente da 180 lumen.



Scatola



Alimentazione	100 ÷ 240 V, 50 ÷ 60 Hz
Batteria	3,7V - 2600 mAh - Li-ion
Tempo di ricarica	6 h
Autonomia	3,5 h
Luminosità	180 lm



0123

€ 67,60

FARO MULTIFUNZIONE A LED RICARICABILE CON USB

Dotato di torcia Led anteriore con vari livelli di luminosità, Led bianchi e rossi laterali con funzione lampeggio. Cavo di ricarica usb e trasformatore. Led di stato di carica e ricarica. Possibile ricarica direttamente dal computer.



Scatola



Batteria	3.7V - 1800 mAh - Li-ion
LED	24 Cree XPG R5
Luminosità	30 - 300 lm
Dimensioni	191 x 99 x 148 mm
Carica batteria	USB 110 - 230 V 50 - 60 Hz
Autonomia	2.5 h



G900

€ 16,00

TORCIA DA CAMPEGGIO

Scatola



Dimensioni	Ø 60 x 160 mm
Luminosità	150 lm
Batterie non incluse	3 x AA



L008

€ 139,00

LAMPADA LED RICARICABILE ULTRA SOTTILE

Batterie al litio ad alta capacità per lunga autonomia, luce potente da 400 lumen, il design sottile e la struttura robusta la rendono indistruttibile anche se cade da un metro di altezza o, se dimenticata su di un pavimento piano, l'auto ci passa sopra.



Scatola



Alimentazione	100 ÷ 240 V, 50 ÷ 60 Hz
Batteria	3,7V 2400mAh Lithium
Flusso luminoso	400 lm
Tempo di ricarica	3,5 h
Autonomia	3 - 10 h
Luminosità	400 lm



0445/20
€ 171,00
FARETTO A LED RICARICABILE

Con interruttore, ricarica auto con spina per accendisigari e alimentatore 230V da casa, robusto supporto orientabile.



Scatola

Alu

Alluminio

IP65

Alimentazione	DC 12 - 24 V, 20 W; AC 230 V 20W
Flusso luminoso	600 - 1450 lm
Batteria	7.4V 5400mAh Li-ion
Autonomia	1,5 h

0342
€ 18,30
LAMPADA AL NEON APPENDIBILE

Blister

IP20

Alimentazione	230 V 50 Hz 8 W
Dimensioni	ø 31 x 435 mm
Cavo	5 m

0900/BL
€ 258,00
LAMPADA LED MAGNETICA CON SUPPORTO SOTTOCOFANO ESTENSIBILE

La lampada sottocofano è composta da due punti luce Cob Led magnetici e ruotabili di 360°, per un massimo di 2800 lumen (1400lm + 1400lm) e da una barra estensibile fino a 2100 mm per adattarsi a qualsiasi tipologia di cofano.



Scatola

ABS
Alu

Alluminio

LED	COB
Alimentazione	USB Tipo C 5 V 2 A
Batteria	3.7 V 5200 mAh Li-ion
Flusso luminoso	2 x 400-1400 lm
Tempo di ricarica	4 h
Autonomia	4 h
Regolazione ganci a molla	850 ÷ 2100 mm

0429
€ 28,10
PORTALAMPADA CON CAVO DI ALIMENTAZIONE DI 5M

Senza interruttore, massimo 60 W per lampadine ad incandescenza, attacco lampadina E27 possibilità di funzione da 12V a 230V con lampadina dello stesso voltaggio; lampadina non inclusa.



Append.

Lunghezza cavo	5 m
Attacco lampadina	E27
Voltaggio	230 V

0900
€ 92,20
LAMPADA LED CON BASE MAGNETICA

Lampada COB Led portatile in ABS antiurto. La lampada LED è regolabile su quattro diverse intensità di luce da 350 a 1400 Lumen. La forte base magnetica e il corpo ruotabile di 180° la rendono adatta ad essere usata in ogni circostanza.

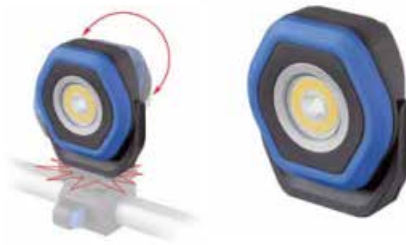

Scatola

Alu

Alluminio

LED	COB
Alimentazione	USB Tipo C 5 V 2 A
Batteria	3.7 V 5200 mAh Li-ion
Flusso luminoso	350 ÷ 1400 lm
Tempo di ricarica	4 h
Autonomia	3 h ÷ 14 h
Dimensioni	116 x 101 x 41.5 mm

0840
€ 131,00
LAMPADA A LED RICARICABILE MAGNETICA CON GANCI ESTENSIBILI

In ABS e policarbonato, 2 funzioni: 18 Led smd - 36 Led smd, con batteria al litio, ricarica auto con spina per accendisigari e alimentatore 230V da casa, indicatore stato della carica.



Scatola

ABS

Alimentazione	DC 12 V 7,2 W; AC 230V
Dimensioni lampada	ø 38 x 1080 mm
Regolazione ganci a molla	1210 ÷ 1950 mm
Batteria	7.4 V, 1800 mAh Lithium
Luminosità	900 lm, 36 SMD
Tempo di ricarica	4 - 5 h
Autonomia	3h



0621/A3
€ 117,00
AVVOLGICAVO AUTO RIENTRANTE

Protezione contro i sovraccarichi, Led sull'avvolgicavo che segnala se collegato alla rete elettrica.



Scatola

Lunghezza cavo	10 m
Tipo cavo	3 x 1,50 mm ² H05RR-F
Alimentazione	12 V ÷ 240 V
Massima potenza collegabile al cavo avvolto	1200 W
Massima potenza collegabile al cavo svolto	1800 W

A010-X
AVVOLGICAVO

Cavo doppio isolamento H05VV-F omologato spina pressofusa in PVC omologata con spinotti protetti, disgiuntore termico a ripristino manuale, max potenza prelevabile con cavo avvolto 1,2kw, max potenza prelevabile con cavo svolto 3,4kw.



Scatola

Art.	€	Lunghezza cavo	Sezione	Tamburo
A010/10	€ 43,20	10 m	3 x 1,5 mm ²	ø 200 mm
A010/20	€ 70,20	20 m	3 x 1,5 mm ²	ø 250 mm

A010/30T
€ 407,00
AVVOLGICAVO INDUSTRIALE

Costruito in riferimento alle norme EN 61316, cavo flessibile H07RN-F omologato in neoprene, prese IP 44, disgiuntore termico a ripristino manuale, max. potenza prelevabile con cavo avvolto 5kw, max. potenza prelevabile con cavo svolto 11kW.



Scatola

Alimentazione	380 V
Lunghezza cavo	30 m
Sezione	4 x 2,5 mm ²
Tamburo	ø 340 mm

0428
€ 124,00
AVVOLGICAVO AUTO RIENTRANTE CON PORTALAMPADA

Protezione contro i sovraccarichi, massimo 60 W per lampadine ad incandescenza, Led sull'avvolgicavo che segnala se collegato alla rete elettrica, lampadina non inclusa.



Scatola



Dimensioni cavo	13 + 1 m - H05RR-F - 2 x 1 mm ²
Attacco lampadina	E27
Voltaggio	12 ÷ 230 V

A010-
AVVOLGICAVO

Costruiti in riferimento alle norme EN 61242, cavo doppio isolamento H05VV-F omologato spina pressofusa in PVC omologata con spinotti protetti, disgiuntore termico a ripristino manuale, max potenza prelevabile con cavo avvolto 1,2kw, max potenza prelevabile con cavo svolto 3,4kw.



Scatola

Art.	€	Lunghezza cavo	Sezione	Tamburo
A010/15	€ 62,90	15 m	3 x 1,5 mm ²	ø 190 mm
A010/25	€ 91,00	25 m	3 x 1,5 mm ²	ø 240 mm
A010/50	€ 162,00	50 m	3 x 1,5 mm ²	ø 310 mm

A010/30
€ 296,00
AVVOLGICAVO INDUSTRIALE

Costruito in riferimento alle norme EN 61316, cavo flessibile H07RN-F omologato in neoprene, prese IP 44, disgiuntore termico a ripristino manuale, max. potenza prelevabile con cavo avvolto 5kw, max. potenza prelevabile con cavo svolto 11kW.







Scatola

Alimentazione	230 V
Lunghezza cavo	30 m
Sezione	3 x 2,5 mm ²
Tamburo	ø 340 mm



**CALIBRI, TRUSCHINI
E RIGHE**

- p. 554  Calibri digitali
- p. 555  Calibri con comparatore
- p. 555  Calibri vernier
- p. 559  Truschini
- p. 559  Righe digitali

COMPARATORI

- p. 560  Comparatori digitali e analogici
- p. 562  Misuratori di spessore
- p. 563  Centratori

MICROMETRI

- p. 564  Micrometri per esterni
- p. 565  Micrometri per interni

**BLOCCHETTI, ANELLI
E TAMPONI**

- p. 566  Blocchetti di riscontro
- p. 567  Anelli e tamponi

**ACCESSORI PER
LA MISURAZIONE**

- p. 569  Basi magnetiche e supporti
- p. 572  Piani di riscontro
- p. 572  Squadre
- p. 574  Spessimetri e contafiletti

**FLESSOMETRI, LIVELLE E
GONIOMETRI**

- p. 577  Flessometri
- p. 578  Livelle
- p. 580  Goniometri

**MISURATORI
ANALOGICI E DIGITALI**

- p. 581  Endoscopi e Microscopi
- p. 582  Pinze amperometriche e multimetri
- p. 583  Misuratori digitali
- p. 587  Rifrattometri
- p. 588  Durometri

**BILANCE E
DINAMOMETRI**

- p. 590  Bilance
- p. 591  Dinamometri

C031/150
€ 193,00
CALIBRO ELETTRONICO DIGITALE INOX

A 2 funzioni con schermo grande.



Utile	0÷150 mm 0÷6"
Lettura	0,01 mm 0,0005"
Becchi	40 mm
Asta	16 x 3 mm
Batteria	1 x LR44

C035-
CALIBRO ELETTRONICO DIGITALE INOX

Con scala di misurazione in vetro per una migliore precisione, carcassa e pulsanti in metallo, uscita dati con porta mini USB, rotella di posizionamento rimovibile, becchi di misurazione rettificati e lappati, con vite di bloccaggio.



Art.	€	Utile	Lettura	Precisione	Ripetibilità	Asta	Becchi	Becchi da interni	Batteria	Altezza cifre
C035/150	€ 75,90	0÷150 mm 0÷6"	0,01 mm 0,0005"	0,02 mm	0,01 mm	16 x 3 mm	40 mm	16,5 mm	1 x 3V CR2032	9 mm
C035/200	€ 104,00	0÷200 mm 0÷8"	0,01 mm 0,0005"	0,03 mm	0,01 mm	16 x 3 mm	50 mm	19,5 mm	1 x 3V CR2032	9 mm
C035/300	€ 182,00	0÷300 mm 0÷12"	0,01 mm 0,0005"	0,03 mm	0,01 mm	16 x 3 mm	60 mm	20,5 mm	1 x 3V CR2032	9 mm

C033-
CALIBRO ELETTRONICO DIGITALE INOX

A 3 funzioni con schermo grande.



Art.	€	Utile	Lettura	Asta	Becchi	Batteria
C033/150	€ 66,90	0÷150 mm 0÷6"	0,01 mm 0,0005"	16 x 3,2 mm	40 mm	1 x LR44
C033/200	€ 97,40	0÷200 mm 0÷8"	0,01 mm 0,0005"	16 x 3,2 mm	50 mm	1 x LR44
C033/300	€ 145,00	0÷300 mm 0÷12"	0,01 mm 0,0005"	16 x 3,2 mm	60 mm	1 x LR44

C041/150
€ 37,50
CALIBRO ELETTRONICO DIGITALE MONOBLOCCO INOX

A 3 funzioni con schermo grande.



Utile	0÷150 mm 0÷6"
Lettura	0,01 mm 0,0005"
Becchi	40 mm
Asta	16 x 3 mm
Batteria	1 x LR44



**C043-****CALIBRO ELETTRONICO DIGITALE INOX**

A 4 funzioni con schermo grande, regolazione micrometrica.



Art.	€	Utile	Lettura	Becchi	Asta	Batteria
C043/500	€ 357,00	0÷500 mm 0÷20"	0,01 mm 0,0005"	100 mm	25 x 6 mm	1 x LR44
C043/1000	€ 713,00	0÷1000 mm 0÷40"	0,01 mm 0,0005"	150 mm	30 x 8 mm	1 x LR44

C005/150**€ 58,90****CALIBRO CON COMPARATORE INOX**

Utile	0 ÷ 150 mm
Lettura	0,01 mm
Becchi	40 mm
Asta	15,5 x 3 mm

C006-**CALIBRO CON COMPARATORE INOX**

Art.	€	Utile	Lettura	Becchi	Asta
C006/150	€ 52,80	0 ÷ 150 mm	0,02 mm	40 mm	16 x 3 mm
C006/200	€ 80,40	0 ÷ 200 mm	0,02 mm	50 mm	16 x 3 mm
C006/300	€ 131,00	0 ÷ 300 mm	0,02 mm	60 mm	20 x 4 mm

C018-**CALIBRO MONOBLOCCO INOX CROMATO OPACO**

Art.	€	Utile	Lettura	Becchi	Asta
C018/150	€ 39,70	0÷150 mm 0÷6"	1/20 0,05 mm 1/128"	40 mm	16 x 3 mm
C018/200	€ 61,80	0÷200 mm 0÷8"	1/50 0,02 mm 1/1000"	50 mm	16 x 3 mm

C057/150
€ 22,80
CALIBRO SATINATO

Scatola 862

Utile	0÷150 mm 0÷6"
Lettura	1/20 0,05 mm 1/128"
Becchi	40 mm
Asta	16 x 3 mm

C011-
CALIBRO MONOBLOCCO INOX CROMATO OPACO

Alta precisione, con rotellina per bloccaggio cursore, campo di misurazione 0 – 200 mm.



Scatola 862

Art.	€	Utile	Lettura	Becchi	Asta
C011/150	€ 43,30	0÷150 mm 0÷6"	1/50 0,02 mm 1/1000"	40 mm	16 x 3 mm
C011/200	€ 71,80	0÷200 mm 0÷8"	1/50 0,02 mm 1/1000"	50 mm	16 x 3 mm

C019/150
€ 18,10
CALIBRO SATINATO

Scatola 862

Utile	0÷150 mm 0÷6"
Lettura	1/20 0,05 mm 1/128"
Becchi	40 mm
Asta	16 x 3 mm

C056/200
€ 31,70
CALIBRO SATINATO

Scatola 862

Utile	0÷200 mm 0÷8"
Lettura	1/50 0,02 mm 1/1000"
Becchi	50 mm
Asta	16,5 x 3,5 mm



**C049/300**

€ 31,70

CALIBRO SATINATO

Registrazione micrometrica.



Scatola 862

Utile	0 ÷ 300 mm
Lettura	1/50 - 0,02 mm
Becchi	60 mm
Asta	20 x 4 mm

**C021-****CALIBRO MONOBLOCCO SATINATO INOX**

Registrazione micrometrica.



Scatola 862

Art.	€	Utile	Lettura	Becchi	Asta
C021/300	€ 188,00	0÷300 mm 0÷12"	1/50 0,02 mm 1/1000"	100 mm	23 x 6 mm
C021/500	€ 258,00	0÷500 mm 0÷20"	1/50 0,02 mm 1/1000"	150 mm	23 x 6 mm
C021/1000	€ 576,00	0÷1000 mm 0÷40"	1/50 0,02 mm 1/1000"	150 mm	32 x 8 mm

**C020-****CALIBRO SATINATO**

Registrazione micrometrica.



Scatola 862

Art.	€	Utile	Lettura	Becchi	Asta
C020/500	€ 162,00	0 ÷ 500 mm	1/50 0,02 mm	100 mm	23 x 6 mm
C020/1000	€ 401,00	0 ÷ 1000 mm	1/50 0,02 mm	150 mm	30 x 8 mm
C020/1500	€ 1120,00	0 ÷ 1500 mm	1/50 0,02 mm	225 mm	49 x 14 mm
C020/2000	€ 1810,00	0 ÷ 2000 mm	1/50 0,02 mm	250 mm	50 x 15 mm

**C044-****CALIBRO ELETTRONICO DIGITALE INOX DI PROFONDITÀ**

A 3 funzioni con schermo grande.



Scatola 862

Art.	€	Utile	Lettura	Base	Asta	Peso batteria (Kg)	Batteria
C044/200	€ 94,50	0÷200 mm 0÷8"	0,01 mm 0,0005"	100 mm	13 x 3,5 mm	0,002	1 x LR44
C044/300	€ 162,00	0÷300 mm 0÷12"	0,01 mm 0,0005"	150 mm	15 x 4 mm	0,002	1 x LR44



C007-

CALIBRO DI PROFONDITÀ SATINATO



Art.	€	Utile	Letture	Base	Asta
C007/200	€ 40,90	0 ÷ 200 mm	1/50 0,02 mm	100 mm	9,6 x 4,5 mm
C007/300	€ 56,20	0 ÷ 300 mm	1/50 0,02 mm	100 mm	12 x 4 mm

C010/200

€ 59,10

CALIBRO PER TRACCIATURA MONOBLOCCO SATINATO

C010/200P € 8,70

SET 2 PUNTE PER CALIBRO C010/200



Utile	0÷200 mm 0÷8"
Letture	1/10 0,1 mm 1/64"
Becchi	10 mm
Asta	16 x 3 mm



CF08

€ 9,20

CALIBRO PER MISURA INTERASSE FORI DADI RUOTA

Utile per la misurazione della distanza dei fori di fissaggio del cerchio.
Per cerchi con 4, 5, 6 e 8 fori.



Utile	4-8 LUG 100 ÷ 210 mm
-------	----------------------



T092-
TRUSCHINO DIGITALE MULTIFUNZIONE

A 4 funzioni con schermo grande, con punta a tracciare.



Scatola

Art.	€	Campo di misura	Letture	Precisione	Peso netto	Batteria
T092/300	€ 595,00	0÷300 mm 0÷12"	0,01 mm 0,0005"	0,03 mm 0,015"	4 kg	1x 3V CR2032
T092/600	€ 989,00	0÷600 mm 0÷24"	0,01 mm 0,0005"	0,05 mm 0,025"	9 kg	1x 3V CR2032

T100-
TRUSCHINO IN ACCIAIO CROMATO OPACO

Con punta a tracciare.



Scatola

Art.	€	Campo di misura	Letture	Peso netto
T100/300	€ 121,00	0 ÷ 300 mm	0,02 mm	2 kg
T100/500	€ 239,00	0 ÷ 500 mm	0,02 mm	5,5 kg

Rx
RIGA CON DISPLAY DIGITALE MULTIFUNZIONE

La riga può essere tagliata per utilizzare la lunghezza desiderata. Funzioni: on/off - mm/inch - zero - abs/inc - autospegnimento.



Scatola

Art.	€	Lunghezza totale	Utile	Letture	Batteria
R060	€ 90,00	630 mm - 24.8" inch	500 mm - 19.7"	0,01 mm 0.001"	2 x 3 V CR2032
R100	€ 117,00	1000 mm - 40" inch	900 mm - 35"	0,01 mm 0.001"	2 x 3 V CR2032

C064 € 115,00
COMPARATORE DIGITALE CENTESIMALE MULTIFUNZIONE

Funzioni principali: azzeramento in ogni posizione, conversione mm/inch memoria e ricerca del valore min/max, spegnimento automatico.



Scatola 878

Campo di misura	0÷12,7 mm 0÷0,5"
Risoluzione	0,01 mm 0,0005"
Precisione	0,02 mm 0,002"
Diametro quadrante	60 mm
Batteria	1x SR44W

C004 € 94,90
COMPARATORE MILLESIMALE

Scatola 878

Diametro quadrante	60 mm
Campo di misura	0 ÷ 1 mm
Letture	0,001 mm
Precisione	0,002 mm

C002 € 57,10
COMPARATORE CENTESIMALE

Scatola 878

Diametro quadrante	60 mm
Campo di misura	10 mm
Letture	0,01 mm
Precisione	0,015 mm

C023G € 22,10
COMPARATORE CENTESIMALE

Scatola 878

Diametro quadrante	60 mm
Campo di misura	10 mm
Letture	0,01 mm
Precisione	0,015 mm

C060 € 241,00
COMPARATORE DIGITALE MILLESIMALE MULTIFUNZIONE

Funzioni principali: azzeramento in ogni posizione, conversione mm/inch, memoria e ricerca del valore min-max, spegnimento automatico.



Scatola 878

Utile	0÷2,40 mm 0÷0,094"
Letture	0,01 mm 0,0005"
Dimensioni piatto	Ø 24 mm
Altezza cifre	8 mm
Batteria	1 x 3V CR2032
Dimensioni	Ø 50 x 51 mm

C017 € 65,70
COMPARATORE CENTESIMALE ANTIURTO

Con movimento su rubini e resistente agli spruzzi d'acqua, con nasello.



Scatola 878

Diametro quadrante	55 mm
Campo di misura	10 mm
Letture	0,01 mm
Precisione	0,015 mm

C023 € 33,50
COMPARATORE CENTESIMALE

Scatola 878

Diametro quadrante	60 mm
Campo di misura	10 mm
Letture	0,01 mm
Precisione	0,015 mm

C023/N € 37,90
COMPARATORE CENTESIMALE

Scatola 878

Diametro quadrante	60 mm
Campo di misura	10 mm
Letture	0,01 mm
Precisione	0,015 mm





C002/42

€ 41,20

COMPARATORE CENTESIMALE



Scatola 878

Diametro quadrante	42 mm
Campo di misura	5 mm
Letture	0,01 mm
Precisione	0,015 mm

T003-

INDICATORE A TASTO CENTESIMALE



Scatola 2270

Art.	€	Diametro quadrante	Campo di misura	Letture	Precisione	Punta tastatrice
T003	€ 101,00	32 mm	0,8 mm	0,01 mm	0,015 mm	Ø 2 mm
T003G	€ 60,10	32 mm	0,8 mm	0,01 mm	0,008 mm	Ø 2 mm

C048

€ 80,50

COMPARATORE CENTESIMALE

Con nasello.



Scatola 878

Diametro quadrante	60 mm
Campo di misura	30 mm
Letture	0,01 mm
Precisione	0,015 mm

T007-

INDICATORE A TASTO CENTESIMALE



Scatola

Art.	€	Diametro quadrante	Campo di misura	Letture	Precisione	Punta tastatrice
T007	€ 102,00	40 mm	0,8 mm	0,01 mm	0,011 mm	Ø 2 mm
T007G	€ 65,20	40 mm	0,8 mm	0,01 mm	0,008 mm	Ø 2 mm

T006

€ 109,00

INDICATORE A TASTO CENTESIMALE CON TASTATORE LUNGO



Scatola 2270

Diametro quadrante	40 mm
Campo di misura	0,8 mm
Letture	0,01 mm
Precisione	0,011 mm
Punta tastatrice	Ø 2 mm
Lunghezza punta tastatrice	29 mm

T005

€ 121,00

INDICATORE A TASTO BIMILLESIMALE



Scatola 2270

Diametro quadrante	32 mm
Campo di misura	0,2 mm
Letture	0,002 mm
Precisione	0,005 mm
Punta tastatrice	Ø 2 mm

T011

€ 92,60

INDICATORE A TASTO CENTESIMALE



Scatola 2270

Diametro quadrante	32 mm
Campo di misura	0,8 mm
Letture	0,01 mm
Precisione	0,011 mm
Punta tastatrice	Ø 2 mm

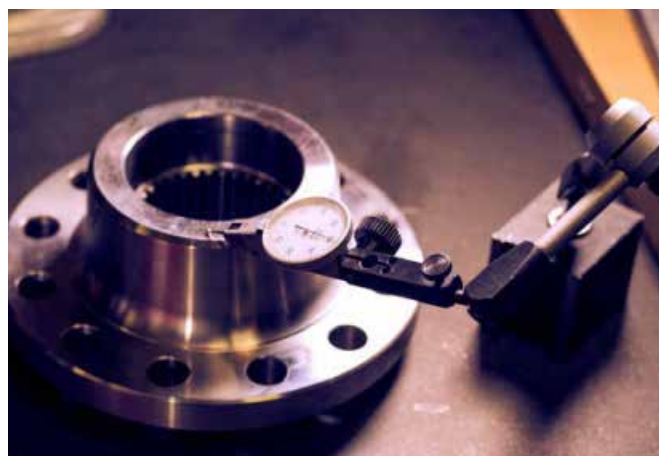

A016-

ALESAMETRO CON COMPARATORE



Scatola

Art.	€	Campo di misura	Letture	Profondità foro
A016/6/10	€ 156,00	6 ÷ 10 mm	0,01 mm	40 mm
A016/10/18	€ 161,00	10 ÷ 18 mm	0,01 mm	100 mm
A016/18/35	€ 161,00	18 ÷ 35 mm	0,01 mm	125 mm
A016/35/50	€ 161,00	35 ÷ 50 mm	0,01 mm	150 mm
A016/50/160	€ 161,00	50 ÷ 160 mm	0,01 mm	150 mm
A016/160/250	€ 180,00	160 ÷ 250 mm	0,01 mm	400 mm
A016/250/450	€ 204,00	250 ÷ 450 mm	0,01 mm	400 mm

M055/120

€ 105,00

MISURATORE DI SPESSORI



Scatola

Campo di misura	0 ÷ 10 mm
Letture	0,01 mm
Profondità di misurazione	120 mm

C016

€ 172,00

MISURATORE DI PROFONDITÀ



Scatola

Campo di misura	0 ÷ 110 mm
Corsa comparatore	0 ÷ 10 mm
Dimensioni base	63 x 17 mm
Letture	0,01 mm
Prolunghe	10 pz

M062

€ 26,10

MISURATORE DI SPESSORI DIGITALE



Scatola

Campo di misura	0 ÷ 12 mm - 0 ÷ 0,5"
Letture	0,01 mm 0,0005"
Profondità di misurazione	20 mm
Precisione	±0,1 mm 0,004"
Batteria	1 x LR44

M055

€ 69,10

MISURATORE DI SPESSORI



Scatola

Campo di misura	0 ÷ 10 mm
Letture	0,01 mm
Profondità di misurazione	9 ÷ 16 mm

C014-

MISURATORE RAPIDO PER INTERNI



Scatola

Art.	€	Campo di misura	Bracci	Tastatori	Letture
C014/15/35	€ 156,00	15 ÷ 35 mm	50 mm	Ø 3 x 3 mm	0,01 mm
C014/35/55	€ 156,00	35 ÷ 55 mm	80 mm	Ø 3 x 6 mm	0,01 mm
C014/55/75	€ 156,00	55 ÷ 75 mm	80 mm	Ø 3 x 6 mm	0,01 mm
C014/75/95	€ 156,00	75 ÷ 95 mm	100 mm	Ø 3 x 8 mm	0,01 mm

A020

€ 147,00

AZZERZATORE CON COMPARATORE CON BASE MAGNETICA



Scatola

Altezza di azzeramento	50 mm
Letture	0,01 mm
Utile	0 ÷ 8 mm

**A021**

€ 136,00

AZZERZATORE CON COMPARATORE CON BASE MAGNETICA

Per posizionare o azzerare l'altezza degli utensili, come frese a candela, direttamente sulle macchine utensili, determinando anche la posizione del mandrino della macchina.



Scatola

Utile	0±2,40 mm 0±0,094"
Letture	0,01 mm 0,0005"
Dimensioni piatto	Ø 24 mm
Altezza cifre	8 mm
Batteria	1 x 3V CR2032
Dimensioni	Ø 50 x 51 mm

C061

€ 249,00

CENTRATORE A 2 ASSI

Con asta di posizionamento.



Scatola

Comparatore	Ø 40 mm
Corsa	4,9 mm
Letture	0,01 mm
Velocità max di utilizzo	800 rpm
Attacco cilindrico	Ø 10 mm
Tastatori dritti	3
Tastatori curvi	3
Lunghezza tastatori	50 - 100 - 150 mm
Punta tastatrice	Ø 3 mm
Tracciatore snodato	50 mm

C062

€ 41,20

CENTRATORE MECCANICO A MOLLA

Scatola

Gambo	Ø 10 mm
Tastatori	Ø 4 - 10 mm

C063

€ 78,90

CENTRATORE LUMINOSO

Scatola

Gambo	Ø 20 mm
Tastatore	Ø 10 mm
Lunghezza totale	100 mm
Alimentazione	2 x SR44W

C063/L

€ 96,50

CENTRATORE LUMINOSO E SONORO

Con segnale sonoro.



Scatola

Gambo	Ø 20 mm
Tastatore	Ø 10 mm
Lunghezza totale	160 mm
Alimentazione	2 x LR1 1.5 V

M021-
MICROMETRO DIGITALE ELETTRONICO

Con frizione sul tamburo, contatti in metallo duro, funzioni: abs/inc, set, on/off e mm/inch.



Art.	€	Misura	Letture	Precisione
M021/00/25	€ 101,00	0 ÷ 25 mm - 0 ÷ 1"	0,001 mm - 0,00005"	0,003 mm - 0,00015"
M021/25/50	€ 126,00	25 ÷ 50 mm - 1" ÷ 2"	0,001 mm - 0,00005"	0,003 mm - 0,00015"
M021/50/75	€ 153,00	50 ÷ 75 mm - 2" ÷ 3"	0,001 mm - 0,00005"	0,004 mm - 0,0002"
M021/75/100	€ 178,00	75 ÷ 100 mm - 3" ÷ 4"	0,001 mm - 0,00005"	0,004 mm - 0,0002"

M026-
MICROMETRO DIGITALE ELETTRONICO

Con frizione sul tamburo con contatti in metallo duro.



Art.	€	Misura	Letture	Precisione
M026/0/25	€ 196,00	0 ÷ 25 mm - 0 ÷ 1"	0,001 mm 0,0001"	0,0002 mm 0,00008"
M026/25/50	€ 246,00	25 ÷ 50 mm - 1" ÷ 2"	0,001 mm 0,0001"	0,0002 mm 0,00008"
M026/50/75	€ 264,00	50 ÷ 75 mm - 2" ÷ 3"	0,001 mm 0,0001"	0,0003 mm 0,00012"
M026/75/100	€ 293,00	75 ÷ 100 mm - 3" ÷ 4"	0,001 mm 0,0001"	0,0003 mm 0,00012"

M022-
MICROMETRO CENTESIMALE PER ESTERNI

Con tamburo grande a 100 divisioni con contatti in metallo duro e frizione sul tamburo.



Art.	€	Misura	Letture	Precisione
M022/00/25	€ 74,40	0 ÷ 25 mm	0,01 mm	0,004 mm
M022/25/50	€ 92,50	25 ÷ 50 mm	0,01 mm	0,004 mm
M022/50/75	€ 109,00	50 ÷ 75 mm	0,01 mm	0,005 mm
M022/75/100	€ 125,00	75 ÷ 100 mm	0,01 mm	0,005 mm

M033
€ 216,00
ASSORTIMENTO MICROMETRI CENTESIMALI PER ESTERNI

Con contatti in metallo duro e arco verniciato.



Misura	0÷25 - 25÷50 - 50÷75 - 75÷100 - 100÷125 - 125÷150 mm
Letture	0,01 mm
Precisione	0,004 - 0,004 - 0,005 - 0,005 - 0,006 - 0,006 mm
Stelo	Ø 6,3 mm

M033-
MICROMETRO CENTESIMALE PER ESTERNI

Con contatti in metallo duro e arco verniciato.



Art.	€	Misura	Letture	Stelo
M033/00/25	€ 27,20	0÷25 mm	0,01 mm	Ø 6,3 mm
M033/25/50	€ 38,20	25÷50 mm	0,01 mm	Ø 6,3 mm
M033/50/75	€ 42,70	50÷75 mm	0,01 mm	Ø 6,3 mm
M033/75/100	€ 47,30	75÷100 mm	0,01 mm	Ø 6,3 mm

M033-x
MICROMETRO CENTESIMALE PER ESTERNI

Con contatti in metallo duro e arco verniciato.



Art.	€	Misura	Letture	Stelo
M033/100/125	€ 50,60	100÷125 mm	0,01 mm	Ø 6,3 mm
M033/125/150	€ 54,00	125÷150 mm	0,01 mm	Ø 6,3 mm
M033/150/175	€ 64,50	150÷175 mm	0,01 mm	Ø 6,3 mm
M033/175/200	€ 73,50	175÷200 mm	0,01 mm	Ø 6,3 mm
M033/200/225	€ 85,30	200÷225 mm	0,01 mm	Ø 6,3 mm
M033/225/250	€ 104,00	225÷250 mm	0,01 mm	Ø 6,3 mm
M033/250/275	€ 107,00	250÷275 mm	0,01 mm	Ø 6,3 mm
M033/275/300	€ 121,00	275÷300 mm	0,01 mm	Ø 6,3 mm



M009-

MICROMETRO CENTESIMALE PER ESTERNI

Con contatti in metallo duro, arco verniciato.



Scatola

HM



863

Art.	€	Misura	Letture	Stelo
M009/300/400	€ 371,00	300 ÷ 400 mm	0,01 mm	ø 6,5 mm
M009/400/500	€ 405,00	400 ÷ 500 mm	0,01 mm	ø 6,5 mm
M009/500/600	€ 467,00	500 ÷ 600 mm	0,01 mm	ø 6,5 mm
M009/600/700	€ 556,00	600 ÷ 700 mm	0,01 mm	ø 6,5 mm
M009/700/800	€ 667,00	700 ÷ 800 mm	0,01 mm	ø 6,5 mm
M009/800/900	€ 770,00	800 ÷ 900 mm	0,01 mm	ø 6,5 mm
M009/900/1000	€ 915,00	900 ÷ 1000 mm	0,01 mm	ø 6,5 mm
M009/1000/1200	€ 1350,00	1000 ÷ 1200 mm	0,01 mm	ø 6,5 mm

M019-

MICROMETRO A TRE PUNTE PER INTERNI, PER FORI CIECHI



Scatola

Art.	€	Anello	Misura	Letture	Precisione
M019/06/08	€ 414,00	1	6 ÷ 8 mm	0,001 mm	0,004 mm
M019/08/10	€ 414,00	1	8 ÷ 10 mm	0,001 mm	0,004 mm
M019/10/12	€ 414,00	1	10 ÷ 12 mm	0,001 mm	0,004 mm
M019/12/16	€ 387,00	1	12 ÷ 16 mm	0,005 mm	0,004 mm
M019/16/20	€ 387,00	1	16 ÷ 20 mm	0,005 mm	0,004 mm
M019/20/25	€ 416,00	1	20 ÷ 25 mm	0,005 mm	0,004 mm
M019/25/30	€ 416,00	1	25 ÷ 30 mm	0,005 mm	0,004 mm
M019/30/40	€ 458,00	1	30 ÷ 40 mm	0,005 mm	0,004 mm
M019/40/50	€ 545,00	1	40 ÷ 50 mm	0,005 mm	0,005 mm
M019/50/63	€ 556,00	1	50 ÷ 63 mm	0,005 mm	0,005 mm
M019/62/75	€ 616,00	1	62 ÷ 75 mm	0,005 mm	0,005 mm
M019/75/88	€ 623,00	1	75 ÷ 88 mm	0,005 mm	0,005 mm
M019/87/100	€ 623,00	1	87 ÷ 100 mm	0,005 mm	0,005 mm
M019/100/125	€ 693,00	0	100 ÷ 125 mm	0,005 mm	0,005 mm
M019/125/150	€ 766,00	0	125 ÷ 150 mm	0,005 mm	0,005 mm

M010-

MICROMETRO A PIATTELLO

Arco verniciato.



Scatola



863

Art.	€	Misura	Letture	Piattelli
M010/0/25	€ 116,00	0 ÷ 25 mm	0,01 mm	Ø 20 mm
M010/25/50	€ 143,00	25 ÷ 50 mm	0,01 mm	Ø 20 mm
M010/50/75	€ 150,00	50 ÷ 75 mm	0,01 mm	Ø 20 mm
M010/75/100	€ 158,00	75 ÷ 100 mm	0,01 mm	Ø 20 mm
M010/100/125	€ 202,00	100 ÷ 125 mm	0,01 mm	Ø 27 mm
M010/125/150	€ 229,00	125 ÷ 150 mm	0,01 mm	Ø 27 mm
M010/150/175	€ 255,00	150 ÷ 175 mm	0,01 mm	Ø 27 mm
M010/175/200	€ 269,00	175 ÷ 200 mm	0,01 mm	Ø 27 mm

M019-x

ASSORTIMENTO MICROMETRI A TRE PUNTE PER INTERNI, PER FORI CIECHI



Valigetta

Art.	€	Micrometri	Anelli	Misura	Letture	Precisione
M019/06/12	€ 1080,00	3	3	6 ÷ 12 mm	0,001 mm	0,004 mm
M019/12/20	€ 587,00	2	1	12 ÷ 20 mm	0,005 mm	0,004 mm
M019/20/40	€ 1140,00	3	2	20 ÷ 40 mm	0,005 mm	0,004 mm
M019/40/100	€ 2510,00	5	3	40 ÷ 100 mm	0,005 mm	0,005 mm

M013/0/100

€ 132,00

MICROMETRO CENTESIMALE DI PROFONDITÀ



Valigetta

Campo di misura	0÷25 mm, 25÷50 mm, 50÷75 mm, 75÷100 mm
Letture	0,01 mm
Base	100 x 17 mm

B0x
SERIE BLOCCHETTI DI RISCONTRO PIANO PARALLELI IN ACCIAIO LAPPATO

Certificato di collaudo emesso dalla fabbrica, certificato Accredia a richiesta.



Valigetta



3650

Art.	€	Grado	Pezzi	Misura nominale (mm)	Progressione (mm)	Pz per passo
B008/1	€ 1130,00	1	8	25 - 50 - 75 - 100 - 250 - 300 - 400 - 500	-	1
B011/0	€ 233,00	0	11	2,5 - 5,1 - 7,7 - 10,3 - 12,9 - 15 - 17,6 - 20,2 - 22,8 - 23,4 - 25	-	1
B032/0	€ 471,00	0	32	1,005	-	1
				1,01±1,09	-	9
				1,1±1,9	0,01	9
				1±9	0,1	9
				10 - 20 - 30 - 50	1	4
B032/1	€ 292,00	1	32	1,005	-	1
				1,01±1,09	-	9
				1,1±1,9	0,01	9
				1±9	0,1	9
				10 - 20 - 30 - 50	1	4
B032/2	€ 163,00	2	32	1,005	-	1
				1,01±1,09	-	9
				1,1±1,9	0,01	9
				1±9	0,1	9
				10 - 20 - 30 - 50	1	4
B047/0	€ 669,00	0	47	1,005	-	1
				1,01±1,2	0,01	20
				1,3±1,9	0,1	7
				1±9	1	9
				10±100	10	10
B047/1	€ 396,00	1	47	1,005	-	1
				1,01±1,2	0,01	20
				1,3±1,9	0,1	7
				1±9	1	9
				10±100	10	10
B047/2	€ 235,00	2	47	1,005	-	1
				1,01±1,2	0,01	20
				1,3±1,9	0,1	7
				1±9	1	9
				10±100	10	10
B087/0	€ 1120,00	0	87	1,001±1,009	0,001	9
				1,01±1,49	0,01	49
				0,5±9,5	0,5	19
				10±100	10	10
				B087/1	€ 597,00	1
1,01±1,49	0,01	49				
0,5±9,5	0,5	19				
10±100	10	10				
B087/2	€ 365,00	2	87			
				1,01±1,49	0,01	49
				0,5±9,5	0,5	19
				10±100	10	10
				B103/0	€ 1280,00	0
1,01±1,49	0,01	49				
0,5±24,5	0,5	49				
25±100	25	4				
B103/1	€ 792,00	1	103			
				1,01±1,49	0,01	49
				0,5±24,5	0,5	49
				25±100	25	4
				B103/2	€ 447,00	2
1,01±1,49	0,01	49				
0,5±24,5	0,5	49				
25±100	25	4				
B112/0	€ 1120,00	0	112			
				1,001 ± 1,009	0,001	9
				1,01 ± 1,49	0,01	49
				0,5 ± 24,5	0,5	49
				25 ± 100	25	4
B112/1	€ 791,00	1	112	1,005	-	1
				1,001 ± 1,009	0,001	9
				1,01 ± 1,49	0,01	49
				0,5 ± 24,5	0,5	49
				25 ± 100	25	4



C025-

CALIBRO TAMPONE LISCIO H7 P/NP TEMPERATO E CEMENTATO



Art.	€	Ø	Pezzi
C025/03	€ 37,60	3 mm	1
C025/04	€ 37,60	4 mm	1
C025/05	€ 37,60	5 mm	1
C025/06	€ 37,60	6 mm	1
C025/07	€ 37,60	7 mm	1
C025/08	€ 37,60	8 mm	1
C025/09	€ 37,60	9 mm	1
C025/10	€ 37,60	10 mm	1
C025/11	€ 46,60	11 mm	1
C025/12	€ 46,60	12 mm	1
C025/13	€ 46,60	13 mm	1
C025/14	€ 46,60	14 mm	1
C025/15	€ 46,60	15 mm	1
C025/16	€ 46,60	16 mm	1
C025/17	€ 46,60	17 mm	1
C025/18	€ 46,60	18 mm	1
C025/19	€ 46,60	19 mm	1
C025/20	€ 46,60	20 mm	1
C025/21	€ 69,80	21 mm	1
C025/22	€ 69,80	22 mm	1
C025/23	€ 69,80	23 mm	1
C025/24	€ 69,80	24 mm	1
C025/25	€ 69,80	25 mm	1
C025/26	€ 69,80	26 mm	1
C025/27	€ 69,80	27 mm	1
C025/28	€ 69,80	28 mm	1
C025/29	€ 69,80	29 mm	1
C025/30	€ 87,50	30 mm	1
C025/32	€ 87,50	32 mm	1
C025/33	€ 87,50	33 mm	1
C025/34	€ 87,50	34 mm	1
C025/35	€ 87,50	35 mm	1
C025/36	€ 87,50	36 mm	1
C025/37	€ 87,50	37 mm	1
C025/38	€ 87,50	38 mm	1
C025/40	€ 87,50	40 mm	1
C025/42	€ 87,50	42 mm	1
C025/44	€ 87,50	44 mm	1
C025/45	€ 98,30	45 mm	1
C025/46	€ 98,40	46 mm	1
C025/47	€ 98,40	47 mm	1
C025/48	€ 98,40	48 mm	1
C025/50	€ 98,40	50 mm	1
C025/51	€ 106,00	51 mm	1
C025/52	€ 106,00	52 mm	1
C025/55	€ 106,00	55 mm	2
C025/56	€ 106,00	56 mm	2
C025/57	€ 106,00	57 mm	2
C025/58	€ 106,00	58 mm	2
C025/59	€ 106,00	59 mm	2
C025/60	€ 106,00	60 mm	2
C025/62	€ 127,00	62 mm	2
C025/63	€ 127,00	63 mm	2
C025/65	€ 127,00	65 mm	2
C025/66	€ 127,00	66 mm	2
C025/67	€ 127,00	67 mm	2
C025/68	€ 127,00	68 mm	2
C025/69	€ 127,00	69 mm	2
C025/70	€ 169,00	70 mm	2
C025/71	€ 169,00	71 mm	2
C025/72	€ 169,00	72 mm	2
C025/74	€ 169,00	74 mm	2
C025/75	€ 169,00	75 mm	2
C025/76	€ 169,00	76 mm	2
C025/78	€ 169,00	78 mm	2
C025/80	€ 169,00	80 mm	2

C025-3x

SERIE CALIBRI TAMPONE LISCI PASSA NON PASSA H7 TEMPERATI



UPGRADE



Valigetta

Art.	€	Pezzi	Passo	Ø
C025/3/30	€ 1190,00	28	1 mm	3 ÷ 30 mm
C025/32/62	€ 1420,00	16	-	32-35-37-38-40-42-45-47-48-50 52-55-56-58-60-62 mm

A015-

ANELLO DI AZZERAMENTO

Precisione 6g.



2250

Art.	€	Misura
A015/008	€ 57,00	8 mm
A015/010	€ 63,90	10 mm
A015/011	€ 63,90	11 mm
A015/017	€ 69,80	17 mm
A015/025	€ 69,80	25 mm
A015/035	€ 69,80	35 mm
A015/040	€ 119,00	40 mm
A015/062	€ 132,00	62 mm
A015/087	€ 311,00	87 mm
A015/100	€ 327,00	100 mm
A015/125	€ 506,00	125 mm
A015/150	€ 710,00	150 mm

T048x
TAMPONE FILETTATO DOPPIO P/NP

Passo gas cilindrico.



Art.	€	Dimensioni
T0481/8	€ 70,80	1/8" - 28 TPI
T0481/4	€ 70,80	1/4" - 19 TPI
T0483/8	€ 70,80	3/8" - 19 TPI
T0481/2	€ 91,10	1/2" - 14 TPI
T0485/8	€ 106,00	5/8" - 14 TPI
T0483/4	€ 113,00	3/4" - 14 TPI
T0487/8	€ 147,00	7/8" - 14 TPI
T0481	€ 172,00	1" - 11 TPI

A018x
ANELLO FILETTATO TIPO PASSA

Passo gas cilindrico.



Art.	€	Dimensioni
A0181/8	€ 73,00	1/8" - 28 TPI
A0181/4	€ 73,00	1/4" - 19 TPI
A0183/8	€ 73,00	3/8" - 19 TPI
A0181/2	€ 100,00	1/2" - 14 TPI
A0185/8	€ 100,00	5/8" - 14 TPI
A0183/4	€ 122,00	3/4" - 14 TPI
A0187/8	€ 147,00	7/8" - 14 TPI
A0181	€ 107,00	1" - 11 TPI

T049x
TAMPONE FILETTATO DOPPIO P/NP METRICO 6H

Art.	€	Dimensioni
T0493X0.5	€ 64,90	3 x 0,5 mm
T0494X0.7	€ 83,50	4 x 0,7 mm
T0495X0.8	€ 86,40	5 x 0,8 mm
T0496X1	€ 86,40	6 x 1 mm
T0498X1	€ 78,70	8 x 1 mm
T0498X1.25	€ 78,70	8 x 1,25 mm
T04910X1	€ 80,50	10 x 1 mm
T04910X1.25	€ 80,50	10 x 1,25 mm
T04910X1.5	€ 80,50	10 x 1,5 mm
T04912X1.25	€ 80,50	12 x 1,25 mm
T04912X1.5	€ 80,50	12 x 1,5 mm
T04912X1.75	€ 80,50	12 x 1,75 mm
T04914X1.5	€ 86,40	14 x 1,5 mm
T04914X2	€ 86,40	14 x 2 mm
T04916X1.5	€ 90,20	16 x 1,5 mm
T04916X2	€ 90,20	16 x 2 mm
T04918X1.5	€ 66,90	18 x 1,5 mm
T04918X2.5	€ 66,90	18 x 2,5 mm
T04920X1.5	€ 73,30	20 x 1,5 mm
T04920X2.5	€ 73,30	20 x 2,5 mm
T04922X1.5	€ 75,10	22 x 1,5 mm
T04922X2.5	€ 75,10	22 x 2,5 mm
T04924X1.5	€ 78,70	24 x 1,5 mm
T04924X2	€ 78,70	24 x 2 mm
T04924X3	€ 78,70	24 x 3 mm

A017x
ANELLO FILETTATO 6G TIPO PASSA METRICO

Art.	€	Dimensioni
A0173X0.5	€ 62,90	3 x 0,5 mm
A0174X0.7	€ 70,80	4 x 0,7 mm
A0175X0.8	€ 70,80	5 x 0,8 mm
A0176X1	€ 58,90	6 x 1 mm
A0178X1	€ 58,90	8 x 1 mm
A0178X1.25	€ 58,90	8 x 1,25 mm
A01710X1	€ 83,50	10 x 1 mm
A01710X1.25	€ 64,90	10 x 1,25 mm
A01710X1.5	€ 64,90	10 x 1,5 mm
A01712X1.25	€ 90,20	12 x 1,25 mm
A01712X1.5	€ 90,20	12 x 1,5 mm
A01712X1.75	€ 90,20	12 x 1,75 mm
A01714X2	€ 90,20	14 x 2 mm
A01716X1.5	€ 95,60	16 x 1,5 mm
A01716X2	€ 95,60	16 x 2 mm
A01718X1.5	€ 66,90	18 x 1,5 mm
A01718X2.5	€ 66,90	18 x 2,5 mm
A01720X1.5	€ 70,60	20 x 1,5 mm
A01720X2.5	€ 70,60	20 x 2,5 mm
A01722X1.5	€ 80,40	22 x 1,5 mm
A01722X2.5	€ 80,40	22 x 2,5 mm
A01724X1.5	€ 107,00	24 x 1,5 mm
A01724X2	€ 107,00	24 x 2 mm
A01724X3	€ 107,00	24 x 3 mm

S091
SERIE SPINE CALIBRATE
€ 520,00

Valigetta

Pezzi	91
Misura	1±10 mm
Progressione	0,1 mm
Lunghezza	50 mm
Durezza	HRC-60-62
Precisione	±0,002 mm



T009 € 35,00

SUPPORTO TASTATORE AD ARCO



Attacco maschio	Ø 8 mm
Attacco femmina	Ø 4 mm

B201/1 € 18,20

BASE MAGNETICA

Per porta comparatore, materiale magnetico n35, selettore in abs e base prismatica.



Dimensioni base	36 x 30 x 35 mm
Foro	M5 x 0,8
Forza magnetica	300 N



B201/2 € 21,60

BASE MAGNETICA

Per porta comparatore, materiale magnetico n35, selettore in abs e base prismatica.



Dimensioni base	60 x 50 x 55 mm
Foro	M8 x 1,25
Forza magnetica	800 N



B201/3 € 28,50

BASE MAGNETICA

Per porta comparatore, materiale magnetico n35, selettore in abs e base prismatica.



Dimensioni base	73 x 50 x 55 mm
Foro	M8 x 1,25
Forza magnetica	1000 N



B201/4 € 39,80

BASE MAGNETICA

Per porta comparatore, materiale magnetico n35, selettore in abs e base prismatica.



Dimensioni base	117 x 50 x 55 mm
Foro	M8 x 1,25
Forza magnetica	1300 N



B100 € 26,00

BASE MAGNETICA

Per porta comparatore, selettore in abs e base prismatica.



Dimensioni	63 x 50 x 55h mm
Foro	M 8 x 1,25
Forza magnetica	600 N



S052/2 € 34,20

SUPPORTO MAGNETICO PORTA COMPARATORE

Con regolazione micrometrica, colonna robusta e braccio trasversale regolabile. Base magnetica con appoggio prismatico e commutatore.



Asta principale	Ø 12 x 176 mm
Asta secondaria	Ø 10 x 150 mm
Forza magnetica	800 N
Dimensioni base	60 x 50 x 55 mm



S052/3 € 59,30

SUPPORTO MAGNETICO PORTA COMPARATORE

Con regolazione micrometrica, colonna robusta e braccio trasversale regolabile. Base magnetica con appoggio prismatico e commutatore.



Asta principale	Ø 16 x 225 mm
Asta secondaria	Ø 14 x 165 mm
Forza magnetica	1000 N
Dimensioni base	73 x 50 x 55 mm



S052/4
€ 87,80
SUPPORTO MAGNETICO PORTA COMPARATORE

Con regolazione micrometrica, colonna robusta e braccio trasversale regolabile. Base magnetica con appoggio prismatico e commutatore.



Scatola

Asta principale	ø 20 x 355 mm
Asta secondaria	ø 14 x 210 mm
Forza magnetica	1300 N
Dimensioni base	117 x 50 x 55 mm

S049
€ 38,60
SUPPORTO MAGNETICO PORTA COMPARATORE

Con regolazione micrometrica.



Scatola

Asta principale	ø 12 x 170 mm
Asta secondaria	ø 10 x 150 mm
Forza magnetica	600 N
Dimensioni base	63 x 50 x 55h mm

S047
€ 72,30
SUPPORTO MAGNETICO PORTA COMPARATORE

Con regolazione micrometrica.



Scatola

Asta principale	ø 16 x 220 mm
Asta secondaria	ø 12 x 180 mm
Forza magnetica	800 N
Dimensioni base	65 x 50 x 55h mm

S054
€ 35,00
SUPPORTO MAGNETICO PORTA COMPARATORE

Con regolazione micrometrica.



Scatola

Asta principale	ø 12 x 170 mm
Asta secondaria	ø 10 x 165 mm
Forza magnetica	600 N
Dimensioni base	63 x 50 x 55h mm

S055
€ 68,30
SUPPORTO MAGNETICO PORTA COMPARATORE
S042/1
€ 63,10
SUPPORTO ARTICOLATO MECCANICO

Con bloccaggio centrale 3d delle aste.



Scatola

Asta principale	ø 16 x 210 mm
Asta secondaria	ø 12 x 175 mm
Forza magnetica	800 N
Dimensioni base	75 x 50 x 55h mm



Scatola

Dimensioni base	36 x 30 x 35 mm
Forza magnetica	300 N
Lunghezza braccio	145 mm

S042/2
€ 79,80
SUPPORTO ARTICOLATO MECCANICO

Con microregolazione e bloccaggio centrale 3d delle aste.

S042/3
€ 103,00
SUPPORTO ARTICOLATO MECCANICO

Con microregolazione e bloccaggio centrale 3d delle aste.



Scatola

Dimensioni base	60 x 50 x 55 mm
Forza magnetica	800 N
Lunghezza braccio	290 mm



Scatola

Dimensioni base	75 x 50 x 55 mm
Forza magnetica	1000 N
Lunghezza braccio	365 mm



**S045****€ 81,00****SUPPORTO ARTICOLATO MECCANICO**

Scatola

Asta principale	Ø 12 x 160 mm
Asta secondaria	Ø 10 x 180 mm
Forza magnetica	600 N
Dimensioni base	63 x 50 x 55h mm

S046**€ 124,00****SUPPORTO ARTICOLATO IDRAULICO**

Scatola

Asta principale	Ø 17 x 180 mm
Asta secondaria	Ø 14 x 200 mm
Forza magnetica	600 N
Dimensioni base	63 x 50 x 55h mm

B025**€ 239,00****STATIVO PORTA COMPARATORE**

Con piano scanalato e base in alluminio.



Scatola

Porta comparatore	Ø 8 mm
Dimensioni piano	80 x 80 mm
Dimensioni base	150 x 100 mm
Colonna	Ø 25 x 180 mm

B010**€ 295,00****STATIVO PORTA COMPARATORE**

Con base in granito.



Scatola

Porta comparatore	Ø 8 mm
Dimensioni base	300 x 200 x 50h mm
Colonna	Ø 35 x 300 mm
Planarità base	0,002 mm

A019-**APPARECCHIO A DUE PUNTE PER IL CONTROLLO DELLA CONCENTRICITÀ**

Con superfici di scorrimento rettificate e dotato di supporto porta comparatore.



Cassa di legno



Ghisa

Art.	€	Distanza tra le punte	Altezza punte Min. - Max	CM	Dimensioni	Porta comparatore	Peso netto
A019/300	€ 1340,00	300 mm	145 / 175 mm	2	730 x 310 x 370h mm	2	65 kg
A019/500	€ 1710,00	500 mm	135 / 170 mm	2	924 x 330 x 482h mm	2	70 kg
A019/1000	€ 2020,00	1000 mm	135 / 170 mm	2	1400 x 330 x 430h mm	2	100 kg

S051**€ 34,60****SUPPORTO MICROMETRO**

Con ganasce ricoperte di plastica morbida.



Scatola



Ghisa



P04x

PIANO DI RISCONTRO IN GRANITO

Grado 0



Cassa di legno

Art.	€	Dimensioni	Peso netto
P040	€ 96,10	310 x 230 x 80 mm	20 kg
P042	€ 308,00	630 x 400 x 100 mm	80 kg
P043	€ 825,00	1000 x 630 x 150 mm	280 kg
P047	€ 1370,00	1200 x 800 x 160 mm	497 kg
P044	€ 2900,00	1600 x 1000 x 200 mm	1059 kg



S06x

SQUADRA DI RISCONTRO IN GRANITO

Grado 0



Cassa di legno



876

Art.	€	Dimensioni	Precisione
S061	€ 458,00	250 x 40 x 400h mm	± 6 µm
S062	€ 646,00	400 x 100 x 635h mm	± 9 µm

S050-

SQUADRA A 90°

Adatta per il controllo di ortogonalità e planarità nell'industria meccanica di precisione. Con cappello



Acciaio



875/1

Art.	€	Dimensioni	Sezione
S050/150	€ 36,80	150 x 100 mm	25,5 x 4,8 mm
S050/200	€ 46,70	200 x 130 mm	30,3 x 6 mm
S050/250	€ 62,40	250 x 165 mm	35 x 7 mm
S050/300	€ 69,50	300 x 200 mm	36 x 9 mm
S050/400	€ 154,00	400 x 265 mm	39 x 9 mm
S050/500	€ 184,00	500 x 330 mm	50 x 9 mm

S051-

SQUADRA A 90°

Adatta per il controllo di ortogonalità e planarità nell'industria meccanica. Con cappello



Acciaio

Art.	€	Dimensioni	Sezione
S051/100	€ 15,70	100 x 70 mm	20 x 5,5 mm ²
S051/150	€ 18,10	150 x 100 mm	20 x 5,5 mm ²
S051/200	€ 24,80	200 x 130 mm	20 x 5,5 mm ²
S051/250	€ 28,60	250 x 160 mm	25 x 5,5 mm ²
S051/300	€ 36,90	300 x 175 mm	25 x 5,5 mm ²
S051/400	€ 40,60	400 x 200 mm	29,5 x 5,5 mm ²
S051/500	€ 62,40	500 x 250 mm	29,5 x 5,5 mm ²
S051/600	€ 78,50	600 x 330 mm	29,5 x 5,5 mm ²
S051/750	€ 185,00	750 x 375 mm	29,5 x 5,5 mm ²
S051/1000	€ 221,00	1000 x 500 mm	29,5 x 5,5 mm ²

S059-

SQUADRA A 90°

Adatta per il controllo di ortogonalità e planarità nell'industria meccanica. Senza cappello



Acciaio

Art.	€	Dimensioni	Sezione
S059/100	€ 9,10	100 x 70 mm	20 x 5,5 mm ²
S059/150	€ 10,90	150 x 100 mm	20 x 5,5 mm ²
S059/200	€ 12,70	200 x 130 mm	20 x 5,5 mm ²
S059/250	€ 15,30	250 x 160 mm	25 x 5,5 mm ²
S059/300	€ 17,50	300 x 175 mm	25 x 5,5 mm ²
S059/400	€ 22,20	400 x 200 mm	29,5 x 5,5 mm ²
S059/500	€ 26,40	500 x 250 mm	29,5 x 5,5 mm ²
S059/600	€ 31,70	600 x 330 mm	29,5 x 5,5 mm ²
S059/750	€ 54,40	750 x 375 mm	29,5 x 5,5 mm ²
S059/1000	€ 79,30	1000 x 500 mm	29,5 x 5,5 mm ²

S048-

SQUADRA BISELLATA A 90°



875/00

Art.	€	Dimensioni	Sezione
S048/100	€ 39,10	100 x 70 mm	20 x 5 mm ²
S048/150	€ 59,30	150 x 100 mm	25 x 5 mm ²

S056-

SQUADRA MAGNETICA A 90°



Scatola

Art.	€	Dimensioni	Forza magnetica max.
S056/150	€ 90,30	150 x 150 x 50 mm	500 N
S056/200	€ 113,00	200 x 200 x 50 mm	1000 N

S057/125

POSIZIONATORE MAGNETICO

€ 21,00



Blister

Dimensioni	135 x 135 x 25 mm
Forza magnetica	340 N
Angolo di posizionamento	45 - 90 - 135°

0286-

SQUADRA FALEGNAME MILLIMETRATA



Art.	€	Dimensioni
0286/250	€ 3,11	250 x 130 x 0,8 mm
0286/300	€ 3,66	300 x 130 x 0,8 mm
0286/350	€ 4,08	350 x 155 x 0,8 mm

S058

SQUADRA MAGNETICA INCLINABILE

€ 104,00



Scatola

Dimensioni	115 x 115 x 35 mm
Gradi	45° ± 90°
Forza magnetica max.	250 N

S057/060S

SERIE POSIZIONATORI MAGNETICI

€ 14,20



4 Pcs



Blister

Dimensioni	50 x 60 x 12,5 mm
Forza magnetica	45 N
Angolo di posizionamento	45 - 90 - 135°

0212 € 8,80

SPESSIMETRO



Blister

Lame num.	20
Misure	0,05 - 1,00 mm

FGx-AI

SET DI SPESSIMETRI IN ACCIAIO INOX

Lame a forma conica, custodia placcata in nichel con dado di bloccaggio, misure in mm e pollici su ogni lama.



Blister

INOX

Art.	€	Lame num.	Tolleranza	Misure	Lunghezza lama
FG01/AI	€ 14,40	13	T2	0,05 - 1,00 mm 0,002 - 0,040"	100 mm
FG02/AI	€ 22,90	20	T2	0,05 - 1,00 mm 0,002 - 0,040"	100 mm

HT125 € 7,70

SUPPORTO PER SPESSIMETRO A NASTRO



Blister

Dimensioni	125 x 17 mm
------------	-------------



FGx

SET DI SPESSIMETRI

Lame a forma conica, custodia placcata in nichel con dado di bloccaggio, misure in mm e pollici su ogni lama.



Blister



Acciaio

Art.	€	Lame num.	Tolleranza	Misure	Lunghezza lama
FG01	€ 4,85	13	T2	0,05 - 1,00 mm 0,002 - 0,040"	100 mm
FG02	€ 8,20	20	T2	0,05 - 1,00 mm 0,002 - 0,040"	100 mm

TGx-AE

SPESSIMETRO A NASTRO CONTINUO

Misura in mm e pollici su ogni lama. Tolleranza T2



Blister



Acciaio

Art.	€	Spessore	Lunghezza
TG001/AE	€ 66,80	0.01 mm 0.0004"	5 m
TG002/AE	€ 51,80	0.02 mm 0.0008"	5 m
TG003/AE	€ 28,50	0.03 mm 0.0012"	5 m
TG004/AE	€ 29,60	0.04 mm 0.0016"	5 m
TG005/AE	€ 20,70	0.05 mm 0.0020"	5 m
TG006/AE	€ 20,70	0.06 mm 0.0024"	5 m
TG007/AE	€ 20,70	0.07 mm 0.0028"	5 m
TG008/AE	€ 20,70	0.08 mm 0.0030"	5 m
TG009/AE	€ 20,70	0.09 mm 0.0035"	5 m
TG010/AE	€ 20,70	0.10 mm 0.0040"	5 m
TG012/AE	€ 20,70	0.12 mm 0.005"	5 m
TG015/AE	€ 19,10	0.15 mm 0.006"	5 m
TG018/AE	€ 20,70	0.18 mm 0.007"	5 m
TG020/AE	€ 19,10	0.20 mm 0.008"	5 m
TG025/AE	€ 19,10	0.25 mm 0.010"	5 m
TG030/AE	€ 19,10	0.30 mm 0.012"	5 m
TG035/AE	€ 20,70	0.35 mm 0.014"	5 m
TG040/AE	€ 20,70	0.40 mm 0.016"	5 m
TG045/AE	€ 20,70	0.45 mm 0.018"	5 m
TG050/AE	€ 20,70	0.50 mm 0.020"	5 m
TG055/AE	€ 29,60	0.55 mm 0.022"	5 m
TG060/AE	€ 29,60	0.60 mm 0.024"	5 m
TG065/AE	€ 29,60	0.65 mm 0.026"	5 m
TG070/AE	€ 25,50	0.70 mm 0.028"	5 m
TG075/AE	€ 25,50	0.75 mm 0.030"	5 m
TG080/AE	€ 25,50	0.80 mm 0.032"	5 m
TG085/AE	€ 25,50	0.85 mm 0.034"	5 m
TG090/AE	€ 25,50	0.90 mm 0.036"	5 m
TG095/AE	€ 25,50	0.95 mm 0.038"	5 m
TG100/AE	€ 25,50	1.00 mm 0.040"	5 m
TG110/AE	€ 19,40	1.10 mm	1 m
TG120/AE	€ 19,40	1.20 mm	1 m
TG130/AE	€ 19,40	1.30 mm	1 m
TG140/AE	€ 19,40	1.40 mm	1 m
TG150/AE	€ 19,40	1.50 mm	1 m
TG160/AE	€ 19,40	1.60 mm	1 m
TG170/AE	€ 19,40	1.70 mm	1 m
TG180/AE	€ 19,40	1.80 mm	1 m
TG190/AE	€ 19,40	1.90 mm	1 m
TG200/AE	€ 19,40	2.00 mm	1 m

**C058**

€ 14,00

CONTAFILETTI A 58 LAME

Blister

Lame metriche	0.25 - 6 mm 60°
Lame a pollici	4 - 62 TPI 55°
Lame a gas	8 - 28 TPI 55°

C029-**COMPASSO**

Per interni.



Art.	€	Lunghezza
C029/150	€ 9,70	150 mm
C029/200	€ 12,00	200 mm
C029/250	€ 13,90	250 mm
C029/300	€ 16,40	300 mm

C027-**COMPASSO**

Con guida e gambo quadrato.



Art.	€	Lunghezza
C027/150	€ 13,50	150 mm
C027/200	€ 15,90	200 mm
C027/250	€ 19,80	250 mm
C027/300	€ 22,00	300 mm

C026-**COMPASSO**

A punta con gambo quadrato.



Art.	€	Lunghezza
C026/150	€ 9,70	150 mm
C026/200	€ 12,00	200 mm
C026/250	€ 16,40	250 mm
C026/300	€ 18,90	300 mm

C028-**COMPASSO**

Per spessori esterni.



Art.	€	Lunghezza
C028/150	€ 9,70	150 mm
C028/200	€ 12,00	200 mm
C028/250	€ 13,90	250 mm
C028/300	€ 16,40	300 mm



P007-
PRISMA MAGNETICO

Singolo o in coppia.



Scatola

Art.	€	Dimensioni	Larghezza	Forza magnetica max.	Pezzi
P007/1	€ 123,00	70 x 60 x 72 mm	38 mm	400 N	1
P007/2	€ 158,00	100 x 70 x 95 mm	50 / 16 mm	300 N	1
P007/1C	€ 234,00	71 x 60 x 73 mm	38 mm	400 N	2
P007/2C	€ 360,00	100 x 70 x 95 mm	50 / 16 mm	300 N	2

P30x
PRISMA A 90°

Con morsetto, singolo o in coppia.



Scatola



Acciaio



Temprato

Art.	€	Dimensioni	Bloccaggio massimo	Precisione	Pezzi
P301/2	€ 68,90	63,5 x 63,5 x 50 mm	ø 35 mm	±0,01 mm	1
P302/2	€ 117,00	100 x 75 x 75 mm	ø 65 mm	±0,01 mm	1
P303/2	€ 181,00	150 x 125 x 100 mm	ø 110 mm	±0,01 mm	1
P301/2C	€ 133,00	63,5 x 63,5 x 50,8 mm	ø 35 mm	±0,01 mm	2
P302/2C	€ 230,00	100 x 75 x 75 mm	ø 65 mm	±0,01 mm	2
P303/2C	€ 361,00	150 x 125 x 100 mm	ø 110 mm	±0,01 mm	2

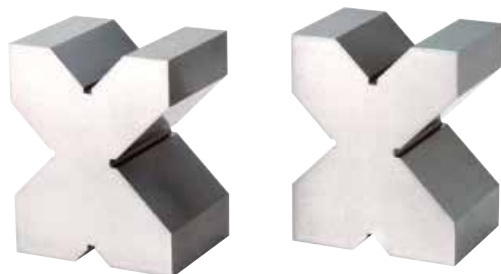
P20x
COPPIA PRISMI RETTIFICATI

Scatola

C45

Art.	€	Dimensioni	Precisione
P200/1	€ 251,00	75 x 75 x 60 mm	1/100 mm
P201/1	€ 334,00	100 x 80 x 60 mm	1/100 mm

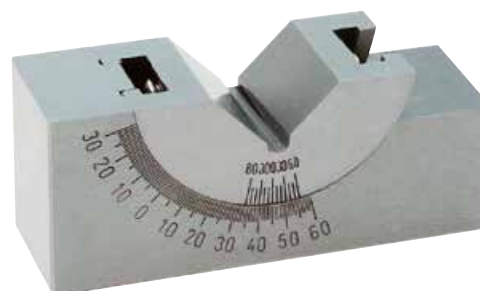
P011-
PRISMA INCLINABILE

Scatola

Art.	€	Dimensioni
P011/075	€ 116,00	75 x 32 x 25 mm
P011/100	€ 138,00	102 x 48 x 46 mm



F813

€ 4,90 **NEW**

FLESSOMETRO



Espositore

Dimensioni nastro
Classe di precisione

3 m x 12 mm
II

F2Gx

FLESSOMETRO

Con meccanismo di arresto in acciaio, gancio rivettato all'estremità con protezione della lama inferiore mediante ammortizzatore.



Espositore

Art.	€	Dimensioni nastro	Classe di precisione
F2G2	€ 3,58	2 m x 16 mm	II
F2G3	€ 4,09	3 m x 16 mm	II
F2G5	€ 6,30	5 m x 19 mm	II

F68x

FLESSOMETRO MAGNETICO

Con meccanismo di arresto in acciaio, gancio rivettato all'estremità con protezione della lama inferiore mediante ammortizzatore.



Espositore

Art.	€	Dimensioni nastro	Classe di precisione
F683	€ 6,70	3 m x 19 mm	II
F685	€ 9,30	5 m x 25 mm	II
F688	€ 13,40	8 m x 25 mm	II

F80x

FLESSOMETRO

Di forma ergonomica antiscivolo, con bloccaggio sicuro e preciso, gancio per cintura, nastro di spessore maggiorato con rivestimento in poliestere antiabrasivo.



Espositore

Art.	€	Dimensioni nastro	Classe di precisione
F802	€ 2,83	2 m x 16 mm	II
F803	€ 4,60	3 m x 16 mm	II
F805	€ 6,50	5 m x 19 mm	II
F808	€ 9,30	8 m x 25 mm	II

F32x

FLESSOMETRO MAGNETICO

Con freno automatico e magnete.



Espositore

Art.	€	Dimensioni nastro	Classe di precisione
F322	€ 4,61	2 m x 16 mm	II
F323	€ 6,10	3 m x 19 mm	II
F325	€ 8,30	5 m x 25 mm	II
F328	€ 11,60	8 m x 25 mm	II

R0x
ROTELLA METRICA

Con nastro in acciaio.



Scatola

Art.	€	Dimensioni nastro
R030	€ 28,10	30 m x 13 mm
R050	€ 43,60	50 m x 13 mm

0646/A
€ 128,00
LASER AUTOLIVELLANTE

Scatola

Precisione di livellamento	0,5 mm / m
Precisione linea orizzontale e verticale	± 0,5 mm / m
Batteria	3 x 1,5V AA
Tipo laser	Classe II / 650 nm
Distanza di lavoro consigliata	10 m
H massima	126,5 cm
H minima	52,5 cm

0449
€ 25,60
MINI LIVELLA LASER

A 4 fiale, con corpo in ABS, raggio laser in grado di emettere un unico punto o una croce perpendicolare.



Scatola

Tipo laser	Classe II / 650 nm
Distanza di lavoro	20 m
Potenza	< 1 mW
Accuratezza	0,05°
Batteria	2 x 1,5V AAA

0666
€ 193,00
LIVELLA DIGITALE CON RAGGIO LASER

Visualizzazione dell'angolo o della percentuale di inclinazione. Batterie non incluse.



Scatola

Lunghezza	600 mm
Autospegnimento	5 min
Gamma di misurazione	0 ~ 360°
Lunghezza d'onda	650 nm
Risoluzione	0,1°
Potenza laser	< 1 mW
Precisione livella	± 0,05°
Precisione del punto	± 1 mm / m
Batteria	2 x 1,5V AAA

0109
€ 52,70
LIVELLA DIGITALE

Magnetica con corpo in alluminio, autospegnimento, schermo retroilluminato, 2 fiale, lettura assoluta e relativa, funzione "hold".



Scatola

Lunghezza	400 mm
Autospegnimento	5 min
Gamma di misurazione	0 - 90° x 4
Risoluzione	0° - 90°: 0,1°
Precisione livella	0° - 90°: ±0,2°
Batteria	2 x AAA 1,5V

0112
€ 115,00
LIVELLA DIGITALE

Magnetica con corpo in alluminio e base fresata, autospegnimento, schermo retroilluminato, 2 fiale, funzione "hold", ricerca del 0° e 90° sonoro, lettura: assoluta e relativa, gradi, percentuale, mm/m e in/ft, borsa per il trasporto.



Scatola

Lunghezza	600 mm
Autospegnimento	5 min
Gamma di misurazione	0 - 90° x 4
Risoluzione	0° & 90°: 0,05°; 0° - 89°: 0,1°
Precisione livella	0° & 90°: ±0,05°; 0,1° - 89,9°: ±0,2°
Batteria	2 x AAA 1,5V

L090A
€ 120,00
LIVELLA DIGITALE INCLINOMETRO E GONIOMETRO CON MAGNETE

Funzioni: 0 ÷ 90° in tutte le 4 direzioni, inclinazione mm/m, inclinazione in/ft, percentuale d'inclinazione (%), retroilluminazione, autospegnimento, misurazione assoluta (ABS) e relativa, inversione automatica dei numeri per letture sottosopra, con segnale acustico.



Scatola

Precisione	± 0.15°
Gamma di misurazione	0 ÷ 90° x 4
Risoluzione	0.05°
Dimensioni	151 x 31 x 60 mm
Batteria	2 x 1.5 V AAA

L085
€ 91,70
LIVELLA QUADRA DIGITALE

Magnetica 2 x 0 ÷ 180°, autospegnimento, misurazione assoluta (ABS) e relativa, inversione automatica dei numeri per letture sottosopra e funzione hold.



Blister



Precisione	± 0.1°
Gamma di misurazione	0° ÷ 180°
Risoluzione	0.1°
Dimensioni	51 x 51 x 33 mm
Batteria	1 x 3 V CR2032

0824-
LIVELLA

In alluminio a 3 fiale, fresata e millimetrata.



Art.	€	Dimensioni
0824/300	€ 6,10	300 x 49 x 23 mm
0824/400	€ 6,90	400 x 49 x 23 mm
0824/500	€ 8,10	500 x 49 x 23 mm
0824/600	€ 9,20	600 x 49 x 23 mm

L080
€ 58,20
LIVELLA QUADRA DIGITALE

Magnetica 0 ÷ 90° in tutte le 4 direzioni, retroilluminazione, autospegnimento, misurazione assoluta (ABS) e relativa, inversione automatica dei numeri per letture sottosopra.



Blister

Precisione	0° ± 0.1°; 90° ± 0.1°; 0.1° ÷ 89.9° ± 0.2°
Gamma di misurazione	0 ÷ 90° x 4
Risoluzione	0.1°
Dimensioni	59 x 27 x 59 mm
Batteria	1 x 1.5 V AAA

0805/400
€ 10,00
LIVELLA MAGNETICA

A 3 fiale millimetrata.



Dimensioni	400 x 50 x 20 mm
------------	------------------

L200
€ 206,00
LIVELLA LINEARE

Rettificata di alta precisione, con base prismatica.



Dimensioni	200 x 45 x 40 mm
Precisione	0,02 mm / m

L150

€ 239,00

LIVELLA QUADRA

Rettificata di alta precisione, con 2 facce piane e 2 prismatiche.



Dimensioni	150 x 38 x 150 mm
Precisione	0,02 mm / m

G006-

GONIOMETRO SEMPLICE

Con vite di bloccaggio, scala incisa al laser.

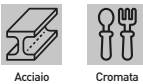

Art.	€	Arco	Asta	Campo di misura
G006/120	€ 23,00	Ø 80 mm	120 mm	0 ÷ 180°
G006/150	€ 25,80	Ø 120 mm	150 mm	0 ÷ 180°
G006/200	€ 31,30	Ø 150 mm	200 mm	0 ÷ 180°
G006/300	€ 43,90	Ø 200 mm	300 mm	0 ÷ 180°
G006/500	€ 90,50	Ø 300 mm	500 mm	0 ÷ 180°
G006/600	€ 103,00	Ø 300 mm	600 mm	0 ÷ 180°

G008

€ 55,90

GONIOMETRO DIGITALE E LIVELLA CON 2 FIALE

Calcolo automatico di angoli e inclinazioni.



Blister

Lunghezza	400 mm
Scala	0 ÷ 225°
Letture	0,1°
Accuratezza	± 0,5°
Batteria	1x 9V

G005

€ 93,60

GONIOMETRO UNIVERSALE



Letture	5'
Scala	0° ÷ 360°
Asta	300 mm



E022/12
€ 382,00
ENDOSCOPIO FLESSIBILE PER MECCANICA

Con sonda \varnothing 12 mm dotato di: schermo a colori lcd 3,5" - sonda flessibile - videocamera dotata di luci Led - possono essere aggiunte fino a 2 prolunghe - terminale magnetico - terminale a gancio - terminale con specchio.



Valigetta

Lunghezza senza manico	900 mm
Sonda	\varnothing 12 mm
Visione	0° - 60°
Batteria	1 x 9 V
Massima profondità di rilevazione	50 mm
Distanza	2.5 cm - 30 cm
Display	3.5" LCD
Tempo di utilizzo	> 2hr
Temperatura di esercizio	0°C - 4°C
Temperatura stoccaggio	-20°C - +60°C
Dimensioni	215 x 156 x 96 mm

M072
€ 31,50
LENTE DI PRECISIONE PER MISURAZIONI

Scatola

Ingrandimenti	10x
Campo di vista	24 mm
Campo di misura	0 \pm 20 mm
Letture	0,1 mm

E022/5
€ 382,00
SONDA FLESSIBILE

Dimensioni	\varnothing 5,5 mm
Lunghezza	1070 mm

E022/P
€ 83,20
PROLUNGA FLESSIBILE

Dimensioni	\varnothing 18 mm
Lunghezza	2750 mm

M069
€ 610,00
MICROSCOPIO STEREOSCOPICO

Scatola

Luce propria diretta	12 V - 10 W
Distanza di lavoro	165 mm 10x - 119 mm 20x
Alimentazione	230 V 50 Hz
Oculari	10x - 20x
Obiettivi	1x - 2x
Ingrandimenti	10x \div 40x

M071
€ 431,00
MICROSCOPIO STEREOSCOPICO

Scatola

Luce propria incidente e diretta	12 V - 10 W
Altezza massima del pezzo da controllare	75 mm
Alimentazione	230 V 50 Hz
Oculari	10x
Obiettivi	2x - 4x
Ingrandimenti	20x \div 40x

P080
€ 86,40
PINZA AMPEROMETRICA DIGITALE

Con display LCD. 7 modalità di funzionamento: corrente AC, voltaggio AC, voltaggio in DC, resistenza, continuità, frequenza, controllo diodo. Alta affidabilità.



Scatola

ACV	4 / 40 / 400 / 600 V ±1,5% + 4
ACA	4 / 40 / 400 / 600 A ±1,5% + 4
DCV	4 / 40 / 400 / 600 V ±1,0% + 2
RES	400 Ω / 4 kΩ / 40 kΩ / 400 kΩ / 4 MΩ / 40 MΩ ±1,0% + 2
Frequenza	10 MHz ±0,8% + 2
Batteria	2 x 1,5 V x AA
Dimensioni	250 x 71 x 38,8 mm

0029
€ 6,00
TESTER RUBACORRENTE

Per rilevare la corrente nei cavi delle automobili, con valori di tensione da 6-12-24V.



Voltaggio	6 - 12 - 24 V
-----------	---------------

0013/142
€ 1,80
GIRAVITE CERCAFASE

Con impugnatura in materiale isolante, luce al neon e lama in acciaio.



Campo di misura	100 ÷ 500 V
Lunghezza	142 mm

0013/185
€ 1,96
GIRAVITE CERCAFASE

Con impugnatura in materiale isolante, luce al neon e lama in acciaio.



Campo di misura	100 ÷ 500 V
Lunghezza	190 mm

P075
€ 145,00
PINZA AMPEROMETRICA DIGITALE

Con display LCD. 9 modalità di funzionamento: corrente AC, voltaggio AC, voltaggio in DC, resistenza, continuità, frequenza, controllo diodo, misurazione della temperatura. Alta affidabilità.



Scatola

ACV	750 V ±1,2%
ACA	200 - 1000 A ±2,0%
DCV	1000 V ±1,0%
DCA	200 - 1000 A ±2,0%
RES	200 Ω ±1,0%
Frequenza	2k Hz ±2,5%
Temperatura	-40°C - 400°C ±1,5%
Batteria	1 x 9V

T051
€ 20,60
MULTIMETRO DIGITALE TASCABILE

Continuità sonora e controllo diodi.



Scatola

DCV	2-20-200-500V ±0,5%
ACV	200-500V ±1,2%
DCA	200mA ±1,5%
RES	2K-20K-200K-2M Ω ±1%
Batteria	1 x A23

T050
€ 40,90
MULTIMETRO DIGITALE

Con sonda per misurazione temperatura, continuità sonora e controllo diodi.



Scatola

DCV	200 mV ±0,5%
DCV	2 V - 20 V - 200 V ±0,8%
DCV	1000 V ±0,1%
ACV	2mV - 20 V - 200 V ±1,0%
ACV	750 V ±1,2%
DCA	2 mA - 20 mA ±1,8%
DCA	200 mA ±2,0%
DCA	20 A ±2,0%
ACA	200 mA ±2,0%
ACA	20 A ±3,0%
RES	200 Ω ±1,0%
RES	2KΩ - 20KΩ - 200KΩ - 2MΩ ±1,0%
RES	20 MΩ ± 1.0%
RES	200 MΩ ±5.0%
CAP	2000 pF - 20 nF - 200 nF - 2 μF - 20 μF ±4%
Temperatura	-40 °C ÷ 400 °C ±1,0%
Temperatura	400 °C ÷ 1000 °C ±1,5%
Batteria	1x 9V

T053
€ 98,20
MULTIMETRO DIGITALE

Con sonda per misurazione temperatura, continuità sonora e controllo diodi.



Scatola

DCV	200 mV - 2 V - 20 V - 200 V - 1000 V ±0,8%
ACV	200 mV - 2 V - 20 V - 750 V ±1,2%
DCA / ACA	200 μA - 2 mA - 20 mA - 200 mA - 20 A ±2,0%
RES	200Ω - 2kΩ - 20kΩ - 200kΩ - 2MΩ - 20MΩ - 200MΩ ±1%
CAP	20 nF / 200 nF / 2 μF / 20 μF / 200 μF / 2000 μF ±2,5%
Induttanza	2 mH - 20mH - 200 mH - 2 H - 20 H
Batteria	1x 9V
Temperatura	-20 °C ÷ 1000 °C
Frequenza	10 mHz
Test transistor hFE	0 ~ 1000

ML80A
€ 88,90
MISURATORE DI DISTANZA LASER

Maneggevole e leggero, ideale per misurazioni nell'edilizia e in carpenteria, funzioni: addizioni, sottrazioni, area e volume, autospegnimento.



Blister



Campo di misura	0,05 ÷ 80 m
Precisione	±2 mm
Batteria	3 x AAA

ML40
€ 66,10
MISURATORE DI DISTANZA LASER

Maneggevole e leggero, ideale per misurazioni in edilizia e in carpenteria, funzioni: addizioni, sottrazioni, area e volume, autospegnimento.



Blister



Campo di misura	0,05 ÷ 40 m
Precisione	± 2 mm
Batteria	2 x AAA

T068
€ 144,00
MISURATORE DI TEMPERATURA AD INFRAROSSI CON PUNTATORE LASER

Non idoneo alla misura della temperatura corporea.



Scatola

Campo di misura	-30°C÷550 °C -22 F÷1022 F
Precisione	-30 °C ÷ 0 °C -22 F ÷ 32 F ±3 % o ±3 °C
Precisione	0 °C ÷ 100 °C 32 F ÷ 212 F ±2 % o ±2 °C
Precisione	> 100 °C > 212 F ±3 % o ±3 °C
Letture	0,1 °C 0,1 F
Emissività	0,1 ÷ 1,0
Batteria	1x 9V
Dimensioni	146 x 80 x 38 mm
Distanza / Diametro dell'area	1 : 12

T064
€ 111,00
MISURATORE DI TEMPERATURA AD INFRAROSSI CON PUNTATORE LASER

Alta precisione. Misurazione della temperatura senza contatto. Non idoneo per essere umani.



Blister

Campo di misura	-25°C÷400 °C -13 F÷752 F
Precisione	-25 °C ÷ 400 °C ±(2 % + 1 °C)
Precisione	-13 F ÷ 752 F ±(2 % + 1 F)
Letture	1 °C 2 F
Batteria	1x 9V
Distanza / Diametro dell'area	1 : 10
Tempo di misurazione	0.5 s
Emissività pre- impostata	0.95

T057
€ 246,00
MISURATORE DIGITALE DI TEMPERATURA E UMIDITÀ AMBIENTE

Alta precisione, con micro-computer LSI.



Valigetta

Temperatura	-10 °C ÷ +65 °C
Letture temperatura	0,1 °C
Precisione temperatura	±0,5 °C
Umidità relativa	10 % ÷ 100 %
Precisione	2 % ±1 % RH
Batteria	4 x 1,5 V AA
Tempo di risposta	0.4 s
Consumo di energia	16 mA
Dimensioni	202 x 72 x 37 mm

I002
€ 359,00
IGROMETRO A CONTATTO PER LA MISURAZIONE DI UMIDITÀ

Del legno e materiali da costruzione. Con Micro- Computer LSI e timer a cristalli per alta precisione. Collegamento computer per trasferimento dati. Non idoneo per misurare l'umidità ambientale.



Valigetta

Temperatura di esercizio	0 °C - 40 °C
Campo di misura	0 - 80 %
Materiali da costruzione	0 - 50 %
Letture	0,1 %
Precisione	± (0,5 % n+1)
Batteria	4 x 1,5 V AA
Dimensioni	165 x 62 x 26 mm

T054
€ 40,90
MISURATORE DI TEMPERATURA DIGITALE TASCABILE

Con sonde per rilevare la temperatura o per immersione.



Scatola

Letture	1 °C
Campo di misura	-50°C ÷ 1100°C con uso sonda T056/TP03 non in dotazione, -50°C ÷ 750°C con uso sonda T056/TP02 in dotazione, -50°C ÷ 250
Precisione	0°C ÷ 500°C ±(0,75% + 1°C), 500°C ÷ 750°C ± (1% + 1°C), 750°C ÷ 1000°C ± (2% + 1°C), 1000°C ÷ 1200°C ± (4% + 3°C)
Sonda tipo	"K"
Batteria	1x 9V

T063
€ 74,00
MISURATORE DI TEMPERATURA DIGITALE PORTATILE

Sonde tipo "K" per ambiente e per immersione, doppia rilevazione della temperatura, con scatola.



Scatola

Campo di misura	T056/TP01: -50°C ÷ 250°C
Campo di misura	T056/TP02: -50°C ÷ 750°C
Letture	1 °C
Precisione	-50 °C ÷ 1200 °C ±(0.3 % + 2 °C)
Precisione	1200°C ÷ 1300 °C ±(0.6 % + 2 °C)
Precisione	-58 F ~ 1200 F ±(0.3 % + 2 F)
Precisione	1200 F ~ 1999 F ±(0.6 % + 2 F)
Batteria	1x 9V

T055 € 159,00
MISURATORE DI TEMPERATURA DIGITALE PORTATILE

Sonde tipo "K" per ambiente e per immersione con custodia in plastica.



Scatola

Campo di misura	T056/TP01: -50°C ÷ 250°C
Campo di misura	T056/TP02: -50°C ÷ 750°C
Letture	0,1 F
Letture	0,1 °C
Precisione	±(0,3% n+1.8 F)
Precisione	±(0,3% n+1 °C)
Dimensioni	178 x 68 x 39 mm
Lunghezza totale sonda	120 mm
Batteria	4 x 1,5 VAA

F010 € 338,00
FONOMETRO INTEGRATORE DIGITALE

Alta precisione, modalità di rilevamento Fast, Slow, Max. Collegamento con computer per trasferimento dati.



Valigetta

Risposta di frequenze	31,5 Hz ÷ 8 kHz
Campo di misura	30 dB ÷ 130 dB (A) 32 dB ÷ 130 dB (C) 35 dB ÷ 130 dB (Lineare)
Letture	0,1 dB
Funzioni	SL, LN, Leq (livello equivalente)
Caratteristiche di rilevamento	Fast, Slow, Max
Tempo di misurazione	0,1 s
Display	10 mm
Temperatura di esercizio	-10 °C ÷ 40 °C
Batterie non incluse	4 x 1,5 V AAA
Tempo di risposta	1 s
Dimensioni	236 x 63 x 26 mm

T056/TP01 € 9,70
SONDA TIPO "K" PER TEMPERATURA AMBIENTE

Campo di misura	-50°C ÷ 250°C
Tipo sonda	"K"
Lunghezza sonda	2 mm

T056/TP02 € 11,90
SONDA TIPO "K" PER TEMPERATURA AMBIENTE O PER IMMERSIONE

Campo di misura	-50°C ÷ 750°C
Tipo sonda	"K"
Lunghezza totale	135 mm

T056/TP03 € 70,70
SONDA TIPO "K"

Per temperatura ambiente o per immersione.



Campo di misura	-50 °C ÷ 1100 °C
Tipo sonda	"K"
Lunghezza sonda	650 mm

A005 € 226,00
ANEMOMETRO DIGITALE

Valigetta

MISURAZIONE VELOCITÀ DELL'ARIA	
Unità di misura	m/s - Km/h - ft/min - Knots
Gamma velocità madrina	0,4 ÷ 30,0 / 1,4 ÷ 108 / 80 ÷ 5910 / 0,8 ÷ 58,3
Letture	0,1
Precisione	± (2%+1 cifra) / ± (2%+3 cifre) / ± (2%+2 cifre) / ± (2%+2 cifre)
MISURAZIONE TEMPERATURA	
Campo di misura	0°C÷60°C 32 F÷140 F
Letture	0,1° C 0,1 F
Precisione	0,5°C 0.9 F
Batteria	1x 9V non inclusa

L014
€ 79,00
LUXMETRO DIGITALE

Valigetta

Campo di misura	0 LUX ÷ 2000 LUX ÷ 20000 LUX ÷ 50000 LUX
Risoluzione	1 LUX
Precisione	± 5 %
Batteria	1x 9V

MD01
€ 129,00
CERCAMETALLI

Analogico composto da 2 Led a colori per riconoscimento metalli. Sensore audio.



Scatola

Diametro bobina	170 mm
Connettore jack	1/4"
Sensibilità	> 15 cm per una moneta di Ø 25 mm
Batteria	1x 9V

C069
€ 121,00
CONTAGIRI DIGITALE A CONTATTO

Valigetta

Velocità di rotazione	2,5 - 9999,9 rpm
Velocità tangenziale	0,05 - 999,99 m/min
Letture	0,1 (7,5 - 999,9) rpm
Letture	1 (1000-9999,9) rpm
Precisione	± 0,05% + 1 cifra
Dimensioni	190 x 72 x 37 mm
Batteria	4 x 1,5 V AA

O387A
€ 74,00
RILEVATORE DIGITALE

Per la misurazione di metalli ferrosi e non ferrosi, legno e cavi in tensione in pareti, soffitti e pavimenti.



Scatola

Massima profondità di rilevazione	
Metalli ferrosi	100 ± 5 mm
Metalli non ferrosi	70 ± 5 mm
Legno	20 ± 5 mm
Cavi in tensione	50 ± 5 mm
Batteria	1x 9V
Dimensioni	150 x 75 x 24 mm

C070
€ 169,00
CONTAGIRI DIGITALE OTTICO E A CONTATTO

Con strisce catadiottriche. Alta precisione.



Valigetta

Velocità di rotazione ottica	2,5 ÷ 9999,9 rpm
Velocità di rotazione contatto	0,05 ÷ 999,9 rpm
Velocità tangenziale	0,1 ÷ 999,99 m / min
Letture	0,1 (2,5 ÷ 999,9) rpm
Letture	1 (1000 ÷ 9999,9) rpm
Distanza d'uso	da 50 ÷ 60 mm a 50 ÷ 250 mm (con ottico)
Precisione	± 0,05% + 1 cifra
Dimensioni	220 x 75 x 29 mm
Batteria	4 x 1,5V AA
Temperatura di esercizio	0°C ÷ 40°C
Tempo di misurazione	0,8 s

C067
€ 121,00
CONTAGIRI DIGITALE OTTICO

Con strisce catadiottriche.



Valigetta

Campo di misura	2,5 ÷ 9999,9 rpm
Letture	0,1 (2,5 ÷ 999,9) rpm
Letture	1 (1000 ÷ 9999,9) rpm
Distanza d'uso	da 50 ÷ 60 mm a 50 ÷ 250 mm
Precisione	± 0,05% della lettura + 1 cifra
Dimensioni	170 x 72 x 37 mm
Batteria	4 x 1,5V AA

0543 € 22,80
MISURATORE DI PRESSIONE PNEUMATICI E EMERGENZA AUTO

Ideale in condizioni di emergenza può essere utilizzato in 4 modi differenti: misuratore di pressione pneumatici, torcia elettrica a Led, martello rompi vetro di emergenza, taglia cintura di sicurezza.



Blister



Campo di misura	3÷150 psi 0,21÷10,34 bar 21÷1034 kPa
Temperatura di esercizio	-20°C ~ +50° C
Batteria	2x 1.5V AA

V002 € 1190,00
MISURATORE DI VIBRAZIONI

Completo di sonda magnetica, 2 puntali, software e cavo usb.

Accelerazione	0,1 ÷ 400 m/s ²
Velocità	0,01 ÷ 40 cm/s
Spostamento	0,001 ÷ 4 mm
Equilibratura rpm	60 ÷ 99,990
Frequenza	1÷20 kHz
Precisione	± 5 %
Batteria	4 x 1,5 V AA

0836 € 19,00
MISURATORE DI PRESSIONE DIGITALE

Dotato di misuratore di spessore del battistrada e di luce al Led.



Blister



Campo di misura	0,5÷99,5 psi 0,034÷6,86 bar, 3,45÷686 kPa
Precisione	±1%
Batteria	3 x SR44

S004 € 1630,00
MISURATORE DI SPESSORI AD ULTRASUONI

Risoluzione	4-digit LCD
Campo di misura	1,0 ÷ 225,0 mm
Precisione	±0,1 mm
Dimensioni	126 x 68 x 23 mm
Batteria	2 x 1,5 V AA

0583 € 98,20
RIFRATTOMETRO BRIX

Valigetta

Campo di misura	0 ÷ 80 % Brix
-----------------	---------------

0433 € 90,10
RIFRATTOMETRO

Brix per controllo di oli emulsionabili.



Valigetta

Campo di misura	0 ÷ 32% Brix
-----------------	--------------

0312 € 98,20
RIFRATTOMETRO TRIVALENTE PER LIQUIDI AUTO

Valigetta

Scala per liquidi antigelo E	-50 °C ÷ 0 °C
Scala per liquidi antigelo P	-50 °C ÷ 0 °C
Scala per liquidi batteria B	1,10 ÷ 1,40 SG
Scala per liquidi tergcristallo C	-40 ÷ 0°C

0312/AB € 73,60
RIFRATTOMETRO PER LIQUIDI AUTO CON ADBLUE

Valigetta

Scala per liquidi antigelo E	-40 °C ÷ 0 °C
Scala per liquidi antigelo P	-50 °C ÷ 0 °C
Scala per liquidi batteria B	1,10 ÷ 1,40 SG
AdBlue	30 ÷ 35 %

D001

€ 2670,00

DUROMETRO DA BANCO ROCKWELL

Cassa di legno

Letture	0,5 HR
Penetratore a diamante e a sfera	n° 1+1
Incudini piani	n° 2
Incudine a V	n° 1
Blocchetti di taratura	n° 5 (HRC, 3xHRB, HRA)
Altezza max del pezzo da misurare	170 mm
Profondità di misurazione	125 mm
Dimensioni durometro	185 x 465 x 640 mm
Forza di misurazione	588,4 N / 980,7 / 1471 N (60 kgf / 100 kgf / 150 kgf)
SCALE DI MISURAZIONE:	
HRC	20 ÷ 70
HRB	25 ÷ 100
HRA	20 ÷ 88
Peso netto	90 kg

D018

€ 5110,00

DUROMETRO DA BANCO

Motorizzato, rockwell, brinell e vickers.



Cassa di legno



Forza di misurazione	294,2 N / 306,5 N / 588,4 N / 612,9 N / 980,7 N / 1471 N / 1839 N; 30 kgf / 31,25 kgf / 60 kgf / 62,5 kgf / 100 kgf / 150 kgf / 187,5 kgf
Penetratore in diamante a cono e piramide	n° 1+1
Penetratore a sfera	n° 3
Incudini piani	n° 2
Incudine a V	n° 1
Blocchetti di taratura	n° 2 Brinell; n° 2 Rockwell; n° 1 Vickers
Ingrandimenti	37,5x - 75x
Altezza max del pezzo da misurare	Rockwell: 175 mm; Brinell - Vickers: 145 mm

Profondità di misurazione	160 mm
Alimentazione	230 V - 50 / 60 Hz - 6 W
Dimensioni durometro	525 x 240 x 730h mm
SCALE DI MISURAZIONE:	
HBS	4 - 450
HRB	20 - 100
HRA	20 - 88
HRC	20 - 70
HV	200 - 1000
Peso netto	70 kg



D007/A
€ 86,10
DUROMETRO SHORE "A"

Misuratore di durezza per gomme morbide, pelle, feltro, cere.



Campo di misura	0 ÷ 100 A
Lettura	2 A

D011/A
€ 150,00
DUROMETRO DIGITALE SHORE "A"

Misuratore di durezza per gomme morbide, pelle, feltro, cere.



Campo di misura	0 ÷ 100 A
Lettura	0,5 A
Batteria	1 x 3 V CR2032

D011/D
€ 150,00
DUROMETRO DIGITALE SHORE "D"

Misuratore di durezza per gomme dure e materie plastiche.



Campo di misura	0 ÷ 100 D
Lettura	0,5 D
Batteria	1 x 3 V CR2032

P013
€ 157,00
PROVINI IN GOMMA SHORE "A"

Con durezza variabile da 26ha a 88ha. Provini di colore viola, marrone, verde, arancione, rosso, giallo e grigio. Precisione ±2ha.



7 Pcs

S110
€ 431,00
SCLEROMETRO

Per la misurazione di durezza dei manufatti in cemento.



Energia di percussione	2.207 Nm
Tensione molla	7.84 N
Corsa	75 mm

S111
€ 476,00
INCUDINE PER TARATURA SCLEROMETRO

B031
€ 25,40
BILANCINA DIGITALE DI PRECISIONE TASCABILE

Non idoneo nei rapporti con terzi.



Scatola

Capacità	100 g
Letture	0,01 g
Tipo di pesatura	g / dwt / tl / ct
Batteria	1 x 3 V CR2032

B021
€ 20,60
BILANCINA DIGITALE DI PRECISIONE TASCABILE

Non idoneo nei rapporti con terzi. Funzioni tara e calibrazione.



Scatola

Capacità	500 g
Letture	0,1 g
Tipo di pesatura	g / dwt / gn / ct
Batteria	2 x 1,5V AAA

B003/5/1
€ 36,90
BILANCIA ELETTRONICA DIGITALE

Non idoneo nei rapporti con terzi, funzione tara, autospegnimento.



Scatola

Capacità	5 kg - 176,4 oz
Letture	1 g 0,1 oz
Batteria	2 x 1,5V AA
Dimensioni	170 x 240 x 35 mm

B018
€ 134,00
BILANCIA ELETTRONICA DIGITALE CON DOPPIO DISPLAY

Non idoneo nei rapporti con terzi. Dotata di batteria 4 V 4 AH e caricabatteria. Memoria per valori unitari. Calcoli valori totali.



Scatola

Capacità	30 kg
Letture	10 g
Dimensione piatto	340 x 230 mm
Dimensioni	350 x 330 x 120 mm
Alimentazione	230V 50 Hz
Batteria ricaricabile	1 x 4 V 4 Ah

B004-
BILANCIA ELETTRONICA DIGITALE CONTAPEZZI RICARICABILE

Non idoneo nei rapporti con terzi, Dotata di batteria 6V 4A e caricabatterie.

0561/B
€ 38,50
BATTERIA DI RICAMBIO

Per tutte le bilance B004.



Scatola

Art.	€	Capacità	Letture	Dimensioni bilancia da banco	Dimensioni piatto	Batteria ricaricabile
B004/7	€ 410,00	7,5 kg	0,2 g	350 x 340 x 105 mm	335 x 228 mm	1 x 6 V 4 Ah
B004/30	€ 410,00	30 kg	1 g	350 x 340 x 105 mm	335 x 228 mm	1 x 6 V 4 Ah



B004/150

€ 800,00

BILANCIA ELETTRONICA DIGITALE CONTAPEZZI RICARICABILE

Non idoneo nei rapporti con terzi, Dotata di batteria 6V 4A e caricabatterie.

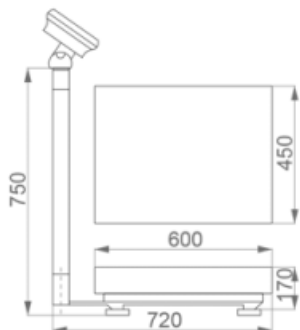

Scatola

Capacità	150 kg
Letture	10 g
Batteria ricaricabile	1 x 6 V 4 Ah
Peso netto	17 kg

0561/B

€ 38,50

BATTERIA DI RICAMBIO

Per tutte le bilance B004.



D010-

DINAMOMETRI DIGITALI

Con struttura in fusione di alluminio, dotati di batteria, caricabatterie, telecomando ad infrarossi e segnale sonoro. Doppia unità di misura kg / lb. Con funzioni di Picco, Hold, Tara, Zero e addizione. Caratteri grandi per una facile lettura. Non idoneo nei rapporti con terzi.



Scatola

Art.	€	Grandezza caratteri	Portata	Letture	Pesata minima	Carico limite	Batteria	Peso netto
D010/0100	€ 622,00	40 x 20 mm	1000 kg	0.500 kg	0.500 kg	150%	1 x 6 V 4 Ah	7,1 kg
D010/0300	€ 749,00	40 x 20 mm	3000 kg	1 kg	1 kg	150%	1 x 6 V 4 Ah	7,5 kg
D010/0500	€ 876,00	40 x 20 mm	5000 kg	2 kg	2 kg	150%	1 x 6 V 4 Ah	12,3 kg
D010/1000	€ 1100,00	40 x 20 mm	10000 kg	5 kg	5 kg	150%	1 x 6 V 4 Ah	25,7 kg

D012-

DINAMOMETRI DIGITALI

Dotati di batteria, caricabatterie, radiocomando, retroilluminazione e segnale sonoro. Doppia unità di misura kg/lb. Con funzioni di Picco, Hold, Tara e Zero. Caratteri grandi per una facile lettura. Non idoneo nei rapporti con terzi.



Scatola

Art.	€	Grandezza caratteri	Portata	Letture	Pesata minima	Carico limite	Batteria ricaricabile	Peso netto
D012/0100	€ 938,00	40 x 20 mm	1001 kg	0,200 kg	0,200 kg	150%	1 x 6 V 10 Ah	12 kg
D012/0300	€ 1110,00	40 x 20 mm	3001 kg	0,500 kg	0,500 kg	150%	1 x 6 V 10 Ah	14,5 kg
D012/0500	€ 1280,00	40 x 20 mm	5001 kg	1 kg	1 kg	150%	1 x 6 V 10 Ah	19 kg
D012/1000	€ 1530,00	40 x 20 mm	10001 kg	2 kg	2 kg	150%	1 x 6 V 10 Ah	32 kg

ART	PAG	ART	PAG	ART	PAG
0010	380	0046	524	0092	474
0011	061	0047	524	0093/22	473
0012	060	0048	529	0093/42	474
0013/142	582	0049	526	0094	372
0013/185	582	0050	525	0095	468
0018/15	408	0051	525	0096	467
0018/30	408	0052	522	0096/L	469
0019-	413	0054/10	368	0101/500	475
0020	453	0054/4	368	0102	082
0020/1	453	0056-	383	0103	483
0020/2	453	0059	526	0104	448
0020/3	453	0060	371	0105	501
0020/4	453	0062-	379	0105T	500
0020/5	453	0063	372	0106	073
0020/6	453	0064	389	0107	548
0021/1	372	0065A	370	0109	578
0021/2	372	0066	387	0110	501
0022	079	0067	371	0110T	500
0023	072	0068/S	388	0112	578
0024	533	0068L	388	0113	083
0026	533	0069-	371	0115	525
0027/30W	532	0070	387	0116	478
0027/40W	532	0070/C	387	0116P	478
0027/40W/TIP	532	0071	534	0118	456
0028	388	0073	397	0119	456
0028R	388	0075	380	0119/5	456
0028-xL	388	0076	408	0119/7	456
0029	582	0077	408	0120	456
0031	532	007x	407	0121	456
0033A	532	0080	409	0122	455
0033A/TIP	532	0081	473	0123	549
0034	534	0082	444	0125	527
0035	468	0083	443	0126	461
0036-	342	0084-	400	0127	461
0036-xG	342	0085	481	0128A	548
0037	532	0087	226	0130-	457
0037/TIP	532	0087/35	226	0132	067
0038	355	0088	435	0133	067
0042-	343	0089	445	0134-	399
0043	483	0090	403	0134S	399
0044	522	0090-	403	0135-	342
0045	522	0091	481	0136	455

ART	PAG	ART	PAG	ART	PAG
0137	410	0183/750	535	0218-xB	544
0138	099	0184-	482	0218-xS	544
0140-	342	0186	056	0219	464
0141	473	0187	399	0220	405
0142-	106	0188-	107	0220/C	405
0143/25	390	0188-xG	107	0221	397
0143A	390	0189-	540	0222	397
0144	099	0189/G	540	0222-	397
0145-	342	0190	405	0223	397
0146/60	343	0190T	406	0224-	397
0147	373	0192	466	0225-	457
0148/500	459	0194	540	0226	471
0149	518	0195	423	0227-	457
0151	476	0196	399	0228	413
0152	462	0196-	399	0229	477
0153-	458	0197	082	0230	065
0154-	458	0198	466	0231	477
0156-	535	0199	396	0232	356
0157-	345	0199P	396	0233	356
0158/500	535	0199P-	396	0234	481
0159	471	0200	395	0235	080
0160	464	0201	395	0236	383
0161	471	0201-	395	0237-	383
0162	463	0202	466	0238	226
0163	313	0203	355	0239/400	459
0164	502	0204	396	0241	377
0164/250	535	0205	344	0242	059
0165	499	0205/120	344	0243-	459
0166	463	0206	456	024xE	455
0167-	344	0207	444	024xI	455
0168	463	0208	396	0250	345
0169-	459	0208-	396	0252/230V	055
0171-	535	0209	547	0252/400V	055
0172/150	535	0211	356	0253	474
0173	413	0212	574	0254	341
0174-	342	0214	464	0255	066
0176	480	0215x	403	0256-	379
0177	479	0216/400	459	0257	478
0178	477	0217	377	0258	462
0179	478	0218-	544	0259	462
0180	478	0218/30B	544	0260	060
0181	425	0218/50T	545	0261	479

ART	PAG	ART	PAG	ART	PAG
0263	478	0307/1	479	0353/110	345
0264	341	0307/2	479	0355	442
0265/05	345	0308	413	0356	540
0266	400	0310	351	0357-	408
0267	466	0310B	352	0358	446
0268A	410	0311	548	0359-	407
0269	403	0312	587	035x	345
0271	368	0312/AB	587	0360	411
0272	542	0313	525	0362	067
0273	065	0315	499	0363-	332
0274	541	0316	073	0365	091
0277	448	0317	480	0366	545
0278-	203	0318	480	0367	471
0278/002S	203	0320	466	0368-	457
0278/005S	203	0321	534	0369	370
0278/008S	203	0322	475	0370-	457
0278/009S	203	0323/45	337	0371	141
0280	090	0323/55	337	0373-	457
0285/75	079	0325	473	0375A	370
0286-	573	0327	471	0376/AC	476
0287-	474	0329	411	0376/AI	477
0289	541	0331	305	0376/AL	477
028x	483	0332	221	0377	071
0290	354	0333	534	0378/1510	531
0291	548	0333/150	534	0379	456
0292-	083	0334/0750	079	0380	480
0293	480	0334/1000	079	0381	462
0294	477	0338	548	0382-	332
0295	476	0339	524	0383	073
0296	477	033x	459	0384	470
0298	477	0340S	400	0385	541
0299	478	0341	432	0386	541
0299/P	478	0341/3LS	433	0387A	586
0300	463	0341/5S	433	0390	341
0301-	463	0341-Sx	433	0391	462
0302/200	097	0341-x	432	0392	356
0302/245	097	0341-xL	433	0393	401
0302/305	097	0342	550	0393-	401
0303	540	0343	545	0393/A	401
0304	445	0344	546	0394-	345
0305	355	0350	315	0396	461
0305/0203/1118	356	0352-	408	0398	479
0306	463	0353/085	345	0399	502

ART	PAG	ART	PAG	ART	PAG
0400	405	0444	533	0490/03	353
0400-	404	0445/20	550	0490/11	353
0401	549	0449	578	0490/20	354
0402	447	0452	377	0492	548
0403	447	0453	451	0493/1	547
0404	447	0454	451	0493/2	547
0405	406	0455	451	0494-	412
0405-	406	0456	435	0495	101
0406	445	0457	370	0495/24	102
0407	445	0458	524	0496	101
0409	341	0459	285	0497-	085
0411	469	0460	524	0498	086
0412	527	0461	383	0499	087
0413	523	0462	351	0499/C	088
0414	523	0462/55	354	0502	073
0415	469	0463	226	0503	073
0416	523	0465	479	0504	089
0417	523	0466/4V	336	0505	098
0418	523	0466/CV	336	0506	028
0419	523	0466/DM	444	0507	101
0420	469	0466/PB	336	0507/07	102
0420/S	469	0466/SC	336	0507/14	102
0421	524	0467	380	0507/15	102
0422-	337	0468	479	0507/4R	102
0423/1	337	0469	451	0507/Y	102
0423/2	337	0470	451	0509/245	095
0424	473	0471	435	0509/305	095
0425-	122	0472	474	0509/340	095
0426-	409	0473-	535	0510	072
0427-	342	0474/PA	542	0511	458
0428	551	0474/PE	542	0513	475
0429	550	0474/PP	542	0514-	458
0430	377	0476	398	0515	475
0431	534	0476-	398	0516	546
0433	587	0477	398	0517/59	088
0434	502	0481/15	531	0517A	087
0437	547	0482/3	547	0518/20	062
0439-	412	0483	081	0518/30	062
0441	533	0485	367	0518/38M	063
0442	401	0486	355	0518/50	062
0442-	401	0487	350	0518/55H	063
0443	533	0490	350	0518/80	063

ART	PAG	ART	PAG	ART	PAG
0519	464	0558/TX	405	0595	374
0520-xA	343	0559	089	0596	374
0520-xF	343	0559/T	089	0597	549
0520-xG	343	0560	079	0599	041
0520-xP	343	0561/B	590	05x	353
0520-xS	343	0562	445	0600	384
0521	481	0562N	445	0601	348
0522	067	0563-	121	0601/24	353
0523	098	0564	098	0601/30	353
0524	227	0565	069	0602	384
0526	227	0567	370	0603	455
0529	225	0568	069	0604	481
0530	546	0569	352	0605	348
0530A	546	0570	525	0606	482
0531A	141	0571	522	0607	527
0532A	141	0574	525	0608	527
0532A/230V	141	0575	349	0609	527
0536	141	0575/04	353	0610	527
0536A	141	0575/0580/12	354	0611	468
0537A	141	0575S	349	0612	467
0538A	141	0576	522	0613	467
0540-	402	0577/17	354	0614	400
0540/3	402	0578-	352	0614-	400
0540S	402	0579-	352	0615	348
0541S	399	0580	350	0617	467
0543	587	0580/01-6	353	0618	427
0544	395	0580S	350	0620	425
0545/EF	403	0581	352	0621/A3	551
0545/TF	405	0582-	352	0622	426
0546	395	0583	587	0623	467
0548	445	0584-	476	0624	424
0551	071	0585	518	0625	547
0552	071	0585-	476	0626	446
0552/400V	071	0586	519	0626L	446
0553	071	0587	518	0627	467
0554	071	0587-	476	0627/L	468
0554/400V	071	0588-	476	0628	454
0555	073	0588/6	519	0629	471
0556	071	0589	424	0630/0900	375
0558/EM	404	0590	387	0630/2200	375
0558/EP	404	0591-	342	0630/2720	375
0558/GE	403	0594	374	0632	356

ART	PAG	ART	PAG	ART	PAG
0632-	357	0666	578	06x	385
0632/01	356	0667/100	077	0700-	394
0633	441	0667/150	078	0700/07P	394
0634	441	0668	082	0700/12P	394
0635/25	385	0670	472	0701	077
063xE	455	0670/U	472	0706	534
063xI	455	0671/1P	548	0708	028
0640	448	0672	472	0709	315
0641	526	0672/B	473	0710	029
0642	068	0673	473	0711-	124
0644	526	0677	536	0712-	204
0645/C	378	0677/500	536	0712/002	204
0645/CC	378	0677/500CG	536	0712/005	204
0645/CP	378	0677/CG	536	0712/008	204
0645/S	378	0677/IA	536	0712/009	204
0645/SS	378	0677/SO	536	0712/010	205
0646/A	578	0678	481	0712/900	205
0647/25	470	0679	424	0712-x0	205
0647/25L	470	0682	339	0712-x00	205
0647/50	470	0683	339	0713/15	545
0647/50L	470	0686/200	088	0713/18	545
0647/65	470	0686/200C	088	0713/27	545
0647/65L	470	0687	349	0714	400
0648	085	0687/005	353	0715-	139
0649-	374	0687/029	353	0716	029
0654-xF	391	0687/041	354	0716/B	029
0654-xL	391	0687/102	354	0716S	029
0655/L	472	0688	136	0717A	097
0655/R	472	068x	339	0719	083
0655/S	472	0690-	394	0720	099
0656/254	090	0690/07P	394	0720/L	099
0656/310	090	0690/12P	394	0721	082
0657	028	0691/400V	077	0722	083
0657/B	029	0692/230V	066	0723	083
0658	371	0692/400V	066	0724/B	471
0659	547	0693A	549	0725	527
0660-	540	0694	533	0725L	527
0661	546	0696	468	072x	460
0662	078	0696/L	468	0732	447
0663	368	0697	088	0733	462
0664	368	0698/100	107	0734/1	462
0665	089	0699/240	472	0734/2	462

ART	PAG	ART	PAG	ART	PAG
0735	251	0765	099	0814	454
0736	251	0766/090	108	0815-	410
0737-	465	0766/125	108	0816	313
0738-	465	0766/150	108	0817	313
0739-	465	0773-	081	0818/250	472
073x	460	0773/05L	081	0819-	482
0740-	465	0773/10L	081	0820-	482
0741-	465	0775	081	0821/14	482
0742-	465	0776	080	0822	482
0747	483	0776/610	080	0823	482
0748	483	0777/2	530	0824-	579
0749	087	0777/3	530	0826	455
0749/C	088	0780	458	0829	444
0749/M	088	0781	458	0830	227
0749/MC	088	0782	390	0831-	456
0750	059	0783-xF	530	0833	315
0750CM3	059	0783-xM	530	0834-	456
0751	084	0784	526	0835/15	227
0751/A4	122	0785-xF	530	0836	587
0751/P	122	0785-xM	530	0839-	460
0752	056	0786	522	0839-xT	460
0752CM3	056	0787	548	0840	550
0753/A	099	0789	451	0841	454
0753/L	099	0791-	387	0843	454
0754/230V	055	0792	468	0844	474
0754/400V	055	0792/L	469	0846/150	474
0755	542	0793	532	0847	454
0756	101	0794-	459	0849	332
0756/F	102	0795/1	423	0855	096
0756/S	102	0795/2	423	0855-	406
0756/T	102	0799-	226	0856-	404
0756/Y	102	07x	251	0857	046
0757	046	0803-	411	0861	482
0758	084	0803/S080	411	0862	475
0758/C	084	0803/S210	411	0864	533
0759	101	0804	075	0865	533
0759/F	102	0804/MD	076	0869	471
0759/S	102	0805/400	579	0870/250	091
0760	483	0806/020	410	0871	091
0762-	251	0806/200	409	0872/OPD	452
0762/190	251	0808-	459	0872/P	452
0764	094	0809-	409	0872/PCD	452
0764/455	094	0813	454	0872/PDD	452

ART	PAG	ART	PAG	ART	PAG
0873/TF	453	16-CM	128	A007/20	325
0873/TL	452	16-D	128	A007/21	325
0873-BC	452	16ERx	178	A007/21I	325
0873-BD	452	16IRx	178	A007/22	325
0873-U	452	1-xA	124	A007/23	324
0876	479	1-xD	124	A007/LED	326
0877	480	2622x	121	A007/LED/C	326
0878	349	2-xA	130	A007A	319
0880/307	442	2-xB	130	A007B	319
0881/008	442	2-xD	131	A007C	319
0888	444	3/B/40	126	A007D	319
0889	549	3A40-	126	A007E	320
0890	233	3-CM	126	A007F	320
0890-	233	3D40-	126	A007G	320
0891A	546	4-	129	A007H	320
0892	082	4-xB	129	A007I	321
0893	083	4-xD	130	A007L	321
0895-	398	A001-	125	A007M	321
0896-	398	A003/13A	074	A007N	321
0897-	233	A003/13ACBN	076	A007P	322
08x	454	A003/13ASDC	076	A007Q	322
08xx	454	A003/32	074	A007R	322
0900	550	A003/32CBN	076	A007S	322
0900/BL	550	A003/32SDC	076	A007T	323
0901	340	A004/14	075	A007U	323
0902	340	A004/14CBN	076	A007UF	323
0903	340	A004/14SDC	076	A007V	323
0904	340	A004/20	075	A007-xP	326
0905	341	A004/20CBN	076	A008A	319
0906	341	A004/20SDC	076	A008B	319
0907	340	A005	585	A008C	319
1/1B40	124	A007/01	325	A008D	319
1/1B50	124	A007/02	324	A008E	320
1/2B40	124	A007/03	324	A008F	320
1/2B50	124	A007/04	324	A008G	320
1/3B40	124	A007/05	324	A008H	320
1/3B50	124	A007/06	324	A008I	321
1/4B40	124	A007/07	325	A008L	321
1/4B50	124	A007/10	325	A008M	321
1/5B50	124	A007/11	325	A008N	321
165x	178	A007/16	325	A008P	322
16Ax	128	A007/17	324	A008Q	322
16-B	128	A007/18	324	A008R	322

ART	PAG	ART	PAG	ART	PAG
A008S	322	A208B-	206	AxDC	212
A008T	323	A212-	206	AxSC	212
A008U	323	A300	329	B001-	132
A008UF	323	A481/10	531	B003/5/1	590
A008V	323	A481/15	531	B004-	590
A010-	551	A481/15H	531	B004/150	591
A010/30	551	A481/30H	531	B005-	179
A010/30T	551	A601A	528	B006-	461
A010-x	551	A601DS	528	B007-	146
A013/26M	076	A602A	528	B009/A1	328
A0132A	075	A901A	529	B009/A2	328
A0132A/MB	076	A902A	529	B009/B1	328
A0132A/MR	076	ACAS/001	360	B009/B2	328
A014-	209	ACAS/002	360	B010	571
A014/03-30S	209	ACAS/003	360	B012-	181
A015-	567	ACAS/004	360	B013-	181
A016-	562	ACAS/005	360	B014-	181
A017x	568	ACAS/006	360	B015	327
A018x	568	ACAS/007	360	B015/10	327
A019-	571	ACAS/008	360	B017/C	327
A020	562	ACAS/009	360	B018	590
A021	563	ACAS/010	360	B019	328
A024/10	358	ACAS/011	360	B019/G030	328
A024/602	359	ACAS/012	360	B021	590
A025/30	358	ACAS/013	360	B022/10	327
A040/30A	358	ACAS/014	360	B022/15	327
A040/60A	358	ACAS/015	360	B025	571
A040/802	359	ACAS/017	360	B031	590
A040/8029	360	ADF-	293	B0x	566
A040/803	359	ADLTx	175	B100	569
A040/8037	360	ADLTxA	175	B201/1	569
A040/8040	360	ADLTxA1	175	B201/2	569
A040/8046	360	ADR3/6	276	B201/3	569
A040/8047S	360	AN2G/12/1	385	B201/4	569
A040/8047U	360	AP01	520	B609	543
A040/8048	360	AP02	520	B610	543
A059/M	076	AP03	520	BASECKJNL	164
A100	329	AP04	520	BASECKJNR	164
A12AL6	213	AP05	521	BGAx	300
A162A	529	AP05/150	521	BI413L0x	429
A162C	529	AP06	521	BI423Lx	429
A162DS	529	APKTx	175	BI433Mx	429

ART	PAG	ART	PAG	ART	PAG
BI443Mx	429	BRAS4103x	180	C018-	555
BI4E1Lx	431	BRAS4104x	180	C019/150	556
BI4E1Nx	431	BRAS4109x	181	C020-	557
BI4E2Lx	430	BRAS4111x	180	C021-	557
BI4E2Nx	430	BRCIx	180	C022/100	080
BI4E3Lx	428	BRFEx	180	C023	560
BI4E3Nx	428	BRFlix	180	C023/N	560
BN413Lx	420	BSAx	300	C023G	560
BN413Nx	420	BSCL09	164	C025-	567
BN414Lx	417	BSCL12	164	C025-3x	567
BN414Nx	417	BSDJ11	164	C026-	575
BN415Nx	414	BSER16	164	C027-	575
BN423Lx	420	BSNR16	164	C028-	575
BN423Nx	420	BSSS12	164	C029-	575
BN424Lx	417	BSTG16	164	C030-	391
BN424Nx	417	BSVJ16	164	C031/150	554
BN425Nx	415	BU3550	164	C033-	554
BN433Lx	420	BU4050	164	C035-	554
BN433Nx	420	BU4560	164	C038/30	370
BN434Lx	417	BxAL	213	C039/15	371
BN434Nx	417	BxDC	213	C039/25	371
BN443Lx	421	BxDCxL	213	C041/150	554
BN443Nx	421	BxSC	213	C043-	555
BN444Lx	418	BxSCxL	213	C044-	557
BN444Nx	418	C001-	220	C046-	135
BN445Nx	415	C002	560	C048	561
BN4C3Lx	421	C002/42	561	C049/300	557
BN4C4Lx	418	C003-	220	C050-	135
BN4E2Nx	422	C004	560	C051	111
BN4E3Lx	419	C005/150	555	C052	111
BN4E3Nx	419	C006-	555	C053-	135
BN4E4Lx	416	C007-	558	C054	111
BN4E4Nx	416	C009	381	C055-	135
BN4E5Lx	414	C010/200	558	C056/200	556
BN4E5Nx	414	C010/200P	558	C057/150	556
BN4P2Nx	422	C011-	556	C058	575
BN4P3Lx	419	C012-	461	C060	560
BN4P3Nx	419	C014-	562	C061	563
BN4P4Nx	416	C015	461	C062	563
BN4P5Nx	414	c015-	461	C063	563
BR10/10	179	C016	562	C063/L	563
BR10/12	179	C017	560	C064	560

ART	PAG	ART	PAG	ART	PAG
C065/2	381	C650	381	C960/PG	334
C067	586	C700	330	C960/PL	334
C069	586	C750	381	C960C3C	487
C070	586	C800	329	C960CA	486
C075/2	381	C800-	330	C980	336
C076/30	082	C855-	406	C980/CC01	484
C080-	330	c856-	404	CAR115280/060	287
C085-	330	C880/006	441	CAR115280/080	287
C086/01C	331	C881-	441	CAR115280/120	287
C086/01T	331	C881/006	441	CB01-	437
C086/02C	331	C882-	440	CB01/04P	438
C086/02T	331	C882/2038	440	CB01/07P	438
C086/04C	331	C883-	440	CB01/11P	438
C086/04C/D	331	C884-	440	CB02-	437
C086/04T	331	C884/6038	440	CB02/04P	438
C086/12C	331	C885-	440	CB02/07P	438
C086/12C/D	331	C885/2038	441	CB02/11P	438
C087	332	C900/A	333	CBF1-	437
C090-	332	C900/B	333	CBF1/10P	438
C1101	382	C900/CC01	487	CCGx	298
C1102	382	C900/CC03	488	CCMTx	168
C163	338	C900/CC04	488	CCMTxA	168
C165	338	C900C3C	489	CF08	558
C170P	382	C900CA	489	CHERx	127
C182	382	C960/1A	490	CI80/006	442
C183	382	C960/2A	490	CI82-	442
C184	383	C960/3A	490	CI83-	442
C189	382	C960/4A	491	CKJNx	151
C245-	407	C960/5A	491	CKUNR	155
C313	337	C960/7A	491	CN450N0/0	412
C315	337	C960/8A	491	CN450Nx	412
C360	337	C960/AM01	484	CNMGx	168
C371	338	C960/CC01	485	CNMGxF15	168
C391-	407	C960/CC03	485	CNMGxF25	168
C395-	407	C960/CC04	486	CNMGxM25	169
C586	518	C960/F6	335	CNMGxM35	169
C589	519	C960/F7	335	CR20x	480
C600	329	C960/F8	335	CRDxC	289
C600-	330	C960/MP	334	CRDxT	289
C603	329	C960/PC	334	CSCD-	293
C603-	330	C960/PD	334	CSDS-	293
C648	338	C960/PF	334	CSF-	293

ART	PAG	ART	PAG	ART	PAG
CTFP10/12	164	DC200	298	DN2300-Z	269
CTFPBASE25/32	164	DCGx	298	DN4100-A	267
CTFPx	154	DCK100	297	DN4100-Z	265
CTMTMC16/20	164	DCMTx	169	DN4300-A	267
CTMTMC25/32	164	DCMTxA	169	DN4300-Z	265
Cx	381	DCTx	297	DN4550-Z	265
CxAL	214	DCVx	297	DN6100-A	263
CxDC	214	DF2100-A	270	DN6100-Z	261
CxSC	214	DF2100-Z	268	DN6300-A	263
D001	588	DF2150-A	270	DN6300-Z	261
D003	109	DF2150-Z	268	DN6550-Z	261
D004-	111	DF4100-A	267	DN8100-A	259
D005-	110	DF4100-Z	264	DN8100-Z	257
D006-	111	DF4150-A	267	DN8300-A	259
D007/A	589	DF4150-Z	264	DN8300-Z	257
D009/5-12	225	DF4600-Z	266	DN8550-Z	257
D009/5-85	225	DF6100-A	263	DN9100-ZC	272
D010-	591	DF6100-Z	260	DN9101-C	273
D011/A	589	DF6150-A	263	DNMGx	169
D011/D	589	DF6150-Z	260	DNMGxM25	170
D012-	591	DF6600-Z	262	DNMGxM35	170
D018	588	DF6700-Z	262	DNW100	298
D020	225	DF8100-A	259	DSCx	297
D023	109	DF8100-Z	256	DSK100	297
D040-	315	DF8150-A	259	DSTx	297
D045-	313	DF8150-Z	256	DxAL	214
D050	225	DF8600-Z	258	DxDC	214
D054-	315	DF8700-Z	258	DxSC	214
D055-	314	DF9100-ZC	271	E001	435
D059-	314	DF9101-C	273	E002-	125
D060-	314	DF9103-M	274	E003	435
D070-	314	DF9150-ZC	271	E005	435
D100	313	DF9153-M	274	E010	237
D100/S	313	DF9800-ZC	272	E010-	237
D17x	282	DF9801-C	273	E010B	237
D880/006	439	DFC115/M14	296	E010-BSFxEx	245
D882-	439	DFFx	296	E010-BSWxEx	245
D882/2038	439	DFVx-xA	281	E010E	237
D883-	439	DFVx-xZ	281	E010-MxE1	242
D884-	439	DLFx	295	E010-MxE15	243
D884/6038	439	DMV150	298	E010-MxE2	243
D885-	439	DN2100-A	270	E010-MxE25	244
D885/2038	439	DN2100-Z	268	E010-MxE3	244

ART	PAG	ART	PAG	ART	PAG
E010-MxExA	245	ExDC	215	F122-	234
E010-MxExC	240	ExSC	215	F123	234
E010-UNCxEx	245	F001/10	210	F23x	210
E010-UNFxEEx	246	F001/20	210	F256-	162
E011/BSF	241	F002-	196	F256/644	164
E011/BSW	240	F002/6	196	F256/648	164
E011/M140X125B	239	F002/P	197	F2Gx	577
E011/M140X125MCB	240	F002/PL	197	F300-	160
E011/MC	240	F002-xL	197	F301-	160
E011/UNC	241	F002-xP	196	F302-	160
E011/UNF	242	F002-xPL	197	F303-	162
E011A	238	F005-	211	F304-	161
E011-Ax	249	F006-	211	F306-	160
E011B	238	F007-	211	F307/16/22	163
E011-BSFx	241	F008-	219	F308-	162
E011-BSFxM	247	F008DC	219	F32x	577
E011-BSWx	240	F008SC	219	F400-	161
E011-BSWxM	247	F010	585	F401-	161
E011C	238	F011-	195	F402-	161
E011D	238	F011/6	195	F403-	163
E011-Ex	249	F011-xP	195	F406-	163
E011-M140x125Ex	240	F015-	201	F407-	162
E011-Mx1	239	F015/005	201	F430	209
E011-MxC	239	F015/006S	201	F585	518
E011-MxM	246	F015/007	201	F588/6	518
E011-MxMC	247	F015/008S	201	F639	209
E011-UMx	248	F015-A	201	F68x	577
E011-UNCx	241	F018	473	F80x	577
E011-UNCxM	248	F019-	199	F813	577
E011-UNFxE	242	F019/005	199	FB12CD3AS-22B	505
E011-UNFxE M	248	F019/006	199	FB20AG3AB-12B	508
E011-Ux	249	F019/007	199	FB20AG3AB-14B	508
E022/12	581	F019/008	199	FB20AG3AB-22B	508
E022/5	581	F025	210	FB20AG3AB-24B	508
E022/P	581	F050	034	FB20AG3AB-B	508
E190-	436	F050B	035	FB20BC3A2-K	511
E190-Bx	436	F050I	034	FB20BC3A4-K	511
E191-	436	F050U	033	FB20CD3AB-12B	507
EN403Nx	421	F060	033	FB20CD3AB-14B	507
EN404Nx	418	F060I	032	FB20CD3AB-22B	507
EN405Nx	415	F060V	032	FB20CD3AB-24B	507
ERW100	279	F090-	412	FB20CD3AB-B	507
ExAL	215	F121-	234	FB20ID3AB-12B	507

ART	PAG	ART	PAG	ART	PAG
FB20ID3AB-14B	507	G002-	233	JN403NA	421
FB20ID3AB-22B	507	G003-	233	JN404NA	418
FB20ID3AB-24B	507	G005	580	JN405NA	415
FB20ID3AB-B	507	G006-	580	JxDC	218
FB20IS3AB-K	509	G007-	151	JxSC	218
FB20IW3AB-K	509	G008	580	K001-	114
FB20LB3A2-E	511	G009	460	k002-	114
FB20LB3A4-E	511	G011/1	233	KICAN	155
FB20LL3AX-K	510	G011/2	233	KISCLCR	152
FB20RH3AB-24B	508	G030-	537	KISER	155
FB20RH3AB-B	508	G090-	412	KISNR	155
FC94/245	096	G0x	127	KISTCMT	152
FC94/350	096	G900	549	KISTFCR	152
FCGx	298	GCMX	178	KITCKJ	148
FD0x-	121	GCMXA	178	KITCKJ16	148
FDCx	281	Gx	328	KITPCLNR16	147
FFAG07203A-115K	515	GxAL	216	KITPCLNR20	147
FFAG08603A-125K	515	GxDC	216	KITPCLNR25	147
FFAG12003V-125K	515	GxSC	216	KITPDJNR20	148
FFAG22003A-230K	515	HT125	574	KITPDJNR25	148
FFCS15003A-190K	516	HxAL	216	KITPSSNR16	148
FFID06003A-K	513	HxDC	216	KITPSSNR20	148
FFID08103A-K	513	HxSC	216	KITPSSNR25	148
FFJS07103A-K	516	I002	584	KITPTGNR16	147
FFOS03503A-K	517	I109	434	KITPTGNR20	147
FFRH08003A-B	514	I217	433	KITPTGNR25	147
FFRH10503A-B	514	I306	433	KITPWLNR20	148
FFRS04503A-150K	517	I340	432	KITPWLNR25	148
FFSF14003A-110K	516	IS25-ESx	449	KITSCLCR12E	146
FGx	574	IS25-PHx	449	KITSCLCR16E	146
FGx-AI	574	IS25-PHxAS	449	KITSCLCR20E	146
FLIx	288	IS25-PZx	449	KITSCLCR25E	146
FPA120-	292	IS25-PZxAS	449	KITSDJCR10	147
FRFx	277	IS25-TGx	449	KITSDJCR12	147
FSAx	300	IS25-TXx	449	KITSDJCR16	147
FTRx	287	IS50-ESx	449	KITSDJCR20	147
FTx-1000	386	IS50-PHx	450	KITSDJCR25	147
FTx-2000	386	IS50-PZx	450	KITSSSCR20E	146
FTx-3000	386	IS50-TGx	450	KITSSSCR25E	146
FxAL	215	IS50-TXx	450	KITSTGCR16	146
FxDC	215	JI40xL	434	KITSTGCR20	146
FxSC	215	JI40xN	434	KITSTGCR25	146
G001-	234	JN402NA	422	KITSVJBR20	147

ART	PAG	ART	PAG	ART	PAG
KITSVJBR25	147	M003-	232	M033-	564
KNUX	170	M003-xV	232	M033-x	564
KVx	164	M003-xxV	232	M034/120	107
KxDC	218	M003-xxx	232	M036	228
KxSC	218	m004-	129	M038	139
L006	547	M005A/200	120	M040	361
L007	466	M005A/250	120	M040/CF	361
L008	549	M005A/320	120	M040/CP	361
L011	464	M005A/400	120	M040/D	361
L012	464	M005A/500	120	M040/SA	361
L012/PIA	464	M005A/630	120	M040/SP	361
L013	464	M006-	344	M040/ST	361
L014	586	M007-	344	M041	361
L018-	207	M009-	565	M042-	123
L018S	207	M010-	565	M049A/080	118
L019-	207	M011-	103	M049A/080ST	121
L019S	207	M011-xG	104	M049A/100	118
L020	208	M012-	104	M049A/100ST	121
L020-	207	M013/0/100	565	M049A/125	118
L020S	207	M014-	105	M049A/125ST	121
L080	579	M015S	228	M049A/160	118
L085	579	M016/075	106	M049A/160ST	121
L090A	579	M016/100	106	M049A/200	118
L10AL6	217	M017/080	106	M049A/200GBD	121
L150	580	M017/100	106	M049A/250	118
L200	579	M018-	344	M049A/250GBD	121
LB09/2720	250	M019-	565	M049A/320	118
LB11/2720	250	M019-x	565	M049A/320GBD	121
LBx	250	M020	228	M049A/400	118
LN400N1/2A	421	M021-	564	M049A/400GBD	121
LN400N1/4A	415	M022-	564	M051-	123
LN400N3/4A	422	M023-	105	M052-	123
LN400N3/8A	418	M024-	105	M055	562
LSL76-20	251	M026-	564	M055/120	562
LSM76-12	251	M027-	106	M057/16	088
LxDC	217	M028-	103	M059-	131
LxSC	217	M028-xG	104	M060-	131
M001-	106	M028-xGR	104	M061	104
M001-x	231	M029	229	M062	562
M001-xV	231	M030	229	M069	581
M002-	231	M032	228	M071	581
M002-xV	231	M033	564	M072	581

ART	PAG	ART	PAG	ART	PAG
M075A/080	117	M300/B	338	ML80A	583
M075A/100	117	M312/C	228	MSCx	291
M075A/125	117	M312/P	228	MSD4x	310
M075A/160	117	M430/B	338	MSD6x	310
M075A/200	117	M449A/080	118	MSD8x	310
M075A/250	117	M449A/080ST	121	MTD4x	308
M075A/320	117	M449A/100	118	MTD6x	308
M075A/400	117	M449A/100ST	121	MTD7x	309
M076A/080	117	M449A/125	118	MTFNBASE25/32	164
M076A/100	117	M449A/125ST	121	MTFNx	154
M076A/125	117	M449A/160	118	MTP4x	308
M076A/160	117	M449A/160ST	121	MTP6x	307
M076A/200	117	M449A/200	118	MTP7x	309
M076A/250	117	M449A/200GBD	121	MTP8x	307
M076A/320	117	M449A/250	118	MTP9x	309
M076A/400	117	M449A/250GBD	121	MVx	311
M078A/160/D1-4	119	M449A/320	118	Mx	140
M078A/200/D1-4	119	M449A/320GBD	121	MxDC	217
M078A/200/D1-5	119	M449A/400	118	MxSC	217
M078A/250/D1-5	119	M449A/400GBD	121	N12DC6	218
M078A/250/D1-6	119	M505/B	339	N7x	250
M078A/250/D1-8	119	M530-	105	N7x1	250
M078A/320/D1-6	119	M540/BT	339	NAS100x-A	278
M078A/320/D1-8	119	MBGxA	312	NAS100x-C	279
M078A/400/D1-8	119	MBGxC	313	NAS100x-Z	278
M079A/160/D1-4	119	MBx	311	NAT100x	279
M079A/200/D1-4	119	MCDxZ	275	NTxA	290
M079A/200/D1-5	119	MCG2050/06G	312	NTxZ	290
M079A/250/D1-5	119	MCGxA	312	NWS100	280
M079A/250/D1-6	119	MCGxC	312	NWS100/M	280
M079A/250/D1-8	119	MCGxS	312	NxSC	218
M079A/320/D1-6	119	MCLNBASE25/32	164	OFEXx	175
M079A/320/D1-8	119	MCLNx	154	OFEXxA	176
M079A/400/D1-8	119	MD01	586	ONMXxA	176
M080-	123	MDAxZT	282	P001/04	366
M081-	123	MDFx	295	P001/10	366
M100	229	MDUx	294	P001/12	366
M101	229	MFDxZ	275	P001/20	366
M10AL6	217	MFDxZC	275	P001/30	365
M13x	338	MFGx	296	P001/45	365
M16x	311	MGx	311	P001/75	365
M218	229	ML40	583	P002	362

ART	PAG	ART	PAG	ART	PAG
P005	362	P033/03S	224	P080	582
P007-	576	P034-	224	P081-	193
P008/102	080	P034/05S	224	P100/250	140
P009	329	P034/06S	224	P101-	140
P010/41	189	P035-	225	P20x	576
P010/51	189	P035/04S	225	P30x	576
P011-	576	P036-	210	P340A	133
P012-L	362	P037-	210	P350A	133
P012-LxP	362	P039	363	P40VD	326
P012-N	362	P039/PR	363	P440A	133
P012-NxP	362	P045	184	P444A/125	120
P013	589	P046	184	P444A/160	120
P014	108	P049-	221	P444A/200	120
P015	108	P04x	572	P444A/250	120
P017	108	P050-	221	P444A/320	120
P018-	139	P051-	221	P444A/400	120
P019	383	P052-	226	P450A	133
P020	363	P052/08S	226	P4ACS	134
P020/P	363	P056-	193	P880/06S	444
P021	362	P056/10S	193	P881-	443
P022-	367	P057	192	P881/06S	444
P023-	186	P058-	189	P882-	443
P023/19	186	P058/170	189	P883-	443
P023/25	186	P061	189	P886-	443
P023-xC	187	P062	189	PARx	292
P023-xL	187	P063-	221	PAS-	295
P023-xL1	187	P064-	191	PAV	326
P023-xL2	188	P064/19A	191	PC40A	134
P023-xL3	188	P064/25A	191	PC40A/R	134
P024/06	541	P065-	190	PC50A	134
P024/15	541	P067	190	PC50A/R	134
P028-	367	P068	189	PCLNx	150
P029-	367	P069	190	PCR6338	289
P031-	223	P075	582	PDBx	284
P031/03S	223	P076-	222	PDC1-	385
P031/05S	223	P076/006S	222	PDC2-	385
P031/06P	223	P076/008S	222	PDC4-	384
P031/06S	223	P076-Gx	222	PDJNRKIT	164
p032-	127	P076-Px	222	PDJNx	151
P032/18P	127	P077-	114	PDMx	284
P032/7P	127	P078-	114	PDVx-M14	285
P033-	224	P079-	114	PFBx	282

ART	PAG	ART	PAG	ART	PAG
PFLx	285	RFTx	277	S017	378
PFSx	282	RGFx	295	S018	450
PI063	446	RGMx	276	S019	373
PI401x	434	RGPx	277	S022-	461
PI402x	430	RGTx	276	S023	072
PI403x	429	RI40x	434	S024	373
PI453x	429	RICAPCLN	164	S026-	208
PIF1	444	RICAPSSN	164	S026/06-20S	208
PLV175	299	RICAPTGN	164	S026/06-20SM	208
PMEx	285	RLFx	277	S027	376
PN402Nx	422	RLMx	278	S027ATV	376
PN403Nx	421	RLPx	278	S029	376
PN404Nx	418	RLTx	278	S029P	376
PN405Nx	415	RMTx	276	S033	373
PNS	299	RN4023NA	422	S042/1	570
PPSx	285	RN4032NA	421	S042/2	570
PR16/10P	127	RN4034NA	421	S042/3	570
PR20/12P	127	RN4043NA	418	S045	571
PR25/15P	127	RN4045NA	418	S046	571
PSSNx	150	RN4054NA	415	S047	570
PSV-F	326	RPMTx	176	S048-	573
PSV-M	326	RPW090	279	S049	570
PTGNx	150	RSAx	286	S050-	572
PVC300	483	RSRx	286	S051	571
PVC300/125	483	RSSx	286	S051-	572
PWLNRRKIT	164	RTFx	287	S052/2	569
PWLNx	151	Rx	559	S052/3	569
R001-	068	S001	208	S052/4	570
R003/09	068	S001/60	209	S054	570
R015	373	S002	469	S055	570
R0x	578	S002/E100	469	S056-	573
R608	543	S002/E200	469	S057/060S	573
R609	543	S002/E300	469	S057/125	573
R60xA	543	S004	587	S058	573
R60xB	543	S005	470	S059-	572
R610	543	S005/R	470	S068	373
RASx	286	s007-	133	S06x	572
RCLx	287	S008/M	377	S075-	530
RCSx	288	S009	100	S091	568
RDHTx	176	S013	377	S0x	208
RFF100	296	S014-	133	S100	140
RFPx	278	S015	100	S108	426

ART	PAG	ART	PAG	ART	PAG
S110	589	SCMTxA1	170	SNMGxM25	171
S111	589	SCMTxA2	171	SNMGxM35	172
S169	295	SCMTxA3	171	SNMXx	177
S179	427	SCRx	302	SNRx	156
S1x	209	SCRxI	302	SPA115/M14	291
S2/800	389	SC5x	279	SPIxZ	288
S328	425	SDJCx	150	SPKNx	177
S383	072	SDUCx	153	SPMRx	172
S401/00	537	SEHTx	176	SPUN13P	079
S401/01	537	SEHTxA	176	SR44W	480
S401/02	537	SEHXx	177	SRFx	301
S401/03	537	SEHXxA	177	SRFxI	301
S401/04	537	SEKNx	177	SRGx	303
S401/05	538	SERx	156	SRGxI	303
S401/06	538	SFFx	275	SRRx	302
S401/07	539	SFGx	304	SRRx-M14	302
S401/08	538	SFGxI	304	SSSCRx	152
S401/09	538	SFPx	304	SSSCxE	149
S401/10	538	SFPxI	305	ST1Ax	184
S401/11	538	SFRx	305	ST1AxC	184
S401/12	539	SFRxI	305	ST1AxR10	185
S401/13	539	SGCx	289	ST1AxR13	185
S401/14	539	SGFx	275	ST2Ax	192
S401/15	539	SGIH	157	ST45-	125
S401/16	539	SGR075	303	ST45-xL	125
S503	072	SGR075I	303	STAFCKJNL	164
S510	072	SGTBK	157	STAFCKJNR	164
S520	424	SI40N006	434	STFCx	153
SA01/A	351	SI413M006	432	STFx	301
SA01/C	351	SI423M006	432	STFxI	301
SA01/F	353	SI4E1N008	434	STGCx	149
SA01/TR	351	SI4E2N008	434	STGx	304
SA01-CTRx	351	SI4E3N013	432	STGxI	304
SALx	300	SMC275	305	STRx	302
SCDx	291	SMC275I	305	STRxI	302
SCFx	301	SN4E3C015	423	SVJBx	149
SCFxI	301	SN4E4C013	423	SWS100	279
SCG090	303	SN4E5C012	423	SWS100/M	280
SCG090I	304	SN4P3N027	425	Sx	384
SCLCx	153	SNGx	303	T001-	110
SCLCxE	149	SNMGxF15	171	T002-	110
SCMTx	170	SNMGxF25	171	T003-	561

ART	PAG	ART	PAG	ART	PAG
T004-	113	T049x	568	T092-	559
T005	561	T050	583	T094F	007
T006	561	T051	582	T094F10	007
T007-	561	T052/400V	040	T094F20	007
T008	113	T052/400VDA	040	T094F30	007
T009	569	T053	583	T095F	006
T00A1	138	T054	584	T095F10	006
T00A1/LR	138	T055	585	T095F20	006
T00A1/PL	138	T056/TP01	585	T095F30	006
T00A1/PP	138	T056/TP02	585	T09x	157
T00A1/SP	138	T056/TP03	585	T0Ax	137
T00Ax	137	T057	584	T0Ax-D	137
T00Ax-PP	137	T058	038	T100-	559
T00x	136	T059/16V	038	T145	050
T00x-B	136	T059/28V	037	T200	139
T00x-D	136	T061A	037	T201	139
T00x-LC	137	T062	051	T202	140
T00x-S	137	T063	584	T203	140
T010-	132	T064	584	T338-	140
T011	561	T066	050	T609	543
T013	112	T068	584	T660	027
T014G	112	T069/400V	015	T660I	027
T015	112	T069/400V3A	015	T700	026
T015/E	112	T069/400VI3A	014	T700V	026
T016/100	109	T070/400V3A	013	T750	025
T017/100	109	T070/400V3A15	011	T750I	025
T018/330	113	T070/400VI3A	012	T900	024
T018/350	113	T071	054	T900I	024
T021-	132	T072	053	T900I2A/FULL	023
T032	054	T072DA	052	T940/230V	021
T032DA	053	T073	039	T940/230VI	020
T034/065	081	T073DA	039	T997/230V	019
T034/105	081	T075I	010	T997/230V3A	019
T041	052	T080F	009	T997/230VI	018
T041DA	051	T080F10	009	T997/230VI3A	018
T044/230V	036	T080F20	009	T997/400V	019
T044/400V	036	T085F	008	T997/400V3A	019
T046	041	T085F10	008	T998/230V3A	017
T047/230V	036	T085F20	008	T998/400V	017
T047/400V	036	T085F30	008	T998/400V3A	017
T047/400VDA	035	T088	156	T998/400VI3A	016
T048x	568	T089	156	T999/3A	139

ART	PAG	ART	PAG	ART	PAG
TCMTx	172	TM01/043	497	VDA150/060F8	283
TCMTxA	172	TM01/044	494	VDA150/080F8	283
TDV	285	TM01/045	494	VDA150/100F8	283
TEV120	285	TM01/046	494	VDA150/120F8	283
TGx-AE	574	TM01/047	497	VDA150/180F8	283
TH250	530	TM01/048	497	VDA150/220F8	283
TH500	530	TM01/049	497	VDAx	283
TH601A	528	TM01/050	497	VDFx	296
TH602A	528	TM01/052	497	VDGx	283
TH901A	528	TM01/053	494	VDLx	299
TIPAx	131	TM01/054	497	VDRx	284
TIPDx	131	TM01/055	497	VDZ150/040F8	284
TM01/001	492	TM01/056	492	VDZ150/060F8	284
TM01/002	492	TM01/063	493	VDZ150/080F8	284
TM01/005	492	TM01/064	496	VDZ150/100F8	284
TM01/006	492	TM01/068	493	VDZ150/120F8	284
TM01/008	492	TM01/069	496	VDZx	284
TM01/009	492	TM01/070	494	VITECKJN	164
TM01/010	492	TM01/100	498	VLA200	299
TM01/011	493	TM01/110	498	VSCx	291
TM01/012	493	TM01/120	498	VSPx	299
TM01/014	493	TNMGx	173	VT00440	164
TM01/016	493	TNMGxF15	173	W021PA	526
TM01/018	493	TNMGxF25	173	W021PG	526
TM01/020	493	TNMGxM25	174	W021PN	526
TM01/022	494	TNMGxM35	174	WNMGx	172
TM01/023	494	TPKNx	177	WNMGxM25	173
TM01/024	494	TPMRx	174	WNMGxM35	173
TM01/025	495	TR01/180	045	WSSP	164
TM01/026	495	TR01/200	044	x-1000	386
TM01/027	495	TR01/280	043	x-2000	386
TM01/028	495	Tx	140	x-3000	386
TM01/029	495	U003	354	ZSAx	284
TM01/030	495	U004	354	ZSD8x	310
TM01/031	495	UC01-	357	ZTD8x	307
TM01/032	495	UNCD-	294		
TM01/033	496	UNFx	294		
TM01/035	496	UNPx	294		
TM01/036	496	V002	587		
TM01/037	496	VBMTx	174		
TM01/038	496	VBMTxA	174		
TM01/042	496	VDA150/040F8	283		

1. DISPOSIZIONI GENERALI

Fervi SpA è una società che opera commercializza prodotti a proprio marchio quali macchine utensili, accessori, strumenti di misura e prodotti genericamente chiamati articoli da ferramenta. Le condizioni generali di vendita, qui di seguito riportate, sono assunte da Fervi SpA e si intendono valide per qualsiasi ordine ad essa pervenuto, costituendone parte essenziale ed integrante e si applicano a tutte le vendite di prodotti dalla stessa effettuate.

Fervi si riserva il diritto di modificare le presenti condizioni generali di vendita in ogni momento e senza preventivo avviso. eventuali modifiche, deroghe e/o condizioni particolari rispetto alle presenti clausole provenienti dal Cliente non saranno comunque vincolanti per Fervi se non espressamente concordate in forma scritta e debitamente sottoscritte da entrambe le parti.

2. DEFINIZIONI

Ai fini delle presenti condizioni generali di contratto di vendita (di seguito denominate "Condizioni di vendita"), i seguenti termini avranno unicamente il significato di seguito ad essi attribuito:

- "Fervi/Il Venditore": Fervi SpA;
- "Cliente-/Compratore-": qualunque società, ente o entità giuridica che acquisti i prodotti di Fervi;
- "Prodotti/o": i beni prodotti, assemblati, venduti e/o distribuiti da Fervi;
- "Ordine/i": ciascuna richiesta scritta e/o proposta di acquisto dei Prodotti inoltrata dal Cliente a Fervi tramite fax, e-mail, rappresentante o qualunque altra modalità riconosciuta da Fervi;
- "Vendita/e": ciascun contratto di vendita concluso tra Fervi e il Cliente, anche tramite rappresentante;
- "Merce": quantitativo e tipologia di prodotto contenuti nell'Ordine del Cliente;
- "Catalogo": volume illustrativo dei Prodotti Fervi;
- "Resi": tutti i prodotti e le merci restituiti mediante la procedura prevista da Fervi
- "Marchio/i": tutti i marchi di cui Fervi è proprietaria, titolare e/o licenziataria;
- "Diritti di Proprietà Intellettuale": tutti i diritti di proprietà intellettuale ed industriale di Fervi, ivi inclusi, senza limitazione alcuna, i diritti relativi a brevetti per invenzioni, disegni o modelli, modelli di utilità, marchi, loghi, know-how, specifiche tecniche, dati, siano stati tali diritti registrati o meno, nonché qualsivoglia domanda o registrazione relativa a tali diritti ed ogni altro diritto o forma di protezione di natura simile o avente effetto equivalente.

3. PRODOTTI E MODIFICHE

I pesi, le dimensioni, i prezzi, i colori e qualsiasi altra caratteristica e dato anche di carattere figurativo inseriti nel Catalogo, nei listini, nei prospetti, illustrazioni, locandine, offerte, nel materiale pubblicitario in genere e/o altri documenti illustrativi di Fervi, hanno carattere di indicazioni approssimative e non sono in ogni caso impegnative per Fervi.

Il Venditore si riserva il diritto di variare in qualsiasi momento e senza obbligo di preavviso i dati tecnici o costruttivi dei suoi prodotti e di apportare agli stessi le modifiche che reputi in ogni caso necessarie.

Il Venditore non è tenuto in ogni caso ad apportare alle merci destinate al Cliente già prodotte, o in corso di produzione, le modifiche che siano intervenute successivamente all'ordine.

La tipologia di prodotti e la loro disponibilità potranno variare in qualsiasi momento senza che ciò comporti alcuna responsabilità per Fervi nei confronti dei Clienti.

Eventuali modifiche ai prodotti di Fervi non legittimano in ogni caso il Cliente a proporre reclami.

4. PREZZI

Il prezzo è espresso in euro e il prezzo per ogni singolo prodotto è quello indicato nel Catalogo e/o nel sito internet di Fervi ed è meramente indicativo e potrà pertanto subire variazioni senza necessità di preventiva informazione al Cliente.

Nell'ipotesi di offerte promozionali presentate da Fervi, il prezzo sarà quello indicato nelle stesse e potrà subire variazioni per alcuni prodotti, laddove specificato.

Salvo diverso accordo scritto tra le parti, la merce sarà fatturata ai prezzi in vigore al momento dell'ordine.

I prezzi si intendono al netto di iva, di eventuali imposte e tasse, nonché di tributi, diritti ed oneri fiscali o di qualsivoglia specie eventualmente gravanti sul contratto, che restano a carico esclusivo del Cliente.

Il costo dell'imballaggio è incluso nel prezzo, mentre il costo per la spedizione è sempre escluso.

5. ORDINI

Le presenti condizioni di vendita si intendono lette e approvate dal Cliente con la trasmissione dell'ordine, che viene in ogni caso ricevuto dalla Fervi con la clausola "Salvo approvazione della Casa". L'ordine deve essere definito in ogni sua parte e completo di tutte le indicazioni sia tecniche che amministrative, comprese le eventuali facilitazioni di carattere fiscale. In esso deve in ogni caso essere specificato il codice dell'articolo e le relative quantità.

Le quantità minime d'ordine per ciascun articolo sono indicate nel Catalogo.

Ordini non corrispondenti ad esse, o ai loro multipli, verranno automaticamente adeguati da Fervi senza necessità di previa autorizzazione del Cliente.

Salvo che non sia diversamente pattuito per iscritto tra le parti, l'ordine deve ritenersi irrevocabile ai sensi e per gli effetti dell'art. 1331 c.c..

Fervi si riserva la facoltà, a proprio insindacabile giudizio, di rifiutare o accettare anche solo parzialmente eventuali variazioni dell'ordine, proposte dal Compratore successivamente alla trasmissione dell'ordine.

E' espressamente esclusa la facoltà del Cliente di recedere unilateralmente dall'ordine confermato da Fervi e comunque dalla Vendita. In caso di revoca da parte del Cliente dell'ordine confermato da Fervi, egli è tenuto in ogni caso a pagare integralmente l'importo relativo alle merci.

6. ACCETTAZIONE / CONFERMA D'ORDINE

Il Cliente con l'invio dell'ordine rimane impegnato ai prezzi ed alle condizioni indicati nel catalogo vigente al momento dell'ordine.

Fervi può accettare l'ordine mediante spedizione della merce, ai sensi dell'art. 1327 c.c., senza obbligo di darne avviso al Cliente, in deroga a quanto previsto dal II° comma del predetto articolo. E' facoltà della Fervi, a seguito della ricezione dell'ordine, se lo riterrà opportuno, inviare al Cliente la conferma d'ordine a titolo di accettazione.

7. EVASIONE PARZIALE DELL'ORDINE

Fervi si riserva la facoltà di evadere l'ordine in tutto o in parte ovvero in diverse riprese, tenuto conto della disponibilità di magazzino di prodotti, senza garanzia di saldo.

I prodotti rimanenti saranno inviati al Cliente, nei limiti delle disponibilità di Fervi, nei modi e nei tempi che le parti concorderanno per iscritto.

8. RESI

Il Cliente ha l'obbligo di informare Fervi (fax +39 059 763 037; email assistenza@fervi.com) nell'ipotesi in cui intenda effettuare resi di merce entro e non oltre 8 giorni dal ricevimento.

Eventuali resi di merce verranno in ogni caso accettati da Fervi solo se preventivamente concordati ed autorizzati dallo stesso Venditore per iscritto e le relative spese sono interamente a carico del Cliente.

In ogni caso nel documento di accompagnamento devono essere specificamente indicati la causale del reso, il numero di autorizzazione ricevuto nonché l'indicazione della fattura di acquisto.

La merce deve essere resa nell'imballo originale.

I resi comunque non autorizzati e/o effettuati con modalità diverse rispetto a quelle concordate, non saranno accettati da Fervi e saranno restituiti al Cliente mediante spedizione a sue spese.

Non saranno comunque accettati resi di prodotto danneggiati, alterati e/o modificati.

I suddetti resi dovranno essere inviati a Fervi SpA, Via del Commercio n. 81 - 41058 Vignola (Mo) Italia.

9. RISERVE / RECLAMI / PRODOTTI NON CONFORMI ALL'ORDINATO

Il Cliente, anche tramite persona addetta alla ricezione della merce dallo stesso incaricata, ha l'obbligo di controllare la merce, lo stato dell'imballo o altri vizi apparenti al momento della consegna alla presenza del trasportatore, nonché a verificare l'integrità dei colli consegnati ed il relativo numero.

Ove la merce o il suo imballaggio risultino danneggiati ovvero in presenza di merce mancante o altri vizi apparenti, il Compratore è obbligato a formulare le proprie riserve immediatamente al trasportatore all'atto del ricevimento della merce, per iscritto nell'apposito spazio riservato nel tagliando del trasportatore, specificandone in ogni caso la motivazione. Il suddetto tagliando, debitamente sottoscritto con firma leggibile, dovrà essere consegnato direttamente al trasportatore.

Espletata la predetta procedura, il Cliente ha l'obbligo di specificare le eventuali problematiche al Venditore per iscritto a mezzo fax o e-mail, a pena di decadenza, entro e non oltre 4 giorni dalla data di ricevimento della merce, indicando il numero di ordine e la data di ricezione della merce.

Eventuali reclami per difetti non individuabili mediante un diligente controllo al momento del ricevimento della merce (vizi occulti) dovranno essere comunicati per iscritto al Venditore a mezzo fax o e-mail, a pena di decadenza, entro e non oltre 15 giorni dalla data della scoperta del difetto e comunque non oltre dodici mesi dalla data del ricevimento della merce.

Il reclamo deve in ogni caso specificare con precisione il difetto riscontrato, i prodotti cui esso si riferisce e gli estremi della fattura di acquisto.

Nel caso di consegna di prodotti non conformi all'ordine effettuato, il Compratore ha l'obbligo di darne avviso al Venditore mediante comunicazione scritta a pena di decadenza entro e non oltre 8 giorni dalla data di ricevimento della merce onde concordarne la restituzione.

La merce resa dovrà obbligatoriamente essere accompagnata dalla relativa bolla di accompagnamento con la dicitura "merce non conforme all'ordinato".

La restituzione della merce dal Compratore a Fervi, a qualsivoglia titolo, è in ogni caso subordinata ad autorizzazione scritta del Venditore, il quale comunicherà le modalità di restituzione e i tempi. La merce deve essere restituita nell'imballo originale e accompagnata dall'indicazione del numero di autorizzazione ricevuta da Fervi. E' inteso che eventuali reclami e/o contestazioni non danno diritto al Compratore di sospendere o comunque ritardare i pagamenti dei prodotti oggetto di reclamo e/o contestazione e neppure, tanto meno, di altre forniture.

Le restituzioni comunque non autorizzate e/o effettuate con modalità diverse rispetto a quelle concordate, non verranno accettate da Fervi e la merce sarà restituita al Cliente mediante spedizione a sue spese.

Non saranno comunque accettati resi di prodotto manomessi, alterati, modificati, vetusti o non più compresi nell'assortimento di vendita di Fervi.

Qualora la denuncia non avvenga secondo le modalità e entro i tempi di cui sopra, i prodotti consegnati verranno considerati come conformi a quelli ordinati dal Cliente con obbligo del Cliente di pagare la merce.

10. CONDIZIONI DI PAGAMENTO / PROPRIETA' DELLA MERCE

I pagamenti devono essere effettuati secondo le modalità e nei termini indicati nella fattura emessa da Fervi.

Il Compratore non è in ogni caso autorizzato ad effettuare alcuna deduzione o modifica al prezzo pattuito, se non previo accordo scritto con il Venditore.

Il Compratore acquisterà la proprietà della merce solo a seguito del pagamento integrale della fattura emessa dal Venditore, ma assumerà ogni rischio inerente alla stessa al momento della consegna al vettore.

In caso di ritardi di pagamento, il Venditore potrà modificare unilateralmente i termini di eventuali altre forniture e/o sospenderne l'esecuzione fino all'ottenimento di adeguate garanzie di pagamento (ad es. fidejussione o garanzia bancaria).

11. SPEDIZIONE E TRASPORTO

Le spese di spedizione e trasporto sono interamente a carico del Cliente.

Fervi si riserva di scegliere il vettore al quale non è tenuto di norma a comunicare il valore della merce. Qualora comunque il Cliente intenda assicurare la spedizione, è obbligato a chiederlo espressamente al momento dell'ordine, accollandosi il pagamento di tutti gli oneri corrispondenti.

Il trasferimento dei rischi relativi alla merce ha luogo al momento della loro consegna al vettore: conseguentemente la merce viaggia sempre a totale rischio e pericolo del Cliente, anche nell'ipotesi di spedizione in porto franco di Fervi.

La spedizione della merce così come l'eventuale conferma d'ordine sono comunque subordinate ad ordini effettuati per un importo minimo di euro 150,00 (centocinquanta). In caso di ritiro della merce da parte del Cliente direttamente al Banco Vendita presso i Centri di Distribuzione di Fervi, l'importo rimane invariato. E' in ogni caso esclusa la spedizione diretta a Clienti del Compratore.

12. TERMINI DI CONSEGNA

Eventuali termini per l'evasione dell'ordine, laddove previsti, sono computati per giorni lavorativi e sono da intendersi in ogni caso puramente indicativi, non tassativi e non giuridicamente vincolanti per Fervi.

Pertanto, in considerazione della natura meramente indicativa dei termini sopra indicati, Fervi non risponde dei danni direttamente o indirettamente causati dalla ritardata esecuzione o dalla ritardata o mancata consegna della merce.

Fervi non sarà in ogni caso responsabile per ritardi o mancate consegne, che dipendano da caso fortuito o forza maggiore.

13. GARANZIE PRODOTTO / CONFORMITA' TECNICHE

Tutti i prodotti Fervi sono coperti dalla garanzia della Casa produttrice e dotati di tutte le certificazioni e conformità tecniche necessarie per legge.

Tale garanzia è limitata nel tempo e opera in relazione all'oggetto venduto, escludendo ogni altra prestazione così come ogni indennizzo e/o risarcimento. Tale garanzia si applicherà al prodotto che presenti difetti di conformità e/o malfunzionamenti non riscontrabili al momento dell'acquisto, purché il prodotto stesso sia utilizzato correttamente e con la dovuta diligenza e cioè nel rispetto della sua destinazione e di quanto previsto nella eventuale documentazione tecnica, con osservanza puntuale della funzione d'uso propria come descritta nei manuali.

La predetta garanzia non sarà invece applicabile in caso di negligenza, incuria nell'uso e nella manutenzione del prodotto. Fervi in ogni caso non si assume alcuna responsabilità in relazione a utilizzo, applicazioni e/o operazioni alle quali il prodotto dovesse essere sottoposto presso il Cliente o chi per esso, nel caso di utilizzo per scopi diversi o non idonei rispetto a quanto previsto nel Catalogo e/o nelle istruzioni d'uso.

14. RIPARAZIONI / INTERVENTI TECNICI / ASSISTENZA

Fervi, per i suoi prodotti, svolge anche attività di assistenza tecnica e centro riparazione.

Il Cliente che necessita di interventi ha l'obbligo di trasmettere la propria richiesta di intervento per iscritto a Fervi a mezzo fax o email, indicando espressamente il motivo della richiesta, la tipologia del prodotto, la data di acquisto e ogni altro dato necessario al fine di concordare le modalità di intervento.

Il Servizio tecnico di assistenza Fervi, esaminata la richiesta, informerà il Cliente circa l'intervento da effettuare e i relativi tempi.

Le spese di intervento saranno quantificate a seguito della ricezione della richiesta e varieranno a seconda che il prodotto sia coperto da garanzia o non lo sia.

La data indicata sulla fattura d'acquisto è l'inizio della garanzia. Spetta al richiedente provare il diritto alla garanzia mediante esibizione del documento di acquisto.

Fervi comunicherà il preventivo di spesa per le riparazioni nel caso in cui la garanzia non operi; laddove diversamente la garanzia sia in vigore, le spese di intervento resteranno a carico di Fervi.

In ogni caso, qualunque intervento, è subordinato ad autorizzazione di Fervi: il Cliente, pertanto, non potrà inviare il materiale senza la preventiva accettazione di Fervi, a pena di restituzione a sue spese.

la merce sarà in ogni caso resa dal Cliente franco magazzino di Fervi.

15. MUTAMENTO DELLE CONDIZIONI PATRIMONIALI DEL CLIENTE

Fervi avrà diritto di recedere dal contratto nonché di sospendere l'adempimento delle obbligazioni derivanti dalla vendita dei prodotti senza alcun onere, qualora venga a conoscenza dell'esistenza di mutamenti nelle condizioni patrimoniali del Cliente tali da porre in serio pericolo il conseguimento della controprestazione salvo che sia prestata idonea garanzia. tale facoltà è riconosciuta a Fervi anche laddove venga a conoscenza, a titolo meramente esemplificativo e non esaustivo, dell'esistenza di protesti di titoli, dell'avvio di procedure giudiziarie, monitorie, ordinarie, concorsuali, anche di natura extragiudiziale a carico del Cliente.

16. DIRITTI DI PROPRIETA' INTELLETTUALE

I Diritti di proprietà Intellettuale sono di totale ed esclusiva proprietà di Fervi e la loro comunicazione o utilizzo nell'ambito delle presenti Condizioni di Vendita non crea, in relazione ad essi, alcun diritto o pretesa in capo al Cliente.

Il Cliente si obbliga in ogni caso a non compiere alcun atto incompatibile con la titolarità dei Diritti di proprietà Intellettuale.

Il Cliente dichiara che: Fervi è l'esclusiva titolare dei Diritti di proprietà Intellettuale; il Cliente si asterrà dall'utilizzare e dal registrare marchi simili e/o confondibili con i Marchi di cui Fervi è proprietaria e/o licenziataria; utilizzerà i Marchi esclusivamente in ottemperanza alle istruzioni di Fervi ed esclusivamente per i fini di cui alle presenti Condizioni di Vendita.

In ogni caso il Catalogo dei prodotti Fervi è a tutti gli effetti protetto dalle norme sul diritto d'Autore e, pertanto, qualsiasi riproduzione e/o utilizzo non espressamente autorizzata per iscritto è da ritenersi vietata.

17. DIRITTO APPLICABILE E FORO COMPETENTE

Il presente contratto è regolato dalla legge italiana e per qualsiasi controversia circa la sua validità, interpretazione o esecuzione, il Cliente accetta la giurisdizione dello stato italiano e, in ogni caso, l'applicazione della legge italiana in vigore al momento dell'insorgere della lite nonché le norme applicabili in tema di vendita disciplinate dagli artt. 1470 e ss. codice civile. Qualsiasi controversia che dovesse insorgere circa l'interpretazione, applicazione, esecuzione, risoluzione del contratto e/o delle presenti Condizioni generali di contratto, o comunque ad esse relativa, verrà devoluta in via esclusiva alla competenza del foro di Modena.

18. TRATTAMENTO DEI DATI PERSONALI

Fervi garantisce che i dati forniti per effetto del presente contratto saranno dalla stessa trattati con la massima riservatezza, e nel rispetto della normativa vigente in materia di protezione dei dati personali (D.lgs. 30 giugno 2003, n. 196). In ogni caso il loro trattamento è improntato al rispetto dei principi di correttezza, liceità e trasparenza. tutti i dati sono trattati da Fervi, titolare del trattamento, per l'invio del Catalogo (considerata attività pre-contrattuale), per l'acquisizione, la gestione, l'evasione degli ordini, per le attività post contrattuali, nonché per ottemperare agli adempimenti e agli obblighi amministrativi, di legge e fiscali.

Il trattamento dei dati potrà essere effettuato sia con mezzi cartacei, sia con mezzi e strumenti automatizzati, ubicati in Italia o all'estero, e supporti informatici presso il titolare del trattamento. Il conferimento dei dati, al momento dell'invio degli ordini di acquisto, è obbligatorio in conseguenza di adempimenti e obblighi amministrativi, di legge e fiscali.

Un eventuale rifiuto al conferimento impedirà l'evasione dell'ordine. I dati non saranno diffusi, ma potranno essere comunicati al personale dipendente e ai collaboratori di Fervi, ai consulenti, ai soggetti legittimati ad accedervi in forza di disposizioni di leggi, regolamenti, normative comunitarie e, nei limiti strettamente necessari a svolgerli, ai soggetti che sempre per finalità indicate, debbano fornire beni e/o eseguire su incarico di Fervi prestazioni o servizi. I dati potranno essere trasferiti in paesi dell'Unione europea e in paesi terzi, nell'ambito delle finalità sopra indicate.

In qualsiasi momento, il Cliente potrà esercitare i diritti di cui all'art. 7 del D.lgs. n. 196/2003 ovvero accedere ai dati personali per conoscerne l'utilizzo, ottenerne la cancellazione, la correzione, la modifica, l'aggiornamento, l'integrazione oppure opporsi al trattamento scrivendo all'indirizzo della sede di Fervi, via del Commercio n. 81 - 41058 Vignola (Mo).

**ATTENZIONE: CONTROLLARE SEMPRE L'INTEGRITÀ DEI COLLI AL MOMENTO DEL RICEVIMENTO.
NEL CASO SI RISCOVRANO DANNI, EFFETTUARE UNA CHIARA RISERVA SULLA NOSTRA BOLLA O FATTURA.
FERVI SpA DECLINA OGNI RESPONSABILITÀ PER DANNI CAUSATI ALLE MERCI DURANTE IL TRASPORTO.**

MINIMO ORDINABILE PER ARTICOLO

Tutti i nostri prodotti sono **acquistabili in quantità 1 (uno) pezzo**, ad eccezione degli articoli che riportano una specifica indicazione, **acquistabili solo nella quantità minima indicata**.

P023-XL

PUNTA ELICOIDALE CILINDRICA LUNGA

DIN 340, Destra, rettificata

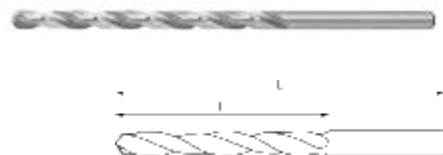
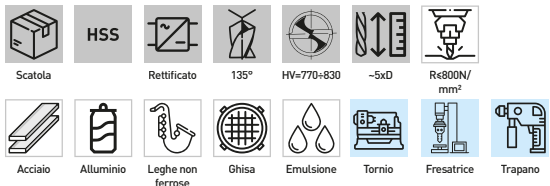

Art.	€	Ø	L	l	Pack
P023/01.00L	€ 9999,99	0 mm	56 mm	33 mm	10
P023/01.25L	€ 9999,99	5 mm	65 mm	40 mm	10
P023/01.50L	€ 9999,99	0 mm	70 mm	45 mm	10
P023/01.75L	€ 9999,99	5 mm	80 mm	53 mm	10
P023/02.00L	€ 9999,99	0 mm	85 mm	56 mm	10
P023/02.25L	€ 9999,99	5 mm	90 mm	59 mm	10
P023/02.50L	€ 9999,99	0 mm	95 mm	62 mm	10
P023/02.75L	€ 9999,99	5 mm	100 mm	66 mm	10
P023/03.00L	€ 9999,99	0 mm	100 mm	66 mm	10
P023/03.25L	€ 9999,99	5 mm	106 mm	69 mm	10
P023/03.50L	€ 9999,99	0 mm	112 mm	73 mm	10
P023/03.75L	€ 9999,99	5 mm	112 mm	73 mm	10
P023/04.00L	€ 9999,99	0 mm	119 mm	78 mm	10
P023/04.25L	€ 9999,99	5 mm	119 mm	78 mm	10
P023/04.50L	€ 9999,99	0 mm	126 mm	82 mm	10
P023/04.75L	€ 9999,99	5 mm	126 mm	82 mm	10
P023/05.00L	€ 9999,99	0 mm	132 mm	87 mm	10
P023/05.25L	€ 9999,99	5 mm	132 mm	87 mm	10
P023/05.50L	€ 9999,99	0 mm	139 mm	91 mm	10
P023/05.75L	€ 9999,99	5 mm	139 mm	91 mm	10
P023/06.00L	€ 9999,99	0 mm	139 mm	91 mm	10
P023/06.25L	€ 9999,99	5 mm	148 mm	97 mm	10

Art.	€	Ø	L	l	Pack
P023/06.50L	€ 9999,99	0 mm	148 mm	97 mm	10
P023/06.75L	€ 9999,99	5 mm	148 mm	97 mm	10
P023/07.00L	€ 9999,99	0 mm	156 mm	102 mm	10
P023/07.25L	€ 9999,99	2 mm	156 mm	7,50 mm	10
P023/07.50L	€ 9999,99	5 mm	156 mm	102 mm	10
P023/07.75L	€ 9999,99	5 mm	165 mm	109 mm	10
P023/08.00L	€ 9999,99	0 mm	165 mm	109 mm	5
P023/08.25L	€ 9999,99	5 mm	165 mm	109 mm	5
P023/08.50L	€ 9999,99	0 mm	165 mm	109 mm	5
P023/08.75L	€ 9999,99	5 mm	175 mm	115 mm	5
P023/09.00L	€ 9999,99	0 mm	175 mm	115 mm	5
P023/09.25L	€ 9999,99	5 mm	175 mm	115 mm	5
P023/09.50L	€ 9999,99	0 mm	175 mm	115 mm	5
P023/09.75L	€ 9999,99	5 mm	184 mm	121 mm	5
P023/10.00L	€ 9999,99	0 mm	184 mm	121 mm	5
P023/10.25L	€ 9999,99	25 mm	184 mm	121 mm	5
P023/10.50L	€ 9999,99	50 mm	184 mm	121 mm	5
P023/11.00L	€ 9999,99	0 mm	195 mm	128 mm	5
P023/11.50L	€ 9999,99	50 mm	195 mm	128 mm	5
P023/12.00L	€ 9999,99	0 mm	205 mm	134 mm	5
P023/12.50L	€ 9999,99	50 mm	205 mm	134 mm	5
P023/13.00L	€ 9999,99	0 mm	205 mm	134 mm	5

MINIMO FATTURABILE

L'importo **minimo fatturabile e di Euro 150,00 (centocinquanta) IVA esclusa** (articolo 11 delle condizioni generali di vendita Fervi SpA)



46

FERVI SPA

Via del Commercio, 81
41058 - Vignola (MO), Italia
Tel. +39 059 767 172
Fax +39 059 763 037
info@fervi.com
fervi.com



a **FERVI GROUP** company