

Issue 304
USA/CANADA/MEXICO

EBC[®] BRAKES



THE WORLD'S LARGEST RANGE OF MOTORCYCLE, ATV AND UTV BRAKES AND CLUTCHES

Brake pads, rotors, braided stainless brake lines, clutches and much more, with four manufacturing plants in the UK and USA producing over 10 million components each year.

www.ebcbrakes.com

As they say quality never goes out of style... and EBC is the perfect example of that... 40 years as industry leader as the market changes and supply issues arise, NO supply issues for EBC... and EBC goes from strength to strength.

Here's why EBC beats them all

In house press-works for backing plates - millions per year

- NRS hook system on all organic backing plates for perfect bond strength
- In house production of all Organic and sintered brake pads all with R90
- Two massive auto load In house high powered Lasers for endless supply of rotor components again R90
- New centreless grinders for perfect rotor componentry, flat smooth and precise within microns
- In house multi line skin packaging, boxing and flow line shipping facilities

Lets remember - EBC Brakes make 100% of the motorcycle brakes it sells IN HOUSE

On distribution EBC are one of a tiny few companies who has "Kept the Faith" as EBC Brakes continues its tradition of Distributor only sales allowing those Distributors to fill orders to the dealer network.

The reason we don't need to change recipe that is because it works !!!! It works for the distributors, it works for the dealers and it works for us as a factory.

As EBC continues to grow and expand globally we have welcomed numerous new overseas importers for new markets but in Europe and USA our distributor network has remained stable and we really appreciate the loyalty and business support that our fantastic distributors have given us through their dealers...long may it continue.

Thanks again to you all for your support.



CATALOG COPYRIGHT

This catalog forms a copyright under US law.

This includes, but is not limited to, the series of brake pad, brake shoe, clutch and brake rotor design numbers with or without the prefixes FA, EPFA, GPFAX, MXS, SXR or suffixes R, HH, X, SV. These design numbers prefixes and suffixes form the toils of many years of work and set EBC products apart and are easily distinguished from other manufacturers brands or numbers.

Any copying, imitation, in full or in part, by any third party, will result in prosecution to the fullest extent of US law.

Also included within this catalog are registered or applied for individual trademarks, such as:

- | | | | | |
|------------|----------------|--------|--------------|-------------|
| • EBC | • SD-System | • DRC | • SRK | • VR Series |
| • Double-H | • Dirt Racer | • DRCF | • SV Series | • UTVX |
| • Pro-lite | • Street Racer | • SRC | • VLD Series | • SXR |

All of the above are active trademarks and/or brands used by EBC Brakes licencees.

© Copyright 2024 A C Freeman Investments Ltd

CONTENTS

PAD & SHOE APPLICATIONS

US Built Motorcycles (Harley-Davidson®, Arch, Arctic Cat, ATK, Bombardier/BRP, Buell, Can-Am, Cobra Moto, EBR, Indian, Motus, Polaris, Victory, Zero Electric Motorcycles)	2-53
Rotor Designs and Dimensions for US Built Motorcycles	54-71
Japanese Bikes (Honda, Kawasaki, Suzuki, Yamaha)	74-173
Non-Japanese Bikes	174-273
Recommended 2024 Dealer Inventory.....	274-275
Road Racing Applications/ Pads for Aftermarket Calipers	276-280
Brake Lines	281-299

BRAKE
APPLICATIONS

BUYER'S GUIDE - BRAKE PADS

Buyer's Guide Brake Pads	300-380
--------------------------------	---------

BUYERS GUIDE
BRAKE PADS

BUYER'S GUIDE - BRAKE SHOES

Buyer's Guide Brake Shoes	381-396
---------------------------------	---------

BUYERS GUIDE
BRAKE SHOES

BUYER'S GUIDE - BRAKE ROTORS

Buyer's Guide Brake Rotors - Streetbikes.....	397-463
Buyer's Guide Brake Rotors - Dirtbikes/ATV/UTV	464-513

BUYERS GUIDE
BRAKE ROTORS

CLUTCH APPLICATIONS

Japanese Bikes.....	514-542
Non-Japanese Bikes	542-559

CLUTCH
APPLICATIONS

BUYER'S GUIDE - CLUTCHES

Buyer's Guide - CK Clutch Kits	560-580
Buyer's Guide - DRC/DRCF Clutch Kits	581-588
Buyer's Guide - SRC/SRK Clutch Kits	589-596

BUYERS GUIDE
CLUTCHES

ACCESSORY PAGES

Carburettor Jets - Pilot Jets	597-599
Carburettor Jets - Main Jets	600-601
Brake Fluid & Caliper Lube.....	601

ACCESSORY
PAGES

COPYRIGHT NOTICE: The part numbers, illustrations and listings in this publication are the copyright of EBC Brakes and any reproduction in part or whole or similarity, without advance authority in writing is contrary to international law and copyright holders will enforce vigorously. Vehicle manufacturers names and model numbers are indicated for cross reference purposes only. All products in this catalogue are manufactured by EBC Brakes and are not original equipment parts.

MOTORCYCLE BRAKE PADS

Aramid Fiber Organic FA Series Pads



FA series organic brake pads will deliver fingertip stopping power and superb brake feel and control, the preferred choice for many sportbike riders. This compound has low disc attack characteristics and gives medium lifetime.

“X” Pads



“X” series Motocross sport and enduro pads, cool running based pad compound for sport use in Motocross and ATV applications. For mud, sand or wet conditions requiring longer life, use our sintered range below.

Double-H™ Pads



FA series with HH suffix, EBC’s American-made ultra high friction Double-H™ sintered copper alloy brake pads for maximum stopping power and lifetime. With stainless steel radiator plates to reduce heat transfer and double compact for wider pads.

MXS Series Pads



“MXS” Motocross race pads, ultra high friction American-made sintered copper alloy with diamond ground surface finish for fast brake-in. With external hex drive slider pins, these pads are suitable for all fast Motocross riding.

“R” Series Pads



“R” series American-made sintered copper alloy ATV and Motocross replacement pads for sport and utility off road riding.

SV Pads



“SV” series severe duty ATV pads, high density copper alloy for longest possible life in utility applications on ATV, especially in wet, mud, dust and dirt conditions.

MOTORCYCLE BRAKE PADS

EPFA Trackday Pads



EPFA trackday pads give long life in street use with improved fade resistance and heat cycling plus improved noise characteristics, making this a great pad for heavy streetbikes and cruisers as well as faster superbikes. Great for intermittent track use.

GPFX Race Series Pads



GPFX vacuum sintered ultra-high friction race pads are for sportbike asphalt racing and have been refined over the years to deliver one of the best brake race materials ever made. See page xii for full details.

SFA Organic Scooter Pads



A superb general replacement pad for urban use on scooter mopeds, mofas, mokicks and mopeds. Made using aramid fibers, these pads give above average lifetime, reduced rotor wear characteristics and offer great value for money.

SFA-HH Sintered Scooter Pads



These American-made sintered scooter pads are long lasting with high performance HH rated stopping power for perfect braking - wet or dry. The HH pads target the faster and heavier scooter market and work well with stainless steel brake discs.

V-Pads



Semi-Sintered V-Pads™ are a new blended Semi-Sintered brake pad that combine the highest qualities of an organic brake pad with the endurance of a sintered equivalent brake pad. The Vee brake pad range are designed for the heavy cruiser/streetbike market as a replacement brake pad.

MOTORCYCLE BRAKE ROTORS

X and XC Series Sportbike Rotors

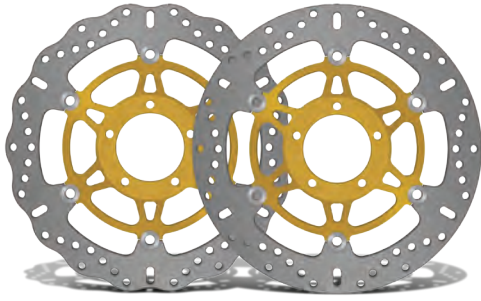

X and XC series rotors feature mill hard stainless steel high friction rotor blades for maximum brake effect and are direct size for size replacements for OEM rotors. These rotors feature our patented SD system square drive button system.

VMD Classic Style Rotors

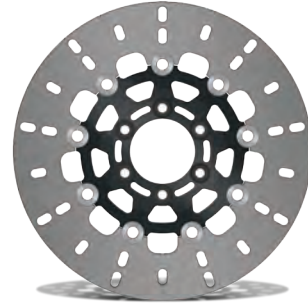

These black anodised vintage rotors are new to our range. The vintage fitment benefits from billet aluminum construction; lightweight, less unsprung weight enables better handling and stopping power. Perfect for the Café racer scene.

Sportbike VR Series Rotors

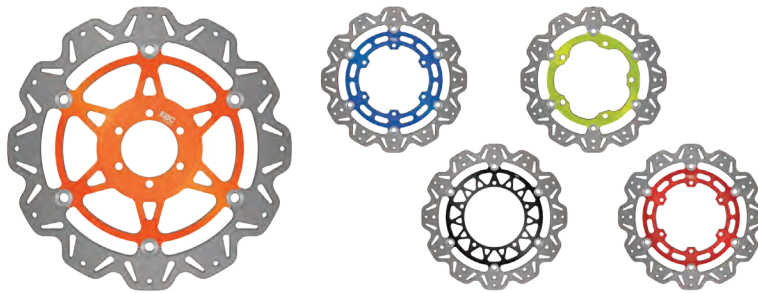

Vee profile lightweight rotors with alloy hubs and ground stainless steel rotor blades for fast street bikes. Choose from black or colored hub options as shown above. To order prefix with VR and suffix with chosen color BLK, RED, BLU, GRN, GLD. For rear rotors just the VR number.

Supermoto Brake Rotor

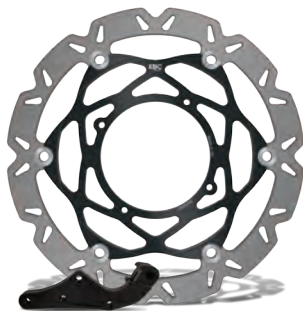

SMX rotor with vee design contoured rotor, 320mm rotor upgrade kits complete with relocation bracket.

Cross Country Rear Brake Rotors

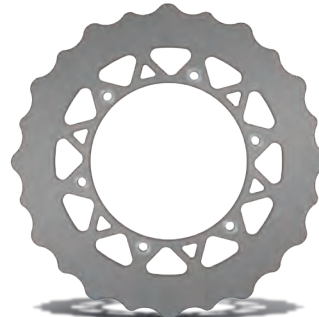

Made in the UK from German milled rolled, heat treated stainless steel. These rotors have no drill pattern in the pad track which improves pad wear, prevents mud and debris being dragged between the pad and disc. Ideal for cross country competition in all conditions, use with EBC Brakes sintered MXS or R material brake pads.

MOTORCYCLE BRAKE ROTORS

MD Series Stainless Scooter Rotors



Made from mill hard rolled steel, these rotors are machined to match the original units, mechanically de-stressed to avoid rotor distortion, surface finished for precise smoothness and then zinc coated to prevent corrosion or rusting.

VR Series Stainless Scooter Rotors



Made in the UK using German mill rolled heat treated and precision ground stainless steel, the new VR profiled scooter sport rotors are the lightest and best looking on the market and can be used with any type of brake pad.

UTVX Rotors for ATV//UTV



These rotors look great and give an improved brake performance. Made in our British manufacturing facility using durable, tough German mill rolled stainless steel, heat treated & diamond ground to give great braking for less than OEM prices.

CX Extreme Off Road Rotors

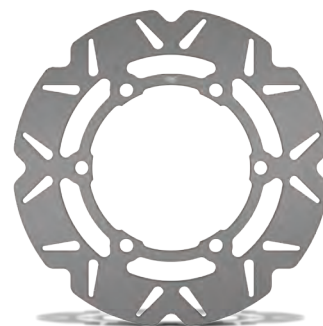

CX Extreme self-cleaning lightweight stainless rotors are a size-for-size replacement/upgrade for front and rear fitment on all modern motocross machines.

Oversize MX Rotors

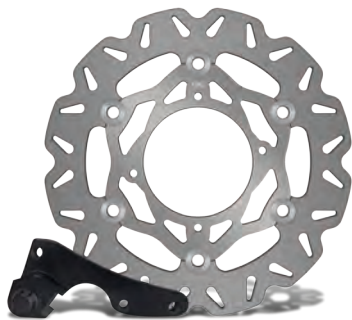

250 or 280mm motocross oversize rotor kit complete with billet aluminum relocation brackets for improved braking performance and modulation with vee design rotor.

Rear Brake Rotors

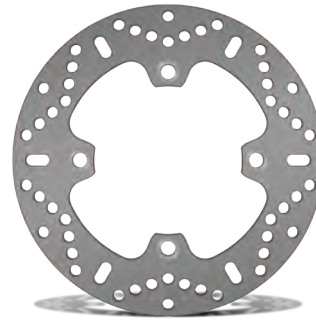

Made from stainless steel and available in full circle or contoured profile, suitable for performance street use or racing with new lightweight hole pattern construction.

ROTOR BOLT KITS

All manufacturers recommend new rotor bolts when replacing brake rotors on a motorcycle. EBC Brakes have a range of brake rotor bolt kits available to purchase with all new EBC Brakes rotors.

Our Rotor Bolt Kits are produced to fit individual motorcycle models (refer to Catalogue for model listings). Manufactured from stainless steel with thread lock applied and comply with the original manufacturers specifications, are supplied in sets in the quantity required for each individual brake rotor.

EBC Brakes Rotor Bolt Kits

- Sold in line with OEM Specifications
- All bolts are stainless steel
- All bolts have thread lock applied



ROTOR BOLT PART NO.	MAKE
DB102/6	HONDA
DB201/6	YAMAHA
DB301/4	SUZUKI
DB302/3	SUZUKI
DB302/4	SUZUKI
DB302/5	SUZUKI
DB302/6	SUZUKI
DB303/5	SUZUKI
DB401/4	KAWASAKI
DB401/6	KAWASAKI
DB402/4	KAWASAKI
DB402/6	KAWASAKI
DB403/4	KAWASAKI
DB403/6	KAWASAKI
DB404/4	KAWASAKI

ROTOR BOLT PART NO.	MAKE
DB404/5	KAWASAKI
DB404/7	KAWASAKI
DB405/3	KAWASAKI
DB405/4	KAWASAKI
DB405/5	KAWASAKI
DB601/5	BMW
DB601/6	BMW
DB602/5	BMW
DB603/4	KTM
DB603/6	HUSQVARNA
DB604/5	APRILIA
DB604/6	APRILIA
DB605/4	TRIUMPH
DB605/6	TRIUMPH

MOTORCYCLE CLUTCH OPTIONS

CK/CKF Series Clutch Kits



CK complete engine sets of stack height controlled friction plates feature the EBC Brakes' unique alloy particle impregnated clutch facings that prevent burn up or slippage. CKF carbon fiber impregnated kits for ATV and Motocross use are built to last longer, grip and feel better than cork kits.

DRC/DRCF Series Clutch Kits



DRC is the ultimate clutch rebuild kit for your ATV and Motocross machine. The DRCF kit swaps the stock type cork friction plates for a set of severe duty carbon fiber lined friction plates for better heat and wear abilities.

SRC/SRK Series Clutch Kits



SRC is an aramid fiber lined plate set with heavy duty clutch springs (diaphragm type springs included where required). Ideal for heavy sport bikes, faster riders and production based race use. SRK series includes a full engine set of aramid lined friction plates with clutch springs and steel separator plates.

CSK Coil & Diaphragm Clutch Kits



CSK sets include either coiled springs or diaphragm springs where appropriate. Coil springs are spiral wound with 4 to 8 pieces per set, made from heat treated high carbon steel delivering the right tension for your bike. Diaphragm springs are dish shaped flat steel pressure rings.

Clutch Removal Tools



Made in the UK by EBC Brakes, these laser cut clutch tools make clutch removal, loosening of the drive shaft bolts and re-tightening a breeze, without any fear of damage to your expensive clutch basket. Tools can be extended to create more leverage if required with any simple workshop tool or tube. EBC Brakes produce a clutch tool for almost every clutch plate design known.

SXS Products from EBC BRAKES



The longest lasting, highest performing aftermarket pads and rotors for the SxS industry yet ... All EBC Brakes pads for SxS fitments, both sintered and carbon X pads, are made with beefed-up pad thickness and **DO NOT REQUIRE** or accommodate the fitting of noise shims, offering even more available pad life for this tough application

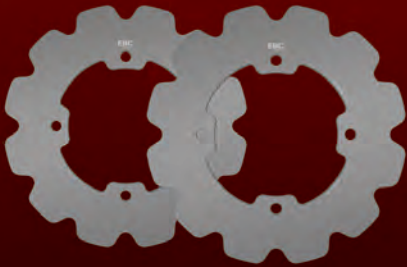

UTVX Rotors

- Profiled
- UK made
- Heat treated stainless steel



SXR Pads

- Vacuum sintered • Maximum grip
- Race performance • Longest wear life



Sport Carbon X Pads

- Fast, dry riding
- Enhanced life material
- Enhanced pad thickness

All parts are in stock at your favourite EBC Brakes distributor NOW for immediate delivery.

Part numbers, prefixes, suffixes, photos and illustrations shown in this catalog are trademarks and/or copyrights of EBC Brakes or the trademark owner A C Freeman Investments Ltd and use without express written permission of the owners is punishable by law.

SXS PADS AND ROTORS

Part #	Make/Model	Year	Pad Position	UPC	Matching UTVX Rotor	
					Front	Rear
SXR354HH	POLARIS			889668168839		
	570 Sportsman Ace/Ace Euro	15-20	Rear		UTVX6202	UTVX6275
	800 Ranger Crew	10-14	Rear		UTVX6338	UTVX6275
SXR452HH	POLARIS			889668168846		
	500 Ranger (4 x 4 EFI)/(Carb) 2 x 4/Ranger Crew	08-13	Front		UTVX6202	UTVX6275
	500 Ranger (EFI) 4 x 4 H.O.	09-11	Front		UTVX6338	UTVX6275
	RGR 570, Full Size (R06)	16	Front		UTVX6202	UTVX6275
	700 Ranger Crew (EFI) 4 x 4/6 x 4 EFI/XP 4 x 4	08-09	Front		UTVX6202	UTVX6275
	700 Ranger 4 x 4 EFI	09	Front		UTVX6338	UTVX6275
	800 Ranger/EFI/XP/Crew	10-14	Front		UTVX6338	UTVX6275
	800 Ranger 6 x 6	10-17	Front & Rear		UTVX6338	UTVX6275
	RZR-4 800 EPS	12	Front		UTVX6338	UTVX6275
	Ranger EV (Electric)	10-15	Front		UTVX6202	UTVX6275
	900 D Crew Ranger Diesel/Crew Ranger Diesel	11-14	Front		UTVX6338	UTVX6275
	900 (Ranger XP 900)	15-19	Front		UTVX6338	UTVX6275
	900 (Ranger XP 900)	13-14	Front		UTVX6338	UTV6374
	Ranger Crew 900 All Options (R07)	16-19	Front & Rear		UTVX6338	UTVX6275
	1000 General EPS (2 Seat)	16	Front		UTVX6338	UTVX6338
	1000 General EPS PS MD (R09, R13, 2 Seat)	17-20	Front		UTVX6408	UTVX6408
	1000 General 4 EPS PS XP DLX (R01, R14, R18, 4 Seat)	17-20	Front		UTVX6338	UTVX6408
	1000 Ranger Diesel Crew	15	Front		UTVX6338	UTVX6275
	RZR XP 1000 (R11 EU/MD,R12, R14)	16-17	Front		UTVX6380	UTVX6380
	Brutus HD HDPT0 (R03)	13-17	Front		UTVX6338	UTVX6275
SXR456HH	POLARIS			889668168853		
	RZR 570/RZR 800 (Inc EPS Models)	08-14	Front		UTVX6312	UTVX6275
	RZR 570 S/EU/MD (R05)	14-19	Front		UTVX6338	UTVX6275
SXR656HH	POLARIS			889668168884		
	570 Sportsman Ace/Ace Euro	15-20	Front		UTVX6202	UTVX6275
	570 Ranger Crew EFI	14-15	Front		UTVX6202	UTVX6275
	RGR 570, Full Size (R12/R06/R03)	17-20	Front		UTVX6202	UTVX6275
	RGR CRW 570 FS (R08/R05/R03)	16-20	Front		UTVX6202	UTVX6275
	RGR 570 EPS CRW MD (R04)/EFI CRW (R10/R03/R02)	17-20	Front		UTVX6202	UTVX6275
	RGR EV MD (R02)/EV LIION (R08/R03)/EV (R12/R03/R02)	16-19	Front		UTVX6202	TBA
	RGR 800 6X6 MD Poland (R02)	17-20	Front		UTVX6202	TBA
	RGR CRW 900 XP 6P SP (R10)/900 EPS (R03)/6P SP (R14)	17-19	Front		UTVX6338	TBA
	Ranger 902D EU Tractor R07	19-20	Front		UTVX6380	UTVX6338
	RZR XP 1000 S4 R02	18-20	Front		UTVX6380	UTVX6338
	900 Ranger Crew	10-15	Front		UTVX6338	UTVX6275
	1000 Ranger Diesel EU (R12)	15-20	Front		UTVX6338	UTVX6275
	RGR CRW 1000 XP PS MD (R08)/PS All Options (R32/R09)	17-18	Front		UTVX6338	UTVX6275
	RGR CRW 1000 XP 6P, PS, NB, MD (R08)/PS (R10)	17-20	Front		UTVX6338	UTVX6275
	RGR 1000 D Poland (R07)/D EU (R14) D Crew (R16)	17-18	Front		UTVX6338	UTVX6275
	Ranger Crew 1000 (R04, R06, R08, R11)	18-20	Front		UTVX6338	UTVX6275
	Ranger 1000 XP PS Crew Inc EU, EPS, HD, MD (R03, R09, R13, R20)	18-20	Front		UTVX6338	UTVX6275
	Ranger 1000 XP PS NSTR, Crew Mud (R15, R17, R18)	18-20	Front		UTVX6338	UTVX6275
	RGR 1000D (R17/R13)	17-18	Front		UTVX6338	UTVX6275
	MIL RZR2 XP MV 1000 TD (R01/R04)/TD NELO (R01)	17-18	Front		TBA	TBA
	RZR XP 900 (Inc EPS Models)/4 XP 900 All Options Inc Military/4 900 (R05)	11-17	Front		UTVX6338	MD6374D
	RZR 4 900 (R05, R12)	16-18	Front		UTVX6338	TBA
	RZR XP 1000 R35	12-19	Front		UTVX6380	UTVX6380
	RZR RS1/XP 4 1000/4 1000 MD	16-20	Front & Rear		UTVX6380	UTVX6380
	RZR XP/XP 4 Turbo/Turbo 4	16-20	Rear		UTVX6397	UTVX6397
	RZR XP Turbo/Latin/MD/S/Tractor/Turbo S/XP4 Turbo/Turbo Intl/Turbo MD	17-20	Rear		UTVX6380	UTVX6397
SXR677HH	YAMAHA			889668168914		
	YZZ 1000 R All Models	16-17	Rear		UTVX6395	UTVX6395
SXR680HH	POLARIS			889668182019		
	RZR XP/XP 4 Turbo/Turbo 4	16-20	Front		UTVX6397	UTVX6397
	RZR XP/XP4	17-20	Front		UTVX6380	UTVX6397

SXS PADS



SXR354HH – 97mm wide



SXR452HH – 120mm wide



SXR456HH – 97.5mm wide



SXR656HH – 120.5mm wide

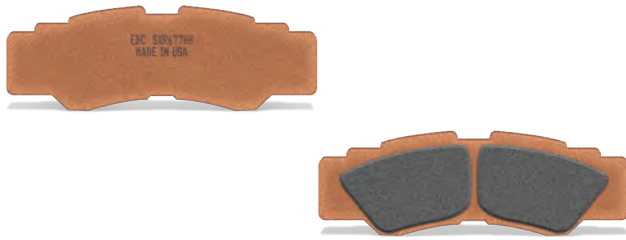

SXR677HH – 104mm wide



SXR680HH – 155mm wide

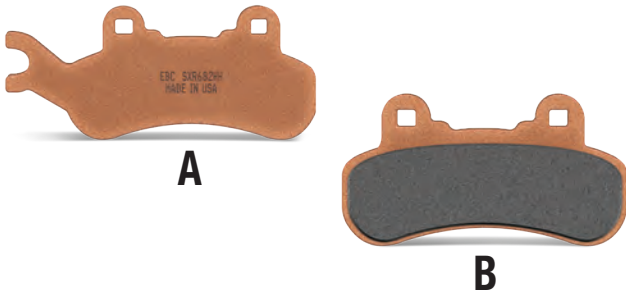

SXR682HH – A-117.5/B-95mm wide



SXR683HH – A-117.5/B-95mm wide

SXS PADS

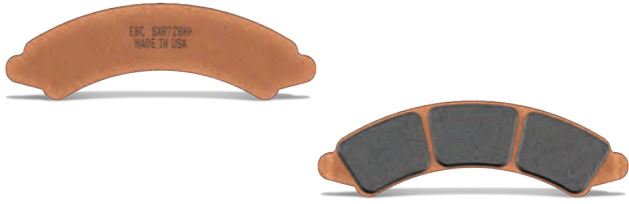

SXR728HH – 163.5mm wide

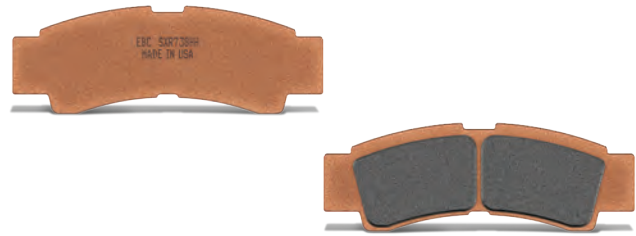

SXR738HH – 114mm wide

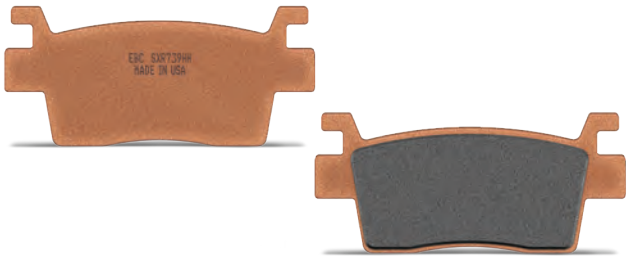

SXR739HH – 85.5mm wide



SXR756HH – 91mm wide



SXR768HH – 155.5mm wide

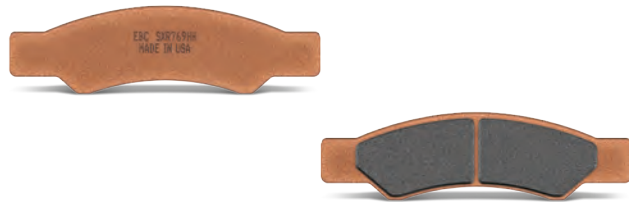

















SXR769HH – 135mm wide

The diagrams above show a generic material friction pattern. Please see image to the right, for actual friction material.

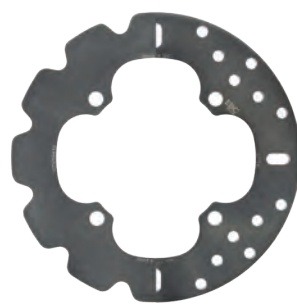

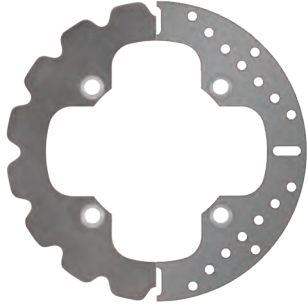
SXS ROTORS

			
UTVX6173 / MD6173 202mm/7.95"	UTVX6202 / MD6202 228mm/8.98"	UTVX6271 / MD6271 252mm/9.92"	UTVX6275 / MD6275 218mm/8.58"
			
UTVX6312 / MD6312 235mm/9.25"	UTVX6338 / MD6338 220mm/8.93"	UTVX6366 / MD6366 215mm/8.46"	UTVX6370 / MD6370 215mm/8.46"
			
UTVX6374 / MD6374 218mm/8.58"	UTVX6380 / MD6380 245mm/9.64"	UTVX6384 / MD6384 252mm/9.92"	UTVX6395 / MD6395 245mm/9.64"
			
UTVX6408 / MD6408 227mm/8.94"	UTVX6410 / MD6410 210mm/8.27"	UTVX6411 / MD6411 260mm/10.23"	UTVX6412 / MD6412 247.5mm/9.74"
			
UTVX6434 / MD6434 260mm/10.24"	UTVX6396 / MD6396 220mm/8.66"	UTVX6397 / MD6397 248mm/9.76"	

GP FAX Full Race Pads

PART #	BRIEF FITMENT
GP FAX16HH	ISR CALIPERS 22-030 (2 Piston Rear)/22-033 (2 Piston HD)
GP FAX95HH	DUCATI 748 Biposto 95-98, 851 Superbike Biposto 89-92, 916 (Biposto) 94-96, 916 Sienna 94-98
GP FAX197HH	HONDA NSF 100 R 06 / KAWASAKI EX 400 17-20
GP FAX244HH	BREMBO CALIPERS / DUCATI 748 99-02, 848 08-15, 916 97-98, 996 99-01, 998 02-03
GP FAX263HH	AP LOCKHEED CALIPERS / PFM CALIPERS Six piston superbike caliper
GP FAX295HH	BREMBO CALIPERS
GP FAX296HH	HONDA CBR 600 99-04 / KAWASAKI ZX6R (ZX 636 E) 636cc 13-17
GP FAX347HH	HONDA RS125 (Radial Caliper) 04-07, NSF250 R (Moto3) 12-13 / KAWASAKI Z900 17-20 / MORIWAKI MD250H 08-13 / YAMAHA TZ250 (Radial Caliper) 02-10
GP FAX379HH	KAWASAKI ZX 6R 18-20 / SUZUKI GSX-R 600 04-05, GSX-R 750 04-05, GSXR 1000 04-11
GP FAX380HH	YAMAHA YZF-R6 05-19, YZF-R198-19
GP FAX390HH	HONDA CBR 600 RR 05-17, VFR 800 F 14-15, CB 1000 R 10-16, CBR 1000 RR 04-16
GP FAX417/4HH	KAWASAKI ZX6R 07-12, Z 1000 07-08, ZG 1400 08-16, ZX14 Ninja ZX 1400 06-11, ZX14 R 12-17
GP FAX435/4HH	AP LOCKHEED CALIPERS
GP FAX442/4HH	YAMAHA YZ-R1 07-14
GP FAX447HH	BREMBO CALIPERS / HONDA CBR 1000 RR SP 14-20, RC 213 V-S 15-17 / KAWASAKI ZX10 R/RR Ninja ABS 16-20, Ninja 15-20 / SUZUKI GSX-R 600/750/1000 11-20, GSX-S 1000 16-20, GSX 1000 19-20 / BMW HP4 (1000cc) 13-14 / DUCATI 848 10-13, Desmosedici RR 08, 1098 07-09, Panigale V4 20, 1198 09-11, 1199 Panigale 12-15, 1299 Panigale 18-19, TRIUMPH Street Triple 675 18-19, Bonneville Street Scrambler 18-20
GP FAX491HH	TRIUMPH Daytona 675 09-17
GP FAX604/4HH	BMW S 1000 RR 10-17
GP FAX611HH	BREMBO CALIPERS
GP FAX630HH	BREMBO CALIPERS
GP FAX646HH	BREMBO CALIPERS
GP FAX662HH	YAMAHA MT03 & YZ-F R3
GP FAX663HH	YAMAHA YZ-F R3 15-20
GP FAX673HH	BREMBO CALIPERS
GP FAX700HH	HONDA CBR 600/1000 RR 18-20
GP FAX724HH	BMW S 1000 18-20, R1250 GS 18-20, R 1250 RT 18-20
GP FAX757HH	BMW M1000R, HONDA CBR 1000 RR-R SP Fire Blade Nissin Caliper

Dyno Graph

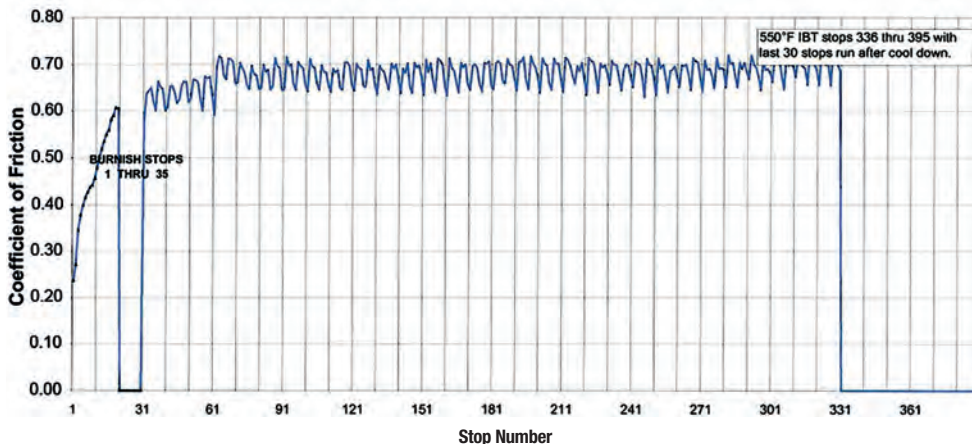

These pads bed in fast and deliver extremely high friction linear performance in track use. GP FAX pads are high friction but highly stable in stop. This means pads are powerful and predictable time after time when the brake is applied in race use. The “in-stop” friction fall off is almost zero and can hardly be noticed at the lever, meaning the brakes offer superb control. The EBC dyno is set to duplicate race conditions at the Road America race track and represents a true simulation of race brake demand. The number of race teams using GP FAX grows annually and for 2022 the exact same formulation developed through 2019 is used again.

EBC pads are developed in our own laboratory and tested using this race track simulator dynamometer to guarantee perfection before being thoroughly field tested on dozens of race teams.

EBC[®] BRAKES

Catalog - Issue 304

AMERICAN, EUROPEAN, ASIAN AND
BRITISH BUILT MACHINES



FRONT: AMERICAN PRODUCED MOTORCYCLES

APPLICATIONS



SUFFIX OR PREFIX
PAD MATERIALS AND DESCRIPTION

HARLEY-DAVIDSON® ELECTRIC

LiveWire 2018-2023

HARLEY-DAVIDSON® X350

HD350-10 2023-2024

HARLEY-DAVIDSON® SPORTSTER

XLH, XLCH 1973-1978

XLH 1000 1979-1981

Sportster 1984-1987

XLH 1200 1987-1999

XLH 883 *Oversize Rotor Available 2000-2003

XL 883 R Sportster Flat Track *Oversize Rotor Available 2000-2003

XL 883 Hugger *Oversize Rotor Available 2000-2003

XL 53c *Oversize Rotor Available 2000-2003

XL 883 R 100th Anniversary Edition *Oversize Rotor Available 2003

XL 883 Sportster Standard *Oversize Rotor Available 2004-2010

XL 883 C Sportster *Oversize Rotor Available 2004-2010

XL 883 Hugger *Oversize Rotor Available 2004-2006

XL 883 L Low *Oversize Rotor Available 2007-2010

XL 883 R Sportster *Oversize Rotor Available 2004-2013

XL 883 R Roadster *Oversize Rotor Available 2014-2015

XL 883 L Superlow *Oversize Rotor Available 2011-2013

XL 883 L Superlow *Oversize Rotor Available 2014-2022

XL 883 N Iron *Oversize Rotor Available 2009-2013

XL 883 N Iron *Oversize Rotor Available 2014-2023

RH 975 Nightster 2022-2024

XL 1200 *Oversize Rotor Available 2000-2003

XL 1200 Custom *Oversize Rotor Available 2000-2003

XL 1200 S *Oversize Rotor Available 2000-2003

XL 1200 R Sportster Roadster *Oversize Rotor Available 2004-2008

XL 50 Anniversary 1200 *Oversize Rotor Available 2007

XL 1200 *Oversize Rotor Available 2004-2010

XL 1200 Custom *Oversize Rotor Available 2004-2013

XL 1200 R *Oversize Rotor Available 2004-2009

XL 1200 N Nightster *Oversize Rotor Available 2007-2012

XL 1200 L *Oversize Rotor Available 2007-2012

XL 1200 X Forty Eight *Oversize Rotor Available 2010-2013

XL 1200 V Seventy Two *Oversize Rotor Available 2011-2013

XL 1200 C Custom *Oversize Rotor Available 2014-2021

XL 1200 CX Roadster *Oversize Rotor Available 2016-2021

XL 1200 T Superlow *Oversize Rotor Available 2014-2021

XL 1200 V Seventy Two *Oversize Rotor Available 2014-2016

XL 1200 X Forty Eight *Oversize Rotor Available 2014-2023

XL 1200 XS Forty Eight Special *Oversize Rotor Available 2018-2020

XL 1200 NS Iron *Oversize Rotor Available 2018-2021

XR 1200 2008-2010

XR 1200 X 2010-2013

RH 1250 Sportster S 2021-2024

HARLEY-DAVIDSON® STREET

XG 500 Street 2014-2015

XG 500 Street 2016-2020

XG 750 Street 2014-2015

XG 750 Street 2016-2020

XG 750 Street Rod 2017-2020

		FRONT				FRONT ROTOR OPTIONS
		PADS	PADS	PADS	PADS	DESIGN NO.
		FA	V	HH	EPFA	
		Organic Pads	Semi-Sintered V-Pads™	Double-H™ USA-Made Sintered Pads	Premium Low Noise Street Sintered Pads	See Buyers Guide for rotor style & finish options. Part nos for ordering & sizing.
				FA630HH*	EPFA630HH*	17
		FA244*		FA244HH*		
		FA26				
		FA71*				
		FA94	FA94V	FA94HH		2
		FA94	FA94V	FA94HH		2
		FA400	FA400V	FA400HH		1
		FA400	FA400V	FA400HH		1
		FA400	FA400V	FA400HH		1
		FA400*		FA400HH*	EPFA400HH*	1
		FA381	FA381V	FA381HH		1
		FA381	FA381V	FA381HH		1
		FA381	FA381V	FA381HH		1
		FA381	FA381V	FA381HH		1
		FA381*		FA381HH*		1
		FA640	FA640V	FA640HH	EPFA640HH	10
		FA381	FA381V	FA381HH	EPFA381HH	1
		FA640	FA640V	FA640HH	EPFA640HH	10
		FA381	FA381V	FA381HH	EPFA381HH	1
		FA640	FA640V	FA640HH		10
		FA409		FA409HH		TBC
		FA400	FA400V	FA400HH		1
		FA400	FA400V	FA400HH		1
		FA400*		FA400HH*		1
		FA381*		FA381HH*	EPFA381HH*	1
		FA381	FA381V	FA381HH	EPFA381HH	1
		FA381	FA381V	FA381HH		1
		FA381	FA381V	FA381HH		1
		FA381	FA381V	FA381HH		1
		FA381	FA381V	FA381HH		1
		FA381	FA381V	FA381HH		1
		FA381	FA381V	FA381HH		1
		FA381	FA381V	FA381HH	EPFA381HH	1
		FA640	FA640V	FA640HH	EPFA640HH	10
		FA640*		FA640HH*	EPFA640HH*	10
		FA640	FA640V	FA640HH	EPFA640HH	10
		FA640	FA640V	FA640HH	EPFA640HH	10
		FA640	FA640V	FA640HH	EPFA640HH	10
		FA640	FA640V	FA640HH	EPFA640HH	10
		FA640	FA640V	FA640HH	EPFA640HH	10
		FA640	FA640V	FA640HH	EPFA640HH	10
		FA640	FA640V	FA640HH	EPFA640HH	10
			FA630V	FA630HH		TBC
			FA643V	FA643HH		MD531
		FA209/2	FA209/2V	FA209/2HH	EPFA209/2HH	22
			FA643V	FA643HH		MD531
		FA209/2	FA209/2V	FA209/2HH	EPFA209/2HH	22
		FA209/2	FA209/2V	FA209/2HH	EPFA209/2HH	22

Line #

* This symbol indicates a rotor made of billet steel, and should be only used with EBC FA Organic or Vee pads.

*Oversize rotor available – see buyer's guide

* symbol after part# = 2 pieces required i.e. 2 pad sets or 2 rotors (twin rotor models)

Part numbers, prefixes, suffixes, photos and illustrations shown in this catalog are trademarks and/or copyrights of EBC Brakes or the trademark owner A C Freeman Investments Ltd and use without express written permission of the owners is punishable by law.

REAR: AMERICAN PRODUCED MOTORCYCLES



Line #

HARLEY-DAVIDSON® ELECTRIC

LiveWire 2018-2023

HARLEY-DAVIDSON® X350

HD350-10 2023-2024

HARLEY-DAVIDSON® SPORTSTER

XLH, XLCH 1973-1978

XLH 1000 1979-1981

1984-1987

XLH 1200 1987-1999

XLH 883 2000-2003

XL 883 R Sportster Flat Track 2000-2003

XL 883 Hugger 2000-2003

XL 53c 2000-2003

XL 883 R 100th Anniversary Edition 2003

XL 883 Sportster Standard 2004-2010

XL 883 C Sportster 2004-2010

XL 883 Hugger 2004-2006

XL 883 L Low 2007-2010

XL 883 R Sportster 2004-2013

XL 883 R Roadster 2014-2015

XL 883 L Superlow 2011-2013

XL 883 L Superlow 2014-2022

XL 883 N Iron 2009-2013

XL 883 N Iron 2014-2023

RH 975 Nightster 2022-2024

XL 1200 2000-2003

XL 1200 Custom 2000-2003

XL 1200 S 2000-2003

XL 1200 R Sportster Roadster 2004-2008

XL 50 Anniversary 1200 2007

XL 1200 2004-2010

XL 1200 Custom 2004-2013

XL 1200 R 2004-2009

XL 1200 N Nightster 2007-2012

XL 1200 L 2007-2012

XL 1200 X Forty Eight 2010-2013

XL 1200 V Seventy Two 2011-2013

XL 1200 C Custom 2014-2021

XL 1200 CX Roadster 2016-2021

XL 1200 T Superlow 2014-2021

XL 1200 V Seventy Two 2014-2016

XL 1200 X Forty Eight 2014-2023

XL 1200 XS Forty Eight Special 2018-2020

XL 1200 NS Iron 2018-2021

XR 1200 2008-2010

XR 1200 X 2010-2013

RH 1250 2021-2024

HARLEY-DAVIDSON® STREET

XG 500 Street 2014-2015

XG 500 Street 2016-2020

XG 750 Street 2014-2015

XG 750 Street 2016-2020

XG 750 Street Rod 2017-2020

SUFFIX OR PREFIX
PAD MATERIALS AND DESCRIPTION

YEAR

REAR					REAR ROTOR OPTIONS DESIGN NO.
PADS	PADS	PADS	PADS	See Buyers Guide for rotor style & finish options. Part nos for ordering & sizing.	
FA	V	HH	EPFA		
Organic Pads	Semi-Sintered V-Pads™	Double-H™ USA-Made Sintered Pads	Premium Low Noise Street Sintered Pads		
FA266		FA266HH			
FA698	FA698V	FA698HH			
FA72	FA72V				
FA72	FA72V				
FA78	FA78V	FA78HH			
FA200	FA200V	FA200HH	EPFA200HH		4
FA400	FA400V	FA400HH			3
FA400	FA400V	FA400HH			3
FA400	FA400V	FA400HH			3
FA400	FA400V	FA400HH	EPFA400HH		3
FA387	FA387V	FA387HH			3
FA387	FA387V	FA387HH			3
FA387	FA387V	FA387HH			3
FA387	FA387V	FA387HH			3
FA387	FA387V	FA387HH			3
FA254	FA254V	FA254HH	EPFA254HH		13
FA387	FA387V	FA387HH			13
FA254	FA254V	FA254HH			13
FA387	FA387V	FA387HH	EPFA387HH		3
FA254	FA254V	FA254HH			13
FA760	FA760V	FA760HH			TBC
FA400	FA400V	FA400HH			3
FA400	FA400V	FA400HH			3
FA400	FA400V	FA400HH			3
FA387	FA387V	FA387HH	EPFA387HH		3
FA387	FA387V	FA387HH	EPFA387HH		3
FA387	FA387V	FA387HH	EPFA387HH		3
FA387	FA387V	FA387HH	EPFA387HH		3
FA387	FA387V	FA387HH	EPFA387HH		3
FA387	FA387V	FA387HH	EPFA387HH		13
FA387	FA387V	FA387HH	EPFA387HH		3
FA387	FA387V	FA387HH	EPFA387HH		3
FA254	FA254V	FA254HH	EPFA254HH		13
FA254	FA254V	FA254HH	EPFA254HH		13
FA254	FA254V	FA254HH	EPFA254HH		13
FA254	FA254V	FA254HH	EPFA254HH		13
FA254	FA254V	FA254HH	EPFA254HH		13
FA254	FA254V	FA254HH	EPFA254HH		13
FA254	FA254V	FA254HH	EPFA254HH		13
FA254	FA254V	FA254HH	EPFA254HH		13
FA387	FA387V	FA387HH	EPFA387HH		13
FA387	FA387V	FA387HH	EPFA387HH		13
FA760	FA760V	FA760HH			
	FA643V	FA643HH			MD532
	FA643V	FA643HH			23
	FA643V	FA643HH			MD532
	FA643V	FA643HH			23
	FA643V	FA643HH			23

All names & numbers are for reference purposes only. © Registered trademarks of Harley—Davidson® Motor Corp or Buell.

NOTE: — Some models may have a second rotor fitted as an optional extra. Please double check with your customer exactly which side the front rotor is fitted and if twin rotor or single.

☛ This symbol indicates a rotor made of billet steel, and should be only used with EBC FA Organic or Vee pads.

BRAKE
APPLICATIONS

* symbol after part# = 2 pieces required i.e. 2 pad sets or 2 rotors (twin rotor models)

Part numbers, prefixes, suffixes, photos and illustrations shown in this catalog are trademarks and/or copyrights of EBC Brakes or the trademark owner A C Freeman Investments Ltd and use without express written permission of the owners is punishable by law.

FRONT: AMERICAN PRODUCED MOTORCYCLES

APPLICATIONS
BRAKE



SUFFIX OR PREFIX
PAD MATERIALS AND DESCRIPTION

HARLEY-DAVIDSON® DYNA

YEAR

		FRONT					Line #
		PADS	PADS	PADS	PADS	FRONT ROTOR OPTIONS	
		FA	V	HH	EPFA	DESIGN NO.	
		Organic Pads	Semi-Sintered V-Pads™	Double-HT™ USA-Made Sintered Pads	Premium Low Noise Street Sintered Pads	See Buyers Guide for rotor style & finish options. Part nos for ordering & sizing.	
FX, FXE Rivet type	1973-1977	FA26					1
FX, FXE, FXS Late 1978-1983	1978-1983	FA71	FA71V				2
FXD,FXDL,FXDWG,FXR,FXRS,FXRT,FXRD,FXLR	1982-1983	FA71*					3
FX, FXE, FXS	1984-1986	FA94*		FA94HH*	EPFA94HH*	2	4
FXWG, FXSB	1983	FA71	FA71V			2	5
FXD/L/WG, FXR/S/T/D/R 1984-Early 1987	1984-1987	FA94*		FA94HH*	EPFA94HH*	2	6
FXD/L/WG, FXR/S/T/D, FXLR Late 1987-1999	1987-1999	FA94*		FA94HH*	EPFA94HH*	2	7
FXD/L/WG, FXR/S/T/D, FXLR Late 1987-1999	1989-1999	FA94*		FA94HH*	EPFA94HH*	2	8
FXDS Convertible 1450 *Oversize Rotor Available	2000-2003	FA400*		FA400HH*	EPFA400HH*	1	9
FXDL Low Rider *Oversize Rotor Available	2000-2003	FA400*		FA400HH*	EPFA400HH*	1	10
FXDLi Low Rider *Oversize Rotor Available	2004-2007	FA400	FA400V	FA400HH	EPFA400HH	1	11
FXD Super Glide *Oversize Rotor Available	2000-2003	FA400	FA400V	FA400HH	EPFA400HH	1	12
FXDi Super Glide *Oversize Rotor Available	2004-2007	FA400	FA400V	FA400HH	EPFA400HH	1	13
FXDX Super Glide Sport *Oversize Rotor Available	2000-2003	FA400*		FA400HH*	EPFA400HH*	1	14
FXDXi Super Glide Sport *Oversize Rotor Available	2004-2005	FA400*		FA400HH*	EPFA400HH*	1	15
FXDWG Wide Glide *Oversize Rotor Available	2000-2003	FA400*		FA400HH*	EPFA400HH*	1	16
FXDWGi Wide Glide *Oversize Rotor Available	2004-2007	FA400	FA400V	FA400HH	EPFA400HH	1	17
FXDXT Superglide T-Sport *Oversize Rotor Available	2001-2003	FA400*		FA400HH*	EPFA400HH*	1	18
FXDCi Superglide Custom *Oversize Rotor Available	2005-2007	FA400	FA400V	FA400HH	EPFA400HH	1	19
FXDi Super Glide *Oversize Rotor Available	2006-2007	FA400	FA400V	FA400HH	EPFA400HH	10	20
FXDi Super Glide	2006-2007	FA400	FA400V	FA400HH	EPFA400HH	6	21
FXDBi Street Bob *Oversize Rotor Available	2006-2007	FA400	FA400V	FA400HH	EPFA400HH	1	22
FXDF Fat Bob	2008-2017			FA457HH*	EPFA457HH*	17	23
FXDF 96 Fat Bob *Oversize Rotor Available	2011-2017			FA457HH*	EPFA457HH*	10	24
FXDL Low Rider *Oversize Rotor Available	2008-2013		FA457V	FA457HH	EPFA457HH	10	25
FXDL Low Rider 103 *Oversize Rotor Available	2014-2017			FA457HH*	EPFA457HH*	10	26
FXDLS Dyna Low Rider S *Oversize Rotor Available	2017			FA457HH*	EPFA457HH*	10	27
FXDB Street Bob *Oversize Rotor Available	2008-2020		FA457V	FA457HH	EPFA457HH	10	28
FXDBC Street Bob LTD *Oversize Rotor Available	2016			FA457HH*	EPFA457HH*	10	29
FXDB Street Bob 114 *Oversize Rotor Available	2021-2022		FA457V	FA457HH	EPFA457HH	10	30
FLD Switchback *Oversize Rotor Available	2012-2016		FA457V	FA457HH	EPFA457HH	10	31
FXD Super Glide	2008-2010		FA457V	FA457HH	EPFA457HH	6	32
FXD Super Glide *Oversize Rotor Available	2008-2010		FA457V	FA457HH	EPFA457HH	10	33
FXDWG Wide Glide *Oversize Rotor Available	2008		FA457V	FA457HH	EPFA457HH	10	34
FXDWG Dyna Wide Glide *Oversize Rotor Available	2008-2020		FA457V	FA457HH	EPFA457HH	10	35
FXDC Super Glide Custom 96 *Oversize Rotor Available	2008-2014		FA457V	FA457HH	EPFA457HH	10	36
HARLEY-DAVIDSON® SOFTAIL							37
FXST/B/C/S, FLST/C/F/S/N	1984-1987	FA94	FA94V	FA94HH	EPFA94HH	2	39
FXST/B/C/S, FLST/C/F/S/N	1987-1999	FA94	FA94V	FA94HH	EPFA94HH	2	40
FXSTS Springer	2000-2005	FA94	FA94V	FA94HH	EPFA94HH	2	41
FLSTSC/FLSTSCi Springer Classic *Oversize Rotor Available	2006-2007	FA94	FA94V	FA94HH	EPFA94HH	1	42
FLSTS Heritage Springer *Oversize Rotor Available	2000-2003	FA94	FA94V	FA94HH	EPFA94HH	1	43
FLSTF Fat Boy *Oversize Rotor Available	2000-2007	FA400	FA400V	FA400HH	EPFA400HH	1	44
FLSTFi Fat Boy 15th Anniversary Edition *Oversize Rotor Available	2005	FA400	FA400V	FA400HH	EPFA400HH	1	45
FLSTC Heritage Classic *Oversize Rotor Available	2000-2007	FA400	FA400V	FA400HH	EPFA400HH	1	46
FLST Heritage Softail *Oversize Rotor Available	2006	FA400	FA400V	FA400HH	EPFA400HH	1	47
FXSTB Night Train *Oversize Rotor Available	2000-2005	FA400	FA400V	FA400HH	EPFA400HH	1	48
FXSTBi Night Train *Oversize Rotor Available	2006-2007	FA400	FA400V	FA400HH	EPFA400HH	1	49
FXSTDi Deuce *Oversize Rotor Available	2000-2007	FA400	FA400V	FA400HH	EPFA400HH	1	50
FXST Softail Standard *Oversize Rotor Available	2000-2005	FA400	FA400V	FA400HH	EPFA400HH	1	51
FXST Softail Standard *Oversize Rotor Available	2006-2007	FA400	FA400V	FA400HH	EPFA400HH	1	52
FLSTNi Softail Deluxe *Oversize Rotor Available	2005-2007	FA400	FA400V	FA400HH	EPFA400HH	1	53
FXSTC Softail Custom *Oversize Rotor Available	2007	FA400	FA400V	FA400HH	EPFA400HH	1	54
FLSTF Fat Boy *Oversize Rotor Available	2008-2014		FA457V	FA457HH	EPFA457HH	1	55

* symbol after part# = 2 pieces required i.e. 2 pad sets or 2 rotors (twin rotor models)

Part numbers, prefixes, suffixes, photos and illustrations shown in this catalog are trademarks and/or copyrights of EBC Brakes or the trademark owner A C Freeman Investments Ltd and use without express written permission of the owners is punishable by law.

This symbol indicates a rotor made of billet steel, and should be only used with EBC FA Organic or Vee pads.

*Oversize rotor available - see buyer's guide

REAR: AMERICAN PRODUCED MOTORCYCLES



SUFFIX OR PREFIX
PAD MATERIALS AND DESCRIPTION

Line #

HARLEY-DAVIDSON® DYNA

YEAR	FA	V	HH	EPFA	REAR ROTOR OPTIONS
1	FX, FXE Rivet type	1973-1977	FA24/2	FA24/2V	
2	FX, FXE, FXS Late 1978-1983	1978-1983	FA24/2	FA24/2V	
3	FXD,FXDL,FXDWG,FXR,FXRS,FXRT,FXRD,FXLR	1982-1983	FA78	FA78V	
4	FX, FXE, FXS	1984-1986	FA78	FA78V	FA78HH
5	FXWG, FXSB	1983	FA78	FA78V	FA78HH
6	FXD/L/WG, FXR/S/T/D/R 1984-Early 1987	1984-1987	FA78	FA78V	FA78HH
7	FXD/L/WG, FXR/S/T/D, FXLR Late 1987-1999	1987-1999	FA78	FA78V	FA78HH
8	FXD/L/WG, FXR/S/T/D, FXLR Late 1987-1999	1989-1999	FA200	FA200V	FA200HH EPFA200HH
9	FXDS Convertible 1450	2000-2003	FA400	FA400V	FA400HH
10	FXDL Low Rider	2000-2003	FA400	FA400V	FA400HH EPFA400HH
11	FXDLi Low Rider	2004-2007	FA400	FA400V	FA400HH EPFA400HH
12	FXD Super Glide	2000-2003	FA400	FA400V	FA400HH EPFA400HH*
13	FXDi Super Glide	2004-2007	FA400	FA400V	FA400HH EPFA400HH
14	FXDX Super Glide Sport	2000-2003	FA400	FA400V	FA400HH EPFA400HH
15	FXDXi Super Glide Sport	2004-2005	FA400	FA400V	FA400HH EPFA400HH
16	FXDWG Wide Glide	2000-2003	FA400	FA400V	FA400HH EPFA400HH
17	FXDWGi Wide Glide	2004-2007	FA400	FA400V	FA400HH EPFA400HH
18	FXDXT Superglide T-Sport	2001-2003	FA400	FA400V	FA400HH EPFA400HH
19	FXDCi Superglide Custom	2005-2007		FA458V	FA458HH EPFA400HH
20	FXDi Super Glide	2006-2007	FA400	FA400V	FA400HH EPFA400HH
21	FXDi Super Glide	2006-2007	FA400	FA400V	FA400HH EPFA400HH
22	FXDBi Street Bob	2006-2007	FA400	FA400V	FA400HH EPFA400HH
23	FXDF Fat Bob	2008-2017	FA78	FA78V	FA78HH
24	FXDF 96 Fat Bob	2011-2017	FA200	FA200V	FA200HH EPFA200HH
25	FXDL Low Rider	2008-2013		FA458V	FA458HH EPFA458HH
26	FXDL Low Rider 103	2014-2017		FA458V	FA458HH EPFA458HH
27	FXDLS Dyna Low Rider S	2017		FA458V	FA458HH EPFA458HH
28	FXDB Street Bob	2008-2020		FA458V	FA458HH EPFA458HH
29	FXDBC Street Bob LTD	2016		FA458V	FA458HH EPFA458HH
30	FXDB Street Bob 114	2021-2022		FA458V	FA458HH EPFA458HH
31	FLD Switchback	2012-2016		FA458V	FA458HH EPFA458HH
32	FXD Super Glide	2008-2010	FA78	FA78V	FA78HH
33	FXD Super Glide	2008-2010	FA78	FA78V	FA78HH
34	FXDWG Wide Glide	2008	FA400	FA400V	FA400HH EPFA400HH
35	FXDWG Dyna Wide Glide	2008-2020		FA458V	FA458HH EPFA458HH
36	FXDC Super Glide Custom 96	2008-2014		FA458V	FA458HH EPFA458HH

HARLEY-DAVIDSON® SOFTAIL

39	FXST/B/C/S, FLST/C/F/S/N	1984-1987	FA78	FA78V	FA78HH
40	FXST/B/C/S, FLST/C/F/S/N	1987-1999	FA200	FA200V	FA200HH EPFA200HH
41	FXSTS Springer	2000-2005	FA400	FA400V	FA400HH EPFA400HH
42	FLSTSC/FLSTSCi Springer Classic	2006-2007	FA400	FA400V	FA400HH EPFA400HH
43	FLSTS Heritage Springer	2000-2003	FA400	FA400V	FA400HH EPFA400HH
44	FLSTF Fat Boy	2000-2007	FA400	FA400V	FA400HH EPFA400HH
45	FLSTFi Fat Boy 15th Anniversary Edition	2005	FA400	FA400V	FA400HH EPFA400HH
46	FLSTC Heritage Classic	2000-2007	FA400	FA400V	FA400HH EPFA400HH
47	FLST Heritage Softail	2006	FA400	FA400V	FA400HH EPFA400HH
48	FXSTB Night Train	2000-2005	FA400	FA400V	FA400HH EPFA400HH
49	FXSTBi Night Train	2006-2007	FA434	FA434V	FA434HH
50	FXSTDI Deuce	2000-2007	FA400	FA400V	FA400HH EPFA400HH
51	FXST Softail Standard	2000-2005	FA400	FA400V	FA400HH EPFA400HH
52	FXST Softail Standard	2006-2007	FA434	FA434V	FA434HH
53	FLSTNi Softail Deluxe	2005-2007	FA400	FA400V	FA400HH EPFA400HH
54	FXSTC Softail Custom	2007	FA434	FA434V	FA434HH
55	FLSTF Fat Boy	2008-2014		FA458V	FA458HH EPFA458HH

* symbol after part# = 2 pieces required i.e. 2 pad sets or 2 rotors (twin rotor models)

Part numbers, prefixes, suffixes, photos and illustrations shown in this catalog are trademarks and/or copyrights of EBC Brakes or the trademark owner A C Freeman Investments Ltd and use without express written permission of the owners is punishable by law.

All names & numbers are for reference purposes only. © Registered trademarks of Harley—Davidson® Motor Corp or Buell.

NOTE: — Some models may have a second rotor fitted as an optional extra. Please double check with your customer exactly which side the front rotor is fitted and if twin rotor or single.

☉ This symbol indicates a rotor made of billet steel, and should be only used with EBC FA Organic or Vee pads.

BRAKE
APPLICATIONS

FRONT: AMERICAN PRODUCED MOTORCYCLES

APPLICATIONS
BRAKE



SUFFIX OR PREFIX
PAD MATERIALS AND DESCRIPTION

HARLEY-DAVIDSON® SOFTAIL

YEAR

		FRONT					
		PADS	PADS	PADS	PADS	FRONT ROTOR OPTIONS	
		FA	V	HH	EPFA	DESIGN NO.	
		Organic Pads	Semi-Sintered V-Pads™	Double-HT™ USA-Made Sintered Pads	Premium Low Noise Street Sintered Pads	See Buyers Guide for rotor style & finish options. Part nos for ordering & sizing.	
FLSTF Fat Boy *Oversize Rotor Available	2015-2017			FA296HH	EPFA296HH	10	1
FLSTC Heritage Softail Classic *Oversize Rotor Available	2008-2014		FA457V	FA457HH	EPFA457HH	1	2
FLSTC Heritage Softail Classic 96 *Oversize Rotor Available	2015-2017			FA296HH	EPFA296HH	10	3
FXSTB Night Train *Oversize Rotor Available	2008-2009		FA457V	FA457HH	EPFA457HH	1	4
FXSTC Softail Custom *Oversize Rotor Available	2008-2010		FA457V	FA457HH	EPFA457HH	1	5
FLSTN Softail Deluxe *Oversize Rotor Available	2008-2014		FA457V	FA457HH	EPFA457HH	1	6
FLSTN Softail Deluxe 96 *Oversize Rotor Available	2015-2017			FA296HH	EPFA296HH	10	7
FLSTSB Softail Cross Bones *Oversize Rotor Available	2008-2011	FA94	FA94V	FA94HH	EPFA94HH	1	8
FLSTFB Fat Boy LO *Oversize Rotor Available	2010-2014		FA457V	FA457HH	EPFA457HH	1	9
FLSTFB Fat Boy LO *Oversize Rotor Available	2015-2017			FA296HH	EPFA296HH	10	10
FLFB Fatboy 107 *Oversize Rotor Available	2018-2022			FA296HH	EPFA296HH	10	11
FLFBS Fat Boy 114 *Oversize Rotor Available	2018-2023			FA296HH	EPFA296HH	10	12
FLFBS Fat Boy 114 Anniversary *Oversize Rotor Available	2018			FA296HH	EPFA296HH	10	13
FXCW Rocker *Oversize Rotor Available	2008-2011		FA457V	FA457HH	EPFA457HH	1	14
FXCWC Rocker C *Oversize Rotor Available	2008-2011		FA457V	FA457HH	EPFA457HH	1	15
FXS Blackline *Oversize Rotor Available	2011-2013		FA457V	FA457HH	EPFA457HH	1	16
FXST Softail Standard *Oversize Rotor Available	2011-2014		FA457V	FA457HH	EPFA457HH	1	17
FXST Softail Standard 96 *Oversize Rotor Available	2014-2017			FA296HH	EPFA296HH	10	18
FXST Softail Standard 107 *Oversize Rotor Available	2020-2023			FA296HH	EPFA296HH	10	19
FLS Softail Slim *Oversize Rotor Available	2012-2014		FA457V	FA457HH	EPFA457HH	1	20
FLS Softail Slim 96 *Oversize Rotor Available	2015-2017			FA296HH	EPFA296HH	10	21
FXSB Breakout 96 *Oversize Rotor Available	2013-2014		FA457V	FA457HH	EPFA457HH	1	22
FXSB Breakout 96 & 103 *Oversize Rotor Available	2015-2017			FA296HH	EPFA296HH	10	23
FXBR Breakout *Oversize Rotor Available	2018-2020			FA296HH	EPFA296HH	10	24
FXBRS Breakout 114 *Oversize Rotor Available	2018-2022			FA296HH	EPFA296HH	10	25
FXBRS Breakout 114 Anniversary *Oversize Rotor Available	2018-2020			FA296HH	EPFA296HH	10	26
FLDE Deluxe 107 *Oversize Rotor Available	2018-2022			FA296HH	EPFA296HH	10	27
FXFB Fat Bob *Oversize Rotor Available	2018-2020			FA296HH*	EPFA296HH*	10	28
FXFBS Fat Bob 107 & 114 *Oversize Rotor Available	2018-2023			FA296HH*	EPFA296HH*	10	29
FXDR 114-FXDRS *Oversize Rotor Available	2018-2022			FA296HH*	EPFA296HH*	10	30
FLHC Heritage Classic 107 *Oversize Rotor Available	2018-2022			FA296HH	EPFA296HH	10	31
FLHCS Heritage Classic 114 *Oversize Rotor Available	2018-2023			FA296HH	EPFA296HH	10	32
FLHCS Heritage Classic 114 Anniversary *Oversize Rotor Available	2018-2020			FA296HH	EPFA296HH	10	33
FXLR Low Rider 107 *Oversize Rotor Available	2018-2020			FA296HH*	EPFA296HH*	10	34
FXLRS Low Rider S 114 *Oversize Rotor Available	2021-2024			FA296HH*	EPFA296HH*	10	35
FXLRST Low Rider ST 117 *Oversize Rotor Available	2022-2024			FA296HH*	EPFA296HH*	10	36
FLSL Softail Slim 107 *Oversize Rotor Available	2018-2022			FA296HH	EPFA296HH	10	37
FXBB Street Bob 107 *Oversize Rotor Available	2018-2023			FA296HH	EPFA296HH	10	38
FXLRT Low Rider EL Diablo 117 *Oversize Rotor Available	2022-2024			FA296HH*	EPFA296HH*	10	39
FLSB Sport Glide 107 *Oversize Rotor Available	2018-2023			FA296HH	EPFA296HH	10	40
HARLEY-DAVIDSON® S SERIES							41
FLSS Softail Slim S *Oversize Rotor Available	2016-2020			FA296HH	EPFA296HH	10	42
FLSTFBS Fat Boy S *Oversize Rotor Available	2016-2018			FA296HH	EPFA296HH	10	43
HARLEY-DAVIDSON® TOURING							44
FLT, FLHT, FLHTCI Ultraglide®/Electraglide®/Electraglide Classic®/Ultra Classic®	1980-1983						45
FLT, FLHT, FLHTCI Ultraglide®/Electraglide®/Electraglide Classic®/Ultra Classic®	1984-1985	FA94*		FA94HH*	EPFA94HH*		46
FLT, FLHT, FLHTCI Ultraglide®/Electraglide®/Electraglide Classic®/Ultra Classic®	1986-1999	FA94*		FA94HH*	EPFA94HH*	2	47
FLHR, FLHRCi Road King®, Road King Classic®	1994-1999	FA94*		FA94HH*	EPFA94HH*	2	48
FLHR Road King *Oversize Rotor Available	2000-2007	FA400*		FA400HH*	EPFA400HH*	1	49
FLHRCi Road King Classic *Oversize Rotor Available	2000-2007	FA400*		FA400HH*	EPFA400HH*	1	50
FLHRS Road King Custom *Oversize Rotor Available	2004-2007	FA400*		FA400HH*	EPFA400HH*	1	51
FLHT Electra Glide Standard *Oversize Rotor Available	2000-2007	FA400*		FA400HH*	EPFA400HH*	1	52
FLHTC Electra Glide Classic *Oversize Rotor Available	2000-2007	FA400*		FA400HH*	EPFA400HH*	1	53

* symbol after part# = 2 pieces required i.e. 2 pad sets or 2 rotors (twin rotor models)

Part numbers, prefixes, suffixes, photos and illustrations shown in this catalog are trademarks and/or copyrights of EBC Brakes or the trademark owner A C Freeman Investments Ltd and use without express written permission of the owners is punishable by law.

This symbol indicates a rotor made of billet steel, and should be only used with EBC FA Organic or Vee pads.

*Oversize rotor available – see buyer's guide

Line #

REAR: AMERICAN PRODUCED MOTORCYCLES



Line #

HARLEY-DAVIDSON® SOFTAIL

SUFFIX OR PREFIX
PAD MATERIALS AND DESCRIPTION

YEAR

REAR

PADS	PADS	PADS	PADS	REAR ROTOR OPTIONS
FA	V	HH	EPFA	DESIGN NO.
Organic Pads	Semi-Sintered V-Pads™	Double-H™ USA-Made Sintered Pads	Premium Low Noise Street Sintered Pads	See Buyers Guide for rotor style & finish options. Part nos for ordering & sizing.

1	FLSTF Fat Boy	2015-2017		FA458V	FA458HH	EPFA458HH	3
2	FLSTC Heritage Softail Classic	2008-2014		FA458V	FA458HH	EPFA458HH	3
3	FLSTC Heritage Softail Classic 96	2015-2017		FA458V	FA458HH	EPFA458HH	3
4	FXSTB Night Train	2008-2009		FA458V	FA458HH	EPFA458HH	3
5	FXSTC Softail Custom	2008-2010		FA458V	FA458HH	EPFA458HH	3
6	FLSTN Softail Deluxe	2008-2014		FA458V	FA458HH	EPFA458HH	3
7	FLSTN Softail Deluxe 96	2015-2017		FA458V	FA458HH	EPFA458HH	3
8	FLSTSB Softail Cross Bones	2008-2011		FA458V	FA458HH	EPFA458HH	3
9	FLSTFB Fat Boy LO	2010-2014		FA458V	FA458HH	EPFA458HH	3
10	FLSTFB Fat Boy LO	2015-2017		FA458V	FA458HH	EPFA458HH	3
11	FLFB Fatboy 107	2018-2022		FA710V	FA710HH	EPFA710HH	3
12	FLFBS Fat Boy 114	2018-2023		FA710V	FA710HH	EPFA710HH	3
13	FLFBS Fat Boy 114 Anniversary	2018		FA710V	FA710HH	EPFA710HH	3
14	FXCW Rocker	2008-2011		FA458V	FA458HH	EPFA458HH	3
15	FXCWC Rocker C	2008-2011		FA458V	FA458HH	EPFA458HH	3
16	FXS Blackline	2011-2013		FA458V	FA458HH	EPFA458HH	3
17	FXST Softail Standard	2011-2014		FA458V	FA458HH	EPFA458HH	3
18	FXST Softail Standard 96	2014-2017		FA710V	FA710HH	EPFA710HH	3
19	FXST Softail Standard 107	2020-2023		FA710V	FA710HH	EPFA710HH	3
20	FLS Softail Slim	2012-2014		FA458V	FA458HH	EPFA458HH	3
21	FLS Softail Slim 96	2015-2017		FA458V	FA458HH	EPFA458HH	3
22	FXSB Breakout 96	2013-2014		FA458V	FA458HH	EPFA458HH	3
23	FXSB Breakout 96 & 103	2015-2017		FA458V	FA458HH	EPFA458HH	3
24	FXBR Breakout	2018-2020		FA710V	FA710HH	EPFA710HH	3
25	FXBRS Breakout 114	2018-2022		FA710V	FA710HH	EPFA710HH	3
26	FXBRS Breakout 114 Anniversary	2018-2020		FA710V	FA710HH	EPFA710HH	3
27	FLDE Deluxe 107	2018-2022		FA710V	FA710HH	EPFA710HH	3
28	FXFB Fat Bob - Oversize Rotor Available	2018-2020		FA710V	FA710HH	EPFA710HH	3
29	FXFBS Fat Bob 107 & 114	2018-2023		FA710V	FA710HH	EPFA710HH	3
30	FXDR 114-FXDRS	2018-2022		FA387V	FA387HH	EPFA387HH	
31	FLHC Heritage Classic 107	2018-2022		FA710V	FA710HH	EPFA710HH	3
32	FLHCS Heritage Classic 114	2018-2023		FA710V	FA710HH	EPFA710HH	3
33	FLHCS Heritage Classic 114 Anniversary	2018-2020		FA710V	FA710HH	EPFA710HH	3
34	FXLR Low Rider 107	2018-2020		FA710V	FA710HH	EPFA710HH	3
35	FXLRS Low Rider S 114	2021-2024		FA710V	FA710HH	EPFA710HH	3
36	FXLRST Low Rider ST 117	2022-2024		FA710V	FA710HH	EPFA710HH	3
37	FLSL Softail Slim 107	2018-2022		FA710V	FA710HH	EPFA710HH	3
38	FXBB Street Bob 107	2018-2023		FA710V	FA710HH	EPFA710HH	3
39	FXLRT Low Rider EL Diablo 117	2022-2024		FA710V	FA710HH	EPFA710HH	3
40	FLSB Sport Glide 107	2018-2023		FA710V	FA710HH	EPFA710HH	3

HARLEY-DAVIDSON® S SERIES

43	FLSS Softail Slim S	2016-2020		FA458V	FA458HH	EPFA458HH	MD528
44	FLSTFBS Fat Boy S	2016-2018		FA458V	FA458HH	EPFA458HH	MD528

HARLEY-DAVIDSON® TOURING

47	FLT, FLHT, FLHTCI Ultraglide®/Electraglide®/Electraglide Classic®/Ultra Classic®	1980-1983	FA79	FA79V			
48	FLT, FLHT, FLHTCI Ultraglide®/Electraglide®/Electraglide Classic®/Ultra Classic®	1984-1985	FA79	FA79V			
49	FLT, FLHT, FLHTCI Ultraglide®/Electraglide®/Electraglide Classic®/Ultra Classic®	1986-1999	FA201	FA201V			MD509SR ⚡
50	FLHR, FLHRCI Road King®, Road King Classic®	1994-1999	FA201	FA201V			MD509SR ⚡
51	FLHR Road King	2000-2007	FA400	FA400V	FA400HH	EPFA400HH	3
52	FLHRCi Road King Classic	2000-2007	FA400	FA400V	FA400HH	EPFA400HH	3
53	FLHRS Road King Custom	2004-2007	FA400	FA400V	FA400HH	EPFA400HH	3
54	FLHT Electra Glide Standard	2000-2007	FA400	FA400V	FA400HH	EPFA400HH	3
55	FLHTC Electra Glide Classic	2000-2007	FA400	FA400V	FA400HH	EPFA400HH	3

* symbol after part# = 2 pieces required i.e. 2 pad sets or 2 rotors (twin rotor models)

Part numbers, prefixes, suffixes, photos and illustrations shown in this catalog are trademarks and/or copyrights of EBC Brakes or the trademark owner A C Freeman Investments Ltd and use without express written permission of the owners is punishable by law.

BRAKE APPLICATIONS

All names & numbers are for reference purposes only. © Registered trademarks of Harley—Davidson® Motor Corp or Buell.

NOTE: — Some models may have a second rotor fitted as an optional extra. Please double check with your customer exactly which side the front rotor is fitted and if twin rotor or single.

⚡ This symbol indicates a rotor made of billet steel, and should be only used with EBC FA Organic or Vee pads.

FRONT: AMERICAN PRODUCED MOTORCYCLES

APPLICATIONS
BRAKE



SUFFIX OR PREFIX
PAD MATERIALS AND DESCRIPTION

HARLEY-DAVIDSON® TOURING

YEAR

		FRONT				FRONT ROTOR OPTIONS	
		PADS	PADS	PADS	PADS	DESIGN NO.	
		FA	V	HH	EPFA		
		Organic Pads	Semi-Sintered V-Pads™	Double-HTM USA-Made Sintered Pads	Premium Low Noise Street Sintered Pads	See Buyers Guide for rotor style & finish options. Part nos for ordering & sizing.	Line #
FLHTCU-I Electra Glide Ultra Classic *Oversize Rotor Available	2000-2007	FA400*		FA400HH*	EPFA400HH*	1	1
FLHX/FLHXi Street Glide *Oversize Rotor Available	2006-2007	FA400*		FA400HH*	EPFA400HH*	1	2
FLHX/FLHXi Street Glide *Oversize Rotor Available	2000-2007	FA400*		FA400HH*	EPFA400HH*	1	3
FLHR Road King 96 *Oversize Rotor Available	2008-2016	FA409*		FA409HH*	EPFA409HH*	10	4
FLHR Road King	2015-2023	FA409*		FA409HH*	EPFA409HH*	17	5
FLHRC Road King Classic 96 *Oversize Rotor Available	2008-2020	FA409*		FA409HH*	EPFA409HH*	10	6
FLHRXS Road King Special 114	2017-2023	FA409*		FA409HH*	EPFA409HH*	17	7
FLHRXS Road King Special 114 *Oversize Rotor Available	2017-2023	FA409*		FA409HH*	EPFA409HH*	10	8
FLHT Electra Glide Standard 96 *Oversize Rotor Available	2008-2010	FA409*		FA409HH*	EPFA409HH*	10	9
FLHT Electra Glide Standard *Oversize Rotor Available	2021-2022	FA409*		FA409HH*	EPFA409HH*	10	10
FLH Revival	2021	FA409*		FA409HH*	EPFA409HH*	17	11
FLH Revival *Oversize Rotor Available	2021	FA409*		FA409HH*	EPFA409HH*	10	12
FLHTC Electra Glide Classic 96 *Oversize Rotor Available	2008-2013	FA409*		FA409HH*	EPFA409HH*	10	13
FLHTCU Ultra Classic Electra Glide 96 *Oversize Rotor Available	2008-2013	FA409*		FA409HH*	EPFA409HH*	10	14
FLHTCU Ultra Classic Electra Glide	2014-2020	FA409*		FA409HH*	EPFA409HH*	17	15
FLHTCUL Ultra Classic Electra Glide Low	2015-2016	FA409*		FA409HH*	EPFA409HH*	17	16
FLTR Road Glide *Oversize Rotor Available	2008-2009	FA409*		FA409HH*	EPFA409HH*	10	17
FLTRU Road Glide Ultra *Oversize Rotor Available	2011-2013	FA409*		FA409HH*	EPFA409HH*	10	18
FLTRU Road Glide Ultra	2016-2020	FA409*		FA409HH*	EPFA409HH*	17	19
FLTRU Road Glide Ultra Limited	2021-2023	FA409*		FA409HH*	EPFA409HH*	17	20
FLHX Street Glide 96 *Oversize Rotor Available	2008-2013	FA409*		FA409HH*	EPFA409HH*	10	21
FLHX Street Glide	2014-2023	FA409*		FA409HH*	EPFA409HH*	17	22
FLHX Street Glide ST	2022-2023	FA409*		FA409HH*	EPFA409HH*	17	23
FLHXS Street Glide Special	2015-2017	FA409*		FA409HH*	EPFA409HH*	17	24
FLHXS Street Glide Special	2015-2017	FA409*		FA409HH*	EPFA409HH*	17	25
FLHXS Street Glide Special	2018-2023	FA409*		FA409HH*	EPFA409HH*	17	26
FLHXS Street Glide Special *Oversize Rotor Available	2018-2023	FA409*		FA409HH*	EPFA409HH*	10	27
FLHXSE CVO Street Glide	2021-2022	FA409*		FA409HH*	EPFA409HH*	17	28
FLHXSE CVO Street Glide Custom *Oversize Rotor Available	2018-2019	FA409*		FA409HH*	EPFA409HH*	10	29
FLHXSE CVO Street Glide 121	2023-2024			FA630HH*	EPFA630HH*	TBC*	30
FLTRX Road Glide	2015-2023	FA409*		FA409HH*	EPFA409HH*	17	31
FLTRX Road Glide ST	2022-2023	FA409*		FA409HH*	EPFA409HH*	17	32
FLTRX Road Glide Custom *Oversize Rotor Available	2010-2012	FA409*		FA409HH*	EPFA409HH*	10	33
FLTRX Road Glide Limited	2018-2023	FA409*		FA409HH*	EPFA409HH*	17	34
FLTRX Road Glide Limited CVO	2022-2023	FA409*		FA409HH*	EPFA409HH*	17	35
FLTRXS Road Glide Special *Oversize Rotor Available	2015-2018	FA409*		FA409HH*	EPFA409HH*	10	36
FLTRXS Road Glide Special	2015-2018	FA409*		FA409HH*	EPFA409HH*	17	37
FLTRX Road Glide Special	2021-2023	FA409*		FA409HH*	EPFA409HH*	17	38
FLTRXSE Road Glide CVO 117 *Oversize Rotor Available	2018-2023	FA409*		FA409HH*	EPFA409HH*	10	39
FLTRXST Road Glide Special ST	2022	FA409*		FA409HH*	EPFA409HH*	17	40
FLTRXSE CVO Road Glide 121	2023			FA630HH*	EPFA630HH*	TBC*	41
FLHTK Electra Glide Ultra LTD *Oversize Rotor Available	2010-2013	FA409*		FA409HH*	EPFA409HH*	10	42
FLHTK Electra Glide Ultra LTD	2015-2021	FA409*		FA409HH*	EPFA409HH*	17	43
FLHTKL Electra Glide Ultra LTD Low	2015-2020	FA409*		FA409HH*	EPFA409HH*	17	44
FLHTKSE CVO Limited	2021-2023	FA409*		FA409HH*	EPFA409HH*	17	45
RA 1250 Pan America Adventure	2020-2023			FA630HH*	EPFA630HH*	MD8020*	46
RA 1250 S Pan America Adventure Special	2020-2023			FA630HH*	EPFA630HH*	MD8018X	47
HARLEY-DAVIDSON® V-ROD							
VRSCA	2002-2005	FA400*	FA400V*	FA400HH*	EPFA400HH*	6	48
VRSCB	2004-2005	FA400*	FA400V*	FA400HH*	EPFA400HH*	6	49
VRSCA *Oversize Rotor Available	2006	FA409*		FA409HH*	EPFA409HH*	7	50
VRSCD Night Rod *Oversize Rotor Available	2006-2008	FA409*		FA409HH*	EPFA409HH*	7	51
VRSCAW *Oversize Rotor Available	2007	FA409*		FA409HH*	EPFA409HH*	7	52
VRSCAW *Oversize Rotor Available	2008-2010	FA409*		FA409HH*	EPFA409HH*	10	53
							54
							55

* symbol after part# = 2 pieces required i.e. 2 pad sets or 2 rotors (twin rotor models)

Part numbers, prefixes, suffixes, photos and illustrations shown in this catalog are trademarks and/or copyrights of EBC Brakes or the trademark owner A C Freeman Investments Ltd and use without express written permission of the owners is punishable by law.

This symbol indicates a rotor made of billet steel, and should be only used with EBC FA Organic or Vee pads.

*Oversize rotor available – see buyer's guide

REAR: AMERICAN PRODUCED MOTORCYCLES



Line #

HARLEY-DAVIDSON® TOURING

SUFFIX OR PREFIX
PAD MATERIALS AND DESCRIPTION

YEAR

		REAR				REAR ROTOR OPTIONS	
		PADS	PADS	PADS	PADS	DESIGN NO.	
		FA	V	HH	EPFA	DESIGN NO.	
		Organic Pads	Semi-Sintered V-Pads™	Double-H™ USA-Made Sintered Pads	Premium Low Noise Street Sintered Pads	See Buyers Guide for rotor style & finish options. Part nos for ordering & sizing.	
1	FLHTCU-I Electra Glide Ultra Classic	2000-2007	FA400	FA400V	FA400HH	EPFA400HH	3
2	FLHX/FLHXi Street Glide	2006-2007	FA400	FA400V	FA400HH	EPFA400HH	3
3	FLHX/FLHXi Street Glide	2000-2007	FA400	FA400V	FA400HH	EPFA400HH	3
4	FLHR Road King 96	2008-2016	FA409	FA409V	FA409HH	EPFA409HH	9
5	FLHR Road King	2015-2023	FA409	FA409V	FA409HH	EPFA409HH	9
6	FLHRC Road King Classic 96	2008-2020	FA409	FA409V	FA409HH	EPFA409HH	9
7	FLHRXS Road King Special 114	2017-2023	FA409	FA409V	FA409HH	EPFA409HH	9
8	FLHRXS Road King Special 114	2017-2023	FA409	FA409V	FA409HH	EPFA409HH	9
9	FLHT Electra Glide Standard 96	2008-2010	FA409	FA409V	FA409HH	EPFA409HH	9
10	FLHT Electra Glide Standard	2021-2022	FA409	FA409V	FA409HH	EPFA409HH	9
11	FLH Revival	2021	FA409	FA409V	FA409HH	EPFA409HH	MD542
12	FLH Revival	2021	FA409	FA409V	FA409HH	EPFA409HH	MD542
13	FLHTC Electra Glide Classic 96	2008-2013	FA409	FA409V	FA409HH	EPFA409HH	9
14	FLHTCU Ultra Classic Electra Glide 96	2008-2013	FA409	FA409V	FA409HH	EPFA409HH	9
15	FLHTCU Ultra Classic Electra Glide	2014-2020	FA409	FA409V	FA409HH	EPFA409HH	9
16	FLHTCUL Ultra Classic Electra Glide Low	2015-2016	FA409	FA409V	FA409HH	EPFA409HH	9
17	FLTR Road Glide	2008-2009	FA409	FA409V	FA409HH	EPFA409HH	9
18	FLTRU Road Glide Ultra	2011-2013	FA409	FA409V	FA409HH	EPFA409HH	9
19	FLTRU Road Glide Ultra	2016-2020	FA409	FA409V	FA409HH	EPFA409HH	9
20	FLTRU Road Glide Ultra Limited	2021-2023	FA409	FA409V	FA409HH	EPFA409HH	9
21	FLHX Street Glide 96	2008-2013	FA409	FA409V	FA409HH	EPFA409HH	9
22	FLHX Street Glide	2014-2023	FA409	FA409V	FA409HH	EPFA409HH	9
23	FLHX Street Glide ST	2022-2023	FA409	FA409V	FA409HH	EPFA409HH	9
24	FLHXS Street Glide Special	2015-2017	FA409	FA409V	FA409HH	EPFA409HH	9
25	FLHXS Street Glide Special	2015-2017	FA409	FA409V	FA409HH	EPFA409HH	9
26	FLHXS Street Glide Special	2018-2023	FA409	FA409V	FA409HH	EPFA409HH	9
27	FLHXS Street Glide Special	2018-2023	FA409	FA409V	FA409HH	EPFA409HH	9
28	FLHXSE CVO Street Glide	2021-2022	FA409	FA409V	FA409HH	EPFA409HH	9
29	FLHXSE CVO Street Glide Custom	2018-2019	FA409	FA409V	FA409HH	EPFA409HH	9
30	FLHXSE CVO Street Glide 121	2023-2024	FA409	FA409V	FA409HH	EPFA409HH	9
31	FLTRX Road Glide	2015-2023	FA409	FA409V	FA409HH	EPFA409HH	9
32	FLTRX Road Glide ST	2022-2023	FA409	FA409V	FA409HH	EPFA409HH	9
33	FLTRX Road Glide Custom	2010-2012	FA409	FA409V	FA409HH	EPFA409HH	9
34	FLTRX Road Glide Limited	2018-2023	FA409	FA409V	FA409HH	EPFA409HH	9
35	FLTRX Road Glide Limited CVO	2022-2023	FA409	FA409V	FA409HH	EPFA409HH	9
36	FLTRXS Road Glide Special	2015-2018	FA409	FA409V	FA409HH	EPFA409HH	9
37	FLTRXS Road Glide Special	2015-2018	FA409	FA409V	FA409HH	EPFA409HH	9
38	FLTRX Road Glide Special	2021-2023	FA409	FA409V	FA409HH	EPFA409HH	9
39	FLTRXSE Road Glide CVO 117	2018-2023	FA409	FA409V	FA409HH	EPFA409HH	9
40	FLTRXST Road Glide Special ST	2022	FA409	FA409V	FA409HH	EPFA409HH	9
41	FLTRXSE CVO Road Glide 121	2023	FA409	FA409V	FA409HH	EPFA409HH	9
42	FLHTK Electra Glide Ultra LTD	2010-2013	FA409	FA409V	FA409HH	EPFA409HH	9
43	FLHTK Electra Glide Ultra LTD	2015-2021	FA409	FA409V	FA409HH	EPFA409HH	9
44	FLHTKL Electra Glide Ultra LTD Low	2015-2020	FA409	FA409V	FA409HH	EPFA409HH	9
45	FLHTKSE CVO Limited	2021-2023		FA409V	FA409HH	EPFA409HH	9
46	RA 1250 Pan America Adventure	2020-2023	FA213	FA213V	FA213HH		MD8019
47	RA 1250 S Pan America Adventure Special	2020-2023					
48	HARLEY-DAVIDSON® V-ROD						
49							
50	VRSCA	2002-2005					
51	VRSCB	2004-2005					
52	VRSCA	2006	FA409	FA409V	FA409HH	EPFA409HH	8
53	VRSCD Night Rod	2006-2008	FA409	FA409V	FA409HH	EPFA409HH	8
54	VRSCAW	2007	FA409	FA409V	FA409HH	EPFA409HH	8
55	VRSCAW	2008-2010	FA409	FA409V	FA409HH	EPFA409HH	8

* symbol after part# = 2 pieces required i.e. 2 pad sets or 2 rotors (twin rotor models)

Part numbers, prefixes, suffixes, photos and illustrations shown in this catalog are trademarks and/or copyrights of EBC Brakes or the trademark owner A C Freeman Investments Ltd and use without express written permission of the owners is punishable by law.

All names & numbers are for reference purposes only. © Registered trademarks of Harley—Davidson® Motor Corp or Buell.

NOTE: — Some models may have a second rotor fitted as an optional extra. Please double check with your customer exactly which side the front rotor is fitted and if twin rotor or single.

☉ This symbol indicates a rotor made of billet steel, and should be only used with EBC FA Organic or Vee pads.

BRAKE APPLICATIONS

FRONT: AMERICAN PRODUCED MOTORCYCLES

APPLICATIONS
BRAKE



SUFFIX OR PREFIX
PAD MATERIALS AND DESCRIPTION

HARLEY-DAVIDSON® V-ROD

YEAR	FRONT				FRONT ROTOR OPTIONS	
	PADS	PADS	PADS	PADS	DESIGN NO.	
	FA	V	HH	EPFA		
	Organic Pads	Semi-Sintered V-Pads™	Double-HT™ USA-Made Sintered Pads	Premium Low Noise Street Sintered Pads	See Buyers Guide for rotor style & finish options. Part nos for ordering & sizing.	
VRSCDX Night Rod Special inc 105 model *Oversize Rotor Available	2007-2017	FA409*		FA409HH*	EPFA409HH*	7
VRSCDX Night Rod Special Ann *Oversize Rotor Available	2012	FA409*		FA409HH*	EPFA409HH*	7
VRSCF Muscle inc 105 model *Oversize Rotor Available	2009-2017	FA409*		FA409HH*	EPFA409HH*	7
VRSCR Street Rod *Oversize Rotor Available	2006-2007	FA409*		FA409HH*	EPFA409HH*	7
VRSCAW *Oversize Rotor Available	2007	FA409*		FA409HH*	EPFA409HH*	10

HARLEY-DAVIDSON® TRIKE

FLHTCUTG Tri Glide Ultra Classic Trike	2009-2013			FA409HH*	EPFA409HH*	10
FLHXXX Street Glide Trike	2010-2013			FA409HH*	EPFA409HH*	10
FLHTCUTG Tri Glide Ultra	2014-2019			FA638HH*	EPFA638HH*	10
FLHTCUTG Tri Glide Ultra	2020-2023			FA638HH*	EPFA638HH*	10
FLRT Freewheeler Trike	2015-2019			FA638HH*	EPFA638HH*	10
FLRT Freewheeler Trike	2020-2023			FA638HH*	EPFA638HH*	10
FLHTCUTGSE CVO Tri Glide	2021-2023			FA409HH*		10

ARCH

1 S	2019-2022	FA175*		FA175HH*		
KRGT-1	2019-2021	FA175*		FA175HH*		
Method 143	2019-2021	FA175*		FA175HH*		

ARCTIC CAT ATV

50 2 x 4 Youth	2004-2006	338*		338G*		
50 4 x 4 Auto Youth	2006-2008	338*		338G*		
50 DVX Sport	2006-2008	338*		338G*		
90 2 x 4 Youth	2002-2004	338*		338G*		
90 2 x 4 Youth	2004-2005	338*		338G*		
90 2 x 4 Youth	2006	338*		338G*		
90 Alterra 90	2018-2023	338*		338G*		
90 DVX	2006-2012	338*		338G*		
90 DVX	2018	338*		388G		
90 DVX SE	2009	338*		338G*		
90 Reverse Gear Model	2010-2013	338*		338G*		
150 2 x 4 Utility	2015-2018	303*		303G*		
150 2 x 4 Utility	2009-2015	303*		303G*		
250 2 x 4 Utility	1999-2004	FA271X*		FA271R*		MD6173D*
250 2 x 4 Utility	2005-2009	FA395X*		FA395R*		MD6173D*
250 4 x 4 Utility	2001-2004	FA271X*		FA271R*		MD6173D*
250 4 x 4 Utility	2005	FA395X*		FA395R*		MD6173D*
250 4 x 4 Utility	2008	FA395X*		FA395R*		MD6173D*
250 DVX Sport	2006-2008	FA377X*		FA377R*		MD6267D*
300 2 x 4 Utility	2010-2014	FA377X*		FA377R*		MD6267D*
300 4 x 4	1998-2004	FA271X*		FA271R*		MD6173D*
300 4 x 4 Utility	2005	FA395X*		FA395R*		MD6173D*
300 Alterra	2017-2023	FA377X*		FA377R*		MD6267D*
300 DVX	2009-2012	FA377X*		FA377R*		MD6267D*
350 ATV	2012	FA395X*		FA395R*		MD6173D*
366 4 x 4 Auto Utility	2008-2009	FA395X*		FA395R*		MD6173D*
366 SE	2010	FA395X*		FA395R*		MD6173D*
400 2 x 4 Utility	1998-2004	FA271X*		FA271R*		MD6173D*
400 4 x 4	2004	FA271X*		FA271R*		MD6173D*
400 4 x 4	2006-2007	FA395X*		FA395R*		MD6173D*
400 4 x 4 Utility	2000-2004	FA271X*		FA271R*		MD6173D*
400 4 x 4 Utility	2005-2008	FA395X*		FA395R*		MD6173D*
400 Alterra	2016-2018	FA395X*		FA395R*		MD6383D*

* symbol after part# = 2 pieces required i.e. 2 pad sets or 2 rotors (twin rotor models)

Part numbers, prefixes, suffixes, photos and illustrations shown in this catalog are trademarks and/or copyrights of EBC Brakes or the trademark owner A C Freeman Investments Ltd and use without express written permission of the owners is punishable by law.

This symbol indicates a rotor made of billet steel, and should be only used with EBC FA Organic or Vee pads. *Oversize rotor available - see buyer's guide

Line #

1
2
3
4
5
6
7
8
9
10
11
12
13
14
15
16
17
18
19
20
21
22
23
24
25
26
27
28
29
30
31
32
33
34
35
36
37
38
39
40
41
42
43
44
45
46
47
48
49
50
51
52
53
54
55

REAR: AMERICAN PRODUCED MOTORCYCLES



Line #

			REAR				
			PADS	PADS	PADS	PADS	REAR ROTOR OPTIONS
			FA	V	HH	EPFA	DESIGN NO.
SUFFIX OR PREFIX PAD MATERIALS AND DESCRIPTION			Organic Pads	Semi-Sintered V-Pads™	Double-H™ USA-Made Sintered Pads	Premium Low Noise Street Sintered Pads	See Buyers Guide for rotor style & finish options. Part nos for ordering & sizing.
YEAR							
HARLEY-DAVIDSON® V-ROD							
1	VRSCDX Night Rod Special inc 105 model	2007-2017	FA409	FA409V	FA409HH	EPFA409HH	8
2	VRSCDX Night Rod Special Ann	2012	FA409	FA409V	FA409HH	EPFA409HH	8
3	VRSCF Muscle inc 105 model	2009-2017	FA409	FA409V	FA409HH	EPFA409HH	14
4	VRSCR Street Rod	2006-2007	FA409	FA409V	FA409HH	EPFA409HH	8
5	VRSCAW	2007	FA409	FA409V	FA409HH	EPFA409HH	8
HARLEY-DAVIDSON® TRIKE							
8	FLHTCUTG Tri Glide Ultra Classic Trike	2009-2013		FA605/4V ▲	FA605/4HH ▲		MD540
9	FLHXXX Street Glide Trike	2010-2013		FA605/4V ▲	FA605/4HH ▲		MD540
10	FLHTCUTG Tri Glide Ultra	2014-2019		FA641/4V ▲	FA641/4HH ▲		MD538
11	FLHTCUTG Tri Glide Ultra	2020-2023	FA631		FA631HH		MD538
12	FLRT Freewheeler Trike	2015-2019		FA641/4V ▲	FA641/4HH ▲		MD538
13	FLRT Freewheeler Trike	2020-2023	FA631		FA631HH		MD538
14	FLHTCUTGSE CVO Tri Glide	2021-2023			FA631HH		MD538
▲ PADS ARE SOLD IN AXLE SETS – 4 PADS PER SET							
ARCH							
18	1 S	2019-2022	FA47		FA47HH		
19	KRGT-1	2019-2021	FA47		FA47HH		
20	Method 143	2019-2021	FA47		FA47HH		
ARCTIC CAT ATV							
23	50 2 x 4 Youth	2004-2006	FA305X		FA305R		MD6267D
24	50 4 x 4 Auto Youth	2006-2008	FA305X		FA305R		MD6267D
25	50 DVX Sport	2006-2008	FA305X		FA305R		MD6267D
26	90 2 x 4 Youth	2002-2004	307		307G		
27	90 2 x 4 Youth	2004-2005	307		307G		
28	90 2 x 4 Youth	2006	FA305X		FA305R		
29	90 Alterra 90	2018-2023	FA377X	FA377V	FA377R		MD6267D
30	90 DVX	2006-2012	FA305X		FA305R		MD6267D
31	90 DVX	2018	FA377X	FA377V	FA377R		
32	90 DVX SE	2009	FA305X		FA305R		MD6267D
33	90 Reverse Gear Model	2010-2013	FA305X		FA305R		MD6267D
34	150 2 x 4 Utility	2015-2018	FA377X	FA377V	FA377R		
35	150 2 x 4 Utility	2009-2015	FA305X		FA305R		MD6267D
36	250 2 x 4 Utility	1999-2004	FA271X		FA271R		MD6173D
37	250 2 x 4 Utility	2005-2009	FA395X		FA395R		MD6173D
38	250 4 x 4 Utility	2001-2004	FA271X		FA271R		MD6173D
39	250 4 x 4 Utility	2005	FA395X		FA395R		MD6173D
40	250 4 x 4 Utility	2008	FA395X		FA395R		MD6173D
41	250 DVX Sport	2006-2008	FA355/4X		FA355/4R		MD6268D
42	300 2 x 4 Utility	2010-2014	FA377X*	FA377V*	FA377R		
43	300 4 x 4	1998-2004	FA271X		FA271R		MD6173D
44	300 4 x 4 Utility	2005	FA395X		FA395R		MD6173D
45	300 Alterra	2017-2023	FA377X	FA377V	FA377R		
46	300 DVX	2009-2012	FA355/4X		FA355/4R		MD6268D
47	350 ATV	2012	FA395X		FA395R		MD6173D
48	366 4 x 4 Auto Utility	2008-2009	FA395X		FA395R		MD6173D
49	366 SE	2010	FA395X		FA395R		MD6173D
50	400 2 x 4 Utility	1998-2004	FA271X		FA271R		MD6173D
51	400 4 x 4	2004	FA271X		FA271R		MD6173D
52	400 4 x 4	2007	FA395X		FA395R		MD6173D
53	400 4 x 4 Utility	2000-2004	FA271X		FA271R		MD6173D
54	400 4 x 4 Utility	2005-2008	FA395X		FA395R		MD6173D
55	400 Alterra	2016-2018	FA395X		FA395R		MD6383D

* symbol after part# = 2 pieces required i.e. 2 pad sets or 2 rotors (twin rotor models)

Part numbers, prefixes, suffixes, photos and illustrations shown in this catalog are trademarks and/or copyrights of EBC Brakes or the trademark owner A C Freeman Investments Ltd and use without express written permission of the owners is punishable by law.

BRAKE APPLICATIONS

All names & numbers are for reference purposes only. © Registered trademarks of Harley—Davidson® Motor Corp or Buell.

NOTE: — Some models may have a second rotor fitted as an optional extra. Please double check with your customer exactly which side the front rotor is fitted and if twin rotor or single.

☛ This symbol indicates a rotor made of billet steel, and should be only used with EBC FA Organic or Vee pads.

FRONT: AMERICAN PRODUCED MOTORCYCLES

APPLICATIONS
BRAKE



SUFFIX OR PREFIX
PAD MATERIALS AND DESCRIPTION

ARCTIC CAT ATV

YEAR

FRONT					
PADS	PADS	PADS	PADS	FRONT ROTOR OPTIONS	
FA	V	HH	EPFA	DESIGN NO.	
Organic Pads	Semi-Sintered V-Pads™	Double-HTM USA-Made Sintered Pads	Premium Low Noise Street Sintered Pads	See Buyers Guide for rotor style & finish options. Part nos for ordering & sizing.	
400 ATV	2013-2014	FA395X*		FA395R*	MD6375D*
400 DVX Sport	2004-2008	FA84X*		FA84R*	MD6210D*
400 DVX TS Sport	2006-2007	FA84X*		FA84R*	MD6210D*
400 TRV	2009-2013	FA395X*		FA395R*	MD6173D*
425i SE	2012	FA395X*		FA395R*	MD6173D*
425i	2012	FA395X*		FA395R*	MD6173D*
450 4H1 EFI	2010	FA395X*		FA395R*	MD6173D*
450 ATV	2013-2014	FA395X*		FA395R*	MD6375D*
450 TRV	2011-2012	FA395X*		FA395R*	MD6173D*
450i GT	2012	FA395X*		FA395R*	MD6173D*
450i TRV	2011	FA395X*		FA395R*	MD6173D*
450i XC	2013-2014	FA395X*		FA395R*	MD6375D*
450i XC	2015-2017	FA395X*		FA395R*	MD6173D*
450i XC	2011-2012	FA395X*		FA395R*	MD6173D*
450i	2011-2012	FA395X*		FA395R*	MD6173D*
450 Alterra	2016-2023	FA395X*		FA395R*	MD6173D*
454 Bearcat 2 x 4	1997-1998	FA271X*		FA271R*	MD6173D*
454 Bearcat 4 x 4	1996-1998	FA271X*		FA271R*	MD6173D*
500 4 x 4	2008	FA395X*		FA395R*	MD6173D*
500 4 x 4 Utility	1998-2004	FA271X*		FA271R*	MD6173D*
500 4 x 4 Utility	2005-2009	FA395X*		FA395R*	MD6173D*
500 4 x 4 Multirider	2005-2006	FA395X*		FA395R*	MD6173D*
500 Alterra	2016-2019	FA395X*		FA395R*	MD6383D*
500 ATV	2013-2014	FA395X*		FA395R*	MD6375D*
500 TRV	2013	FA395X*		FA395R*	MD6375D*
500 XT	2013-2014	FA395X*		FA395R*	MD6375D*
550 Alterra TRV XT	2016-2019	FA395X*		FA395R*	MD6383D*
550 ATV	2013-2014	FA395X*		FA395R*	MD6375D*
550 ATV LTD	2013-2014	FA395X*		FA395R*	MD6375D*
550 ATV XT	2013-2014	FA395X*		FA395R*	MD6375D*
550 GT S TRV	2010	FA395X*		FA395R*	MD6173D*
550 GT TRV	2011-2012	FA395X*		FA395R*	MD6173D*
550 HI EFI	2009-2010	FA395X*		FA395R*	MD6173D*
550i All Models	2011-2012	FA395X*		FA395R*	MD6173D*
550 S Inc TRV	2009-2011	FA395X*		FA395R*	MD6173D*
550 S LTD	2010	FA395X*		FA395R*	MD6173D*
550 TRV LTD	2013	FA395X*		FA395R*	MD6375D*
570 Alterra	2019-2020	FA395X*		FA395R*	MD6383D*
600 Alterra	2022-2023	FA395X*		FA395R*	MD6383D*
650 H1	2010	FA395X*		FA395R*	MD6173D*
650 H1 4 x 4 Utility	2004-2008	FA271X*		FA271R*	MD6173D*
650 H1 Mudpro	2010	FA395X*		FA395R*	MD6384D*
650 H1 TBX 4 x 4 Utility	2007	FA395X*		FA395R*	MD6173D*
650 H1 TRV	2007-2009	FA395X*		FA395R*	MD6173D*
650 Mudpro	2010-2011	FA395X*		FA395R*	MD6384D*
650 TBX	2009	FA395X*		FA395R*	MD6173D*
650 V2 4 x 4 Utility	2004-2006	FA395X*		FA395R*	MD6173D*
700 Alterra	2016-2023	FA395X*		FA395R*	MD6383D*
700 Alterra TBX	2017-2018	FA395X*		FA395R*	MD6383D*
700 Alterra VLX	2017-2018	FA395X*		FA395R*	MD6383D*
700 ATV	2012-2013	FA395X*		FA395R*	MD6375D*
700 ATV	2013-2014	FA395X*		FA395R*	
700 ATV LTD	2012-2014	FA395X*		FA395R*	MD6375D*
700 ATV XT	2013-2014	FA395X*		FA395R*	MD6375D*
700 EFI 4 x 4	2006-2008	FA395X*		FA395R*	MD6173D*

Line #

* This symbol indicates a rotor made of billet steel, and should be only used with EBC FA Organic or Vee pads.

* symbol after part# = 2 pieces required i.e. 2 pad sets or 2 rotors (twin rotor models)

Part numbers, prefixes, suffixes, photos and illustrations shown in this catalog are trademarks and/or copyrights of EBC Brakes or the trademark owner A C Freeman Investments Ltd and use without express written permission of the owners is punishable by law.

REAR: AMERICAN PRODUCED MOTORCYCLES



Line #

ARCTIC CAT ATV

SUFFIX OR PREFIX
PAD MATERIALS AND DESCRIPTION

YEAR

REAR					REAR ROTOR OPTIONS DESIGN NO.
PADS	PADS	PADS	PADS		
FA	V	HH	EPFA		
Organic Pads	Semi-Sintered V-Pads™	Double-H™ USA-Made Sintered Pads	Premium Low Noise Street Sintered Pads	See Buyers Guide for rotor style & finish options. Part nos for ordering & sizing.	
400 ATV	2013-2014	FA395X		FA395R	MD6173D
400 DVX Sport	2004-2008	FA137X		FA137R	MD6211D
400 DVX TS Sport	2006-2007	FA137X		FA137R	MD6211D
400 TRV	2009	FA395X		FA395R	MD6173D
425i SE	2012	FA395X		FA395R	MD6173D
425i	2012	FA395X		FA395R	MD6173D
450 4H1 EFI	2010	FA395X		FA395R	MD6173D
450 ATV	2013-2014	FA395X		FA395R	MD6375D
450 TRV	2011-2012	FA395X		FA395R	MD6173D
450i GT	2012	FA395X		FA395R	MD6173D
450i TRV	2011	FA395X		FA395R	MD6173D
450i XC	2013-2014	FA395X		FA395R	
450i XC	2015-2017	FA395X		FA395R	MD6173D
450i XC	2011-2012	FA395X		FA395R	MD6173D
450i	2011-2012	FA395X		FA395R	MD6173D
450 Alterra	2016-2023	FA395X		FA395R	MD6173D
454 Bearcat 2 x 4	1997-1998	FA271X		FA271R	MD6173D
454 Bearcat 4 x 4	1996-1998	FA271X		FA271R	MD6173D
500 4 x 4	2008	FA395X		FA395R	MD6173D
500 4 x 4 Utility	1998-2004	FA271X		FA271R	MD6173D
500 4 x 4 Utility	2005-2009	FA395X		FA395R	MD6173D
500 4 x 4 Multirider	2005-2006	FA395X		FA395R	MD6173D
500 Alterra	2016-2019	FA395X		FA395R	MD6383D
500 ATV	2013-2014	FA395X		FA395R	MD6375D
500 TRV	2013	FA395X		FA395R	MD6375D
500 XT	2013-2014	FA395X		FA395R	MD6375D
550 Alterra TRV XT	2016-2019	FA395X		FA395R	MD6383D
550 ATV	2013-2014	FA395X		FA395R	MD6375D
550 ATV LTD	2013-2014	FA395X		FA395R	MD6375D
550 ATV XT	2013-2014	FA395X		FA395R	MD6375D
550 GT S TRV	2010	FA395X		FA395R	MD6173D
550 GT TRV	2011-2012	FA395X		FA395R	MD6173D
550 HI EFI	2009-2010	FA395X		FA395R	MD6173D
550i All Models	2011-2012	FA395X		FA395R	MD6173D
550 S	2010	FA395X		FA395R	MD6173D
550 S LTD	2010	FA395X		FA395R	MD6173D
550 TRV LTD	2013	FA395X		FA395R	MD6375D
570 Alterra 570	2019-2020	FA395X		FA395R	MD6383D
600 Alterra 600	2022-2023	FA395X		FA395R	MD6383D
650 H1	2010	FA395X		FA395R	MD6173D
650 H1 4 x 4 Utility	2004-2008	FA271X		FA271R	MD6173D
650 H1 Mudpro	2010	FA395X		FA395R	MD6173D
650 H1 TBX 4 x 4 Utility	2007	FA395X		FA395R	MD6173D
650 H1 TRV	2009	FA395X		FA395R	MD6173D
650 Mudpro	2010-2011	FA395X		FA395R	MD6173D
650 TBX	2009	FA395X		FA395R	MD6173D
650 V2 4 x 4 Utility	2004-2006	FA395X		FA395R	MD6173D
700 Alterra	2016-2023	FA395X		FA395R	MD6383D
700 Alterra TBX	2017-2018	FA395X		FA395R	MD6383D
700 Alterra VLX	2017-2018	FA395X		FA395R	MD6383D
700 ATV	2012-2013	FA395X		FA395R	MD6375D
700 ATV	2013-2014	FA395X		FA395R	
700 ATV LTD	2012-2014	FA395X		FA395R	MD6375D
700 ATV XT	2013-2014	FA395X		FA395R	MD6375D
700 Efi 4 x 4	2006-2008	FA395X		FA395R	MD6173D

* symbol after part# = 2 pieces required i.e. 2 pad sets or 2 rotors (twin rotor models)

Part numbers, prefixes, suffixes, photos and illustrations shown in this catalog are trademarks and/or copyrights of EBC Brakes or the trademark owner A C Freeman Investments Ltd and use without express written permission of the owners is punishable by law.

BRAKE
APPLICATIONS

All names & numbers are for reference purposes only. © Registered trademarks of Harley—Davidson® Motor Corp or Buell.

NOTE: — Some models may have a second rotor fitted as an optional extra. Please double check with your customer exactly which side the front rotor is fitted and if twin rotor or single.

⊗ This symbol indicates a rotor made of billet steel, and should be only used with EBC FA Organic or Vee pads.

FRONT: AMERICAN PRODUCED MOTORCYCLES

APPLICATIONS
BRAKE



SUFFIX OR PREFIX
PAD MATERIALS AND DESCRIPTION

		FRONT					Line #
		PADS	PADS	PADS	PADS	FRONT ROTOR OPTIONS	
		FA	V	HH	EPFA	DESIGN NO.	
		Organic Pads	Semi-Sintered V-Pads™	Double-HT™ USA-Made Sintered Pads	Premium Low Noise Street Sintered Pads	See Buyers Guide for rotor style & finish options. Part nos for ordering & sizing.	
ARCTIC CAT ATV							
700 EFi Cruiser	2011	FA395X*		FA395R*		MD6173D*	1
700 H1 EFi	2008-2010	FA395X*		FA395R*		MD6173D*	2
700i GT	2011-2012	FA395X*		FA395R*		MD6173D*	3
700i LTD	2011-2012	FA395X*		FA395R*		MD6173D*	4
700i Mudpro	2011-2013	FA395X*		FA395R*		MD6384D*	5
700i Mudpro LTD	2011	FA395X*		FA395R*		MD6384D*	6
700i	2011-2012	FA395X*		FA395R*		MD6173D*	7
700 Mudpro	2010-2017	FA395X*		FA395R*		MD6384D*	8
700 S	2010	FA395X*		FA395R*		MD6173D*	9
700 Super Duty Diesel	2010-2011	FA395X*		FA395R*		MD6173D*	10
700 TBX	2011-2013	FA395X*		FA395R*		MD6375D*	11
700 TRV	2009-2012	FA395X*		FA395R*		MD6173D*	12
700 TRV XT	2013	FA395X*		FA395R*		MD6375D*	13
700 Utility	2007-2008	FA395X*		FA395R*		MD6173D*	14
700 XR LTD/XT	2015	FA395X*		FA395R*		MD6383D*	15
1000 Alterra TRV XT EPS	2017	FA395X*		FA395R*		MD6383D*	16
1000 H2 Mudpro EFi	2010-2017	FA395X*		FA395R*		MD6384D*	17
1000 Mudpro	2010-2013	FA395X*		FA395R*		MD6384D*	18
1000 Mudpro SE EPS	2016	FA395X*		FA395R*		MD6384D*	19
1000 Thundercat H2	2008-2010	FA395X*		FA395R*		MD6173D*	20
1000 TRV All Models	2009-2011	FA395X*		FA395R*		MD6173D*	21
1000 XT	2013-2014	FA395X*		FA395R*			22
ARCTIC CAT SIDE X SIDE							
550 H1 EFi Prowler	2009	FA395X*		FA395R*		MD6271D*	25
550 XT	2010-2011	FA395X*		FA395R*		MD6271D*	26
550 XT Prowler	2011-2014	FA395X*		FA395R*		MD6271D*	27
650 H1 Prowler	2007	FA395X*		FA395R*		MD6271D*	28
650 Prowler	2008	FA395X*		FA395R*		MD6271D*	29
650 XT H1 Prowler	2006-2009	FA395X*		FA395R*		MD6271D*	30
700 HDX LTD Prowler	2014	FA395X*		FA395R*		MD6271D*	31
700 HDX Prowler	2011-2014	FA395X*		FA395R*		MD6271D*	32
700 HDX Trail	2014	FA395X*		FA395R*		MD6271D*	33
700 Wildcat Sport All Models	2015-2019	FA741X*		FA741R*			34
700 Wildcat Trail XT	2015-2019	FA395X*		FA395R*		MD6384D*	35
700 XTX Prowler All Models	2008-2014	FA395X*		FA395R*		MD6271D*	36
812 Prowler Pro	2019-2023	FA740X*		FA740R*			37
900 Havoc X EPS	2018			FA737R*			38
900 Stampede 4 Inferno	2018			FA737R*			39
900 Stampede XT/ XTR	2017-2019			FA737R*			40
1000 Cushman Hauler 4x4	2019-2020	FA740X*		FA740R*			41
1000 Wildcat	2019	FA740X*		FA740R*			42
1000 Wildcat 4	2013-2014			FA610R*		MD6384D*	43
1000 Wildcat 4 LTD	2014			FA610R*		MD6384D*	44
1000 Wildcat 4X	2014-2016			FA610R*		MD6384D*	45
1000 Wildcat 4X-LTD	2014-2015			FA610R*		MD6384D*	46
1000 Wildcat GT	2011-2012	FA395X*		FA395R*		MD6271D*	47
1000 Wildcat GT	2013-2014	FA395X*		FA395R*			48
1000 Wildcat LTD	2013-2014	FA395X*		FA395R*			49
1000 Wildcat X All Models	2014-2016	FA395X*		FA395R*			50
1000 XTZ Prowler	2010-2014	FA395X*		FA395R*		MD6271D*	51
1200 Cushamn Hauler	2012-2015	FA737X*		FA737R*			52
							53
							54
							55

* This symbol indicates a rotor made of billet steel, and should be only used with EBC FA Organic or Vee pads.

* symbol after part# = 2 pieces required i.e. 2 pad sets or 2 rotors (twin rotor models)

Part numbers, prefixes, suffixes, photos and illustrations shown in this catalog are trademarks and/or copyrights of EBC Brakes or the trademark owner A C Freeman Investments Ltd and use without express written permission of the owners is punishable by law.

REAR: AMERICAN PRODUCED MOTORCYCLES



Line #
1
2
3
4
5
6
7
8
9
10
11
12
13
14
15
16
17
18
19
20
21
22
23
24
25
26
27
28
29
30
31
32
33
34
35
36
37
38
39
40
41
42
43
44
45
46
47
48
49
50
51
52
53
54
55

ARCTIC CAT ATV

SUFFIX OR PREFIX
PAD MATERIALS AND DESCRIPTION

YEAR

REAR					
PADS	PADS	PADS	PADS	REAR ROTOR OPTIONS	
FA	V	HH	EPFA	DESIGN NO.	
Organic Pads	Semi-Sintered V-Pads™	Double-H™ USA-Made Sintered Pads	Premium Low Noise Street Sintered Pads	See Buyers Guide for rotor style & finish options. Part nos for ordering & sizing.	
700 Efi Cruiser	2011	FA395X		FA395R	MD6173D
700 H1 Efi	2008-2010	FA395X		FA395R	MD6173D
700i GT	2011-2012	FA395X		FA395R	MD6173D
700i LTD	2011-2012	FA395X		FA395R	MD6173D
700i Mudpro	2011-2013	FA395X		FA395R	MD6173D
700i Mudpro LTD	2011	FA395X		FA395R	MD6173D
700i	2011-2012	FA395X		FA395R	MD6173D
700 Mudpro	2010-2017	FA395X		FA395R	MD6173D
700 S	2010	FA395X		FA395R	MD6173D
700 Super Duty Diesel	2010-2011	FA395X		FA395R	MD6173D
700 TBX	2013	FA395X		FA395R	MD6375D
700 TRV	2011-2012	FA395X		FA395R	MD6173D
700 TRV XT	2013	FA395X		FA395R	MD6375D
700 Utility	2007-2008	FA395X		FA395R	MD6173D
700 XR LTD/XT	2015	FA395X		FA395R	MD6383D
1000 Alterra TRV XT EPS	2017	FA395X		FA395R	MD6383D
1000 H2 Mudpro Efi	2010-2017	FA395X		FA395R	MD6173D
1000 Mudpro	2010-2013	FA395X		FA395R	MD6271D
1000 Mudpro SE EPS	2016	FA395X		FA395R	MD6383D
1000 Thundercat H2	2008-2010	FA395X		FA395R	MD6173D
1000 TRV Cruiser	2011	FA395X		FA395R	MD6173D
1000 XT	2013-2014	FA395X		FA395R	MD6173D
ARCTIC CAT SIDE X SIDE					
550 H1 Efi Prowler	2009	FA395X		FA395R	
550 XT	2010-2011	FA395X		FA395R	
550 XT Prowler	2011-2014	FA395X		FA395R	
650 H1 Prowler	2007	FA395X		FA395R	
650 Prowler	2008	FA395X		FA395R	
650 XT H1 Prowler	2006-2009	FA395X		FA395R	
700 HDX LTD Prowler	2014	FA395X*		FA395R*	
700 HDX Prowler	2011-2014	FA395X*		FA395R*	
700 HDX Trail	2014	FA395X*		FA395R*	
700 Wildcat Sport	2015				
700 Wildcat Trail XT	2015-2019	FA395X*		FA395R*	
700 XTX Prowler	2011-2014	FA395X		FA395R	
812 Prowler Pro	2019-2023	FA742X*		FA742R*	
900 Havoc X EPS	2018			FA737R*	
900 Stampede 4 Inferno	2018			FA737R*	
900 Stampede XT/ XTR	2017-2019			FA737R*	
1000 Cushman Hauler 4x4	2019-2020	FA742X*		FA742R*	
1000 Wildcat	2019	FA742X*		FA742R*	
1000 Wildcat 4	2013-2014	FA395X*		FA395R*	
1000 Wildcat 4 LTD	2014	FA395X*		FA395R*	
1000 Wildcat 4X	2014-2016	FA395X*		FA395R*	
1000 Wildcat 4X-LTD	2014-2015	FA395X*		FA395R*	
1000 Wildcat GT	2011-2012	FA395X*		FA395R*	
1000 Wildcat GT	2013-2014	FA395X*		FA395R*	
1000 Wildcat LTD	2013-2014	FA395X*		FA395R*	
1000 Wildcat X	2014-2016	FA395X*		FA395R*	
1000 XTZ Prowler	2010-2014	FA395X*		FA395R*	
1200 Cushman Hauler	2012-2015				

* symbol after part# = 2 pieces required i.e. 2 pad sets or 2 rotors (twin rotor models)

Part numbers, prefixes, suffixes, photos and illustrations shown in this catalog are trademarks and/or copyrights of EBC Brakes or the trademark owner A C Freeman Investments Ltd and use without express written permission of the owners is punishable by law.

BRAKE APPLICATIONS

All names & numbers are for reference purposes only. © Registered trademarks of Harley—Davidson® Motor Corp or Buell.

NOTE: — Some models may have a second rotor fitted as an optional extra. Please double check with your customer exactly which side the front rotor is fitted and if twin rotor or single.

⊗ This symbol indicates a rotor made of billet steel, and should be only used with EBC FA Organic or Vee pads.

FRONT: AMERICAN PRODUCED MOTORCYCLES

APPLICATIONS
BRAKE



SUFFIX OR PREFIX
PAD MATERIALS AND DESCRIPTION

FRONT

YEAR	FA	V	HH	EPFA	FRONT ROTOR OPTIONS
					DESIGN NO.
					See Buyers Guide for rotor style & finish options. Part nos for ordering & sizing.
ATK					
125	FA181X		FA181R	EPFA181HH	
250	FA181X		FA181R	EPFA181HH	MD6032D
GT 250 R V-Twin Sport	FA86*		FA86HH*		MD690*
GV 250 V-Twin Cruiser	FA86		FA86HH		
260	FA181X		FA181R	EPFA181HH	
370	FA181X		FA181R	EPFA181HH	MD6032D
450 Enduro	FA181X		FA181R	EPFA181HH	
450 Motard	FA95		FA95HH	EPFA95HH	
450 MX	FA181X		FA181R	EPFA181HH	
450 XC	FA181X		FA181R	EPFA181HH	
500 Enduro	FA181X		FA181R	EPFA181HH	
500	FA181X		FA181R	EPFA181HH	MD6032D
560	FA47X				
560	FA47X				
560	FA126X				
All models	FA126X				
All models	FA135X		FA135R		
All models	FA181X		FA181R	EPFA181HH	
500/600 Super Motard	FA95		FA95HH	EPFA95HH	
600 DTM Dirt Track Motard	FA95		FA95HH	EPFA95HH	
605 Enduro	FA181X		FA181R	EPFA181HH	
620 Intimidator	FA181X		FA181R	EPFA181HH	MD6032D
650 GT R V-Twin Sport	FA86*		FA86HH*		MD690*
650 GV V-Twin Cruiser	FA86*		FA86HH*		MD691*
700 Intimidator	FA181X		FA181R	EPFA181HH	MD6032D
700 Intimidator	FA181X		FA181R	EPFA181HH	MD6032D
BOMBARDIER/BRP (SEE CAM-AM FOR 07 MODELS)					
DS 50	346*		346G*		
DS 90	346*		346G*		
Quest 50	346*		346G*		
Quest 90	346*		346G*		
Rally 200	FA83X*		FA83R*		MD6220D*
Rally 200	FA83X*		FA83R*		MD6220D*
DS 250	FA377X*		FA377R*		MD6283D*
Outlander 330 HO	Left 2004-2005	FA307X	SXR307HH	FA307R	MD6222D*
	Right	FA317X	SXR317HH	FA317R	
Outlander 400 Max HO	Left 2003-2006	FA307X	SXR307HH	FA307R	MD6222D*
	Right	FA317X	SXR317HH	FA317R	
Outlander 400	Left 2003-2004	FA307X	SXR307HH	FA307R	MD6222D*
	Right	FA317X	SXR317HH	FA317R	
Quest 500 2 x 4	Left 2002	FA307X	SXR307HH	FA307R	MD6224D*
	Right	FA317X	SXR317HH	FA317R	
Quest 500 4 x 4	Left 2002-2004	FA307X	SXR307HH	FA307R	MD6224D*
	Right	FA317X	SXR317HH	FA317R	
DS 650 Baja/X	Left 2001-2006	FA307X	SXR307HH	FA307R	MD6171D*
	Right	FA317X	SXR317HH	FA317R	
DS 650 Max	Left 2004-2005	FA307X	SXR307HH	FA307R	MD6245D*
	Right	FA317X	SXR317HH	FA317R	
DS 650	Left 2000-2005	FA307X	SXR307HH	FA307R	MD6171D*
	Right	FA317X	SXR317HH	FA317R	
Outlander 650 HO	Left 2006	FA307X	SXR307HH	FA307R	MD6222D*
	Right	FA317X	SXR317HH	FA317R	
Outlander Max 650 HO	Left 2006	FA307X	SXR307HH	FA307R	MD6222D*
	Right	FA317X	SXR317HH	FA317R	

This symbol indicates a rotor made of billet steel, and should be only used with EBC FA Organic or Vee pads.

Line #

* symbol after part# = 2 pieces required i.e. 2 pad sets or 2 rotors (twin rotor models)

Part numbers, prefixes, suffixes, photos and illustrations shown in this catalog are trademarks and/or copyrights of EBC Brakes or the trademark owner A C Freeman Investments Ltd and use without express written permission of the owners is punishable by law.

FRONT: AMERICAN PRODUCED MOTORCYCLES

APPLICATIONS
BRAKE



BOMBARDIER/BRP (SEE CAM-AM FOR 07 MODELS)

SUFFIX OR PREFIX
PAD MATERIALS AND DESCRIPTION

YEAR

					FRONT				FRONT ROTOR OPTIONS	Line #	
					PADS	PADS	PADS	PADS			DESIGN NO.
					FA	V	HH	EPFA			
					Organic Pads	Semi-Sintered V-Pads™	Double-H™ USA-Made Sintered Pads	Premium Low Noise Street Sintered Pads		See Buyers Guide for rotor style & finish options. Part nos for ordering & sizing.	
Quest 650 2 x 4	Left		2002		FA307X	SXR307HH	FA307R		MD6224D*	1	
	Right				FA317X	SXR317HH	FA317R			2	
Quest 650 4 x 4	Left		2002-2004		FA307X	SXR307HH	FA307R		MD6224D*	3	
	Right				FA317X	SXR317HH	FA317R			4	
Quest 650 XT 4 x 4	Left		2002		FA307X	SXR307HH	FA307R		MD6224D*	5	
	Right				FA317X	SXR317HH	FA317R			6	
Quest Max 650	Left		2003		FA307X	SXR307HH	FA307R		MD6224D*	7	
	Right				FA317X	SXR317HH	FA317R			8	
Quest Max/STD/XT	Left		2004-2005		FA307X	SXR307HH	FA307R		MD6245D*	9	
	Right				FA317X	SXR317HH	FA317R			10	
Traxter 4 x 4			1999-2000		FA266*		FA266R*		MD6229D*	11	
Traxter 4 x 4	Left		2001		FA307X	SXR307HH	FA307R		MD6229D*	12	
	Right				FA317X	SXR317HH	FA317R			13	
Traxter Autoshift	Left		2001-2005		FA307X	SXR307HH	FA307R		MD6225D*	14	
	Right				FA317X	SXR317HH	FA317R			15	
Traxter Autoshift			2001		FA266*		FA266R*		MD6229D*	16	
Traxter Footshift			2001		FA266*		FA266R*		MD6229D*	17	
Traxter Footshift	Left		2001		FA307X	SXR307HH	FA307R		MD6229D*	18	
	Right				FA317X	SXR317HH	FA317R			19	
Traxter Max	Left		2003-2005		FA307X	SXR307HH	FA307R		MD6245D*	20	
	Right				FA317X	SXR317HH	FA317R			21	
Traxter XL	Left		2004		FA307X	SXR307HH	FA307R		MD6245D*	22	
	Right				FA317X	SXR317HH	FA317R			23	
Traxter XL 4 x 4			2001		FA266*		FA266R*		MD6229D*	24	
Traxter XL 4 x 4	Left		2001-2004		FA307X	SXR307HH	FA307R		MD6229D*	25	
	Right				FA317X	SXR317HH	FA317R			26	
Traxter XT 4 x 4	Left		2001		FA307X	SXR307HH	FA307R		MD6229D*	27	
	Right				FA317X	SXR317HH	FA317R			28	
Outlander 800 All Models	Left		2006		FA307X	SXR307HH	FA307R		MD6222D*	29	
	Right				FA317X	SXR317HH	FA317R			30	
Sarasota 1000 Side x Side			2005							31	
BUELL											
Blast			2000-2007		FA196	FA196V	FA196HH		MD737	34	
S1 Lightning			1994-1997		FA210	FA210V			MD719RS	35	
S1 Lightning			1998-2000		FA424		FA424HH		MD719RS	36	
S1 White Lightning			1998-2000		FA424		FA424HH		MD719RS	37	
X1 Lightning			1998-2000		FA424		FA424HH		MD719RS	38	
X1 Lightning			2000-2005		FA424		FA424HH		MD734RS	39	
1125 CR			2009-2010				FA454/4HH	EPFA454/4HH	MD735RS	40	
1125 R			2008-2010				FA454/4HH	EPFA454/4HH	MD735RS	41	
Firebolt XB9R			2002-2007				FA345HH	EPFA345HH	MD735RS	42	
M2 Cyclone			1994-1997		FA210	FA210V			MD719RS	43	
M2 Cyclone			1998-2000		FA424		FA424HH		MD719RS	44	
M2 Cyclone			2000-2005		FA424		FA424HH		MD734RS	45	
S2 Thunderbolt			1994-1997		FA210	FA210V			MD719RS	46	
S3 Thunderbolt			1994-1997		FA210	FA210V			MD719RS	47	
S3 Thunderbolt			1998-2000		FA424		FA424HH		MD719RS	48	
S3T Thunderbolt			1998-2000		FA424		FA424HH		MD719RS	49	
XB12 R Firebolt			2004-2008				FA345HH	EPFA345HH	MD735RS	50	
XB12 R Firebolt			2009-2010				FA454/4HH	EPFA454/4HH	MD735RS	51	
XB12 S Lightning			2004-2008				FA345HH	EPFA345HH	MD735RS	52	
XB12 SCG Lightning			2006-2008				FA345HH	EPFA345HH	MD735RS	53	
XB12 SCG Lightning			2009-2010				FA454/4HH	EPFA454/4HH	MD735RS	54	
XB12 Ss Lightning			2009-2010				FA454/4HH	EPFA454/4HH	MD735RS	55	

* symbol after part# = 2 pieces required i.e. 2 pad sets or 2 rotors (twin rotor models)

Part numbers, prefixes, suffixes, photos and illustrations shown in this catalog are trademarks and/or copyrights of EBC Brakes or the trademark owner A C Freeman Investments Ltd and use without express written permission of the owners is punishable by law.

This symbol indicates a rotor made of billet steel, and should be only used with EBC FA Organic or Vee pads.

REAR: AMERICAN PRODUCED MOTORCYCLES



Line #

BOMBARDIER/BRP (SEE CAM-AM FOR 07 MODELS)

SUFFIX OR PREFIX
PAD MATERIALS AND DESCRIPTION
YEAR

REAR								
PADS	PADS	PADS	PADS	REAR ROTOR OPTIONS				
FA	V	HH	EPFA	DESIGN NO.				
Organic Pads	Semi-Sintered V-Pads™	Double-H™ USA-Made Sintered Pads	Premium Low Noise Street Sintered Pads	See Buyers Guide for rotor style & finish options. Part nos for ordering & sizing.				
1	Quest 650 2 x 4	Left	2002	FA317X		FA317R		MD6225D
2		Right						
3	Quest 650 4 x 4	Left	2002-2004	FA317X		FA317R		MD6225D
4		Right						
5	Quest 650 XT 4 x 4	Left	2002	FA317X		FA317R		MD6225D
6		Right						
7	Quest Max 650	Left	2003	FA317X		FA317R		MD6225D
8		Right						
9	Quest Max/STD/XT	Left	2004-2005	FA317X		FA317R		MD6225D
10		Right						
11	Traxter 4 x 4		1999-2000	FA266		FA266R		MD6230D
12	Traxter 4 x 4	Left	2001	FA307X		FA307R		MD6230D
13		Right						
14	Traxter Autoshift	Left	2001-2005	FA317X		FA317R		MD6224D
15		Right						
16	Traxter Autoshift		2001	FA266		FA266R		MD6230D
17	Traxter Footshift		2001	FA266		FA266R		MD6230D
18	Traxter Footshift	Left	2001	FA317X		FA317R		MD6230D
19		Right						
20	Traxter Max	Left	2003-2005	FA317X		FA317R		MD6225D
21		Right						
22	Traxter XL	Left	2004	FA317X		FA317R		MD6225D
23		Right						
24	Traxter XL 4 x 4		2001	FA266		FA266R		MD6230D
25	Traxter XL 4 x 4	Left	2001-2004	FA317X		FA317R		MD6230D
26		Right						
27	Traxter XT 4 x 4	Left	2001	FA317X		FA317R		MD6230D
28		Right						
29	Outlander 800 All Models	Left	2006	FA307X		FA307R		MD6223D
30		Right						
31	Sarasota 1000 Side x Side		2005					
32	BUELL							
33								
34	Blast		2000-2007	FA140	FA140V	FA140HH		MD738
35	S1 Lightning		1994-1997	FA251				MD511
36	S1 Lightning		1998-2000	FA140	FA140V	FA140HH		MD511
37	S1 White Lightning		1998-2000	FA140	FA140V	FA140HH		MD511
38	X1 Lightning		1998-2000	FA140	FA140V	FA140HH		MD511
39	X1 Lightning		2000-2005	FA140	FA140V	FA140HH		MD511
40	1125 CR		2009-2010			FA460HH		
41	1125 R		2008-2010			FA460HH		
42	Firebolt XB9R		2002-2007	FA140	FA140V	FA140HH		MD522
43	M2 Cyclone		1994-1997	FA251				MD511
44	M2 Cyclone		1998-2000	FA140	FA140V	FA140HH		MD511
45	M2 Cyclone		2000-2005	FA140	FA140V	FA140HH		MD511
46	S2 Thunderbolt		1994-1997	FA251				MD511
47	S3 Thunderbolt		1994-1997	FA251				MD511
48	S3 Thunderbolt		1998-2000	FA140	FA140V	FA140HH		MD511
49	S3T Thunderbolt		1998-2000	FA140	FA140V	FA140HH		MD511
50	XB12 R Firebolt		2004-2008	FA140	FA140V	FA140HH		MD522
51	XB12 R Firebolt		2009-2010	FA140	FA140V	FA140HH		MD522
52	XB12 S Lightning		2004-2008	FA140	FA140V	FA140HH		MD522
53	XB12 SCG Lightning		2006-2008	FA140	FA140V	FA140HH		MD522
54	XB12 SCG Lightning		2009-2010	FA140	FA140V	FA140HH		MD522
55	XB12 Ss Lightning		2009-2010	FA140	FA140V	FA140HH		MD522

* symbol after part# = 2 pieces required i.e. 2 pad sets or 2 rotors (twin rotor models)

Part numbers, prefixes, suffixes, photos and illustrations shown in this catalog are trademarks and/or copyrights of EBC Brakes or the trademark owner A C Freeman Investments Ltd and use without express written permission of the owners is punishable by law.

BRAKE APPLICATIONS

All names & numbers are for reference purposes only. © Registered trademarks of Harley—Davidson® Motor Corp or Buell.

NOTE: — Some models may have a second rotor fitted as an optional extra. Please double check with your customer exactly which side the front rotor is fitted and if twin rotor or single.

☉ This symbol indicates a rotor made of billet steel, and should be only used with EBC FA Organic or Vee pads.

FRONT: AMERICAN PRODUCED MOTORCYCLES

APPLICATIONS
BRAKE



SUFFIX OR PREFIX
PAD MATERIALS AND DESCRIPTION

YEAR

FRONT

PADS

PADS

PADS

PADS

FRONT ROTOR
OPTIONS

FA

V

HH

EPFA

DESIGN NO.

Organic
Pads

Semi-Sintered
V-Pads™

Double-H™
USA-Made
Sintered Pads

Premium Low
Noise Street
Sintered Pads

See Buyers Guide for
rotor style & finish
options. Part nos for
ordering & sizing.

Line #

BUELL

XB12 Ss Lightning Long		2006-2008			FA345HH	EPFA345HH	MD735RS	1
XB12 STT Lightning		2008			FA345HH	EPFA345HH	MD735RS	2
XB12 X Ulysses		2006-2010			FA345HH	EPFA345HH	MD735RS	3
XB12 XT Ulysses		2008-2010			FA345HH	EPFA345HH	MD735RS	4
XB9S Lightning		2003-2004			FA345HH	EPFA345HH	MD735RS	5
XB9SX Lightning City X		2005-2009			FA345HH	EPFA345HH	MD735RS	6
XB9SX Lightning		2008-2010			FA345HH	EPFA345HH	MD735RS	7

CAN-AM ATV

DS 70 2 x 4 Mini		2008-2021			346*			10
Renegade 70		2023			346*			11
DS 90 2 x 4		2006-2021			346*			12
DS 90 X 2 x 4		2008-2023			FA83X*		MD6335D*	13
Renegade 110		2023			346*			14
Rally 200		2005-2007			FA83X*		MD6220D*	15
DS 250		2006-2022			FA377X*		MD6283D*	16
DS 450 2 x 4/EFI		2008-2015				FA468R*		17
DS 450 X 2 x 4/EFI		2008-2009				FA468R*		18
DS 450 Xxc/Xxm		2009-2015				FA468R*		19
Outlander 400 4 x 4 STD	Left	2007-2014			FA307X	SXR307HH	FA307R	MD6222D*
	Right				FA317X	SXR317HH	FA317R	
Outlander 400 EFI STD international	Left	2015			FA307X	SXR307HH	FA307R	MD6222D*
	Right				FA317X	SXR317HH	FA317R	
Outlander 400 XT 4 x 4	Left	2007-2014			FA307X	SXR307HH	FA307R	MD6222D*
	Right				FA317X	SXR317HH	FA317R	
Outlander Max 400 STD 4 x 4	Left	2007-2014			FA307X	SXR307HH	FA307R	MD6222D*
	Right				FA317X	SXR317HH	FA317R	
Outlander Max 400 XT 4 x 4	Left	2006-2013			FA307X	SXR307HH	FA307R	MD6222D*
	Right				FA317X	SXR317HH	FA317R	
Outlander 450 All Models	Left	2018-2023			FA618X		FA618R	MD6370D*
	Right				FA617X		FA617R	
Outlander L 450 EFI	Left	2015			FA618X		FA618R	MD6370D*
	Right				FA617X		FA617R	
Outlander L 450 Max EFI	Left	2015			FA618X		FA618R	MD6370D*
	Right				FA617X		FA617R	
Outlander Max 450 All Models	Left	2018-2023			FA618X		FA618R	MD6370D*
	Right				FA617X		FA617R	
Outlander 500 4 X 4 STD/ DPS/ XT	Left	2013-2015			FA618X		FA618R	MD6370D*
	Right				FA617X		FA617R	
Outlander 500 L EFI	Left	2015			FA618X		FA618R	MD6370D*
	Right				FA617X		FA617R	
Outlander 500 STD 4 x 4	Left	2007-2012			FA307X	SXR307HH	FA307R	MD6222D*
	Right				FA317X	SXR317HH	FA317R	
Outlander 500 XT 4 x 4	Left	2007-2012			FA307X	SXR307HH	FA307R	MD6222D*
	Right				FA317X	SXR317HH	FA317R	
Outlander Max 500 4 X 4 STD/ DPS/ XT	Left	2013-2014			FA618X		FA618R	MD6370D*
	Right				FA617X		FA617R	
Outlander Max 500 L Efi	Left	2015			FA618X		FA618R	MD6370D*
	Right				FA617X		FA617R	
Outlander Max 500 STD 4 x 4	Left	2007-2012			FA307X	SXR307HH	FA307R	MD6222D*
	Right				FA317X	SXR317HH	FA317R	
Outlander Max 500 XT 4 x 4	Left	2007-2012			FA307X	SXR307HH	FA307R	MD6222D*
	Right				FA317X	SXR317HH	FA317R	
Renegade 500 EFI 4 x 4	Left	2007-2008			FA307X	SXR307HH	FA307R	MD6223D*
	Right				FA317X	SXR317HH	FA317R	

* symbol after part# = 2 pieces required i.e. 2 pad sets or 2 rotors (twin rotor models)

Part numbers, prefixes, suffixes, photos and illustrations shown in this catalog are trademarks and/or copyrights of EBC Brakes or the trademark owner A C Freeman Investments Ltd and use without express written permission of the owners is punishable by law.

This symbol indicates a rotor made of billet steel, and should be only used with EBC FA Organic or Vee pads.

REAR: AMERICAN PRODUCED MOTORCYCLES



Line #

BUELL

SUFFIX OR PREFIX	PAD MATERIALS AND DESCRIPTION	YEAR
	XB12 Ss Lightning Long	2006-2008
	XB12 STT Lightning	2008
	XB12 X Ulysses	2006-2010
	XB12 XT Ulysses	2008-2010
	XB9S Lightning	2003-2004
	XB9SX Lightning City X	2005-2009
	XB9SX Lightning	2008-2010

CAN-AM ATV

SUFFIX OR PREFIX	PAD MATERIALS AND DESCRIPTION	YEAR
	DS 70 2 x 4 Mini	2008-2021
	Renegade 70	2023
	DS 90 2 x 4	2006-2021
	DS 90 X 2 x 4	2008-2023
	Renegade 110	2023
	Rally 200	2005-2007
	DS 250	2006-2022
	DS 450 2 x 4/EFI	2008-2015
	DS 450 X 2 x 4/EFI	2008-2009
	DS 450 Xxc/Xxm	2009-2015
	Outlander 400 4 x 4 STD	2007-2014
	Outlander 400 EFI STD international	2015
	Outlander 400 XT 4 x 4	2007-2014
	Outlander Max 400 STD 4 x 4	2007-2014
	Outlander Max 400 XT 4 x 4	2006-2013
	Outlander 450 All Models	2018-2023
	Outlander L 450 EFI	2015
	Outlander L 450 Max EFI	2015
	Outlander Max 450 All Models	2018-2023
	Outlander 500 4 X 4 STD/ DPS/ XT	2013-2015
	Outlander 500 L EFI	2015
	Outlander 500 STD 4 x 4	2007-2012
	Outlander 500 XT 4 x 4	2007-2012
	Outlander Max 500 4 X 4 STD/ DPS/ XT	2013-2014
	Outlander Max 500 L Efi	2015
	Outlander Max 500 STD 4 x 4	2007-2012
	Outlander Max 500 XT 4 x 4	2007-2012
	Renegade 500 EFI 4 x 4	2007-2008

REAR				
PADS	PADS	PADS	PADS	REAR ROTOR OPTIONS
FA	V	HH	EPFA	DESIGN NO.
Organic Pads	Semi-Sintered V-Pads™	Double-H™ USA-Made Sintered Pads	Premium Low Noise Street Sintered Pads	See Buyers Guide for rotor style & finish options. Part nos for ordering & sizing.
FA140	FA140V	FA140HH		MD522
FA140	FA140V	FA140HH		MD522
FA140	FA140V	FA140HH		MD522
FA140	FA140V	FA140HH		MD522
FA140	FA140V	FA140HH		MD522
FA140	FA140V	FA140HH		MD522
307		307G		
307		307G		
307		307G		
FA83X		FA83R		MD6334D
307		307G		
FA307X	SXR307HH	FA307R		MD6285D
FA377X	FA377V	FA377R		MD6282D
		FA398R		
		FA398R		
		FA398R		MD6021D
FA307X	SXR307HH	FA307R		MD6223D
FA307X	SXR307HH	FA307R		MD6223D
FA307X	SXR307HH	FA307R		MD6223D
FA307X	SXR307HH	FA307R		MD6223D
FA618X		FA618R		MD6370D*
FA617X		FA617R		
FA617X		FA617R		MD6370D
FA617X		FA617R		MD6370D
FA618X		FA618R		MD6370D*
FA617X		FA617R		
FA617X		FA617R		MD6370D
FA307X	SXR307HH	FA307R		MD6223D
FA307X	SXR307HH	FA307R		MD6223D
FA618X		FA618R		MD6370D*
FA617X		FA617R		
FA617X		FA617R		MD6370D
FA307X	SXR307HH	FA307R		MD6223D
FA307X	SXR307HH	FA307R		MD6223D
FA307X	SXR307HH	FA307R		MD6223D
FA307X	SXR307HH	FA307R		MD6223D

* symbol after part# = 2 pieces required i.e. 2 pad sets or 2 rotors (twin rotor models)

Part numbers, prefixes, suffixes, photos and illustrations shown in this catalog are trademarks and/or copyrights of EBC Brakes or the trademark owner A C Freeman Investments Ltd and use without express written permission of the owners is punishable by law.

BRAKE APPLICATIONS

All names & numbers are for reference purposes only. © Registered trademarks of Harley—Davidson® Motor Corp or Buell.

NOTE: — Some models may have a second rotor fitted as an optional extra. Please double check with your customer exactly which side the front rotor is fitted and if twin rotor or single.

☉ This symbol indicates a rotor made of billet steel, and should be only used with EBC FA Organic or Vee pads.

FRONT: AMERICAN PRODUCED MOTORCYCLES

APPLICATIONS
BRAKE



SUFFIX OR PREFIX
PAD MATERIALS AND DESCRIPTION

CAN AM ATV

YEAR

					FRONT				FRONT ROTOR OPTIONS DESIGN NO.
					PADS	PADS	PADS	PADS	
					FA	V	HH	EPFA	
					Organic Pads	Semi-Sintered V-Pads™	Double-H™ USA-Made Sintered Pads	Premium Low Noise Street Sintered Pads	See Buyers Guide for rotor style & finish options. Part nos for ordering & sizing.
Renegade 500 EFI 4x4	Left	2009-2012	FA307X	SXR307HH	FA307R			MD6223D*	
	Right		FA317X	SXR317HH	FA317R				
Renegade 500 STD/ EFI	Left	2012-2015	FA618X		FA618R			MD6370D*	
	Right		FA617X		FA617R				
Renegade 570 All Models	Left	2018-2022	FA618X		FA618R			MD6370D*	
	Right		FA617X		FA617R				
Outlander Max 570 All Models	Left	2018-2023	FA618X		FA618R			MD6370D*	
	Right		FA617X		FA617R				
Outlander 570 All Models	Left	2018-2023	FA618X		FA618R			MD6370D*	
	Right		FA617X		FA617R				
Outlander 570 Max Pro	Left	2017	FA618X		FA618R			MD6370D*	
	Right		FA617X		FA617R				
Outlander 570 T & T MAX-DPS/XU & XU+	Left	2020-2022	FA618X		FA618R			MD6370D*	
	Right		FA617X		FA617R				
Outlander 570 T3 EFI inc 3FJD	Left	2018	FA618X		FA618R			MD6370D*	
	Right		FA617X		FA617R				
DS 650 X 3B7A/B	Left	2007	FA307X	SXR307HH	FA307R			MD6171D*	
	Right		FA317X	SXR317HH	FA317R				
Outlander 650 4 x 4 STD	Left	2007-2012	FA307X	SXR307HH	FA307R			MD6222D*	
	Right		FA317X	SXR317HH	FA317R				
Outlander 650 EFI 6x6	Left	2016-2022	FA618X		FA618R			MD6370D*	
	Right		FA617X		FA617R				
Outlander 650 All Models	Left	2013-2023	FA618X		FA618R			MD6370D*	
	Right		FA617X		FA617R				
Outlander 650 XT 4 x 4	Left	2007-2012	FA307X	SXR307HH	FA307R			MD6222D*	
	Right		FA317X	SXR317HH	FA317R				
Outlander Max 650 All Models	Left	2013-2023	FA618X		FA618R			MD6370D*	
	Right		FA617X		FA617R				
Outlander Max 650 STD 4 x 4	Left	2007-2012	FA307X	SXR307HH	FA307R			MD6222D*	
	Right		FA317X	SXR317HH	FA317R				
Outlander Max 650 X - TP	Left	2012	FA307X	SXR307HH	FA307R			MD6222D*	
	Right		FA317X	SXR317HH	FA317R				
Outlander Max 650 XT 4 x 4	Left	2007-2012	FA307X	SXR307HH	FA307R			MD6222D*	
	Right		FA317X	SXR317HH	FA317R				
Renegade 650 All Models	Left	2018-2023	FA618X		FA618R			MD6370D*	
	Right		FA617X		FA617R				
Outlander Max 800 Ltd 4 x 4	Left	2007-2012	FA307X	SXR307HH	FA307R			MD6222D*	
	Right		FA317X	SXR317HH	FA317R				
Outlander Max 800 R EFI	Left	2009-2012	FA307X	SXR307HH	FA307R			MD6222D*	
	Right		FA317X	SXR317HH	FA317R				
Outlander Max 800 R STD/ DPS/ XT/ XT-P	Left	2014-2015	FA618X		FA618R			MD6370D*	
	Right		FA617X		FA617R				
Outlander Max 800 R XT		2009-2012	FA307X		FA307R			MD6222D	
Outlander Max 800 R X-TP	Left	2012	FA307X	SXR307HH	FA307R			MD6222D*	
	Right		FA317X	SXR317HH	FA317R				
Outlander Max 800 STD 4 x 4	Left	2007-2012	FA307X	SXR307HH	FA307R			MD6222D*	
	Right		FA317X	SXR317HH	FA317R				
Outlander Max 800 XT 4 x 4	Left	2007-2008	FA307X	SXR307HH	FA307R			MD6222D*	
	Right		FA317X	SXR317HH	FA317R				
Outlander 800 R EFI	Left	2009	FA307X	SXR307HH	FA307R			MD6222D*	
	Right		FA317X	SXR317HH	FA317R				
Outlander 800 R Mmr	Left	2015	FA618X		FA618R			MD6370D*	
	Right		FA617X		FA617R				
Outlander 800 R STD	Left	2012-2015	FA618X		FA618R			MD6370D*	
	Right		FA617X		FA617R				

Line #

⚡ This symbol indicates a rotor made of billet steel, and should be only used with EBC FA Organic or Vee pads.

* symbol after part# = 2 pieces required i.e. 2 pad sets or 2 rotors (twin rotor models)

Part numbers, prefixes, suffixes, photos and illustrations shown in this catalog are trademarks and/or copyrights of EBC Brakes or the trademark owner A C Freeman Investments Ltd and use without express written permission of the owners is punishable by law.

REAR: AMERICAN PRODUCED MOTORCYCLES



Line #

CAN AM ATV

SUFFIX OR PREFIX
PAD MATERIALS AND DESCRIPTION

YEAR

REAR								
PADS	PADS	PADS	PADS	REAR ROTOR OPTIONS				
FA	V	HH	EPFA	DESIGN NO.				
Organic Pads	Semi-Sintered V-Pads™	Double-H™ USA-Made Sintered Pads	Premium Low Noise Street Sintered Pads	See Buyers Guide for rotor style & finish options. Part nos for ordering & sizing.				
1	Renegade 500 EFI 4x4	Left	2009-2012	FA307X	SXR307HH	FA307R		MD6223D
2		Right						
3	Renegade 500 STD/ EFI	Left	2012-2015	FA618X		FA618R		MD6370D*
4		Right		FA617X		FA617R		
5	Renegade 570 All Models	Left	2018-2022		SXR617HH			
6		Right		FA617X		FA617R		MD6370D
7	Outlander Max 570 All Models	Left	2018-2023					
8		Right		FA617X	SXR617HH	FA617R		MD6370D
9	Outlander 570 All Models	Left	2018-2023					
10		Right		FA617X	SXR617HH	FA617R		MD6370D
11	Outlander 570 Max Pro	Left	2017	FA618X		FA618R		MD6370D*
12		Right		FA617X		FA617R		
13	Outlander 570 T & T MAX-DPS/XU & XU+	Left	2020-2022	FA618X		FA618R		MD6370D*
14		Right		FA617X		FA617R		
15	Outlander 570 T3 EFI inc 3FJD	Left	2018	FA618X		FA618R		MD6370D*
16		Right		FA617X		FA617R		
17	DS 650 X 3B7A/B	Left	2007	FA307X	SXR307HH	FA618R		MD6172D
18		Right						
19	Outlander 650 4 x 4 STD	Left	2007-2012	FA307X	SXR307HH	FA307R		MD6223D
20		Right						
21	Outlander 650 EFI 6x6	Left	2016-2022	FA618X		FA618R		MD6370D*
22		Right		FA617X		FA617R		
23	Outlander 650 All Models	Left	2013-2023					
24		Right		FA617X		FA617R		MD6370D
25	Outlander 650 XT 4 x 4	Left	2007-2012	FA307X	SXR307HH	FA307R		MD6223D
26		Right						
27	Outlander Max 650 All Models	Left	2013-2023					
28		Right		FA617X	SXR617HH	FA617R		MD6370D
29	Outlander Max 650 STD 4 x 4	Left	2007-2012	FA307X	SXR307HH	FA307R		MD6223D
30		Right						
31	Outlander Max 650 X - TP	Left	2012	FA307X	SXR307HH	FA307R		MD6223D
32		Right						
33	Outlander Max 650 XT 4 x 4	Left	2007-2012	FA307X	SXR307HH	FA307R		MD6223D
34		Right						
35	Renegade 650 All Models	Left	2018-2023		SXR617HH			
36		Right		FA617X		FA617R		MD6370D
37	Outlander Max 800 Ltd 4 x 4	Left	2007-2012	FA307X	SXR307HH	FA307R		MD6223D
38		Right						
39	Outlander Max 800 R EFI	Left	2009-2012	FA307X	SXR307HH	FA307R		MD6223D
40		Right						
41	Outlander Max 800 R STD/ DPS/ XT/ XT-P	Left	2014-2015					
42		Right		FA617X		FA617R		MD6370D
43	Outlander Max 800 R XT		2009-2012	FA307X	SXR307HH	FA307R		MD6223D
44	Outlander Max 800 R X-TP	Left	2012	FA307X	SXR307HH	FA307R		MD6223D
45		Right						
46	Outlander Max 800 STD 4 x 4	Left	2007-2012	FA307X	SXR307HH	FA307R		MD6223D
47		Right						
48	Outlander Max 800 XT 4 x 4	Left	2007-2008	FA307X	SXR307HH	FA307R		MD6223D
49		Right						
50	Outlander 800 R EFI	Left	2009	FA307X	SXR307HH	FA307R		MD6223D
51		Right						
52	Outlander 800 R Mmr	Left	2015					
53		Right		FA617X		FA617R		MD6370D
54	Outlander 800 R STD	Left	2012-2015					
55		Right		FA617X		FA617R		MD6370D

All names & numbers are for reference purposes only. © Registered trademarks of Harley—Davidson® Motor Corp or Buell.

NOTE: — Some models may have a second rotor fitted as an optional extra. Please double check with your customer exactly which side the front rotor is fitted and if twin rotor or single.

☼ This symbol indicates a rotor made of billet steel, and should be only used with EBC FA Organic or Vee pads.

BRAKE APPLICATIONS

* symbol after part# = 2 pieces required i.e. 2 pad sets or 2 rotors (twin rotor models)
Part numbers, prefixes, suffixes, photos and illustrations shown in this catalog are trademarks and/or copyrights of EBC Brakes or the trademark owner A C Freeman Investments Ltd and use without express written permission of the owners is punishable by law.

FRONT: AMERICAN PRODUCED MOTORCYCLES

APPLICATIONS
BRAKE



SUFFIX OR PREFIX
PAD MATERIALS AND DESCRIPTION

CAN AM ATV

YEAR

					FRONT				
					PADS	PADS	PADS	PADS	FRONT ROTOR OPTIONS
					FA	V	HH	EPFA	DESIGN NO.
					Organic Pads	Semi-Sintered V-Pads™	Double-HTM USA-Made Sintered Pads	Premium Low Noise Street Sintered Pads	See Buyers Guide for rotor style & finish options. Part nos for ordering & sizing.
Outlander 800 R STD/ DPS/ XT/ XT-P	Left	2014-2015			FA618X		FA618R		MD6370D*
	Right				FA617X		FA617R		
Outlander 800 R Xmr	Left	2011-2012			FA307X	SXR307HH	FA307R		MD6222D*
	Right				FA317X	SXR317HH	FA317R		
Outlander 800 R XT	Left	2009-2010			FA307X	SXR307HH	FA307R		MD6222D*
	Right				FA317X	SXR317HH	FA317R		
Outlander 800 R XT/ XXC	Left	2012-2015			FA618X		FA618R		MD6370D*
	Right				FA617X		FA617R		
Outlander 800 R XXC	Left	2011			FA307X	SXR307HH	FA307R		MD6222D*
	Right				FA317X	SXR317HH	FA317R		
Outlander 800 STD 4 x 4	Left	2007-2008			FA307X	SXR307HH	FA307R		MD6222D*
	Right				FA317X	SXR317HH	FA317R		
Outlander 800 XT 4 x 4	Left	2007-2008			FA307X	SXR307HH	FA307R		MD6222D*
	Right				FA317X	SXR317HH	FA317R		
Renegade 800 4 x 4/EFI	Left	2007-2008			FA307X	SXR307HH	FA307R		
	Right				FA317X	SXR317HH	FA317R		
Renegade 800 EFI STD & XXC	Left	2013-2015			FA618X		FA618R		MD6370D*
	Right				FA617X		FA617R		
Renegade 800 R EFI	Left	2009-2011			FA307X	SXR307HH	FA307R		
	Right				FA317X	SXR317HH	FA317R		
Renegade 800 R X	Left	2009-2010			FA307X	SXR307HH	FA307R		MD6223D*
	Right				FA317X	SXR317HH	FA317R		
Renegade 800 R XXC	Left	2011			FA307X	SXR307HH	FA307R		MD6223D*
	Right				FA317X	SXR317HH	FA317R		
Renegade 800 R XXC	Left	2012-2014			FA618X		FA618R		MD6370D*
	Right				FA617X		FA617R		
Renegade 800 X 4 x 4/EFI	Left	2008			FA307X	SXR307HH	FA307R		
	Right				FA317X	SXR317HH	FA317R		
Outlander 850 EFI G2	Left	2018-2019			FA618X		FA618R		MD6370D*
	Right				FA617X		FA617R		
Outlander 850 EFI Max G2	Left	2018-2019			FA618X		FA618R		MD6370D*
	Right				FA617X		FA617R		
Outlander 850 EFI Max XT XT-P	Left	2020-2021			FA618X		FA618R		MD6370D*
	Right				FA617X		FA617R		
Outlander 850 EFI STD/ DPS/ XT & XT-P	Left	2018-2021			FA618X		FA618R		MD6370D*
	Right				FA617X		FA617R		
Outlander 850 XMR	Left	2020-2021			FA618X		FA618R		MD6370D*
	Right				FA617X		FA617R		
Renegade 850 All Models	Left	2018-2023			FA618X		FA618R		MD6370D*
	Right				FA617X		FA617R		
Outlander 1000 4 x 4	Left	2013-2015			FA618X		FA618R		MD6370D*
	Right				FA617X		FA617R		
Outlander 1000 6x6 EFI T3	Left	2016-2021			FA618X		FA618R		MD6370D*
	Right				FA617X		FA617R		
Outlander 1000 6x6 XT	Left	2014-2015			FA618X		FA618R		MD6370D*
	Right				FA617X		FA617R		
Outlander 1000 DPS/ XT/ XT-P	Left	2013			FA618X		FA618R		MD6370D*
	Right				FA617X		FA617R		
Outlander 1000 All Models	Left	2018-2023			FA618X		FA618R		MD6370D*
	Right				FA617X		FA617R		
Outlander Max 1000 All Models	Left	2018-2023			FA618X		FA618R		MD6370D*
	Right				FA617X		FA617R		
Outlander 1000 Max DPS/ XT/ XT-P	Left	2013-2014			FA618X		FA618R		MD6370D*
	Right				FA617X		FA617R		

* This symbol indicates a rotor made of billet steel, and should be only used with EBC FA Organic or Vee pads.

Line #

1
2
3
4
5
6
7
8
9
10
11
12
13
14
15
16
17
18
19
20
21
22
23
24
25
26
27
28
29
30
31
32
33
34
35
36
37
38
39
40
41
42
43
44
45
46
47
48
49
50
51
52
53
54
55

* symbol after part# = 2 pieces required i.e. 2 pad sets or 2 rotors (twin rotor models)

Part numbers, prefixes, suffixes, photos and illustrations shown in this catalog are trademarks and/or copyrights of EBC Brakes or the trademark owner A C Freeman Investments Ltd and use without express written permission of the owners is punishable by law.

REAR: AMERICAN PRODUCED MOTORCYCLES



Line #

CAN AM ATV

SUFFIX OR PREFIX
PAD MATERIALS AND DESCRIPTION

YEAR

REAR				
PADS	PADS	PADS	PADS	REAR ROTOR OPTIONS
FA	V	HH	EPFA	DESIGN NO.
Organic Pads	Semi-Sintered V-Pads™	Double-H™ USA-Made Sintered Pads	Premium Low Noise Street Sintered Pads	See Buyers Guide for rotor style & finish options. Part nos for ordering & sizing.
	Left	2014-2015		
	Right		FA617X	
	Left	2011-2012	FA307X	SXR307HH
	Right			
	Left	2009-2010	FA307X	SXR307HH
	Right			
	Left	2012-2015		
	Right		FA617X	
	Left	2011	FA307X	SXR307HH
	Right			
	Left	2007-2008	FA307X	SXR307HH
	Right			
	Left	2007-2008	FA307X	SXR307HH
	Right			
	Left	2007-2008	FA307X	SXR307HH
	Right			
	Left	2013-2015	FA618X	
	Right		FA617X	
	Left	2009-2011	FA307X	SXR307HH
	Right			
	Left	2009-2010	FA307X	SXR307HH
	Right			
	Left	2011	FA307X	SXR307HH
	Right			
	Left	2012-2014	FA618X	
	Right		FA617X	
	Left	2008	FA307X	SXR307HH
	Right			
	Left	2018-2019	FA618X	
	Right		FA617X	
	Left	2018-2019	FA618X	
	Right		FA617X	
	Left	2020-2021	FA618X	
	Right		FA617X	
	Left	2018-2021	FA618X	
	Right		FA617X	
	Left	2020-2021	FA618X	
	Right		FA617X	
	Left	2018-2023		
	Right		FA617X	SXR617HH
	Left	2013-2015		
	Right		FA617X	
	Left	2016-2021	FA618X	
	Right		FA617X	
	Left	2014-2015	FA618X	
	Right		FA617X	
	Left	2013		
	Right		FA617X	
	Left	2018-2023	FA618X	
	Right		FA617X	
	Left	2018-2023	FA618X	
	Right		FA617X	
	Left	2013-2014		
	Right		FA617X	

All names & numbers are for reference purposes only. © Registered trademarks of Harley—Davidson® Motor Corp or Buell.

NOTE: — Some models may have a second rotor fitted as an optional extra. Please double check with your customer exactly which side the front rotor is fitted and if twin rotor or single.

☼ This symbol indicates a rotor made of billet steel, and should be only used with EBC FA Organic or Vee pads.

BRAKE APPLICATIONS

* symbol after part# = 2 pieces required i.e. 2 pad sets or 2 rotors (twin rotor models)

Part numbers, prefixes, suffixes, photos and illustrations shown in this catalog are trademarks and/or copyrights of EBC Brakes or the trademark owner A C Freeman Investments Ltd and use without express written permission of the owners is punishable by law.

FRONT: AMERICAN PRODUCED MOTORCYCLES

BRAKE APPLICATIONS



SUFFIX OR PREFIX
PAD MATERIALS AND DESCRIPTION

YEAR

FRONT

PADS

PADS

PADS

PADS

FRONT ROTOR
OPTIONS

FA

V

HH

EPFA

DESIGN NO.

Organic
Pads

Semi-Sintered
V-Pads™

Double-H™
USA-Made
Sintered Pads

Premium Low
Noise Street
Sintered Pads

See Buyers Guide for
rotor style & finish
options. Part nos for
ordering & sizing.

CAN AM ATV

Outlander 1000 Max EFI T3 L and R	Left	2016-2019	FA618X		FA618R		MD6370D*
	Right		FA617X		FA617R		
Outlander 1000 STD	Left	2012	FA618X		FA618R		MD6370D*
	Right		FA617X		FA617R		
Outlander 1000 T	Left	2020-2021	FA618X		FA618R		MD6370D*
	Right		FA617X		FA617R		
Outlander 1000 XMR	Left	2013-2018	FA618X		FA618R		MD6370D*
	Right		FA617X		FA617R		
Outlander 1000 XMR	Left	2020-2021	FA618X		FA618R		MD6370D*
	Right		FA617X		FA617R		
Outlander 1000 XT	Left	2012	FA618X		FA618R		MD6370D*
	Right		FA617X		FA617R		
Renegade 1000 All Models	Left	2017-2023	FA618X		FA618R		MD6370D*
	Right		FA617X		FA617R		
Renegade 1000 STD EFI	Left	2012-2014	FA618X		FA618R		MD6370D*
	Right		FA617X		FA617R		
Renegade 1000 XXC	Left	2012-2014	FA618X		FA618R		MD6370D*
	Right		FA617X		FA617R		

CAN-AM UTV

Commander Electric 9KW/ STD/ XT/ LSV		2013-2015			FA468R*		MD6222D*
Commander 700 EFI - DPS - XT	Left	2022-2023	FA682X	SXR682HH	FA682R		MD6396D*
	Right		FA683X	SXR683HH	FA683R		
Maverick Trail 700 All Models	Left	2022-2023	FA682X	SXR682HH	FA682R		MD6396D*
	Right		FA683X	SXR683HH	FA683R		
Commander 800 R	Left	2011-2015	FA165X	SXR165HH	FA165R		MD6366D*
	Right		FA135X	SXR135HH	FA135R		
Commander 800 R XT	Left	2011-2014	FA165X	SXR165HH	FA165R		MD6366D*
	Right		FA135X	SXR135HH	FA135R		
Commander 800 STD 800R/ X 1000		2013-2014			FA398R*		MD6222D*
Commander 800 STD/ DPS/ XT/ 800R EFI	Left	2012-2015	FA165X	SXR165HH	FA165R		MD6366D*
	Right		FA135X	SXR135HH	FA135R		
Commander 800 XT/DPS	Left	2011-2015	FA165X	SXR165HH	FA165R		MD6366D*
	Right		FA135X	SXR135HH	FA135R		
Commander 800	Left	2011	FA165X	SXR165HH	FA165R		MD6366D*
	Right		FA135X	SXR135HH	FA135R		
Maverick Trail 800 Trail EFI	Left	2018-2021	FA682X	SXR682HH	FA682R		MD6396D*
	Right		FA683X	SXR683HH	FA683R		
Commander 1000 DPS	Left	2013-2015	FA165X	SXR165HH	FA165R		MD6366D*
	Right		FA135X	SXR135HH	FA135R		
Commander 1000 EFI	Left	2018-2019	FA642X	SXR642HH	FA642R		MD6411D*
	Right		FA645X	SXR645HH	FA645R		
Commander 1000 LTD	Left	2012-2014	FA165X	SXR165HH	FA165R		MD6366D*
	Right		FA135X	SXR135HH	FA135R		
Commander 1000 STD	Left	2011-2015	FA165X	SXR165HH	FA165R		MD6366D*
	Right		FA135X	SXR135HH	FA135R		
Commander 1000 STD/ DPS XT/ XT-P 1000		2013-2015			FA398R*		MD6222D*
Commander 1000 STD/ DPS/ XT/ X/ XT-P/ 1000 Efi	Left	2012-2017	FA165X	SXR165HH	FA165R		MD6366D*
	Right		FA135X	SXR135HH	FA135R		
Commander 1000 X	Left	2011-2013	FA165X	SXR165HH	FA165R		MD6366D*
	Right		FA135X	SXR135HH	FA135R		
Commander 1000 XT	Left	2011-2015	FA165X	SXR165HH	FA165R		MD6366D*
	Right		FA135X	SXR135HH	FA135R		
Commander 1000 XT-P	Left	2014-2015	FA165X	SXR165HH	FA165R		MD6366D*
	Right		FA135X	SXR135HH	FA135R		

This symbol indicates a rotor made of billet steel, and should be only used with EBC FA Organic or Vee pads.

Line #

* symbol after part# = 2 pieces required i.e. 2 pad sets or 2 rotors (twin rotor models)

Part numbers, prefixes, suffixes, photos and illustrations shown in this catalog are trademarks and/or copyrights of EBC Brakes or the trademark owner A C Freeman Investments Ltd and use without express written permission of the owners is punishable by law.

REAR: AMERICAN PRODUCED MOTORCYCLES



Line #

CAN AM ATV

SUFFIX OR PREFIX PAD MATERIALS AND DESCRIPTION		YEAR	FA	V	HH	EPFA	REAR ROTOR OPTIONS
1	Outlander 1000 Max EFI T3 L and R	Left	2016-2019	FA618X		FA618R	MD6370D*
2		Right		FA617X		FA617R	
3	Outlander 1000 STD	Left	2012				
4		Right		FA617X		FA617R	MD6370D
5	Outlander 1000 T	Left	2020-2021	FA618X		FA618R	MD6370D*
6		Right		FA617X		FA617R	
7	Outlander 1000 XMR	Left	2013-2018				
8		Right		FA617X		FA617R	MD6370D
9	Outlander 1000 XMR	Left	2020-2021				
10		Right		FA617X		FA617R	MD6370D
11	Outlander 1000 XT	Left	2012				
12		Right		FA617X		FA617R	MD6370D
13	Renegade 1000 All Models	Left	2017-2023	FA618X		FA618R	MD6370D*
14		Right		FA617X		FA617R	
15	Renegade 1000 STD EFI	Left	2012-2014	FA618X		FA618R	MD6370D*
16		Right		FA617X		FA617R	
17	Renegade 1000 XXC	Left	2012-2014	FA618X		FA618R	MD6370D*
18		Right		FA617X		FA617R	

CAN-AM UTV

21	Commander Electric 9KW/ STD/ XT/ LSV		2013-2015				
22	Commander 700 EFI - DPS - XT	Left	2022-2023	FA684X	SXR684HH	FA684R	MD6396D*
23		Right		FA685X	SXR685HH	FA685R	
24	Maverick Trail 700 All Models	Left	2022-2023	FA682X	SXR682HH	FA682R	MD6412D*
25		Right		FA683X	SXR683HH	FA683R	
26	Commander 800 R	Left	2011-2015	FA135X	SXR135HH	FA135R	MD6366D
27		Right					
28	Commander 800 R XT	Left	2011-2014	FA135X	SXR135HH	FA135R	MD6366D
29		Right					
30	Commander 800 STD 800R/ X 1000		2013-2014				
31	Commander 800 STD/ DPS/ XT/ 800R EFI	Left	2012-2015				
32		Right		FA165X	SXR165HH	FA165R	MD6366D
33	Commander 800 XT/DPS	Left	2011-2015	FA135X	SXR135HH	FA135R	MD6366D
34		Right					
35	Commander 800	Left	2011				
36		Right		FA165X	SXR165HH	FA165R	MD6366D
37	Maverick Trail 800 Trail EFI	Left	2018-2021	FA682X	SXR682HH	FA682R	MD6412D*
38		Right		FA683X	SXR683HH	FA683R	
39	Commander 1000 DPS	Left	2013-2015	FA135X		FA135R	MD6366D
40		Right					
41	Commander 1000 EFI	Left	2018-2019	FA135X		FA135R	MD6366D
42		Right					
43	Commander 1000 LTD	Left	2012-2014				
44		Right		FA165X	SXR165HH	FA165R	MD6366D
45	Commander 1000 STD	Left	2011-2015	FA135X		FA135R	MD6366D
46		Right					
47	Commander 1000 STD/ DPS XT/ XT-P 1000		2013-2015				
48	Commander 1000 STD/ DPS/ XT/ X/ XT-P/ 1000 Efi	Left	2012-2017				
49		Right		FA165X	SXR165HH	FA165R	MD6366D
50	Commander 1000 X	Left	2011-2013	FA135X		FA135R	MD6366D
51		Right					
52	Commander 1000 XT	Left	2011-2015	FA135X		FA135R	MD6366D
53		Right					
54	Commander 1000 XT-P	Left	2014-2015	FA135X		FA135R	MD6366D
55		Right					

* symbol after part# = 2 pieces required i.e. 2 pad sets or 2 rotors (twin rotor models)

Part numbers, prefixes, suffixes, photos and illustrations shown in this catalog are trademarks and/or copyrights of EBC Brakes or the trademark owner A C Freeman Investments Ltd and use without express written permission of the owners is punishable by law.

All names & numbers are for reference purposes only. © Registered trademarks of Harley—Davidson® Motor Corp or Buell.

NOTE: — Some models may have a second rotor fitted as an optional extra. Please double check with your customer exactly which side the front rotor is fitted and if twin rotor or single.

☼ This symbol indicates a rotor made of billet steel, and should be only used with EBC FA Organic or Vee pads.

BRAKE
APPLICATIONS

FRONT: AMERICAN PRODUCED MOTORCYCLES

APPLICATIONS
BRAKE



SUFFIX OR PREFIX
PAD MATERIALS AND DESCRIPTION

CAN-AM UTV

YEAR

				FRONT				
				PADS	PADS	PADS	PADS	FRONT ROTOR OPTIONS
				FA	V	HH	EPFA	DESIGN NO.
				Organic Pads	Semi-Sintered V-Pads™	Double-H™ USA-Made Sintered Pads	Premium Low Noise Street Sintered Pads	See Buyers Guide for rotor style & finish options. Part nos for ordering & sizing.
Commander 1000	Left	2011		FA165X	SXR165HH	FA165R		MD6366D*
	Right			FA135X	SXR135HH	FA135R		
Commander 1000R All Models	Left	2021-2023		FA682X	SXR682HH	FA682R		MD6396D*
	Right			FA683X	SXR683HH	FA683R		
Commander Max 1000 DPS/XT	Left	2014		FA165X	SXR165HH	FA165R		MD6366D*
	Right			FA135X	SXR135HH	FA135R		
Commander Max 1000 DPS/XT	Left	2015		FA642X	SXR642HH	FA642R		MD6411D*
	Right			FA645X	SXR645HH	FA645R		
Commander Max 1000 LTD	Left	2015-2017		FA642X	SXR642HH	FA642R		MD6411D*
	Right			FA645X	SXR645HH	FA645R		
Commander MAX 1000R All Models	Left	2021-2023		FA682X	SXR682HH	FA682R		MD6396D*
	Right			FA683X	SXR683HH	FA683R		
Defender HD5 All Models	Left	2017-2019		FA682X	SXR682HH	FA682R		MD6396D*
	Right			FA683X	SXR683HH	FA683R		
Defender HD7 All Models	Left	2022-2023		FA682X	SXR682HH	FA682R		MD6396D*
	Right			FA683X	SXR683HH	FA683R		
Defender Max HD7 All Models	Left	2022-2023		FA682X	SXR682HH	FA682R		MD6396D*
	Right			FA683X	SXR683HH	FA683R		
Defender HD8 XT	Left	2016		FA682X	SXR682HH	FA682R		MD6396D*
	Right			FA683X	SXR683HH	FA683R		
Defender HD8 XT Cab	Left	2016		FA682X	SXR682HH	FA682R		MD6396D*
	Right			FA683X	SXR683HH	FA683R		
Defender Max HD8 All Models	Left	2018-2021		FA682X	SXR682HH	FA682R		MD6396D*
	Right			FA683X	SXR683HH	FA683R		
Defender HD8 All Models	Left	2016		FA682X	SXR682HH	FA682R		MD6396D*
	Right			FA683X	SXR683HH	FA683R		
Defender HD8 All Models	Left	2017-2021		FA682X	SXR682HH	FA682R		MD6396D*
	Right			FA683X	SXR683HH	FA683R		
Defender HD10 DPS	Left	2016		FA682X	SXR682HH	FA682R		MD6396D*
	Right			FA683X	SXR683HH	FA683R		
Defender HD10 All Models	Left	2017-2023		FA682X	SXR682HH	FA682R		MD6396D*
	Right			FA683X	SXR683HH	FA683R		
Defender Max HD10 All Models	Left	2018-2023		FA682X	SXR682HH	FA682R		MD6396D*
	Right			FA683X	SXR683HH	FA683R		
Defender PRO HD10	Left	2020-2023		FA682X	SXR682HH	FA682R		MD6396D*
	Right			FA683X	SXR683HH	FA683R		
Defender HD9 All Models	Left	2022-2023		FA682X	SXR682HH	FA682R		MD6396D*
	Right			FA683X	SXR683HH	FA683R		
Defender Max HD9 All Models	Left	2022-2023		FA682X	SXR682HH	FA682R		MD6396D*
	Right			FA683X	SXR683HH	FA683R		
Defender T T	Left	2017		FA682X	SXR682HH	FA682R		MD6396D*
	Right			FA683X	SXR683HH	FA683R		
Maverick Turbo DS	Left	2019-2023		FA682X	SXR682HH	FA682R		MD6411D*
	Right			FA683X	SXR683HH	FA683R		
Maverick Turbo R All Models	Left	2019-2021		FA682X	SXR682HH	FA682R		MD6411D*
	Right			FA683X	SXR683HH	FA683R		
Maverick Turbo RR All Models	Left	2019-2023		FA682X	SXR682HH	FA682R		MD6411D*
	Right			FA683X	SXR683HH	FA683R		
Maverick X3 Max Turbo All Models	Left	2017-2018		FA682X	SXR682HH	FA682R		MD6411D*
	Right			FA683X	SXR683HH	FA683R		
Maverick X3 Turbo All Models	Left	2017-2021		FA682X	SXR682HH	FA682R		MD6411D*
	Right			FA683X	SXR683HH	FA683R		
Maverick Max Turbo All Models	Left	2019-2023		FA682X	SXR682HH	FA682R		MD6411D*
	Right			FA683X	SXR683HH	FA683R		
Maverick X3 Turbo All Models		2017-2021			SXR756HH*			

* This symbol indicates a rotor made of billet steel, and should be only used with EBC FA Organic or Vee pads.

Line #
1
2
3
4
5
6
7
8
9
10
11
12
13
14
15
16
17
18
19
20
21
22
23
24
25
26
27
28
29
30
31
32
33
34
35
36
37
38
39
40
41
42
43
44
45
46
47
48
49
50
51
52
53
54
55

* symbol after part# = 2 pieces required i.e. 2 pad sets or 2 rotors (twin rotor models)

Part numbers, prefixes, suffixes, photos and illustrations shown in this catalog are trademarks and/or copyrights of EBC Brakes or the trademark owner A C Freeman Investments Ltd and use without express written permission of the owners is punishable by law.

REAR: AMERICAN PRODUCED MOTORCYCLES



Line #

CAN-AM UTV

SUFFIX OR PREFIX
PAD MATERIALS AND DESCRIPTION

YEAR

REAR

PADS	PADS	PADS	PADS	REAR ROTOR		
				OPTIONS		
				DESIGN NO.		
FA	V	HH	EPFA	See Buyers Guide for rotor style & finish options. Part nos for ordering & sizing.		
Organic Pads	Semi-Sintered V-Pads™	Double-H™ USA-Made Sintered Pads	Premium Low Noise Street Sintered Pads			
	Left	2011				
	Right		FA165X	SXR165HH	FA165R	MD6366D
	Left	2021-2023	FA684X	SXR684HH	FA684R	MD6396D*
	Right		FA685X	SXR685HH	FA685R	
	Left	2014	FA307X	SXR307HH	FA307R	MD6370D*
	Right		FA317X	SXR317HH	FA317R	
	Left	2015	FA307X	SXR307HH	FA307R	MD6370D*
	Right		FA317X	SXR317HH	FA317R	
	Left	2015-2017	FA307X	SXR307HH	FA307R	MD6370D*
	Right		FA317X	SXR317HH	FA317R	
	Left	2021-2023	FA684X	SXR684HH	FA684R	MD6396D*
	Right		FA685X	SXR685HH	FA685R	
	Left	2017-2019				
	Right		FA683X		FA683R	MD6396D
	Left	2022-2023				
	Right		FA683X		FA683R	MD6396D
	Left	2022-2023	FA684X	SXR684HH	FA684R	MD6396D*
	Right		FA685X	SXR685HH	FA685R	
	Left	2016	FA684X	SXR684HH	FA684R	MD6396D*
	Right		FA685X	SXR685HH	FA685R	
	Left	2016	FA684X	SXR684HH	FA684R	MD6396D*
	Right		FA685X	SXR685HH	FA685R	
	Left	2018-2021	FA684X	SXR684HH	FA684R	MD6396D*
	Right		FA685X	SXR685HH	FA685R	
	Left	2016	FA684X	SXR684HH	FA684R	MD6396D*
	Right		FA685X	SXR685HH	FA685R	
	Left	2017-2021	FA684X	SXR684HH	FA684R	MD6396D*
	Right		FA685X	SXR685HH	FA685R	
	Left	2016	FA684X	SXR684HH	FA684R	MD6396D*
	Right		FA685X	SXR685HH	FA685R	
	Left	2017-2023	FA684X	SXR684HH	FA684R	MD6396D*
	Right		FA685X	SXR685HH	FA685R	
	Left	2018-2023	FA684X	SXR684HH	FA684R	MD6396D*
	Right		FA685X	SXR685HH	FA685R	
	Left	2020-2023	FA682X	SXR682HH	FA682R	MD6396D*
	Right		FA683X	SXR683HH	FA683R	
	Left	2022-2023	FA684X	SXR684HH	FA684R	MD6396D*
	Right		FA685X	SXR685HH	FA685R	
	Left	2022-2023	FA684X	SXR684HH	FA684R	MD6396D*
	Right		FA685X	SXR685HH	FA685R	
	Left	2017	FA682X	SXR682HH	FA682R	MD6396D*
	Right		FA683X	SXR683HH	FA683R	
	Left	2019-2023	FA682X	SXR682HH	FA682R	MD6412D*
	Right		FA683X	SXR683HH	FA683R	
	Left	2019-2021	FA682X	SXR682HH	FA682R	MD6412D*
	Right		FA683X	SXR683HH	FA683R	
	Left	2019-2023	FA682X	SXR682HH	FA682R	MD6412D*
	Right		FA683X	SXR683HH	FA683R	
	Left	2017-2018	FA682X	SXR682HH	FA682R	MD6412D*
	Right		FA683X	SXR683HH	FA683R	
	Left	2017-2021	FA682X	SXR682HH	FA682R	MD6412D*
	Right		FA683X	SXR683HH	FA683R	
	Left	2019-2023	FA682X	SXR682HH	FA682R	MD6412D*
	Right		FA683X	SXR683HH	FA683R	
	Left	2017-2021				
	Right		SXR756HH*			

* symbol after part# = 2 pieces required i.e. 2 pad sets or 2 rotors (twin rotor models)

Part numbers, prefixes, suffixes, photos and illustrations shown in this catalog are trademarks and/or copyrights of EBC Brakes or the trademark owner A C Freeman Investments Ltd and use without express written permission of the owners is punishable by law.

All names & numbers are for reference purposes only. © Registered trademarks of Harley—Davidson® Motor Corp or Buell.

NOTE: — Some models may have a second rotor fitted as an optional extra. Please double check with your customer exactly which side the front rotor is fitted and if twin rotor or single.

☼ This symbol indicates a rotor made of billet steel, and should be only used with EBC FA Organic or Vee pads.

BRAKE APPLICATIONS

FRONT: AMERICAN PRODUCED MOTORCYCLES

APPLICATIONS
BRAKE



SUFFIX OR PREFIX
PAD MATERIALS AND DESCRIPTION

CAN-AM UTV

YEAR

					FRONT				FRONT ROTOR OPTIONS	DESIGN NO.
					PADS	PADS	PADS	PADS		
					FA	V	HH	EPFA		
					Organic Pads	Semi-Sintered V-Pads™	Double-HTM USA-Made Sintered Pads	Premium Low Noise Street Sintered Pads	See Buyers Guide for rotor style & finish options. Part nos for ordering & sizing.	
Maverick 1000 Std	Left	2013	FA165X	SXR165HH	FA165R				MD6366D*	
	Right		FA135X	SXR135HH	FA135R					
Maverick 1000 STD/XRS/XRS - DPS	Left	2014-2016	FA165X	SXR165HH	FA165R				MD6411D*	
	Right		FA135X	SXR135HH	FA135R					
Maverick 1000 STD_XRS_XRS - DPS	Left	2015	FA642X	SXR642HH	FA642R				MD6411D*	
	Right		FA645X	SXR645HH	FA645R					
Maverick 1000 XDS - DPS	Left	2015	FA642X	SXR642HH	FA642R				MD6411D*	
	Right		FA645X	SXR645HH	FA645R					
Maverick 1000 XMR	Left	2014-2015	FA642X	SXR642HH	FA642R				MD6411D*	
	Right		FA645X	SXR645HH	FA645R					
Maverick 1000 XRS	Left	2013	FA165X	SXR165HH	FA165R				MD6366D*	
	Right		FA135X	SXR135HH	FA135R					
Maverick 1000 XXC	Left	2014-2016	FA165X	SXR165HH	FA165R				MD6411D*	
	Right		FA135X	SXR135HH	FA135R					
Maverick Max 1000 Max	Left	2016-2017	FA642X	SXR642HH	FA642R				MD6411D*	
	Right		FA645X	SXR645HH	FA645R					
Maverick Max 1000 Std/ XRS	Left	2014-2015	FA642X	SXR642HH	FA642R				MD6411D*	
	Right		FA645X	SXR645HH	FA645R					
Maverick Max 1000 XDS - DPS	Left	2015-2016	FA642X	SXR642HH	FA642R				MD6411D*	
	Right		FA645X	SXR645HH	FA645R					
Maverick Max 1000 XRS - DPS	Left	2014-2015	FA642X	SXR642HH	FA642R				MD6411D*	
	Right		FA645X	SXR645HH	FA645R					
Maverick Sport 1000R All Models	Left	2019-2023	FA682X	SXR682HH	FA682R				MD6396D*	
	Right		FA683X	SXR683HH	FA683R					
Maverick Sport Max 1000R All Models	Left	2019-2023	FA682X	SXR682HH	FA682R				MD6396D*	
	Right		FA683X	SXR683HH	FA683R					
Maverick Trail 1000 All Models	Left	2018-2023	FA682X	SXR682HH	FA682R				MD6396D*	
	Right	2018-2023	FA683X	SXR683HH	FA683R					
Traxter HD5	Left	2017-2020	FA682X		FA682R				MD6396D*	
	Right		FA683X		FA683R					
Traxter T T HD5	Left	2018-2021	FA682X	SXR682HH	FA682R				MD6396D*	
	Right		FA683X	SXR683HH	FA683R					
Traxter HD7 All Models	Left	2022-2023	FA682X	SXR682HH	FA682R				MD6396D*	
	Right		FA683X	SXR683HH	FA683R					
Traxter HD8	Left	2017-2021	FA682X	SXR682HH	FA682R				MD6396D*	
	Right		FA683X	SXR683HH	FA683R					
Traxter T T HD8	Left	2018-2021	FA682X	SXR682HH	FA682R				MD6396D*	
	Right		FA683X	SXR683HH	FA683R					
Traxter HD9 All Models	Left	2022-2023	FA682X	SXR682HH	FA682R				MD6396D*	
	Right		FA683X	SXR683HH	FA683R					
Traxter Max HD9 All Models	Left	2022-2023	FA682X	SXR682HH	FA682R				MD6396D*	
	Right		FA683X	SXR683HH	FA683R					
Traxter HD10 All Models	Left	2017-2023	FA682X	SXR682HH	FA682R				MD6396D*	
	Right		FA683X	SXR683HH	FA683R					
Traxter Max HD10 All Models	Left	2017-2023	FA682X		FA682R				MD6396D*	
	Right		FA683X		FA683R					
Traxter T T HD10	Left	2018-2020	FA682X	SXR682HH	FA682R				MD6396D*	
	Right		FA683X	SXR683HH	FA683R					
Traxter Pro HD10	Left	2022-2023	FA682X	SXR682HH	FA682R				MD6396D*	
	Right		FA683X	SXR683HH	FA683R					
CAN AM RYKER										
600 Ace	Left	2018-2023	FA165X	SXR165HH	FA165R					
	Right		FA135X	SXR135HH	FA135R					

* This symbol indicates a rotor made of billet steel, and should be only used with EBC FA Organic or Vee pads.

Line #
1
2
3
4
5
6
7
8
9
10
11
12
13
14
15
16
17
18
19
20
21
22
23
24
25
26
27
28
29
30
31
32
33
34
35
36
37
38
39
40
41
42
43
44
45
46
47
48
49
50
51
52
53
54
55

* symbol after part# = 2 pieces required i.e. 2 pad sets or 2 rotors (twin rotor models)

Part numbers, prefixes, suffixes, photos and illustrations shown in this catalog are trademarks and/or copyrights of EBC Brakes or the trademark owner A C Freeman Investments Ltd and use without express written permission of the owners is punishable by law.

REAR: AMERICAN PRODUCED MOTORCYCLES



Line #

CAN-AM UTV

SUFFIX OR PREFIX
PAD MATERIALS AND DESCRIPTION

YEAR

REAR

PADS

PADS

PADS

PADS

REAR ROTOR
OPTIONS

FA

V

HH

EPFA

DESIGN NO.

Organic
Pads

Semi-Sintered
V-Pads™

Double-H™
USA-Made
Sintered Pads

Premium Low
Noise Street
Sintered Pads

See Buyers Guide for
rotor style & finish
options. Part nos for
ordering & sizing.

1	Maverick 1000 Std	Left	2013	FA307X	SXR307HH	FA307R		MD6370D*
2		Right		FA317X	SXR317HH	FA317R		
3	Maverick 1000 STD/XRS/XRS - DPS	Left	2014-2016	FA307X	SXR307HH	FA307R		MD6370D*
4		Right		FA317X	SXR317HH	FA317R		
5	Maverick 1000 STD_XRS_XRS - DPS	Left	2015	FA307X	SXR307HH	FA307R		MD6370D*
6		Right		FA317X	SXR317HH	FA317R		
7	Maverick 1000 XDS - DPS	Left	2015	FA307X	SXR307HH	FA307R		MD6370D*
8		Right		FA317X	SXR317HH	FA317R		
9	Maverick 1000 XMR	Left	2014-2015	FA307X	SXR307HH	FA307R		MD6370D*
10		Right		FA317X	SXR317HH	FA317R		
11	Maverick 1000 XRS	Left	2013	FA307X	SXR307HH	FA307R		MD6370D*
12		Right		FA317X	SXR317HH	FA317R		
13	Maverick 1000 XXC	Left	2014-2016	FA307X	SXR307HH	FA307R		MD6370D*
14		Right		FA317X	SXR317HH	FA317R		
15	Maverick Max 1000 Max	Left	2016-2017	FA307X	SXR307HH	FA307R		MD6370D*
16		Right		FA317X	SXR317HH	FA317R		
17	Maverick Max 1000 Std/ XRS	Left	2014-2015	FA307X	SXR307HH	FA307R		MD6370D*
18		Right		FA317X	SXR317HH	FA317R		
19	Maverick Max 1000 XDS - DPS	Left	2015-2016	FA307X	SXR307HH	FA307R		MD6370D*
20		Right		FA317X	SXR317HH	FA317R		
21	Maverick Max 1000 XRS - DPS	Left	2014-2015	FA307X	SXR307HH	FA307R		MD6370D*
22		Right		FA317X	SXR317HH	FA317R		
23	Maverick Sport 1000R All Models	Left	2019-2023	FA682X	SXR682HH	FA682R		MD6412D*
24		Right		FA683X	SXR683HH	FA683R		
25	Maverick Sport Max 1000R All Models	Left	2019-2023	FA682X	SXR682HH	FA682R		MD6412D*
26		Right		FA683X	SXR683HH	FA683R		
27	Maverick Trail 1000 All Models	Left	2018-2023	FA682X	SXR682HH	FA682R		MD6412D*
28		Right		FA683X	SXR683HH	FA683R		
29	Traxter HD5	Left	2017-2020					
30		Right		FA683X	SXR683HH	FA683R		MD6396D
31	Traxter T T HD5	Left	2018-2021					
32		Right		FA683X	SXR683HH	FA683R		MD6396D
33	Traxter HD7 All Models	Left	2022-2023	FA684X	SXR684HH	FA684R		MD6396D*
34		Right		FA685X	SXR685HH	FA685R		
35	Traxter HD8	Left	2017-2021	FA684X	SXR684HH	FA684R		MD6396D*
36		Right		FA685X	SXR685HH	FA685R		
37	Traxter T T HD8	Left	2018-2021	FA684X	SXR684HH	FA684R		MD6396D*
38		Right		FA685X	SXR685HH	FA685R		
39	Traxter HD9 All Models	Left	2022-2023	FA684X	SXR684HH	FA684R		MD6396D*
40		Right		FA685X	SXR685HH	FA685R		
41	Traxter Max HD9 All Models	Left	2022-2023	FA682X	SXR682HH	FA682R		MD6396D*
42		Right		FA683X	SXR683HH	FA683R		
43	Traxter HD10 All Models	Left	2017-2023	FA684X	SXR684HH	FA684R		MD6396D*
44		Right		FA685X	SXR685HH	FA685R		
45	Traxter Max HD10 All Models	Left	2017-2023	FA682X	SXR682HH	FA682R		MD6396D*
46		Right		FA683X	SXR683HH	FA683R		
47	Traxter T T HD10	Left	2018-2020	FA684X	SXR684HH	FA684R		MD6396D*
48		Right		FA685X	SXR685HH	FA685R		
49	Traxter Pro HD10	Left	2022-2023	FA684X	SXR684HH	FA684R		MD6396D*
50		Right		FA685X	SXR685HH	FA685R		

CAN AM RYKER

51								
52								
53	600 Ace	Left	2018-2023	FA317X	SXR317HH	FA317R		
54		Right						
55								

* symbol after part# = 2 pieces required i.e. 2 pad sets or 2 rotors (twin rotor models)

Part numbers, prefixes, suffixes, photos and illustrations shown in this catalog are trademarks and/or copyrights of EBC Brakes or the trademark owner A C Freeman Investments Ltd and use without express written permission of the owners is punishable by law.

BRAKE
APPLICATIONS

All names & numbers are for reference purposes only. © Registered trademarks of Harley—Davidson® Motor Corp or Buell.

NOTE: — Some models may have a second rotor fitted as an optional extra. Please double check with your customer exactly which side the front rotor is fitted and if twin rotor or single.

☼ This symbol indicates a rotor made of billet steel, and should be only used with EBC FA Organic or Vee pads.

FRONT: AMERICAN PRODUCED MOTORCYCLES

APPLICATIONS
BRAKE



SUFFIX OR PREFIX
PAD MATERIALS AND DESCRIPTION

		FRONT					
		PADS	PADS	PADS	PADS	FRONT ROTOR OPTIONS	
		FA	V	HH	EPFA	DESIGN NO.	
		Organic Pads	Semi-Sintered V-Pads™	Double-HT™ USA-Made Sintered Pads	Premium Low Noise Street Sintered Pads	See Buyers Guide for rotor style & finish options. Part nos for ordering & sizing.	
CAN AM RYKER							
900 Ace	Left	2018-2023	FA165X	SXR165HH	FA165R		
	Right		FA135X	SXR135HH	FA135R		
900 Ace Rally Edition	Left	2021-2023	FA165X	SXR165HH	FA165R		
	Right		FA135X	SXR135HH	FA135R		
CAN AM SPYDER							
RT		2010-2012	FA474*			MD801*	
RT		2013-2021		FA630HH*	EPFA630HH*	MD853*	
RT LTD		2010-2012	FA474*			MD801*	
RT LTD		2013-2021		FA630HH*	EPFA630HH*	MD853*	
F3 SE6/SM6		2015-2023		FA630HH*	EPFA630HH*	MD853*	
F3 LTD		2016-2023		FA630HH*	EPFA630HH*	MD853*	
F3-S SE6/SM6		2015-2021		FA630HH*	EPFA630HH*	MD853*	
F3-S Special Series		2016-2023		FA630HH*	EPFA630HH*	MD853*	
F3-S Daytona 500		2017		FA630HH*	EPFA630HH*	MD853*	
F3-T		2016-2021		FA630HH*	EPFA630HH*	MD853*	
RS		2013-2016		FA630HH*	EPFA630HH*	MD853*	
RS		2010-2012	FA474*			MD801*	
RS Phantom Black		2009	FA474*			MD801*	
RS SE5		2008-2009	FA474*			MD801*	
RS SM5		2008-2009	FA474*			MD801*	
RS-S		2010-2012	FA474*			MD801*	
RS-S		2013-2016		FA630HH*	EPFA630HH*	MD853*	
RT-S		2010-2012	FA474*			MD801*	
RT-S		2013-2015		FA630HH*	EPFA630HH*	MD853*	
RT-S Special Series		2016-2017		FA630HH*	EPFA630HH*	MD853*	
ST		2013-2016		FA630HH*	EPFA630HH*	MD853*	
ST LTD		2013-2015		FA630HH*	EPFA630HH*	MD853*	
ST-S		2013-2016		FA630HH*	EPFA630HH*	MD853*	
F3 LTD Special Series		2023		FA630HH*	EPFA630HH*	MD853*	
COBRA MOTO							
50 JR		2010-2017	FA325X		FA325R		
50 JR		2018-2021			FA752R		
50 P3		2016-2017	FA325X		FA325R		
50 P3		2018-2021			FA752R		
CX 50 FWE		2016-2017	FA325X		FA325R		
CX 50 FWE		2018-2021			FA752R		
CX 50 SRX		2020-2021			FA752R		
CX50 SR King		2011-2017	FA325X		FA325R		
CX50 SR King		2018-2020			FA752R		
King 50		2004-2006	FA325X		FA325R		
CX 65		2011-2022			FA752R		
DC 65		2006	FA325X		FA325R		
EBR							
1190 RS Sport		2014-2015			FA454/4HH	EPFA454/4HH	
1190 RX Sport		2014-2015			FA454/4HH	EPFA454/4HH	
1190 SX		2014-2015			FA454/4HH	EPFA454/4HH	
INDIAN							
Chief All models		2002-2008	FA216/3	FA216/3V	FA216/3HH		
Scout All models		2002-2008	FA216/3	FA216/3V	FA216/3HH		
Spirit All models		2002-2008	FA216/3	FA216/3V	FA216/3HH		
Chief Blackhawk		2011	FA95*		FA95HH*	MD535*	

Line #

* This symbol indicates a rotor made of billet steel, and should be only used with EBC FA Organic or Vee pads.

* symbol after part# = 2 pieces required i.e. 2 pad sets or 2 rotors (twin rotor models)

Part numbers, prefixes, suffixes, photos and illustrations shown in this catalog are trademarks and/or copyrights of EBC Brakes or the trademark owner A C Freeman Investments Ltd and use without express written permission of the owners is punishable by law.

REAR: AMERICAN PRODUCED MOTORCYCLES



Line #

CAN AM RYKER

SUFFIX OR PREFIX
PAD MATERIALS AND DESCRIPTION

YEAR

REAR

PADS	PADS	PADS	PADS	REAR ROTOR OPTIONS
FA	V	HH	EPFA	DESIGN NO.
Organic Pads	Semi-Sintered V-Pads™	Double-H™ USA-Made Sintered Pads	Premium Low Noise Street Sintered Pads	See Buyers Guide for rotor style & finish options. Part nos for ordering & sizing.

1	900 Ace	Left	2018-2023	FA317X	SXR317HH	FA317R		
2		Right						
3	900 Ace Rally Edition	Left	2021-2023	FA317X	SXR317HH	FA317R		
4		Right						

CAN AM SPYDER

7	RT		2010-2012	FA473	FA473V			MD802
8	RT		2013-2021		FA631V	FA631HH		MD854
9	RT LTD		2010-2012	FA473	FA473V			MD802
10	RT LTD		2013-2021		FA631V	FA631HH		MD854
11	F3 SE6/SM6		2015-2023		FA631V	FA631HH		MD854
12	F3 LTD		2016-2023		FA631V	FA631HH		MD854
13	F3-S SE6/SM6		2015-2021		FA631V	FA631HH		MD854
14	F3-S Special Series		2016-2023		FA631V	FA631HH		MD854
15	F3-S Daytona 500		2017		FA631V	FA631HH		MD854
16	F3-T		2016-2021		FA631V	FA631HH		MD854
17	RS		2013-2016		FA631V	FA631HH		MD854
18	RS		2010-2012	FA473	FA473V			MD802
19	RS Phantom Black		2009	FA473	FA473V			MD802
20	RS SE5		2008-2009	FA473	FA473V			MD802
21	RS SM5		2008-2009	FA473	FA473V			MD802
22	RS-S		2010-2012	FA473	FA473V			MD802
23	RS-S		2013-2016		FA631V	FA631HH		MD854
24	RT-S		2010-2012	FA473	FA473V			MD802
25	RT-S		2013-2015		FA631V	FA631HH		MD854
26	RT-S Special Series		2016-2017		FA631V	FA631HH		MD854
27	ST		2013-2016		FA631V	FA631HH		MD854
28	ST LTD		2013-2015		FA631V	FA631HH		MD854
29	ST-S		2013-2016		FA631V	FA631HH		MD854
30	F3 LTD Special Series		2023		FA631V	FA631HH		MD854

COBRA MOTO

33	50 JR		2010-2017	FA325X		FA325R		
34	50 JR		2018-2021			FA752R		
35	50 P3		2016-2017	FA325X		FA325R		
36	50 P3		2018-2021			FA752R		
37	CX 50 FWE		2016-2017	FA325X		FA325R		
38	CX 50 FWE		2018-2021			FA752R		
39	CX 50 SRX		2020-2021			FA752R		
40	CX50 SR King		2011-2017	FA325X		FA325R		
41	CX50 SR King		2018-2020			FA752R		
42	King 50		2004-2006	FA325X		FA325R		
43	CX 65		2011-2022	FA480				
44	DC 65		2006	FA325X		FA325R		

EBR

47	1190 RS Sport		2014-2015			FA460HH		
48	1190 RX Sport		2014-2015			FA460HH		
49	1190 SX		2014-2015			FA460HH		

INDIAN

52	Chief All models		2002-2008	FA216/3	FA216/3V	FA216/3HH		
53	Scout All models		2002-2008	FA216/3	FA216/3V	FA216/3HH		
54	Spirit All models		2002-2008	FA216/3	FA216/3V	FA216/3HH		
55	Chief Blackhawk		2011			FA696HH		MD535

* symbol after part# = 2 pieces required i.e. 2 pad sets or 2 rotors (twin rotor models)

Part numbers, prefixes, suffixes, photos and illustrations shown in this catalog are trademarks and/or copyrights of EBC Brakes or the trademark owner A C Freeman Investments Ltd and use without express written permission of the owners is punishable by law.

BRAKE
APPLICATIONS

All names & numbers are for reference purposes only. © Registered trademarks of Harley—Davidson® Motor Corp or Buell.
NOTE: — Some models may have a second rotor fitted as an optional extra. Please double check with your customer exactly which side the front rotor is fitted and if twin rotor or single.
☉ This symbol indicates a rotor made of billet steel, and should be only used with EBC FA Organic or Vee pads.

FRONT: AMERICAN PRODUCED MOTORCYCLES

APPLICATIONS
BRAKE



SUFFIX OR PREFIX
PAD MATERIALS AND DESCRIPTION

YEAR

FRONT

PADS

PADS

PADS

PADS

FRONT ROTOR
OPTIONS

FA

V

HH

EPFA

DESIGN NO.

Organic
Pads

Semi-Sintered
V-Pads™

Double-HTM
USA-Made
Sintered Pads

Premium Low
Noise Street
Sintered Pads

See Buyers Guide for
rotor style & finish
options. Part nos for
ordering & sizing.

Line #

INDIAN

Chief Blackhawk Dark	2011	FA95*		FA95HH*		MD535*	1
Chief Bobber	2022-2023			FA347HH		MD890BLK	2
Chief Classic	2011-2013	FA95*		FA95HH*		MD535*	3
Chief Classic	2014-2017			FA347HH*			4
Chief Dark Horse	2016-2022			FA347HH		MD890BLK	5
Chief Dark Horse	2022-2023			FA347HH			6
Chief Deluxe	2009	FA95*		FA95HH*		MD535*	7
Chief Roadmaster	2009-2011	FA95*		FA95HH*		MD535*	8
Chief Standard	2009-2011	FA95*		FA95HH*		MD535*	9
Chief Super Chief	2022-2023			FA347HH			10
Chief Super Chief Limited	2022			FA347HH			11
Chief Vintage	2009-2013	FA95*		FA95HH*		MD535*	12
Chief Vintage	2014-2021			FA347HH*		MD890BLK*	13
Chief Bobber Dark Horse	2022-2023			FA347HH		MD890BLK	14
Chief	2022-2023			FA347HH		MD890BLK	15
Bomber	2010-2011	FA95*		FA95HH*		MD535*	16
Chieftain Dark Horse	2014-2023			FA347HH*		MD890BLK*	17
Chieftain Elite	2014-2023			FA347HH*		MD890BLK*	18
Chieftain Limited	2014-2023			FA347HH*		MD890BLK*	19
Chieftain	2014-2023			FA347HH*		MD890BLK*	20
Dark Horse	2010-2013	FA95*		FA95HH*		MD535*	21
Challenger 1800	2020-2023			FA630HH*			22
Challenger 1800 Dark Horse	2020-2023			FA630HH*			23
Challenger 1800 Limited	2020-2023			FA630HH*			24
Challenger 1800 Elite	2023			FA630HH*			25
Roadmaster Dark Horse	2015-2023			FA347HH*		MD890BLK*	26
Roadmaster Dark Horse Jack Daniel's Edition	2021			FA347HH*		MD890BLK*	27
Roadmaster Elite	2015-2023			FA347HH*		MD890BLK*	28
Roadmaster Limited	2015-2023			FA347HH*		MD890BLK*	29
Roadmaster	2015-2023			FA347HH*		MD890BLK*	30
Pursuit Limited	2022-2023			FA630HH*		MD803*	31
Scout Rogue	2022-2023	FA209/2	FA209/2V	FA209/2HH		MD534	32
Scout Rogue Sixty	2023	FA209/2	FA209/2V	FA209/2HH		MD534	33
Scout	2017-2023	FA209/2	FA209/2V	FA209/2HH		MD534	34
Scout Sixty	2016	FA672	FA672V	FA672HH		MD534	35
Scout Sixty	2017-2023	FA209/2	FA209/2V	FA209/2HH		MD534	36
Scout	2015-2016	FA672	FA672V	FA672HH		MD534	37
Scout Bobber	2019-2023	FA209/2	FA209/2V	FA209/2HH			38
Scout Bobber Sixty	2021-2023	FA209/2	FA209/2V	FA209/2HH			39
Scout Bobber Twenty	2019-2023	FA209/2	FA209/2V	FA209/2HH			40
Springfield	2016-2023			FA347HH*		MD890BLK*	41
Springfield Dark Horse	2019-2023			FA347HH*		MD890BLK*	42
FTR 1200 Rally	2020-2023			FA630HH*	EPFA630HH*	MD803*	43
FTR 1200 R Carbon	2021-2022			FA630HH*	EPFA630HH*	MD803*	44
FTR 1200 S	2019-2023			FA630HH*	EPFA630HH*	MD803*	45
FTR 1200 S Race Replica	2019-2020			FA630HH*	EPFA630HH*	MD803*	46
FTR 1200	2018-2023			FA630HH*	EPFA630HH*	MD803*	47

MOTUS

MST	2014-2017	FA244*		FA244HH*	EPFA244HH*		50
MSTR	2014-2017			FA447HH*	EPFA447HH*		51
MST-01	2012-2013			FA322/4HH*	EPFA322/4HH*		52
MSTR-01	2012-2013			FA322/4HH*	EPFA322/4HH*		53

* symbol after part# = 2 pieces required i.e. 2 pad sets or 2 rotors (twin rotor models)

Part numbers, prefixes, suffixes, photos and illustrations shown in this catalog are trademarks and/or copyrights of EBC Brakes or the trademark owner A C Freeman Investments Ltd and use without express written permission of the owners is punishable by law.

This symbol indicates a rotor made of billet steel, and should be only used with EBC FA Organic or Vee pads.

FRONT: AMERICAN PRODUCED MOTORCYCLES

APPLICATIONS
BRAKE



SUFFIX OR PREFIX
PAD MATERIALS AND DESCRIPTION

FRONT

YEAR	PADS	PADS	PADS	PADS	FRONT ROTOR
					DESIGN NO.
					Options
	FA	V	HH	EPFA	DESIGN NO.
	Organic Pads	Semi-Sintered V-Pads™	Double-H™ USA-Made Sintered Pads	Premium Low Noise Street Sintered Pads	See Buyers Guide for rotor style & finish options. Part nos for ordering & sizing.

POLARIS ATV

☞ This symbol indicates a rotor made of billet steel, and should be only used with EBC FA Organic or Vee pads.

Outlaw 50	2008-2018	338*		338G*			1
Predator 50	2004-2007	338*		338G*			2
Scrambler 50	1985-1986	503		503G			3
Scrambler 50	2001-2003	338*		338G*			4
Outlaw 70	2021-2022	TBC*		TBC*			5
Outlaw 90	2007-2016	338*		338G*			6
Predator 90	2003-2006	338*		338G*			7
Scrambler 90 X	2001-2003	338*		338G*			8
Sportsman 90	2001-2016	338*		338G*			9
Outlaw 110	2016-2022	338*		338G*			10
150 Ranger Youth Efi	2023	FA159X*		FA159R*		MD6149D*	11
Phoenix 200	2005	FA159X*		FA159R*		MD6219D*	12
Phoenix 200	2006-2009	FA83X*		FA83R*		MD6274D*	13
Phoenix 200	2010-2014			FA490R*		MD6274D*	14
Phoenix 200 Quadricycle Model	2005	FA159X*		FA159R*		MD6219D*	15
Phoenix 200 Quadricycle Model	2005-2009	FA83X*		FA83R*		MD6274D*	16
Phoenix 200 Quadricycle Model	2010			FA490R*		MD6274D*	17
Sawtooth 200	2006-2007	FA83X*		FA83R*		MD6274D*	18
Sawtooth 200 Quadricycle	2006	FA83X*		FA83R*		MD6274D*	19
Sawtooth 200 Quadricycle	2008	FA83X*		FA83R*		MD6274D*	20
Big Boss 250 4 x 6	1989-1990	FA159X*		FA159R*		MD6147D*	21
Big Boss 250 4 x 6	1989-1990	FA159X		FA159R		MD6149D	22
Big Boss 250 4 x 6	1991-1992	FA159X*		FA159R*		MD6150D*	23
Big Boss 250 4 x 6	1991-1992	FA159X		FA159R		MD6149D	24
Big Boss 250 6 x 6	1991	FA159X*		FA159R*		MD6149D*	25
Big Boss 250 6 x 6	1991	FA159X		FA159R		MD6149D	26
Big Boss 250 6 x 6	1992-1993	FA159X*		FA159R*		MD6150D*	27
Big Boss 250 6 x 6	1992-1993	FA159X		FA159R		MD6149D	28
Cyclone X 250	1987	503*		503G*			29
Trail Blazer 250	1990	FA159X*		FA159R*		MD6147D*	30
Trail Blazer 250	1991-1993	FA159X*		FA159R*		MD6150D*	31
Trail Blazer 250	1994-1998	FA159X*		FA159R*		MD6150D*	32
Trail Blazer 250	1999-2000	FA159X*		FA159R*		MD6155D*	33
Trail Blazer 250	2005-2006	FA159X*		FA159R*		MD6262D*	34
Trail Blazer 250 Freedom	2001-2004	FA159X*		FA159R*		MD6155D*	35
Trail Boss 250	1988-1990	FA159X*		FA159R*		MD6147D*	36
Trail Boss 250	1991-1999	FA159X*		FA159R*		MD6150D*	37
Trail Boss 250 2 x 4	1985-1987	503*		503G*			38
Trail Boss 250 2 x 4/4 x 4	1988-1989	FA159X*		FA159R*		MD6147D*	39
Trail Boss 250 2 x 4/4 x 4	1991-1992	FA159X*		FA159R*		MD6150D*	40
Trail Boss 250 4 x 4	1987	FA54X*		FA54R*		MD6147D*	41
300 2 x 4 / 4 x 4	1994-1995	FA159X*		FA159R*		MD6150D*	42
Big Boss 300 6 x 6	1994	FA159X*		FA159R*		MD6150D*	43
Big Boss 300 6 x 6	1994	FA159X*		FA159R*		MD6149D*	44
Hawkeye 300 2 x 4	2006	FA395X*		FA395R*		MD6272D*	45
Hawkeye 300 2 x 4	2008-2009	FA159X*		FA159R*		MD6272D*	46
Hawkeye 300 2 x 4/4 x 4	2007	FA159X*		FA159R*		MD6272D*	47
Hawkeye 300 4 x 4	2006	FA395X*		FA395R*		MD6272D*	48
Sportsman 300 4 x 4	2008-2010	FA159X*		FA159R*		MD6272D*	49
Xpress 300 2 x 4	1998-2000	FA159X*		FA159R*		MD6150D*	50
Xpress 300/400 L	1996-1997	FA159X*		FA159R*		MD6150D*	51
Xplorer 300 4 x 4	1996-2000	FA159X*		FA159R*		MD6150D*	52
Hawkeye 325 2 x 4	2015	FA159X*		FA159R*		MD6202D*	53
Magnum 325 2 x 4 HDS	2002	FA159X*		FA159R*		MD6155D*	54
Magnum 325 2 x 4/4 x 4 Moose	2001	FA159X*		FA159R*		MD6155D*	55

* symbol after part# = 2 pieces required i.e. 2 pad sets or 2 rotors (twin rotor models)

Part numbers, prefixes, suffixes, photos and illustrations shown in this catalog are trademarks and/or copyrights of EBC Brakes or the trademark owner A C Freeman Investments Ltd and use without express written permission of the owners is punishable by law.

REAR: AMERICAN PRODUCED MOTORCYCLES



Line #

POLARIS ATV

SUFFIX OR PREFIX
PAD MATERIALS AND DESCRIPTION

YEAR

		REAR				
		PADS	PADS	PADS	PADS	REAR ROTOR OPTIONS
		FA	V	HH	EPFA	DESIGN NO.
		Organic Pads	Semi-Sintered V-Pads™	Double-H™ USA-Made Sintered Pads	Premium Low Noise Street Sintered Pads	See Buyers Guide for rotor style & finish options. Part nos for ordering & sizing.
1	Outlaw 50	2008-2018	307		307G	
2	Predator 50	2004-2007	307		307G	
3	Scrambler 50	1985-1986	FA40			
4	Scrambler 50	2001-2003	307		307G	
5	Outlaw 70	2021-2022	TBC			
6	Outlaw 90	2007-2016	307		307G	
7	Predator 90	2003-2006	307		307G	
8	Scrambler 90 X	2001-2003	307		307G	
9	Sportsman 90	2001-2016	307		307G	
10	Outlaw 110	2016-2022	307		307G	
11	150 Ranger Youth Efi	2023	FA232X		FA232R	
12	Phoenix 200	2005	306		306G	
13	Phoenix 200	2006-2009	306		306G	
14	Phoenix 200	2010-2014	306		306G	
15	Phoenix 200 Quadricycle Model	2005	FA67X		FA67R	MD6311D
16	Phoenix 200 Quadricycle Model	2005-2009	FA67X		FA67R	MD6311D
17	Phoenix 200 Quadricycle Model	2010	FA67X		FA67R	MD6311D
18	Sawtooth 200	2006-2007	306		306G	
19	Sawtooth 200 Quadricycle	2006	FA67X		FA67R	MD6311D
20	Sawtooth 200 Quadricycle	2008	FA67X		FA67R	MD6311D
21	Big Boss 250 4 x 6	1989-1990	FA232X		FA232R	
22	Big Boss 250 4 x 6	1989-1990				
23	Big Boss 250 4 x 6	1991-1992	FA232X		FA232R	
24	Big Boss 250 4 x 6	1991-1992				
25	Big Boss 250 6 x 6	1991	FA232X		FA232R	
26	Big Boss 250 6 x 6	1991				
27	Big Boss 250 6 x 6	1992-1993	FA232X		FA232R	
28	Big Boss 250 6 x 6	1992-1993				
29	Cyclone X 250	1987	FA40			
30	Trail Blazer 250	1990	FA232X		FA232R	
31	Trail Blazer 250	1991-1993	FA232X		FA232R	
32	Trail Blazer 250	1994-1998	FA232X		FA232R	
33	Trail Blazer 250	1999-2000	FA270X		FA270R	MD6156D
34	Trail Blazer 250	2005-2006			FA314R	MD6256D
35	Trail Blazer 250 Freedom	2001-2004	FA270X		FA270R	MD6156D
36	Trail Boss 250	1988-1990	FA232X		FA232R	
37	Trail Boss 250	1991-1999	FA232X		FA232R	
38	Trail Boss 250 2 x 4	1985-1987	FA40			
39	Trail Boss 250 2 x 4/4 x 4	1988-1989	FA232X		FA232R	
40	Trail Boss 250 2 x 4/4 x 4	1991-1992	FA232X		FA232R	
41	Trail Boss 250 4 x 4	1987	FA232X		FA232R	
42	300 2 x 4 / 4 x 4	1994-1995	FA232X		FA232R	
43	Big Boss 300 6 x 6	1994	FA232X		FA232R	
44	Big Boss 300 6 x 6	1994				
45	Hawkeye 300 2 x 4	2006	FA395X*		FA395R*	MD6273D*
46	Hawkeye 300 2 x 4	2008-2009	FA159X		FA159R	MD6273D
47	Hawkeye 300 2 x 4/4 x 4	2007	FA159X*		FA159R*	MD6273D*
48	Hawkeye 300 4 x 4	2006	FA395X*		FA395R*	MD6273D*
49	Sportsman 300 4 x 4	2008-2010	FA159X		FA159R	MD6273D
50	Xpress 300 2 x 4	1998-2000	FA232X		FA232R	
51	Xpress 300/400 L	1996-1997	FA232X		FA232R	
52	Xplorer 300 4 x 4	1996-2000	FA232X		FA232R	
53	Hawkeye 325 2 x 4	2015	FA475X		FA475R	MD6275D
54	Magnum 325 2 x 4 HDS	2002			FA314R	MD6200D
55	Magnum 325 2 x 4/4 x 4 Moose	2001	FA270X		FA270R	MD6156D

* symbol after part# = 2 pieces required i.e. 2 pad sets or 2 rotors (twin rotor models)

Part numbers, prefixes, suffixes, photos and illustrations shown in this catalog are trademarks and/or copyrights of EBC Brakes or the trademark owner A C Freeman Investments Ltd and use without express written permission of the owners is punishable by law.

BRAKE
APPLICATIONS

All names & numbers are for reference purposes only. © Registered trademarks of Harley—Davidson® Motor Corp or Buell.

NOTE: — Some models may have a second rotor fitted as an optional extra. Please double check with your customer exactly which side the front rotor is fitted and if twin rotor or single.

☼ This symbol indicates a rotor made of billet steel, and should be only used with EBC FA Organic or Vee pads.

FRONT: AMERICAN PRODUCED MOTORCYCLES

APPLICATIONS
BRAKE



POLARIS ATV

SUFFIX OR PREFIX
PAD MATERIALS AND DESCRIPTION

YEAR

FRONT				
PADS	PADS	PADS	PADS	FRONT ROTOR OPTIONS
FA	V	HH	EPFA	DESIGN NO.
Organic Pads	Semi-Sintered V-Pads™	Double-HTM USA-Made Sintered Pads	Premium Low Noise Street Sintered Pads	See Buyers Guide for rotor style & finish options. Part nos for ordering & sizing.
Magnum 325 4 x 4	2002	FA159X*	FA159R*	MD6155D*
Magnum 325 4 x 4 HDS	2002	FA159X*	FA159R*	MD6202D*
Sportsman 325 Ace	2014	FA656X*	FA656R*	MD6202D*
Sportsman 325 Ace EFI	2015	FA656X*	FA656R*	MD6202D*
Sportsman 325 Ace Euro	2014-2015	FA656X*	FA656R*	MD6202D*
Sportsman 325 Ace HD	2015	FA656X*	FA656R*	MD6202D*
Trail Boss 325	2001-2002	FA159X*	FA159R*	MD6155D*
Xpedition 325	2002	FA159X*	FA159R*	MD6155D*
Magnum 330 2 x 4/HDS	2003-2006	FA159X*	FA159R*	MD6149D*
Magnum 330 4 x 4/HDS	2003-2004	FA159X*	FA159R*	MD6202D*
ATP 330 4 x 4	2004-2005	FA159X*	FA159R*	MD6202D*
Trail Blazer 330	2008-2009	FA159X*	FA159R*	MD6262D*
Trail Blazer 330	2010-2013	FA159X*	FA159R*	MD6202D*
Trail Boss 330	2003-2004	FA159X*	FA159R*	MD6155D*
Trail Boss 330	2005-2009	FA159X*	FA159R*	MD6262D*
Trail Boss 330	2010-2013	FA159X*	FA159R*	MD6202D*
Sportsman 335 4 x 4	1999-2000	FA159X*	FA159R*	MD6150D*
Sportsman 335 Worker 4 x 4	1999-2000	FA159X*	FA159R*	MD6149D*
350 L 2 x 4	1990	FA159X*	FA159R*	MD6150D*
350 L 4 x 4	1990	FA159X*	FA159R*	MD6149D*
350 L 4 x 4	1993	FA159X*	FA159R*	MD6150D*
Big Boss 350 L	1993	FA159X*	FA159R*	MD6149D*
Sportsman 350 4 x 4	1993	FA159X*	FA159R*	MD6149D*
Trail Boss 350 L 2 x 4	1991-1993	FA159X*	FA159R*	MD6150D*
Trail Boss 350 L 2 x 4	1991	FA159X*	FA159R*	MD6149D*
400 L 2 x 4	1994-1995	FA159X*	FA159R*	MD6150D*
400 L 4 x 4	1994	FA159X*	FA159R*	MD6149D*
Big Boss 400 L 6 x 6	1994-1995	FA159X*	FA159R*	MD6149D*
Big Boss 400 L 6 x 6	1994-1995	FA159X*	FA159R*	MD6149D*
Big Boss 400 L 6 x 6	1996	FA159X*	FA159R*	MD6149D*
Big Boss 400 L 6 x 6	1996		FA273R*	MD6153D
Big Boss 400 L 6 x 6	1997	FA159X*	FA159R*	MD6149D*
Big Boss 400 L 6 x 6	1997	FA159X*	FA159R*	MD6149D*
Hawkeye 400 H.O. 2 x 4	2013-2014	FA159X*	FA159R*	MD6202D*
Scrambler 400 2 x 4	2002	FA159X*	FA159R*	MD6155D*
Scrambler 400 4 x 4	1998-2002	FA159X*	FA159R*	MD6155D*
Scrambler 400 L 4 x 4	1995-1997	FA159X*	FA159R*	MD6150D*
Sport 400	1999-2000	FA159X*	FA159R*	MD6150D*
Sport 400 L	1994-1998	FA159X*	FA159R*	MD6150D*
Sportsman 400	2001-2002	FA159X*	FA159R*	MD6149D*
Sportsman 400	2003	FA159X*	FA159R*	MD6149D*
Sportsman 400	2004	FA159X*	FA159R*	MD6149D*
Sportsman 400	2004	FA159X*	FA159R*	MD6202D*
Sportsman 400 HO 4 x 4	2008-2010	FA159X*	FA159R*	MD6272D*
Sportsman 400 HO 4 x 4	2011-2014	FA159X*	FA159R*	MD6202D*
Sportsman 400 L 4 x 4	1994-1997	FA159X*	FA159R*	MD6149D*
Trail Blazer 400	2003	FA159X*	FA159R*	MD6155D*
Xplorer 400	2001-2002	FA159X*	FA159R*	MD6149D*
Xplorer 400 4 x 4	2001-2002	FA159X*	FA159R*	MD6155D*
Xplorer 400 L 4 x 4	1995-1998	FA159X*	FA159R*	MD6149D*
Xplorer 400 L 4 x 4	1999-2000	FA159X*	FA159R*	MD6149D*
Xplorer S	2008-2010	FA456X*	FA456R*	MD6219D*
Magnum 425 2 x 4	1995-1998	FA159X*	FA159R*	MD6150D*
Magnum 425 4 x 4	1995-1998	FA159X*	FA159R*	MD6149D*
Magnum 425 6 x 6	1996	FA159X*	FA159R*	MD6149D*

Line #

⚡ This symbol indicates a rotor made of billet steel, and should be only used with EBC FA Organic or Vee pads.

* symbol after part# = 2 pieces required i.e. 2 pad sets or 2 rotors (twin rotor models)

Part numbers, prefixes, suffixes, photos and illustrations shown in this catalog are trademarks and/or copyrights of EBC Brakes or the trademark owner A C Freeman Investments Ltd and use without express written permission of the owners is punishable by law.

REAR: AMERICAN PRODUCED MOTORCYCLES



Line #

POLARIS ATV

SUFFIX OR PREFIX
PAD MATERIALS AND DESCRIPTION

YEAR

REAR				
PADS	PADS	PADS	PADS	REAR ROTOR OPTIONS
FA	V	HH	EPFA	DESIGN NO.
Organic Pads	Semi-Sintered V-Pads™	Double-H™ USA-Made Sintered Pads	Premium Low Noise Street Sintered Pads	See Buyers Guide for rotor style & finish options. Part nos for ordering & sizing.
1	Magnum 325 4 x 4	2002		MD6200D
2	Magnum 325 4 x 4 HDS	2002		MD6200D
3	Sportsman 325 Ace	2014		MD6275D*
4	Sportsman 325 Ace Efi	2015		MD6275D*
5	Sportsman 325 Ace Euro	2014-2015		MD6275D*
6	Sportsman 325 Ace HD	2015		MD6275D*
7	Trail Boss 325	2001-2002	FA270X	MD6156D
8	Xpedition 325	2002		MD6200D
9	Magnum 330 2 x 4/HDS	2003-2006		MD6200D
10	Magnum 330 4 x 4/HDS	2003-2004		MD6200D
11	ATP 330 4 x 4	2004-2005	FA159X*	MD6200D*
12	Trail Blazer 330	2008-2009		MD6256D
13	Trail Blazer 330	2010-2013		MD6256D
14	Trail Boss 330	2003-2004	FA270X	MD6156D
15	Trail Boss 330	2005-2009		MD6256D
16	Trail Boss 330	2010-2013		MD6256D
17	Sportsman 335 4 x 4	1999-2000	FA270X	
18	Sportsman 335 Worker 4 x 4	1999-2000	FA270X	
19	350 L 2 x 4	1990	FA232X	
20	350 L 4 x 4	1990	FA232X	
21	350 L 4 x 4	1993	FA232X	
22	Big Boss 350 350 L	1993	FA232X	
23	Sportsman 350 350 4 x 4	1993	FA232X	
24	Trail Boss 350 L 2 x 4	1991-1993	FA232X	
25	Trail Boss 350 L 2 x 4	1991	FA232X	
26	400 L 2 x 4	1994-1995	FA232X	
27	400 L 4 x 4	1994	FA232X	
28	Big Boss 400 L 6 x 6	1994-1995	FA232X	
29	Big Boss 400 L 6 x 6	1994-1995		
30	Big Boss 400 L 6 x 6	1996	FA232X	
31	Big Boss 400 L 6 x 6	1996		
32	Big Boss 400 L 6 x 6	1997	FA232X	
33	Big Boss 400 L 6 x 6	1997		
34	Hawkeye 400 H.O. 2 x 4	2013-2014	FA475X	MD6274D
35	Scrambler 400 2 x 4	2002	FA270X	MD6156D
36	Scrambler 400 4 x 4	1998-2002	FA270X	MD6156D
37	Scrambler 400 L 4 x 4	1995-1997	FA232X	
38	Sport 400	1999-2000	FA270X	MD6156D
39	Sport 400 L	1994-1998	FA232X	
40	Sportsman 400	2001-2002	FA270X	
41	Sportsman 400	2003		MD6201D*
42	Sportsman 400	2004		MD6201D*
43	Sportsman 400	2004		MD6201D*
44	Sportsman 400 HO 4 x 4	2008-2010	FA159X	MD6273D
45	Sportsman 400 HO 4 x 4	2011-2014	FA475X	MD6275D
46	Sportsman 400 L 4 x 4	1994-1997	FA232X	
47	Trail Blazer 400	2003	FA270X	MD6156D
48	Xplorer 400	2001-2002	FA270X	MD6169D
49	Xplorer 400 4 x 4	2001-2002	FA270X	MD6156D
50	Xplorer 400 L 4 x 4	1995-1998	FA232X	
51	Xplorer 400 L 4 x 4	1999-2000	FA270X	MD6169D
52	Xplorer S	2008-2010	FA159X	MD6218D
53	Magnum 425 2 x 4	1995-1998	FA232X	
54	Magnum 425 4 x 4	1995-1998	FA232X	
55	Magnum 425 6 x 6	1996	FA232X	

All names & numbers are for reference purposes only. © Registered trademarks of Harley—Davidson® Motor Corp or Buell.

NOTE: — Some models may have a second rotor fitted as an optional extra. Please double check with your customer exactly which side the front rotor is fitted and if twin rotor or single.

☼ This symbol indicates a rotor made of billet steel, and should be only used with EBC FA Organic or Vee pads.

BRAKE APPLICATIONS

* symbol after part# = 2 pieces required i.e. 2 pad sets or 2 rotors (twin rotor models)

Part numbers, prefixes, suffixes, photos and illustrations shown in this catalog are trademarks and/or copyrights of EBC Brakes or the trademark owner A C Freeman Investments Ltd and use without express written permission of the owners is punishable by law.

FRONT: AMERICAN PRODUCED MOTORCYCLES

APPLICATIONS
BRAKE



SUFFIX OR PREFIX
PAD MATERIALS AND DESCRIPTION

YEAR	FRONT					Line #
	PADS	PADS	PADS	PADS	FRONT ROTOR OPTIONS	
	FA	V	HH	EPFA	DESIGN NO.	
	Organic Pads	Semi-Sintered V-Pads™	Double-H™ USA-Made Sintered Pads	Premium Low Noise Street Sintered Pads	See Buyers Guide for rotor style & finish options. Part nos for ordering & sizing.	
Magnum 425 6 x 6			FA273R*		MD6153D	1
Magnum 425 6 x 6	FA159X*		FA159R*		MD6149D*	2
Magnum 425 6 x 6	FA159X*		FA159R*		MD6149D*	3
Magnum 425	FA159X*		FA159R*		MD6149D*	4
Xpedition 425 4 x 4	FA159X*		FA159R*		MD6149D*	5
Outlaw 450 MXR	FA456X*		FA456R*		MD6219D*	6
Outlaw 450 S	FA456X*		FA456R*		MD6219D*	7
Sportsman 450	FA159X*		FA159R*		MD6202D*	8
Sportsman 450	FA159X*		FA159R*		MD6202D*	9
Sportsman 450 HO	FA159X*		FA159R*		MD6202D*	10
Sportsman 450 HO	FA475X*		FA475R*		MD6202D*	11
Diesel 455 4 x 4 EBS	FA159X*		FA159R*		MD6149D*	12
Diesel 455	FA159X*		FA159R*		MD6149D*	13
ATP HO 500 4 x 4	FA159X*		FA159R*		MD6202D*	14
ATV Pro 500 4 x 4 PPS	FA159X*		FA159R*		MD6202D*	15
Big Boss 500 6 x 6	FA159X*		FA159R*		MD6149D*	16
Big Boss 500 6 x 6	FA159X*		FA159R*		MD6149D*	17
Magnum 500 2 x 4 39906 HDS	FA159X*		FA159R*		MD6149D*	18
Magnum 500 4 x 4	FA159X*		FA159R*		MD6149D*	19
Magnum 500 4 x 4 HDS	FA159X*		FA159R*		MD6202D*	20
Outlaw 500	FA159X*		FA159R*		MD6219D*	21
Outlaw IRS	FA456X*		FA456R*		MD6219D*	22
Predator 500 TLD	FA159X*		FA159R*		MD6219D*	23
Scrambler 500 2 x 4	FA159X*		FA159R*		MD6155D*	24
Scrambler 500 2 x 4	FA159X*		FA159R*		MD6262D*	25
Scrambler 500 4 x 4	FA159X*		FA159R*		MD6150D*	26
Scrambler 500 4 x 4	FA159X*		FA159R*		MD6155D*	27
Scrambler 500 4 x 4	FA159X*		FA159R*		MD6155D*	28
Scrambler 500 4 x 4	FA159X*		FA159R*		MD6202D*	29
Sportsman 500 4 x 4	FA159X*		FA159R*		MD6149D*	30
Sportsman 500 4 x 4	FA159X*		FA159R*		MD6149D*	31
Sportsman 500 6 x 6	FA159X*		FA159R*		MD6149D*	32
Sportsman 500 EFI Quad H.O.	FA159X*		FA159R*		MD6202D*	33
Sportsman 500 EFI/HO	FA159X*		FA159R*		MD6202D*	34
Sportsman 500 EFI/HO	FA159X*		FA159R*		MD6202D*	35
Sportsman 500 Forest	FA159X*		FA159R*		MD6202D*	36
Sportsman 500 HO	FA159X*		FA159R*		MD6202D*	37
Sportsman 500 HO	FA159X*		FA159R*		MD6202D*	38
Sportsman 500 HO/EFI Demand Drive	FA159X*		FA159R*		MD6149D*	39
Sportsman 500 Touring H.O.	FA159X*		FA159R*		MD6202D*	40
Sportsman 500 Touring H.O.	FA159X*		FA159R*		MD6202D*	41
Sportsman 500 Worker 4 x 4 EBS/500 RSE	FA159X*		FA159R*		MD6149D*	42
Sportsman 500 X 2 EFI	FA159X*		FA159R*		MD6202D*	43
Sportsman 500 X2	FA159X*		FA159R*		MD6202D*	44
Sportsman 500 XP	FA475X*		FA475R*		MD6339D*	45
Xplorer 500 4 x 4	FA159X*		FA159R*		MD6149D*	46
Sportsman 550 EPS	FA475X*		FA475R*		MD6339D*	47
Sportsman 550 Forest	FA475X*		FA475R*		MD6339D*	48
Sportsman 550 Touring EPS	FA475X*		FA475R*		MD6339D*	49
Sportsman 550 X2	FA475X*		FA475R*		MD6339D*	50
Sportsman 550 XP EPS	FA475X*		FA475R*		MD6339D*	51
Sportsman 550	FA475X*		FA475R*		MD6339D*	52
Sportsman 570 6X6	FA159X*		FA159R*		MD6202D*	53
Sportsman 570 6X6 Tractor	FA159X*		FA159R*		MD6202D*	54
Sportsman 570 Ace	FA656X*		FA656R*		MD6202D*	55

This symbol indicates a rotor made of billet steel, and should be only used with EBC FA Organic or Vee pads.

* symbol after part# = 2 pieces required i.e. 2 pad sets or 2 rotors (twin rotor models)

Part numbers, prefixes, suffixes, photos and illustrations shown in this catalog are trademarks and/or copyrights of EBC Brakes or the trademark owner A C Freeman Investments Ltd and use without express written permission of the owners is punishable by law.

FRONT: AMERICAN PRODUCED MOTORCYCLES

APPLICATIONS
BRAKE



SUFFIX OR PREFIX
PAD MATERIALS AND DESCRIPTION

POLARIS ATV

	YEAR	FRONT					Line #
		PADS	PADS	PADS	PADS	FRONT ROTOR OPTIONS	
		FA	V	HH	EPFA	DESIGN NO.	
		Organic Pads	Semi-Sintered V-Pads™	Double-HTM USA-Made Sintered Pads	Premium Low Noise Street Sintered Pads	See Buyers Guide for rotor style & finish options. Part nos for ordering & sizing.	
Sportsman 570 Ace Euro	2015-2018	FA656X*		FA656R*		MD6202D*	1
Sportsman 570 EFI	2011-2020	FA159X*		FA159R*		MD6202D*	2
Sportsman 570 EFI X2	2015-2021	FA159X*		FA159R*		MD6202D*	3
Sportsman 570 Forest Tracker EFI/EPS	2015	FA159X*		FA159R*		MD6202D*	4
Sportsman 570 Touring EFI	2014-2021	FA159X*		FA159R*		MD6202D*	5
Sportsman 570 Touring Tractor EFI EPS	2016-2021	FA159X*		FA159R*		MD6202D*	6
Sportsman 570	2021-2023	FA475X*		FA475R*		MD6202D*	7
Sportsman 600 4 x 4	2003-2005	FA159X*		FA159R*		MD6202D*	8
Sportsman 700 4 x 4 EFI	2002-2006	FA159X*		FA159R*		MD6202D*	9
Sportsman 700 EFI	2007	FA159X*		FA159R*		MD6202D*	10
Sportsman 700 MV	2005-2006	FA159X*		FA159R*		MD6202D*	11
Sportsman 700 X2	2008	FA159X*		FA159R*		MD6202D*	12
Sportsman 800 Big Boss EFI 6 x 6	2009-2014	FA159X*		FA159R*		MD6202D*	13
Sportsman 800 EFI	2005-2006	FA159X*		FA159R*		MD6202D*	14
Sportsman 800 EFI	2008	FA159X*		FA159R*		MD6202D*	15
Sportsman 800 EFI	2009	FA159X*		FA159R*		MD6202D*	16
Sportsman 800 EFI	2010-2013	FA159X*		FA159R*		MD6202D*	17
Sportsman 800 EFI Int/HO	2007-2011	FA159X*		FA159R*		MD6202D*	18
Sportsman 800 EFI Touring	2008-2009	FA159X*		FA159R*		MD6202D*	19
Sportsman 800 Forest	2012	FA475X*		FA475R*		MD6339D*	20
Sportsman 800 X2 EFI	2007-2009	FA159X*		FA159R*		MD6202D*	21
Sportsman 800	2012-2014	FA475X*		FA475R*		MD6339D*	22
Forest 850	2015	FA475X*		FA475R*		MD6339D*	23
Scrambler 850 XP HO	2013-2015	FA475X*		FA475R*		MD6339D*	24
Scrambler 850	2015	FA475X*		FA475R*		MD6339D*	25
Sportsman 850 Forest	2012	FA475X*		FA475R*		MD6339D*	26
Sportsman 850 Touring EPS	2010-2013	FA475X*		FA475R*		MD6339D*	27
Sportsman 850 Touring H.O. EPS	2013-2015	FA475X*		FA475R*		MD6339D*	28
Sportsman 850 XP	2009-2013	FA475X*		FA475R*		MD6339D*	29
Sportsman 850 XP EPS	2009-2013	FA475X*		FA475R*		MD6339D*	30
Sportsman 850 XP H.O. EPS	2013-2015	FA475X*		FA475R*		MD6339D*	31
Sportsman 850 A22SXA85A1	2022-2023	FA475X*		FA475R*		MD6339D*	32
Forest 1000	2015	FA475X*		FA475R*		MD6339D*	33
Scrambler 1000 1000	2015	FA475X*		FA475R*		MD6339D*	34
Scrambler 1000 XP	2015	FA475X*		FA475R*		MD6339D*	35
Scrambler 1000 XP	2015-2021	FA475X*		FA475R*		MD6339D*	36
Sportsman 1000 MD/XP	2015-2019	FA475X*		FA475R*		MD6339D*	37
Sportsman 1000 Touring Tractor	2016-2022	FA475X*		FA475R*		MD6339D*	38
Sportsman 1000 Touring XP	2015-2020	FA475X*		FA475R*		MD6339D*	39
Sportsman 1000 XP High Lifter	2019	FA475X*		FA475R*		MD6339D*	40
Sportsman 1000 XP S 55	2020-2021	FA475X*		FA475R*		MD6338D*	41
Sportsman 1000 XP Tractor	2016-2021	FA475X*		FA475R*		MD6338D*	42
Sportsman 1000 XP	2022-2023	FA475X*		FA475R*		MD6339D*	43
							44
							45
POLARIS UTV							
250 2 x 4 / 4 x 4	1993	FA159X*		FA159R*		MD6150D*	46
325 Ranger ETX	2015-2016			FA354R*		MD6202D*	47
400 Ranger	2010-2014			FA354R*		MD6202D*	48
499 Ranger	2017	Left		FA354R*		MD6202D*	49
499 Ranger	2017	Right					50
500 Ranger	2017-2020			FA354R*		MD6202D*	51
500 Ranger	2021-2022			FA354R*		MD6202D*	52
500 Ranger 2 x 4/4 x 4	2006-2007			FA354R*		MD6202D*	53
500 Ranger 4 x 4 EFI	2006-2007			FA354R*		MD6202D*	54
500 Ranger 4 x 4 EFI	2008-2010	FA452X*		FA452R*		MD6202D*	55

* symbol after part# = 2 pieces required i.e. 2 pad sets or 2 rotors (twin rotor models)

Part numbers, prefixes, suffixes, photos and illustrations shown in this catalog are trademarks and/or copyrights of EBC Brakes or the trademark owner A C Freeman Investments Ltd and use without express written permission of the owners is punishable by law.

This symbol indicates a rotor made of billet steel, and should be only used with EBC FA Organic or Vee pads.

REAR: AMERICAN PRODUCED MOTORCYCLES



Line #

POLARIS ATV

SUFFIX OR PREFIX
PAD MATERIALS AND DESCRIPTION

YEAR

			REAR				REAR ROTOR OPTIONS
			PADS	PADS	PADS	PADS	DESIGN NO.
			FA	V	HH	EPFA	DESIGN NO.
			Organic Pads	Semi-Sintered V-Pads™	Double-HT™ USA-Made Sintered Pads	Premium Low Noise Street Sintered Pads	See Buyers Guide for rotor style & finish options. Part nos for ordering & sizing.
1	Sportsman 570 Ace Euro	2015-2018		SXR354HH*	FA354R*		MD6275D*
2	Sportsman 570 EFI	2011-2020	FA475X		FA475R		MD6275D
3	Sportsman 570 EFI X2	2015-2021	FA475X		FA475R		MD6275D
4	Sportsman 570 Forest Tracker EFI/EPS	2015	FA475X		FA475R		MD6275D
5	Sportsman 570 Touring EFI	2014-2021	FA475X		FA475R		MD6275D
6	Sportsman 570 Touring Tractor EFI EPS	2016-2021	FA475X		FA475R		MD6275D
7	Sportsman 570	2021-2023	FA475X		FA475R		MD6275D
8	Sportsman 600 4 x 4	2003-2005			FA314R		MD6201D
9	Sportsman 700 4 x 4 EFI	2002-2006			FA314R		MD6201D
10	Sportsman 700 EFI	2007			FA314R		MD6275D
11	Sportsman 700 MV	2005-2006			FA314R		MD6201D
12	Sportsman 700 X2	2008	FA159X		FA159R		MD6275D
13	Sportsman 800 Big Boss EFI 6 x 6	2009-2014			FA314R*		MD6275D*
14	Sportsman 800 EFI	2005-2006			FA314R		MD6201D
15	Sportsman 800 EFI	2008			FA314R		MD6275D
16	Sportsman 800 EFI	2009			FA314R		MD6275D
17	Sportsman 800 EFI	2010-2013			FA475R		MD6275D
18	Sportsman 800 EFI Intl/HO	2007-2011			FA314R		MD6275D
19	Sportsman 800 EFI Touring	2008-2009	FA159X*		FA159R*		MD6275D
20	Sportsman 800 Forest	2012	FA475X		FA475R		MD6339D
21	Sportsman 800 X2 EFI	2007-2009	FA159X*		FA159R*		MD6275D*
22	Sportsman 800	2012-2014	FA475X		FA475R		MD6339D
23	Forest 850	2015	FA475X*		FA475R*		MD6339D*
24	Scrambler 850 XP HO	2013-2015	FA475X		FA475R		MD6339D
25	Scrambler 850	2015	FA475X*		FA475R*		MD6339D*
26	Sportsman 850 Forest	2012	FA475X		FA475R		MD6339D
27	Sportsman 850 Touring EPS	2010-2013	FA475X		FA475R		MD6339D
28	Sportsman 850 Touring H.O. EPS	2013-2015	FA475X		FA475R		MD6339D
29	Sportsman 850 XP	2009-2013	FA475X		FA475R		MD6339D
30	Sportsman 850 XP EPS	2009-2013	FA475X		FA475R		MD6339D
31	Sportsman 850 XP H.O. EPS	2013-2015	FA475X		FA475R		MD6339D
32	Sportsman 850 A22SXA85A1	2022-2023	FA475X		FA475R		MD6339D
33	Forest 1000	2015	FA475X*		FA475R*		MD6339D*
34	Scrambler 1000 1000	2015	FA475X*		FA475R*		MD6339D*
35	Scrambler 1000 XP	2015	FA475X*		FA475R*		MD6339D*
36	Scrambler 1000 XP	2015-2021	FA456X*		FA456R*		MD6339D*
37	Sportsman 1000 MD/XP	2015-2019	FA475X*		FA475R*		MD6339D*
38	Sportsman 1000 Touring Tractor	2016-2022	FA475X*		FA475R*		MD6339D*
39	Sportsman 1000 Touring XP	2015-2020	FA475X*		FA475R*		MD6339D*
40	Sportsman 1000 XP High Lifter	2019	FA475X*		FA475R*		MD6339D*
41	Sportsman 1000 XP S 55	2020-2021	FA456X*		FA456R*		MD6338D*
42	Sportsman 1000 XP Tractor	2016-2021	FA475X*		FA475R*		MD6338D*
43	Sportsman 1000 XP	2022-2023	FA475X*		FA475R*		MD6339D*
44	POLARIS UTV						
45							
46	250 2 x 4 / 4 x 4	1993	FA232X		FA232R		
47	325 Ranger ETX	2015-2016			FA354R*		MD6275D*
48	400 Ranger	2010-2014			FA354R*		MD6275D*
49	499 Ranger	2017			FA354R*		MD6201D
50	499 Ranger	2017	Left				MD6275D
51	500 Ranger	2017-2020			FA354R*		MD6275D*
52	500 Ranger	2021-2022			FA354R*		MD6275D*
53	500 Ranger 2 x 4/4 x 4	2006-2007			FA354R*		MD6275D*
54	500 Ranger 4 x 4 EFI	2006-2007			FA354R*		MD6275D*
55	500 Ranger 4 x 4 EFI	2008-2010			FA354R*		MD6275D*

* symbol after part# = 2 pieces required i.e. 2 pad sets or 2 rotors (twin rotor models)

Part numbers, prefixes, suffixes, photos and illustrations shown in this catalog are trademarks and/or copyrights of EBC Brakes or the trademark owner A C Freeman Investments Ltd and use without express written permission of the owners is punishable by law.

BRAKE
APPLICATIONS

All names & numbers are for reference purposes only. © Registered trademarks of Harley—Davidson® Motor Corp or Buell.

NOTE: — Some models may have a second rotor fitted as an optional extra. Please double check with your customer exactly which side the front rotor is fitted and if twin rotor or single.

☼ This symbol indicates a rotor made of billet steel, and should be only used with EBC FA Organic or Vee pads.

REAR: AMERICAN PRODUCED MOTORCYCLES



Line #

POLARIS UTV

SUFFIX OR PREFIX
PAD MATERIALS AND DESCRIPTION

YEAR

REAR						
PADS	PADS	PADS	PADS	REAR ROTOR OPTIONS		
FA	V	HH	EPFA	DESIGN NO.		
Organic Pads	Semi-Sintered V-Pads™	Double-H™ USA-Made Sintered Pads	Premium Low Noise Street Sintered Pads	See Buyers Guide for rotor style & finish options. Part nos for ordering & sizing.		
1	500 Ranger 4 x 4 EFI	2011-2013		FA354R*	MD6275D*	
2	500 Ranger Carb 2 x 4	2008-2009		FA354R*	MD6275D*	
3	500 Ranger Crew	2011-2013		FA354R*	MD6275D*	
4	500 Ranger EFI 4 x 4 H.O.	2009-2011		FA354R*	MD6275D*	
5	570 Ace EFI EURO R09	2017-2020		FA354R*	MD6201D*	
6	570 Ace R08 All models	2017-2020		FA354R*	MD6201D*	
7	570 FS Ranger Crew R17RD R08	2016-2020	FA656X*	FA656R*	MD6275D*	
8	570 Ranger	2017-2020		FA354R*	MD6275D*	
9	570 Ranger Crew EFI	2014-2015		FA354R*	MD6275D*	
10	570 Ranger Crew Efi R17RN R10	2017-2020	FA656X*	FA656R*	MD6275D*	
11	570 Ranger Crew EPS MD R18RN R04	2018-2020	FA656X*	FA656R*	MD6275D*	
12	570 Ranger Crew R18RNA R03	2018-2020	FA656X*	FA656R*	MD6275D*	
13	570 Ranger Crew R19RNA R02	2016-2023	FA656X*	FA656R*	MD6275D*	
14	570 Ranger EFi	2014-2020		FA354R*	MD6275D*	
15	570 Ranger Full Size R21	2021-2023	FA656X*	FA656R*	MD6275D*	
16	570 Ranger R16	2016		FA354R*	MD6275D*	
17	570 Ranger R18R FULL SIZE R06	2018-2020		FA354R*	MD6275D*	
18	570 Ranger R18R FULL SIZE R06	2019-2020		FA354R*	MD6275D*	
19	570 Ranger SP	2022		FA354R*	MD6275D*	
20	570 Ranger SP North Star Edition	2022		FA354R*	MD6275D*	
21	700 Ranger 4 x 4 EFI	2009		FA354R*	MD6275D*	
22	700 Ranger 4 x 4 EFI/LE	2007		FA354R*	MD6275D*	
23	700 Ranger 6 x 4 EFI	2008		FA354R*	MD6275D*	
24	700 Ranger 6 x 6 EFI	2006-2009		FA354R*	MD6275D*	
25	700 Ranger Crew EFI 4 x 4	2009	FA452X*	FA452R*	MD6275D*	
26	700 Ranger XP 4 x 4	2006		FA354R*	MD6275D*	
27	700 Ranger XP 4 x 4	2008		FA354R*	MD6275D*	
28	800 Ranger	2010-2012		FA354R*	MD6275D*	
29	800 Ranger 6 x 6	2010-2017	FA452X*	SXR452HH*	FA452R*	MD6275D*
30	800 Ranger 6X6 17RAA MD Poland R02	2017-2020		FA656R*	MD6275D*	
31	800 Ranger Crew	2010-2014		SXR354HH*	FA354R*	MD6275D*
32	800 Ranger EFi	2013-2014		FA354R*	MD6275D*	
33	800 Ranger Mid Size	2013-2014		FA354R*	MD6275D*	
34	800 Ranger XP	2010-2012	FA452X*	FA452R*	MD6275D*	
35	900 D Crew Ranger Diesel	2013-2014	FA452X*	FA452R*	MD6275D*	
36	900 D Ranger Diesel	2011-2014		FA354R*	MD6275D*	
37	900 Ranger Crew	2010-2015	FA452X*	FA452R*	MD6275D*	
38	900 RANGER CREW 6P SP	2017				
39	900 RANGER CREW EPS	2019				
40	900 RANGER CREW XP 6P SP	2018				
41	900 Ranger R18RV	2016-2019	FA452X*	SXR452HH*	FA452R*	MD6275D*
42	900 Ranger XP	2013-2014		FA354R*	MD6275D*	
43	900 Ranger XP R27	2015-2019		FA354R*	MD6275D*	
44	902 Ranger EU Tractor R07	2019-2020	FA456X*	FA456R*	MD6338D*	
45	1000 Ranger Crew Diesel	2017-2018	FA656X*		MD6275D*	
46	1000 Ranger Crew Factory Choice 49/50S	2018-2020	FA456X*	FA456R*	MD6275D*	
47	1000 Ranger Crew Mud XP PS NSTR	2018-2020	FA456X*	FA456R*	MD6275D*	
48	1000 Ranger Crew PS	2018-2020	FA452X*	FA452R*	MD6275D*	
49	1000 Ranger Crew PS EPS HD	2018-2020	FA456X*	FA456R*	MD6275D*	
50	1000 Ranger Crew XP 6P PS NB	2017	FA452X*	FA452R*	MD6275D*	
51	1000 Ranger Crew XP PS	2017	FA452X*	FA452R*	MD6275D*	
52	1000 Ranger EPS	2022-2023	FA452X*	FA452R*	MD6275D*	
53	1000 Ranger Diesel	2015-2020		FA354R*	MD6275D*	
54	1000 Ranger Diesel	2017	FA656X*		MD6275D*	
55	1000 Ranger Diesel	2018	FA656X*		MD6275D*	

* symbol after part# = 2 pieces required i.e. 2 pad sets or 2 rotors (twin rotor models)

Part numbers, prefixes, suffixes, photos and illustrations shown in this catalog are trademarks and/or copyrights of EBC Brakes or the trademark owner A C Freeman Investments Ltd and use without express written permission of the owners is punishable by law.

BRAKE APPLICATIONS

All names & numbers are for reference purposes only. © Registered trademarks of Harley—Davidson® Motor Corp or Buell.

NOTE: — Some models may have a second rotor fitted as an optional extra. Please double check with your customer exactly which side the front rotor is fitted and if twin rotor or single.

☼ This symbol indicates a rotor made of billet steel, and should be only used with EBC FA Organic or Vee pads.

FRONT: AMERICAN PRODUCED MOTORCYCLES

APPLICATIONS
BRAKE



POLARIS UTV

SUFFIX OR PREFIX
PAD MATERIALS AND DESCRIPTION

YEAR

					FRONT				
					PADS	PADS	PADS	PADS	FRONT ROTOR OPTIONS
					FA	V	HH	EPFA	DESIGN NO.
					Organic Pads	Semi-Sintered V-Pads™	Double-HT™ USA-Made Sintered Pads	Premium Low Noise Street Sintered Pads	See Buyers Guide for rotor style & finish options. Part nos for ordering & sizing.
1000 Ranger Diesel Crew				2015	FA452X*		FA452R*		MD6338D*
1000 Ranger Diesel EU				2017	FA656X*		FA656R*		MD6338D*
1000 Ranger Diesel Poland				2017-2018	FA656X*		FA656R*		MD6338D*
1000 Ranger Crew XP PS				2017	FA656X*		FA656R*		MD6338D*
1000 Ranger XP				2022-2023	FA656X*		FA656R*		MD6338D*
1000 Ranger XP Crew PS				2018-2023	FA656X*		FA656R*		MD6338D*
1000 Ranger Crew Premium				2022-2023	FA656X*		FA656R*		MD6338D*
1000 Ranger Crew XP Premium				2022-2023	FA656X*		FA656R*		MD6338D*
1000 Ranger Crew XP NorthStar Edition Premium				2023	FA656X*		FA656R*		MD6338D*
Brutus HD HDPTO				2013-2017	FA452X*		FA452R*		MD6338D*
General 1000 4 Deluxe Ride Command Edition				2021-2022	FA656X*		FA656R*		MD6338D*
General 1000 4 EPS				2017-2020	FA452X*		FA452R*		MD6380D*
General 1000 4 Premium				2021-2022	FA656X*		FA656R*		MD6380D*
General 1000 Deluxe				2021-2022	FA656X*		FA656R*		MD6380D*
General 1000 Deluxe Ride Command Edition				2021-2022	FA656X*		FA656R*		MD6380D*
General 1000 EPS				2016-2020	FA452X*		FA452R*		MD6380D*
General 1000 EPS				2017-2020	FA452X*		FA452R*		MD6380D*
General 1000 Premium				2021-2022	FA656X*		FA656R*		MD6380D*
General 1000 Sport				2021-2023	FA656X*		FA656R*		MD6380D*
General 1000 XP 4 Deluxe				2021-2022			FA680R*		MD6380D*
General 1000 XP 4 Deluxe Ride Command Edition				2021-2022			FA680R*		MD6380D*
General 1000 XP 4 Trailhead Edition				2021-2022			FA680R*		MD6380D*
General 1000 XP Deluxe				2021-2022	FA656X*		FA656R*		MD6380D*
General 1000 XP Deluxe Ride Command Edition				2021-2022	FA656X*		FA656R*		MD6380D*
General 1000 XP Trailhead Edition		Left		2021-2022	FA656X*	SXR656HH*	FA656R*		MD6380D*
		Right			FA656X*				
General 1000 XP Premium				2023-2024	FA656X*	SXR656HH*	FA656R*		MD6380D*
General 1000 XP Sport				2023-2024	FA656X*	SXR656HH*	FA656R*		MD6380D*
General 1000 XP Ultimate				2023-2024	FA656X*	SXR656HH*	FA656R*		MD6380D*
General 1000 XP 4 Premium				2023-2024		SXR680HH*	FA680R*		MD6380D*
General 1000 XP 4 Sport				2023-2024		SXR680HH*	FA680R*		MD6380D*
General 1000 XP 4 Ultimate				2023-2024			FA680R*		MD6380D*
MILITARY RZR2 XP MV 1000 TURBO DIESEL R01				2017	FA656X*		FA656R*		
MILITARY RZR2 XP MV 1000 TURBO DIESEL NELO R01				2018	FA656X*		FA656R*		
MILITARY RZR4 XP MV 1000 TURBO DIESEL R04				2017	FA656X*		FA656R*		
PPS LUH 6 x 6				2002	FA159X*		FA159R*		MD6149D*
Ranger TM 653				2006			FA354R*		MD6202D*
Ranger 2 x 4 / 4 x 4				2004-2005			FA354R		MD6202D*
Ranger 1999 models				1999	FA159X*		FA159R*		MD6149D*
Ranger 6 x 6				2004-2005			FA354R*		MD6202D*
Ranger TM				2004-2005			FA354R*		MD6202D*
Ranger Various Models 05-16				2005-2016					
Ranger XP 700				2005			FA354R*		MD6202D*
Ranger EV Electric				2010-2015	FA452X*		FA452R*		MD6202D*
Ranger EV Electric				2016-2017	FA656X*		FA656R*		MD6202D*
Ranger EV Electric				2016-2018	FA656X*		FA656R*		MD6202D*
Ranger EV LIION Electric				2016-2018	FA656X*		FA656R*		MD6202D*
Ranger EV LIION Electric				2016-2018	FA656X*		FA656R*		MD6202D*
Ranger EV MD Electric				2018-2023	FA656X*		FA656R*		MD6202D*
RZR 170				2009-2015			FA490R*		MD6353D*
RZR 200				2021-2022			FA490R*		MD6353D*
250 2 x 4 / 4 x 4				1990	FA159X*		FA159R*		MD6149D*
RZR 570 Trail				2020-2021	FA456X*		FA456R*		MD6338D*
RZR 570 Trail				2020-2021	FA456X*		FA456R*		MD6338D*
RZR 570 Trail Premium				2020-2021	FA456X*		FA456R*		MD6338D*

Line #

* This symbol indicates a rotor made of billet steel, and should be only used with EBC FA Organic or Vee pads.

* symbol after part# = 2 pieces required i.e. 2 pad sets or 2 rotors (twin rotor models)

Part numbers, prefixes, suffixes, photos and illustrations shown in this catalog are trademarks and/or copyrights of EBC Brakes or the trademark owner A C Freeman Investments Ltd and use without express written permission of the owners is punishable by law.

FRONT: AMERICAN PRODUCED MOTORCYCLES

APPLICATIONS
BRAKE



POLARIS UTV

SUFFIX OR PREFIX
PAD MATERIALS AND DESCRIPTION

YEAR

FRONT						
PADS	PADS	PADS	PADS	FRONT ROTOR OPTIONS		
FA	V	HH	EPFA	DESIGN NO.		
Organic Pads	Semi-Sintered V-Pads™	Double-HT™ USA-Made Sintered Pads	Premium Low Noise Street Sintered Pads	See Buyers Guide for rotor style & finish options. Part nos for ordering & sizing.		
RZR 570 Trail S	2020-2021	FA456X*		FA456R*	MD6338D*	1
RZR 570	2012-2013	FA456X*		FA456R*	MD6312D*	2
RZR 570	2014-2019	FA456X*		FA456R*	MD6338D*	3
570 Ranger SP	2022-2023			FA354R*	MD6202D*	4
RZR 800 EPS	2008-2014	FA456X*		FA456R*	MD6312D*	5
RZR-4 800 EPS	2012	FA452X*		FA452R*	MD6338D*	6
RZR 900 4 XP	2012-2016	FA656X*		FA656R*	MD6338D*	7
RZR 900 XP	2011-2014	FA656X*		FA656R*	MD6338D*	8
RZR 900	2015-2020	FA657X*		FA657R*	MD6338D*	9
RZR-S 900	2015-2020	FA657X*		FA657R*	MD6338D*	10
RZR 900 Trail	2021-2023	FA656X*		FA656R*	MD6338D*	11
RZR 900 Trail S	2021-2023	FA656X*		FA656R*	MD6338D*	12
RZR 4 900	2016-2018	FA656X*		FA656R*	MD6338D*	13
RZR 4 900	2017	FA656X*		FA656R*	MD6338D*	14
RZR 1000 RS1	2018-2023	FA656X*		FA656R*	MD6380D*	15
RZR 1000 XP 4	2016-2017	FA656X*		FA656R*	MD6380D*	16
RZR 1000 XP 4	2018	FA656X*		FA656R*	MD6380D*	17
RZR 1000 4 XP High Lifter	2021-2022	FA656X*		FA656R*	MD6380D*	18
RZR 1000 S 4 Turbo	2021-2022			FA728R*	MD6380D*	19
RZR 1000 S 4 Velocity Turbo	2021-2022			FA728R*	MD6380D*	20
RZR 1000 Turbo S	2019-2022			FA728R*	MD6380D*	21
RZR 1000 Turbo S Velocity	2019-2022			FA728R*	MD6380D*	22
RZR 1000 XP	2012-2019	FA656X*		FA656R*	MD6380D*	23
RZR 1000 XP	2016-2017	FA452X*		FA452R*	MD6380D*	24
RZR 1000 XP 4 Turbo	2016			FA680R*	MD6397D*	25
RZR 1000 XP 4 Turbo	2017-2022	FA680X*		FA680R*	MD6380D*	26
RZR 1000 XP 4 Turbo	2019-2020	FA680X*		FA680R*	MD6397D*	27
RZR 1000 XP 4 Turbo Intl	2017	FA680X*		FA680R*	MD6380D*	28
RZR 1000 XP High Lifter	2021-2022	FA656X*		FA656R*	MD6380D*	29
RZR 1000 XP Premium	2021-2022	FA656X*		FA656R*	MD6380D*	30
RZR 1000 XP Sport	2021-2022	FA656X*		FA656R*	MD6380D*	31
RZR 1000 XP Turbo	2016			FA680R*	MD6397D*	32
RZR 1000 XP Turbo	2017-2020	FA680X*		FA680R*	MD6380D*	33
RZR 1000 XP Turbo Latin	2018	FA680X*		FA680R*	MD6380D*	34
RZR 1000 XP Turbo MD	2018-2020	FA680X*		FA680R*	MD6380D*	35
RZR 1000 XP Turbo MD	2017-2018	FA680X*		FA680R*	MD6380D*	36
RZR 1000 XP Turbo S	2018-2020	FA680X*		FA680R*	MD6380D*	37
RZR 1000 XP Turbo Tractor	2017-2018	FA680X*		FA680R*	MD6380D*	38
RZR 1000 Z19VCE99AM	2018-2020	FA656X*		FA656R*	MD6380D*	39
RZR 1000 XP 4	2019-2020	FA656X*		FA656R*	MD6380D*	40
RZR 1000 XP 4 MD	2017	FA656X*		FA656R*	MD6380D*	41
RZR 1000 XP 4 MD	2018-2019	FA656X*		FA656R*	MD6380D*	42
RZR 1000 60" Inch PS EU/Tractor/Zug R01/R06/R07/R09	2017-2020	FA657X*		FA657R*	MD6338D*	43
RZR 1000 Pro XP Turbo	2020-2021	FA680X*		FA680R*	MD6380D*	44
RZR 1000 Pro XP 4 Premium Turbo	2021-2024	FA680X*		FA680R*	MD6380D*	45
RZR 1000 Pro XP 4 Sport Turbo	2021-2024	FA680X*		FA680R*	MD6380D*	46
RZR 1000 Pro XP 4 Ultimate Turbo	2021-2024	FA680X*		FA680R*	MD6380D*	47
RZR 1000 Pro XP Premium Turbo	2021-2024	FA680X*		FA680R*	MD6380D*	48
RZR 1000 Pro XP Sport Turbo	2021-2024	FA680X*		FA680R*	MD6380D*	49
RZR 1000 Pro XP Ultimate Turbo	2021-2024	FA680X*		FA680R*	MD6380D*	50
RZR 1000 Pro R	2022-2024	FA680X*		FA680R*	MD6380D*	51
RZR 1000 Pro XP	2022-2024	FA680X*		FA680R*	MD6380D*	52
RZR 1000 Turbo R	2022-2024			FA728R*	MD6380D*	53
						54
						55

* This symbol indicates a rotor made of billet steel, and should be only used with EBC FA Organic or Vee pads.

* symbol after part# = 2 pieces required i.e. 2 pad sets or 2 rotors (twin rotor models)

Part numbers, prefixes, suffixes, photos and illustrations shown in this catalog are trademarks and/or copyrights of EBC Brakes or the trademark owner A C Freeman Investments Ltd and use without express written permission of the owners is punishable by law.

REAR: AMERICAN PRODUCED MOTORCYCLES



Line #

POLARIS UTV

SUFFIX OR PREFIX
PAD MATERIALS AND DESCRIPTION

YEAR

		REAR				REAR ROTOR OPTIONS
		PADS	PADS	PADS	PADS	DESIGN NO.
		FA	V	HH	EPFA	DESIGN NO.
		Organic Pads	Semi-Sintered V-Pads™	Double-HT™ USA-Made Sintered Pads	Premium Low Noise Street Sintered Pads	See Buyers Guide for rotor style & finish options. Part nos for ordering & sizing.
1	RZR 570 Trail S	2020-2021	FA475X*		FA475R*	MD6275D*
2	RZR 570	2012-2013	FA159X*	SXR159HH*	FA159R*	MD6275D*
3	RZR 570	2014-2019	FA456X*		FA456R*	MD6275D*
4	570 Ranger SP	2022-2023			FA354R*	MD6275D*
5	RZR 800 EPS	2008-2014	FA159X*		FA159R*	MD6275D*
6	RZR-4 800 EPS	2012			FA354R*	MD6275D*
7	RZR 900 4 XP	2012-2016	FA656X*		FA656R*	MD6374D*
8	RZR 900 XP	2011-2014			FA354R*	MD6374D*
9	RZR 900	2015-2020	FA456X*		FA456R*	MD6338D*
10	RZR-S 900	2015-2020	FA456X*		FA456R*	MD6338D*
11	RZR 900 Trail	2021-2023	FA456X*		FA456R*	
12	RZR 900 Trail S	2021-2023	FA456X*		FA456R*	
13	RZR 4 900	2016-2018	FA456X*		FA456R*	
14	RZR 4 900	2017	FA656X*		FA656R*	MD6374D*
15	RZR 1000 RS1	2018-2022	FA656X*	SXR656HH*	FA656R*	MD6380D*
16	RZR 1000 XP 4	2016-2017	FA656X*	SXR656HH*	FA656R*	MD6380D*
17	RZR 1000 XP 4	2018	FA656X*	SXR656HH*	FA656R*	MD6380D*
18	RZR 1000 4 XP High Lifter	2021-2022	FA656X*		FA656R*	MD6380D*
19	RZR 1000 S 4 Turbo	2021-2022	FA656X*	SXR656HH*	FA656R*	MD6397D*
20	RZR 1000 S 4 Velocity Turbo	2021-2022	FA656X*	SXR656HH*	FA656R*	MD6397D*
21	RZR 1000 Turbo S	2019-2022				MD6397D*
22	RZR 1000 Turbo S Velocity	2019-2022				MD6397D*
23	RZR 1000 XP	2012-2019	FA656X*		FA656R*	MD6380D*
24	RZR 1000 XP	2016-2017	FA452X*		FA452R*	MD6380D*
25	RZR 1000 XP 4 Turbo	2016	FA656X*	SXR656HH*	FA656R*	MD6397D*
26	RZR 1000 XP 4 Turbo	2017-2022	FA656X*	SXR656HH*	FA656R*	MD6397D*
27	RZR 1000 XP 4 Turbo	2019-2020	FA656X*	SXR656HH*	FA656R*	MD6397D*
28	RZR 1000 XP 4 Turbo Intl	2017	FA656X*	SXR656HH*	FA656R*	MD6397D*
29	RZR 1000 XP High Lifter	2021-2022	FA656X*		FA656R*	MD6380D*
30	RZR 1000 XP Premium	2021-2022	FA656X*		FA656R*	MD6380D*
31	RZR 1000 XP Sport	2021-2022	FA656X*		FA656R*	MD6380D*
32	RZR 1000 XP Turbo	2016	FA656X*	SXR656HH*	FA656R*	MD6397D*
33	RZR 1000 XP Turbo	2017-2020	FA656X*	SXR656HH*	FA656R*	MD6397D*
34	RZR 1000 XP Turbo Latin	2018	FA656X*	SXR656HH*	FA656R*	MD6397D*
35	RZR 1000 XP Turbo MD	2018-2020	FA656X*	SXR656HH*	FA656R*	MD6397D*
36	RZR 1000 XP Turbo MD	2017-2018	FA656X*	SXR656HH*	FA656R*	MD6397D*
37	RZR 1000 XP Turbo S	2018-2020	FA656X*	SXR656HH*	FA656R*	MD6397D*
38	RZR 1000 XP Turbo Tractor	2017-2018	FA656X*	SXR656HH*	FA656R*	MD6397D*
39	RZR 1000 Z19VCE99AM	2018-2020	FA456X*		FA456R*	MD6338D*
40	RZR 1000 XP 4	2019-2020	FA656X*	SXR656HH*	FA656R*	MD6380D*
41	RZR 1000 XP 4 MD	2017	FA656X*	SXR656HH*	FA656R*	MD6380D*
42	RZR 1000 XP 4 MD	2018-2019	FA656X*	SXR656HH*	FA656R*	MD6380D*
43	RZR 1000 60" Inch PS EU/Tractor/Zug R01/R06/R07/R09	2017-2020	FA456X*		FA456R*	MD6338D*
44	RZR 1000 Pro XP Turbo	2020-2021	TBC*	TBC*	TBC*	MD6397D*
45	RZR 1000 Pro XP 4 Premium Turbo	2021-2022	TBC*	TBC*	TBC*	MD6397D*
46	RZR 1000 Pro XP 4 Sport Turbo	2021-2022	TBC*	TBC*	TBC*	MD6397D*
47	RZR 1000 Pro XP 4 Ultimate Turbo	2021-2022	TBC*	TBC*	TBC*	MD6397D*
48	RZR 1000 Pro XP Premium Turbo	2021-2022	TBC*	TBC*	TBC*	MD6397D*
49	RZR 1000 Pro XP Sport Turbo	2021-2022	TBC*	TBC*	TBC*	MD6397D*
50	RZR 1000 Pro XP Ultimate Turbo	2021-2022	TBC*	TBC*	TBC*	MD6397D*
51	RZR 1000 Pro R	2022-2023	TBC*	TBC*	TBC*	MD6397D*
52	RZR 1000 Pro XP	2022-2023	TBC*	TBC*	TBC*	MD6397D*
53	RZR 1000 Turbo R	2022-2023	FA656X*	SXR656HH*	FA656R*	MD6397D*
54						
55						

* symbol after part# = 2 pieces required i.e. 2 pad sets or 2 rotors (twin rotor models)

Part numbers, prefixes, suffixes, photos and illustrations shown in this catalog are trademarks and/or copyrights of EBC Brakes or the trademark owner A C Freeman Investments Ltd and use without express written permission of the owners is punishable by law.

BRAKE APPLICATIONS

All names & numbers are for reference purposes only. © Registered trademarks of Harley—Davidson® Motor Corp or Buell.

NOTE: — Some models may have a second rotor fitted as an optional extra. Please double check with your customer exactly which side the front rotor is fitted and if twin rotor or single.

⊗ This symbol indicates a rotor made of billet steel, and should be only used with EBC FA Organic or Vee pads.

FRONT: AMERICAN PRODUCED MOTORCYCLES

APPLICATIONS
BRAKE



SUFFIX OR PREFIX
PAD MATERIALS AND DESCRIPTION

YEAR	FRONT					FRONT ROTOR OPTIONS DESIGN NO.
	PADS	PADS	PADS	PADS		
	FA	V	HH	EPFA		
	Organic Pads	Semi-Sintered V-Pads™	Double-H™ USA-Made Sintered Pads	Premium Low Noise Street Sintered Pads		See Buyers Guide for rotor style & finish options. Part nos for ordering & sizing.
POLARIS SLINGSHOT						
Sport Pad and Sport Rotor Options shown on page 71						
S 2.0L	2018-2022	FA669/4*				MD533*
All SL Models 2.0L	2019-2021	FA669/4*				TBC*
Base 2.0L	2015-2017	FA669/4*				MD533*
SL LE 2.0L	2015-2023	FA669/4*				MD533*
SL 2.0L	2015-2023	FA669/4*				MD533*
SLR 2.0L	2017-2023	FA669/4*				TBC*
VICTORY						
Broadwalk	2013-2015			FA347HH	EPFA347HH	MD890BLK*
Cross Country 8-Ball	2015-2016			FA347HH*	EPFA347HH*	MD890BLK*
Cross Country Cory Ness Victory	2011-2012			FA347HH*	EPFA347HH*	MD890BLK*
Cross Country Touring	2013-2017			FA347HH*	EPFA347HH*	MD890BLK*
Cross Country	2010-2017			FA347HH*	EPFA347HH*	MD890BLK*
Cross Roads 8-Ball	2014-2015			FA347HH*	EPFA347HH*	MD890BLK*
Cross Roads Classic	2013-2014			FA347HH*	EPFA347HH*	MD890BLK*
Cross Roads	2010-2012			FA347HH*	EPFA347HH*	MD890BLK*
Deluxe Cruiser	2001-2002	FA244	FA244V	FA244HH	EPFA244HH	MD727
Empulse TT	2016	FA244*		FA244HH*	EPFA244HH*	MD890BLK*
Gunner	2015-2017			FA347HH	EPFA347HH	MD890BLK*
Hammer 8-Ball	2010-2015			FA347HH	EPFA347HH	MD678*
Hammer 8-Ball	2016			FA347HH*	EPFA347HH*	MD890BLK*
Hammer S	2007	FA244*		FA244HH*	EPFA244HH*	MD678*
Hammer S	2008-2017			FA347HH*	EPFA347HH*	MD890BLK*
Hammer	2005-2007	FA244*		FA244HH*	EPFA244HH*	MD678*
Hammer	2008-2011			FA347HH*	EPFA347HH*	MD890BLK*
Hard Ball	2012-2013			FA347HH*	EPFA347HH*	MD678*
High Ball	2012-2017			FA347HH	EPFA347HH	MD890BLK*
Jackpot Cory Ness	2008-2010			FA347HH	EPFA347HH	MD678
Jackpot	2007-2010			FA347HH	EPFA347HH	MD678
Jackpot	2011-2016			FA347HH	EPFA347HH	MD890BLK
Judge	2013-2017			FA347HH	EPFA347HH	MD890BLK
King Pin 8-Ball	2008-2011			FA347HH	EPFA347HH	MD678
King Pin Low	2009			FA347HH	EPFA347HH	MD890BLK
King Pin Tour	2004-2007	FA244	FA244V	FA244HH	EPFA244HH	MD678
King Pin Tour	2008-2009			FA347HH	EPFA347HH	MD890BLK
King Pin	2004-2007	FA244	FA244V	FA244HH	EPFA244HH	MD678
King Pin	2008-2012			FA347HH	EPFA347HH	MD890BLK
Magnum X-1	2015-2017			FA347HH*	EPFA347HH*	MD890BLK
Magnum	2015-2017			FA347HH*	EPFA347HH*	MD890BLK
Ness Signature Series	2005-2007	FA244	FA244V	FA244HH	EPFA244HH	MD678
Octane 1200	2017	FA209/2	FA209/2V	FA209/2HH	EPFA209/2HH	MD534
Special Edition	2000	FA244	FA244V	FA244HH	EPFA244HH	MD727
Sport Cruiser	2000-2001	FA244*		FA244HH*	EPFA244HH*	MD727*
Standard Cruiser	1998-2000	FA244	FA244V	FA244HH	EPFA244HH	MD727
Standard Cruiser	2001-2002	FA244	FA244V	FA244HH	EPFA244HH	MD727
Touring Cruiser	2003-2006	FA244*		FA244HH*	EPFA244HH*	MD727*
Vegas 8-Ball	2005-2007	FA244	FA244V	FA244HH	EPFA244HH	MD678
Vegas 8-Ball	2008-2010			FA347HH	EPFA347HH	MD678
Vegas 8-Ball	2011-2017			FA347HH	EPFA347HH	MD678
Vegas Jackpot	2006-2007	FA244	FA244V	FA244HH	EPFA244HH	MD678
Vegas Jackpot	2008-2012			FA347HH	EPFA347HH	MD678
Vegas Jackpot	2013-2014			FA347HH	EPFA347HH	MD678
Vegas Low	2008-2009			FA347HH	EPFA347HH	MD678

* This symbol indicates a rotor made of billet steel, and should be only used with EBC FA Organic or Vee pads.

Line #
1
2
3
4
5
6
7
8
9
10
11
12
13
14
15
16
17
18
19
20
21
22
23
24
25
26
27
28
29
30
31
32
33
34
35
36
37
38
39
40
41
42
43
44
45
46
47
48
49
50
51
52
53
54
55

* symbol after part# = 2 pieces required i.e. 2 pad sets or 2 rotors (twin rotor models)

Part numbers, prefixes, suffixes, photos and illustrations shown in this catalog are trademarks and/or copyrights of EBC Brakes or the trademark owner A C Freeman Investments Ltd and use without express written permission of the owners is punishable by law.

REAR: AMERICAN PRODUCED MOTORCYCLES



SUFFIX OR PREFIX
PAD MATERIALS AND DESCRIPTION

YEAR

REAR

PADS	PADS	PADS	PADS	REAR ROTOR OPTIONS
FA	V	HH	EPFA	DESIGN NO.
Organic Pads	Semi-Sintered V-Pads™	Double-H™ USA-Made Sintered Pads	Premium Low Noise Street Sintered Pads	See Buyers Guide for rotor style & finish options. Part nos for ordering & sizing.

Line #

POLARIS SLINGSHOT

Sport Pad and Sport Rotor Options shown on page 71

3	S 2.0L	2018-2022	FA670				MD533
4	All SL Models 2.0L	2019-2021	FA670				TBC
5	Base 2.0L	2015-2017	FA670				MD533
6	SL LE 2.0L	2015-2023	FA670				MD533
7	SL 2.0L	2015-2023	FA670				MD533
8	SLR 2.0L	2017-2023	FA670				TBC

VICTORY

11	Broadwalk	2013-2015	FA196	FA196V	FA196HH	EPFA196HH	MD887BLK
12	Cross Country 8-Ball	2015-2016	FA196	FA196V	FA196HH	EPFA196HH	MD887BLK
13	Cross Country Cory Ness Victory	2011-2012	FA196	FA196V	FA196HH	EPFA196HH	MD887BLK
14	Cross Country Touring	2013-2017	FA196	FA196V	FA196HH	EPFA196HH	MD887BLK
15	Cross Country	2010-2017	FA196	FA196V	FA196HH	EPFA196HH	MD887BLK
16	Cross Roads 8-Ball	2014-2015	FA196	FA196V	FA196HH	EPFA196HH	MD887BLK
17	Cross Roads Classic	2013-2014	FA196	FA196V	FA196HH	EPFA196HH	MD887BLK
18	Cross Roads	2010-2012	FA196	FA196V	FA196HH	EPFA196HH	MD887BLK
19	Deluxe Cruiser	2001-2002	FA209/2	FA209/2V	FA209/2HH	EPFA209/2HH	MD727
20	Empulse TT	2016	FA266	FA266V	FA266HH	EPFA266HH	MD887BLK
21	Gunner	2015-2017	FA196	FA196V	FA196HH	EPFA196HH	MD890BLK
22	Hammer 8-Ball	2010-2015	FA196	FA196V	FA196HH	EPFA196HH	MD890BLK
23	Hammer 8-Ball	2016	FA196	FA196V	FA196HH	EPFA196HH	MD890BLK
24	Hammer S	2007	FA209/2	FA209/2V	FA209/2HH	EPFA209/2HH	MD678
25	Hammer S	2008-2017	FA196	FA196V	FA196HH	EPFA196HH	MD890BLK
26	Hammer	2005-2007	FA209/2	FA209/2V	FA209/2HH	EPFA209/2HH	MD678
27	Hammer	2008-2011	FA196	FA196V	FA196HH	EPFA196HH	MD890BLK
28	Hard Ball	2012-2013	FA196	FA196V	FA196HH	EPFA196HH	MD887BLK
29	High Ball	2012-2017	FA196	FA196V	FA196HH	EPFA196HH	MD890BLK
30	Jackpot Cory Ness	2008-2010	FA196	FA196V	FA196HH	EPFA196HH	MD890BLK
31	Jackpot	2007-2010	FA196	FA196V	FA196HH	EPFA196HH	MD678
32	Jackpot	2011-2016	FA196	FA196V	FA196HH	EPFA196HH	MD890BLK
33	Judge	2013-2017	FA196	FA196V	FA196HH	EPFA196HH	MD890BLK
34	King Pin 8-Ball	2008-2011	FA196	FA196V	FA196HH	EPFA196HH	MD890BLK
35	King Pin Low	2009	FA196	FA196V	FA196HH	EPFA196HH	MD890BLK
36	King Pin Tour	2004-2007	FA209/2	FA209/2V	FA209/2HH	EPFA209/2HH	MD678
37	King Pin Tour	2008-2009	FA196	FA196V	FA196HH	EPFA196HH	MD890BLK
38	King Pin	2004-2007	FA209/2	FA209/2V	FA209/2HH	EPFA209/2HH	MD678
39	King Pin	2008-2012	FA196	FA196V	FA196HH	EPFA196HH	MD890BLK
40	Magnum X-1	2015-2017	FA196	FA196V	FA196HH	EPFA196HH	MD887BLK
41	Magnum	2015-2017	FA196	FA196V	FA196HH	EPFA196HH	MD887BLK
42	Ness Signature Series	2005-2007	FA209/2	FA209/2V	FA209/2HH	EPFA209/2HH	MD678
43	Octane 1200	2017	FA213	FA213V	FA213HH	EPFA213HH	MD534
44	Special Edition	2000	FA209/2	FA209/2V	FA209/2HH	EPFA209/2HH	MD727
45	Sport Cruiser	2000-2001	FA209/2	FA209/2V	FA209/2HH	EPFA209/2HH	MD727
46	Standard Cruiser	1998-2000	FA209/2	FA209/2V	FA209/2HH	EPFA209/2HH	MD727
47	Standard Cruiser	2001-2002	FA209/2	FA209/2V	FA209/2HH	EPFA209/2HH	MD727
48	Touring Cruiser	2003-2006	FA209/2	FA209/2V	FA209/2HH	EPFA209/2HH	MD727
49	Vegas 8-Ball	2005-2007	FA209/2	FA209/2V	FA209/2HH	EPFA209/2HH	MD678
50	Vegas 8-Ball	2008-2010	FA196	FA196V	FA196HH	EPFA196HH	MD678
51	Vegas 8-Ball	2011-2017	FA196	FA196V	FA196HH	EPFA196HH	MD678
52	Vegas Jackpot	2006-2007	FA209/2	FA209/2V	FA209/2HH	EPFA209/2HH	MD678
53	Vegas Jackpot	2008-2012	FA196	FA196V	FA196HH	EPFA196HH	MD678
54	Vegas Jackpot	2013-2014	FA196	FA196V	FA196HH	EPFA196HH	MD678
55	Vegas Low	2008-2009	FA196	FA196V	FA196HH	EPFA196HH	MD678

* symbol after part# = 2 pieces required i.e. 2 pad sets or 2 rotors (twin rotor models)

Part numbers, prefixes, suffixes, photos and illustrations shown in this catalog are trademarks and/or copyrights of EBC Brakes or the trademark owner A C Freeman Investments Ltd and use without express written permission of the owners is punishable by law.

All names & numbers are for reference purposes only. © Registered trademarks of Harley—Davidson® Motor Corp or Buell.

NOTE: — Some models may have a second rotor fitted as an optional extra. Please double check with your customer exactly which side the front rotor is fitted and if twin rotor or single.

☉ This symbol indicates a rotor made of billet steel, and should be only used with EBC FA Organic or Vee pads.

BRAKE APPLICATIONS

FRONT: AMERICAN PRODUCED MOTORCYCLES

APPLICATIONS
BRAKE



SUFFIX OR PREFIX
PAD MATERIALS AND DESCRIPTION

VICTORY

YEAR	SUFFIX OR PREFIX PAD MATERIALS AND DESCRIPTION	FA	V	HH	EPFA	FRONT ROTOR OPTIONS DESIGN NO.
2011	Vegas Zach Ness			FA347HH	EPFA347HH	MD678
2003-2007	Vegas	FA244	FA244V	FA244HH	EPFA244HH	MD678
2008-2012	Vegas			FA347HH	EPFA347HH	MD678
2016-2017	Vegas			FA347HH	EPFA347HH	MD678
2010-2011	Vision 8-Ball			FA261HH*	EPFA261HH*	MD678
2010-2012	Vision Arlen Ness Victory Vision			FA261HH*	EPFA261HH*	MD890BLK*
2008-2009	Vision Street			FA261HH*	EPFA261HH*	MD678
2008-2015	Vision Tour - All models			FA261HH*	EPFA261HH*	MD890BLK*

ZERO

2016-2019	DS ZF13.0	FA209/2		FA209/2HH		
2010-2012	DS ZF6.0/ZF9.0	FA264		FA264HH		
2019-2021	DS II ZF14.4	FA209/2		FA209/2HH		
2013	DS II ZF8.5/ZF11.4	FA185X		FA185R		
2014	DS II ZF8.5/ZF11.4	FA185X		FA185R		
2015	DS II ZF9.4/ZF12.5	FA209/2		FA209/2HH		
2017-2019	DSR ZF13.0	FA209/2		FA209/2HH		
2019-2022	DSR ZF14.4.0	FA209/2		FA209/2HH		
2019-2022	DSR ZF7.2	FA209/2		FA209/2HH		
2019-2021	FX Black Forest Edition - ZF14.4.0	FA209/2		FA209/2HH		
2013	FX ZF2.8/ZF5.7	FA185X		FA185R		
2014	FX ZF2.8/ZF5.7	FA185X		FA185R		
2015	FX ZF2.8/ZF5.7	FA181X		FA181R		
2016-2022	FX ZF3.3/ZF6.5	FA209/2		FA209/2HH		
2017-2021	FXS ZF3.3/ZF6.5	FA209/2		FA209/2HH		
2010-2012	MX R	FA264		FA264HH		
2019-2021	S ZF14.4	FA209/2		FA209/2HH		
2013	S ZF2.8/ZF5.7	FA185X		FA185R		
2010-2012	S ZF6.0	FA264		FA264HH		
2019-2022	S ZF7.2	FA209/2		FA209/2HH		
2013	S ZF8.5/ZF11.4	FA185X		FA185R		
2014	S ZF8.5/ZF11.4	FA185X		FA185R		
2015	S ZF9.4/ZF12.5	FA209/2		FA209/2HH		
2016-2019	S ZF9.8/ZF13.0	FA209/2		FA209/2HH		
2014	SR ZF11.4	FA185X		FA185R		
2015	SR ZF12.5	FA209/2		FA209/2HH		
2016-2022	SR ZF13.0	FA209/2		FA209/2HH		
2019-2022	SR/F ZF 14.4 kWh	FA244*		FA244HH*		MD669X*
2013	SR/F ZF2.8/ZF5.7	FA185X		FA185R		
2019-2022	SR/S ZF 14.4 kWh	FA244*		FA244HH*		MD669X*
2010-2012	XU R	FA264		FA264HH		
2010-2012	XU R	FA264		FA264HH		
2022-2023	DSR/X ZF75-10X 17.3.0 Adventure	FA244*		FA244HH*		
2022	FXE ZF7.2	FA209/2		FA209/2HH		

* This symbol indicates a rotor made of billet steel, and should be only used with EBC FA Organic or Vee pads.

Line #
1
2
3
4
5
6
7
8
9
10
11
12
13
14
15
16
17
18
19
20
21
22
23
24
25
26
27
28
29
30
31
32
33
34
35
36
37
38
39
40
41
42
43
44
45
46
47
48
49
50
51
52
53
54
55

* symbol after part# = 2 pieces required i.e. 2 pad sets or 2 rotors (twin rotor models)

Part numbers, prefixes, suffixes, photos and illustrations shown in this catalog are trademarks and/or copyrights of EBC Brakes or the trademark owner A C Freeman Investments Ltd and use without express written permission of the owners is punishable by law.

ROTOR GROUP NO. 001 - FRONT. CHOOSE YOUR PREFERRED STYLE:

Type	Solid	OD	11.4" / 290mm
Color /Finish	Natural	Thickness	0.2" / 5.2mm
Bobbins	None	Bore	2.22" / 56.4mm
		Bolt Holes	Counterbored



MD523
Fits EBC Pads: 296

Type	Floating	OD	11.4" / 290mm
Color /Finish	Polished	Thickness	0.2" / 5.2mm
Bobbins	5	Bore	2.22" / 56.4mm
		Bolt Holes	Counterbored

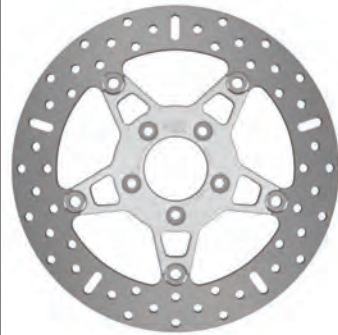

FSD523
Fits EBC Pads: 296

Type	Solid	OD	11.5" / 290mm
Color /Finish	Natural	Thickness	0.196" / 5mm
Bobbins	None	Bore	2.22" / 56.4mm
		Bolt Holes	Counterbored

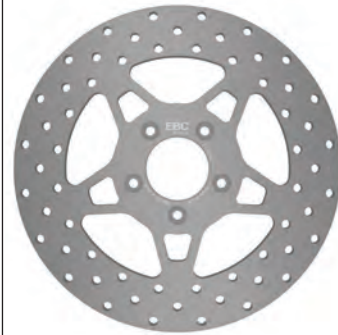

FSD008
Fits EBC Pads: 94, 381, 400, 457

Type	Floating	OD	11.5" / 290mm
Color /Finish	Polished	Thickness	0.196" / 5mm
Bobbins	5	Bore	2.22" / 56.4mm
		Bolt Holes	Counterbored

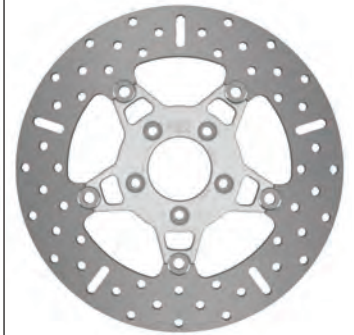

FSD010
Fits EBC Pads: 94, 381, 400, 457

Type	Floating	OD	11.5" / 290mm
Color /Finish	Black	Thickness	0.196" / 5mm
Bobbins	5	Bore	2.22" / 56.4mm
		Bolt Holes	Counterbored



FSD010BLK
Fits EBC Pads: 94, 381, 400, 457

Type	Floating	OD	11.5" / 290mm
Color /Finish	Polished	Thickness	0.196" / 5mm
Bobbins	5	Bore	2.22" / 56.4mm
		Bolt Holes	Counterbored

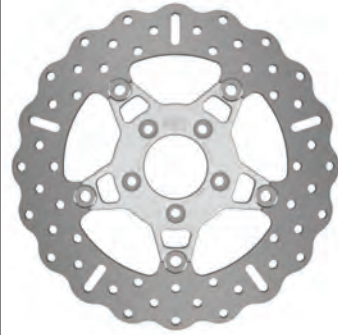

FSD012C
Fits EBC Pads: 94, 381, 400, 457

Type	Floating	OD	11.5" / 290mm
Color /Finish	Black	Thickness	0.196" / 5mm
Bobbins	5	Bore	2.22" / 56.4mm
		Bolt Holes	Counterbored



FSD012CBLK
Fits EBC Pads: 94, 381, 400, 457

Type	Floating	OD	11.5" / 290mm
Color /Finish	Polished	Thickness	0.196" / 5mm
Bobbins	10	Bore	2.22" / 56.4mm
		Bolt Holes	Counterbored

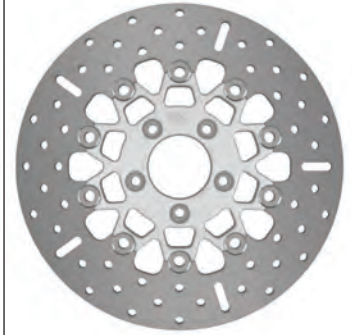

FSD023
Fits EBC Pads: 94, 381, 400, 457

Type	Floating	OD	11.5" / 290mm
Color /Finish	Black	Thickness	0.196" / 5mm
Bobbins	10	Bore	2.22" / 56.4mm
		Bolt Holes	Counterbored



FSD023BLK
Fits EBC Pads: 94, 381, 400, 457

Type	Floating	OD	11.5" / 290mm
Color /Finish	Polished	Thickness	0.196" / 5mm
Bobbins	10	Bore	2.22" / 56.4mm
		Bolt Holes	Counterbored

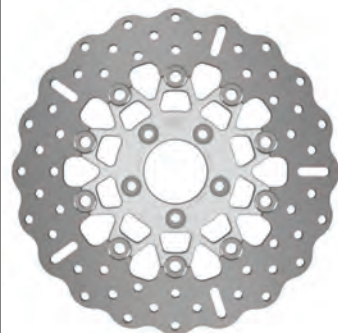

FSD027C
Fits EBC Pads: 94, 381, 400, 457

Type	Floating	OD	11.5" / 290mm
Color /Finish	Black	Thickness	0.196" / 5mm
Bobbins	10	Bore	2.22" / 56.4mm
		Bolt Holes	Counterbored



FSD027CBLK
Fits EBC Pads: 94, 381, 400, 457

Type	Floating	OD	11.5" / 290mm
Color /Finish	Black	Thickness	0.196" / 5mm
Bobbins	5	Bore	2.22" / 56.4mm
		Bolt Holes	Counterbored



VR010BLK
Fits EBC Pads: 94, 381, 400, 457

ROTOR GROUP NO. 001 - FRONT. CHOOSE YOUR PREFERRED STYLE:

Type	Floating	OD	11.5" / 290mm
Color /Finish	Black	Thickness	0.196" / 5mm
Bobbins	10	Bore	2.22" / 56.4mm
		Bolt Holes	Counterbored



VR023BLK
Fits EBC Pads: 94, 381, 400, 457

Type	Floating	OD	14" / 355mm
Color /Finish	Black	Thickness	0.196" / 5mm
Bobbins	5	Bore	2.22" / 56.4mm
		Bolt Holes	Counterbored



OSMD004-14BLK
Fits EBC Pads: 94, 381, 400, 457



Supplied with relocation bracket & hardware
BRK707

Type	Floating	OD	15" / 381mm
Color /Finish	Black	Thickness	0.196" / 5mm
Bobbins	5	Bore	2.22" / 56.4mm
		Bolt Holes	Counterbored



OSMD004-15BLK
Fits EBC Pads: 94, 381, 400, 457



Supplied with relocation bracket & hardware
BRK710

OVERSIZE ROTOR OPTION

OVERSIZE ROTOR OPTION

Increased stopping power, feel and control with the EBC FULLY floating oversize range. These kits bolt directly onto your bike using the stock caliper and also deliver the advantages of a floating rotor over solid designs.

5 button or 10 button Floating Rotors

Light duty 5 button rotors are designed for bikes with a TWIN front rotor set up.
Heavy duty 10 button rotors are designed for bikes with a SINGLE front rotor set up.

ROTOR BOLT KITS

All manufacturers recommend new rotor bolts when replacing brake rotors on any motorcycle. EBC Brakes have rotor bolt kits specifically for Harley Davidson.

Our rotor bolt kits are manufactured from stainless steel with thread lock applied and comply with original manufacturers specifications, supplied in sets of 5.

ROTOR BOLT KITS AVAILABLE

HBK001	5 bolts in chrome finish 15/16 UNC - Front
HBK002	5 bolts in Black Chrome finish 15/16 UNC - Front
HBK003	5 bolts in chrome finish 7/8 UNC - Rear
HBK004	5 bolts in Black Chrome finish 7/8 UNC - Rear



ROTOR GROUP NO. 002 - FRONT. CHOOSE YOUR PREFERRED STYLE:

BRAKE APPLICATIONS

Type	Solid	OD	11.5" / 290mm
Color /Finish	Natural	Thickness	0.196" / 5mm
Bobbins	None	Bore	1.99" / 50.6mm
		Bolt Holes	Counterbored



FSD007
Fits EBC Pads: 94, 216/3

Type	Floating	OD	11.5" / 290mm
Color /Finish	Polished	Thickness	0.196" / 5mm
Bobbins	5	Bore	1.99" / 50.6mm
		Bolt Holes	Counterbored

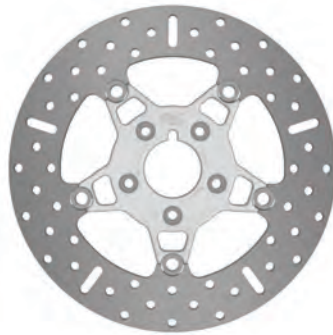

FSD009
Fits EBC Pads: 94, 216/3

Type	Floating	OD	11.5" / 290mm
Color /Finish	Black	Thickness	0.196" / 5mm
Bobbins	5	Bore	1.99" / 50.6mm
		Bolt Holes	Counterbored



FSD009BLK
Fits EBC Pads: 94, 216/3

Type	Floating	OD	11.5" / 290mm
Color /Finish	Polished	Thickness	0.196" / 5mm
Bobbins	5	Bore	1.99" / 50.6mm
		Bolt Holes	Counterbored

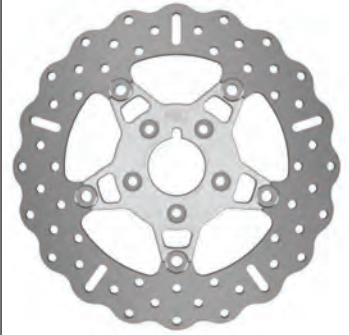

FSD011C
Fits EBC Pads: 94, 216/3

Type	Floating	OD	11.5" / 290mm
Color /Finish	Black	Thickness	0.196" / 5mm
Bobbins	5	Bore	1.99" / 50.6mm
		Bolt Holes	Counterbored



FSD011CBLK
Fits EBC Pads: 94, 216/3

Type	Floating	OD	11.5" / 290mm
Color /Finish	Polished	Thickness	0.196" / 5mm
Bobbins	10	Bore	1.99" / 50.6mm
		Bolt Holes	Counterbored

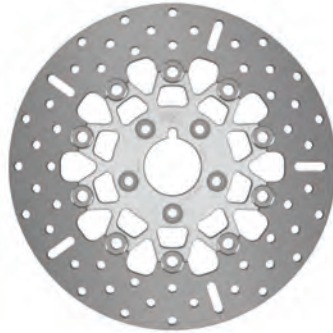

FSD022
Fits EBC Pads: 94, 216/3

Type	Floating	OD	11.5" / 290mm
Color /Finish	Black	Thickness	0.196" / 5mm
Bobbins	10	Bore	1.99" / 50.6mm
		Bolt Holes	Counterbored

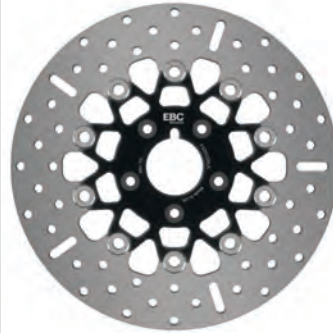

FSD022BLK
Fits EBC Pads: 94, 216/3

Type	Floating	OD	11.5" / 290mm
Color /Finish	Polished	Thickness	0.196" / 5mm
Bobbins	10	Bore	1.99" / 50.6mm
		Bolt Holes	Counterbored

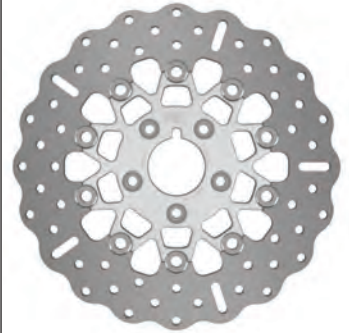

FSD026C
Fits EBC Pads: 94, 216/3

Type	Floating	OD	11.5" / 290mm
Color /Finish	Black	Thickness	0.196" / 5mm
Bobbins	10	Bore	1.99" / 50.6mm
		Bolt Holes	Counterbored



FSD026CBLK
Fits EBC Pads: 94, 216/3

Type	Floating	OD	11.5" / 290mm
Color /Finish	Black	Thickness	0.196" / 5mm
Bobbins	5	Bore	1.99" / 50.6mm
		Bolt Holes	Counterbored



VR011BLK
Fits EBC Pads: 94, 216/3

**5 button or
10 button
Floating Rotors**

Light duty 5 button rotors are designed for bikes with a TWIN front rotor set up.

Heavy duty 10 button rotors are designed for bikes with a SINGLE front rotor set up.

ROTOR GROUP NO. 003 - REAR. CHOOSE YOUR PREFERRED STYLE:

Type	Floating	OD	11.4" / 290mm
Color /Finish	Polished	Thickness	0.236" / 6mm
Bobbins	10	Bore	2.22" / 56.4mm
		Bolt Holes	Counterbored

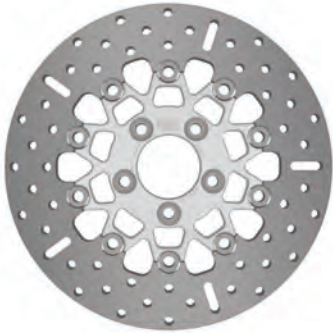

MD528
Fits EBC Pads: 458, 710

Type	Solid	OD	11.5" / 290mm
Color /Finish	Natural	Thickness	0.236" / 6mm
Bobbins	None	Bore	2.22" / 56.4mm
		Bolt Holes	Counterbored



RSD008
Fits EBC Pads: 387, 400, 434, 458, 710

Type	Floating	OD	11.5" / 290mm
Color /Finish	Black	Thickness	0.236" / 6mm
Bobbins	10	Bore	1.99" / 50.6mm
		Bolt Holes	Counterbored



RSD017CBLK
Fits EBC Pads: 200, 216/3

Type	Floating	OD	11.5" / 290mm
Color /Finish	Polished	Thickness	0.236" / 6mm
Bobbins	10	Bore	2.22" / 56.4mm
		Bolt Holes	Counterbored

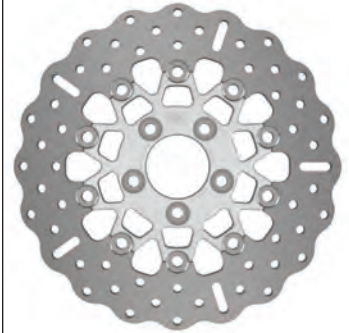

RSD018C
Fits EBC Pads: 387, 400, 434, 458, 710

Type	Floating	OD	11.5" / 290mm
Color /Finish	Black	Thickness	0.236" / 6mm
Bobbins	10	Bore	2.22" / 56.4mm
		Bolt Holes	Counterbored



RSD018CBLK
Fits EBC Pads: 387, 400, 434, 458, 710

Type	Floating	OD	11.5" / 290mm
Color /Finish	Polished	Thickness	0.236" / 6mm
Bobbins	10	Bore	1.99" / 50.6mm
		Bolt Holes	Counterbored

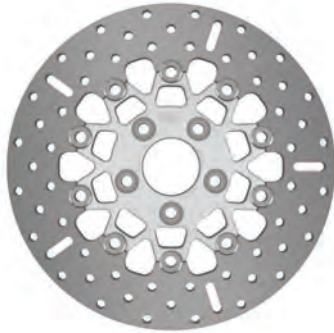

RSD019
Fits EBC Pads: 200, 216/3

Type	Floating	OD	11.5" / 290mm
Color /Finish	Black	Thickness	0.236" / 6mm
Bobbins	10	Bore	1.99" / 50.6mm
		Bolt Holes	Counterbored



RSD019BLK
Fits EBC Pads: 200, 216/3

Type	Floating	OD	11.5" / 290mm
Color /Finish	Polished	Thickness	0.236" / 6mm
Bobbins	10	Bore	2.22" / 56.4mm
		Bolt Holes	Counterbored

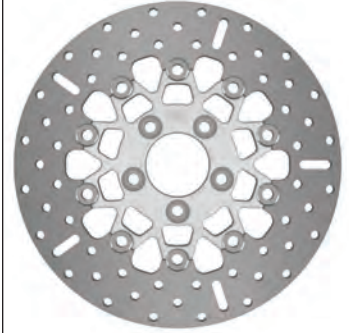

RSD020
Fits EBC Pads: 387, 400, 434, 458, 710

Type	Floating	OD	11.5" / 290mm
Color /Finish	Black	Thickness	0.236" / 6mm
Bobbins	10	Bore	2.22" / 56.4mm
		Bolt Holes	Counterbored



RSD020BLK
Fits EBC Pads: 387, 400, 434, 458, 710

Type	Floating	OD	11.5" / 290mm
Color /Finish	Black	Thickness	0.236" / 6mm
Bobbins	10	Bore	2.22" / 56.4mm
		Bolt Holes	Counterbored



VR020BLK
Fits EBC Pads: 387, 400, 434, 458, 710

ROTOR BOLT KITS AVAILABLE

HBK001	5 bolts in chrome finish 15/16 UNC - Front
HBK002	5 bolts in Black Chrome finish 15/16 UNC - Front
HBK003	5 bolts in chrome finish 7/8 UNC - Rear
HBK004	5 bolts in Black Chrome finish 7/8 UNC - Rear



ROTOR GROUP NO. 004 - REAR. CHOOSE YOUR PREFERRED STYLE:

APPLI
ATIONS
BRAKE

Type	Solid	OD	11.5" / 290mm
Color /Finish	Natural	Thickness	0.236" / 6mm
Bobbins	None	Bore	1.99" / 50.6mm
		Bolt Holes	Counterbored

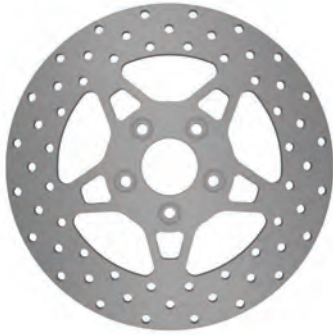

RSD007

Fits EBC Pads: 200, 216/3

Type	Solid	OD	11.5" / 290mm
Color /Finish	Natural	Thickness	0.275" / 6mm
Bobbins	None	Bore	1.99" / 50.6mm
		Bolt Holes	Counterbored

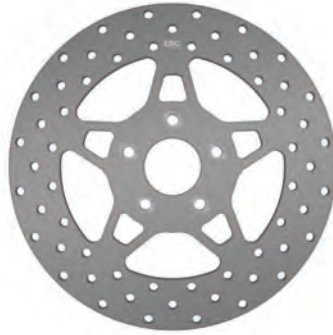

RSD007A

Fits EBC Pads: 200, 216/3

Type	Floating	OD	11.5" / 290mm
Color /Finish	Polished	Thickness	0.236" / 6mm
Bobbins	10	Bore	1.99" / 50.6mm
		Bolt Holes	Counterbored

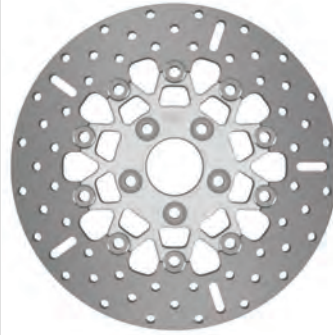

RSD019

Fits EBC Pads: 200, 216/3

Type	Floating	OD	11.5" / 290mm
Color /Finish	Polished	Thickness	0.236" / 6mm
Bobbins	10	Bore	1.99" / 50.6mm
		Bolt Holes	Counterbored

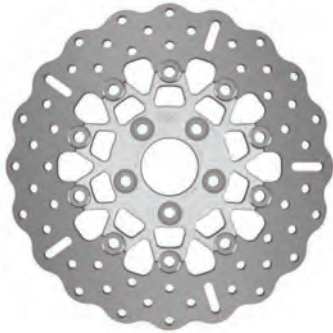

RSD019C

Fits EBC Pads: 200, 216/3

Type	Floating	OD	11.5" / 290mm
Color /Finish	Black	Thickness	0.236" / 6mm
Bobbins	10	Bore	1.99" / 50.6mm
		Bolt Holes	Counterbored



VR019BLK

Fits EBC Pads: 200, 216/3

Type	Floating	OD	11.5" / 290mm
Color /Finish	Black	Thickness	0.236" / 6mm
Bobbins	10	Bore	1.99" / 50.6mm
		Bolt Holes	Counterbored



RSD019BLK

Fits EBC Pads: 200, 216/3

MD509SR

Type	Solid	OD	10.67" / 271mm
Color /Finish	Natural	Thickness	0.314" / 8mm
Bobbins	None	Bore	4" / 101.8mm
		Bolt Holes	Plain

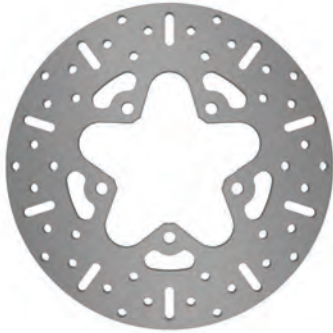

MD509SR – Billet Steel

Fits EBC Pads: 201, 201V only

MD511

Type	Solid	OD	9.44" / 240mm
Color /Finish	Natural	Thickness	0.196" / 5mm
Bobbins	None	Bore	4.13" / 105mm
		Bolt Holes	Countersunk



MD511
Fits EBC Pads: 140, 251

ROTOR BOLT KITS AVAILABLE

HBK001	5 bolts in chrome finish 15/16 UNC - Front
HBK002	5 bolts in Black Chrome finish 15/16 UNC - Front
HBK003	5 bolts in chrome finish 7/8 UNC - Rear
HBK004	5 bolts in Black Chrome finish 7/8 UNC - Rear



ROTOR GROUP NO. 006 – FRONT/REAR. CHOOSE YOUR PREFERRED STYLE:

Type	Solid	OD	11.5" / 290mm
Color /Finish	Natural	Thickness	0.196" / 5mm
Bobbins	None	Bore	6.77" / 172mm
		Bolt Holes	N/A



MD514LS
Fits EBC Pads: 400

Type	Solid	OD	11.5" / 290mm
Color /Finish	Natural	Thickness	0.196" / 5mm
Bobbins	None	Bore	6.77" / 172mm
		Bolt Holes	N/A

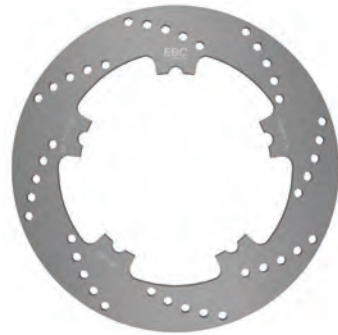

MD514RS
Fits EBC Pads: 400

Type	Solid	OD	11.5" / 290mm
Color /Finish	Natural	Thickness	0.196" / 5mm
Bobbins	None	Bore	6.77" / 172mm
		Bolt Holes	N/A

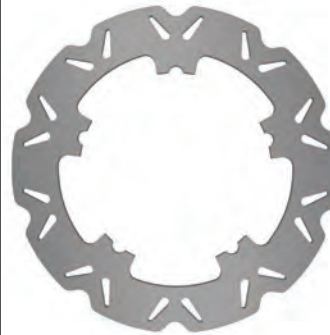

VR514
Fits EBC Pads: 400

MD515

Type	Solid	OD	11.5" / 292mm
Color /Finish	Natural	Thickness	0.23" / 5.8mm
Bobbins	None	Bore	4" / 101.4mm
		Bolt Holes	Counterbored



MD515
Fits EBC Pads: 400

ROTOR GROUP NO. 007 - FRONT. CHOOSE YOUR PREFERRED STYLE:

**APPLI
CATIONS
BRAKE**

Type	Solid	OD	11.8" / 300mm
Color /Finish	Natural	Thickness	0.196" / 5mm
Bobbins	None	Bore	6.7" / 171mm
		Bolt Holes	N/A

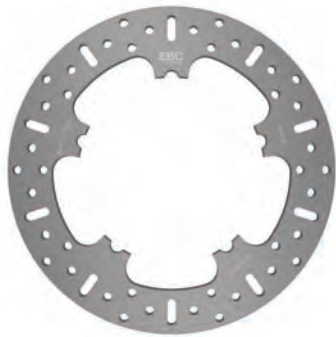

MD516
Fits EBC Pads: 400, 409, 457

Type	Floating	OD	11.8" / 300mm
Color /Finish	Polished	Thickness	0.196" / 5mm
Bobbins	5	Bore	6.7" / 171mm
		Bolt Holes	N/A

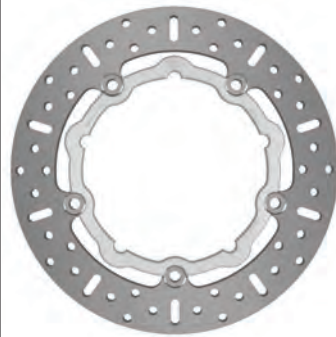

MD516X
Fits EBC Pads: 400, 409, 457

Type	Floating	OD	14" / 355mm
Color /Finish	Black	Thickness	0.196" / 5mm
Bobbins	5	Bore	6.7" / 171mm
		Bolt Holes	N/A

OVERSIZE ROTOR OPTION



OSMD516-14BLK
Fits EBC Pads: 400, 409, 457



Supplied with relocation bracket & hardware
BRK703 **BRK704**

Type	Floating	OD	15" / 381mm
Color /Finish	Black	Thickness	0.196" / 5mm
Bobbins	5	Bore	6.7" / 171mm
		Bolt Holes	N/A

OVERSIZE ROTOR OPTION

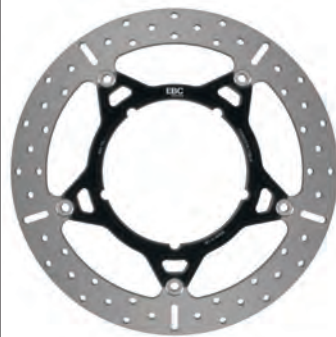

OSMD516-15BLK
Fits EBC Pads: 400, 409, 457



Supplied with relocation bracket & hardware
BRK707 **BRK708**

Increased stopping power, feel and control with the EBC FULLY floating oversize range. These kits bolt directly onto your bike using the stock caliper and also deliver the advantages of a floating rotor over solid designs.

ROTOR GROUP NO. 008 - REAR. CHOOSE YOUR PREFERRED STYLE:

Type	Solid	OD	11.8" / 300mm
Color /Finish	Natural	Thickness	0.275" / 7mm
Bobbins	None	Bore	4" / 101.6mm
		Bolt Holes	Counterbored



MD517
Fits EBC Pads: 409

Type	Floating	OD	11.8" / 300mm
Color /Finish	Polished	Thickness	0.275" / 7mm
Bobbins	9	Bore	4" / 101.4mm
		Bolt Holes	Counterbored

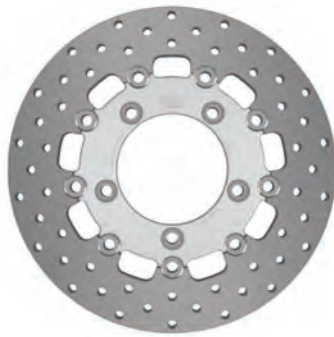

MD525
Fits EBC Pads: 409

ROTOR GROUP NO. 009 – REAR. CHOOSE YOUR PREFERRED STYLE:

Type	Solid	OD	11.8" / 300mm
Color /Finish	Natural	Thickness	0.275" / 7mm
Bobbins	None	Bore	2.22" / 56.4mm
		Bolt Holes	Counterbored

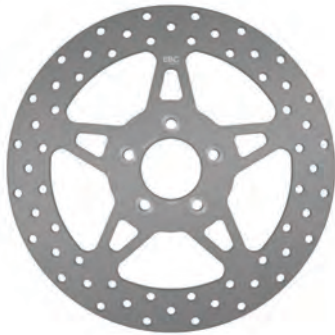

MD542
Fits EBC Pads: 409

Type	Floating	OD	11.8" / 300mm
Color /Finish	Polished	Thickness	0.275" / 7mm
Bobbins	10	Bore	2.22" / 56.4mm
		Bolt Holes	Counterbored

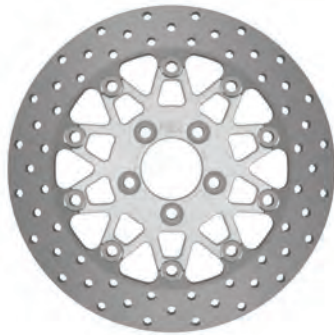

MD521
Fits EBC Pads: 409

Type	Floating	OD	11.8" / 300mm
Color /Finish	Black	Thickness	0.275" / 7mm
Bobbins	10	Bore	2.22" / 56.4mm
		Bolt Holes	Counterbored



MD521BLK
Fits EBC Pads: 409

Type	Floating	OD	11.8" / 300mm
Color /Finish	Black	Thickness	0.275" / 7mm
Bobbins	10	Bore	2.22" / 56.4mm
		Bolt Holes	Counterbored



VR521BLK
Fits EBC Pads: 409

ROTOR BOLT KITS AVAILABLE

HBK001	5 bolts in chrome finish 15/16 UNC - Front
HBK002	5 bolts in Black Chrome finish 15/16 UNC - Front
HBK003	5 bolts in chrome finish 7/8 UNC - Rear
HBK004	5 bolts in Black Chrome finish 7/8 UNC - Rear



ROTOR GROUP NO. 010 - FRONT. CHOOSE YOUR PREFERRED STYLE:

Type	Floating	OD	11.8" / 300mm
Color /Finish	Polished	Thickness	0.196" / 5mm
Bobbins	10	Bore	2.22" / 56.4mm
		Bolt Holes	Counterbored

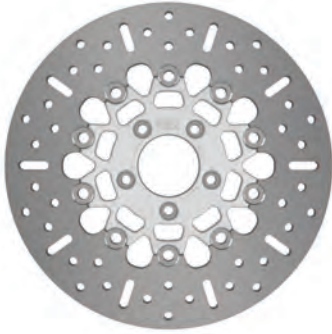

MD518
Fits EBC Pads: 400, 409, 457

Type	Floating	OD	11.8" / 300mm
Color /Finish	Black	Thickness	0.196" / 5mm
Bobbins	10	Bore	2.22" / 56.4mm
		Bolt Holes	Counterbored



MD518BLK
Fits EBC Pads: 400, 409, 457

Type	Floating	OD	11.8" / 300mm
Color /Finish	Black	Thickness	0.196" / 5mm
Bobbins	10	Bore	2.22" / 56.4mm
		Bolt Holes	Counterbored



MD518CBLK
Fits EBC Pads: 400, 409, 457

Type	Floating	OD	11.8" / 300mm
Color /Finish	Polished	Thickness	0.196" / 5mm
Bobbins	5	Bore	2.22" / 56.4mm
		Bolt Holes	Plain

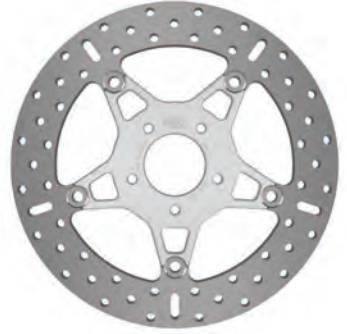

MD520
Fits EBC Pads: 296, 409, 638, 640

Type	Floating	OD	11.8" / 300mm
Color /Finish	Black	Thickness	0.196" / 5mm
Bobbins	10	Bore	2.22" / 56.4mm
		Bolt Holes	Plain



MD520/10BLK
Fits EBC Pads: 409

Type	Floating	OD	11.8" / 300mm
Color /Finish	Natural	Thickness	0.196" / 5mm
Bobbins	None	Bore	2.22" / 56.4mm
		Bolt Holes	Plain



VR520BLK
Fits EBC Pads: 409

Type	Solid	OD	11.8" / 300mm
Color /Finish	Natural	Thickness	0.196" / 5mm
Bobbins	None	Bore	2.22" / 56.4mm
		Bolt Holes	Counterbored



MD526
Fits EBC Pads: 296, 640

Type	Floating	OD	11.8" / 300mm
Color /Finish	Polished	Thickness	0.196" / 5mm
Bobbins	5	Bore	2.22" / 56.4mm
		Bolt Holes	Counterbored

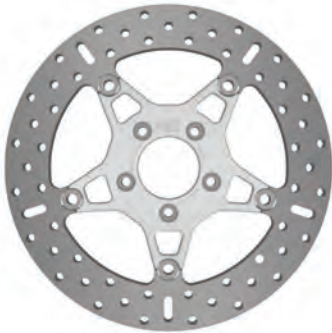

MD530
Fits EBC Pads: 296, 409, 638, 640

Type	Floating	OD	11.8" / 300mm
Color /Finish	Black	Thickness	0.196" / 5mm
Bobbins	5	Bore	2.22" / 56.4mm
		Bolt Holes	Counterbored



MD530BLK
Fits EBC Pads: 296, 638, 640

Type	Solid	OD	11.81" / 300mm
Color /Finish	Natural	Thickness	0.196" / 5mm
Bobbins	None	Bore	2.22" / 56.4mm
		Bolt Holes	Plain



MD541
Fits EBC Pads: 409

**5 button or
10 button
Floating Rotors**

Light duty 5 button rotors are designed for bikes with a TWIN front rotor set up.
Heavy duty 10 button rotors are designed for bikes with a SINGLE front rotor set up.

ROTOR GROUP NO. 010 - FRONT. CHOOSE YOUR PREFERRED STYLE:

Type	Floating	OD	14" / 355mm
Color /Finish	Polished	Thickness	0.196" / 5mm
Bobbins	5	Bore	2.22" / 56.4mm
		Bolt Holes	Counterbored

OVERSIZE ROTOR OPTION

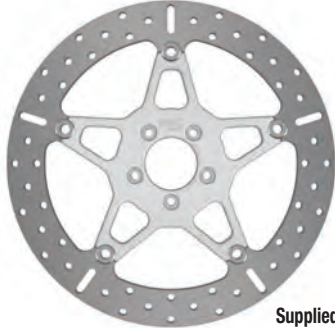

OSMD518-14
Fits EBC Pads: 400, 409, 457
BRK701 **SEE RIGHT**
Supplied with relocation bracket & hardware

Type	Floating	OD	14" / 355mm
Color /Finish	Black	Thickness	0.196" / 5mm
Bobbins	5	Bore	2.22" / 56.4mm
		Bolt Holes	Counterbored

OVERSIZE ROTOR OPTION

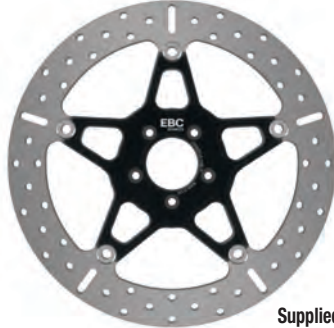

OSMD518-14BLK
Fits EBC Pads: 400, 409, 457
BRK701 **SEE RIGHT**
Supplied with relocation bracket & hardware

Increased stopping power, feel and control with the EBC FULLY floating oversize range. These kits bolt directly onto your bike using the stock caliper and also deliver the advantages of a floating rotor over solid designs.



BRK701

MD522

Type	Solid	OD	9.44" / 240mm
Color /Finish	Natural	Thickness	0.196" / 5mm
Bobbins	None	Bore	2.77" / 70.6mm
		Bolt Holes	Plain

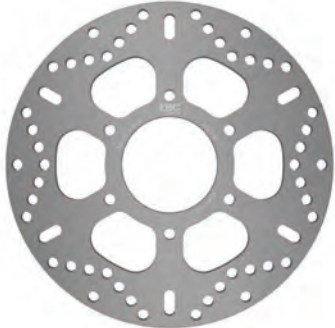

MD522
Fits EBC Pads: 140

ROTOR BOLT KITS AVAILABLE

HBK001	5 bolts in chrome finish 15/16 UNC - Front
HBK002	5 bolts in Black Chrome finish 15/16 UNC - Front
HBK003	5 bolts in chrome finish 7/8 UNC - Rear
HBK004	5 bolts in Black Chrome finish 7/8 UNC - Rear



ROTOR GROUP NO. 011 – REAR. CHOOSE YOUR PREFERRED STYLE:

Type	Solid	OD	10.23" / 260mm
Color /Finish	Natural	Thickness	0.275" / 7mm
Bobbins	None	Bore	2.22" / 56.4mm
		Bolt Holes	Counterbored



MD524
Fits EBC Pads: 254, 387

Type	Floating	OD	10.23" / 260mm
Color /Finish	Polished	Thickness	0.275" / 7mm
Bobbins	10	Bore	2.22" / 56.4mm
		Bolt Holes	Counterbored

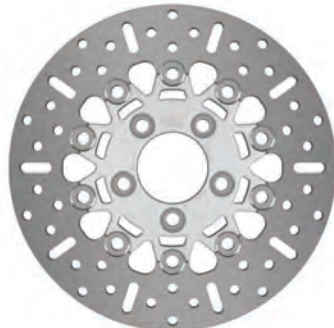

RSD524
Fits EBC Pads: 254, 387

ROTOR GROUP NO. 017 – FRONT. CHOOSE YOUR PREFERRED STYLE:

Type	Solid	OD	11.8" / 300mm
Color /Finish	Natural	Thickness	0.196" / 5mm
Bobbins	None	Bore	5.48" / 139.2mm
		Bolt Holes	N/A

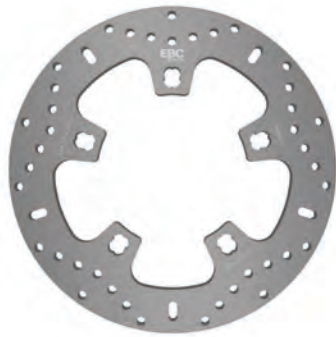

MD529
Fits EBC Pads: 409

Type	Solid	OD	11.8" / 300mm
Color /Finish	Natural	Thickness	0.196" / 5mm
Bobbins	None	Bore	5.48" / 139.2mm
		Bolt Holes	N/A



VR529
Fits EBC Pads: 409

ROTOR BOLT KITS AVAILABLE

HBK001	5 bolts in chrome finish 15/16 UNC - Front
HBK002	5 bolts in Black Chrome finish 15/16 UNC - Front
HBK003	5 bolts in chrome finish 7/8 UNC - Rear
HBK004	5 bolts in Black Chrome finish 7/8 UNC - Rear



MD531

Type	Solid	OD	11.41" / 290mm
Color /Finish	Natural	Thickness	0.2" / 5.2mm
Bobbins	None	Bore	2.22" / 56.4mm
		Bolt Holes	Plain



MD531
Fits EBC Pads: 643

MD532

Type	Solid	OD	10.23" / 260mm
Color /Finish	Natural	Thickness	0.2" / 5.6mm
Bobbins	None	Bore	2.22" / 56.4mm
		Bolt Holes	Plain



MD532
Fits EBC Pads: 643

ROTOR GROUP NO. 019 – FRONT/REAR. CHOOSE YOUR PREFERRED STYLE:

Type	Solid	OD	11.77" / 299mm
Color /Finish	Black	Thickness	0.82" / 21mm
Bobbins	None	Bore	2.67" / 68mm
		Bolt Holes	N/A



MD533
Fits EBC Pads: 669/4, 670

Type	Solid	OD	11.77" / 299mm
Color /Finish	Black	Thickness	0.82" / 21mm
Bobbins	None	Bore	2.67" / 68mm
		Bolt Holes	N/A



MD533BSDF – Front 2 required
Fits EBC Pads: 669/4, 670

Type	Solid	OD	11.77" / 299mm
Color /Finish	Black	Thickness	0.82" / 21mm
Bobbins	None	Bore	2.67" / 68mm
		Bolt Holes	N/A



MD533BSDR – Rear 1 required
Fits EBC Pads: 669/4, 670

BSDF and BSDR slotted sport rotors choose axle required from suffix F for front and R for rear)

ROTOR GROUP NO. 020 – FRONT/REAR. CHOOSE YOUR PREFERRED STYLE:

Type	Solid	OD	11.73" / 298mm
Color /Finish	Natural	Thickness	0.196" / 5mm
Bobbins	None	Bore	2.52" / 64.2mm
		Bolt Holes	Plain

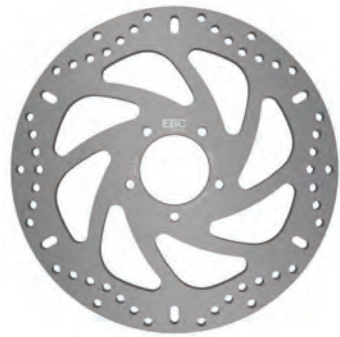

MD534
Fits EBC Pads: 209/2, 213, 377, 672

Type	Floating	OD	11.73" / 298mm
Color /Finish	Polished	Thickness	0.196" / 5mm
Bobbins	10	Bore	2.52" / 64.2mm
		Bolt Holes	Plain

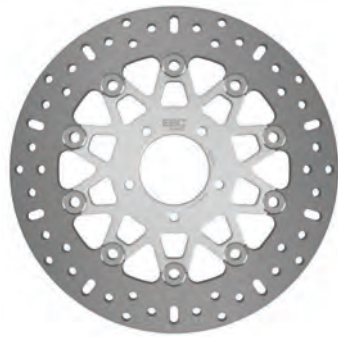

MD534X
Fits EBC Pads: 209/2, 213, 377, 672

Type	Floating	OD	11.73" / 298mm
Color /Finish	Polished	Thickness	0.196" / 5mm
Bobbins	10	Bore	2.52" / 64.2mm
		Bolt Holes	Plain



MD534XBLK
Fits EBC Pads: 209/2, 213, 377, 672

ROTOR GROUP NO. 021 - FRONT/REAR. CHOOSE YOUR PREFERRED STYLE:

Type	Floating	OD	11.5" / 292mm
Color /Finish	Polished	Thickness	0.196" / 5mm
Bobbins	5	Bore	2.22" / 56.4mm
		Bolt Holes	Counterbored

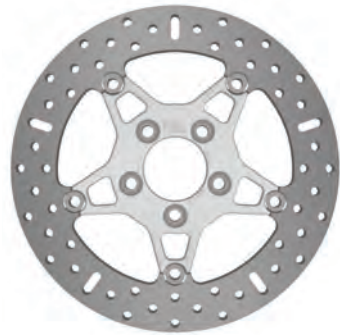

MD535
Fits EBC Pads: 95, 696

Type	Floating	OD	11.5" / 292mm
Color /Finish	Black	Thickness	0.196" / 5mm
Bobbins	5	Bore	2.22" / 56.4mm
		Bolt Holes	Counterbored



MD535BLK
Fits EBC Pads: 95, 696

ROTOR GROUP NO. 022 – FRONT. CHOOSE YOUR PREFERRED STYLE:

Type	Solid	OD	11.8" / 300mm
Color /Finish	Natural	Thickness	0.236" / 6mm
Bobbins	None	Bore	2.22" / 56.4mm
		Bolt Holes	Counterbored



MD536
Fits EBC Pads: 209/2

Type	Floating	OD	11.8" / 300mm
Color /Finish	Polished	Thickness	0.236" / 6mm
Bobbins	5	Bore	2.22" / 56.4mm
		Bolt Holes	Counterbored



MD536X
Fits EBC Pads: 209/2

Type	Floating	OD	11.8" / 300mm
Color /Finish	Black	Thickness	0.236" / 6mm
Bobbins	5	Bore	2.22" / 56.4mm
		Bolt Holes	Counterbored



MD536XBLK
Fits EBC Pads: 209/2

MD537

Type	Solid	OD	11.8" / 300mm
Color /Finish	Natural	Thickness	0.236" / 6mm
Bobbins	None	Bore	2.22" / 56.4mm
		Bolt Holes	Counterbored



MD537
Fits EBC Pads: 181

ROTOR BOLT KITS AVAILABLE

HBK001	5 bolts in chrome finish 15/16 UNC - Front
HBK002	5 bolts in Black Chrome finish 15/16 UNC - Front
HBK003	5 bolts in chrome finish 7/8 UNC - Rear
HBK004	5 bolts in Black Chrome finish 7/8 UNC - Rear



MD538

Type	Solid	OD	10.67" / 270.5mm
Color /Finish	Black	Thickness	0.25" / 6.35mm
Bobbins	None	Bore	4.311" / 109.5mm
		Bolt Holes	N/A



MD538 – Cast iron rotors for Trikes®
Fits EBC Pads: 641/4

MD540

Type	Solid	OD	8.97" / 228mm
Color /Finish	Black	Thickness	0.248" / 6.3mm
Bobbins	None	Bore	6.783" / 172.3mm
		Bolt Holes	N/A



MD540 – Cast iron rotors for Trikes®
Fits EBC Pads: 605/4

ROTOR GROUP NO. 024 - FRONT/REAR. CHOOSE YOUR PREFERRED STYLE:

Type	Floating	OD	11.77" / 299mm
Color /Finish	Natural	Thickness	0.196" / 5mm
Bobbins	9	Bore	2.52" / 64.2mm
		Bolt Holes	Plain



MD678
Fits EBC Pads: 196, 209/2, 244, 347

Type	Floating	OD	11.77" / 299mm
Color /Finish	Black	Thickness	0.196" / 5mm
Bobbins	9	Bore	2.52" / 64.2mm
		Bolt Holes	Plain



MD678BLK
Fits EBC Pads: 196, 209/2, 244, 347

Type	Floating	OD	11.77" / 299mm
Color /Finish	Black	Thickness	0.196" / 5mm
Bobbins	9	Bore	2.52" / 64.2mm
		Bolt Holes	Plain

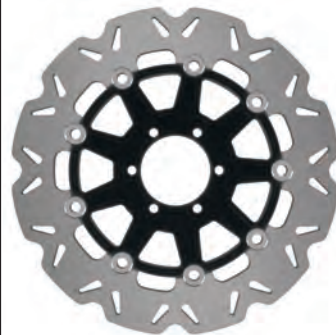

VR678BLK
Fits EBC Pads: 196, 209/2, 244, 347

ROTOR GROUP NO. 025 – REAR. CHOOSE YOUR PREFERRED STYLE:

Type	Floating	OD	11.77" / 299mm
Color /Finish	Black	Thickness	0.275" / 7mm
Bobbins	9	Bore	2.527" / 64.2mm
		Bolt Holes	Plain



MD887BLK
Fits EBC Pads: 196

Type	Floating	OD	11.77" / 299mm
Color /Finish	Black	Thickness	0.275" / 7mm
Bobbins	9	Bore	2.527" / 64.2mm
		Bolt Holes	Plain



VR887BLK
Fits EBC Pads: 196

ROTOR GROUP NO. 026 – FRONT/REAR. CHOOSE YOUR PREFERRED STYLE:

Type	Floating	OD	11.77" / 299mm
Color /Finish	Natural	Thickness	0.196" / 5mm
Bobbins	9	Bore	1.99" / 50.6mm
		Bolt Holes	Plain

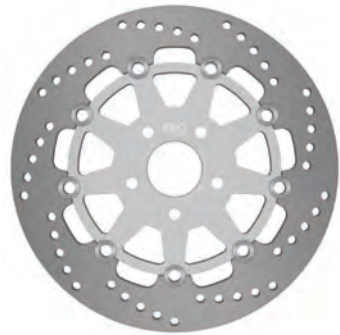

MD727
Fits EBC Pads: 209/2, 244

Type	Floating	OD	11.77" / 299mm
Color /Finish	Black	Thickness	0.196" / 5mm
Bobbins	9	Bore	1.99" / 50.6mm
		Bolt Holes	Plain

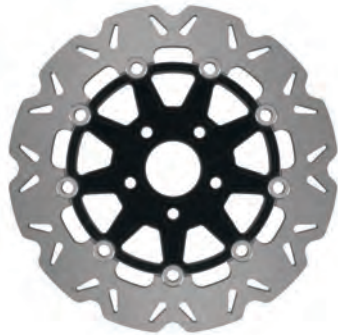

VR727BLK
Fits EBC Pads: 209/2, 244

ROTOR GROUP NO. 027 - FRONT. CHOOSE YOUR PREFERRED STYLE:

Type	Solid	OD	9.84" / 250mm
Color /Finish	Natural	Thickness	0.236" / 6mm
Bobbins	None	Bore	2.606" / 66.2mm
		Bolt Holes	Plain



MD801
Fits EBC Pads: 474

Type	Solid	OD	9.84" / 250mm
Color /Finish	Natural	Thickness	0.236" / 6mm
Bobbins	None	Bore	2.606" / 66.2mm
		Bolt Holes	Plain



VR801
Fits EBC Pads: 474

ROTOR GROUP NO. 028 – REAR. CHOOSE YOUR PREFERRED STYLE:

Type	Solid	OD	9.84" / 250mm
Color /Finish	Natural	Thickness	0.236" / 6mm
Bobbins	None	Bore	2.606" / 66.2mm
		Bolt Holes	Plain



MD802
Fits EBC Pads: 473

Type	Solid	OD	9.84" / 250mm
Color /Finish	Natural	Thickness	0.236" / 6mm
Bobbins	None	Bore	2.606" / 66.2mm
		Bolt Holes	Plain



VR802
Fits EBC Pads: 473

ROTOR GROUP NO. 029 – FRONT. CHOOSE YOUR PREFERRED STYLE:

Type	Solid	OD	10.6" / 270mm
Color /Finish	Natural	Thickness	0.275" / 7mm
Bobbins	None	Bore	2.46" / 62.6mm
		Bolt Holes	Plain



MD853
Fits EBC Pads: 630

Type	Solid	OD	10.6" / 270mm
Color /Finish	Natural	Thickness	0.275" / 7mm
Bobbins	None	Bore	2.46" / 62.6mm
		Bolt Holes	Plain



VR853
Fits EBC Pads: 630

ROTOR GROUP NO. 030 - REAR. CHOOSE YOUR PREFERRED STYLE:

Type	Solid	OD	10.6" / 270mm
Color /Finish	Natural	Thickness	0.275" / 7mm
Bobbins	None	Bore	2.46" / 62.6mm
		Bolt Holes	Counterbored



MD854
Fits EBC Pads: 631

Type	Solid	OD	10.6" / 270mm
Color /Finish	Natural	Thickness	0.275" / 7mm
Bobbins	None	Bore	2.46" / 62.6mm
		Bolt Holes	Counterbored



VR854
Fits EBC Pads: 631

ROTOR BOLT KITS AVAILABLE

HBK001	5 bolts in chrome finish 15/16 UNC - Front
HBK002	5 bolts in Black Chrome finish 15/16 UNC - Front
HBK003	5 bolts in chrome finish 7/8 UNC - Rear
HBK004	5 bolts in Black Chrome finish 7/8 UNC - Rear



ROTOR GROUP NO. 031 – FRONT. CHOOSE YOUR PREFERRED STYLE:

Type	Solid	OD	12.59" / 320mm
Color /Finish	Natural	Thickness	0.196" / 5mm
Bobbins	None	Bore	8.86" / 225mm
		Bolt Holes	N/A

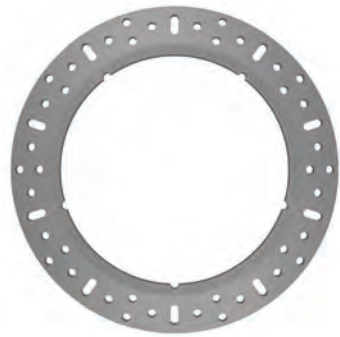

MD737
Fits EBC Pads: 196

Type	Solid	OD	12.59" / 320mm
Color /Finish	Natural	Thickness	0.196" / 5mm
Bobbins	None	Bore	8.86" / 225mm
		Bolt Holes	N/A



VR737
Fits EBC Pads: 196

ROTOR GROUP NO. 032 – REAR. CHOOSE YOUR PREFERRED STYLE:

Type	Solid	OD	8.66" / 220mm
Color /Finish	Natural	Thickness	0.196" / 5mm
Bobbins	None	Bore	1.99" / 50.6mm
		Bolt Holes	Plain



MD738
Fits EBC Pads: 140

Type	Solid	OD	8.66" / 220mm
Color /Finish	Natural	Thickness	0.196" / 5mm
Bobbins	None	Bore	1.99" / 50.6mm
		Bolt Holes	Plain



VR738
Fits EBC Pads: 140

MD689

MD690

MD690C

MD691

Type	Solid	OD	9.05" / 230mm
Color /Finish	Natural	Thickness	0.177" / 4.5mm
Bobbins	None	Bore	3.433" / 87.2mm
		Bolt Holes	Counterbored



MD689
Fits EBC Pads: 86

Type	Floating	OD	11.77" / 299mm
Color /Finish	Natural	Thickness	0.157" / 4mm
Bobbins	9	Bore	2.527" / 64.2mm
		Bolt Holes	Counterbored

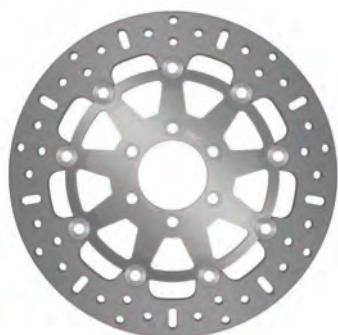

MD690
Fits EBC Pads: 86

Type	Floating	OD	11.77" / 299mm
Color /Finish	Natural	Thickness	0.157" / 4mm
Bobbins	9	Bore	2.527" / 64.2mm
		Bolt Holes	Counterbored

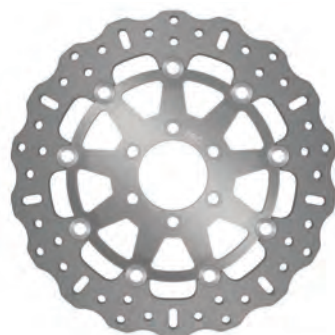

MD690C
Fits EBC Pads: 86

Type	Floating	OD	11.81" / 300mm
Color /Finish	Natural	Thickness	0.157" / 4mm
Bobbins	6	Bore	5.126" / 130.2mm
		Bolt Holes	Counterbored

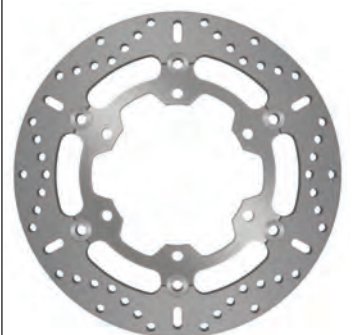

MD691
Fits EBC Pads: 86

MD719RS

Type	Floating	OD	13.38" / 340mm
Color /Finish	Natural	Thickness	0.196" / 5mm
Bobbins	9	Bore	2.385" / 60.6mm
		Bolt Holes	Countersunk

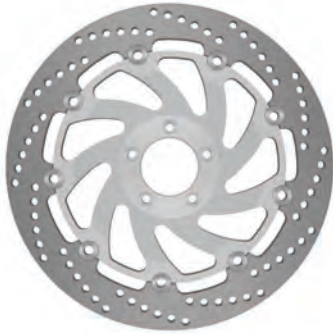

MD719RS
Fits EBC Pads: 210, 424

MD734RS

Type	Floating	OD	13.38" / 340mm
Color /Finish	Natural	Thickness	0.196" / 5mm
Bobbins	9	Bore	2.385" / 60.6mm
		Bolt Holes	Counterbored



MD734RS
Fits EBC Pads: 424

MD735RS

Type	Solid	OD	14.76" / 375mm
Color /Finish	Natural	Thickness	0.196" / 5mm
Bobbins	None	Bore	12" / 307mm
		Bolt Holes	N/A

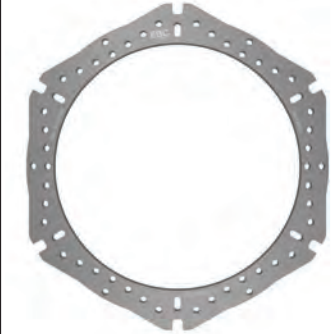

MD735RS
Fits EBC Pads: 345, 454/4

MD803

Type	Solid	OD	12.6" / 320mm
Color /Finish	Natural	Thickness	0.177" / 4.5mm
Bobbins	None	Bore	7.106" / 180.5mm
		Bolt Holes	Plain

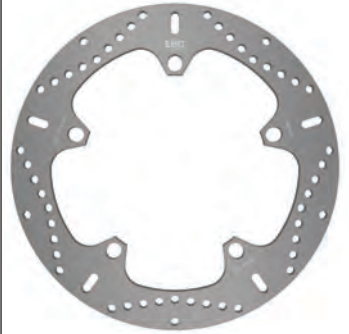

MD803
Fits EBC Pads: 630

MD887BLK

Type	Floating	OD	11.77" / 299mm
Color /Finish	Black	Thickness	0.275" / 7mm
Bobbins	9	Bore	2.527" / 64.2mm
		Bolt Holes	Plain



MD887BLK
Fits EBC Pads: 196

MD890BLK

Type	Floating	OD	11.77" / 299mm
Color /Finish	Black	Thickness	0.196" / 5mm
Bobbins	9	Bore	2.527" / 64.2mm
		Bolt Holes	Plain



MD890BLK
Fits EBC Pads: 196, 261, 347

MD8007

Type	Solid	OD	10.24" / 260mm
Color /Finish	Natural	Thickness	0.196" / 5mm
Bobbins	None	Bore	4.63" / 117.6mm
		Bolt Holes	Plain

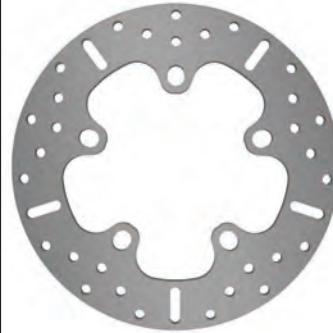

MD8007
Fits EBC Pads: 266

MD1187C

Type	Solid	OD	12.6" / 320mm
Color /Finish	Natural	Thickness	0.196" / 5mm
Bobbins	None	Bore	8.35" / 212.2mm
		Bolt Holes	Plain

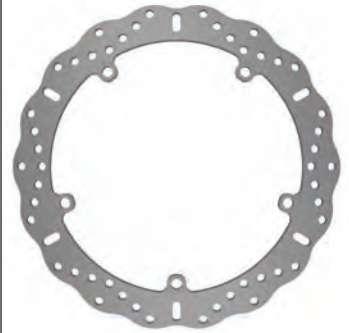

MD1187C
Fits EBC Pads: 185, 209/2, 264

MD6435C

Type	Solid	OD	9.44" / 240mm
Color /Finish	Natural	Thickness	0.157" / 4mm
Bobbins	None	Bore	4.141" / 105.2mm
		Bolt Holes	Plain

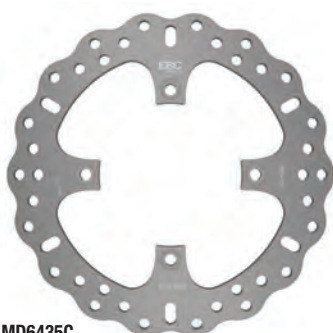

MD6435C
Fits EBC Pads: 83, 181, 185, 208, 209/2, 213, 264, 367

MD8018XBLK

Type	Floating	OD	12.59" / 320mm
Color /Finish	Black	Thickness	0.177" / 4.5mm
Bobbins	6	Bore	2.244" / 57mm
		Bolt Holes	Plain

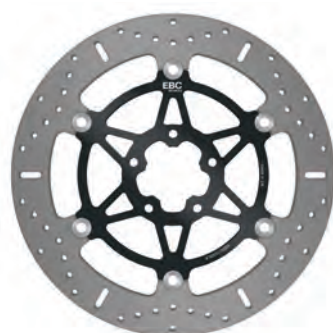

MD8018XBLK
Fits EBC Pads: 630

MD8019

Type	Solid	OD	11.02" / 280mm
Color /Finish	Natural	Thickness	0.196" / 5mm
Bobbins	None	Bore	6.614" / 168mm
		Bolt Holes	Plain

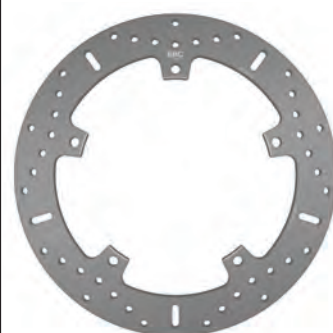

MD8019
Fits EBC Pads: 213

MD8020

Type	Solid	OD	12.59" / 320mm
Color /Finish	Natural	Thickness	0.177" / 4.5mm
Bobbins	None	Bore	6.322" / 160.6mm
		Bolt Holes	Plain

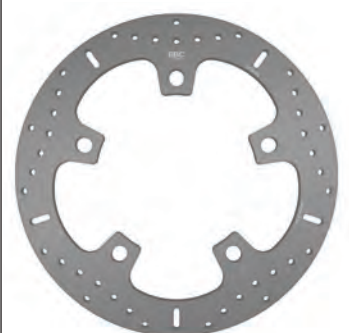

MD8020
Fits EBC Pads: 630

BRAKE PADS AND ROTORS FOR POLARIS SLINGSHOT



EBC BRAKE STANDARD ORGANIC BRAKE PADS

A direct equivalent to the OE brake pads, suitable for every day driving. This is our quietest pad formulation for silent braking – progressive braking with excellent cold friction.

EBC BRAKE YELLOW CODED UPGRADE BRAKE PADS

For faster driving, these pads give excellent cold bite and high temperature fade resistance. Stopping distances are drastically reduced, progressive braking with unparalleled pedal feel.



EBC BRAKE ROTORS – OE QUALITY REPLACEMENT

EBC brake rotors are cast using high quality G3000 alloy making this a premium OE quality replacement brake rotor for your Slingshot. Black thermic coated for aesthetics and corrosion protection.

EBC BRAKE ROTORS – BSD BLADE SERIES

The unique BSD blade slot design removes hot gasses from the heart of the braking zone allowing for quicker and more effective dissipation of heat.

COMPLETE VEHICLE STANDARD BRAKE KIT

This money saving kit includes one set of standard organic brake pads for both the front and rear of your vehicle, plus two OE quality brake rotors for the front and one for the rear.

COMPLETE VEHICLE UPGRADE BRAKE KIT

This upgrade kit includes one set of yellow coded upgrade brake pads for both the front and rear of your vehicle, plus two BSD blade slotted brake rotors for the front and one for the rear.



Model	Year	FRONT					REAR				FULL VEHICLE	
		STANDARD BLACK BRAKE PADS (INC. 4 PADS FOR LEFT AND RIGHT FITMENTS)	UPGRADE YELLOW BRAKE PADS (INC. 4 PADS FOR LEFT AND RIGHT FITMENTS)	STANDARD ROTOR LEFT (GROUP)	STANDARD ROTOR RIGHT (GROUP)	BSD SPORT SLOTTED ROTOR KIT (2 PCS)	STANDARD BLACK BRAKE PADS (2 PCS)	UPGRADE YELLOW BRAKE PADS (2 PCS)	STANDARD ROTOR (GROUP)	BSD SPORT SLOTTED ROTOR	COMPLETE STANDARD BRAKE KIT (1 X FRONT PADS, 1 X REAR PADS, 2 X FRONT ROTORS, 1 X REAR ROTOR)	COMPLETE UPGRADE BRAKE KIT (1 X FRONT PADS, 1 X REAR PADS, 2 X FRONT ROTORS, 1 X REAR ROTOR)
Slingshot Base	15-17	FA669/4	FA4669/4	019	019	MD533BSDF	FA670	FA4670	019	MD533BSDR	MDK533STD	MDK533BSD
Slingshot S	18-22	FA669/4	FA4669/4	019	019	MD533BSDF	FA670	FA4670	019	MD533BSDR	MDK533STD	MDK533BSD
Slingshot SL	15-23	FA669/4	FA4669/4	019	019	MD533BSDF	FA670	FA4670	019	MD533BSDR	MDK533STD	MDK533BSD
Slingshot SL SE	15-22	FA669/4	FA4669/4	019	019	MD533BSDF	FA670	FA4670	019	MD533BSDR	MDK533STD	MDK533BSD
Slingshot SLR	17-23	FA669/4	FA4669/4				FA670	FA4670				

FOR FULL APPLICATION INFORMATION PLEASE SEE PAGES 50-51

Part numbers, prefixes, suffixes, photos and illustrations shown in this catalog are trademarks and/or copyrights of EBC Brakes or the trademark owner A C Freeman Investments Ltd and use without express written permission of the owners is punishable by law.

BRAKE APPLICATION SECTION
Brake pads, shoes and rotors for
European and Asian Motorcycles, ATVs and UTVs

FRONT: HONDA Cont'd

REAR: HONDA

Line #	BRAKE ROTOR CHOICES - FRONT					Front Disc Bolt Kit	DISC PAD CHOICES - REAR					BRAKE ROTOR CHOICES - REAR				
	CX Extreme® /Vee-Rotor	OSX Series Oversize 280mm Rotor Kit	Relocating Bracket for Oversize Rotor	SMX Series Oversize 320mm Rotor Kit	Relocating Bracket for 320mm Rotor		FA/SFA/X Pad or Brake Shoe	Specialty Pads SXR/ VEE/MXS Race	Sintered/ HH Pads/ Grooved Shoes	EPFA Sintered Fast Road/ Track Pads	SV Series Severe Duty Pads	Standard Rotor	Vintage Rotor / UTV Oversize Brake Kit	Contour Profile Rotor	CX Extreme® /Vee-Rotor	Rear Disc Bolt Kit
1							FA131X									
2							333									
3							301									
4							304									
5							301									
6							302									
7							302									
8							301									
9							302									
10							304									
11							301									
12							333									
13							301									
14							304									
15							FA131X									
16							302									
17							302									
18							322									
19							301									
20							302									
21							333									
22							301									
23							302									
24							301									
25							301									
26							301									
27							303									
28							333									
29							310									
30							303									
31							333									
32							303									
33							303									
34							303									
35							330									
36							333									
37							304									
38							303									
39							304									
40							333									
41							333									
42							304									
43							333									
44							338									
45							338									
46							FA131X	MXS131	FA131R			MD6005D				
47	MD6058CX	OSX6058	BRK026				FA131X	MXS131	FA131R			MD6005D		MD6005CX		
48							333		333G							
49							333									
50							302									
51							304		304G							
52							304		304G							
53							333		333G							
54	MD6058CX	OSX6058	BRK026				FA131X	MXS131	FA131R			MD6005D		MD6005CX		
55							303		303G							
56							306		306G							

REAR

BRAKE APPLICATIONS

⚠ This symbol indicates a rotor made of billet steel, and should be only used with EBC FA Organic or Vee pads. SAFETY NOTICE - With vehicles primarily designed for off highway use such as quads now being used on the highway, we would recommend the use of X or MXS pads for highway use and ONLY using the R and SV higher density / harder pad series for off road riding.

*-2 Sets Required. † For Vee disc colours add RED, BLU, GRN, GLD, ORG suffix to part number. **SAFETY WARNING:- DO NOT USE HH PADS ON REAR UNLESS ALSO USED ON FRONT TO AVOID BRAKE IMBALANCE**

FRONT: HONDA

APPLICATIONS

BRAKE



HONDA



DISC PAD CHOICES - FRONT

BRAKE ROTOR CHOICES - FRONT

Model	Year	FA/SFA/X Pad or Brake Shoe	Specialty Pads SXR/VEE/MXS Race	Sintered/HH Pads/Grooved Shoes	EPFA Sintered Fast Road/Track Pads	GPFA Sintered RACE ONLY Pads	SV Series Severe Duty Pads	Standard Rotor Left	Standard Rotor Right	Vintage Rotor / UTV Oversize Brake Kit	Contour Profile Rotor	Line #
TRX 90 Fourtrax/Sportrax	1993-2006	303*		303G*								1
TRX 90 X	2009-2022	303*		303G*								2
CRF 100 F	2004-2014	333		333G								3
NSF 100 R	2006	FA197		FA197HH	EPFA197HH						MD1169C	4
SL 100 K	1970-1974	303		303G								5
XL 100	1974	303		303G								6
XL 100	1976	304		304G								7
XL 100	1977-1978	303		303G								8
XL 100 All Models	1974	304		304G								9
XL 100 K1	1975	304		304G								10
XL 100 S	1979-1985	304		304G								11
XR 100	1981-1984	304		304G								12
XR 100 R	1985-2004	333		333G								13
ATC 110	1979-1985											14
CRF 110 R	2013-2023	333		333G								15
CT 110 Trail	1980-1986	303		303G								16
Navi 110	2022-2023	325										17
NHX 110 Elite	2010-2011	SFA323		SFA323HH				MD931D				18
ATC 125 M	1984-1987	303		303G								19
C 125 Super Cub	2018-2023	FA691		FA691HH								20
CB 125 F	2015-2021			FA679HH								21
CB 125 R	2019-2020			FA679HH								22
CB 125 S	1979-1982	304										23
CB 125 S	1984-1985	330										24
CB 125 TT	1990	FA124/2		FA124/2HH								25
CBR 125 R	2004-2010	FA375		FA375HH					MD644			26
CBR 125 RW	2011-2013	FA375		FA375HH					MD1166RS			27
CG 125	2001-2006	352										28
CG 125	2001-2004	FA54		FA54								29
CH 125 Elite	1984	303										30
CL 125 A	1965	306		306G								31
CL 125 S	1967-1974	303		303G								32
CL 125 S1	1967-1974	303		303G								33
CL 125 S1	1967-1974	304		304G								34
CR 125 M/M1 Elsinore	1973-1978	304		304G								35
CR 125 R	1990-1991	FA125X		FA125R				MD6003D				36
CR 125 R	1992-1994	FA125X		FA125R				MD6001D				37
CR 125 R	1995-1997	FA185X	MXS185	FA185R	EPFA185HH			MD6037D				38
CR 125 R	1998-2001	FA185X	MXS185	FA185R	EPFA185HH			MD6037D				39
CR 125 R	2002-2003	FA185X	MXS185	FA185R	EPFA185HH			MD6037D				40
CR 125 R	2004-2007	FA185X	MXS185	FA185R	EPFA185HH			MD6037D				41
CR 125 R Elsinore	1979-1981	324		324G								42
CR 125 RC	1982	330		330G								43
CR 125 RD	1983	331		331G								44
CR 125 RE	1984-1985	FA92X		FA92R				MD6087D				45
CR 125 RG	1986	FA92X		FA92R				MD6087D				46
CR 125 RH	1987-1988	FA125X		FA125R				MD6087D				47
CR 125 RK	1989	FA125X		FA125R				MD6008D				48
CRF 125 F	2014-2023	FA185X	MXS185	FA185R	EPFA185HH			MD6390D			MD6390C	49
CRF 125 FB	2014-2023	FA185X	MXS185	FA185R	EPFA185HH			MD6390D			MD6390C	50
CRG 125	2009-2010											51
CT 125	1977	304		304G								52
CT 125 Trail	2020-2022	FA375		FA375HH				TBC				53
Elite 125	2009-2010											54
Monkey 125 Z MA	2018-2023	FA375										55
MSX 125 Grom	2013-2020	FA375		FA375HH					MD1183			56

FRONT

* This symbol indicates a rotor made of billet steel, and should be only used with EBC FA Organic or Vee pads.

SAFETY NOTICE - With vehicles primarily designed for off highway use such as quads now being used on the highway, we would recommend the use of X or MXS pads for highway use and ONLY using the R and SV higher density / harder pad series for off road riding.

*-2 Sets Required. † For Vee disc colours add RED, BLU, GRN, GLD, ORG suffix to part number. **SAFETY WARNING:- DO NOT USE HH PADS ON REAR UNLESS ALSO USED ON FRONT TO AVOID BRAKE IMBALANCE**

FRONT: HONDA Cont'd

REAR: HONDA

Line #	BRAKE ROTOR CHOICES - FRONT					DISC PAD CHOICES - REAR					BRAKE ROTOR CHOICES - REAR					
	CX Extreme® /Vee-Rotor	OSX Series Oversize 280mm Rotor Kit	Relocating Bracket for Oversize Rotor	SMX Series Oversize 320mm Rotor Kit	Relocating Bracket for 320mm Rotor	Front Disc Bolt Kit	FA/SFA/X Pad or Brake Shoe	Specialty Pads SXR/ VEE/MXS Race	Sintered/ HH Pads/ Grooved Shoes	EPFA Sintered Fast Road/ Track Pads	SV Series Severe Duty Pads	Standard Rotor	Vintage Rotor / UTV Oversize Brake Kit	Contour Profile Rotor	CX Extreme® /Vee-Rotor	Rear Disc Bolt Kit
1							306		306G							
2							306		306G							
3							333		333G							
4							FA131X			EPFA131HH				MD1170C		
5							303		303G							
6							303		303G							
7							304		304G							
8							303		303G							
9							304		304G							
10							304		304G							
11							304		304G							
12							304		304G							
13							333		333G							
14							306		306G							
15							333		333G							
16							303		303G							
17							325									
18							352									
19							306		306G							
20							352									
21							FA629		FA629HH							
22							FA629		FA629HH							
23							304									
24							303									
25							310									
26							FA343		FA343HH			MD1151				
27							FA629		FA629HH			MD1151				
28							352									
29							352									
30							303									
31							307		307G							
32							303		303G							
33							303		303G							
34							304		304G							
35							304G		304G							
36							FA131X	MXS131	FA131R			MD6002D				
37	MD6001CX	OSX6001E	BRK004				FA131X	MXS131	FA131R			MD6002D			MD6002CX	
38	MD6037CX	OSX6037	BRK008	SMX6037	BRK009		FA131X	MXS131	FA131R			MD6002D			MD6002CX	
39	MD6037CX	OSX6037	BRK008	SMX6037	BRK009		FA131X	MXS131	FA131R			MD6124D			MD6124CX	
40	MD6037CX	OSX6037	BRK008	SMX6037	BRK009		FA346X	MXS346	FA346R	EPFA346HH		MD6191D			MD6191CX	
41	MD6037CX	OSX6437	BRK005	SMX6437	BRK006		FA346X	MXS346	FA346R	EPFA346HH		MD6191D			MD6191CX	
42							330		330G							
43							330		330G							
44							331		331G							
45							331		331G							
46							344		344G							
47							FA131X	MXS131	FA131R			MD6009D				
48							FA131X	MXS131	FA131R			MD6002D				
49							333		333G							
50							333		333G							
51																
52							304		304G							
53							FA343		FA343HH			TBC				
54																
55							FA343		FA343HH							
56	VR1183	OSX1183	BRK037				FA629		FA629HH			MD1184			VR1184	

BRAKE APPLICATIONS

⚠ This symbol indicates a rotor made of billet steel, and should be only used with EBC FA Organic or Vee pads.
 SAFETY NOTICE - With vehicles primarily designed for off highway use such as quads now being used on the highway, we would recommend the use of X or MXS pads for highway use and ONLY using the R and SV higher density / harder pad series for off road riding.

*-2 Sets Required. † For Vee disc colours add RED, BLU, GRN, GLD, ORG suffix to part number. **SAFETY WARNING:- DO NOT USE HH PADS ON REAR UNLESS ALSO USED ON FRONT TO AVOID BRAKE IMBALANCE**

FRONT: HONDA

APPLICATIONS
BRAKE



HONDA



DISC PAD CHOICES - FRONT

BRAKE ROTOR CHOICES - FRONT

Model	Year	FA/SFA/X Pad or Brake Shoe	Specialty Pads SXR/VEE/MXS Race	Sintered/HH Pads/Grooved Shoes	EPFA Sintered Fast Road/Track Pads	GPFA Sintered RACE ONLY Pads	SV Series Severe Duty Pads	Standard Rotor Left	Standard Rotor Right	Vintage Rotor / UTV Oversize Brake Kit	Contour Profile Rotor	Line #
MSX 125 Grom	2018-2024	FA375		FA375HH					MD1191		MD1191C	1
MT 125 K1 Elsinore	1974-1977	304		304G								2
NH 125 Aero	1984	303										3
NX 125	1988-1990	350										4
NXR 125	2003-2008	352										5
PCX 125	2011	SFA603		SFA603HH				MD9134D				6
PCX 125 S - WW AK	2018-2021	SFA693		SFA693HH				MD9177D				7
SL 125	1971-1973	303		303G								8
SS 125 A Supersport 125	1965	306										9
TL 125	1971-1975	304		304G								10
TL 125 S	1976	304		304G								11
TRX 125 Fourtrax	1985-1988	303*		303G*								12
XL 125	1974-1976	304		304G								13
XL 125	1977-1978	303		303G								14
XL 125 S	1979-1984	304		304G								15
XL 125 S	1985	330		330G								16
ADV 150 AN_A	2021-2023	SFA693		SFA693HH								17
CH 150/150 D Elite/Elite Deluxe	1985-1987	303										18
CRF 150 F	2003-2020	FA185X	MXS185	FA185R				MD6317D				19
CRF 150 R	2007-2024	FA84X	MXS84	FA84R				MD6314D			MD6314C	20
CRF 150 RB EXPERT	2018-2024	FA84X	MXS84	FA84R				MD6314D			MD6314C	21
NXR 150	2003-2005	352										22
NXR 150	2006-2008	FA185X	MXS185	FA185R								23
NXR 150	2006-2008	352										24
PCX 150 PCX	2018-2021	SFA693		SFA693HH				MD9177D				25
PCX 150 WW150	2009-2015	SFA603		SFA603HH				MD9134D				26
SH 150i	2010-2011	SFA323		SFA323HH				MD970D				27
XR 150 3 LA	2016-2023	FA185	MXS185	FA185R								28
ADV 160 A AC	2024	SFA693		SFA693HH				TBC				29
PCX 160 A AC	2023-2024	SFA693		SFA693HH				MD9134D				30
CD 175	1967-1968	306										31
CD 175 K3	1969-1971	306										32
CL 175/175 K3	1968-1972	308										33
MR 175 Elsinore	1975-1977	304		304G								34
SL 175 K1	1972-1973	309										35
XL 175	1973-1975	312		312G								36
XL 175	1976-1978	312		312G								37
ATC 185	1980	303		303G								38
ATC 185 S	1981-1983	303		303G								39
XL 185 S	1979-1983	304		304G								40
XR 185	1979	304		304G								41
ATC 200	1981-1983	303		303G								42
ATC 200 E Big Red	1982-1983	303		303G								43
ATC 200 ES Big Red	1984	303		303G								44
ATC 200 M	1984-1985	303		303G								45
ATC 200 S	1984-1986	303		303G								46
ATC 200 X	1983-1985	FA84X		FA84R			FA84SV	MD6059D				47
ATC 200 X	1986-1987	FA84X		FA84R			FA84SV	MD6059D				48
CM 200 T Twinstar	1980-1982	312										49
TLR 200 Reflex	1986-1987	304		304G								50
TR 200 Fatcat	1986-1987	304		304G								51
TRX 200 D Type II Fourtrax	1991-1997	345*		345G*								52
TRX 200 Fourtrax	1984	339*		339G*								53
TRX 200 Fourtrax	1990-1991	345*		345G*								54
TRX 200 SX Fourtrax	1986-1988	345*		345G*								55
XL 200 R	1983-1984	304		304G								56

FRONT

⚠ This symbol indicates a rotor made of billet steel, and should be only used with EBC FA Organic or Vee pads.
SAFETY NOTICE - With vehicles primarily designed for off highway use such as quads now being used on the highway, we would recommend the use of X or MXS pads for highway use and ONLY using the R and SV higher density / harder pad series for off road riding.

*-2 Sets Required. † For Vee disc colours add RED, BLU, GRN, GLD, ORG suffix to part number. SAFETY WARNING:- DO NOT USE HH PADS ON REAR UNLESS ALSO USED ON FRONT TO AVOID BRAKE IMBALANCE

FRONT: HONDA Cont'd

REAR: HONDA

Line #	BRAKE ROTOR CHOICES - FRONT					DISC PAD CHOICES - REAR					BRAKE ROTOR CHOICES - REAR				
	CX Extreme® /Vee-Rotor	OSX Series 280mm Rotor Kit	Relocating Bracket for Oversize Rotor	SMX Series Oversize 320mm Rotor Kit	Relocating Bracket for 320mm Rotor	Front Disc Bolt Kit	FA/SFA/X Pad or Brake Shoe	Specialty Pads SXR/ VEE/MXS Race	Sintered/ HH Pads/ Grooved Shoes	EPFA Sintered Fast Road/ Track Pads	SV Series Severe Duty Pads	Standard Rotor	Vintage Rotor / UTV Oversize Brake Kit	Contour Profile Rotor	CX Extreme® /Vee-Rotor
1	VR1191	OSX1191	BRK048					FA629		FA629HH				VR1184	
2								304		304G					
3								303							
4								304		304G					
5								304		304G					
6								352							
7								352							
8								304		304G					
9								307							
10								304		304G					
11								304		304G					
12								306		306G					
13								304		304G					
14								303		303G					
15								304		304G					
16								304		304G					
17								SFA415		SFA415HH					
18								303							
19		OSX6317	BRK008	SMX6317	BRK009			304		304G					
20	MD6314CX	OSX6314	BRK026					FA346X	MXS346	FA346R		MD6316D	MD6316C	MD6316CX	
21	MD6314CX	OSX6314	BRK026					FA346X	MXS346	FA346R		MD6316D			
22								304		304G					
23								304		304G					
24								304		304G					
25								352							
26								352							
27								352							
28								304		304G					
29								352							
30								352							
31								307							
32								307							
33								309							
34								304		304G					
35								309							
36								310		310G					
37								310		310G					
38								306		306G					
39								306		306G					
40								304		304G					
41								304		304G					
42								306		306G					
43								306		306G					
44								306		306G					
45								306		306G					
46								306		306G					
47										FA84/2R		MD6059D			
48								FA84X		FA84R	FA84SV	MD6059D			
49								310							
50								333		333G					
51								304		304G					
52								306		306G					
53								306		306G					
54								306		306G					
55								306		306G					
56								304		304G					

⚠ This symbol indicates a rotor made of billet steel, and should be only used with EBC FA Organic or Vee pads.
SAFETY NOTICE - With vehicles primarily designed for off highway use such as quads now being used on the highway, we would recommend the use of X or MXS pads for highway use and ONLY using the R and SV higher density / harder pad series for off road riding.

*-2 Sets Required. † For Vee disc colours add RED, BLU, GRN, GLD, ORG suffix to part number. **SAFETY WARNING:- DO NOT USE HH PADS ON REAR UNLESS ALSO USED ON FRONT TO AVOID BRAKE IMBALANCE**

FRONT: HONDA

APPLICATIONS

BRAKE



HONDA



SAFETY NOTICE - With vehicles primarily designed for off highway use such as quads now being used on the highway, we would recommend the use of X or MXS pads for highway use and ONLY using the R and SV higher density / harder pad series for off road riding.

This symbol indicates a rotor made of billet steel, and should be only used with EBC FA Organic or Vee pads.

Model	Year	DISC PAD CHOICES - FRONT						BRAKE ROTOR CHOICES - FRONT				Line #
		FA/SFA/X Pad or Brake Shoe	Specialty Pads SXR/VEE/MXS Race	Sintered/HH Pads/Grooved Shoes	EPFA Sintered Fast Road/Track Pads	GPFAX Sintered RACE ONLY Pads	SV Series Severe Duty Pads	Standard Rotor Left	Standard Rotor Right	Vintage Rotor / UTV Oversize Brake Kit	Contour Profile Rotor	
XR 200 R	1980-1984	304		304G								1
XR 200 R	1984-2002	304		304G								2
XR 200 R Pro Link	1981-1983	304		304G								3
RC 213 V-S	2015-2017			FA447HH*	EPFA447HH*	GPFAX447HH*						4
CRF 230 F AC	2003-2020	FA185X	MXS185	FA185R	EPFA185HH			MD6001D				5
CRF 230 L	2008-2011	FA185X	MXS185	FA185R	EPFA185HH			MD6001D				6
CRF 230 M	2009-2011	FA185X	MXS185	FA185R	EPFA185HH			MD6001D				7
ATC 250 ES Big Red	1985-1987	306		306G								8
ATC 250 R	1981	FA54X		FA54R			FA54SV	MD6060D				9
ATC 250 R	1982	FA54X		FA54R			FA54SV	MD6060D				10
ATC 250 R	1983-1984	FA84X		FA84R			FA84SV	MD6059D				11
ATC 250 R	1985-1986	FA92X		FA92R				MD6059D				12
ATC 250 SX	1985-1987	306		306G								13
CB 250 N/T	1978-1982	FA45						MD1036LS		VMD1036		14
CB 250 Nighthawk	1991-2008	312										15
CBR 250 R	2011-2014	FA226		FA226HH	EPFA226HH				MD1180X			16
CBR 250 RA	2011-2014	FA388		FA388HH	EPFA388HH				MD1180X			17
CH 250 Elite	1987-1990	330										18
CH 250 Elite	1985-1986	330										19
CM 250 C Custom	1982-1983	312										20
CMX 250 C Rebel	1996-1997	FA228		FA228HH				MD1030				21
CMX 250 C Rebel	1999-2014	FA228		FA228HH				MD1030				22
CMX 250 C/CD Rebel	1985-1987	FA86		FA86HH					MD1030			23
CMX 250 C2	1999-2000	FA228						MD1030				24
CMX 250 X	2015	FA228						MD1030				25
CN 250 Helix	1986-1987	FA69		FA69HH				MD908D				26
CN 250 Helix	1992-1993	FA69/2						MD908D				27
CN 250 Helix	1994-2001	SFA142		SFA142HH				MD908D				28
CN 250 Helix	2005-2007	SFA142		SFA142HH				MD908D				29
CR 250 M1/M/M76 Elsinore	1973-1976	312		312G								30
CR 250 R	1992-1994	FA125X		FA125R				MD6001D				31
CR 250 R	1997-2001	FA185X	MXS185	FA185R	EPFA185HH			MD6037D				32
CR 250 R	2002-2003	FA185X	MXS185	FA185R	EPFA185HH			MD6037D				33
CR 250 R	2004-2007	FA185X	MXS185	FA185R	EPFA185HH			MD6037D				34
CR 250 R Elsinore	1978-1980	324		324G								35
CR 250 RB	1981	327		327G								36
CR 250 RC	1982	328		328G								37
CR 250 RD	1983	328		328G								38
CR 250 RE	1984-1985	FA92X		FA92R				MD6087D				39
CR 250 RG	1986	FA92X		FA92R				MD6087D				40
CR 250 RH	1987-1988	FA125X		FA125R				MD6087D				41
CR 250 RK	1989	FA125X		FA125R				MD6008D				42
CR 250 RL	1990-1991	FA125X		FA125R				MD6003D				43
CR 250 RS	1995-1996	FA185X	MXS185	FA185R	EPFA185HH			MD6037D				44
CRF 250 L	2013-2021	FA465X	MXS465	FA465R								45
CRF 250 LA	2019-2021	FA465X	MXS465	FA465R								46
CRF 250 R	2004-2014	FA185X	MXS185	FA185R	EPFA185HH			MD6037D				47
CRF 250 R AC	2015-2024	FA185X	MXS185	FA185R	EPFA185HH						MD6389C	48
CRF 250 RL Rally	2019-2021	FA465X	MXS465	FA465R							MD6409C	49
CRF 250 RLA Rally	2019-2021	FA465X	MXS465	FA465R							MD6409C	50
CRF 250 RX	2019-2024	FA185X	MXS185	FA185R	EPFA185HH						MD6389C	51
CRF 250 X	2004-2016	FA185X	MXS185	FA185R	EPFA185HH			MD6037D				52
FL 250 Odyssey	1977-1984											53
FL 250 Odyssey	1977-1984											54
MR 250 Elsinore	1976	311		311G								55
MT 250	1974-1976	311		311G								56

FRONT

*-2 Sets Required. † For Vee disc colours add RED, BLU, GRN, GLD, ORG suffix to part number. **SAFETY WARNING:- DO NOT USE HH PADS ON REAR UNLESS ALSO USED ON FRONT TO AVOID BRAKE IMBALANCE**

FRONT: HONDA Cont'd

REAR: HONDA

Line #	BRAKE ROTOR CHOICES - FRONT					DISC PAD CHOICES - REAR					BRAKE ROTOR CHOICES - REAR					
	CX Extreme® /Vee-Rotor	OSX Series 280mm Rotor Kit	Relocating Bracket for Oversize Rotor	SMX Series 320mm Rotor Kit	Relocating Bracket for 320mm Rotor	Front Disc Bolt Kit	FA/SFA/X Pad or Brake Shoe	Specialty Pads SXR/ VEE/MXS Race	Sintered/ HH Pads/ Grooved Shoes	EPFA Sintered Fast Road/ Track Pads	SV Series Severe Duty Pads	Standard Rotor	Vintage Rotor / UTV Oversize Brake Kit	Contour Profile Rotor	CX Extreme® /Vee-Rotor	Rear Disc Bolt Kit
1							304		304G							
2							304		304G							
3							304		304G							
4							FA266		FA266HH							
5	MD6001CX	OSX6001	BRK008	SMX6001	BRK009		304		304G							
6	MD6001CX	OSX6001	BRK008	SMX6001	BRK009		FA131X	MXS131	FA131R			MD6013D			MD6013CX	
7	MD6001CX	OSX6001	BRK008	SMX6001	BRK009		FA131X	MXS131	FA131R			MD6013D			MD6013CX	
8							315		315G							
9							306		306G							
10									FA84/2R							
11							FA84X		FA84R		FA84SV	MD6059D				
12							FA92X		FA92R			MD6007D				
13							315		315G							
14							313									
15							310									
16							FA496		FA496HH			MD1004				
17							FA496		FA496HH			MD1181				
18							350									
19							341									
20							310									
21							318									
22							318									
23							310									
24							318									
25							318									
26							350									
27							350									
28							350									
29							350									
30							312		312G							
31	MD6001CX	OSX6001E	BRK004				FA131X	MXS131	FA131R			MD6002D			MD6002CX	
32	MD6037CX	OSX6037	BRK008	SMX6037	BRK009		FA131X	MXS131	FA131R			MD6124D			MD6124CX	
33	MD6037CX	OSX6037	BRK008	SMX6037	BRK009		FA346X	MXS346	FA346R			MD6191D			MD6191CX	
34	MD6037CX	OSX6437	BRK005	SMX6437	BRK006		FA346X	MXS346	FA346R			MD6191D			MD6191CX	
35							325		325G							
36							319		319G							
37							330		330G							
38							331		331G							
39							331		331G							
40							344		344G							
41							FA131X	MXS131	FA131R			MD6009D				
42							FA131X	MXS131	FA131R			MD6002D				
43							FA131X	MXS131	FA131R			MD6002D				
44	MD6037CX	OSX6037	BRK008	SMX6037	BRK009		FA131X	MXS131	FA131R			MD6002D			MD6002CX	
45	MD6372CX						FA629X		FA629R				MD6373C		MD6373CX	
46	MD6372CX						FA629X		FA629R				MD6373C		MD6373CX	
47	MD6037CX	OSX6437	BRK005	SMX6437	BRK006		FA346X	MXS346	FA346R			MD6191D			MD6191CX	
48	MD6389CX	OSX6389	BRK042	SMX6389	BRK041		FA346X	MXS346	FA346R			MD6191D			MD6191CX	
49							FA629X		FA629R				MD6373C			
50							FA629X		FA629R				MD6373C			
51	MD6389CX	OSX6389	BRK042	SMX6389	BRK041		FA346X	MXS346	FA346R			MD6191D			MD6191CX	
52	MD6037CX	OSX6437	BRK005	SMX6437	BRK006		FA346X	MXS346	FA346R			MD6191D			MD6191CX	
53							FA40									
54							306		306G							
55							312		312G							
56							312		312G							

BRAKE APPLICATIONS
⚠ This symbol indicates a rotor made of billet steel, and should be only used with EBC FA Organic or Vee pads.
SAFETY NOTICE - With vehicles primarily designed for off highway use such as quads now being used on the highway, we would recommend the use of X or MXS pads for highway use and ONLY using the R and SV higher density / harder pad series for off road riding.

*-2 Sets Required. † For Vee disc colours add RED, BLU, GRN, GLD, ORG suffix to part number. **SAFETY WARNING:- DO NOT USE HH PADS ON REAR UNLESS ALSO USED ON FRONT TO AVOID BRAKE IMBALANCE**

FRONT: HONDA

APPLICATIONS

BRAKE



HONDA



DISC PAD CHOICES - FRONT

BRAKE ROTOR CHOICES - FRONT

FA/SFA/X Pad or Brake Shoe	Specialty Pads SXR/ VEE/MXS Race	Sintered/ HH Pads/ Grooved Shoes	EPFA Sintered Fast Road/ Track Pads	GPFA Sintered RACE ONLY Pads	SV Series Severe Duty Pads	Standard Rotor Left	Standard Rotor Right	Vintage Rotor / UTV Oversize Brake Kit	Contour Profile Rotor
		FA347HH	EPFA347HH	GPFA347HH		MD1003D	MD1003D		
SFA281		SFA281HH				MD922D			
FA185X	MXS185	FA185R	EPFA185HH			MD6001D			
SFA388		SFA388HH				MD922D			
304		304G							
FA84X*		FA84R*			FA84SV*	MD6006D	MD6006D		
339*		339G*							
FA125X*		FA125R*				MD6046D	MD6046D		
FA125X*		FA125R*				MD6006D	MD6006D		
345*		345G*							
345*		345G*							
FA84X*		FA84R*			FA84SV*	MD6006D	MD6006D		
FA84X*		FA84R*			FA84SV*	MD6006D	MD6006D		
FA80/2									
FA124/2		FA124/2HH							
311									
330		330G							
312		312G							
312		312G							
312		312G							
FA125X		FA125R				MD6001D			
FA185X	MXS185	FA185R	EPFA185HH			MD6001D			
FA185X	MXS185	FA185R	EPFA185HH			MD6001D			
327		327G							
FA92X		FA92R				MD6087D			
FA125X		FA125R				MD6087D			
FA125X		FA125R				MD6087D			
FA125X		FA125R				MD6001D			
FA196		FA196HH							
FA226		FA226HH	EPFA226HH				MD1180X		
FA196		FA196HH							
		FA679HH					MD1180X		MD1180XC
FA226		FA226HH	EPFA226HH				MD1180X		MD1180XC
FA196	FA196V	FA196HH							
FA196	FA196V	FA196HH							
FA226		FA226HH	EPFA226HH				MD1180X		MD1180XC
FA196	FA196V	FA196HH					MD1180X		
FA465X	MXS465	FA465R							
FA465X	MXS465	FA465R							MD6409C
SFA388		SFA388HH					MD9119D		
333									
SFA196		SFA196HH				MD9119D			
SFA388		SFA388HH					MD9119D		
333									
FA84X*		FA84R*			FA84SV*	MD6006D	MD6006D		
345*		345G*							
347*		347G*							
FA84X*		FA84R*			FA84SV*	MD6006D	MD6006D		
FA92X		FA92R				MD6059D			
FA125X		FA125R				MD6059D			
339*		339G*							
314									
308									
342*		342G*							
347*		347G*							
347*		347G*							

Line #

FRONT

⚠ This symbol indicates a rotor made of billet steel, and should be only used with EBC FA Organic or Vee pads. SAFETY NOTICE - With vehicles primarily designed for off highway use such as quads now being used on the highway, we would recommend the use of X or MXS pads for highway use and ONLY using the R and SV higher density / harder pad series for off road riding.

*-2 Sets Required. † For Vee disc colours add RED, BLU, GRN, GLD, ORG suffix to part number. SAFETY WARNING:- DO NOT USE HH PADS ON REAR UNLESS ALSO USED ON FRONT TO AVOID BRAKE IMBALANCE

FRONT: HONDA Cont'd

REAR: HONDA

Line #	BRAKE ROTOR CHOICES - FRONT					DISC PAD CHOICES - REAR					BRAKE ROTOR CHOICES - REAR					
	CX Extreme® /Vee-Rotor	OSX Series Oversize 280mm Rotor Kit	Relocating Bracket for Oversize Rotor	SMX Series Oversize 320mm Rotor Kit	Relocating Bracket for 320mm Rotor	Front Disc Bolt Kit	FA/SFA/X Pad or Brake Shoe	Specialty Pads SXR/ VEE/MXS Race	Sintered/ HH Pads/ Grooved Shoes	EPFA Sintered Fast Road/ Track Pads	SV Series Severe Duty Pads	Standard Rotor	Vintage Rotor / UTV Oversize Brake Kit	Contour Profile Rotor	CX Extreme® /Vee-Rotor	Rear Disc Bolt Kit
1						DB102/6	FA151									
2							SFA358	SFA358HH				MD1004				
3	MD6001CX						323	323G								
4							351									
5							304	304G								
6							340	340G								
7							315	315G								
8							FA92X	FA92R				MD6007D				
9							FA92X	FA92R				MD6007D				
10							340	340G								
11							340	340G								
12							340	340G								
13							FA84X	FA84R		FA84SV	MD6064D					
14							309									
15							309									
16							312	312G								
17							323	323G								
18							323	323G								
19							318	318G								
20							323	323G								
21	MD6001CX	OSX6001E	BRK004				FA131X	MXS131	FA131R			MD6013D		MD6013CX		
22	MD6001CX	OSX6001	BRK008	SMX6001	BRK009		FA131X	MXS131	FA131R			MD6013D		MD6013CX		
23	MD6001CX	OSX6001	BRK008	SMX6001	BRK009		FA131X	MXS131	FA131R			MD6013D		MD6013CX		
24							323	323G								
25							304	304G								
26							304	304G								
27							FA131X	MXS131	FA131R			MD6013D				
28	MD6001CX	OSX6001E	BRK004				FA131X	MXS131	FA131R			MD6013D		MD6013CX		
29							FA496	FA496HH								
30							FA496	FA496HH								
31							FA496	FA496HH								
32							FA629	FA629HH					TBC			
33							FA496	FA496HH								
34							FA496	FA496HH								
35							FA496	FA496HH								
36							FA496	FA496HH								
37							FA496	FA496HH				MD1181		MD1181C		
38	MD6372CX						FA629X	FA629R							MD6373CX	
39							FA629X	FA629R							MD6373CX	
40							SFA415	SFA415HH				MD9139D				
41																
42							SFA415	SFA415HH				MD1149				
43							SFA415	SFA415HH				MD9139D		MD1149C		
44																
45							FA84X	FA84R		FA84SV	MD6064D					
46							315	315G								
47							315	315G								
48							FA84X	FA84R		FA84SV	MD6064D					
49							FA84X	FA84R		FA84SV	MD6061D					
50							FA84X	FA84R		FA84SV	MD6061D					
51								FA111R								
52							315									
53							309									
54							343	343G								
55							351	351G								
56							351	351G								

BRAKE APPLICATIONS

⚠ This symbol indicates a rotor made of billet steel, and should be only used with EBC FA Organic or Vee pads.
 SAFETY NOTICE - With vehicles primarily designed for off highway use such as quads now being used on the highway, we would recommend the use of X or MXS pads for highway use and ONLY using the R and SV higher density / harder pad series for off road riding.

*-2 Sets Required. † For Vee disc colours add RED, BLU, GRN, GLD, ORG suffix to part number. **SAFETY WARNING:- DO NOT USE HH PADS ON REAR UNLESS ALSO USED ON FRONT TO AVOID BRAKE IMBALANCE**

FRONT: HONDA

APPLICATIONS

BRAKE



HONDA



DISC PAD CHOICES - FRONT

BRAKE ROTOR CHOICES - FRONT

Model	Year	FA/SFA/X Pad or Brake Shoe	Specialty Pads SXR/VEE/MXS Race	Sintered/HH Pads/Grooved Shoes	EPFA Sintered Fast Road/Track Pads	GPFAX Sintered RACE ONLY Pads	SV Series Severe Duty Pads	Standard Rotor		Vintage Rotor / UTV Oversize Brake Kit	Contour Profile Rotor	Line #
								Standard Rotor Left	Standard Rotor Right			
XL 350 R	1984-1985	FA92X		FA92R				MD6087D				1
XR 350 R	1983	331		331G								2
XR 350 R	1984-1985	FA92X		FA92R				MD6087D				3
CB 360	1974-1976	FA13	FA13V									4
CJ 360	1976-1977	314										5
CB 400 A Hondamatic	1978	FA45										6
CB 400 F	1975-1977	FA13	FA13V									7
CB 400 F CB-1	1989-1990	FA142	FA142V	FA142HH					MD1038RS			8
CB 400 T Hawk	1980-1981	FA45						MD1036LS		VMD1036		9
CB 400 T MK II Hawk	1978-1979	FA45										10
CB 400 T MKI Hawk	1978-1979	314										11
CM 400 A/T	1979-1981	FA45						MD1036LS		VMD1036		12
CM 400 C Custom	1981	FA69/2						MD1036LS		VMD1036		13
CM 400 E	1980-1981	314										14
FL 400 R Pilot	1989-1990	339*		339G*								15
TRX 400 EX Fourtrax	1999-2000	FA84X*		FA84R*			FA84SV*	MD6006D	MD6006D			16
TRX 400 EX Sportrax	2001-2008	FA84X*		FA84R*			FA84SV*	MD6006D	MD6006D			17
TRX 400 FA Fourtrax Rancher AT	2004-2007	347*		347G*								18
TRX 400 FGA Fourtrax Rancher AT Gpscape	2004-2007	347*		347G*								19
TRX 400 FM Fourtrax Foreman	2002	347*		347G*								20
TRX 400 FW Fourtrax Foreman	1995-2001	347*		347G*								21
TRX 400 FW Fourtrax Foreman	2003	347*		347G*								22
TRX 400 X	2009-2013	FA84X*		FA84R*			FA84SV*	MD6006D	MD6006D			23
XR 400 R	1996-2004	FA185X	MXS185	FA185R	EPFA185HH			MD6001D				24
TRX 420 FA Fourtrax Rancher AT	2009-2014	FA84X*		FA84R*			FA84SV*	MD6302D	MD6302D			25
TRX 420 Fourtrax Rancher	2006-2024	FA84X*		FA84R*			FA84SV*	MD6302D	MD6302D			26
TRX 420 Fourtrax Rancher FA5-FA6	2006-2024	FA84X*		FA84R*			FA84SV*	MD6302D	MD6302D			27
TRX 420 FPA Fourtrax Rancher AT	2009-2012	FA84X*		FA84R*			FA84SV*	MD6302D	MD6302D			28
TRX 420 TM Fourtrax Rancher	2006-2013	FA84X*		FA84R*			FA84SV*	MD6302D	MD6302D			29
TRX 420 TM1 Rancher	2014-2021	FA84X*		FA84R*			FA84SV*	MD6302D	MD6302D			30
CB 450 DX-K	1989-1992	FA122*										31
CB 450 K3-K4	1970-1971	FA12	FA12V									32
CB 450 K5-K7	1972-1974	FA13	FA13V									33
CB 450 SC Nighthawk	1982	FA90						MD1036LS		VMD1036		34
CB 450 SC Nighthawk	1983-1986	FA69		FA69HH				MD1040LS				35
CB 450 T Hawk	1982	FA90						MD1036LS		VMD1036		36
CM 450 A Hondamatic	1982	FA69/2						MD1036LS		VMD1036		37
CM 450 A Hondamatic	1983	FA90						MD1040LS				38
CM 450 C Custom	1982	FA90						MD1036LS		VMD1036		39
CM 450 C Custom	1982	FA69/2						MD1036LS		VMD1036		40
CM 450 E	1982-1983	314										41
CMX 450 C Rebel	1986-1987	FA69		FA69HH				MD1041LS				42
CR 450 R	1981	327		327G								43
CRF 450 L	2018-2020	FA185X	MXS185	FA185R	EPFA185HH							44
CRF 450 R	2002-2003	FA185X	MXS185	FA185R	EPFA185HH			MD6037D				45
CRF 450 R	2004-2014	FA185X	MXS185	FA185R	EPFA185HH			MD6037D				46
CRF 450 R	2015-2024	FA185X	MXS185	FA185R	EPFA185HH							47
CRF 450 RL	2021-2024	FA185X	MXS185	FA185R	EPFA185HH							48
CRF 450 R-S	2022-2024	FA185X	MXS185	FA185R								49
CRF 450 RWE	2019-2023	FA185X	MXS185	FA185R	EPFA185HH							50
CRF 450 RX	2017-2023	FA185X	MXS185	FA185R	EPFA185HH							51
CRF 450 X	2005-2022	FA185X	MXS185	FA185R	EPFA185HH			MD6037D				52
TRX 450	2004-2011	FA185X*	MXS185*	FA185R*	EPFA185HH*			MD6006D	MD6006D			53
TRX 450 FE Fourtrax Foreman ES	2002-2004	347*		347G*								54
TRX 450 FM Fourtrax Foreman S	2002-2004	347*		347G*								55
TRX 450 Fourtrax Foreman ES	1998-2001	347S*		347SG*								56

*-2 Sets Required. † For Vee disc colours add RED, BLU, GRN, GLD, ORG suffix to part number. **SAFETY WARNING:- DO NOT USE HH PADS ON REAR UNLESS ALSO USED ON FRONT TO AVOID BRAKE IMBALANCE**

This symbol indicates a rotor made of billet steel, and should be only used with EBC FA Organic or Vee pads. SAFETY NOTICE - With vehicles primarily designed for off highway use such as quads now being used on the highway, we would recommend the use of X or MXS pads for highway use and ONLY using the R and SV higher density / harder pad series for off road riding.

FRONT: HONDA Cont'd

REAR: HONDA

Line #	BRAKE ROTOR CHOICES - FRONT					DISC PAD CHOICES - REAR					BRAKE ROTOR CHOICES - REAR					
	CX Extreme® /Vee-Rotor	OSX Series Oversize 280mm Rotor Kit	Relocating Bracket for Oversize Rotor	SMX Series Oversize 320mm Rotor Kit	Relocating Bracket for 320mm Rotor	Front Disc Bolt Kit	FA/SFA/X Pad or Brake Shoe	Specialty Pads SXR/ VEE/MXS Race	Sintered/ HH Pads/ Grooved Shoes	EPFA Sintered Fast Road/ Track Pads	SV Series Severe Duty Pads	Standard Rotor	Vintage Rotor / UTV Oversize Brake Kit	Contour Profile Rotor	CX Extreme® /Vee-Rotor	Rear Disc Bolt Kit
1								323		323G						
2								304		304G						
3								304		304G						
4								315								
5								315								
6								313								
7								315								
8							FA140		FA140HH			MD1020				
9							313									
10							313									
11							313									
12							313									
13							313									
14							313									
15																
16																
17							FA84X		FA84R		FA84SV	MD6164D				
18							FA84X		FA84R		FA84SV	MD6164D				
19							351		351G							
20							351		351G							
21							351		351G							
22							351		351G							
23							FA84X		FA84R		FA84SV	MD6164D				
24	MD6001CX	OSX6001	BRK008	SMX6001	BRK009		FA131X	MXS131	FA131R	EPFA131HH		MD6013D			MD6013CX	
25							FA373X		FA373R		FA373SV	MD6217D				
26							351		351G							
27							FA373X		FA373R		FA373SV	MD6217D				
28							FA373X		FA373R		FA373SV	MD6217D				
29							351		351G							
30							351		351G							
31							FA122									
32							316									
33							316									
34							313									
35							313									
36							313									
37							313									
38							313									
39							313									
40							313									
41							313									
42							313									
43							319		319G							
44							FA346X	MXS346	FA346R	EPFA346HH		MD6191D				
45	MD6037CX	OSX6037	BRK008	SMX6001	BRK009		FA346X	MXS346	FA346R	EPFA346HH		MD6191D			MD6191CX	
46	MD6037CX	OSX6437	BRK005	SMX6437	BRK006		FA346X	MXS346	FA346R	EPFA346HH		MD6191D			MD6191CX	
47	MD6389CX	OSX6389	BRK042	SMX6389	TBC		FA346X	MXS346	FA346R	EPFA346HH		MD6191D			MD6191CX	
48							FA346X	MXS346	FA346R	EPFA346HH		MD6191D			MD6191CX	
49	MD6389CX	OSX6389	BRK042	SMX6389	TBC		FA346X	MXS346	FA346R	EPFA346HH		MD6191D			MD6191CX	
50	MD6389CX	OSX6389	BRK042	SMX6389	TBC		FA346X	MXS346	FA346R	EPFA346HH		MD6191D			MD6191CX	
51	MD6389CX	OSX6389	BRK042	SMX6389	BRK041		FA346X	MXS346	FA346R	EPFA346HH		MD6191D			MD6191CX	
52	MD6037CX	OSX6037	BRK005	SMX6037	BRK006		FA346X	MXS346	FA346R	EPFA346HH		MD6191D			MD6191CX	
53							FA373X		FA373R		FA373SV	MD6233D				
54							351		351G							
55							351		351G							
56							351		351G							

BRAKE APPLICATIONS
 This symbol indicates a rotor made of billet steel, and should be only used with EBC FA Organic or Vee pads.
 SAFETY NOTICE - With vehicles primarily designed for off highway use such as quads now being used on the highway, we would recommend the use of X or MXS pads for highway use and ONLY using the R and SV higher density / harder pad series for off road riding.

*-2 Sets Required. † For Vee disc colours add RED, BLU, GRN, GLD, ORG suffix to part number. **SAFETY WARNING:- DO NOT USE HH PADS ON REAR UNLESS ALSO USED ON FRONT TO AVOID BRAKE IMBALANCE**

FRONT: HONDA

APPLICATIONS
BRAKE



HONDA



DISC PAD CHOICES - FRONT

BRAKE ROTOR CHOICES - FRONT

Model	Year	FA/SFA/X Pad or Brake Shoe	Specialty Pads SXR/ VEE/MXS Race	Sintered/ HH Pads/ Grooved Shoes	EPFA Sintered Fast Road/ Track Pads	GPFA Sintered RACE ONLY Pads	SV Series Severe Duty Pads	Standard Rotor		Vintage Rotor / UTV Oversize Brake Kit	Contour Profile Rotor	Line #
								Standard Rotor Left	Standard Rotor Right			
TRX 450 Fourtrax Foreman S	1998-2001	347S*		347SG*								1
CR 480 RC	1982	327		327G								2
CR 480 RD	1983	328		328G								3
CB 500 F	2021-2023	FA759*	FA759V*	FA759HH*							TBC*	4
CB 500 F	2013-2020	FA196	FA196V	FA196HH							MD1200C	5
CB 500 FA	2013-2022	FA196	FA196V	FA196HH							MD1200C	6
CB 500 T	1975-1977	FA13	FA13V									7
CB 500 X	2013-2018	FA196		FA196HH							MD1200C	8
CB 500 X	2021-2023	FA196*		FA196HH*							TBC*	9
CB 500 XA	2013-2018	FA196		FA196HH							MD1200C	10
CB 500 XA	2019-2021	FA196		FA196HH							TBC	11
CBR 500 R	2013-2020	FA196	FA196V	FA196HH							MD1200C	12
CBR 500 R	2021-2022	FA759*	FA759V*	FA759HH*							TBC*	13
CBR 500 RA	2013-2022	FA196	FA196V	FA196HH							MD1200C	14
CMX 500 Rebel	2018-2023	FA196	FA196V	FA196HH								15
CR 500 R	1992-1994	FA125X		FA125R				MD6001D				16
CR 500 R	1995-2001	FA185X	MXS185	FA185R	EPFA185HH			MD6037D				17
CR 500 RE	1984-1985	FA92X		FA92R				MD6087D				18
CR 500 RG	1986	FA92X		FA92R				MD6087D				19
CR 500 RH	1987-1988	FA125X		FA125R				MD6087D				20
CR 500 RK	1989	FA125X		FA125R				MD6008D				21
CR 500 RL	1990-1991	FA125X		FA125R				MD6003D				22
CX 500	1978-1979	FA29										23
CX 500 C Custom	1979-1981	FA29										24
CX 500 C Custom	1982	FA69		FA69HH								25
CX 500 D Deluxe	1979-1981	FA29										26
CX 500 TC Turbo	1982	FA69*		FA69HH*								27
FT 500 Ascot	1982-1983	FA69		FA69HH				MD1131LS				28
GB 500	1989-1990	FA69		FA69HH				MD1001				29
GL 500 I Silverwing Interstate	1981-1982	FA69/2*										30
GL 500 Silverwing	1981-1982	FA69		FA69HH								31
SCL 500 Street Scrambler	2023-2024	FA196	FA196V	FA196HH								32
SXS 500 Pioneer	2018-2022	FA712X*		FA712R*			FA712SV*	MD6341D	MD6341D			33
SXS 500 SXS M2 Pioneer	2015-2017	FA712X*		FA712R*			FA712SV*	MD6341D	MD6341D			34
TRX 500 FA Fourtrax Rubicon	2001-2004	347*		347G*								35
TRX 500 FGA Fourtrax Foreman Rubicon Gpscape	2004	347*		347G*								36
TRX 500 Fourtrax Foreman	2005-2011	FA410X*		FA410R*			FA410SV*	MD6251D	MD6251D			37
TRX 500 Fourtrax Foreman/Rubicon	2014-2021	FA84X*		FA84R*			FA84SV*	MD6387D	MD6387D			38
VF 500 C V30 Magna	1984-1985	FA69		FA69HH				MD1047LS				39
VF 500 F Interceptor	1984-1986	FA69*		FA69HH*				MD1006	MD1006		MD1006C*	40
VT 500 C Shadow	1983-1986	FA69		FA69HH				MD1047LS				41
VT 500 FT Ascot	1983-1984	FA69		FA69HH				MD1047LS				42
XL 500 R Pro Link	1982	332		332G								43
XL 500 S	1979-1981	312		312G								44
XR 500	1979-1980	324		324G								45
XR 500 R Pro Link	1981-1982	327		327G								46
XR 500 R Pro Link	1983-1984	FA92X		FA92R				MD6087D				47
SXS 520 M AC	2021-2023	FA712X*		FA712R*			FA712SV*	MD6341D	MD6341D			48
TRX 520 FA5 A/AC Foreman Rubicon 4x4	2020-2024	FA84X*		FA84R*			FA84SV*	MD6387D	MD6387D			49
TRX 520 FA6 Foreman Rubicon 4x4	2020-2022	FA84X*		FA84R*			FA84SV*	MD6387D	MD6387D			50
TRX 520 FA7 Foreman Rubicon 4x4	2020-2022	FA84X*		FA84R*			FA84SV*	MD6387D	MD6387D			51
TRX 520 FE2 Foreman ES/EPS	2020-2022	FA84X*		FA84R*			FA84SV*	MD6387D	MD6387D			52
TRX 520 FM1 Foreman	2020-2022	FA84X*		FA84R*			FA84SV*	MD6387D	MD6387D			53
TRX 520 FM2 Foreman ES/EPS	2020-2022	FA84X*		FA84R*			FA84SV*	MD6387D	MD6387D			54
TRX 520 FM6 Foreman Rubicon 4x4 EPS	2020-2022	FA84X*		FA84R*			FA84SV*	MD6387D	MD6387D			55
CB 550 F	1975-1977	FA13	FA13V									56

FRONT

⚠ This symbol indicates a rotor made of billet steel, and should be only used with EBC FA Organic or Vee pads.
SAFETY NOTICE - With vehicles primarily designed for off highway use such as quads now being used on the highway, we would recommend the use of X or MXS pads for highway use and ONLY using the R and SV higher density / harder pad series for off road riding.

*-2 Sets Required. † For Vee disc colours add RED, BLU, GRN, GLD, ORG suffix to part number. SAFETY WARNING:- DO NOT USE HH PADS ON REAR UNLESS ALSO USED ON FRONT TO AVOID BRAKE IMBALANCE

FRONT: HONDA Cont'd

REAR: HONDA

Line #	BRAKE ROTOR CHOICES - FRONT					DISC PAD CHOICES - REAR					BRAKE ROTOR CHOICES - REAR					
	CX Extreme® /Vee-Rotor	OSX Series 280mm Rotor Kit	Relocating Bracket for Oversize Rotor	SMX Series Oversize 320mm Rotor Kit	Relocating Bracket for 320mm Rotor	Front Disc Bolt Kit	FA/SFA/X Pad or Brake Shoe	Specialty Pads SXR/ VEE/MXS Race	Sintered/ HH Pads/ Grooved Shoes	EPFA Sintered Fast Road/ Track Pads	SV Series Severe Duty Pads	Standard Rotor	Vintage Rotor / UTV Oversize Brake Kit	Contour Profile Rotor	CX Extreme® /Vee-Rotor	Rear Disc Bolt Kit
1							351		351G							
2							330		330G							
3							331		331G							
4							FA140		FA140HH				TBC			
5							FA140		FA140HH				MD1156			
6							FA140		FA140HH				MD1156			
7							316									
8							FA140		FA140HH				MD1156			
9							FA140		FA140HH				TBC			
10							FA140		FA140HH				MD1156			
11							FA140		FA140HH				MD1156			
12							FA140		FA140HH				MD1156			
13							FA140		FA140HH				TBC			
14							FA140		FA140HH				MD1156			
15							FA496		FA496HH							
16	MD6001CX	OSX6001E	BRK004				FA131X	MXS131	FA131R				MD6002D			MD6002CX
17	MD6037CX	OSX6037	BRK008	SMX6037	BRK009		FA131X	MXS131	FA131R	EPFA131HH			MD6002D			MD6002CX
18							331		331G							
19							344		344G							
20							FA131X	MXS131	FA131R				MD6009D			
21							FA131X	MXS131	FA131R				MD6002D			
22							FA131X	MXS131	FA131R				MD6002D			
23							321									
24							321									
25							321									
26							321									
27							FA69		FA69HH							
28							FA69		FA69HH				MD1048			
29						DB102/6	340									
30							321									
31							321									
32							FA496		FA496HH							
33							FA714X		FA714R		FA714SV		MD6441D			
34							FA714X		FA714R		FA714SV		MD6217D			
35							343		343G							
36							343		343G							
37							343		343G							
38							FA373X		FA373R		FA373SV		MD6217D			
39							321									
40	VR1006*						FA69		FA69HH				MD1006		MD1006C	VR1006
41							313									
42							313									
43							318		318G							
44							318		318G							
45							318		318G							
46							318		318G							
47							304		304G							
48							FA714X		FA714R		FA714SV		MD6217D			
49							FA373X		FA373R		FA373SV		MD6217D			
50							FA373X		FA373R		FA373SV		MD6217D			
51							FA373X		FA373R		FA373SV		MD6217D			
52							351		351G							
53							351		351G							
54							351		351G							
55							FA373X		FA373R		FA373SV		MD6217D			
56							316									

BRAKE APPLICATIONS
 * This symbol indicates a rotor made of billet steel, and should be only used with EBC FA Organic or Vee pads.
 SAFETY NOTICE - With vehicles primarily designed for off highway use such as quads now being used on the highway, we would recommend the use of X or MXS pads for highway use and ONLY using the R and SV higher density / harder pad series for off road riding.

*-2 Sets Required. † For Vee disc colours add RED, BLU, GRN, GLD, ORG suffix to part number. **SAFETY WARNING:- DO NOT USE HH PADS ON REAR UNLESS ALSO USED ON FRONT TO AVOID BRAKE IMBALANCE**

FRONT: HONDA



HONDA



DISC PAD CHOICES - FRONT

BRAKE ROTOR CHOICES - FRONT

FA/SFA/X Pad or Brake Shoe	Specialty Pads SXR/VEE/MXS Race	Sintered/HH Pads/Grooved Shoes	EPFA Sintered Fast Road/Track Pads	GPFA Sintered RACE ONLY Pads	SV Series Severe Duty Pads	Standard Rotor Left	Standard Rotor Right	Vintage Rotor / UTV Oversize Brake Kit	Contour Profile Rotor	Line #
CB 550 K1/76		FA13	FA13V							1
CB 550 SC Nighthawk		FA69		FA69HH		MD1047LS				2
CB 600 F Hornet		FA226*		FA226HH*	EPFA226HH*	MD1139	MD1139		MD1139C*	3
CBR 600 F Hurricane		FA121*		FA121HH*		MD1001	MD1001			4
CBR 600 F2 EBC Floating Rotor Conversion 310mm										5
(Note will require Relocation Brackets - BRK15S)		FA203*		FA203HH*		MD601LS	MD601RS			6
CBR 600 F2 Solid rotor		FA203*		FA203HH*		MD1001	MD1001			7
CBR 600 F3/SJR/SE		FA226*		FA226HH*	EPFA226HH*	MD1003X	MD1003X		MD1003XC*	8
CBR 600 F4				FA296HH*	EPFA296HH*	GPFA296HH*	MD1014X	MD1014X	MD1014XC*	9
CBR 600 F4i Sport				FA296HH*	EPFA296HH*	GPFA296HH*	MD1141X	MD1141X	MD1141XC*	10
CBR 600 RR				FA390HH*	EPFA390HH*	GPFA390HH*	MD1152X	MD1152X	MD1152XC*	11
CBR 600 RR				FA296HH*	EPFA296HH*	GPFA296HH*	MD1152X	MD1152X	MD1152XC*	12
CBR 600 RR				FA390HH*	EPFA390HH*	GPFA390HH*	MD1152X	MD1152X	MD1152XC*	13
CBR 600 RR				FA700HH*	EPFA700HH*	GPFA700HH*	MD1152X	MD1152X	MD1152XC*	14
CBR 600 RR				FA390HH*	EPFA390HH*	GPFA390HH*	MD1152X	MD1152X	MD1152XC*	15
F6B Goldwing				FA261HH*	EPFA261HH*					16
F6B Goldwing Deluxe				FA261HH*	EPFA261HH*					17
FSC 600 A Silverwing		SFA281		SFA281HH		MD1172LS				18
FSC 600 A Silverwing Parking brake		SFA257/2								19
FSC 600 D Silverwing		SFA281		SFA281HH		MD1172LS				20
FSC 600 D Silverwing Parking brake		SFA257/2								21
FSC 600 Silverwing		SFA281		SFA281HH		MD1006			MD1006C	22
FSC 600 Silverwing Parking brake		SFA257/2								23
V LX 600 Shadow		FA124/2	FA124/2V	FA124/2HH		MD1047LS				24
VT 600 Shadow		FA196	FA196V	FA196HH		MD1047LS				25
XL 600 R		FA92X		FA92R		MD6087D				26
XL 600 V Transalp		FA69		FA69HH		MD6044D				27
XR 600 R		FA92X		FA92R		MD6087D				28
XR 600 R		FA125X		FA125R		MD6087D				29
XR 600 R		FA125X		FA125R		MD6001D				30
XR 600 R		FA185X	MXS185	FA185R	EPFA185HH	MD6001D				31
CB 650		FA69	FA69V	FA69HH						32
CB 650		FA45	FA45V			MD1036LS		VMD1036		33
CB 650 C Custom		FA45	FA45V			MD1036LS		VMD1036		34
CB 650 C Custom		FA45*	FA45V*			MD1036LS	MD1036RS	VMD1036*		35
CB 650 F	Left	FA142*	FA142V*						MD1201C	36
	Right								MD1200C	37
CB 650 FA	Left	FA142*	FA142V*						MD1201C	38
	Right								MD1200C	39
CB 650 R				FA679HH*		MD1194X	MD1194X			40
CB 650 R				FA679HH*		MD1194X	MD1194X			41
CB 650 SC Nighthawk		FA90*	FA90V*			MD1036LS	MD1036RS	VMD1036*		42
CB 650 SC Nighthawk		FA69*	FA69V*	FA69HH*		MD1001	MD1001			43
CBR 650 F	Left	FA142*	FA142V*						MD1201C	44
	Right								MD1200C	45
CBR 650 FA	Left	FA142*	FA142V*						MD1201C	46
	Right								MD1200C	47
CBR 650 R				FA679HH*		MD1194X	MD1194X			48
CBR 650 RA				FA679HH*		MD1194X	MD1194X			49
CX 650 C Custom		FA69	FA69V	FA69HH		MD1047LS				50
CX 650 T Turbo		FA69*	FA69V*	FA69HH*						51
GL 650 Silverwing Interstate		FA69*	FA69V*	FA69HH*		MD1040LS	MD1040RS			52
NT 650 Hawk GT		FA142	FA142V	FA142HH		MD1021LS				53
NX 650 Dominator		FA124/2		FA124/2HH		MD6010D				54
TRX 650 FA Rincon		347		347G*						55
TRX 650 FGA Fourtrax Rincon Gpscape		347		347G*						56

FRONT

BRAKE APPLICATIONS

* This symbol indicates a rotor made of billet steel, and should be only used with EBC FA Organic or Vee pads.

SAFETY NOTICE - With vehicles primarily designed for off highway use such as quads now being used on the highway, we would recommend the use of X or MXS pads for highway use and ONLY using the R and SV higher density / harder pad series for off road riding.

*-2 Sets Required. † For Vee disc colours add RED, BLU, GRN, GLD, ORG suffix to part number. **SAFETY WARNING:- DO NOT USE HH PADS ON REAR UNLESS ALSO USED ON FRONT TO AVOID BRAKE IMBALANCE**

FRONT: HONDA Cont'd

REAR: HONDA

Line #	BRAKE ROTOR CHOICES - FRONT					Front Disc Bolt Kit	DISC PAD CHOICES - REAR					BRAKE ROTOR CHOICES - REAR				
	CX Extreme® /Vee-Rotor	OSX Series Oversize 280mm Rotor Kit	Relocating Bracket for Oversize Rotor	SMX Series Oversize 320mm Rotor Kit	Relocating Bracket for 320mm Rotor		FA/SFA/X Pad or Brake Shoe	Specialty Pads SXR/ VEE/MXS Race	Sintered/ HH Pads/ Grooved Shoes	EPFA Sintered Fast Road/ Track Pads	SV Series Severe Duty Pads	Standard Rotor	Vintage Rotor / UTV Oversize Brake Kit	Contour Profile Rotor	CX Extreme® /Vee-Rotor	Rear Disc Bolt Kit
1								316								
2								313								
3						DB102/6		FA174		FA174HH			MD1004		MD1004C	
4						DB102/6		FA69/3		FA69/3HH			MD1002			
5																
6					BRK15S			FA174		FA174HH			MD1004		MD1004C	
7						DB102/6		FA174		FA174HH			MD1004		MD1004C	
8	VR1003BLK*					DB102/6		FA174		FA174HH			MD1004		MD1004C	
9	VR1014BLK*					DB102/6		FA174		FA174HH			MD1004		MD1004C	
10	VR1141BLK*					DB102/6		FA174		FA174HH			MD1004		MD1004C	
11	VR1152BLK*					DB102/6		FA174		FA174HH			MD1004		MD1004C	
12	VR1152BLK*					DB102/6		FA436		FA436HH			MD1004		MD1004C	
13	VR1152BLK*					DB102/6		FA174		FA174HH			MD1004		MD1004C	
14	VR1152BLK*					DB102/6		FA436		FA436HH			MD1004		MD1004C	
15	VR1152BLK*					DB102/6		FA436		FA436HH			MD1173		MD1173C	
16																
17								FA261/2HH		EPFA261/2HH						
18								FA261/2HH		EPFA261/2HH						
19							SFA196		SFA196HH				MD1149			
20							SFA196		SFA196HH				MD1149			
21																
22	VR1006						SFA196		SFA196HH				MD1149		MD1149C	
23																
24								321								
25								321								
26								318		318G						
27								318		318G						
28								304		304G						
29								304		304G						
30	MD6001CX	OSX6001E	BRK004				FA131X	MXS131	FA131R				MD6013D		MD6013CX	
31	MD6001CX	OSX6001	BRK008	SMX6001	BRK009		FA131X	MXS131	FA131R				MD6013D		MD6013CX	
32								320								
33								320								
34								320								
35								320								
36													MD1156			
37							FA496		FA496HH				MD1156			
38																
39							FA496		FA496HH				MD1156			
40							FA496		FA496HH				MD1156			
41							FA496		FA496HH				MD1156			
42							320									
43						DB102/6	321									
44													MD1156			
45							FA496		FA496HH				MD1156			
46																
47							FA496		FA496HH				MD1156			
48							FA496		FA496HH				MD1156			
49							FA496		FA496HH				MD1156			
50																
51							321									
52							FA69		FA69HH							
53							321									
54	MD6010CX						FA140		FA140HH				MD1022			
55							318		318G							
56							FA373X		FA373R		FA373SV		MD6217D			
							FA373X		FA373R		FA373SV		MD6217D			

⚠ This symbol indicates a rotor made of billet steel, and should be only used with EBC FA Organic or Vee pads.
SAFETY NOTICE - With vehicles primarily designed for off highway use such as quads now being used on the highway, we would recommend the use of X or MXS pads for highway use and ONLY using the R and SV higher density / harder pad series for off road riding.

*-2 Sets Required. † For Vee disc colours add RED, BLU, GRN, GLD, ORG suffix to part number. **SAFETY WARNING:- DO NOT USE HH PADS ON REAR UNLESS ALSO USED ON FRONT TO AVOID BRAKE IMBALANCE**

FRONT: HONDA

APPLICATIONS

BRAKE



HONDA



DISC PAD CHOICES - FRONT

BRAKE ROTOR CHOICES - FRONT

Model	Year	Left	Right	DISC PAD CHOICES - FRONT					BRAKE ROTOR CHOICES - FRONT				Line #	
				FA/SFA/X Pad or Brake Shoe	Specialty Pads SXR/VEE/MXS Race	Sintered/HH Pads/Grooved Shoes	EPFA Sintered Fast Road/Track Pads	GPFA Sintered RACE ONLY Pads	SV Series Severe Duty Pads	Standard Rotor Left	Standard Rotor Right	Vintage Rotor / UTV Oversize Brake Kit		Contour Profile Rotor
XR 650 L	1993-2024			FA185X	MXS185	FA185R	EPFA185HH			MD6010D				1
XR 650 R	2000-2007			FA185X	MXS185	FA185R	EPFA185HH			MD6001D			MD6001C	2
TRX 680 FA Fourtrax Rincon	2006-2022			FA410X*		FA410R*			FA410SV*	MD6251D	MD6251D			3
TRX 680 Fourtrax Rincon Gpscape	2006-2009			FA410X*		FA410R*			FA410SV*	MD6251D	MD6251D			4
CB 700 Nighthawk	1984-1986			FA69*	FA69V*	FA69HH*				MD1001	MD1001			5
CTX 700	2014-2017			FA196	FA196V	FA196HH							MD1186C	6
CTX 700 D	2014-2019			FA196	FA196V	FA196HH							MD1186C	7
CTX 700 D Parking brake	2014-2019			SFA257/2										8
CTX 700 N	2014-2016			FA196	FA196V	FA196HH							MD1186C	9
CTX 700 ND	2014-2019			FA196	FA196V	FA196HH							MD1186C	10
CTX 700 ND Parking brake	2014-2019			SFA257/2										11
MUV 700 Big Red	2009-2013			FA476X						MD6341D				12
				FA477X							MD6341D			13
NC 700 JD	2015-2019			SFA196		FA196HH				MD1187C				14
NC 700 JD Parking brake	2015-2019			SFA257/2										15
NC 700 X	2012-2017			FA196		FA196HH							MD1186C	16
NC 700 XD	2012-2017			FA388		FA388HH	EPFA388HH						MD1187C	17
NC 700 XD	2012-2017			FA196		FA196HH							MD1186C	18
NC 700 XD Parking brake	2012-2017			SFA257/2										19
NT 700 VVA	2010-2013					FA388HH*	EPFA388HH*			MD1008	MD1008			20
SXS 700 M2 Pioneer	2014-2023			FA712X*		FA712R*			FA712SV*	MD6341D	MD6341D			21
SXS 700 M4 Pioneer	2014-2023			FA712X*		FA712R*			FA712SV*	MD6341D	MD6341D			22
TRX 700 X	2008-2011			FA185X*	MXS185*	FA185R*	EPFA185HH*			MD6006D	MD6006D			23
VF 700 C Magna	1984			FA69*	FA69V*	FA69HH*				MD1040LS	MD1040RS			24
VF 700 C Magna	1985-1986			FA69*	FA69V*	FA69HH*				MD1040LS	MD1040RS			25
VF 700 C Magna	1987			FA69/3	FA69/3V	FA69/3HH				MD1059LS				26
VF 700 F Interceptor	1984			FA69*		FA69HH*				MD1001	MD1001			27
VF 700 F Interceptor	1985			FA69*		FA69HH*				MD1001	MD1001			28
VF 700 S Sabre	1984-1985			FA69*	FA69V	FA69HH*				MD1001	MD1001			29
VFR 700 F/F2 Interceptor	1986-1987			FA124*		FA124HH*				MD1001	MD1001			30
VT 700 C Shadow	1984-1985			FA90*	FA90V*					MD1040LS	MD1040RS			31
VT 700 C Shadow	1986-1987			FA69	FA69V	FA69HH				MD1047LS				32
CB 750	1970-1975			FA12	FA12V									33
CB 750 76	1970-1976			FA12	FA12V					MD1062LS		VMD1062		34
CB 750 A Hondamatic	1976-1978			FA13	FA13V									35
CB 750 C	1982			FA90*	FA90V*					MD1036LS	MD1036RS	VMD1036*		36
CB 750 C Custom	1980			FA45	FA45V					MD1052LS		VMD1052		37
CB 750 C Custom	1981			FA45*	FA45V*					MD1036LS	MD1036RS	VMD1036*		38
CB 750 C Custom	1982			FA69/2*	FA69/2V*					MD1036LS	MD1036RS	VMD1036*		39
CB 750 F Supersport	1975-1976			FA13	FA13V					MD1062LS		VMD1062		40
CB 750 F Supersport	1977-1978			FA31*	FA31V*									41
CB 750 F Supersport	1979-1980			FA30*	FA30V*					MD1036LS	MD1036RS	VMD1036*		42
CB 750 F Supersport	1981-1982			FA69/2*						MD1036LS	MD1036RS	VMD1036*		43
CB 750 Hornet	2022-2024					FA759HH*								44
CB 750 K	1979-1982			FA45	FA45V					MD1052LS		VMD1052		45
CB 750 K7	1977-1978			FA13	FA13V					MD1062LS		VMD1062		46
CB 750 L Limited Edition	1979			FA45	FA45V					MD1052LS		VMD1052		47
CB 750 Nighthawk	1991-2003			FA196	FA196V	FA196HH				MD1021LS				48
CB 750 SC Nighthawk	1982-1983			FA69*	FA69V*	FA69HH*				MD1036LS	MD1036RS	VMD1036*		49
NC 750 XA	2018-2023			FA196		FA196HH							MD1186C	50
RVF 750 RR RC 45	1994-1995			FA187*		FA187HH*	EPFA187HH*			MD1012LS	MD1012RS			51
VF 750 C Magna/Magna Delux	1994-2003			FA196	FA196V	FA196HH				MD1021LS				52
VF 750 C V45 Magna	1982-1983			FA69*	FA69V*	FA69HH*				MD1040LS	MD1040RS			53
VF 750 C V45 Magna	1988			FA69/3	FA69/3V	FA69/3HH				MD1059LS				54
VF 750 F V45 Interceptor	1983-1984			FA69*		FA69HH*				MD1001	MD1001			55
VF 750 S Sabre	1982-1983			FA69*	FA69V*	FA69HH*				MD1001	MD1001			56

* This symbol indicates a rotor made of billet steel, and should be only used with EBC FA Organic or Vee pads.
 SAFETY NOTICE - With vehicles primarily designed for off highway use such as quads now being used on the highway, we would recommend the use of X or MXS pads for highway use and ONLY using the R and SV higher density / harder pad series for off road riding.

*-2 Sets Required. † For Vee disc colours add RED, BLU, GRN, GLD, ORG suffix to part number. **SAFETY WARNING:- DO NOT USE HH PADS ON REAR UNLESS ALSO USED ON FRONT TO AVOID BRAKE IMBALANCE**

FRONT: HONDA Cont'd

REAR: HONDA

Line #	BRAKE ROTOR CHOICES - FRONT					DISC PAD CHOICES - REAR					BRAKE ROTOR CHOICES - REAR					
	CX Extreme® /Vee-Rotor	OSX Series 280mm Rotor Kit	Relocating Bracket for Oversize Rotor	SMX Series 320mm Rotor Kit	Relocating Bracket for 320mm Rotor	Front Disc Bolt Kit	FA/SFA/X Pad or Brake Shoe	Specialty Pads SXR/VEE/MXS Race	Sintered/HH Pads/ Grooved Shoes	EPFA Sintered Fast Road/ Track Pads	SV Series Severe Duty Pads	Standard Rotor	Vintage Rotor / UTV Oversize Brake Kit	Contour Profile Rotor	CX Extreme® /Vee-Rotor	Rear Disc Bolt Kit
1	MD6010CX			SMX6010	BRK009		FA131X	MXS131	FA131R			MD6045D			MD6045CX	
2	MD6001CX	OSX6001	BRK008	SMX6001	BRK009		FA131X	MXS131	FA131R			MD6181D		MD6181C	MD6181CX	
3							FA373X		FA373R		FA373SV	MD6217D				
4							FA373X		FA373R		FA373SV	MD6217D				
5						DB102/6	343									
6							FA140		FA140HH					MD1185C		
7							FA140		FA140HH					MD1185C		
8														MD1185C		
9							FA140		FA140HH					MD1185C		
10							FA140		FA140HH					MD1185C		
11														MD1185C		
12							FA478X					MD6341D*				
13							FA479X									
14							FA140		FA140HH			MD1185C				
15																
16							FA140		FA140HH					MD1185C		
17							FA140		FA140HH					MD1185C		
18							FA140		FA140HH					MD1185C		
19																
20						DB102/6										
21								FA261HH				MD1016				
22							FA714X		FA714R		FA714SV	MD6217D				
23							FA714X		FA714R		FA714SV	MD6217D				
24							FA410X		FA410R			MD6331D				
25							321									
26							343									
27						DB102/6	FA69/3		FA69/3HH			MD1068				
28						DB102/6	FA69/3		FA69/3HH			MD1079				
29						DB102/6	321									
30						DB102/6	FA69/3		FA69/3HH			MD1006				
31							321									
32							343									
33							320									
34							320									
35							320									
36							320									
37							320									
38							320									
39							320									
40							FA32					MD1064				
41							FA31					MD1064				
42							FA30					MD1071	VMD1071			
43							FA69					MD1082				
44							FA140		FA140HH							
45							320									
46							320									
47							320									
48							321									
49							320									
50							FA496		FA496HH					MD1185C		
51							FA143					MD1013				
52							343									
53							321									
54							343									
55						DB102/6	FA69/3		FA69/3HH			MD1068				
56						DB102/6	321									

⚠ This symbol indicates a rotor made of billet steel, and should be only used with EBC FA Organic or Vee pads.
SAFETY NOTICE - With vehicles primarily designed for off highway use such as quads now being used on the highway, we would recommend the use of X or MXS pads for highway use and ONLY using the R and SV higher density / harder pad series for off road riding.

*-2 Sets Required. † For Vee disc colours add RED, BLU, GRN, GLD, ORG suffix to part number. **SAFETY WARNING:- DO NOT USE HH PADS ON REAR UNLESS ALSO USED ON FRONT TO AVOID BRAKE IMBALANCE**

FRONT: HONDA

APPLICATIONS

BRAKE



HONDA



DISC PAD CHOICES - FRONT

BRAKE ROTOR CHOICES - FRONT

Model	Year	FA/SFA/X Pad or Brake Shoe	Specialty Pads SXR/ VEE/MXS Race	Sintered/ HH Pads/ Grooved Shoes	EPFA Sintered Fast Road/ Track Pads	GPFAX Sintered RACE ONLY Pads	SV Series Severe Duty Pads	Standard Rotor		Vintage Rotor / UTV Oversize Brake Kit	Contour Profile Rotor	Line #
								Standard Rotor Left	Standard Rotor Right			
VFR 750 F	1990-1993	FA142*		FA142HH*				MD1008	MD1008			1
VFR 750 F	1994-1997	FA142*		FA142HH*				MD1003X	MD1003X		MD1003XC*	2
VFR 750 F Interceptor	1986	FA124*		FA124HH*				MD1001	MD1001			3
VFR 750 R	1990	FA187*		FA187HH*	EPFA187HH*			MD1010LS	MD1010RS			4
VT 750 C Shadow	1983	FA90*	FA90V*					MD1040LS	MD1040RS			5
VT 750 C2 Shadow Spirit	2007-2014	FA196	FA196V	FA196HH					MD1159			6
VT 750 CSE Shadow Spirit	2013-2014	FA388		FA388HH	EPFA388HH							7
VT 750 RS Shadow	2010-2014	FA196	FA196V	FA196HH				MD1159				8
VT 750 Shadow Aero	2004-2007	FA196	FA196V	FA196HH				MD1159				9
VT 750 Shadow Aero	2008-2015	FA196	FA196V	FA196HH					MD1159			10
VT 750 Shadow Aero C	2016-2024	FA388		FA388HH					MD1159			11
VT 750 Shadow American Classic Edition 750 Deluxe	2002-2003	FA196	FA196V	FA196HH				MD1159				12
VT 750 Shadow Phantom C2B	2010-2022	FA196	FA196V	FA196HH					MD1159			13
VT 750 Shadow Phantom C2B	2023-2024	FA196	FA196V	FA196HH					MD1159			14
VT 750 Shadow Spirit	2001-2002	FA196	FA196V	FA196HH				MD1159				15
VT 750 Shadow Spirit	2003-2007	FA196	FA196V	FA196HH				MD1159				16
VT 750 Shadow/Shadow Deluxe	1998-2002	FA196	FA196V	FA196HH				MD1159				17
PC 800 Pacific Coast	1989-1990	FA142*	FA142V*	FA142HH*				MD1001	MD1001			18
PC 800 Pacific Coast	1994-1998	FA142*	FA142V*	FA142HH*				MD1001	MD1001			19
VFR 800 A Interceptor	2002-2005			FA261HH*	EPFA261HH*			MD1157X	MD1157X		MD1157XC*	20
VFR 800 A Interceptor ABS	2006-2011	FA388*		FA388HH*	EPFA388HH*			MD1157X	MD1157X		MD1157XC*	21
VFR 800 F Interceptor	2014-2020			FA390HH*	EPFA390HH*	GPFAX390HH*		MD1188X	MD1188X			22
VFR 800 FD Interceptor DLX	2014-2020			FA390HH*	EPFA390HH*	GPFAX390HH*		MD1188X	MD1188X			23
VFR 800 Fi Interceptor	1998-1999			FA261HH*	EPFA261HH*			MD1014X	MD1014X		MD1014XC*	24
VFR 800 Interceptor	2000-2005			FA261HH*	EPFA261HH*			MD1014X	MD1014X		MD1014XC*	25
VFR 800 Interceptor	2006-2009			FA388HH*	EPFA388HH*			MD1014X	MD1014X		MD1014XC*	26
VT 800 C Shadow	1988	FA69	FA69V	FA69HH				MD1047LS				27
CB 900 C Custom	1980	FA30*	FA30V*					MD1036LS	MD1036RS	VMD1036*		28
CB 900 C Custom	1981	FA29*	FA29V*					MD1036LS	MD1036RS	VMD1036*		29
CB 900 C Custom	1982	FA69/2*	FA69/2V*					MD1036LS	MD1036RS	VMD1036*		30
CB 900 F 919 Hornet	2002-2007	FA187*		FA187HH*	EPFA187HH*			MD1141X	MD1141X		MD1141XC*	31
CB 900 F Supersport	1981-1982	FA69/2*						MD1036LS	MD1036RS	VMD1036*		32
CBR 900 RR Fireblade	1993-1994	FA187*		FA187HH*	EPFA187HH*			MD1014X	MD1014X		MD1014XC*	33
CBR 900 RR Fireblade	1995-1997	FA187*		FA187HH*	EPFA187HH*			MD1003X	MD1003X		MD1003XC*	34
CBR 900 RR Fireblade	1998-1999			FA265HH*	EPFA265HH*			MD1134X	MD1134X		MD1134XC*	35
CBR 900 RR Fireblade 929	2000-2001			FA265HH*	EPFA265HH*			MD1137X	MD1137X		MD1137XC*	36
CBR 900 RR Fireblade 954	2002-2003			FA265HH*	EPFA265HH*			MD1137X	MD1137X		MD1137XC*	37
CB 1000	1994-1995	FA187*		FA187HH*	EPFA187HH*			MD1056	MD1056			38
CB 1000 C Custom	1983	FA69*	FA69V*	FA69HH*				MD1040LS	MD1040RS			39
CB 1000 R	2010-2016			FA390HH*	EPFA390HH*	GPFAX390HH*		MD1152X	MD1152X		MD1152XC*	40
CB 1000 R	2017-2018			FA296HH*	EPFA296HH*	GPFAX296HH*		MD1193X	MD1193X			41
CB 1000 R	2018-2023			FA700HH*	EPFA700HH*	GPFAX700HH*		MD1193X	MD1193X			42
CBF 1000 F ABS	2008-2011			FA388HH*	EPFA388HH*			MD1160	MD1160			43
CBR 1000 F	1987-1988	FA124*		FA124HH*				MD1008	MD1008			44
CBR 1000 F	1990-1991	FA142*		FA142HH*				MD1008	MD1008			45
CBR 1000 F	1993-1999	FA189*		FA189HH*				MD1008	MD1008			46
CBR 1000 Fireblade RR-R SP	2020-2024			FA757HH*	EPFA757HH*	GPFAX757HH*		TBC	TBC			47
CBR 1000 RA AC/2AC	2017-2021			FA700HH*	EPFA700HH*	GPFAX700HH*		MD1199X	MD1199X			48
CBR 1000 RR	2004-2005			FA390HH*	EPFA390HH*	GPFAX390HH*		MD1153X	MD1153X		MD1153XC*	49
CBR 1000 RR	2006-2007			FA390HH*	EPFA390HH*	GPFAX390HH*		MD1161X	MD1161X		MD1161XC*	50
CBR 1000 RR	2008-2015			FA390HH*	EPFA390HH*	GPFAX390HH*		MD1171X	MD1171X		MD1171XC*	51
CBR 1000 RR AC/2AC	2017-2023			FA700HH*	EPFA700HH*	GPFAX700HH*		MD1199X	MD1199X			52
CBR 1000 RR SP	2014-2017			FA447HH*	EPFA447HH*	GPFAX447HH*		MD1171X	MD1171X		MD1171XC*	53
CBR 1000 RR SP AC/2AC	2020-2023			FA447HH*	EPFA447HH*	GPFAX447HH*		TBC	TBC			54
CBR 1000 RRA	2009-2016			FA390HH*	EPFA390HH*	GPFAX390HH*		MD1171X	MD1171X		MD1171XC*	55
CBX 1000	1979-1980	FA31*						MD1036LS	MD1036RS	VMD1036*		56

FRONT

⚠ This symbol indicates a rotor made of billet steel, and should be only used with EBC FA Organic or Vee pads. SAFETY NOTICE - With vehicles primarily designed for off highway use such as quads now being used on the highway, we would recommend the use of X or MXS pads for highway use and ONLY using the R and SV higher density / harder pad series for off road riding.

*-2 Sets Required. † For Vee disc colours add RED, BLU, GRN, GLD, ORG suffix to part number. SAFETY WARNING:- DO NOT USE HH PADS ON REAR UNLESS ALSO USED ON FRONT TO AVOID BRAKE IMBALANCE

FRONT: HONDA Cont'd

REAR: HONDA

Line #	BRAKE ROTOR CHOICES - FRONT					DISC PAD CHOICES - REAR					BRAKE ROTOR CHOICES - REAR					
	CX Extreme® /Vee-Rotor	OSX Series Oversize 280mm Rotor Kit	Relocating Bracket for Oversize Rotor	SMX Series Oversize 320mm Rotor Kit	Relocating Bracket for 320mm Rotor	Front Disc Bolt Kit	FA/SFA/X Pad or Brake Shoe	Specialty Pads SXR/ VEE/MXS Race	Sintered/ HH Pads/ Grooved Shoes	EPFA Sintered Fast Road/ Track Pads	SV Series Severe Duty Pads	Standard Rotor	Vintage Rotor / UTV Oversize Brake Kit	Contour Profile Rotor	CX Extreme® /Vee-Rotor	Rear Disc Bolt Kit
1						DB102/6	FA196		FA196HH			MD1007				
2						DB102/6	FA196		FA196HH			MD1007		MD1007C		
3						DB102/6	FA69/3		FA69/3HH			MD1006				
4							FA143					MD1011				
5							321									
6							343									
7							FA254		FA254HH							
8							343									
9							343									
10							343									
11							FA254		FA254HH							
12							343									
13							343									
14							FA254		FA254HH							
15							343									
16							343									
17							343									
18						DB102/6	343									
19						DB102/6	343									
20																
21								FA261HH	EPFA261HH			MD1164		MD1164C		
22						DB102/6		FA261HH	EPFA261HH			MD1164		MD1164C		
23						DB102/6		FA488HH				MD1190				
24						DB102/6		FA488HH				MD1190				
25	VR1014BLK*†					DB102/6		FA261HH	EPFA261HH			MD1165		MD1165C		
26	VR1014BLK*†					DB102/6		FA261HH	EPFA261HH			MD1165		MD1165C		
27	VR1014BLK*†					DB102/6		FA261HH	EPFA261HH			MD1165		MD1165C		
28							343									
29							FA29					MD1071	VMD1071			
30							FA29					MD1071	VMD1071			
31	VR1141BLK*†					DB102/6	FA69					MD1082				
32							FA174		FA174HH			MD1020		MD1020C	VR1020	
33							FA69					MD1082				
34	VR1014BLK*†					DB102/6	FA174		FA174HH			MD1004		MD1004C	VR1004	
35	VR1003BLK*†					DB102/6	FA174		FA174HH			MD1004		MD1004C	VR1004	
36	VR1134BLK*†					DB102/6	FA174		FA174HH			MD1004		MD1004C	VR1004	
37	VR1137BLK*†					DB102/6	FA174		FA174HH			MD1004		MD1004C	VR1004	
38	VR1137BLK*†					DB102/6	FA174		FA174HH			MD1004		MD1004C	VR1004	
39							FA174		FA174HH			MD1016				
40	VR1152BLK*†					DB102/6	FA69		FA69HH			MD1078				
41												MD1177		MD1177C		
42												FA488HH				
43						DB102/6						FA488HH				
44						DB102/6						FA488HH				
45						DB102/6	FA69/3		FA69/3HH	EPFA388HH		MD1156				
46						DB102/6	FA196		FA196HH			MD1001				
47						DB102/6	FA189		FA189HH			MD1016				
48												MD1006				
49	VR1153BLK*†					DB102/6						TBC				
50	VR1161BLK*†					DB102/6	FA436		FA436HH							
51	VR1171BLK*†					DB102/6	FA436		FA436HH							
52							FA436		FA436HH							
53	VR1171BLK*†					DB102/6	FA436		FA436HH							
54							FA436		FA436HH							
55	VR1171BLK*†					DB102/6	FA436		FA436HH							
56							FA31					MD1004		MD1004C	VR1004	
												MD1071	VMD1071			

BRAKE APPLICATIONS
 * This symbol indicates a rotor made of billet steel, and should be only used with EBC FA Organic or Vee pads.
 SAFETY NOTICE - With vehicles primarily designed for off highway use such as quads now being used on the highway, we would recommend the use of X or MXS pads for highway use and ONLY using the R and SV higher density / harder pad series for off road riding.

*-2 Sets Required. † For Vee disc colours add RED, BLU, GRN, GLD, ORG suffix to part number. **SAFETY WARNING:- DO NOT USE HH PADS ON REAR UNLESS ALSO USED ON FRONT TO AVOID BRAKE IMBALANCE**

FRONT: HONDA

APPLICATIONS

BRAKE



HONDA



DISC PAD CHOICES - FRONT

BRAKE ROTOR CHOICES - FRONT

			FA/SFA/X Pad or Brake Shoe	Specialty Pads SXR/ VEE/MXS Race	Sintered/ HH Pads/ Grooved Shoes	EPFA Sintered Fast Road/ Track Pads	GPFAX Sintered RACE ONLY Pads	SV Series Severe Duty Pads	Standard Rotor Left	Standard Rotor Right	Vintage Rotor / UTV Oversize Brake Kit	Contour Profile Rotor	Line #
CBX 1000		1981-1982	FA69/2*										1
CRF 1000 Africa Twin		2016-2020			FA679HH*				MD1198X	MD1198X		MD1198XC*	2
CRF 1000 Africa Twin		2016-2020			FA679HH*				MD1198X	MD1198X		MD1198XC*	3
CRF 1000 Africa Twin Adventure Sport		2018-2020			FA679HH*				MD1198X	MD1198X		MD1198XC*	4
CRF 1000 Africa Twin Adventure Sport		2018-2020			FA679HH*				MD1198X	MD1198X		MD1198XC*	5
DN-01 NSA 700		2009-2011	SFA388*		SFA388HH*				MD1180X	MD1180X			6
DN-01 NSA 700 Parking brake		2009-2011	SFA257/2						MD1180X	MD1180X			7
GL 1000 Goldwing		1978	FA29*	FA29V*									8
GL 1000 Goldwing		1979	FA29*	FA29V*					MD1036LS	MD1036RS	VMD1036*		9
GL 1000 K76/L Goldwing		1975-1977	FA29*	FA29V*					MD1074LS	MD1074RS			10
PVT 1000 PVT 1000 RS Pursuer		2017-2018			FA700HH*	EPFA700HH*						MD1186C*	11
RVT 1000 R		2000-2006			FA265HH*	EPFA265HH*			MD1161X	MD1161X		MD1161XC*	12
SXS 1000 Pioneer	Left	2016-2022	FA701X	SXR701HH	FA701R			FA701SV	MD6410D		UTVX6410*		13
	Right		FA702X	SXR702HH	FA702R			FA702SV		MD6410D			14
SXS 1000 Pioneer	Left	2016-2023	FA701X	SXR701HH	FA701R			FA701SV	MD6410D		UTVX6410*		15
	Right		FA702X	SXR702HH	FA702R			FA702SV		MD6410D			16
SXS 1000 S2R Talon	Left	2019-2023	FA701X	SXR701HH	FA701R			FA701SV	MD6425D			MD6425C	17
	Right		FA702X	SXR702HH	FA702R			FA702SV		MD6425D			18
SXS 1000 S2X Talon	Left	2021-2024	FA701X	SXR701HH	FA701R			FA701SV	MD6425D			MD6425C	19
	Right		FA702X	SXR702HH	FA702R			FA702SV		MD6425D			20
SXS 1000 S4X Talon	Left	2021-2024	FA701X	SXR701HH	FA701R			FA701SV	MD6425D			MD6425C	21
	Right		FA702X	SXR702HH	FA702R			FA702SV		MD6425D			22
VF 1000 F Interceptor		1984	FA69*		FA69HH*				MD1001	MD1001			23
VF 1000 R		1985-1986	FA69*		FA69HH*				MD1146	MD1146			24
VTR 1000 F Super Hawk		1998-2005	FA187*		FA187HH*	EPFA187HH*			MD1003X	MD1003X		MD1003XC*	25
XL 1000 V48 Varadero		2008			FA388HH*	EPFA388HH*			MD1014X			MD1014XC*	26
CB 1100		2013-2014			FA296HH*	EPFA296HH*							27
CB 1100 A		2013-2014			FA388HH*	EPFA388HH*							28
CB 1100 EX		2014-2021			FA296HH*	EPFA296HH*							29
CB 1100 F Supersport		1983	FA69*		FA69HH*				MD1001	MD1001			30
CBR 1100 XX Blackbird		1997-1998			FA261HH*	EPFA261HH*			MD1120X	MD1120X		MD1120XC*	31
CBR 1100 XX Blackbird		1999-2003			FA261HH*	EPFA261HH*			MD1136X	MD1136X		MD1136XC*	32
CMX 1100 Rebel 1100		2021-2024			FA700HH					TBC			33
CRF 1100 Africa Twin		2020-2024			FA679HH*				MD1206X	MD1206X		MD1206XC*	34
CRF 1100 Africa Twin Adventure Sports ES		2020-2024			FA679HH*				MD1206X	MD1206X		MD1206XC*	35
GL 1100 /1100 I Goldwing		1980	FA30*	FA30V*					MD1036LS	MD1036RS	VMD1036*		36
GL 1100 /1100 I Goldwing/Interstate		1983	FA69*	FA69V	FA69HH*				MD1036LS	MD1036RS	VMD1036*		37
GL 1100 /1100 I Goldwing/Interstate		1981	FA29*	FA29V*					MD1036LS	MD1036RS	VMD1036*		38
GL 1100 /1100 I Goldwing/Interstate		1982	FA69/2*	FA69/2V					MD1036LS	MD1036RS	VMD1036*		39
GL 1100 A Goldwing Aspencade		1982-1983	FA69/2*	FA69/2V					MD1133	MD1133			40
ST 1100		1991-2002	FA142*		FA142HH*				MD1021LS	MD1021RS			41
ST 1100 A ABS Model		1995	FA142*		FA142HH*				MD1021LS	MD1021RS			42
ST 1100 A ABS Model		1996-2002			FA261HH*	EPFA261HH*			MD1008	MD1008			43
VF 1100 C V65 Magna		1983-1986	FA69*	FA69V*	FA69HH*				MD1040LS	MD1040RS			44
VF 1100 S V65 Sabre		1984-1985	FA69*	FA69V*	FA69HH*				MD1001	MD1001			45
VT 1100 C Shadow		1985-1986	FA69*	FA69V*	FA69HH*				MD1040LS	MD1040RS			46
VT 1100 C Shadow		1987-1994	FA69/3	FA69/3V	FA69/3HH					MD1080RS			47
VT 1100 C Shadow		1995-1996	FA196	FA196V	FA196HH					MD1167RS			48
VT 1100 C Shadow Spirit		1997-2007	FA196	FA196V	FA196HH					MD1167RS			49
VT 1100 C2 Shadow American Classic Edition		1995-1999	FA196	FA196V	FA196HH				MD1179				50
VT 1100 C2 Shadow Sabre		2000-2007	FA196	FA196V	FA196HH				MD1179				51
VT 1100 C2-2 Shadow 1100 American Classic Edition		1997	FA196	FA196V	FA196HH				MD1179				52
VT 1100 C3 Shadow Aero		1998-2002	FA196	FA196V	FA196HH				MD1179				53
VT 1100 D2 Shadow American Classic Edition		1999	FA196	FA196V	FA196HH				MD1179				54
VT 1100 T Shadow American Classic Edition Tourer		1998-2001	FA196	FA196V	FA196HH				MD1179				55
GL 1200 A/SEI Goldwing		1986-1987	FA69/3*	FA69/3V*	FA69/3HH*				MD1125	MD1125			56

FRONT

⚠ This symbol indicates a rotor made of billet steel, and should be only used with EBC FA Organic or Vee pads.
SAFETY NOTICE - With vehicles primarily designed for off highway use such as quads now being used on the highway, we would recommend the use of X or MXS pads for highway use and ONLY using the R and SV higher density / harder pad series for off road riding.

*-2 Sets Required. † For Vee disc colours add RED, BLU, GRN, GLD, ORG suffix to part number. **SAFETY WARNING:- DO NOT USE HH PADS ON REAR UNLESS ALSO USED ON FRONT TO AVOID BRAKE IMBALANCE**

FRONT: HONDA Cont'd

REAR: HONDA

Line #	BRAKE ROTOR CHOICES - FRONT					Front Disc Bolt Kit	DISC PAD CHOICES - REAR					BRAKE ROTOR CHOICES - REAR				
	CX Extreme® /Vee-Rotor	OSX Series Oversize 280mm Rotor Kit	Relocating Bracket for Oversize Rotor	SMX Series Oversize 320mm Rotor Kit	Relocating Bracket for 320mm Rotor		FA/SFA/X Pad or Brake Shoe	Specialty Pads SXR/ VEE/MXS Race	Sintered/ HH Pads/ Grooved Shoes	EPFA Sintered Fast Road/ Track Pads	SV Series Severe Duty Pads	Standard Rotor	Vintage Rotor / UTV Oversize Brake Kit	Contour Profile Rotor	CX Extreme® /Vee-Rotor	Rear Disc Bolt Kit
1							FA69								MD1082	
2						DB102/6	FA174		FA174HH						MD1196	
3						DB102/6	FA174		FA174HH						MD1196	
4						DB102/6	FA174		FA174HH						MD1196	
5						DB102/6	FA174		FA174HH						MD1196	
6						DB102/6	SFA196		SFA196HH							
7						DB102/6										
8							FA32								MD1064	
9							FA32								MD1064	
10							FA32								MD1064	
11							FA109								MD1079	
12						DB102/6	FA174		FA174HH						MD1004	
13							FA703X	SXR703HH	FA703R		FA703SV	MD6410D*	UTVX6410*		MD1004C	
14							FA704X	SXR704HH	FA704R		FA704SV					
15							FA703X	SXR703HH	FA703R		FA703SV	MD6410D*	UTVX6410*			
16							FA704X	SXR704HH	FA704R		FA704SV					
17							FA703X	SXR703HH	FA703R		FA703SV	MD6425D*		MD6425C*		
18							FA704X	SXR704HH	FA704R		FA704SV					
19							FA703X	SXR703HH	FA703R		FA703SV	MD6425D*		MD6425C*		
20							FA704X	SXR704HH	FA704R		FA704SV					
21							FA703X	SXR703HH	FA703R		FA703SV	MD6425D*		MD6425C*		
22							FA704X	SXR704HH	FA704R		FA704SV					
23						DB102/6	FA69/3		FA69/3HH						MD1079	
24							FA109									
25	VR1003BLK*†					DB102/6	FA174		FA174HH					MD1004C	VR1004	
26	VR1014BLK*†					DB102/6			FA261HH	EPFA261HH				MD1006C	VR1006	
27							FA174		FA174HH							
28							FA174		FA174HH							
29							FA174		FA174HH							
30						DB102/6	FA69		FA69HH						MD1068	
31	VR1120BLK*†								FA261HH	EPFA261HH				MD1006C	VR1006	
32	VR1136BLK*†					DB102/6			FA261HH	EPFA261HH				MD1006C	VR1006	
33							FA496		FA496HH							
34							FA174		FA174HH						MD1196	
35							FA174		FA174HH						MD1196	
36							FA29								MD1071	
37							FA69		FA69HH						VMD1071	
38							FA29								MD1071	
39							FA69								VMD1071	
40							FA69								MD1082	
41							FA69								MD1082	
42							FA196		FA196HH						MD1077	
43						DB102/6	FA196		FA196HH						MD1077	
44									FA261HH						MD1135	
45						DB102/6	FA69/3		FA69/3HH						MD1078	
46							FA69/3		FA69/3HH						MD1079	
47							343									
48							343									
49							343									
50							343									
51							FA174		FA174HH						MD1016	
52							FA174		FA174HH						MD1016	
53							FA174		FA174HH						MD1016	
54							FA174		FA174HH						MD1016	
55							FA174		FA174HH						MD1016	
56							FA69/3		FA69/3HH						MD1082	

BRAKE APPLICATIONS

* This symbol indicates a rotor made of billet steel, and should be only used with EBC FA Organic or Vee pads.
 SAFETY NOTICE - With vehicles primarily designed for off highway use such as quads now being used on the highway, we would recommend the use of X or MXS pads for highway use and ONLY using the R and SV higher density / harder pad series for off road riding.

*-2 Sets Required. † For Vee disc colours add RED, BLU, GRN, GLD, ORG suffix to part number. **SAFETY WARNING:- DO NOT USE HH PADS ON REAR UNLESS ALSO USED ON FRONT TO AVOID BRAKE IMBALANCE**

FRONT: HONDA

APPLICATIONS

BRAKE



HONDA



DISC PAD CHOICES - FRONT

BRAKE ROTOR CHOICES - FRONT

Model	Year	FA/SFA/X Pad or Brake Shoe	Specialty Pads SXR/VEE/MXS Race	Sintered/HH Pads/Grooved Shoes	EPFA Sintered Fast Road/Track Pads	GPFAX Sintered RACE ONLY Pads	SV Series Severe Duty Pads	Standard Rotor		Vintage Rotor / UTV Oversize Brake Kit	Contour Profile Rotor	Line #
								Standard Rotor Left	Standard Rotor Right			
GL 1200 GL Goldwing	1984-1985	FA69/3*	FA69/3V*	FA69/3HH*				MD1083LS	MD1083RS			1
GL 1200 I Goldwing	1986-1987	FA69/3*	FA69/3V*	FA69/3HH*				MD1083LS	MD1083RS			2
GL 1200 L Goldwing	1985	FA69/3*	FA69/3V*	FA69/3HH*				MD1125	MD1125			3
VFR 1200 F	2010-2014			FA499/4HH*				MD1176X	MD1176X			4
VFR 1200 FD	2010-2014			FA499/4HH*				MD1176X	MD1176X			5
VFR 1200 FD Parking Brake	2010-2014	SFA257/2										6
VFR 1200 XA	2016-2017			FA388HH*	EPFA388HH*			MD1197	MD1197			7
VFR 1200 XD DCT	2016-2017			FA388HH*	EPFA388HH*			MD1197	MD1197			8
VFR 1200 XD DCT Parking Brake	2016-2017	SFA257/2										9
CTX 1300	2014-2019			FA388HH*	EPFA388HH*			MD1152X	MD1152X			10
ST 1300 ST 1300 A	2002-2007			FA261HH*	EPFA261HH*			MD1154X	MD1154X		MD1154XC*	11
ST 1300 ST 1300 A	2008-2013			FA388HH*	EPFA388HH*			MD1154X	MD1154X		MD1154XC*	12
VT 1300 CR Stataline	2010-2015	FA196	FA196V	FA196HH								13
VT 1300 CRA Stataline	2011-2015			FA388HH	EPFA388HH							14
VT 1300 CS Sabre	2010-2015	FA196	FA196V	FA196HH								15
VT 1300 CSA Sabre	2011-2014			FA388HH	EPFA388HH							16
VT 1300 CT Interstate	2010-2015	FA196	FA196V	FA196HH								17
VT 1300 CTA Interstate	2011-2015			FA388HH	EPFA388HH							18
VT 1300 CX Fury	2010-2020	FA196	FA196V	FA196HH								19
VT 1300 CXA Fury	2010-2023			FA388HH	EPFA388HH							20
VTX 1300 C	2004-2009	FA196	FA196V	FA196HH					MD1182RS			21
VTX 1300 R	2005-2009	FA196	FA196V	FA196HH					MD1182RS			22
VTX 1300 S Retro	2003-2007	FA196	FA196V	FA196HH					MD1158RS			23
VTX 1300 T	2008-2011	FA196	FA196V	FA196HH					MD1182RS			24
GL 1500 1500 Inc SE Goldwing	1990-2000	FA124/2*	FA124/2V*	FA124/2HH*				MD1126	MD1126			25
GL 1500 C CT Valkyrie Valkyrie Tourer	1997-1999	FA142*	FA142V*	FA142HH*				MD1014X	MD1014X		MD1014XC*	26
GL 1500 Goldwing All models	1988-1989	FA124/2*	FA124/2V*	FA124/2HH*				MD1126	MD1126			27
GL 1500 Valkyrie Valkyrie Tourer Valkyrie Interstate	2000-2003	FA142*	FA142V*	FA142HH*				MD1014X	MD1014X		MD1014XC*	28
GL 1800 1800 A Goldwing All models	2001-2017			FA261HH*	EPFA261HH*			MD1014X	MD1014X		MD1014XC*	29
GL 1800 B Goldwing	2018-2024			FA717HH*								30
GL 1800 BD Goldwing	2018-2024			FA717HH*								31
GL 1800 C Valkyrie	2014-2015			FA296HH*	EPFA296HH*							32
GL 1800 D Goldwing Tour	2018-2024			FA717HH*								33
GL 1800 DA Goldwing Tour	2018-2024			FA717HH*								34
GL 1800 Goldwing - Parking Brake	2018-2024	SFA257/2										35
GL 1800 Goldwing Tour J	2018-2022			FA717HH*								36
NRX 1800 Rune DA/DB/EA/EB	2004-2005		FA261V*	FA261HH*	EPFA261HH*							37
VTX 1800 C	2002-2008		FA261V*	FA261HH*	EPFA261HH*			MD1141X	MD1141X		MD1141XC*	38
VTX 1800 F	2005-2011		FA261V*	FA261HH*	EPFA261HH*			MD1141X	MD1141X		MD1141XC*	39
VTX 1800 N	2004-2011		FA261V*	FA261HH*	EPFA261HH*			MD1141X	MD1141X		MD1141XC*	40
VTX 1800 R	2002-2008		FA261V*	FA261HH*	EPFA261HH*			MD1141X	MD1141X		MD1141XC*	41
VTX 1800 S	2002-2007		FA261V*	FA261HH*	EPFA261HH*			MD1141X	MD1141X		MD1141XC*	42
VTX 1800 T	2007-2011		FA261V*	FA261HH*	EPFA261HH*			MD1141X	MD1141X		MD1141XC*	43
												44
												45
												46
												47
												48
												49
												50
												51
												52
												53
												54
												55
												56

FRONT

* This symbol indicates a rotor made of billet steel, and should be only used with EBC FA Organic or Vee pads.

SAFETY NOTICE - With vehicles primarily designed for off highway use such as quads now being used on the highway, we would recommend the use of X or MXS pads for highway use and ONLY using the R and SV higher density / harder pad series for off road riding.

*-2 Sets Required. † For Vee disc colours add RED, BLU, GRN, GLD, ORG suffix to part number. **SAFETY WARNING:- DO NOT USE HH PADS ON REAR UNLESS ALSO USED ON FRONT TO AVOID BRAKE IMBALANCE**

FRONT: HONDA Cont'd

REAR: HONDA

Line #	BRAKE ROTOR CHOICES - FRONT					Front Disc Bolt Kit	DISC PAD CHOICES - REAR					BRAKE ROTOR CHOICES - REAR				
	CX Extreme® /Vee-Rotor	OSX Series Oversize 280mm Rotor Kit	Relocating Bracket for Oversize Rotor	SMX Series Oversize 320mm Rotor Kit	Relocating Bracket for 320mm Rotor		FA/SFA/X Pad or Brake Shoe	Specialty Pads SXR/ VEE/MXS Race	Sintered/ HH Pads/ Grooved Shoes	EPFA Sintered Fast Road/ Track Pads	SV Series Severe Duty Pads	Standard Rotor	Vintage Rotor / UTV Oversize Brake Kit	Contour Profile Rotor	CX Extreme® /Vee-Rotor	Rear Disc Bolt Kit
1								FA69/3		FA69/3HH				MD1082		
2								FA69/3		FA69/3HH				MD1082		
3								FA69/3		FA69/3HH				MD1082		
4										FA488HH				MD1175		
5										FA636HH				MD1175		
6										FA636HH				MD1175		
7										FA636HH				MD1175		
8										FA636HH				MD1175		
9																
10						DB102/6				FA261HH				MD1163		
11						DB102/6								MD1163		
12						DB102/6								MD1163		
13								FA174		FA174HH						
14										FA261/2HH	EPFA261/2HH					
15								FA174		FA174HH						
16										FA261/2HH	EPFA261/2HH					
17								FA174		FA174HH						
18										FA261/2HH	EPFA261/2HH					
19								FA174		FA174HH				MD1159		
20										FA261HH	EPFA261HH			MD1159		
21								FA174		FA174HH				MD1159		
22								FA174		FA174HH				MD1159		
23								FA174		FA174HH				MD1159		
24								FA174		FA174HH				MD1159		
25								FA69/3		FA69/3HH				MD1077		
26	VR1014BLK*†					DB102/6		FA196		FA196HH				MD1077		
27								FA69/3		FA69/3HH				MD1127		
28	VR1014BLK*†					DB102/6		FA196		FA196HH				MD1148		
29	VR1014BLK*†					DB102/6				FA261/2HH	EPFA261/2HH					
30										FA388/2HH						
31										FA388/2HH						
32										FA261/2HH	EPFA261/2HH					
33										FA388/2HH						
34										FA388/2HH						
35																
36										FA388/2HH						
37										FA261HH	EPFA261HH					
38	VR1141BLK*†					DB102/6				FA261HH	EPFA261HH			MD1148		
39	VR1141BLK*†					DB102/6				FA261/2HH	EPFA261/2HH			MD1148		
40	VR1141BLK*†					DB102/6				FA261/2HH	EPFA261/2HH			MD1148		
41	VR1141BLK*†					DB102/6				FA261HH	EPFA261HH			MD1148		
42	VR1141BLK*†					DB102/6				FA261/2HH	EPFA261/2HH			MD1148		
43	VR1141BLK*†					DB102/6				FA261/2HH	EPFA261/2HH			MD1148		
44																
45																
46																
47																
48																
49																
50																
51																
52																
53																
54																
55																
56																

BRAKE APPLICATIONS
 * This symbol indicates a rotor made of billet steel, and should be only used with EBC FA Organic or Vee pads.
 SAFETY NOTICE - With vehicles primarily designed for off highway use such as quads now being used on the highway, we would recommend the use of X or MXS pads for highway use and ONLY using the R and SV higher density / harder pad series for off road riding.

*-2 Sets Required. † For Vee disc colours add RED, BLU, GRN, GLD, ORG suffix to part number. **SAFETY WARNING:- DO NOT USE HH PADS ON REAR UNLESS ALSO USED ON FRONT TO AVOID BRAKE IMBALANCE**

FRONT: KAWASAKI

APPLICATIONS

⚠ This symbol indicates a rotor made of billet steel, and should be only used with EBC FA Organic or Vee pads.

SAFETY NOTICE - With vehicles primarily designed for off highway use such as quads now being used on the highway, we would recommend the use of X or MXS pads for highway use and ONLY using the R and SV higher density / harder pad series for off road riding.



KAWASAKI



AR 50 A1		1982
KDX 50 A1-A6F		2003-2006
KFX 50		2013-2024
KSF 50 KFX		2003-2005
KSF 50 KFX		2007-2009
KX 60		1985-2003
KX 60 A1/A2		1983-1984
KX 65		2000-2024
AR 80 A1		1982
KD 80 M		1980-1987
KD 80 N		1988-1990
KDX 80		1984-1988
KDX 80 A		1980-1981
KDX 80 B		1982-1983
KSF 80		2003-2006
KX 80		1984-2000
KX 80 C		1981-1982
KX 80 E1		1983
KX 85		2001-2024
KFX 90		2001-2024
KE 100		1976-1981
KE 100		1982-2001
KM 100		1976-1981
KX 100		1995-1996
KX 100		1997-2000
KX 100		2001-2009
KX 100		2010-2021
KLF 110 Mojave		1987-1988
KLT 110 A1/A2/A3		1984-1986
KLX 110 L		2010-2021
KLX 110 R		2002-2024
KX 112		2021-2024
BN 125 Eliminator		2001-2009
KD 125		1975-1979
KE 125 A		1976-1983
KLX 125 A		2003-2006
KLX 125 L		2003-2006
KX 125		1983-1985
KX 125 A		1974-1981
KX 125 B1		1982
KX 125 E/F		1987-1988
KX 125 E1		1986
KX 125 G/H/J		1989-1993
KX 125 K/L		1995-2002
KX 125 K1		1994
KX 125 M		2003-2005
Ninja 125		2019-2021
Z 125 BR125		2017-2021
Z 125 Pro		2017-2023
Z 125 Pro SE		2017-2021
KLX 140		2008-2024
KLX 140 G		2017-2021
KLX 140 L		2008-2021
KLX 150 S		2009-2011
KLT 160 A1		1985
KDX 175 A		1980-1982

FRONT

DISC PAD CHOICES - FRONT							BRAKE ROTOR CHOICES - FRONT			
FA/SFA/X Pad or Brake Shoe	Specialty Pads SXR/VEE/MXS Race	Sintered/HH Pads/Grooved Shoes	EPFA Sintered Fast Road/Track Pads	GPFA Sintered RACE ONLY Pads	SV Series Severe Duty Pads	Standard Rotor Left	Standard Rotor Right	Vintage Rotor / UTV Oversize Brake Kit	Contour Profile Rotor	
SFA83		FA83HH				MD4040LS				
613		613G								
338*		338C*								
614*		614G*								
338*		338G*								
715		715G								
715		715G								
FA302X	MXS302	FA302R				MD6166D				
SFA83		FA83HH				MD4040LS				
603		603G								
FA83X		FA83R								
714		714G								
701		701G								
701		701G								
614*		614G*								
FA83X		FA83R				MD6027D				
701		701G								
714		714G								
FA258X		FA258R				MD6186D		MD6186C		
338*		338C*								
603		603G								
603		603G								
603		603G								
FA83X		FA83R				MD6026D				
FA258X		FA258R				MD6026D				
FA258X		FA258R				MD6186D		MD6186C		
FA258X		FA258R				MD6186D		MD6186C		
603*		603C*								
603		603G								
715		715G								
715		715G								
FA258X		FA258R				MD6186D		MD6186C		
FA197		FA197HH					MD4137RS			
704		704G								
704		704G								
604		604G								
FA230X		FA230R				MD6212D				
FA67X		FA67R								
704		704G								
FA83X		FA83R								
FA130X		FA130R				MD6036D				
FA67X		FA67R				MD6036D				
FA135X	MXS135	FA135R				MD6015D		MD6015C		
FA185X	MXS185	FA185R	EPFA185HH			MD6015D		MD6015C		
FA185X	MXS185	FA185R	EPFA185HH			MD6015D		MD6015C		
FA185X	MXS185	FA185R	EPFA185HH			MD6213D		MD6213C		
FA197		FA197HH				MD4166C		MD4166XC		
FA197		FA197HH				MD4166C		MD4166XC		
FA691		FA691HH				MD4162C		MD4171C		
FA691		FA691HH				MD4166C				
FA135X	MXS135	FA135R								
FA135X	MXS135	FA135R						MD6328C		
FA135X	MXS135	FA135R						MD6328C		
FA135X	MXS135	FA135R						MD6363C		
603		603G								
704		704G								

Line #
1
2
3
4
5
6
7
8
9
10
11
12
13
14
15
16
17
18
19
20
21
22
23
24
25
26
27
28
29
30
31
32
33
34
35
36
37
38
39
40
41
42
43
44
45
46
47
48
49
50
51
52
53
54
55
56

*-2 Sets Required. † For Vee disc colours add RED, BLU, GRN, GLD, ORG suffix to part number. **SAFETY WARNING:- DO NOT USE HH PADS ON REAR UNLESS ALSO USED ON FRONT TO AVOID BRAKE IMBALANCE**

FRONT: KAWASAKI Cont'd

REAR: KAWASAKI

Line # 1
2
3
4
5
6
7
8
9
10
11
12
13
14
15
16
17
18
19
20
21
22
23
24
25
26
27
28
29
30
31
32
33
34
35
36
37
38
39
40
41
42
43
44
45
46
47
48
49
50
51
52
53
54
55
56

BRAKE ROTOR CHOICES - FRONT						DISC PAD CHOICES - REAR						BRAKE ROTOR CHOICES - REAR				
CX Extreme® /Vee-Rotor	OSX Series Oversize 280mm Rotor Kit	Relocating Bracket for Oversize Rotor	SMX Series Oversize 320mm Rotor Kit	Relocating Bracket for 320mm Rotor	Front Disc Bolt Kit	FA/SFA/X Pad or Brake Shoe	Specialty Pads SXR/ VEE/MXS Race	Sintered/ HH Pads/ Grooved Shoes	EPFA Sintered Fast Road/ Track Pads	SV Series Severe Duty Pads	Standard Rotor	Vintage Rotor / UTV Oversize Brake Kit	Contour Profile Rotor	CX Extreme® /Vee-Rotor	Rear Disc Bolt Kit	
						603										
						613		613G								
						FA305X		FA305R			MD6267D					
						604		604G								
						FA305X		FA305R			MD6267D					
						715		715G								
						715		715G								
MD6166CX					DB403/4	FA54X		FA54R			MD6166D			MD6166CX	DB403/4	
						603										
						603		603G								
						603		603G								
						715		715G								
						701		701G								
						701		701G								
						618		618G								
						715		715G								
						701		701G								
						715		715G								
MD6186CX	OSX6186	BRK025			BD403/6	FA84X		FA84R			MD6187D		MD6187C	MD6187CX	DB403/4	
						FA305X		FA305R			MD6267D					
						603		603G								
						603		603G								
						603		603G								
						FA84X		FA84R			MD6025D		MD6025C			
						FA84X		FA84R			MD6025D		MD6025C			
MD6186CX	OSX6186	BRK025			BD403/6	FA84X		FA84R			MD6187D		MD6187C	MD6187CX	DB403/4	
MD6186CX	OSX6186	BRK025			BD403/6	FA84X		FA84R			MD6187D		MD6187C	MD6187CX	DB403/4	
						602		602G								
						602		602G								
						603		603G								
						603		603G								
MD6186CX	OSX6186	BRK025			BD403/6	FA84X		FA84R			MD6187D		MD6187C	MD6187CX	DB403/4	
						602										
						602		602G								
						602		602G								
						604		604G								
						604		604G								
						702		702G								
						602		602G								
						602		602G								
						FA67X		FA67R			MD6161D					
						FA67X		FA67R			MD6161D					
MD6015CX					DB402/4	FA152X	MXS152	FA152R			MD6024D			MD6024CX	DB402/6	
MD6015CX	OSX6015	BRK023	SMX6015	BRK024	DB402/4	FA131X	MXS131	FA131R			MD6024D			MD6024CX	DB402/6	
MD6015CX	OSX6015	BRK023	SMX6015	BRK024	DB402/4	FA152X	MXS152	FA152R			MD6024D			MD6024CX	DB402/6	
MD6213CX	OSX6213	BRK023	SMX6213	BRK024	DB403/4	FA131X	MXS131	FA131R			MD6208D			MD6208CX		
					DB405/5	FA197		FA197HH					MD4179AC			
		BRK040			DB405/5	FA197		FA197HH					MD4179AC			
	OSX4171	BRK040				FA54X		FA54HH					MD4172C			
	OSX4171	BRK040			DB405/5	FA54X		FA54HH					MD4172C			
						FA84X	MXS84	FA84R					MD6327C			
						FA84X	MXS84	FA84R					MD6327C			
						FA84X	MXS84	FA84R					MD6327C			
						FA54X	MXS54	FA54R					MD6362C			
						602		602G								
						602		602G								

REAR

BRAKE APPLICATIONS

⚠ This symbol indicates a rotor made of billet steel, and should be only used with EBC FA Organic or Vee pads.
SAFETY NOTICE - With vehicles primarily designed for off highway use such as quads now being used on the highway, we would recommend the use of X or MXS pads for highway use and ONLY using the R and SV higher density / harder pad series for off road riding.

*-2 Sets Required. † For Vee disc colours add RED, BLU, GRN, GLD, ORG suffix to part number. **SAFETY WARNING:- DO NOT USE HH PADS ON REAR UNLESS ALSO USED ON FRONT TO AVOID BRAKE IMBALANCE**

FRONT: KAWASAKI

APPLICATIONS

BRAKE



KAWASAKI



DISC PAD CHOICES - FRONT

BRAKE ROTOR CHOICES - FRONT

FRONT

Model	Year	FA/SFA/X Pad or Brake Shoe	Specialty Pads SXR/VEE/MXS Race	Sintered/HH Pads/Grooved Shoes	EPFA Sintered Fast Road/Track Pads	GPFAX Sintered RACE ONLY Pads	SV Series Severe Duty Pads	Standard Rotor Left	Standard Rotor Right	Vintage Rotor / UTV Oversize Brake Kit	Contour Profile Rotor	Line #
KE 175 D	1980-1983	704		704G								1
KLF 185 Bayou	1985											2
KLF 185 Bayou	1986-1988	705*		705G*								3
KLT 185 A	1986-1987	603		603G								4
KDX 200 A	1983-1985	703		703G								5
KDX 200 C	1986-1988	FA67X		FA67R				MD6036D				6
KDX 200 E	1989-1992	FA67X		FA67R				MD6036D				7
KDX 200 E	1993-1994	FA135X	MXS135	FA135R				MD6015D			MD6015C	8
KDX 200 H	1995-2006	FA185X	MXS185	FA185R	EPFA185HH			MD6083D				9
KLT 200 A1-A4/A4A	1981-1983	603		603G								10
KLT 200 B1	1983	603		603G								11
KLT 200 C	1983-1984	603		603G								12
KDX 220 R	1997-2005	FA185X	MXS185	FA185R	EPFA185HH			MD6083D				13
KLF 220 Bayou	1988-2002	705*		705G*								14
KLX 230	2019-2020	FA135X	MXS135	FA135R								15
KLX 230 R	2019-2024	FA135X	MXS135	FA135R				TBC				16
KLX 230 SM	2023-2024	FA135X	MXS135	FA135R								17
EL 250 Eliminator	1988-1989	FA85		FA85HH					MD4002RS			18
EL 250 F EL252	1997-1999	FA85		FA85HH								19
EL 250 HS	1991-1995	FA85		FA85HH								20
EX 250 Ninja	1986-1987	FA85		FA85HH				MD4002LS				21
EX 250 Ninja	1988-2007	FA129		FA129HH	EPFA129HH				MD4041RS			22
EX 250 Ninja R	2008-2012	FA197		FA197HH	EPFA197HH			MD4166C				23
KDX 250 A/B	1980-1982	705		705G								24
KDX 250 B	1983-1984	705		705G				MD4162C				25
KDX 250 D	1991	FA135X	MXS135	FA135R				MD4162C				26
KDX 250 D	1992-1994	FA135X	MXS135	FA135R				MD4162C			MD6015C	27
KH 250 A5	1976	711										28
KL 250 A	1978-1980	705		705G								29
KL 250 A	1980-1982	704		704G								30
KL 250 C	1983-1984	704		704G								31
KL 250 KLR	1985-2005	FA67X		FA67R								32
KL 250 Super Sherpa	2000-2009	FA258X		FA258R				MD6239D				33
KLF 250 Bayou	2003-2011	705*		705G*								34
KLT 250 A1/A2	1982-1983	603		603G								35
KLT 250 P1 Police	1984	603		603G								36
KLT 250 Prairie	1983-1985	603		603G								37
KLX 250 A	1979-1980	704		704G								38
KLX 250 R	1994-1996	FA185X	MXS185	FA185R	EPFA185HH			MD6015D			MD6015C	39
KLX 250 S	2001-2009	FA135X	MXS135	FA135R							MD6330C	40
KLX 250 S	2014-2020	FA135X	MXS135	FA135R				MD6330D			MD6330C	41
KLX 250 S H	2006-2007	FA185X	MXS185	FA185R	EPFA185HH			MD6330D			MD6330C	42
KLX 250 SF Supermotard	2009-2020	FA135X	MXS135	FA135R							MD6351C	43
KSF 250 Mojave	1987-2004	FA128X*		FA128R*			FA128SI*	MD6133D	MD6133D			44
KX 250 A	1980-1981	705		705G								45
KX 250 B	1982	FA83X		FA83R								46
KX 250 C/D	1983-1985	FA67X		FA67R								47
KX 250 D2	1986	FA67X		FA67R								48
KX 250 E	1987-1988	FA130X		FA130R				MD6036D				49
												50
KX 250 F	2004-2005	FA185X	MXS185	FA185R	EPFA185HH			MD6213D			MD6213C	51
KX 250 F	2006-2008	FA185X	MXS185	FA185R	EPFA185HH			MD6264D			MD6264C	52
KX 250 F	2009-2014	FA185X	MXS185	FA185R	EPFA185HH						MD6264C	53
KX 250 F	2015-2019	FA185X	MXS185	FA185R	EPFA185HH						MD6388C	54
KX 250 F	2020	FA185X	MXS185	FA185R	EPFA185HH						MD6388C	55
KX 250 F	2021-2024	FA185X	MXS185	FA185R	EPFA185HH						MD6388C	56

*-2 Sets Required. † For Vee disc colours add RED, BLU, GRN, GLD, ORG suffix to part number. **SAFETY WARNING:- DO NOT USE HH PADS ON REAR UNLESS ALSO USED ON FRONT TO AVOID BRAKE IMBALANCE**

This symbol indicates a rotor made of billet steel, and should be only used with EBC FA Organic or Vee pads. SAFETY NOTICE - With vehicles primarily designed for off highway use such as quads now being used on the highway, we would recommend the use of X or MXS pads for highway use and ONLY using the R and SV higher density / harder pad series for off road riding.

FRONT: KAWASAKI Cont'd

REAR: KAWASAKI

Line #	BRAKE ROTOR CHOICES - FRONT					DISC PAD CHOICES - REAR					BRAKE ROTOR CHOICES - REAR					
	CX Extreme® /Vee-Rotor	OSX Series Oversize 280mm Rotor Kit	Relocating Bracket for Oversize Rotor	SMX Series Oversize 320mm Rotor Kit	Relocating Bracket for 320mm Rotor	Front Disc Bolt Kit	FA/SFA/X Pad or Brake Shoe	Specialty Pads SXR/ VEE/MXS Race	Sintered/ HH Pads/ Grooved Shoes	EPFA Sintered Fast Road/ Track Pads	SV Series Severe Duty Pads	Standard Rotor	Vintage Rotor / UTV Oversize Brake Kit	Contour Profile Rotor	CX Extreme® /Vee-Rotor	Rear Disc Bolt Kit
1							703		703G							
2							706		706G							
3							706		706G							
4							602		602G							
5							702		702G							
6							702		702G							
7							FA152X		FA152R			MD6024D				DB402/6
8	MD6015CX						FA152X	MXS152	FA152R			MD6024D				DB402/6
9	MD6083CX						FA152X	MXS152	FA152R			MD6105D		MD6105CX		DB402/6
10							705		705G							
11							705		705G							
12							705		705G							
13	MD6083CX						FA152X	MXS152	FA152R			MD6105D		MD6105CX		DB402/6
14							706		706G							
15							FA54X	MXS54	FA54R							
16							FA54X	MXS54	FA54R							
17							FA54X	MXS54	FA54R							
18						DB404/5	706									
19							706									
20							706									
21							FA85		FA85HH			MD4032				
22							FA141					MD4042				
23						DB405/5	FA197		FA197HH				MD4163C			
24							605		605G							
25							602		602G							
26	MD6083CX						FA152X	MXS152	FA152R			MD6105D		MD6105CX		DB402/6
27	MD6015CX					DB402/4	FA152X	MXS152	FA152R			MD6105D		MD6105CX		DB402/6
28							708									
29							605		605G							
30							703		703G							
31							703		703G							
32							703		703G							
33							FA67X		FA67R			MD6107D				
34							706		706G							
35							705		705G							
36							705		705G							
37							705		705G							
38							602		602G							
39		OSX6015	BRK023	SMX6015	BRK024	DB402/4	FA152X	MXS152	FA152R			MD6085D				DB402/4
40		OSX6330	BRK019	SMX6330	BRK020		FA131X	MXS131	FA131R				MD6326C			
41	MD6330CX	OSX6330	BRK019	SMX6330	BRK020		FA131X	MXS131	FA131R				MD6326C			
42	MD6330CX	OSX6330	BRK021	SMX6330	BRK022		FA131X	MXS131	FA131R			MD6105D		MD6105CX		DB402/6
43							FA131X	MXS131	FA131R				MD6352C			
44							FA84X		FA84R	FA84SV		MD6132D				
45							605		605G							
46							602		602G							
47							602		602G							
48							FA67X		FA67R			MD6161D				
49							FA67X		FA67R			MD6161D				
50												MD6024D				
51	MD6213CX	OSX6213	BRK023	SMX6213	BRK024	DB403/4	FA367X	MXS367	FA367R			MD6208D	MD6208C	MD6208CX		
52	MD6264CX	OSX6264	BRK023	SMX6264	BRK024	DB403/4	FA367X	MXS367	FA367R			MD6208D	MD6208C	MD6208CX		
53	MD6264CX	OSX6264	BRK023	SMX6264	BRK024	DB404/5	FA367X	MXS367	FA367R			MD6208D	MD6208C	MD6208CX		
54	MD6388CX					DB403/4	FA367X	MXS367	FA367R				MD6208C	MD6208CX		
55	MD6388CX					DB403/4	FA367X	MXS367	FA367R			MD6421D	MD6421C	MD6421CX		
56	MD6388CX					DB403/4	FA367X	MXS367	FA367R				MD6208C	MD6208CX		

BRAKE APPLICATIONS

This symbol indicates a rotor made of billet steel, and should be only used with EBC FA Organic or Vee pads.
SAFETY NOTICE - With vehicles primarily designed for off highway use such as quads now being used on the highway, we would recommend the use of X or MXS pads for highway use and ONLY using the R and SV higher density / harder pad series for off road riding.

*-2 Sets Required. † For Vee disc colours add RED, BLU, GRN, GLD, ORG suffix to part number. **SAFETY WARNING:- DO NOT USE HH PADS ON REAR UNLESS ALSO USED ON FRONT TO AVOID BRAKE IMBALANCE**

FRONT: KAWASAKI

APPLICATIONS

SAFETY NOTICE - With vehicles primarily designed for off highway use such as quads now being used on the highway, we would recommend the use of X or MXS pads for highway use and ONLY using the R and SV higher density / harder pad series for off road riding.



KAWASAKI



DISC PAD CHOICES - FRONT

BRAKE ROTOR CHOICES - FRONT

Model	Year	FA/SFA/X Pad or Brake Shoe	Specialty Pads SXR/VEE/MXS Race	Sintered/HH Pads/Grooved Shoes	EPFA Sintered Fast Road/Track Pads	GPFA Sintered RACE ONLY Pads	SV Series Severe Duty Pads	Standard Rotor		Vintage Rotor / UTV Oversize Brake Kit	Contour Profile Rotor	Line #
								Standard Rotor Left	Standard Rotor Right			
KX 250 G/H/J	1989-1993	FA135X	MXS135	FA135R				MD6015D			MD6015C	1
KX 250 K	1994	FA185X	MXS185	FA185R	EPFA185HH			MD6015D			MD6015C	2
KX 250 K	1995-2002	FA185X	MXS185	FA185R	EPFA185HH			MD6015D			MD6015C	3
KX 250 M	2003-2005	FA185X	MXS185	FA185R	EPFA185HH			MD6213D			MD6213C	4
KX 250 R	2006-2007	FA185X	MXS185	FA185R	EPFA185HH			MD6264D			MD6264C	5
KX 250 X	2021-2024	FA185X	MXS185	FA185R	EPFA185HH						MD6388C	6
KXF 250 Tecate 4	1987-1988	FA128X*		FA128R*			FA128SV*	MD6133D	MD6133D			7
KXT 250 A1 Tecate	1984	705		705G								8
KXT 250 A2 Tecate	1985	FA67X		FA67R			FA67SV					9
KXT 250 B1 Tecate	1986	FA67X		FA67R			FA67SV	MD6138D				10
KXT 250 B2 Tecate	1987	FA67X		FA67R			FA67SV	MD6138D				11
KZ 250 D1 LTD	1980-1981	605										12
KZ 250 L1 CSR	1982	605										13
KZ 250 W1 LTD	1983	605										14
300 Ninja EX	2013-2016	FA197		FA197HH	EPFA197HH			MD4166C			MD4166XC	15
300 Ninja EX	2013-2016	FA197		FA197HH	EPFA197HH			MD4166C			MD4166XC	16
300 Ninja SE EX	2013-2016	FA197		FA197HH	EPFA197HH			MD4162C			MD4166XC	17
300 Ninja SE EX	2014-2016	FA197		FA197HH	EPFA197HH			MD4166C			MD4166XC	18
KAF 300 Mule 500	1992-1995	628*		628G*								19
KAF 300 Mule 550	1997-2003	628*		628G*								20
KEF 300 Lakota	1995-2000	FA128X*		FA128R*			FA128SV*		MD6133D			21
KEF 300 Lakota Sport	2001-2003	FA128X*		FA128R*			FA128SV*	MD6133D	MD6133D			22
KLE 300 Versys-X	2018-2023	FA142	FA142V	FA142HH							MD4166XC	23
KLF 300 Bayou	1986-1987	717*		717G*								24
KLF 300 Bayou	1988-2004	FA67X*		FA67R*			FA67SV*	MD6133D	MD6133D			25
KLF 300 Bayou 4x4	Left 1989-2005	FA165X		FA165R			FA165SV	MD6131D				26
	Right	FA135X		FA135R			FA135SV		MD6131D			27
KLX 300	2021-2024	FA135X	MXS135	FA135R				MD6015D			MD6015C	28
KLX 300 A	1997-2007	FA185X	MXS185	FA185R	EPFA185HH			MD6015D			MD6015C	29
KLX 300 R	2021-2024	FA135X	MXS135	FA135R				MD6015D			MD6015C	30
KLX 300 SM	2021-2024	FA135X	MXS135	FA135R							MD6351C	31
KVF 300 Brute Force	2012-2024	FA377X*	FA377V*	FA377R*				MD6267D	MD6267D			32
KVF 300 Prairie 2 x 4	1999-2002	FA54X*		FA54R*			FA54SV*	MD6131D	MD6131D			33
KVF 300 Prairie 4 x 4	1999-2002	FA54X*		FA54R*			FA54SV*	MD6131D	MD6131D			34
EX 305 GPz	Left 1983	FA85		FA85HH				MD4099				35
	Right											36
KZ 305 CSR	Left 1981-1982	FA68		FA68HH				MD4043LS				37
	Right											38
KZ 305 CSR	Left 1982	FA68		FA68HH				MD4043LS				39
	Right											40
KZ 305 LTD	Left 1987-1988	FA68		FA68HH				MD4043LS				41
	Right											42
S2	Left 1972-1973	711										43
	Right											44
S2 A	Left 1972-1973	FA33										45
	Right											46
KVF 360 Prairie	2003-2009	FA54X*		FA54R*			FA54SV*	MD6188D	MD6188D	UTVX6188*		47
KVF 360 Prairie 360 4x4	2003-2012	FA54X*		FA54R*			FA54SV*	MD6188D	MD6188D	UTVX6188*		48
KVF 360 Prairie 4x4 Hardwoods Green HD	2003-2011	FA54X*		FA54R*			FA54SV*	MD6188D	MD6188D	UTVX6188*		49
KAF 400 Mule 600	2005	718*										50
KAF 400 Mule 600	2006-2016	718*										51
KAF 400 Mule 610 4x4	2005	718*										52
KAF 400 Mule 610 4x4	2011-2016	718*										53
KAF 400 Mule 610 4x4	2006-2010	718*										54
KAF 400 Mule 610 4x4 Hardwoods Green HD	2006-2009	718*										55
KAF 400 Mule 610 4x4 SE	2016	718*										56

*-2 Sets Required. † For Vee disc colours add RED, BLU, GRN, GLD, ORG suffix to part number. **SAFETY WARNING:- DO NOT USE HH PADS ON REAR UNLESS ALSO USED ON FRONT TO AVOID BRAKE IMBALANCE**

FRONT: KAWASAKI Cont'd

REAR: KAWASAKI

Line #	BRAKE ROTOR CHOICES - FRONT					DISC PAD CHOICES - REAR					BRAKE ROTOR CHOICES - REAR					
	CX Extreme® /Vee-Rotor	OSX Series Oversize 280mm Rotor Kit	Relocating Bracket for Oversize Rotor	SMX Series Oversize 320mm Rotor Kit	Relocating Bracket for 320mm Rotor	Front Disc Bolt Kit	FA/SFA/X Pad or Brake Shoe	Specialty Pads SXR/ VEE/MXS Race	Sintered/ HH Pads/ Grooved Shoes	EPFA Sintered Fast Road/ Track Pads	SV Series Severe Duty Pads	Standard Rotor	Vintage Rotor / UTV Oversize Brake Kit	Contour Profile Rotor	CX Extreme® /Vee-Rotor	Rear Disc Bolt Kit
1	MD6015CX	OSX6015	BRK023	SMX6015	BRK024	DB402/4	FA152X	MXS152	FA152R			MD6024D		MD6024C	MD6024CX	DB402/6
2	MD6015CX	OSX6015	BRK023	SMX6015	BRK024	DB402/4	FA152X	MXS152	FA152R			MD6024D		MD6024C	MD6024CX	DB402/6
3	MD6015CX	OSX6015	BRK023	SMX6015	BRK024	DB402/4	FA131X	MXS131	FA131R			MD6208D				
4	MD6213CX	OSX6213	BRK023	SMX6213	BRK024	DB403/4	FA131X	MXS131	FA131R			MD6208D		MD6208C	MD6208CX	
5	MD6264CX	OSX6264	BRK023	SMX6264	BRK024	DB403/4	FA131X	MXS131	FA131R			MD6208D		MD6208C	MD6208CX	
6	MD6388CX					DB403/4	FA367X	MXS367	FA367R					MD6208C	MD6208CX	
7							FA84X		FA84R		FA84SV	MD6136D				
8							FA83X		FA83R							
9							FA67X		FA67R		FA67SV					
10							FA67X		FA67R		FA67SV	MD6138D				
11							FA84X		FA84R		FA84SV	MD6134D				
12							602									
13							602									
14							602									
15	VR4166BLK†					DB405/5	FA197		FA197HH					MD4163C	VR4163	
16	VR4166BLK†					DB405/5	FA197		FA197HH					MD4179AC		
17	VR4166BLK†					DB404/5	FA197		FA197HH					MD4179AC		
18	VR4166BLK†					DB405/5	FA197		FA197HH					MD4163C	VR4163	
19							718*									
20							718*									
21							FA84X		FA84R		FA84SV	MD6132D				
22							FA84X		FA84R		FA84SV	MD6132D				
23							FA197		FA197HH					MD4179AC		
24							706*		706G*							
25							706*		706G*							
26							710		710G							
27																
28	MD6388CX					DB402/4	FA131X	MXS131	FA131R					MD6326C		
29	MD6015CX					DB402/4	FA131X	MXS131	FA131R						MD6105CX	
30	MD6015CX					DB402/4	FA131X	MXS131	FA131R					MD6326C		
31	MD6388CX						FA131X	MXS131	FA131R					MD6326C		
32							FA377X		FA377R			MD6267D				
33							710		710G							
34							710		710G							
35							706									
36							FA197									
37							706									
38							FA197									
39							706									
40							FA197									
41							706									
42							FA197									
43							708									
44							FA197									
45							708									
46							FA197									
47							FA192									
48							FA197									
49							FA192									
50							718*									
51							718*									
52							718*									
53							719*									
54							718*									
55							718*									
56							718*									

BRAKE APPLICATIONS
⚠ This symbol indicates a rotor made of billet steel, and should be only used with EBC FA Organic or Vee pads.
SAFETY NOTICE - With vehicles primarily designed for off highway use such as quads now being used on the highway, we would recommend the use of X or MXS pads for highway use and ONLY using the R and SV higher density / harder pad series for off road riding.

*-2 Sets Required. † For Vee disc colours add RED, BLU, GRN, GLD, ORG suffix to part number. **SAFETY WARNING:- DO NOT USE HH PADS ON REAR UNLESS ALSO USED ON FRONT TO AVOID BRAKE IMBALANCE**

FRONT: KAWASAKI

APPLICATIONS

BRAKE



KAWASAKI



DISC PAD CHOICES - FRONT

BRAKE ROTOR CHOICES - FRONT

Model	Year	Side	DISC PAD CHOICES - FRONT					BRAKE ROTOR CHOICES - FRONT				Line #	
			FA/SFA/X Pad or Brake Shoe	Specialty Pads SXR/VEE/MXS Race	Sintered/HH Grooved Shoes	EPFA Sintered Fast Road/Track Pads	GPFX Sintered RACE ONLY Pads	SV Series Severe Duty Pads	Standard Rotor Left	Standard Rotor Right	Vintage Rotor / UTV Oversize Brake Kit		Contour Profile Rotor
KAF 400 Mule 610 4x4 XC	2010-2016		718*										1
KAF 400 Mule 610 4x4 XC - SE	2014-2016		718*										2
KAF 400 Mule 610 4x4 XC Realtree/Camo	2011-2016		718*										3
KAF 400 Mule SX	2017-2022		718*										4
KAF 400 Mule SX 4x4	2017-2022		718*										5
KAF 400 Mule SX 4x4 SE	2017-2022		718*										6
KAF 400 Mule SX 4x4 XC	2017-2023		718*										7
KAF 400 Mule SX 4x4 XC Camo	2017-2023		718*										8
KAF 400 Mule SX 4x4 XC LE	2017-2023		718*										9
KDX 400 A	1979-1980		705		705G								10
KH 400 A	1976-1978		FA33								VMD4123		11
KLF 400 Bayou	1993-1999	Left	FA165X		FA165R				FA165SV	MD6131D			12
		Right	FA135X		FA135R			FA135SV		MD6131D			13
KLX 400 SR	2003-2004		FA185X	MXS185	FA185R	EPFA185HH				MD6017D		MD6017C	14
KLX 400 SR	2003-2004		FA185X	MXS185	FA185R	EPFA185HH				MD6017D		MD6017C	15
KSF 400 KFX	2003-2005		FA84X*		FA84R*			FA84SV*	MD6210D	MD6210D			16
KVF 400 Prairie	1997-1998		FA54X*		FA54R*			FA54SV*	MD6131D	MD6131D			17
KVF 400 Prairie 2 x 4	1999-2002		FA54X*		FA54R*			FA54SV*	MD6131D	MD6131D			18
KVF 400 Prairie 4 x 4	1999-2002		FA54X*		FA54R*			FA54SV*	MD6131D	MD6131D			19
KZ 400 S	1975-1977		711										20
Ninja 400	2017-2023		FA197		FA197HH	EPFA197HH	GPFX197HH		MD4174X			MD4174XC	21
Ninja 400 KRT	2018-2023		FA197		FA197HH	EPFA197HH	GPFX197HH		MD4174X			MD4174XC	22
S3/S3-A A 400cc	1974-1975	Left	FA33										23
		Right											24
Z 400	2019-2023		FA197		FA197HH	EPFA197HH	GPFX197HH		MD4174X			MD4174XC	25
ZX-4RR Ninja 400cc	2023-2024				FA379HH				MD4166X	MD4166X		MD4166XC*	26
KDX 420 B1	1981	Left	705		705G								27
		Right											28
KX 420 A	1980-1981	Left	705		705G								29
		Right											30
KZ 440 A	1980-1982	Left	FA73							MD4047LS			31
		Right											32
KZ 440 A4	1983	Left	FA68		FA68HH					MD4047LS			33
		Right											34
KZ 440 B	1980-1981	Left	711										35
		Right											36
KZ 440 D5 LTD	1983	Left	FA68		FA68HH					MD4010LS			37
		Right											38
KZ 440 G1	1982	Left	FA68		FA68HH					MD4010LS			39
		Right											40
KZ 440 LTD	1980-1982	Left	FA73							MD4047LS			41
		Right											42
EN 450 454 LTD	1985-1990	Left	FA85		FA85HH					MD4006LS			43
		Right											44
KDX 450 A1	1982		705		705G								45
KFX 450 R KSF	2008-2014	Left			FA342R			FA342SV	MD6137D				46
		Right			FA349R			FA349SV		MD6137D			47
KLX 450 R	2008-2012		FA185X	MXS185	FA185R	EPFA185HH						MD6264C	48
KX 450 F	2006-2008		FA185X	MXS185	FA185R	EPFA185HH			MD6264D			MD6264C	49
KX 450 F	2009-2014		FA185X	MXS185	FA185R	EPFA185HH						MD6264C	50
KX 450 F	2015-2017		FA185X	MXS185	FA185R	EPFA185HH						MD6388C	51
KX 450 F	2018-2024		FA185X	MXS185	FA185R	EPFA185HH						MD6388C	52
KX 450 F Tomac	2018-2019		FA185X	MXS185	FA185R							MD6388C	53
KX 450 SR Limited Edition Special Racer	2022-2024		FA185X	MXS185	FA185R	EPFA185HH						MD6388C	54
KX 450 X	2021-2024		FA185X	MXS185	FA185R	EPFA185HH						MD6388C	55
Eliminator	2024		FA197		FA197HH								56

⚠ This symbol indicates a rotor made of billet steel, and should be only used with EBC FA Organic or Vee pads.
SAFETY NOTICE - With vehicles primarily designed for off highway use such as quads now being used on the highway, we would recommend the use of X or MXS pads for highway use and ONLY using the R and SV higher density / harder pad series for off road riding.

*-2 Sets Required. † For Vee disc colours add RED, BLU, GRN, GLD, ORG suffix to part number. **SAFETY WARNING:- DO NOT USE HH PADS ON REAR UNLESS ALSO USED ON FRONT TO AVOID BRAKE IMBALANCE**

FRONT: KAWASAKI Cont'd

REAR: KAWASAKI

Line #	BRAKE ROTOR CHOICES - FRONT					Front Disc Bolt Kit	DISC PAD CHOICES - REAR					BRAKE ROTOR CHOICES - REAR				
	CX Extreme® /Vee-Rotor	OSX Series Oversize 280mm Rotor Kit	Relocating Bracket for Oversize Rotor	SMX Series Oversize 320mm Rotor Kit	Relocating Bracket for 320mm Rotor		FA/SFA/X Pad or Brake Shoe	Specialty Pads SXR/ VEE/MXS Race	Sintered/ HH Pads/ Grooved Shoes	EPFA Sintered Fast Road/ Track Pads	SV Series Severe Duty Pads	Standard Rotor	Vintage Rotor / UTV Oversize Brake Kit	Contour Profile Rotor	CX Extreme® /Vee-Rotor	Rear Disc Bolt Kit
1								719*								
2								719*								
3								719*								
4								718*								
5								718*								
6								718*								
7								718*								
8								718*								
9								718*								
10								605		605G						
11								708								
12								710		710G						
13																
14	MD6017CX	OSX6017	BRK023	SMX6017	BRK024			FA131X	MXS131	FA131R		MD6014D		MD6014CX		
15	MD6017CX	OSX6017	BRK023	SMX6017	BRK024			FA131X	MXS131	FA131R		MD6014D		MD6014CX		
16						DB302/3		FA137X		FA137R	FA137SV	MD6211D				
17								710		710G						
18								710		710G						
19								710		710G						
20								708								
21								FA197		FA197HH	EPFA197HH		MD4179AC			
22								FA197		FA197HH	EPFA197HH		MD4179AC			
23								708								
24								FA197								
25								FA197		FA197HH	EPFA197HH		MD4179AC			
26						DB405/5		FA174		FA174HH			MD4164AC		DB405/4	
27								605		605G						
28								FA197								
29								605		605G						
30								FA197								
31								706								
32								FA192								
33								706								
34								FA192								
35								706								
36								FA192								
37								706								
38								FA192								
39								706								
40								FA192								
41								706								
42								FA192								
43								709								
44								FA192								
45								605		605G						
46								FA84X		FA84R	FA84SV		MD6304C			
47																
48	MD6264CX	OSX6264	BRK023	SMX6264	BRK024	DB403/4		FA367X	MXS367	FA367R			MD6208C	MD6208CX		
49	MD6264CX	OSX6264	BRK023	SMX6264	BRK024	DB403/4		FA367X	MXS367	FA367R		MD6208D	MD6208C	MD6208CX		
50	MD6264CX	OSX6264	BRK023	SMX6264	BRK024	DB403/4		FA367X	MXS367	FA367R		MD6208D	MD6208C	MD6208CX		
51	MD6388CX			SMX6264	BRK024	DB403/4		FA367X	MXS367	FA367R			MD6208C	MD6208CX		
52	MD6388CX			SMX6264	BRK024	DB403/4		FA367X	MXS367	FA367R		MD6421D	MD6421C	MD6421CX		
53	MD6388CX					DB403/4		FA367X	MXS367	FA367R		MD6421D	MD6421C	MD6421CX		
54	MD6388CX			SMX6264	BRK024	DB403/4		FA367X	MXS367	FA367R		MD6421D	MD6421C	MD6421CX		
55	MD6388CX					DB403/4		FA367X	MXS367	FA367R		MD6208D	MD6208C	MD6208CX		
56								FA197		FA197HH						

BRAKE APPLICATIONS
⚠ This symbol indicates a rotor made of billet steel, and should be only used with EBC FA Organic or Vee pads.
SAFETY NOTICE - With vehicles primarily designed for off highway use such as quads now being used on the highway, we would recommend the use of X or MXS pads for highway use and ONLY using the R and SV higher density / harder pad series for off road riding.

*-2 Sets Required. † For Vee disc colours add RED, BLU, GRN, GLD, ORG suffix to part number. **SAFETY WARNING:- DO NOT USE HH PADS ON REAR UNLESS ALSO USED ON FRONT TO AVOID BRAKE IMBALANCE**

FRONT: KAWASAKI



KAWASAKI



DISC PAD CHOICES - FRONT

BRAKE ROTOR CHOICES - FRONT

FA/SFA/X Pad or Brake Shoe	Specialty Pads SXR/VEE/MXS Race	Sintered/HH Pads/Grooved Shoes	EPFA Sintered Fast Road/Track Pads	GPFAX Sintered RACE ONLY Pads	SV Series Severe Duty Pads	Standard Rotor Left	Standard Rotor Right	Vintage Rotor / UTV Oversize Brake Kit	Contour Profile Rotor
Eliminator SE		FA197HH							
EN 500 A/B		FA85				MD4006LS			
EN 500 Vulcan		FA85				MD4124LS			
EX 500 A		FA129	EPFA129HH			MD4016			
EX 500 Ninja		FA129	EPFA129HH				MD4016		
KH 500 A8		FA33				MD4052LS		VMD4052	
KX 500 A		FA67X	FA67R						
KX 500 B		FA67X	FA67R						
KX 500 C/D		FA130X	FA130R			MD6036D			
KX 500 D		FA135X	FA135R			MD6015D			MD6015C
KX 500 E		FA185X	FA185R	EPFA185HH		MD6015D			MD6015C
KX 500 E		FA185X	FA185R	EPFA185HH		MD6015D			MD6015C
KZ 550 A		FA73				MD4053LS			
KZ 550 A2/A3/A4		FA68	FA68HH			MD4006LS			
KZ 550 D GPz		FA68*	FA68HH*			MD4010LS	MD4010RS		
KZ 550 H GPz		FA68*	FA68HH*			MD4099	MD4099		
KZ 550 LTD		FA68	FA68HH			MD4006LS			
KZ 550 M LTD		FA68	FA68HH			MD4006LS			
KZ 550 Spectre F2 LTD		FA68	FA68HH			MD4006LS			
ZR 550 Zephyr		FA129*	FA129HH*	EPFA129HH*		MD4008X	MD4008X		MD4008XC*
ZR 550 Zephyr		FA129*	FA129HH*	EPFA129HH*		MD4008X	MD4008X		MD4008XC*
ZX 550 A GPz		FA85*	FA85HH*			MD4002LS	MD4002RS		
KL 600 A		FA67X	FA67R			MD6080D			
KL 600 B KLR		FA67X	FA67R			MD6080D			
ZL 600 A		FA85	FA85HH			MD4016			
ZL 600 B Eliminator		FA129	FA129V	FA129HH	EPFA129HH		MD4008X		MD4008XC
ZX 600 D ZX6		FA158*	FA158HH*	EPFA158HH*		MD4141X	MD4141X		MD4141XC*
ZX 600 Ninja		FA85*	FA85HH*			MD4028	MD4028		
ZX 600 Ninja R		FA129*	FA129HH*	EPFA129HH*		MD4026LS	MD4026RS		
ZX 600 Ninja ZX6		FA158*	FA158HH*	EPFA158HH*		MD4008X	MD4008X		MD4008XC*
ZX6R ZX 600 F		FA158*	FA158HH*	EPFA158HH*		MD4008X	MD4008X		MD4008XC*
ZX6R ZX 600 G/J		FA188*	FA188HH*	EPFA188HH*		MD4136X	MD4136X		MD4136XC*
ZX6R ZX 600 P/R			FA417/4HH*	EPFA417/4HH*	GPFAX417/4HH*				MD4152XC*
ZX6RR ZX 600 K/M			FA369/4HH*	EPFA369/4HH*		MD4151X	MD4151X		MD4151XC*
ZX6RR ZX 600 N			FA369/4HH*	EPFA369/4HH*					MD4152XC*
ZZR 600 ZX 600		FA158*	FA158HH*	EPFA158HH*		MD4153X	MD4153X		MD4153XC*
ZZR 600 ZX 600 J4		FA188*	FA188HH*	EPFA188HH*		MD4136X	MD4136X		MD4136XC*
ZZR 600 ZX 600 J6/7/8		FA188*	FA188HH*	EPFA188HH*		MD4136X	MD4136X		MD4136XC*
KAF 620 H 4x4		719*							
KAF 620 J1 Trans 4x4		719*							
KAF 620 K Trans 4x4		719*							
KAF 620 Mule 4000		719*							
KAF 620 Mule 4010 4x4		719*							
KAF 620 Mule 4010 Trans 4x4		719*							
KAF 620 N9F		719*							
KAF 620 S		719*							
KAF 620 T		719*							
KAF 620 V		719*							
ZX-6R ZX 636 30th Anniversary			FA296HH*	EPFA296HH*	GPFAX296HH*	MD4155X	MD4155X		MD4155XC*
ZX-6R ZX 636 30th Anniversary			FA296HH*	EPFA296HH*	GPFAX296HH*	MD4155X	MD4155X		MD4155XC*
ZX-6R ZX 636 A		FA188*	FA188HH*	EPFA188HH*		MD4136X	MD4136X		MD4136XC*
ZX-6R ZX 636 B			FA369/4HH*	EPFA369/4HH*		MD4151X	MD4151X		MD4151XC*
ZX-6R ZX 636 C			FA369/4HH*	EPFA369/4HH*					MD4152XC*
ZX-6R ZX 636 E			FA296HH*	EPFA296HH*	GPFAX296HH*	MD4155X	MD4155X		MD4155XC*
ZX-6R ZX 636 F			FA296HH*	EPFA296HH*	GPFAX296HH*	MD4155X	MD4155X		MD4155XC*
ZX-6R ZX 636 KRT Edition			FA296HH*	EPFA296HH*	GPFAX296HH*	MD4155X	MD4155X		MD4155XC*

APPLICATIONS

BRAKE

⚠ This symbol indicates a rotor made of billet steel, and should be only used with EBC FA Organic or Vee pads.

SAFETY NOTICE - With vehicles primarily designed for off highway use such as quads now being used on the highway, we would recommend the use of X or MXS pads for highway use and ONLY using the R and SV higher density / harder pad series for off road riding.

FRONT

Line #

*-2 Sets Required. † For Vee disc colours add RED, BLU, GRN, GLD, ORG suffix to part number. SAFETY WARNING:- DO NOT USE HH PADS ON REAR UNLESS ALSO USED ON FRONT TO AVOID BRAKE IMBALANCE

FRONT: KAWASAKI Cont'd

REAR: KAWASAKI

Line #

BRAKE ROTOR CHOICES - FRONT						DISC PAD CHOICES - REAR						BRAKE ROTOR CHOICES - REAR				
CX Extreme® /Vee-Rotor	OSX Series Oversize 280mm Rotor Kit	Relocating Bracket for Oversize Rotor	SMX Series Oversize 320mm Rotor Kit	Relocating Bracket for 320mm Rotor	Front Disc Bolt Kit	FA/SFA/X Pad or Brake Shoe	Specialty Pads SXR/ VEE/MXS Race	Sintered/ HH Pads/ Grooved Shoes	EPFA Sintered Fast Road/ Track Pads	SV Series Severe Duty Pads	Standard Rotor	Vintage Rotor / UTV Oversize Brake Kit	Contour Profile Rotor	CX Extreme® /Vee-Rotor	Rear Disc Bolt Kit	
1						FA197		FA197HH								
2						709										
3						709										
4						706										
5						FA67/3					MD4051					
6						710										
7						602		602G								
8						FA67X		FA67R			MD6161D					
9						FA67X		FA67R			MD6161D					
10	MD6015CX				DB402/4	FA152X	MXS152	FA152R			MD6024D		MD6024C	MD6024CX	DB402/6	
11	MD6015CX	OSX6015	BRK023	SMX6015	BRK024	FA152X	MXS152	FA152R			MD6024D		MD6024C	MD6024CX	DB402/6	
12	MD6015CX	OSX6015	BRK023	SMX6015	BRK024	FA131X	MXS131	FA131R			MD6024D		MD6024C	MD6024CX	DB402/6	
13						709										
14						709										
15						FA68		FA68HH			MD4169					
16						FA68		FA68HH			MD4024					
17						709										
18						709										
19						709										
20	VR4008BLK*†				DB404/5	FA141					MD4009		MD4009C	VR4009		
21	VR4008BLK*†				DB404/5	FA192		FA192HH			MD4009		MD4009C	VR4009		
22						FA85		FA85HH			MD4001			VR4009		
23						602		602G						VR4009		
24						602		602G						VR4009		
25						709								VR4009		
26	VR4008BLK†				DB404/5	709								VR4009		
27					DB404/5	FA129		FA129HH	EPFA129HH		MD4007		MD4007C	VR4009		
28						FA85		FA85HH			MD4015			VR4009		
29						FA129		FA129HH	EPFA129HH		MD4027					
30	VR4008BLK*†				DB404/5	FA192		FA192HH			MD4009		MD4009C	VR4009		
31	VR4008BLK*†				DB404/5	FA192		FA192HH			MD4023		MD4023C	VR4023		
32	VR4136BLK*†				DB404/5	FA192		FA192HH			MD4138		MD4138C	VR4138	DB404/4	
33	VR4152BLK*†				DB404/5	FA192		FA192HH			MD4138		MD4138C	VR4138	DB404/4	
34					DB404/5	FA192		FA192HH			MD4138		MD4138C	VR4138	DB404/4	
35	VR4152BLK*†				DB404/5	FA192		FA192HH			MD4138		MD4138C	VR4138	DB404/4	
36	VR4153BLK*†					FA192		FA192HH			MD4009		MD4009C	VR4009		
37	VR4136BLK*†				DB404/5	FA192		FA192HH			MD4138		MD4138C	VR4138	DB404/4	
38	VR4136BLK*†				DB404/5	FA192		FA192HH			MD4138		MD4138C	VR4138	DB404/4	
39						720*										
40						720*										
41						720*										
42						720*										
43						720*										
44						720*										
45						720*										
46						720*										
47						720*										
48						720*										
49	VR4155BLK*†				DB404/5	FA192		FA436HH			MD4165		MD4165C	VR4165	DB404/4	
50	VR4155BLK*†				DB404/5	FA197		FA436HH			MD4165		MD4165C	VR4165	DB404/4	
51	VR4136BLK*†				DB404/5	FA192		FA192HH			MD4138		MD4138C	VR4138	DB404/4	
52					DB404/5	FA192		FA192HH			MD4138		MD4138C	VR4138	DB404/4	
53	VR4152BLK*†				DB404/5	FA192		FA192HH			MD4138		MD4138C	VR4138	DB404/4	
54	VR4155BLK*†				DB404/5	FA436		FA436HH			MD4165		MD4165C	VR4165	DB404/4	
55	VR4155BLK*†				DB404/5	FA436		FA436HH			MD4165		MD4165C	VR4165	DB404/4	
56	VR4155BLK*†				DB404/5	FA436		FA436HH			MD4165		MD4165C	VR4165	DB404/4	

BRAKE APPLICATIONS

⚠ This symbol indicates a rotor made of billet steel, and should be only used with EBC FA Organic or Vee pads.
SAFETY NOTICE - With vehicles primarily designed for off highway use such as quads now being used on the highway, we would recommend the use of X or MXS pads for highway use and ONLY using the R and SV higher density / harder pad series for off road riding.

*-2 Sets Required. † For Vee disc colours add RED, BLU, GRN, GLD, ORG suffix to part number. **SAFETY WARNING:- DO NOT USE HH PADS ON REAR UNLESS ALSO USED ON FRONT TO AVOID BRAKE IMBALANCE**

FRONT: KAWASAKI



KAWASAKI



DISC PAD CHOICES - FRONT

BRAKE ROTOR CHOICES - FRONT

Model	Year	Left/Right	FA/SFA/X Pad or Brake Shoe	Specialty Pads SXR/VEE/MXS Race	Sintered/HH Pads/Grooved Shoes	EPFA Sintered Fast Road/Track Pads	GPFAX Sintered RACE ONLY Pads	SV Series Severe Duty Pads	Standard Rotor		Vintage Rotor / UTV Oversize Brake Kit	Contour Profile Rotor
									Standard Rotor Left	Standard Rotor Right		
ZX-6R ZX 636 KRT Edition	2016-2017				FA296HH*	EPFA296HH*	GPFAX296HH*		MD4155X	MD4155X		MD4155XC*
ZX-6R ZX 636R	2018-2021				FA296HH*	EPFA296HH*	GPFAX296HH*		MD4155X	MD4155X		MD4155XC*
ZX-6R ZX 636R	2018-2024				FA296HH*	EPFA296HH*	GPFAX296HH*		MD4155X	MD4155X		MD4155XC*
ZX-6R ZX 636R KRT Edition	2018-2024				FA296HH*	EPFA296HH*	GPFAX296HH*		MD4155X	MD4155X		MD4155XC*
EN 650 Vulcan S	2015-2020				FA281HH							
EN 650 Vulcan S	2015-2023				FA281HH							
EN 650 Vulcan S Café	2018-2023				FA281HH							
EN 650 Vulcan S SE	2018-2022				FA281HH							
ER 6N ER 650	2009-2010	Left	FA229		FA229HH	EPFA229HH						MD4159XC*
		Right	FA231		FA231HH	EPFA231HH						
EX 650 Ninja	2017-2024	Left	FA226*		FA226HH*	EPFA226HH*						MD4156AXC
		Right										MD4156XC
EX 650 Ninja 650	2012-2016	Left	FA229		FA229HH	EPFA229HH						MD4159XC*
		Right	FA231		FA231HH	EPFA231HH						
EX 650 Ninja 650 F	2013-2016	Left	FA229		FA229HH	EPFA229HH						MD4156AXC
		Right	FA231		FA231HH	EPFA231HH						MD4156XC
EX 650 Ninja 650 R	2006-2010	Left	FA229		FA229HH	EPFA229HH						MD4159XC*
		Right	FA231		FA231HH	EPFA231HH						
EX 650 Ninja 650 R CBF	2011	Left	FA229		FA229HH	EPFA229HH						MD4159XC*
		Right	FA231		FA231HH	EPFA231HH						
EX 650 Ninja JHF -	2017	Left	FA226*		FA226HH*	EPFA226HH*						MD4156AXC
		Right										MD4156XC
EX 650 Ninja KRT Edition	2018-2024	Left	FA226*		FA226HH*	EPFA226HH*						MD4156AXC
		Right										MD4156XC
KL 650 B2/B3 Tengai	1990-1991		FA129		FA129R				MD6081D			
KL 650 KLR	1987-2007		FA130X	FA130V	FA130R				MD6042D			
KL 650 KLR 650	2008-2018				FA228HH							MD6309C
KLE 650 DEF Versys	2014	Left	FA229		FA229HH	EPFA229HH						MD4156AXC
		Right	FA231		FA231HH	EPFA231HH						MD4159XC
KLE 650 Versys	2007-2014	Left	FA229		FA229HH	EPFA229HH						MD4159XC*
		Right	FA231		FA231HH	EPFA231HH						
KLE 650 Versys	2020-2022	Left	FA142*	FA142V*	FA142HH*							MD4156AXC
		Right										MD4159XC
KLE 650 Versys Grand Tourer	2020-2021	Left	FA142*	FA142V*	FA142HH*							MD4156AXC
		Right										MD4159XC
KLE 650 Versys LT	2015	Left	FA142*	FA142V*	FA142HH*							MD4156AXC
		Right										MD4159XC
KLE 650 Versys Tourer	2020-2021	Left	FA142*	FA142V*	FA142HH*							MD4156AXC
		Right										MD4159XC
KLE 650 Versys/LT	2016-2023	Left	FA142*	FA142V*	FA142HH*							MD4156AXC
		Right										MD4159XC
KLR 650 Adventure	2021-2023		FA228		FA228HH				TBC			
KLR 650 KLR 650 ABS	2021-2023		FA228		FA228HH				TBC			
KLR 650 Traveller	2021-2023		FA228		FA228HH				TBC			
KLX 650 C	1993-1996		FA185X	MXS185	FA185R	EPFA185HH			MD6086D			
KLX 650 R	1993-1995		FA185X	MXS185	FA185R	EPFA185HH			MD6015D			MD6015C
KLX 650 R D1	1996		FA185X	MXS185	FA185R	EPFA185HH			MD6015D			MD6015C
KVF 650 Brute Force 4x4	2005-2011	Left			FA342R			FA342SV	MD6188D		UTVX6188*	
		Right			FA349R			FA349SV		MD6188D		
KVF 650 Brute Force 4x4 Hardwoods Green HD	2005-2009	Left			FA342R			FA342SV	MD6188D		UTVX6188*	
		Right			FA349R			FA349SV		MD6188D		
KVF 650 Brute Force 4x4i	2007-2008	Left	FA165X		FA165R			FA165SV	MD6188D		UTVX6188*	
		Right	FA135X		FA135R			FA135SV		MD6188D		
KVF 650 Brute Force 4x4i	2008	Left	FA165X		FA165R			FA165SV	MD6188D		UTVX6188*	
		Right	FA135X		FA135R			FA135SV		MD6188D		

APPLICATIONS

⚠ This symbol indicates a rotor made of billet steel, and should be only used with EBC FA Organic or Vee pads.
SAFETY NOTICE - With vehicles primarily designed for off highway use such as quads now being used on the highway, we would recommend the use of X or MXS pads for highway use and ONLY using the R and SV higher density / harder pad series for off road riding.

*-2 Sets Required. † For Vee disc colours add RED, BLU, GRN, GLD, ORG suffix to part number. **SAFETY WARNING:- DO NOT USE HH PADS ON REAR UNLESS ALSO USED ON FRONT TO AVOID BRAKE IMBALANCE**

FRONT: KAWASAKI Cont'd

REAR: KAWASAKI

Line #	BRAKE ROTOR CHOICES - FRONT					Front Disc Bolt Kit	DISC PAD CHOICES - REAR					BRAKE ROTOR CHOICES - REAR				
	CX Extreme® /Vee-Rotor	OSX Series Oversize 280mm Rotor Kit	Relocating Bracket for Oversize Rotor	SMX Series Oversize 320mm Rotor Kit	Relocating Bracket for 320mm Rotor		FA/SFA/X Pad or Brake Shoe	Specialty Pads SXR/ VEE/MXS Race	Sintered/ HH Pads/ Grooved Shoes	EPFA Sintered Fast Road/ Track Pads	SV Series Severe Duty Pads	Standard Rotor	Vintage Rotor / UTV Oversize Brake Kit	Contour Profile Rotor	CX Extreme® /Vee-Rotor	Rear Disc Bolt Kit
1	VR4155BLK*†					DB404/5	FA436		FA436HH			MD4165		MD4165C	VR4165	DB404/4
2	VR4155BLK*†					DB404/5	FA436		FA436HH			MD4165		MD4165C	VR4165	DB404/4
3	VR4155BLK*†					DB404/5	FA436		FA436HH			MD4165		MD4165C	VR4165	DB404/4
4	VR4155BLK*†					DB404/5	FA436		FA436HH			MD4165		MD4165C	VR4165	DB404/4
5							FA174		FA174HH			MD4165		MD4165C		DB404/4
6							FA174		FA174HH			MD4165		MD4165C		DB404/4
7							FA174		FA174HH			MD4165		MD4165C		DB404/4
8							FA174		FA174HH			MD4165		MD4165C		DB404/4
9	VR4159BLK*†					DB404/5	FA192		FA192HH					MD4138C	VR4138	DB404/4
10																
11						DB404/5	FA174		FA174HH			MD4164AC				
12						DB404/5										
13	VR4159BLK*†					DB404/5	FA192		FA192HH					MD4138C	VR4138	DB404/4
14																
15						DB404/5	FA192		FA192HH			MD4164AC				DB405/4
16						DB404/5										
17	VR4159BLK*†					DB404/5	FA192		FA192HH					MD4138C	VR4138	DB404/4
18																
19	VR4159BLK*†					DB404/5	FA192		FA192HH					MD4138C	VR4138	DB404/4
20																
21						DB404/5	FA174		FA174HH							
22						DB404/5										
23						DB404/5	FA174		FA174HH			MD4164AC				
24						DB404/5										
25							FA67X		FA67R			MD6082D				
26	MD6042CX						FA67X		FA67R			MD6082D			MD6082CX	
27	MD6309CX								FA197HH					MD6310C	MD6310CX	
28						DB404/5						MD4164AC				DB405/4
29						DB404/5	FA192		FA192HH							
30						DB404/5										
31							FA192		FA192HH			MD4138				DB404/4
32						DB404/5										DB405/4
33						DB404/5	FA174		FA174HH			MD4178AC				DB405/4
34						DB404/5										DB405/4
35						DB404/5	FA174		FA174HH			MD4178AC				DB405/4
36						DB404/5										
37						DB404/5	FA174		FA174HH			MD4178AC				
38						DB404/5										DB405/4
39						DB404/5	FA174		FA174HH			MD4178AC				DB405/4
40						DB404/5										DB405/4
41						DB404/5	FA174		FA174HH			MD4178AC				DB405/4
42							FA197		FA197HH					MD6310C	MD6310CX	
43							FA197		FA197HH					MD6310C	MD6310CX	
44							FA197		FA197HH					MD6310C	MD6310CX	
45							FA152X	MXS152	FA152R			MD6085D				DB402/4
46	MD6015CX	OSX6015	BRK023	SMX6015	BRK024	DB402/4	FA152X	MXS152	FA152R			MD6085D				DB402/4
47	MD6015CX	OSX6015	BRK023	SMX6015	BRK024	DB402/4	FA131X	MXS131	FA131R			MD6105D			MD6105CX	DB402/6
48																
49																
50																
51																
52																
53																
54																
55																
56																

⊗ This symbol indicates a rotor made of billet steel, and should be only used with EBC FA Organic or Vee pads.
SAFETY NOTICE - With vehicles primarily designed for off highway use such as quads now being used on the highway, we would recommend the use of X or MXS pads for highway use and ONLY using the R and SV higher density / harder pad series for off road riding.

*-2 Sets Required. † For Vee disc colours add RED, BLU, GRN, GLD, ORG suffix to part number. **SAFETY WARNING:- DO NOT USE HH PADS ON REAR UNLESS ALSO USED ON FRONT TO AVOID BRAKE IMBALANCE**

FRONT: KAWASAKI



KAWASAKI



APPLICATIONS
BRAKE

⊛ This symbol indicates a rotor made of billet steel, and should be only used with EBC FA Organic or Vee pads.
SAFETY NOTICE - With vehicles primarily designed for off highway use such as quads now being used on the highway, we would recommend the use of X or MXS pads for highway use and ONLY using the R and SV higher density / harder pad series for off road riding.

			DISC PAD CHOICES - FRONT					BRAKE ROTOR CHOICES - FRONT				Line #	
			FA/SFA/X Pad or Brake Shoe	Specialty Pads SXR/VEE/MXS Race	Sintered/HH Pads/Grooved Shoes	EPFA Sintered Fast Road/Track Pads	GPFA Sintered RACE ONLY Pads	SV Series Severe Duty Pads	Standard Rotor Left	Standard Rotor Right	Vintage Rotor / UTV Oversize Brake Kit	Contour Profile Rotor	
KVF 650 Brute Force 650 4x4i	Left	2006-2011	FA165X		FA165R			FA165SV	MD6188D		UTVX6188*		1
	Right		FA135X		FA135R			FA135SV		MD6188D			2
KVF 650 Brute Force 650 4x4i	Left	2012	FA165X		FA165R			FA165SV	MD6188D		UTVX6188*		3
	Right		FA135X		FA135R			FA135SV		MD6188D			4
KVF 650 Brute Force 650 4x4i - Hardwood Green HD	Left	2006-2010	FA165X		FA165R			FA165SV	MD6188D		UTVX6188*		5
	Right		FA135X		FA135R			FA135SV		MD6188D			6
KVF 650 Prairie	Left	2002-2003			FA342R			FA342SV	MD6188D		UTVX6188*		7
	Right				FA349R			FA349SV		MD6188D			8
KZ 650 B		1977-1979	FA33						MD4052LS		VMD4052		9
KZ 650 C		1977-1979	FA33						MD4059LS	MD4059RS	VMD4059*		10
KZ 650 C3		1979	FA73						MD4059LS	MD4059RS	VMD4059*		11
KZ 650 D SR Series		1978-1979	FA33*						MD4059LS	MD4059RS	VMD4059*		12
KZ 650 D2 SR Series		1979	FA73*						MD4059LS	MD4059RS	VMD4059*		13
KZ 650 F1		1980	FA73						MD4064LS		VMD4064		14
KZ 650 H CSR		1981-1983	FA68	FA68V	FA68HH				MD4065LS				15
KZ 650 LTD		1980	FA73						MD4064LS		VMD4064		16
W 650 EJ 650		2000-2002	FA231		FA231HH	EPFA231HH				MD4008X		MD4008XC	17
Z 650 ER 650		2018-2023	FA226*		FA226HH*	EPFA226HH*						MD4156XC*	18
Z 650 ER 650 GHF		2017	FA142*		FA142HH*							MD4156XC*	19
Z 650 ER 650 HHF		2017	FA142*		FA142HH*							MD4156XC*	20
Z 650 RS		2021-2023	FA142*		FA142HH*								21
KAF 700 Mule Pro DXT	Left	2024	FA165X		FA165R								22
	Right		FA135X		FA135R								23
KAF 700 Mule Pro MX	Left	2019-2024	FA165X		FA165R								24
	Right		FA135X		FA135R								25
KSV 700 KFX 700 V Force	Left	2004			FA342R			FA342SV	MD6137D				26
	Right				FA349R			FA349SV		MD6137D			27
KVF 700 D1 Team Green	Left	2005-2006			FA342R			FA342SV	MD6188D		UTVX6188*		28
	Right				FA349R			FA349SV		MD6188D			29
KVF 700 KFX 4x4	Left	2004-2009			FA342R			FA342SV	MD6188D		UTVX6188*		30
	Right				FA349R			FA349SV		MD6188D			31
KVF 700 Prairie 4x4	Left	2004-2009			FA342R			FA342SV	MD6188D		UTVX6188*		32
	Right				FA349R			FA349SV		MD6188D			33
KZ 700 A1		1984	FA68*	FA68V*	FA68HH*				MD4010LS	MD4010RS			34
ST700 Stallion		2014-2018			FA380HH*				MD4155X	MD4155X		MD4155XC*	35
VN 700 Vulcan		1985	FA85*	FA85V*	FA85HH*				MD4010LS	MD4010RS			36
ZN 700 LTD		1984-1985	FA85*	FA85V*	FA85HH*				MD4067LS	MD4067RS			37
H2 A Mach IV 750-2T		1972-1973	FA55						MD4069LS		VMD4069		38
H2 B/H-C Mach IV 750-2T		1974-1975	FA55						MD4069LS		VMD4069		39
KRF 750 L9F Teryx 750 Fi 4x4 LE Sport	Left	2009	FA165X		FA165R			FA165SV	MD6325D		UTVX6325*		40
	Right		FA135X		FA135R			FA135SV		MD6325D			41
KRF 750 M9F Teryx 750 Fi 4x4 NRA Outdoors	Left	2009	FA165X		FA165R			FA165SV	MD6325D		UTVX6325*		42
	Right		FA135X		FA135R			FA135SV		MD6325D			43
KRF 750 Teryx 4x4 LE RUV	Left	2008	FA165X		FA165R			FA165SV	MD6325D		UTVX6325*		44
	Right		FA135X		FA135R			FA135SV		MD6325D			45
KRF 750 Teryx 4x4 NRA Outdoors RUV	Left	2008	FA165X		FA165R			FA165SV	MD6325D		UTVX6325*		46
	Right		FA135X		FA135R			FA135SV		MD6325D			47
KRF 750 Teryx 4x4 RUV	Left	2008	FA165X		FA165R			FA165SV	MD6325D		UTVX6325*		48
	Right		FA135X		FA135R			FA135SV		MD6325D			49
KRF 750 Teryx 750 Fi 4x4	Left	2009-2013	FA165X		FA165R			FA165SV	MD6325D		UTVX6325*		50
	Right		FA135X		FA135R			FA135SV		MD6325D			51
KRF 750 Teryx 750 Fi 4x4 LE	Left	2009-2013	FA165X		FA165R			FA165SV	MD6325D		UTVX6325*		52
	Right		FA135X		FA135R			FA135SV		MD6325D			53
KRF 750 Teryx 750 Fi 4x4 SGE	Left	2010-2011	FA165X		FA165R			FA165SV	MD6325D		UTVX6325*		54
	Right		FA135X		FA135R			FA135SV		MD6325D			55

*-2 Sets Required. † For Vee disc colours add RED, BLU, GRN, GLD, ORG suffix to part number. **SAFETY WARNING:- DO NOT USE HH PADS ON REAR UNLESS ALSO USED ON FRONT TO AVOID BRAKE IMBALANCE**

FRONT: KAWASAKI Cont'd

REAR: KAWASAKI

Line #	BRAKE ROTOR CHOICES - FRONT					REAR	DISC PAD CHOICES - REAR					BRAKE ROTOR CHOICES - REAR				
	CX Extreme® /Vee-Rotor	OSX Series Oversize 280mm Rotor Kit	Relocating Bracket for Oversize Rotor	SMX Series Oversize 320mm Rotor Kit	Relocating Bracket for 320mm Rotor		Front Disc Bolt Kit	FA/SFA/X Pad or Brake Shoe	Specialty Pads SXR/ VEE/MXS Race	Sintered/ HH Pads/ Grooved Shoes	EPFA Sintered Fast Road/ Track Pads	SV Series Severe Duty Pads	Standard Rotor	Vintage Rotor / UTV Oversize Brake Kit	Contour Profile Rotor	CX Extreme® /Vee-Rotor
1																
2																
3																
4																
5																
6																
7																
8																
9																
10							709									
11							FA37									
12							FA36					MD4062				
13							FA36									
14						DB404/5	FA36					MD4063	VMD4063			
15							709									
16						DB404/5	709									
17	VR4008BLK†					DB404/5	709									
18						DB404/5	706									
19						DB404/5	FA174	FA174HH					MD4164AC		DB405/4	
20						DB404/5	FA174	FA174HH					MD4138C		DB404/4	
21						DB404/5	FA174	FA174HH					MD4138C		DB404/4	
22							FA174	FA174HH				MD4164AC				
23							FA377X*	FA377HH*				TBC*				
24							FA377X*	FA377HH*				TBC*				
25																
26																
27																
28																
29																
30																
31																
32																
33																
34							FA68	FA68HH				MD4169				
35	VR4155BLK*†					DB404/5	FA196	FA196HH				MD4169				
36							709									
37							FA85	FA85HH				MD4068				
38							713									
39							713									
40																
41																
42																
43																
44																
45																
46																
47																
48																
49																
50																
51																
52																
53																
54																
55																
56																

BRAKE APPLICATIONS
 * This symbol indicates a rotor made of billet steel, and should be only used with EBC FA Organic or Vee pads.
 SAFETY NOTICE - With vehicles primarily designed for off highway use such as quads now being used on the highway, we would recommend the use of X or MXS pads for highway use and ONLY using the R and SV higher density / harder pad series for off road riding.

*-2 Sets Required. † For Vee disc colours add RED, BLU, GRN, GLD, ORG suffix to part number. **SAFETY WARNING:- DO NOT USE HH PADS ON REAR UNLESS ALSO USED ON FRONT TO AVOID BRAKE IMBALANCE**

FRONT: KAWASAKI



KAWASAKI



APPLICATIONS
BRAKE

⚠ This symbol indicates a rotor made of billet steel, and should be only used with EBC FA Organic or Vee pads.
SAFETY NOTICE - With vehicles primarily designed for off highway use such as quads now being used on the highway, we would recommend the use of X or MXS pads for highway use and ONLY using the R and SV higher density / harder pad series for off road riding.

DISC PAD CHOICES - FRONT

BRAKE ROTOR CHOICES - FRONT

Model	Side	Year	DISC PAD CHOICES - FRONT					BRAKE ROTOR CHOICES - FRONT				Line #	
			FA/SFA/X Pad or Brake Shoe	Specialty Pads SXR/VEE/MXS Race	Sintered/HH Pads/Grooved Shoes	EPFA Sintered Fast Road/Track Pads	GPFA Sintered RACE ONLY Pads	SV Series Severe Duty Pads	Standard Rotor Left	Standard Rotor Right	Vintage Rotor / UTV Oversize Brake Kit		Contour Profile Rotor
KRF 750 Teryx 750 Fi 4x4 Sport LE Sport	Left	2010-2013	FA165X		FA165R			FA165SV	MD6325D		UTVX6325*		1
	Right		FA135X		FA135R			FA135SV		MD6325D			2
KRT 750 Teryx 4 750 4x4	Left	2012-2013	FA165X		FA165R			FA165SV	MD6399D		UTVX6399*		3
	Right		FA135X		FA135R			FA135SV		MD6399D			4
KRT 750 Teryx 4 750 4x4 EPS	Left	2012-2013	FA165X		FA165R			FA165SV	MD6399D		UTVX6399*		5
	Right		FA135X		FA135R			FA135SV		MD6399D			6
KRT 750 Teryx 4 750 4x4 EPS LE	Left	2012-2013	FA165X		FA165R			FA165SV	MD6399D		UTVX6399*		7
	Right		FA135X		FA135R			FA135SV		MD6399D			8
KRT 750 Teryx 4 750 4x4 EPS Realtree	Left	2012-2013	FA165X		FA165R			FA165SV	MD6399D		UTVX6399*		9
	Right		FA135X		FA135R			FA135SV		MD6399D			10
KVF 750 Brute Force 750 4x4 i / EPS	Left	2012-2017	FA165X		FA165R			FA165SV	MD6188D		UTVX6188*		11
	Right		FA135X		FA135R			FA135SV		MD6188D			12
KVF 750 Brute Force 750 4x4 i / EPS	Left	2012-2023	FA165X		FA165R			FA165SV	MD6188D		UTVX6188*		13
	Right		FA135X		FA135R			FA135SV		MD6188D			14
KVF 750 Brute Force 750 4x4 i / EPS / Camo	Left	2012-2023	FA165X		FA165R			FA165SV	MD6188D		UTVX6188*		15
	Right		FA135X		FA135R			FA135SV		MD6188D			16
KVF 750 Brute Force 750 4x4i	Left	2005-2007	FA165X		FA165R			FA165SV	MD6188D		UTVX6188*		17
	Right		FA135X		FA135R			FA135SV		MD6188D			18
KVF 750 Brute Force 750 4x4i	Left	2005-2011	FA165X		FA165R			FA165SV	MD6188D		UTVX6188*		19
	Right		FA135X		FA135R			FA135SV		MD6188D			20
KVF 750 Brute Force 750 4x4i	Left	2006-2007	FA165X		FA165R			FA165SV	MD6188D		UTVX6188*		21
	Right		FA135X		FA135R			FA135SV		MD6188D			22
KVF 750 Brute Force 750 4x4i	Left	2008	FA165X		FA165R			FA165SV	MD6188D		UTVX6188*		23
	Right		FA135X		FA135R			FA135SV		MD6188D			24
KVF 750 Brute Force 750 4x4i	Left	2010-2011	FA165X		FA165R			FA165SV	MD6188D		UTVX6188*		25
	Right		FA135X		FA135R			FA135SV		MD6188D			26
KVF 750 Brute Force 750 4x4i	Left	2012-2017	FA165X		FA165R			FA165SV	MD6188D		UTVX6188*		27
	Right		FA135X		FA135R			FA135SV		MD6188D			28
KVF 750 Brute Force 750 4x4i Hardwoods Green HD	Left	2005	FA165X		FA165R			FA165SV	MD6188D		UTVX6188*		29
	Right		FA135X		FA135R			FA135SV		MD6188D			30
KVF 750 Brute Force 750 4x4i Hardwoods Green HD	Left	2008-2009	FA165X		FA165R			FA165SV	MD6188D		UTVX6188*		31
	Right		FA135X		FA135R			FA135SV		MD6188D			32
KVF 750 Brute Force 750 4x4i NRA Outdoors	Left	2008-2010	FA165X		FA165R			FA165SV	MD6188D		UTVX6188*		33
	Right		FA135X		FA135R			FA135SV		MD6188D			34
KZ 750 B		1976-1979	FA33						MD4052LS		VMD4052		35
KZ 750 E		1980-1982	FA68*	FA68V*	FA68HH*				MD4010LS	MD4010RS			36
KZ 750 F1 LTD		1983	FA68*	FA68V*	FA68HH*				MD4010LS	MD4010RS			37
KZ 750 G1 LTD		1980	FA73										38
KZ 750 H LTD		1980-1983	FA68*	FA68V*	FA68HH*				MD4010LS	MD4010RS			39
KZ 750 K LTD		1983-1984	FA85	FA85V	FA85HH				MD4070LS				40
KZ 750 L3		1983	FA68*	FA68V*	FA68HH*				MD4010LS	MD4010RS			41
KZ 750 M1 CSR		1982	FA68	FA68V	FA68HH				MD4066LS				42
KZ 750 N Spectre		1982-1983	FA68*	FA68V*	FA68HH*				MD4010LS	MD4010RS			43
KZ 750 R1 GPz		1982	FA68*		FA68HH*				MD4010LS	MD4010RS			44
VN 750 Vulcan		1986-2006	FA85*	FA85V	FA85HH*				MD4010LS	MD4010RS			45
Z 750 S ZR	Left	2005-2006	FA229	FA229V	FA229HH	EPFA229HH			MD4141X			MD4141XC*	46
	Right		FA231	FA231V	FA231HH	EPFA231HH				MD4141X			47
Z 750 ZR	Left	2004	FA229	FA229V	FA229HH	EPFA229HH			MD4141X			MD4141XC*	48
	Right		FA231	FA231V	FA231HH	EPFA231HH				MD4141X			49
ZR 750		1991-1993	FA129*	FA129V*	FA129HH*	EPFA129HH*			MD4008X	MD4008X		MD4008XC*	50
ZR 750 ZR-7	Left	2000-2001	FA229	FA229V	FA229HH	EPFA229HH			MD4141X			MD4141XC*	51
	Right		FA231	FA231V	FA231HH	EPFA231HH				MD4141X			52
ZR 750 ZR7-S	Left	2001-2005	FA229	FA229V	FA229HH	EPFA229HH			MD4141X			MD4141XC*	53
	Right		FA231	FA231V	FA231HH	EPFA231HH				MD4141X			54
ZX 750 GPz		1983-1985	FA85*		FA85HH*				MD4028	MD4028			55
ZX 750 Ninja		1987-1990	FA129*		FA129HH*	EPFA129HH*			MD4071LS	MD4071RS			56

*-2 Sets Required. † For Vee disc colours add RED, BLU, GRN, GLD, ORG suffix to part number. **SAFETY WARNING:- DO NOT USE HH PADS ON REAR UNLESS ALSO USED ON FRONT TO AVOID BRAKE IMBALANCE**

FRONT: KAWASAKI Cont'd

REAR: KAWASAKI

Line #	BRAKE ROTOR CHOICES - FRONT						DISC PAD CHOICES - REAR					BRAKE ROTOR CHOICES - REAR				
	CX Extreme® /Vee-Rotor	OSX Series Oversize 280mm Rotor Kit	Relocating Bracket for Oversize Rotor	SMX Series Oversize 320mm Rotor Kit	Relocating Bracket for 320mm Rotor	Front Disc Bolt Kit	FA/SFA/X Pad or Brake Shoe	Specialty Pads SXR/ VEE/MXS Race	Sintered/ HH Pads/ Grooved Shoes	EPFA Sintered Fast Road/ Track Pads	SV Series Severe Duty Pads	Standard Rotor	Vintage Rotor / UTV Oversize Brake Kit	Contour Profile Rotor	CX Extreme® /Vee-Rotor	Rear Disc Bolt Kit
1																
2																
3																
4																
5																
6																
7																
8																
9																
10																
11																
12																
13																
14																
15																
16																
17																
18																
19																
20																
21																
22																
23																
24																
25																
26																
27																
28																
29																
30																
31																
32																
33																
34																
35																
36								FA37								
37								FA68	FA68HH			MD4169				
38								FA68	FA68HH			MD4169				
39								709								
40								FA68	FA68HH			MD4169				
41								709								
42								FA68	FA68HH			MD4169				
43								709								
44								FA68	FA68HH			MD4169				
45								FA68	FA68HH			MD4169				
46								709								
47						DB404/5		FA192	FA192HH			MD4138	MD4138C		DB404/4	
48						DB404/5		FA192	FA192HH			MD4138	MD4138C		DB404/4	
49						DB404/5										
50	VR4008BLK*†					DB404/5		FA129	FA129HH	EPFA129HH		MD4007	MD4007C	VR4007		
51						DB404/5		FA231	FA231HH	EPFA231HH		MD4142	MD4142C			
52						DB404/5										
53						DB404/5		FA231	FA231HH	EPFA231HH		MD4142	MD4142C			
54						DB404/5										
55								FA85	FA85HH			MD4019				
56								FA129	FA129HH	EPFA129HH		MD4007	MD4007C			

BRAKE APPLICATIONS

* This symbol indicates a rotor made of billet steel, and should be only used with EBC FA Organic or Vee pads.
 SAFETY NOTICE - With vehicles primarily designed for off highway use such as quads now being used on the highway, we would recommend the use of X or MXS pads for highway use and ONLY using the R and SV higher density / harder pad series for off road riding.

*-2 Sets Required. † For Vee disc colours add RED, BLU, GRN, GLD, ORG suffix to part number. **SAFETY WARNING:- DO NOT USE HH PADS ON REAR UNLESS ALSO USED ON FRONT TO AVOID BRAKE IMBALANCE**

FRONT: KAWASAKI

APPLICATIONS

BRAKE



KAWASAKI



DISC PAD CHOICES - FRONT

BRAKE ROTOR CHOICES - FRONT

FRONT

Model	Year	FA/SFA/X Pad or Brake Shoe	Specialty Pads SXR/VEE/MXS Race	Sintered/HH Pads/Grooved Shoes	EPFA Sintered Fast Road/Track Pads	GPFA Sintered RACE ONLY Pads	SV Series Severe Duty Pads	Standard Rotor		Vintage Rotor / UTV Oversize Brake Kit	Contour Profile Rotor
								Standard Rotor Left	Standard Rotor Right		
ZX 750 Ninja ZX 7R	1991-1995	FA158*		FA158HH*	EPFA158HH*			MD4022X	MD4022X		MD4022XC*
ZX 750 Ninja ZX 7R	1996-2003	FA188*		FA188HH*	EPFA188HH*			MD4022X	MD4022X		MD4022XC*
ZX 750 Ninja ZX-7	1991-1995	FA158*		FA158HH*	EPFA158HH*			MD4022X	MD4022X		MD4022XC*
ZX 750 Turbo	1984-1985	FA85*		FA85HH*				MD4016	MD4016		
ZX 750 ZX-7 H	1989-1990	FA158*		FA158HH*	EPFA158HH*			MD4012X	MD4012X		MD4012XC*
ZX 750 ZX7RR ZX	1996-1999	FA424*		FA424HH*				MD4022X	MD4022X		MD4022XC*
KRF/KRT 800 Teryx	2014-2022	FA165X		FA165R			FA165SV	MD6399D		UTVX6399*	
		Right									
KRF/KRT 800 Teryx 4 Camo	2014-2022	FA165X		FA165R			FA165SV	MD6399D		UTVX6399*	
		Right									
KRF/KRT 800 Teryx 4 LE	2014-2022	FA165X		FA165R			FA165SV	MD6399D		UTVX6399*	
		Right									
KRF/KRT 800 Teryx 4 S LE	2014-2022	FA165X		FA165R			FA165SV	MD6399D		UTVX6399*	
		Right									
KRF/KRT 800 Teryx Camo	2014-2022	FA165X		FA165R			FA165SV	MD6399D		UTVX6399*	
		Right									
KRF/KRT 800 Teryx LE	2014-2022	FA165X		FA165R			FA165SV	MD6399D		UTVX6399*	
		Right									
KRF/KRT 800 Teryx S LE	2014-2022	FA165X		FA165R			FA165SV	MD6399D		UTVX6399*	
		Right									
KRF/KRT 800 Teryx4	2014-2022	FA165X		FA165R			FA165SV	MD6399D		UTVX6399*	
		Right									
KRF/KRT 800 Teryx4 S Camo	2014-2022	FA165X		FA165R			FA165SV	MD6399D		UTVX6399*	
		Right									
VN 800 Drifter	1999-2006	FA229	FA229V	FA229HH	EPFA229HH			MD4125LS			
VN 800 Vulcan	1995-2005	FA85	FA85V	FA85HH				MD4124LS			
VN 800 Vulcan Classic	1996-2005	FA229	FA229V	FA229HH	EPFA229HH			MD4125LS			
W 800 EJ	2011-2012	FA231	FA231V	FA231HH					MD4158		
W 800 EJ	2013-2016	FA231	FA231V	FA231HH				MD4008X			MD4008XC
W 800 EJ	2013-2016	FA231	FA231V	FA231HH				MD4008X			MD4008XC
W 800 EJ	2023	FA231	FA231V	FA231HH				MD4008X			MD4008XC
W 800 EJ Café	2011	FA231	FA231V	FA231HH				MD4008X			MD4008XC
W 800 EJ Special	2012	FA231	FA231V	FA231HH				MD4008X			MD4008XC
KAF 820 Mule PRO - FX	2016-2023	FA165X		FA165R			FA165SV	MD6398D		UTVX6398*	
		Right									
KAF 820 Mule PRO - FX/EPS	2016-2023	FA165X		FA165R			FA165SV	MD6398D		UTVX6398*	
		Right									
KAF 820 Mule PRO - FX/EPS Camo	2016-2023	FA165X		FA165R			FA165SV	MD6398D		UTVX6398*	
		Right									
KAF 820 Mule PRO - FX/EPS LE	2016-2023	FA165X		FA165R			FA165SV	MD6398D		UTVX6398*	
		Right									
KAF 820 Mule PRO - FXT	2015-2023	FA165X		FA165R			FA165SV	MD6398D		UTVX6398*	
		Right									
KAF 820 Mule PRO - FXT /EPS	2015-2023	FA165X		FA165R			FA165SV	MD6398D		UTVX6398*	
		Right									
KAF 820 Mule PRO - FXT /EPS Camo	2015-2023	FA165X		FA165R			FA165SV	MD6398D		UTVX6398*	
		Right									
KAF 820 Mule PRO - FXT /EPS LE	2015-2023	FA165X		FA165R			FA165SV	MD6398D		UTVX6398*	
		Right									
KAF 820 Mule PRO - FXT Ranch Edition	2016-2021	FA165X		FA165R			FA165SV	MD6398D		UTVX6398*	
		Right									
KZ 900 A4/A5	1976-1977	FA33						MD4052LS		VMD4052	
KZ 900 B1 LTD	1976	FA33*						MD4076LS	MD4076RS	VMD4076*	
VN 900 Vulcan Classic	2006-2023	FA229	FA229V	FA229HH	EPFA229HH			MD4158			
VN 900 Vulcan Classic LT	2006-2023	FA229	FA229V	FA229HH	EPFA229HH			MD4158			
VN 900 Vulcan Custom	2007-2023	FA229	FA229V	FA229HH	EPFA229HH			MD4158			

Line #

* This symbol indicates a rotor made of billet steel, and should be only used with EBC FA Organic or Vee pads.

SAFETY NOTICE - With vehicles primarily designed for off highway use such as quads now being used on the highway, we would recommend the use of X or MXS pads for highway use and ONLY using the R and SV higher density / harder pad series for off road riding.

*-2 Sets Required. † For Vee disc colours add RED, BLU, GRN, GLD, ORG suffix to part number. **SAFETY WARNING:- DO NOT USE HH PADS ON REAR UNLESS ALSO USED ON FRONT TO AVOID BRAKE IMBALANCE**

FRONT: KAWASAKI Cont'd

REAR: KAWASAKI

Line #	BRAKE ROTOR CHOICES - FRONT					DISC PAD CHOICES - REAR					BRAKE ROTOR CHOICES - REAR					
	CX Extreme® /Vee-Rotor	OSX Series Oversize 280mm Rotor Kit	Relocating Bracket for Oversize Rotor	SMX Series Oversize 320mm Rotor Kit	Relocating Bracket for 320mm Rotor	Front Disc Bolt Kit	FA/SFA/X Pad or Brake Shoe	Specialty Pads SXR/ VEE/MXS Race	Sintered/ HH Pads/ Grooved Shoes	EPFA Sintered Fast Road/ Track Pads	SV Series Severe Duty Pads	Standard Rotor	Vintage Rotor / UTV Oversize Brake Kit	Contour Profile Rotor	CX Extreme® /Vee-Rotor	Rear Disc Bolt Kit
1	VR4022BLK†					DB404/5	FA161		FA161HH			MD4013		MD4013C	VR4013	DB404/5
2	VR4022BLK†					DB404/5	FA161		FA161HH			MD4013		MD4013C	VR4013	DB404/5
3	VR4022BLK†					DB404/5	FA161		FA161HH			MD4013		MD4013C	VR4013	DB404/5
4							FA85		FA85HH			MD4017				
5	VR4012BLK†					DB404/5	FA161		FA161HH			MD4013		MD4013C	VR4013	DB404/5
6	VR4022BLK†					DB404/5			FA254HH			MD4013		MD4013C	VR4013	DB404/5
7																
8																
9																
10																
11																
12																
13																
14																
15																
16																
17																
18																
19																
20																
21																
22																
23																
24																
25						DB404/7	FA231		FA231HH	EPFA231HH		MD4148				
26							709									
27						DB404/7	709									
28							706									
29	VR4008BLK†					DB404/5	706									
30	VR4008BLK†					DB404/5	706									
31	VR4008BLK†					DB404/5	706									
32	VR4008BLK†					DB404/5	706									
33	VR4008BLK†					DB404/5	706									
34							FA686X*		FA686R*			MD6398D*	UTVX6398*			
35																
36							FA686X*		FA686R*			MD6398D*	UTVX6398*			
37																
38							FA686X*		FA686R*			MD6398D*	UTVX6398*			
39																
40							FA686X*		FA686R*			MD6398D*	UTVX6398*			
41																
42							FA686X*		FA686R*			MD6398D*	UTVX6398*			
43																
44							FA686X*		FA686R*			MD6398D*	UTVX6398*			
45																
46							FA686X*		FA686R*			MD6398D*	UTVX6398*			
47																
48							FA686X*		FA686R*			MD6398D*	UTVX6398*			
49																
50							FA686X*		FA686R*			MD6398D*	UTVX6398*			
51																
52							713									
53							FA37									
54									FA231HH	EPFA231HH		MD4085				
55									FA231HH	EPFA231HH		MD4085				
56									FA231HH	EPFA231HH		MD4085				

⚠ This symbol indicates a rotor made of billet steel, and should be only used with EBC FA Organic or Vee pads.
SAFETY NOTICE - With vehicles primarily designed for off highway use such as quads now being used on the highway, we would recommend the use of X or MXS pads for highway use and ONLY using the R and SV higher density / harder pad series for off road riding.

*-2 Sets Required. † For Vee disc colours add RED, BLU, GRN, GLD, ORG suffix to part number. **SAFETY WARNING:- DO NOT USE HH PADS ON REAR UNLESS ALSO USED ON FRONT TO AVOID BRAKE IMBALANCE**

FRONT: KAWASAKI

APPLICATIONS



KAWASAKI



SAFETY NOTICE - With vehicles primarily designed for off highway use such as quads now being used on the highway, we would recommend the use of X or MXS pads for highway use and ONLY using the R and SV higher density / harder pad series for off road riding.

⚠ This symbol indicates a rotor made of billet steel, and should be only used with EBC FA Organic or Vee pads.

			DISC PAD CHOICES - FRONT					BRAKE ROTOR CHOICES - FRONT				Line #	
			FA/SFA/X Pad or Brake Shoe	Specialty Pads SXR/VEE/MXS Race	Sintered/HH Pads/Grooved Shoes	EPFA Sintered Fast Road/Track Pads	GPFA Sintered RACE ONLY Pads	SV Series Severe Duty Pads	Standard Rotor Left	Standard Rotor Right	Vintage Rotor / UTV Oversize Brake Kit		Contour Profile Rotor
Z 900 ABS		2018-2023			FA347HH*	EPFA347HH*	GPFA347HH*						1
Z 900 SE ABS		2022-2023			FA347HH*	EPFA347HH*	GPFA347HH*						2
Z 900 Z1A/B		1973-1975		FA55				MD4069LS		VMD4069			3
Z 900 ZR 900		2017			FA347HH*	EPFA347HH*	GPFA347HH*						4
Z 900 ZR 900 BHF/ABS		2017			FA347HH*	EPFA347HH*	GPFA347HH*						5
Z900 RS		2018-2023			FA347HH*	EPFA347HH*	GPFA347HH*						6
Z900 RS Café		2018-2023			FA347HH*	EPFA347HH*	GPFA347HH*						7
ZL 900 Eliminator		1985-1986		FA85*	FA85V*	FA85HH*		MD4016	MD4016				8
ZX 900 Ninja A		1984-1986		FA85*		FA85HH*		MD4016	MD4016				9
ZX-9R Ninja B		1994-1995		FA158*		FA158HH*	EPFA158HH*	MD4022X	MD4022X		MD4022XC*		10
ZX-9R Ninja B3/4		1996-1997		FA188*		FA188HH*	EPFA188HH*	MD4022X	MD4022X		MD4022XC*		11
ZX-9R ZX 900 C		1998-1999		FA188*		FA188HH*	EPFA188HH*	MD4167X	MD4167X		MD4167XC*		12
ZX-9R ZX 900 E1/E2		2000-2001		FA188*		FA188HH*	EPFA188HH*	MD4012X	MD4012X		MD4012XC*		13
ZX-9R ZX 900 F1/F2		2002-2003				FA347HH*	EPFA347HH*	MD4022X	MD4022X		MD4022XC*		14
KAF 950 Mule 3010 Diesel		2003-2005		719*									15
KAF 950 Mule 3010 Diesel 4x4		2008		719*									16
KAF 950 Mule 3010 Trans 4x4 Diesel		2008		719*									17
KAF 950 Mule 4010 Diesel 4x4		2009-2012		719*									18
KAF 950 Mule 4010 Trans 4x4 Diesel		2009-2012		719*									19
KAF 950 Mule 4010 Trans 4x4 Diesel Realtree		2010		719*									20
H1 500 Mach III		1969-1970											21
H1 A 500 S Mach III		1971											22
H1 B 500 Mach III		1972											23
H1 C 500 Mach III		1972											24
H1 D 500		1973		FA55				MD4069LS		VMD4069			25
H1 E 500		1974		FA55				MD4069LS		VMD4069			26
H1 F 500		1975		FA55				MD4069LS		VMD4069			27
KAF 1000 Mule Pro DX /Diesel	Left	2016-2017	FA165X		FA165R		FA165SV	MD6398D		UTVX6398*			28
	Right		FA135X		FA135R		FA135SV		MD6398D				29
KAF 1000 Mule Pro DX EPS LE/Diesel	Left	2016-2017	FA165X		FA165R		FA165SV	MD6398D		UTVX6398*			30
	Right		FA135X		FA135R		FA135SV		MD6398D				31
KAF 1000 Mule Pro DX EPS/Diesel	Left	2016-2021	FA165X		FA165R		FA165SV	MD6398D		UTVX6398*			32
	Right		FA135X		FA135R		FA135SV		MD6398D				33
KAF 1000 Mule Pro DXT EPS LE/Diesel	Left	2016-2021	FA165X		FA165R		FA165SV	MD6398D		UTVX6398*			34
	Right		FA135X		FA135R		FA135SV		MD6398D				35
KAF 1000 Mule Pro DXT/ Diesel	Left	2016-2017	FA165X		FA165R		FA165SV	MD6398D		UTVX6398*			36
	Right		FA135X		FA135R		FA135SV		MD6398D				37
KAF 1000 Mule Pro DXT/Diesel EPS	Left	2016-2017	FA165X		FA165R		FA165SV	MD6398D		UTVX6398*			38
	Right		FA135X		FA135R		FA135SV		MD6398D				39
KAF 1000 Mule Pro-FX	Left	2024	FA165X		FA165R		FA165SV	MD6398D		UTVX6398*			40
	Right		FA135X		FA135R		FA135SV		MD6398D				41
KAF 1000 Mule Pro-FXR	Left	2024	FA165X		FA165R		FA165SV	MD6398D		UTVX6398*			42
	Right		FA135X		FA135R		FA135SV		MD6398D				43
KAF 1000 Mule Pro-FXT	Left	2024	FA165X		FA165R		FA165SV	MD6398D		UTVX6398*			44
	Right		FA135X		FA135R		FA135SV		MD6398D				45
KLZ 1000 Versys SE		2019-2021			FA379HH*	EPFA379HH*		MD4155X	MD4155X		MD4155XC*		46
KLZ 1000 Versys		2015-2017		FA158*	FA158HH*	EPFA158HH*							47
KLZ 1000 Versys		2018-2021		FA158*	FA158HH*	EPFA158HH*		MD4155X	MD4155X		MD4155XC*		48
KLZ 1000 Versys SE		2018-2023		FA158*	FA158HH*	EPFA158HH*		MD4155X	MD4155X		MD4155XC*		49
KRX 1000 Teryx		2020-2024		SXR738HH*	FA738R*		FA738SV*	MD6434D	MD6434D				50
KRX 1000 Teryx 1000 2 Seat		2020-2021		SXR738HH*	FA738R*		FA738SV*	MD6434D	MD6434D				51
KRX 1000 Teryx 1000 2 Seat Camo		2020-2021		SXR738HH*	FA738R*		FA738SV*	MD6434D	MD6434D				52
KRX 1000 Teryx 1000 2 Seat LE		2020-2021		SXR738HH*	FA738R*		FA738SV*	MD6434D	MD6434D				53
KRX 1000 Teryx eS		2020-2024		SXR738HH*	FA738R*		FA738SV*	MD6434D	MD6434D				54
KRX 1000 Teryx Special Edition		2020-2024		SXR738HH*	FA738R*		FA738SV*	MD6434D	MD6434D				55
KRX 1000 Teryx Trail Edition		2020-2024		SXR738HH*	FA738R*		FA738SV*	MD6434D	MD6434D				56

*-2 Sets Required. † For Vee disc colours add RED, BLU, GRN, GLD, ORG suffix to part number. **SAFETY WARNING:- DO NOT USE HH PADS ON REAR UNLESS ALSO USED ON FRONT TO AVOID BRAKE IMBALANCE**

FRONT: KAWASAKI Cont'd

REAR: KAWASAKI

Line #	BRAKE ROTOR CHOICES - FRONT					Front Disc Bolt Kit	DISC PAD CHOICES - REAR					BRAKE ROTOR CHOICES - REAR				
	CX Extreme® /Vee-Rotor	OSX Series Oversize 280mm Rotor Kit	Relocating Bracket for Oversize Rotor	SMX Series Oversize 320mm Rotor Kit	Relocating Bracket for 320mm Rotor		FA/SFA/X Pad or Brake Shoe	Specialty Pads SXR/ VEE/MXS Race	Sintered/ HH Pads/ Grooved Shoes	EPFA Sintered Fast Road/ Track Pads	SV Series Severe Duty Pads	Standard Rotor	Vintage Rotor / UTV Oversize Brake Kit	Contour Profile Rotor	CX Extreme® /Vee-Rotor	Rear Disc Bolt Kit
1							FA174		FA174HH			MD4157			DB404/4	
2							FA174		FA174HH			MD4157			DB404/4	
3							713									
4							FA140		FA140HH							
5							FA140		FA140HH							
6							FA174		FA174HH			MD4157			DB404/4	
7							FA174		FA174HH			MD4157			DB404/4	
8							FA85		FA85HH			MD4017				
9							FA85		FA85HH			MD4017				
10	VR4022BLK*†					DB404/5	FA192		FA192HH			MD4013	MD4013C	VR4013	DB404/5	
11	VR4022BLK*†					DB404/5	FA192		FA192HH			MD4013	MD4013C	VR4013	DB404/5	
12						DB404/5	FA192		FA192HH			MD4138	MD4138C	VR4138	DB404/4	
13	VR4012BLK*†					DB404/5	FA192		FA192HH			MD4138	MD4138C	VR4138	DB404/4	
14	VR4022BLK*†					DB404/5	FA192		FA192HH			MD4138	MD4138C	VR4138	DB404/4	
15							720*									
16							720*									
17							720*									
18							720*									
19							720*									
20							720*									
21																
22																
23																
24																
25							710									
26							710									
27							710									
28							FA686X*		FA686R*			MD6398D*	UTVX6398*			
29							FA686X*		FA686R*			MD6398D*	UTVX6398*			
30							FA686X*		FA686R*			MD6398D*	UTVX6398*			
31							FA686X*		FA686R*			MD6398D*	UTVX6398*			
32							FA686X*		FA686R*			MD6398D*	UTVX6398*			
33							FA686X*		FA686R*			MD6398D*	UTVX6398*			
34							FA686X*		FA686R*			MD6398D*	UTVX6398*			
35							FA686X*		FA686R*			MD6398D*	UTVX6398*			
36							FA686X*		FA686R*			MD6398D*	UTVX6398*			
37							FA686X*		FA686R*			MD6398D*	UTVX6398*			
38							FA686X*		FA686R*			MD6398D*	UTVX6398*			
39							FA686X*		FA686R*			MD6398D*	UTVX6398*			
40							FA686X*		FA686R*			MD6398D*	UTVX6398*			
41							FA686X*		FA686R*			MD6398D*	UTVX6398*			
42							FA686X*		FA686R*			MD6398D*	UTVX6398*			
43							FA686X*		FA686R*			MD6398D*	UTVX6398*			
44							FA686X*		FA686R*			MD6398D*	UTVX6398*			
45																
46	VR4155BLK*†					DB404/5	FA174		FA174HH				MD4157C			
47							FA174		FA174HH							
48	VR4155BLK*†					DB404/5	FA174		FA174HH				MD4157C			
49	VR4155BLK*†					DB404/5	FA174		FA174HH				MD4157C			
50									FA739R*		FA739SV*	MD6434D*				
51									FA739R*		FA739SV*	MD6434D*				
52									FA739R*		FA739SV*	MD6434D*				
53									FA739R*		FA739SV*	MD6434D*				
54									FA739R*		FA739SV*	MD6434D*				
55									FA739R*		FA739SV*	MD6434D*				
56									FA739R*		FA739SV*	MD6434D*				

BRAKE APPLICATIONS
 * This symbol indicates a rotor made of billet steel, and should be only used with EBC FA Organic or Vee pads.
 SAFETY NOTICE - With vehicles primarily designed for off highway use such as quads now being used on the highway, we would recommend the use of X or MXS pads for highway use and ONLY using the R and SV higher density / harder pad series for off road riding.

*-2 Sets Required. † For Vee disc colours add RED, BLU, GRN, GLD, ORG suffix to part number. **SAFETY WARNING:- DO NOT USE HH PADS ON REAR UNLESS ALSO USED ON FRONT TO AVOID BRAKE IMBALANCE**

FRONT: KAWASAKI



KAWASAKI



DISC PAD CHOICES - FRONT

BRAKE ROTOR CHOICES - FRONT

FA/SFA/X Pad or Brake Shoe	Specialty Pads SXR/VEE/MXS Race	Sintered/HH Pads/ Grooved Shoes	EPFA Sintered Fast Road/Track Pads	GPFX Sintered RACE ONLY Pads	SV Series Severe Duty Pads	Standard Rotor Left	Standard Rotor Right	Vintage Rotor / UTV Oversize Brake Kit	Contour Profile Rotor
	SXR738HH*	FA738R*			FA738SV*	MD6434D	MD6434D		
	SXR738HH*	FA738R*			FA738SV*	MD6434D	MD6434D		
	SXR738HH*	FA738R*			FA738SV*	MD6434D	MD6434D		
	SXR738HH*	FA738R*			FA738SV*	MD6434D	MD6434D		
	SXR738HH*	FA738R*			FA738SV*	MD6434D	MD6434D		
FA33						MD4052LS		VMD4052	
FA73*						MD4064LS	MD4064RS	VMD4064*	
FA33*						MD4076LS	MD4076RS	VMD4076*	
FA73*						MD4064LS	MD4064RS	VMD4064*	
FA73*						MD4064LS	MD4064RS	VMD4064*	
FA33*						MD4076LS	MD4076RS	VMD4076*	
FA33*						MD4076LS	MD4076RS	VMD4076*	
FA73*						MD4076LS	MD4076RS	VMD4076*	
FA62*						MD4078LS	MD4078RS	VMD4078*	
FA73*						MD4064LS	MD4064RS	VMD4064*	
FA68*		FA68HH*				MD4006LS	MD4006RS		
FA68*		FA68HH*				MD4038	MD4038		
FA68*	FA68V*	FA68HH*				MD4006LS	MD4006RS		
FA68*	FA68V*	FA68HH*				MD4080LS	MD4080RS	VMD4080*	
FA68*		FA68HH*				MD4091	MD4091		
FA229		FA229HH	EPFA229HH			MD4091			
FA231		FA231HH	EPFA231HH				MD4091		
FA229		FA229HH	EPFA229HH			MD4091			
FA231		FA231HH	EPFA231HH				MD4091		
FA68*		FA68HH*				MD4038	MD4038		
		FA379HH*	EPFA379HH*						
		FA447HH*	EPFA447HH*	GPFX447HH*					
		FA447HH*	EPFA447HH*	GPFX447HH*					
		FA379HH*	EPFA379HH*						
		FA447HH*	EPFA447HH*						
		FA379HH*	EPFA379HH*						
		FA447HH*	EPFA447HH*	GPFX447HH*					
711									
		FA379HH*	EPFA379HH*						
		FA379HH*	EPFA379HH*			MD4155X	MD4155X	MD4155XC*	
		FA347HH*	EPFA347HH*			MD4154X	MD4154X	MD4154XC*	
		FA347HH*	EPFA347HH*			MD4154X	MD4154X	MD4154XC*	
		FA417/4HH*	EPFA417/4HH*	GPFX417/4HH*				MD4152XC*	
		FA417/4HH*	EPFA417/4HH*	GPFX417/4HH*				MD4152XC*	
		FA630HH*	EPFA630HH*			MD4170X	MD4170X		
		FA447HH*	EPFA447HH*			MD4170X	MD4170X		
		FA447HH*	EPFA447HH*			MD4170X	MD4170X		
FA85*		FA85HH*				MD4028			
							MD4028		
FA129*	FA129V*	FA129HH*	EPFA129HH*			MD4008X	MD4008X	MD4008XC*	
FA129*	FA129V*	FA129HH*	EPFA129HH*			MD4008X	MD4008X	MD4008XC*	
FA85*	FA85V*	FA85HH*				MD4016	MD4016		
FA85*		FA85HH*				MD4016	MD4016		
		FA379HH*	EPFA379HH*	GPFX379HH*				MD4161XC*	
		FA379HH*	EPFA379HH*	GPFX379HH*				MD4161XC*	
		FA447HH*	EPFA447HH*	GPFX447HH*		MD4170X	MD4170X		
		FA447HH*	EPFA447HH*	GPFX447HH*		MD4170X	MD4170X		
		FA447HH*	EPFA447HH*	GPFX447HH*		MD4170X	MD4170X		
		FA447HH*	EPFA447HH*	GPFX447HH*		MD4170X	MD4170X		
FA129*		FA129HH*	EPFA129HH*			MD4021	MD4021		
		FA369/4HH*	EPFA369/4HH*					MD4152XC*	

FRONT

Line #

BRAKE APPLICATIONS

* This symbol indicates a rotor made of billet steel, and should be only used with EBC FA Organic or Vee pads.
 SAFETY NOTICE - With vehicles primarily designed for off highway use such as quads now being used on the highway, we would recommend the use of X or MXS pads for highway use and ONLY using the R and SV higher density / harder pad series for off road riding.

*-2 Sets Required. † For Vee disc colours add RED, BLU, GRN, GLD, ORG suffix to part number. **SAFETY WARNING:- DO NOT USE HH PADS ON REAR UNLESS ALSO USED ON FRONT TO AVOID BRAKE IMBALANCE**

FRONT: KAWASAKI Cont'd

REAR: KAWASAKI

Line #	BRAKE ROTOR CHOICES - FRONT					Front Disc Bolt Kit	DISC PAD CHOICES - REAR					BRAKE ROTOR CHOICES - REAR				
	CX Extreme® /Vee-Rotor	OSX Series Oversize 280mm Rotor Kit	Relocating Bracket for Oversize Rotor	SMX Series Oversize 320mm Rotor Kit	Relocating Bracket for 320mm Rotor		FA/SFA/X Pad or Brake Shoe	Specialty Pads SXR/ VEE/MXS Race	Sintered/ HH Pads/ Grooved Shoes	EPFA Sintered Fast Road/ Track Pads	SV Series Severe Duty Pads	Standard Rotor	Vintage Rotor / UTV Oversize Brake Kit	Contour Profile Rotor	CX Extreme® /Vee-Rotor	Rear Disc Bolt Kit
1																
2																
3																
4																
5																
6																
7						DB404/5	FA36					MD4077	VMD4077			
8							FA36									
9						DB404/5	FA37									
10						DB404/5	FA36				MD4063	VMD4063				
11							FA36				MD4077	VMD4077				
12							FA36				MD4077	VMD4077				
13							FA36				MD4077	VMD4077				
14							FA36				MD4077	VMD4077				
15						DB404/5	FA36				MD4090					
16							FA36				MD4063	VMD4063				
17							FA68	FA68HH			MD4054					
18							FA68	FA68HH			MD4054					
19							FA68	FA68HH			MD4054					
20							FA68	FA68HH			MD4054					
21							FA68	FA68HH			MD4054					
22								FA231HH	EPFA231HH		MD4054					
23								FA231HH	EPFA231HH		MD4054					
24																
25							FA68	FA68HH			MD4054					
26								FA192HH								
27							FA266	FA266HH								
28							FA266	FA266HH								
29							FA228	FA228HH								
30							FA228	FA228HH								
31							FA228	FA228HH								
32							FA228	FA228HH								
33							FA266	FA266HH								
34							708									
35	VR4155BLK*†					DB404/5	FA174	FA192HH				MD4157C	VR4157			
36	VR4154BLK*†						FA174	FA192HH				MD4157C	VR4157			
37	VR4154BLK*†						FA192	FA192HH			MD4138	MD4138C	VR4138	DB404/4		
38	VR4152BLK*†					DB404/5	FA192	FA192HH			MD4138	MD4138C	VR4138	DB404/4		
39	VR4152BLK*†					DB404/5	FA174	FA174HH				MD4157C	VR4157			
40						DB404/5	FA174	FA174HH				MD4157C	VR4157			
41						DB404/5	FA266	FA266HH								
42						DB404/5	FA266	FA266HH			MD4182					
43							FA266	FA266HH								
44							FA85	FA85HH			MD4082					
45	VR4008BLK*†					DB404/5	FA192									
46	VR4008BLK*†					DB404/5	FA85	FA85HH			MD4082					
47							FA85	FA85HH			MD4082					
48							FA85	FA85HH			MD4017					
49	VR4161BLK*†						FA85	FA85HH			MD4019					
50	VR4161BLK*†						FA436	FA436HH				MD4165C	VR4165			
51						DB404/5	FA436	FA436HH				MD4165C	VR4165			
52						DB404/5	FA436	FA436HH			MD4165	MD4165C	VR4165	DB404/4		
53						DB404/5	FA436	FA436HH			MD4165	MD4165C	VR4165	DB404/4		
54							FA436	FA436HH				MD4165C	VR4165	DB404/4		
55							FA436	FA436HH				MD4157C	VR4157			
56	VR4152BLK*†					DB404/5	FA129	FA129HH	EPFA129HH		MD4015					
							FA129	FA129HH				MD4138C	VR4138	DB404/4		

⊗ This symbol indicates a rotor made of billet steel, and should be only used with EBC FA Organic or Vee pads.
 SAFETY NOTICE - With vehicles primarily designed for off highway use such as quads now being used on the highway, we would recommend the use of X or MXS pads for highway use and ONLY using the R and SV higher density / harder pad series for off road riding.

*-2 Sets Required. † For Vee disc colours add RED, BLU, GRN, GLD, ORG suffix to part number. **SAFETY WARNING:- DO NOT USE HH PADS ON REAR UNLESS ALSO USED ON FRONT TO AVOID BRAKE IMBALANCE**

FRONT: KAWASAKI

APPLICATIONS

⊛ This symbol indicates a rotor made of billet steel, and should be only used with EBC FA Organic or Vee pads.

SAFETY NOTICE - With vehicles primarily designed for off highway use such as quads now being used on the highway, we would recommend the use of X or MXS pads for highway use and ONLY using the R and SV higher density / harder pad series for off road riding.



KAWASAKI



ZX10 R Ninja ZX 1000 E/F		2008-2010
ZX10 R Ninja ZX 1000 J		2011-2015
ZX10 R Ninja ZX 1000 K		2011-2015
ZX10 R Ninja ZX 1002 EKF/FKF		2020-2024
ZX10 RR Ninja ZX 1000 ZHF/ZJF		2017-2018
ZX10 RR Ninja ZX 1002 GKF		2020-2024
KZ 1100 A		1981-1983
KZ 1100 D Spectre		1982-1983
KZ 1100 GPz		1981
KZ 1100 GPz		1982
KZ 1100 LTD		1983
ZN 1100 B LTD		1984-1985
ZR 1100 Zephyr		1992-1995
ZR 1100 Zephyr	Left	1996
	Right	
ZRX 1100 ZR 1100 C		1999-2000
ZX 1100 GPz		1983-1984
ZX 1100 GPz ZX	Left	1995-1997
	Right	
ZX 1100 GPz ZX F1	Left	1996-1997
	Right	
ZX 1100 ZX11 Ninja		1990-1993
ZX 1100 ZX-11 Ninja		1993-2001
ZG 1200 Voyager XII		1986-2003
ZRX 1200 R ZR 1200 A		2001-2005
ZX 1200 ZX12 R ZX A/B		2000-2003
ZX 1200 ZX12 R ZX B		2004-2005
ZX 1200 ZZR C		2002-2005
KZ 1300 A		1979-1982
KZ 1300 B2 Touring		1980
ZN 1300 A Voyager		1983-1988
ZG 1400 Concours 14 ZG		2008-2021
ZG 1400 Concours 14 ZG		2008-2010
ZX 14 R Performance Inc SE		2012-2022
ZX 1400 R		2006-2007
ZX 1400 R		2006-2007
ZX 1400 R		2008-2011
ZX 1400 R		2012-2023
ZX 1400 R Performance Sport		2014-2022
VN 1500		1996-1997
VN 1500 A Vulcan 88		1987-1999
VN 1500 B Vulcan 88 SE		1987-1990
VN 1500 Drifter		1999-2005
VN 1500 G3 Nomad	Left	2001
	Right	
VN 1500 Nomad	Left	1999-2000
	Right	
VN 1500 Vulcan 1500 Classic		2005-2006
VN 1500 Vulcan 1500 Classic		2007-2008
VN 1500 Vulcan 1500 Classic Fi		2000-2002
VN 1500 Vulcan 1500 Nomad F1	Left	2001-2005
	Right	
VN 1500 Vulcan Classic		2001-2004
VN 1500 Vulcan Classic		1996-2000
VN 1500 Vulcan Mean Streak		2002-2003
VN 1600 B1 Mean Streak		2004

		DISC PAD CHOICES - FRONT						BRAKE ROTOR CHOICES - FRONT				
FA/SFA/X Pad or Brake Shoe	Specialty Pads SXR/VEE/MXS Race	Sintered/HH Pads/Grooved Shoes	EPFA Sintered Fast Road/Track Pads	GPFA Sintered RACE ONLY Pads	SV Series Severe Duty Pads	Standard Rotor Left	Standard Rotor Right	Vintage Rotor / UTV Oversize Brake Kit	Contour Profile Rotor	Line #		
		FA379HH*	EPFA379HH*	GPFA379HH*					MD4161XC*	1		
		FA379HH*	EPFA379HH*	GPFA379HH*					MD4161XC*	2		
		FA379HH*	EPFA379HH*	GPFA379HH*					MD4161XC*	3		
		FA447HH*	EPFA447HH*	GPFA447HH*		MD4170X	MD4170X			4		
		FA447HH*	EPFA447HH*	GPFA447HH*		MD4175X	MD4175X			5		
		FA447HH*	EPFA447HH*	GPFA447HH*		MD4175X	MD4175X			6		
FA68*	FA68V*	FA68HH*				MD4006LS	MD4006RS			7		
FA68*	FA68V*	FA68HH*				MD4006LS	MD4006RS			8		
FA68*		FA68HH*				MD4006LS	MD4006RS			9		
FA68*		FA68HH*				MD4038	MD4038			10		
FA68*	FA68V*	FA68HH*				MD4006LS	MD4006RS			11		
FA85*	FA85V*	FA85HH*				MD4084	MD4084			12		
FA158*		FA158HH*	EPFA158HH*			MD4012X	MD4012X		MD4012XC*	13		
FA229		FA229HH	EPFA229HH			MD4012X			MD4012XC*	14		
FA231		FA231HH	EPFA231HH				MD4012X			15		
FA188*		FA188HH*	EPFA188HH*			MD4012X	MD4012X		MD4012XC*	16		
FA85*		FA85HH*				MD4016	MD4016			17		
FA229		FA229HH	EPFA229HH			MD4008X			MD4008XC	18		
FA231		FA231HH	EPFA231HH				MD4008X		MD4008C	19		
FA229		FA229HH	EPFA229HH			MD4008X			MD4008XC	20		
FA231		FA231HH	EPFA231HH				MD4132X		MD4132XC	21		
FA158*		FA158HH*	EPFA158HH*			MD4012X	MD4012X		MD4012XC*	22		
FA158*		FA158HH*	EPFA158HH*			MD4022X	MD4022X		MD4022XC*	23		
FA85*		FA85HH*				MD4087	MD4087			24		
FA188*		FA188HH*	EPFA188HH*			MD4012X	MD4012X		MD4012XC*	25		
FA188*		FA188HH*	EPFA188HH*			MD4022X	MD4022X		MD4022XC*	26		
		FA369/4HH*	EPFA369/4HH*			MD4154X	MD4154X		MD4154XC*	27		
FA158*		FA158HH*	EPFA158HH*			MD4022X	MD4022X		MD4022XC*	28		
FA62*						MD4089LS	MD4089RS	VMD4089*		29		
FA62*						MD4089LS	MD4089RS	VMD4089*		30		
FA85*		FA85HH*				MD4091	MD4091			31		
		FA417/4HH*	EPFA417/4HH*			MD4155X	MD4155X		MD4155XC*	32		
		FA417/4HH*	EPFA417/4HH*			MD4155X	MD4155X		MD4155XC*	33		
		FA447HH*	EPFA447HH*			MD4155X	MD4155X		MD4155XC*	34		
		FA417/4HH*	EPFA417/4HH*			MD4155X	MD4155X		MD4155XC*	35		
		FA417/4HH*	EPFA417/4HH*			MD4155X	MD4155X		MD4155XC*	36		
		FA417/4HH*	EPFA417/4HH*			MD4155X	MD4155X		MD4155XC*	37		
		FA417/4HH*	EPFA417/4HH*			MD4155X	MD4155X		MD4155XC*	38		
		FA447HH*	EPFA447HH*			MD4155X	MD4155X		MD4155XC*	39		
FA85	FA85V	FA85HH				MD4124LS				40		
FA85	FA85V	FA85HH				MD4124LS				41		
FA85	FA85V	FA85HH				MD4094LS				42		
FA229	FA229V	FA229HH	EPFA229HH			MD4125LS				43		
FA229	FA229V	FA229HH	EPFA229HH			MD4150				44		
FA231	FA231V	FA231HH	EPFA231HH				MD4150			45		
FA229	FA229V	FA229HH	EPFA229HH			MD4150				46		
FA231	FA231V	FA231HH	EPFA231HH				MD4150			47		
FA229	FA229V	FA229HH	EPFA229HH			MD4125LS				48		
FA229	FA229V	FA229HH	EPFA229HH			MD4125LS				49		
FA229	FA229V	FA229HH	EPFA229HH			MD4125LS				50		
FA229	FA229V	FA229HH	EPFA229HH			MD4150				51		
FA231	FA231V	FA231HH	EPFA231HH				MD4150			52		
FA229	FA229V	FA229HH	EPFA229HH			MD4125LS				53		
FA229	FA229V	FA229HH	EPFA229HH			MD4125LS				54		
FA188*		FA188HH*	EPFA188HH*			MD4022X	MD4022X		MD4022XC*	55		
FA188*		FA188HH*	EPFA188HH*			MD4022X	MD4022X		MD4022XC*	56		

*-2 Sets Required. † For Vee disc colours add RED, BLU, GRN, GLD, ORG suffix to part number. **SAFETY WARNING:- DO NOT USE HH PADS ON REAR UNLESS ALSO USED ON FRONT TO AVOID BRAKE IMBALANCE**

FRONT: KAWASAKI Cont'd

REAR: KAWASAKI

Line #	BRAKE ROTOR CHOICES - FRONT					DISC PAD CHOICES - REAR					BRAKE ROTOR CHOICES - REAR				
	CX Extreme® /Vee-Rotor	OSX Series Oversize 280mm Rotor Kit	Relocating Bracket for Oversize Rotor	SMX Series Oversize 320mm Rotor Kit	Relocating Bracket for 320mm Rotor	Front Disc Bolt Kit	FA/SFA/X Pad or Brake Shoe	Specialty Pads SXR/VEE/MXS Race	Sintered/HH Pads/ Grooved Shoes	EPFA Sintered Fast Road/ Track Pads	SV Series Severe Duty Pads	Standard Rotor	Vintage Rotor / UTV Oversize Brake Kit	Contour Profile Rotor	CX Extreme® /Vee-Rotor
1	VR4161BLK*†						FA129		FA129HH				MD4138C	VR4138	DB404/4
2	VR4161BLK*†						FA436		FA436HH				MD4165C	VR4165	
3	VR4161BLK*†						FA436		FA436HH				MD4165C	VR4165	
4						DB404/5	FA436		FA436HH			MD4165	MD4165C	VR4165	DB404/4
5						DB404/5	FA436		FA436HH			MD4165	MD4165C	VR4165	DB404/4
6						DB404/5	FA436		FA436HH			MD4165	MD4165C	VR4165	DB404/4
7							FA68		FA68HH			MD4054			
8							FA68		FA68HH			MD4054			
9							FA68		FA68HH			MD4054			
10							FA68		FA68HH			MD4054			
11							FA68		FA68HH			MD4054			
12							FA85		FA85HH			MD4085			
13	VR4012BLK*†					DB404/5	FA129		FA129HH	EPFA129HH		MD4027	MD4027C	VR4027	
14	VR4012BLK*†						FA129		FA129HH	EPFA129HH		MD4027	MD4027C	VR4027	
15						DB404/5									
16	VR4012BLK*†					DB404/5	FA161		FA161HH			MD4133	MD4133C	VR4133	
17							FA85					MD4017			
18						DB404/5	FA192		FA192HH			MD4130	MD4130C	VR4130	
19						DB404/5									
20							FA192		FA192HH			MD4130	MD4130C	VR4130	
21															
22	VR4012BLK*†					DB404/5	FA129		FA129HH	EPFA129HH		MD4015	MD4015C	VR4015	
23	VR4022BLK*†					DB404/5	FA161		FA161HH			MD4014	MD4014C	VR4014	
24							FA85		FA85HH			MD4088			
25	VR4012BLK*†					DB404/5	FA161		FA161HH			MD4133	MD4133C	VR4133	
26	VR4022BLK*†					DB404/5	FA161		FA161HH			MD4023	MD4023C	VR4023	
27	VR4154BLK*†					DB404/5	FA161		FA161HH			MD4023	MD4023C	VR4023	
28	VR4022BLK*†					DB404/5	FA161		FA161HH			MD4133	MD4133C	VR4133	
29							FA36					MD4090			
30							FA36					MD4090			
31							FA85		FA85HH			MD4092			
32						DB404/5			FA254HH				MD4160C		
33						DB404/5			FA254HH				MD4160C		
34						DB404/5			FA254HH				MD4157C		
35						DB404/5			FA254HH				MD4157C		
36						DB404/5			FA254HH				MD4157C		
37						DB404/5			FA254HH				MD4157C		
38						DB404/5			FA254HH				MD4157C		
39						DB404/5			FA254HH				MD4157C		
40							FA85		FA85HH			MD4128			
41							FA85		FA85HH			MD4054			
42							FA85		FA85HH			MD4054			
43						DB404/7	FA231		FA231HH	EPFA231HH		MD4148			
44												MD4147			
45															
46							FA85		FA85HH			MD4147			
47															
48						DB404/7						MD4148			
49						DB404/7						MD4148			
50						DB404/7						MD4148			
51												MD4147			
52															
53						DB404/7	FA231		FA231HH	EPFA231HH		MD4148			
54						DB404/7	FA85		FA85HH			MD4128			
55	VR4022BLK*†					DB404/5						MD4146			
56	VR4022BLK*†					DB404/5						MD4146			

⚠ This symbol indicates a rotor made of billet steel, and should be only used with EBC FA Organic or Vee pads.
SAFETY NOTICE - With vehicles primarily designed for off highway use such as quads now being used on the highway, we would recommend the use of X or MXS pads for highway use and ONLY using the R and SV higher density / harder pad series for off road riding.

*-2 Sets Required. † For Vee disc colours add RED, BLU, GRN, GLD, ORG suffix to part number. **SAFETY WARNING:- DO NOT USE HH PADS ON REAR UNLESS ALSO USED ON FRONT TO AVOID BRAKE IMBALANCE**

FRONT: KAWASAKI

APPLICATIONS



KAWASAKI



DISC PAD CHOICES - FRONT

BRAKE ROTOR CHOICES - FRONT

Model	Side	Year	DISC PAD CHOICES - FRONT					BRAKE ROTOR CHOICES - FRONT				Line #	
			FA/SFA/X Pad or Brake Shoe	Specialty Pads SXR/VEE/MXS Race	Sintered/HH Pads/Grooved Shoes	EPFA Sintered Fast Road/Track Pads	GPFAX Sintered RACE ONLY Pads	SV Series Severe Duty Pads	Standard Rotor Left	Standard Rotor Right	Vintage Rotor / UTV Oversize Brake Kit		Contour Profile Rotor
VN 1600 D1/D6F	Left	2005-2006	FA229	FA229V	FA229HH	EPFA229HH				MD4158			1
	Right		FA231	FA231V	FA231HH	EPFA231HH					MD4158		2
VN 1600 Mean Streak		2005-2006			FA369/4HH*	EPFA369/4HH*				MD4022X	MD4022X		3
VN 1600 Mean Streak		2007-2008			FA369/4HH*	EPFA369/4HH*				MD4022X	MD4022X		4
VN 1600 Nomad	Left	2007-2008	FA229	FA229V	FA229HH	EPFA229HH				MD4158			5
	Right		FA231	FA231V	FA231HH	EPFA231HH					MD4158		6
VN 1600 Vulcan Classic	Left	2001-2006	FA229	FA229V	FA229HH	EPFA229HH				MD4158			7
	Right		FA231	FA231V	FA231HH	EPFA231HH					MD4158		8
VN 1600 Vulcan Classic	Left	2003-2008	FA229	FA229V	FA229HH	EPFA229HH				MD4158			9
	Right		FA231	FA231V	FA231HH	EPFA231HH					MD4158		10
VN 1700 KEFA Vulcan Vaquero SE		2014	FA158*		FA158HH*	EPFA158HH*							11
VN 1700 Voyager Nomad		2014	FA158*		FA158HH*	EPFA158HH*							12
VN 1700 Voyager Vaquero		2011-2013	FA158*		FA158HH*	EPFA158HH*							13
VN 1700 Vulcan 1700 Classic	Left	2009-2011	FA229	FA229V	FA229HH	EPFA229HH				MD4158			14
	Right		FA231	FA231V	FA231HH	EPFA231HH					MD4158		15
VN 1700 Vulcan 1700 Classic LT	Left	2009-2011	FA229	FA229V	FA229HH	EPFA229HH				MD4158			16
	Right		FA231	FA231V	FA231HH	EPFA231HH					MD4158		17
VN 1700 Vulcan Nomad	Left	2009-2013	FA229	FA229V	FA229HH	EPFA229HH				MD4158			18
	Right		FA231	FA231V	FA231HH	EPFA231HH					MD4158		19
VN 1700 Vulcan Nomad	Left	2009	FA229	FA229V	FA229HH	EPFA229HH				MD4158			20
	Right		FA231	FA231V	FA231HH	EPFA231HH					MD4158		21
VN 1700 Vulcan Vaquero		2014-2023	FA158*		FA158HH*	EPFA158HH*				MD4158	MD4158		22
VN 1700 Vulcan Voyager		2009-2013	FA158*		FA158HH*	EPFA158HH*				MD4158	MD4158		23
VN 1700 Vulcan Voyager		2009-2023	FA158*		FA158HH*	EPFA158HH*				MD4158	MD4158		24
VN 2000 Vulcan		2004-2009	FA158*		FA158HH*	EPFA158HH*				MD4158	MD4158		25
VN 2000 Vulcan Classic		2006-2009	FA158*		FA158HH*	EPFA158HH*				MD4158	MD4158		26
VN 2000 Vulcan Classic LT		2006-2010	FA158*		FA158HH*	EPFA158HH*				MD4158	MD4158		27
VN 2000 Vulcan Ltd		2005-2006	FA158*		FA158HH*	EPFA158HH*				MD4158	MD4158		28
													29
													30
													31
													32
													33
													34
													35
													36
													37
													38
													39
													40
													41
													42
													43
													44
													45
													46
													47
													48
													49
													50
													51
													52
													53
													54
													55
													56

FRONT

* This symbol indicates a rotor made of billet steel, and should be only used with EBC FA Organic or Vee pads.
 SAFETY NOTICE - With vehicles primarily designed for off highway use such as quads now being used on the highway, we would recommend the use of X or MXS pads for highway use and ONLY using the R and SV higher density / harder pad series for off road riding.

*-2 Sets Required. † For Vee disc colours add RED, BLU, GRN, GLD, ORG suffix to part number. **SAFETY WARNING:- DO NOT USE HH PADS ON REAR UNLESS ALSO USED ON FRONT TO AVOID BRAKE IMBALANCE**

FRONT: KAWASAKI Cont'd

REAR: KAWASAKI

Line #	BRAKE ROTOR CHOICES - FRONT					DISC PAD CHOICES - REAR					BRAKE ROTOR CHOICES - REAR					
	CX Extreme® /Vee-Rotor	OSX Series Oversize 280mm Rotor Kit	Relocating Bracket for Oversize Rotor	SMX Series Oversize 320mm Rotor Kit	Relocating Bracket for 320mm Rotor	Front Disc Bolt Kit	FA/SFA/X Pad or Brake Shoe	Specialty Pads SXR/VEE/MXS Race	Sintered/HH Pads/Grooved Shoes	EPFA Sintered Fast Road/Track Pads	SV Series Severe Duty Pads	Standard Rotor	Vintage Rotor / UTV Oversize Brake Kit	Contour Profile Rotor	CX Extreme® /Vee-Rotor	Rear Disc Bolt Kit
1																
2												MD4146				
3	VR4022BLK*†					DB404/5	FA231/3V									
4	VR4022BLK*†					DB404/5	FA231/3V									
5							FA231/3V									
6							FA231/3V									
7							FA231/3V									
8							FA231/3V					MD4146				
9							FA231/3V									
10							FA231/3V					MD4146				
11							FA231/3V									
12							FA231/3V									
13							FA231/3V									
14							FA231/3V									
15							FA231/3V									
16							FA231/3V									
17							FA231/3V									
18							FA231/3V									
19							FA231/3V									
20							FA231/3V									
21							FA231/3V									
22							FA231/3V									
23							FA231/3V									
24							FA231/3V									
25							FA231/3V					MD4147				
26							FA231/3V					MD4147				
27							FA231/3V					MD4147				
28							FA231/3V					MD4147				
29																
30																
31																
32																
33																
34																
35																
36																
37																
38																
39																
40																
41																
42																
43																
44																
45																
46																
47																
48																
49																
50																
51																
52																
53																
54																
55																
56																

REAR

BRAKE APPLICATIONS

⚠ This symbol indicates a rotor made of billet steel, and should be only used with EBC FA Organic or Vee pads.
 SAFETY NOTICE - With vehicles primarily designed for off highway use such as quads now being used on the highway, we would recommend the use of X or MXS pads for highway use and ONLY using the R and SV higher density / harder pad series for off road riding.

*-2 Sets Required. † For Vee disc colours add RED, BLU, GRN, GLD, ORG suffix to part number. **SAFETY WARNING:- DO NOT USE HH PADS ON REAR UNLESS ALSO USED ON FRONT TO AVOID BRAKE IMBALANCE**

FRONT: SUZUKI

APPLICATIONS

BRAKE



SUZUKI



DISC PAD CHOICES - FRONT

BRAKE ROTOR CHOICES - FRONT

Model	Year	FA/SFA/X Pad or Brake Shoe	Specialty Pads SXR/VEE/MXS Race	Sintered/HH Pads/Grooved Shoes	EPFA Sintered Fast Road/Track Pads	GPFAX Sintered RACE ONLY Pads	SV Series Severe Duty Pads	Standard Rotor		Vintage Rotor / UTV Oversize Brake Kit	Contour Profile Rotor	Line #
								Standard Rotor Left	Standard Rotor Right			
AC 50 R	1970-1971	603										1
AS 50 Sport/Colt	1968-1969	603										2
DR-Z 50	2018-2024	301										3
FA 50	1980-1991	614										4
FS 50 TIX	1980-1981	614										5
FZ 50 NITIXIZID	1979-1983	601										6
GSXR 50	1987	FA67		FA67HH				MD3010LS				7
JR 50 All Models	1978-2006	613		613G								8
LT 50 EIFIGIH	1984-1987											9
LT-A 50 QuadSport	2002-2005	614*		614G*								10
LTZ 50 QuadSport	2006-2011	614*		614G*								11
LTZ 50 QuadSport	2017-2024	614*		614G*								12
OR 50 T	1980	604										13
RM 50 CINIT	1978-1980	603		603G								14
RM 50 X	1981	604		604G								15
RM 60 K3	2003	715		715G								16
RM 60 NIT	1979-1980	603		603G								17
RM 60 XIZID	1981-1983	604		604G								18
RM 65	2003-2005	FA302X	MXS302	FA302R				MD6166D				19
DR-Z 70	2008-2009	301										20
DR-Z 70	2015-2018	301										21
DS 80	1980-2000	604		604G								22
JR 80	2001-2004	604		604G								23
LT 80	1987-2006	614*		614G*								24
RM 80	1980-1981	604		604G								25
RM 80	1982-1985	615										26
RM 80	1986-1989	FA83X		FA83R				MD6018D			MD6018C	27
RM 80	1990-1995	FA83X		FA83R				MD6018D			MD6018C	28
RM 80	1996-2001	FA230X		FA230R				MD6018D			MD6018C	29
RM 85	2002-2004	FA230X		FA230R				MD6018D			MD6018C	30
RM 85	2005-2012	FA258X		FA258R				MD6030D			MD6030C	31
RM 85	2015-2023	FA258X		FA258R				MD6030D			MD6030C	32
XN 85 D	1983	FA65*	FA65V*					MD3028LS	MD3028RS			33
LT-Z 90 QuadSport	2007-2011	604*		604G*								34
LT-Z 90 QuadSport	2014-2018	604*		604G*								35
TC 90 Blazer	1970	602		602G								36
TC 90 Blazer	1971-1972	603		603G								37
TS 90 Honcho	1970	602		602G								38
TS 90 Honcho	1971-1972	603		603G								39
A 100 AIB Cofer	1976-1977	602										40
B 100 P Magnum	1965-1966	602										41
DR 100	1983-1990	604		604G								42
DS 100	1978-1981	602		602G								43
RM 100	1976-1978	603		603G								44
RM 100	1979-1981	603		603G								45
RM 100 K3	2003	FA258X		FA258R				MD6186D			MD6186C	46
SP 100 D	1983	617										47
TC 100 Blazer	1973-1975	603		603G								48
TC 100 Blazer	1976-1977	602		602G								49
TS 100	1976-1981	602		602G								50
TS 100 Honcho	1973-1975	603		603G								51
TS 100 Honcho	1976-1977	602		602G								52
B 105 P Bearcat	1967-1968	602		602G								53
DR-Z 110	2003-2005	715		715G								54
B 120	1971-1977	602										55
KT 120 Trail	1968-1970	602		602G								56

FRONT

⚠ This symbol indicates a rotor made of billet steel, and should be only used with EBC FA Organic or Vee pads. SAFETY NOTICE - With vehicles primarily designed for off highway use such as quads now being used on the highway, we would recommend the use of X or MXS pads for highway use and ONLY using the R and SV higher density / harder pad series for off road riding.

*-2 Sets Required. † For Vee disc colours add RED, BLU, GRN, GLD, ORG suffix to part number. SAFETY WARNING:- DO NOT USE HH PADS ON REAR UNLESS ALSO USED ON FRONT TO AVOID BRAKE IMBALANCE

FRONT: SUZUKI Cont'd

REAR: SUZUKI

Line #	BRAKE ROTOR CHOICES - FRONT						DISC PAD CHOICES - REAR						BRAKE ROTOR CHOICES - REAR				
	CX Extreme® /Vee-Rotor	OSX Series Oversize 280mm Rotor Kit	Relocating Bracket for Oversize Rotor	SMX Series Oversize 320mm Rotor Kit	Relocating Bracket for 320mm Rotor	Front Disc Bolt Kit	FA/SFA/X Pad or Brake Shoe	Specialty Pads SXR/ VEE/MXS Race	Sintered/ HH Pads/ Grooved Shoes	EPFA Sintered Fast Road/ Track Pads	SV Series Severe Duty Pads	Standard Rotor	Vintage Rotor / UTV Oversize Brake Kit	Contour Profile Rotor	CX Extreme® /Vee-Rotor	Rear Disc Bolt Kit	
1								603									
2								603									
3								301		301G							
4								614									
5								614									
6								601									
7								604									
8								613		613G							
9								613		613G							
10								604		604G							
11								604		604G							
12								604		604G							
13								604		604G							
14								603		603G							
15								604		604G							
16								715		715G							
17								603		603G							
18								604		604G							
19	MD6166CX							FA54X		FA54R		MD6166D		MD6166CX	DB403/4		
20								301									
21								301									
22								604		604G							
23								604		604G							
24								618		618G							
25								604		604G							
26								502		502G							
27								502		502G							
28								FA83X		FA83R		MD6025D		MD6025C			
29		OSX6018	BRK001					FA83X		FA83R		MD6025D		MD6025C			
30		OSX6018	BRK001					FA83X		FA83R		MD6025D		MD6025C			
31	MD6030CX	OSXS6030	BRK029			DB301/4		FA401X		FA401R		MD6246D		MD6246C	MD6246CX		
32	MD6030CX	OSXS6030	BRK029			DB301/4		FA401X		FA401R		MD6246D		MD6246C	MD6246CX		
33								FA36				MD3014RS	VMD3014				
34								618		618G							
35								618		618G							
36								602		602G							
37								602		602G							
38								602		602G							
39								602		602G							
40								603									
41								602									
42								604		604G							
43								602		602G							
44								603		603G							
45								617									
46	MD6186CX	OSX6186	BRK025			BD403/6		FA84X		FA84R		MD6187D		MD6187C	MD6187CX	DB403/4	
47								604		604G							
48								602		602G							
49								602		602G							
50								602		602G							
51								602		602G							
52								602		602G							
53								602		602G							
54								603		603G							
55								602									
56								602		602G							

⚠ This symbol indicates a rotor made of billet steel, and should be only used with EBC FA Organic or Vee pads.
SAFETY NOTICE - With vehicles primarily designed for off highway use such as quads now being used on the highway, we would recommend the use of X or MXS pads for highway use and ONLY using the R and SV higher density / harder pad series for off road riding.

*-2 Sets Required. † For Vee disc colours add RED, BLU, GRN, GLD, ORG suffix to part number. **SAFETY WARNING:- DO NOT USE HH PADS ON REAR UNLESS ALSO USED ON FRONT TO AVOID BRAKE IMBALANCE**

FRONT: SUZUKI

APPLICATIONS

BRAKE



SUZUKI



DISC PAD CHOICES - FRONT

BRAKE ROTOR CHOICES - FRONT

Model	Year	FA/SFA/X Pad or Brake Shoe	Specialty Pads SXR/ VEE/MXS Race	Sintered/ HH Pads/ Grooved Shoes	EPFA Sintered Fast Road/Track Pads	GPFA Sintered RACE ONLY Pads	SV Series Severe Duty Pads	Standard Rotor		Vintage Rotor / UTV Oversize Brake Kit	Contour Profile Rotor	Line #
								Standard Rotor Left	Standard Rotor Right			
TC 120 Trailcat	1968-1971	602		602G								1
DR 125	1982-1983	602		602G								2
DR 125	1986-1996	FA54X	MXS54	FA54R				MD6073D				3
DR 125 E	1984	602		602G								4
DR-Z 125	2003-2016	604		604G								5
DR-Z 125 L	2003-2024	FA230X		FA230R				MD6212D				6
DS 125	1979-1981	602		602G								7
GN 125	1982-1983	602										8
GN 125	1991-1996	FA67		FA67HH								9
GSX-R 125	2018-2021	FA715	FA715V	FA715HH							MD3110C	10
GSX-S 125	2018-2021	FA715	FA715V	FA715HH							MD3110C	11
LT 125	1985-1987											12
LT 125 D	1983											13
LT 125 E	1984											14
RM 125	1976-1978	602		602G								15
RM 125	1979-1980	602		602G								16
RM 125	1981-1983	618		618G								17
RM 125	1991-1993	FA135X	MXS135	FA135R				MD6017D				18
RM 125	1994-1995	FA135X	MXS135	FA135R				MD6017D				19
RM 125 E	1984	622		622G								20
RM 125 FIG	1985-1986	FA106X		FA106R				MD6163D				21
RM 125 H	1987	FA135X	MXS135	FA135R				MD6163D				22
RM 125 J	1988	FA135X	MXS135	FA135R				MD6163D				23
RM 125 K	1989	FA135X	MXS135	FA135R				MD6017D				24
RM 125 K	2006-2008	FA185X	MXS185	FA185R				MD6017D				25
RM 125 L	1990	FA135X	MXS135	FA135R				MD6017D				26
RM 125 TIVW	1996-1998	FA185X	MXS185	FA185R				MD6017D				27
RM 125 X	1999-2005	FA185X	MXS185	FA185R				MD6017D				28
RV 125 Tracker	1973	603		603G								29
RV 125 Tracker	1974-1977	602		602G								30
SP 125	1982-1983	602		602G								31
SP 125	1986-1988	FA54X	MXS54	FA54R				MD6073D				32
T 125 R Stinger	1969-1971	602										33
TC 125 Prospector	1972-1973	603		603G								34
TC 125 Prospector	1974-1977	602		602G								35
TM 125 Challenger	1973-1975	603		603G								36
TS 125	1980-1981	602		602G								37
S32 150cc	1965	605										38
LT 160	1989-1992	624*		624G*								39
LT 160 QuadSport	2003-2004	624*		624G*								40
LT-F 160	1991-2001	624*		624G*								41
LT-F 160	2003	624*		624G*								42
PE 175	1980-1981	602		602G								43
PE 175	1982-1984	618		618G								44
RS 175	1980-1982	602		602G								45
DS 185 T	1980	602		602G								46
GT 185 Adventurer	1974-1976	FA55										47
GT 185 K Adventurer	1973											48
LT 185	1984-1987											49
TS 185	1980-1981	602		602G								50
DR 200	1986-1990	FA54X	MXS54	FA54R				MD6073D				51
DR 200	1996-2009	FA54X	MXS54	FA54R				MD6073D				52
DR 200	2013	FA54X	MXS54	FA54R				MD6073D				53
DR 200	2015-2021	FA54X	MXS54	FA54R				MD6073D				54
RV 200 Van-Van	2016-2019	FA231		FA231HH	EPFA231HH			MD6281D				55
SP 200	1986-1988	FA54X	MXS54	FA54R				MD6073D				56

FRONT

⚠ This symbol indicates a rotor made of billet steel, and should be only used with EBC FA Organic or Vee pads. SAFETY NOTICE - With vehicles primarily designed for off highway use such as quads now being used on the highway, we would recommend the use of X or MXS pads for highway use and ONLY using the R and SV higher density / harder pad series for off road riding.

*-2 Sets Required. † For Vee disc colours add RED, BLU, GRN, GLD, ORG suffix to part number. SAFETY WARNING:- DO NOT USE HH PADS ON REAR UNLESS ALSO USED ON FRONT TO AVOID BRAKE IMBALANCE

FRONT: SUZUKI Cont'd

REAR: SUZUKI

Line #	BRAKE ROTOR CHOICES - FRONT						DISC PAD CHOICES - REAR						BRAKE ROTOR CHOICES - REAR				
	CX Extreme® /Vee-Rotor	OSX Series Oversize 280mm Rotor Kit	Relocating Bracket for Oversize Rotor	SMX Series Oversize 320mm Rotor Kit	Relocating Bracket for 320mm Rotor	Front Disc Bolt Kit	FA/SFA/X Pad or Brake Shoe	Specialty Pads SXR/ VEE/MXS Race	Sintered/ HH Pads/ Grooved Shoes	EPFA Sintered Fast Road/ Track Pads	SV Series Severe Duty Pads	Standard Rotor	Vintage Rotor / UTV Oversize Brake Kit	Contour Profile Rotor	CX Extreme® /Vee-Rotor	Rear Disc Bolt Kit	
1							602		602G								
2							602		602G								
3							602		602G								
4							602		602G								
5							604		604G								
6							604		604G								
7							602		602G								
8							602										
9							602										
10							FA629		FA629HH			MD3111		MD3111C			
11							FA629		FA629HH			MD3111		MD3111C			
12							621										
13							621										
14							605		605G								
15							602		602G								
16							617										
17							616		616G								
18	MD6017CX	OSX6017E	BRK031				FA152/2X	MXS152/2	FA152/2R			MD6014D			MD6014CX		
19	MD6017CX	OSX6017E	BRK031				FA152/2X	MXS152/2	FA152/2R			MD6014D			MD6014CX		
20							616		616G								
21							616		616G								
22							616		616G								
23								MXS84/3	FA84/3R			MD6014D					
24	MD6017CX	OSX6017E	BRK031				FA152X	MXS152	FA152R			MD6014D			MD6014CX		
25	MD6017CX	OSX6017	BRK023	SMX6017	BRK024		FA131X	MXS131	FA131R			MD6305D		MD6305C	MD6305CX		
26	MD6017CX	OSX6017E	BRK031				FA152X	MXS152	FA152R			MD6014D			MD6014CX		
27	MD6017CX	OSX6017	BRK023	SMX6017	BRK024		FA131X	MXS131	FA131R			MD6014D			MD6014CX		
28	MD6017CX	OSX6017	BRK023	SMX6017	BRK024		FA131X	MXS131	FA131R			MD6157D		MD6157C	MD6157CX		
29							602		602G								
30							602		602G								
31							602		602G								
32							602		602G								
33							602		602G								
34							602		602G								
35							602		602G								
36							602		602G								
37							602		602G								
38							602		602G								
39							605		605G								
40							605		605G								
41							605		605G								
42							605		605G								
43							605		605G								
44							619		619G								
45							619		619G								
46							617										
47							602		602G								
48							602										
49							605		605G								
50							602		602G								
51							602		602G								
52							602		602G								
53							602		602G								
54							602		602G								
55							603										
56							602		602G								

BRAKE APPLICATIONS
 This symbol indicates a rotor made of billet steel, and should be only used with EBC FA Organic or Vee pads.
 SAFETY NOTICE - With vehicles primarily designed for off highway use such as quads now being used on the highway, we would recommend the use of X or MXS pads for highway use and ONLY using the R and SV higher density / harder pad series for off road riding.

*-2 Sets Required. † For Vee disc colours add RED, BLU, GRN, GLD, ORG suffix to part number. **SAFETY WARNING:- DO NOT USE HH PADS ON REAR UNLESS ALSO USED ON FRONT TO AVOID BRAKE IMBALANCE**

FRONT: SUZUKI



SUZUKI



BRAKE APPLICATIONS

⚡ This symbol indicates a rotor made of billet steel, and should be only used with EBC FA Organic or Vee pads.
SAFETY NOTICE - With vehicles primarily designed for off highway use such as quads now being used on the highway, we would recommend the use of X or MXS pads for highway use and ONLY using the R and SV higher density / harder pad series for off road riding.

DISC PAD CHOICES - FRONT

BRAKE ROTOR CHOICES - FRONT

FA/SFA/X Pad or Brake Shoe	Specialty Pads SXR/ VEE/MXS Race	Sintered/ HH Pads/ Grooved Shoes	EPFA Sintered Fast Road/Track Pads	GPFA Sintered RACE ONLY Pads	SV Series Severe Duty Pads	Standard Rotor Left	Standard Rotor Right	Vintage Rotor / UTV Oversize Brake Kit	Contour Profile Rotor
	SFA197	SFA197HH					MD9176D		
	FA128X*	FA128R*			FA128SV*	MD6020D	MD6020D		
	FA128X*	FA128R*			FA128SV*	MD6020D	MD6020D		
	FA128X*	FA128R*			FA128SV*	MD6020D	MD6020D		
	FA128X*	FA128R*			FA128SV*	MD6020D	MD6020D		
	FA128X*	FA128R*			FA128SV*	MD6020D	MD6020D		
	FA128X*	FA128R*			FA128SV*	MD6020D	MD6020D		
	625*	625G*							
	625*	625G*							
	FA226	FA226HH							MD3112C
	602	602G							
	FA135X	MXS135 FA135R				MD6040D			
	FA135X	MXS135 FA135R				MD6040D			
	FA54X	MXS54 FA54R				MD6074D			
	FA185X	MXS185 FA185R				MD6017D			MD6017C
	605	605G							
	FA51					MD3014LS		VMD3014	
	FA51					MD3014LS		VMD3014	
	FA226	FA226HH	EPFA226HH						MD3112C
	FA226	FA226HH	EPFA226HH						MD3112C
	FA55						MD3014RS		
	FA142	FA142V FA142HH				MD3105LS			
	FA106								
	FA128X*	FA128R*			FA128SV*	MD6020D	MD6020D		
	FA128X*	FA128R*			FA128SV*	MD6020D	MD6020D		
	FA128X*	FA128R*			FA128SV*	MD6020D	MD6020D		
	625*	625G*							
	628*	628G*							
	628*	628G*							
	FA54X*	FA54R*			FA54SV*	MD6195D	MD6195D		
	FA54X*	FA54R*			FA54SV*	MD6207D	MD6207D		
	628*	628G*							
	FA84X*	FA84R*			FA84SV*	MD6210D	MD6210D		
	605	605G							
	602	602G							
	FA185X	MXS185 FA185R				MD6017D			MD6017C
	FA185X	MXS185 FA185R				MD6017D			MD6017C
	622	622G							
	622	622G							
	FA106X	FA106R				MD6163D			
	FA135X	MXS135 FA135R				MD6163D			
	FA135X	MXS135 FA135R				MD6017D			MD6017C
	FA135X	MXS135 FA135R				MD6017D			MD6017C
	605	605G							
	FA135X	MXS135 FA135R				MD6017D			MD6017C
	FA135X	MXS135 FA135R				MD6017D			MD6017C
	618	618G							
	FA185X	MXS185 FA185R				MD6017D			MD6017C
	621								
	FA185X	MXS185 FA185R				MD6017D			MD6017C
	FA135X	MXS135 FA135R				MD6017D			MD6017C
	FA135X	MXS135 FA135R				MD6017D			MD6017C
	FA185X	MXS185 FA185R				MD6017D			MD6017C

FRONT

Line #
1
2
3
4
5
6
7
8
9
10
11
12
13
14
15
16
17
18
19
20
21
22
23
24
25
26
27
28
29
30
31
32
33
34
35
36
37
38
39
40
41
42
43
44
45
46
47
48
49
50
51
52
53
54
55
56

*-2 Sets Required. † For Vee disc colours add RED, BLU, GRN, GLD, ORG suffix to part number. **SAFETY WARNING:- DO NOT USE HH PADS ON REAR UNLESS ALSO USED ON FRONT TO AVOID BRAKE IMBALANCE**

FRONT: SUZUKI Cont'd

REAR: SUZUKI

Line # 1
2
3
4
5
6
7
8
9
10
11
12
13
14
15
16
17
18
19
20
21
22
23
24
25
26
27
28
29
30
31
32
33
34
35
36
37
38
39
40
41
42
43
44
45
46
47
48
49
50
51
52
53
54
55
56

BRAKE ROTOR CHOICES - FRONT						DISC PAD CHOICES - REAR					BRAKE ROTOR CHOICES - REAR				
CX Extreme® /Vee-Rotor	OSX Series Oversize 280mm Rotor Kit	Relocating Bracket for Oversize Rotor	SMX Series Oversize 320mm Rotor Kit	Relocating Bracket for 320mm Rotor	Front Disc Bolt Kit	FA/SFA/X Pad or Brake Shoe	Specialty Pads SXR/ VEE/MXS Race	Sintered/ HH Pads/ Grooved Shoes	EPFA Sintered Fast Road/ Track Pads	SV Series Severe Duty Pads	Standard Rotor	Vintage Rotor / UTV Oversize Brake Kit	Contour Profile Rotor	CX Extreme® /Vee-Rotor	Rear Disc Bolt Kit
						605									
						605									
						SFA413		SFA413HH			MD9176D			VR9117	
							MXS84/3	FA84/3R			MD6021D				
						FA84X		FA84R		FA84SV	MD6063D				
								FA84/3R			MD6021D				
								FA84/3R			MD6063D				
						FA84X		FA84R		FA84SV	MD6021D				
						FA84X		FA84R		FA84SV	MD6063D				
						605		605G							
						605		605G							
						FA496		FA496HH					MD3113C		
						602		602G							
MD6040CX	OSX6040	BRK031				FA152X	MXS152	FA152R			MD6038D			MD6038CX	
MD6040CX	OSX6040	BRK031				FA152X	MXS152	FA152R			MD6038D			MD6038CX	
						602		602G							
MD6017CX	OSX6017	BRK023	SMX6017	BRK024		FA152/2X	MXS152/2	FA152/2R			MD6110D			MD6110CX	
						605		605G							
						602									
						602									
						606		606G							
						FA496		FA496HH					MD3113C		
						FA496		FA496HH					MD3113C		
						609									
						FA496		FA496HH			MD3093				DB303/5
						602									
							MXS84/3	FA84/3R			MD6063D				
						FA137X		FA137R		FA137SV	MD6021D				
						FA84X		FA84R		FA84SV	MD6063D				
						634		634G							
						629		629G							
						629		629G							
						606		606G							
						636		636G							
						629		629G							
						636		636G							
					DB302/3	605		605G							
						605		605G							
MD6017CX	OSX6017	BRK023	SMX6017	BRK024		FA131X	MXS131	FA131R			MD6157D		MD6157C	MD6157CX	
MD6017CX	OSX6017	BRK023	SMX6017	BRK024		FA131X	MXS131	FA131R			MD6305D		MD6305C	MD6305CX	
						616		616G							
						618		618G							
						618		618G							
								FA84/3R			MD6014D				
MD6017CX	OSX6017E	BRK031				FA152X	MXS152	FA152R			MD6014D			MD6014CX	
MD6017CX	OSX6017E	BRK031				FA152X	MXS152	FA152R			MD6014D			MD6014CX	
						620		620G							
MD6017CX	OSX6017E	BRK031				FA152/2X	MXS152/2	FA152/2R			MD6014D			MD6014CX	
MD6017CX	OSX6017E	BRK031				FA152/2X	MXS152/2	FA152/2R			MD6014D			MD6014CX	
						620		620G							
MD6017CX	OSX6017	BRK023	SMX6017	BRK024		FA131X	MXS131	FA131R			MD6014D			MD6014CX	
						616		616G							
MD6017CX	OSX6017	BRK023	SMX6017	BRK024		FA131X	MXS131	FA131R			MD6157D		MD6157C	MD6157CX	
MD6017CX	OSX6017E	BRK031				FA152X	MXS152	FA152R			MD6014D			MD6014CX	
MD6017CX	OSX6017E	BRK031				FA152X	MXS152	FA152R			MD6014D			MD6014CX	
MD6017CX	OSX6017	BRK023	SMX6017	BRK024		FA152X	MXS152	FA152R			MD6014D			MD6014CX	

BRAKE APPLICATIONS
 This symbol indicates a rotor made of billet steel, and should be only used with EBC FA Organic or Vee pads.
 SAFETY NOTICE - With vehicles primarily designed for off highway use such as quads now being used on the highway, we would recommend the use of X or MXS pads for highway use and ONLY using the R and SV higher density / harder pad series for off road riding.

*-2 Sets Required. † For Vee disc colours add RED, BLU, GRN, GLD, ORG suffix to part number. **SAFETY WARNING:- DO NOT USE HH PADS ON REAR UNLESS ALSO USED ON FRONT TO AVOID BRAKE IMBALANCE**

FRONT: SUZUKI



SUZUKI



DISC PAD CHOICES - FRONT

BRAKE ROTOR CHOICES - FRONT

Model	Year	FA/SFA/X Pad or Brake Shoe	Specialty Pads SXR/VEE/MXS Race	Sintered/HH Pads/Grooved Shoes	EPFA Sintered Fast Road/Track Pads	GPFAX Sintered RACE ONLY Pads	SV Series Severe Duty Pads	Standard Rotor Left	Standard Rotor Right	Vintage Rotor / UTV Oversize Brake Kit	Contour Profile Rotor	Line #
RM-Z 250	2004-2006	FA185X	MXS185	FA185R				MD6213D			MD6213C	1
RM-Z 250	2007	FA185X	MXS185	FA185R				MD6254D			MD6254C	2
RM-Z 250	2008-2018	FA185X	MXS185	FA185R				MD6254D			MD6254C	3
RM-Z 250	2019-2024	FA185X	MXS185	FA185R								4
SP 250	1982-1983	620		620G								5
SP 250 F	1985	FA54X	MXS54	FA54R				MD6074D				6
T 250 111RJ Hustler	1969-1972	608										7
T10 250	1966-1967	608										8
T20 250 X6	1965-1969	608										9
TC 250 X6 Scrambler	1967-1969	608										10
TS 250	1971-1981	605		605G								11
TU 250	2009-2016	FA229		FA229HH								12
GS 300	1982-1983											13
GS 300 LF	1985	612										14
LT 300 JIK	1987-1989	625*		625G*								15
LT-F 300 FK2 King Quad	2002	FA165X		FA165R			FA165SV	MD6206D				16
		FA135X		FA135R			FA135SV		MD6206D			17
LT-F 300 King Quad	1999-2001	633*		633G*								18
LT-F 300 King Quad 300	1991-1998	633*		633G*								19
T 305 Raider	1968-1969	608										20
S32-2 150cc	1966-1967											21
DR 350	1990-1996	FA135X	MXS135	FA135R				MD6040D				22
DR 350	1990-1995	FA135X	MXS135	FA135R				MD6040D				23
DR 350	1996-1997	FA135X	MXS135	FA135R				MD6040D				24
DR 350	1997-1999	FA185X	MXS185	FA185R				MD6017D			MD6017C	25
DR 350	1998-1999	FA185X	MXS185	FA185R				MD6017D			MD6017C	26
T 350 Rebel	1969-1972	608										27
DR 370	1978-1979	602		602G								28
RM 370	1976-1977	602		602G								29
SP 370	1978-1979	605		605G								30
GT 380 J Sebring	1972	608										31
GT 380 Sebring	1973-1977	FA55							MD3014RS			32
AN 400 AN 400 Z Burgman	2014-2023	SFA228		SFA228HH				MD994D				33
		SFA197		SFA197HH					MD994D			34
AN 400 Burgman	2003-2006	SFA283/4		SFA283/4HH				MD994D				35
AN 400 Burgman	2007-2016	SFA228		SFA228HH				MD994D				36
		SFA197		SFA197HH					MD994D			37
DR 400 T	1980	602		602G								38
DR-Z 400 E	2000-2007	FA185X	MXS185	FA185R	EPFA185HH			MD6017D			MD6017C	39
DR-Z 400 S	2000-2024	FA185X	MXS185	FA185R	EPFA185HH			MD6017D			MD6017C	40
DR-Z 400 SM	2013-2024	FA185X	MXS185	FA185R	EPFA185HH			MD6247D			MD6247C	41
GN 400 TT	1980-1982	FA51						MD3014LS		VMD3014		42
GS 400	1977-1978	612										43
GS 400 BIC	1977-1978	FA35							MD3014RS			44
GSF 400 Bandit	1991-1993	FA129		FA129HH				MD3006X			MD3006XC	45
LT-A 400 Eiger	2002-2004	FA54X*		FA54R*			FA54SV*	MD6195D	MD6195D			46
LT-A 400 Eiger	2002-2007	FA54X*		FA54R*			FA54SV*	MD6195D	MD6195D			47
LT-A 400 Eiger	2006-2018	FA54X*		FA54R*			FA54SV*	MD6195D	MD6195D			48
LT-A 400 King Quad	2008-2018	FA413X		FA413R			FA413SV	MD6195D				49
		FA414X		FA414R			FA414SV		MD6195D			50
LT-A 400 King Quad 400 AS	2008-2018	FA413X		FA413R			FA413SV	MD6195D				51
		FA414X		FA414R			FA414SV		MD6195D			52
LT-A 400 King Quad 400 AS Anniversary Edition	2008-2009	FA413X		FA413R			FA413SV	MD6195D				53
		FA414X		FA414R			FA414SV		MD6195D			54
LT-A 400 King Quad 400 AS Camo	2009	FA413X		FA413R			FA413SV	MD6195D				55
		FA414X		FA414R			FA414SV		MD6195D			56

FRONT

BRAKE APPLICATIONS

* This symbol indicates a rotor made of billet steel, and should be only used with EBC FA Organic or Vee pads.
 SAFETY NOTICE - With vehicles primarily designed for off highway use such as quads now being used on the highway, we would recommend the use of X or MXS pads for highway use and ONLY using the R and SV higher density / harder pad series for off road riding.

*-2 Sets Required. † For Vee disc colours add RED, BLU, GRN, GLD, ORG suffix to part number. **SAFETY WARNING:- DO NOT USE HH PADS ON REAR UNLESS ALSO USED ON FRONT TO AVOID BRAKE IMBALANCE**

FRONT: SUZUKI Cont'd

REAR: SUZUKI

Line #	BRAKE ROTOR CHOICES - FRONT					Front Disc Bolt Kit	DISC PAD CHOICES - REAR					BRAKE ROTOR CHOICES - REAR				
	CX Extreme® /Vee-Rotor	OSX Series Oversize 280mm Rotor Kit	Relocating Bracket for Oversize Rotor	SMX Series Oversize 320mm Rotor Kit	Relocating Bracket for 320mm Rotor		FA/SFA/X Pad or Brake Shoe	Specialty Pads SXR/ VEE/MXS Race	Sintered/ HH Pads/ Grooved Shoes	EPFA Sintered Fast Road/ Track Pads	SV Series Severe Duty Pads	Standard Rotor	Vintage Rotor / UTV Oversize Brake Kit	Contour Profile Rotor	CX Extreme® /Vee-Rotor	Rear Disc Bolt Kit
1	MD6213CX	OSX6213	BRK023	SMX6213	BRK024		FA367X	MXS367	FA367R			MD6208D		MD6208C		
2	MD6254CX	OSX6254	BRK023	SMX6254	BRK024		FA367X	MXS367	FA367R			MD6255D		MD6255CX		
3	MD6254CX	OSX6254	BRK023	SMX6254	BRK024		FA367X	MXS367	FA367R			MD6255D		MD6255CX		
4	MD6422CX	OSX6254	BRK023	SMX6254	BRK024		FA367X	MXS367	FA367R			MD6255D		MD6255CX		
5							602		602G							
6							602		602G							
7							609									
8							609									
9							609									
10							609									
11							605		605G							
12							602									
13							606		606G							
14							606		606G							
15							634		634G							
16							634		634G							
17																
18							634		634G							
19							634		634G							
20							609									
21							605									
22	MD6040CX	OSX6040	BRK031				FA152X	MXS152	FA152R			MD6038D		MD6038CX		
23	MD6040CX	OSX6040	BRK031				FA152X	MXS152	FA152R			MD6038D		MD6038CX		
24	MD6040CX	OSX6040	BRK031				FA152X	MXS152	FA152R			MD6110D		MD6110CX		
25	MD6017CX	OSX6017	BRK023	SMX6017	BRK024		FA152X	MXS152	FA152R			MD6110D		MD6110CX		
26	MD6017CX	OSX6017	BRK023	SMX6017	BRK024		FA152X	MXS152	FA152R			MD6110D		MD6110CX		
27							609									
28							605		605G							
29							605		605G							
30							605		605G							
31							609									
32							609									
33							SFA412		SFA412HH			MD9109D				
34																
35							SFA411		SFA411HH							
36							SFA412		SFA412HH			MD9109D				
37																
38							605		605G							
39	MD6017CX	OSX6017	BRK023	SMX6017	BRK038		FA131X	MXS131	FA131R			MD6014D		MD6014CX		
40	MD6017CX	OSX6017	BRK023	SMX6017	BRK038		FA131X	MXS131	FA131R			MD6014D		MD6014CX		
41							FA131X	MXS131	FA131R			MD6157D		MD6157C		
42							606		606G							
43							609									
44							609									
45	VR3006BLK†					DB303/5	FA63		FA63HH			MD3002		MD3002C	VR3002 DB303/5	
46							606		606G							
47							606		606G							
48							606		606G							
49							606		606G							
50							606		606G							
51							606		606G							
52							606		606G							
53							606		606G							
54							606		606G							
55							606		606G							
56							606		606G							

⚠ This symbol indicates a rotor made of billet steel, and should be only used with EBC FA Organic or Vee pads.
SAFETY NOTICE - With vehicles primarily designed for off highway use such as quads now being used on the highway, we would recommend the use of X or MXS pads for highway use and ONLY using the R and SV higher density / harder pad series for off road riding.

*-2 Sets Required. † For Vee disc colours add RED, BLU, GRN, GLD, ORG suffix to part number. **SAFETY WARNING:- DO NOT USE HH PADS ON REAR UNLESS ALSO USED ON FRONT TO AVOID BRAKE IMBALANCE**

FRONT: SUZUKI

APPLICATIONS



SUZUKI



SAFETY NOTICE - With vehicles primarily designed for off highway use such as quads now being used on the highway, we would recommend the use of X or MXS pads for highway use and ONLY using the R and SV higher density / harder pad series for off road riding.

This symbol indicates a rotor made of billet steel, and should be only used with EBC FA Organic or Vee pads.

			DISC PAD CHOICES - FRONT					BRAKE ROTOR CHOICES - FRONT				Line #	
Model	Side	Year	FA/SFA/X Pad or Brake Shoe	Specialty Pads SXR/VEE/MXS Race	Sintered/HH Pads/ Grooved Shoes	EPFA Sintered Fast Road/Track Pads	GPFA Sintered RACE ONLY Pads	SV Series Severe Duty Pads	Standard Rotor Left	Standard Rotor Right	Vintage Rotor / UTV Oversize Brake Kit	Contour Profile Rotor	
LT-A 400 King Quad 400 Asi	Left	2011-2022	FA413X		FA413R			FA413SV	MD6195D				1
	Right		FA414X		FA414R			FA414SV		MD6195D			2
LT-A 400 King Quad 400 Asi Camo	Left	2011-2022	FA413X		FA413R			FA413SV	MD6195D				3
	Right		FA414X		FA414R			FA414SV		MD6195D			4
LT-F 400		2002-2007	FA54X*		FA54R*			FA54SV*	MD6195D	MD6195D			5
LT-F 400		2003-2008	FA54X*		FA54R*			FA54SV*	MD6195D	MD6195D			6
LT-F 400 K2 Eiger		2002	FA54X*		FA54R*			FA54SV*	MD6195D	MD6195D			7
LT-F 400 K8	Left	2008	FA413X		FA413R			FA413SV	MD6195D				8
	Right		FA414X		FA414R			FA414SV		MD6195D			9
LT-F 400 King Quad 400 FS	Left	2008-2010	FA413X		FA413R			FA413SV	MD6195D				10
	Right		FA414X		FA414R			FA414SV		MD6195D			11
LT-F 400 King Quad 400 FS Anniversary Edition	Left	2009	FA413X		FA413R			FA413SV	MD6195D				12
	Right		FA414X		FA414R			FA414SV		MD6195D			13
LT-F 400 King Quad 400 FS Camo	Left	2008-2009	FA413X		FA413R			FA413SV	MD6195D				14
	Right		FA414X		FA414R			FA414SV		MD6195D			15
LT-F 400 King Quad 400 FSi	Left	2011-2016	FA413X		FA413R			FA413SV	MD6195D				16
	Right		FA414X		FA414R			FA414SV		MD6195D			17
LT-F 400 King Quad 400 FSi Camo	Left	2011-2016	FA413X		FA413R			FA413SV	MD6195D				18
	Right		FA414X		FA414R			FA414SV		MD6195D			19
LT-Z 400 Quadsport		2003-2014	FA84X*	MXS84*	FA84R*			FA84SV*	MD6210D	MD6210D			20
PE 400		1980-1981	605		605G								21
RM 400 C		1978	602		602G								22
RM 400 N		1979	605		605G								23
RM 400 T		1980	618		618G								24
SP 400 T		1980	605		605G								25
TM 400 Cyclone		1971-1975	602		602G								26
TS 400		1972-1977	605		605G								27
GS 425 EN		1979	FA35						MD3014LS		VMD3014		28
GS 425 LN		1979	FA38	FA38V					MD3014LS		VMD3014		29
GS 425 N		1979	FA35						MD3014LS		VMD3014		30
GS 450		1980-1983	FA51						MD3014LS		VMD3014		31
GS 450		1980-1988	FA51						MD3014LS		VMD3014		32
GS 450		1981-1982	FA51						MD3014LS		VMD3014		33
GS 450		1982-1985	FA51						MD3014LS		VMD3014		34
GS 450		1982	FA51						MD3014LS		VMD3014		35
GS 450		1983	612										36
LT-A 450 King Quad 450 AXi Camo	Left	2007-2009	FA413X		FA413R			FA413SV	MD6261D				37
	Right		FA414X		FA414R			FA414SV		MD6261D			38
LT-A 450 King Quad 450 AXi Limited	Left	2008-2009	FA413X		FA413R			FA413SV	MD6261D				39
	Right		FA414X		FA414R			FA414SV		MD6261D			40
LT-A 450 King Quad 4x4 Axi	Left	2007-2010	FA413X		FA413R			FA413SV	MD6261D				41
	Right		FA414X		FA414R			FA414SV		MD6261D			42
LT-R 450	Left	2006-2011	FA165X	MXS165	FA165R			FA165SV	MD6277D				43
	Right		FA135X	MXS135	FA135R			FA135SV		MD6277D			44
LT-R 450 Quadracracer Limited Edition	Left	2008-2010	FA165X	MXS165	FA165R			FA165SV	MD6277D				45
	Right		FA135X	MXS135	FA135R			FA135SV		MD6277D			46
RMX 450 ZLO		2010	FA185X	MXS185	FA185R							MD6254C	47
RM-Z 450	Left	2005-2007	FA185X	MXS185	FA185R				MD6254D			MD6254C	48
	Right												49
RM-Z 450		2008-2017	FA185X	MXS185	FA185R				MD6254D			MD6254C	50
RM-Z 450		2018-2024	FA185X	MXS185	FA185R								51
RM 465	Left	1981-1982	621										52
	Right												53
DR 500	Left	1981-1983	602		602G								54
	Right												55

*-2 Sets Required. † For Vee disc colours add RED, BLU, GRN, GLD, ORG suffix to part number. **SAFETY WARNING:- DO NOT USE HH PADS ON REAR UNLESS ALSO USED ON FRONT TO AVOID BRAKE IMBALANCE**

FRONT: SUZUKI Cont'd

REAR: SUZUKI

Line #	BRAKE ROTOR CHOICES - FRONT					REAR	DISC PAD CHOICES - REAR					BRAKE ROTOR CHOICES - REAR				
	CX Extreme® /Vee-Rotor	OSX Series Oversize 280mm Rotor Kit	Relocating Bracket for Oversize Rotor	SMX Series Oversize 320mm Rotor Kit	Relocating Bracket for 320mm Rotor		Front Disc Bolt Kit	FA/SFA/X Pad or Brake Shoe	Specialty Pads SXR/ VEE/MXS Race	Sintered/ HH Pads/ Grooved Shoes	EPFA Sintered Fast Road/ Track Pads	SV Series Severe Duty Pads	Standard Rotor	Vintage Rotor / UTV Oversize Brake Kit	Contour Profile Rotor	CX Extreme® /Vee-Rotor
1							606		606G							
2																
3							606		606G							
4																
5							606		606G							
6							606		606G							
7							606		606G							
8							606		606G							
9																
10							606		606G							
11																
12							606		606G							
13																
14							606		606G							
15																
16							606		606G							
17																
18							606		606G							
19																
20						DB302/3	FA137X		FA137R		FA137SV	MD6211D				
21							605		605G							
22							605		605G							
23							620		620G							
24							620		620G							
25							605		605G							
26							605		605G							
27							605		605G							
28							606		606G							
29							606		606G							
30							609									
31							606		606G							
32							606		606G							
33							606		606G							
34							606		606G							
35							609									
36							606		606G							
37																
38																
39																
40																
41																
42																
43						DB302/3	FA137X		FA137R		FA137SV	MD6278D				DB302/3
44																
45						DB302/3	FA137X		FA137R		FA137SV	MD6278D				DB302/3
46																
47	MD6254CX	OSX6254	BRK023	SMX6254	BRK024		FA367X	MXS367	FA367R			MD6255D		MD6255C	MD6255CX	
48	MD6254CX	OSX6254	BRK023	SMX6254	BRK024		FA367X	MXS367	FA367R			MD6255D		MD6255C	MD6255CX	
49							FA131X									
50	MD6254CX	OSX6254	BRK023	SMX6254	BRK024		FA367X*	MXS367	FA367R			MD6255D		MD6255C	MD6255CX	
51	MD6422CX						FA367X*	MXS367	FA367R			MD6255D		MD6255C	MD6255CX	
52							602		602G							
53							FA367X									
54							605		605G							
55							FA367X									
56																

BRAKE APPLICATIONS

⚠ This symbol indicates a rotor made of billet steel, and should be only used with EBC FA Organic or Vee pads. SAFETY NOTICE - With vehicles primarily designed for off highway use such as quads now being used on the highway, we would recommend the use of X or MXS pads for highway use and ONLY using the R and SV higher density / harder pad series for off road riding.

*-2 Sets Required. † For Vee disc colours add RED, BLU, GRN, GLD, ORG suffix to part number. **SAFETY WARNING:- DO NOT USE HH PADS ON REAR UNLESS ALSO USED ON FRONT TO AVOID BRAKE IMBALANCE**

FRONT: SUZUKI



SUZUKI



APPLICATIONS

BRAKE

⊛ This symbol indicates a rotor made of billet steel, and should be only used with EBC FA Organic or Vee pads.
SAFETY NOTICE - With vehicles primarily designed for off highway use such as quads now being used on the highway, we would recommend the use of X or MXS pads for highway use and ONLY using the R and SV higher density / harder pad series for off road riding.

Model	Side	Year
GS 500	Left	1996-2003
	Right	
GS 500	Left	2004-2010
	Right	
GS 500 GM51A	Left	1989-1995
	Right	
GT 500 Titan		1976-1977
LT 500		1987-1990
LT-A 500 FK2 Vinson 4WD		2002-2007
LT-A 500 FY1FK1 Quadmaster	Left	2000-2001
	Right	
LT-A 500 King Quad AXi	Left	2009
	Right	
LT-A 500 King Quad AXi	Left	2009-2016
	Right	
LT-A 500 King Quad AXi	Left	2009-2022
	Right	
LT-A 500 King Quad AXi	Left	2011-2022
	Right	
LT-A 500 King Quad AXi	Left	2013
	Right	
LT-A 500 King Quad AXi Camo	Left	2011-2016
	Right	
LT-A 500 Vinson 4WD		2003-2007
LT-F 500 Quadranner	Left	1998-2002
	Right	
LT-F 500 Vinson Quadranner		2003-2007
RE 5 MIA Rotary		1977
RM 500		1983-1984
SP 500		1981-1983
T 500 1 Cobra		1968
T 500 Titan		1969-1975
GS 550		1977
GS 550		1977-1979
GS 550		1983-1986
GS 550		1983-1986
GS 550 ET		1980
GS 550 LT		1980
GS 550 LX		1981
GS 550 LZ		1982
GS 550 MZ		1982
GS 550 TX		1981
GT 550 AIB Indy		1976-1977
GT 550 B Indy		1977
GT 550 Indy		1973-1975
GT 550 J Indy		1972
GSF 600 Bandit	Left	2000-2003
	Right	
GSF 600 Bandit		1996-1998
GSX 600 FJ Katana		1988
GSX 600 Katana		1989-1997
GSX 600 Katana	Left	1998-2002
	Right	
GSX 600 Katana	Left	2003-2006
	Right	
GSX-R 600		1992-1993

FRONT

DISC PAD CHOICES - FRONT							BRAKE ROTOR CHOICES - FRONT			
FA/SFA/X Pad or Brake Shoe	Specialty Pads SXR/VEE/MXS Race	Sintered/HH Pads/Grooved Shoes	EPFA Sintered Fast Road/Track Pads	GPFAX Sintered RACE ONLY Pads	SV Series Severe Duty Pads	Standard Rotor Left	Standard Rotor Right	Vintage Rotor / UTV Oversize Brake Kit	Contour Profile Rotor	
FA231		FA231HH							MD3006XC	
							MD3006X		MD3006XC	
FA231		FA231HH							MD3006XC	
							MD3006X			
FA129		FA129HH							MD3006XC	
							MD3006X			
FA55							MD3019RS	VMD3019		
FA128*		FA128*			FA128SV*	MD6022D	MD6022D			
FA54X*		FA54R*			FA54SV*	MD6195D	MD6195D			
FA165X		FA165R			FA165SV	MD6145D				
FA135X		FA135R			FA135SV		MD6145D			
FA413X		FA413R			FA413SV	MD6355D				
FA414X		FA414R			FA414SV		MD6355D			
FA413X		FA413R			FA413SV	MD6355D				
FA414X		FA414R			FA414SV		MD6355D			
FA413X		FA413R			FA413SV	MD6355D				
FA414X		FA414R			FA414SV		MD6355D			
FA413X		FA413R			FA413SV	MD6355D				
FA414X		FA414R			FA414SV		MD6355D			
FA413X		FA413R			FA413SV	MD6355D				
FA414X		FA414R			FA414SV		MD6355D			
FA413X		FA413R			FA413SV	MD6355D				
FA414X		FA414R			FA414SV		MD6355D			
FA413X		FA413R			FA413SV	MD6355D				
FA414X		FA414R			FA414SV		MD6355D			
FA413X		FA413R			FA413SV	MD6355D				
FA414X		FA414R			FA414SV		MD6355D			
FA54X*		FA54R*			FA54SV*	MD6195D	MD6195D			
FA165X		FA165R			FA165SV	MD6145D				
FA135X		FA135R			FA135SV		MD6145D			
FA54X*		FA54R*			FA54SV*	MD6195D	MD6195D	VMD3019*		
FA55*						MD3019LS	MD3019RS			
622		622G								
605		605G								
612										
612										
FA38	FA38V					MD3019LS		VMD3019		
FA38	FA38V					MD3020LS				
FA63		FA63HH				MD3014LS		VMD3014		
FA63*		FA63HH*				MD3024LS	MD3024RS			
FA65						MD3014LS		VMD3014		
FA65						MD3020LS				
FA65						MD3022LS				
FA65						MD3022LS				
FA65*						MD3014LS	MD3014RS	VMD3014*		
FA65						MD3022LS				
FA55							MD3019RS	VMD3019		
FA38	FA38V						MD3019RS	VMD3019		
FA55							MD3019RS	VMD3019		
FA229		FA229HH	EPFA229HH			MD3003X			MD3003XC*	
FA231		FA231HH	EPFA231HH				MD3003X		MD3003XC*	
FA142		FA142HH				MD3003X	MD3003X		MD3003XC*	
FA146*		FA146HH*				MD3001	MD3001			
FA146*		FA146HH*				MD3003X	MD3003X		MD3003XC*	
FA229		FA229HH	EPFA229HH			MD3003X			MD3003XC*	
FA231		FA231HH	EPFA231HH				MD3003X			
FA229		FA229HH	EPFA229HH			MD3090X			MD3090XC*	
FA231		FA231HH	EPFA231HH				MD3090X		MD3090XC*	
FA145*		FA145HH*	EPFA145HH*			MD3007X	MD3007X		MD3007XC*	

Line #
1
2
3
4
5
6
7
8
9
10
11
12
13
14
15
16
17
18
19
20
21
22
23
24
25
26
27
28
29
30
31
32
33
34
35
36
37
38
39
40
41
42
43
44
45
46
47
48
49
50
51
52
53
54
55
56

*-2 Sets Required. † For Vee disc colours add RED, BLU, GRN, GLD, ORG suffix to part number. **SAFETY WARNING:- DO NOT USE HH PADS ON REAR UNLESS ALSO USED ON FRONT TO AVOID BRAKE IMBALANCE**

FRONT: SUZUKI Cont'd

REAR: SUZUKI

Line #	BRAKE ROTOR CHOICES - FRONT					REAR	DISC PAD CHOICES - REAR					BRAKE ROTOR CHOICES - REAR				
	CX Extreme® /Vee-Rotor	OSX Series Oversize 280mm Rotor Kit	Relocating Bracket for Oversize Rotor	SMX Series Oversize 320mm Rotor Kit	Relocating Bracket for 320mm Rotor		Front Disc Bolt Kit	FA/SFA/X Pad or Brake Shoe	Specialty Pads SXR/ VEE/MXS Race	Sintered/ HH Pads/ Grooved Shoes	EPFA Sintered Fast Road/ Track Pads	SV Series Severe Duty Pads	Standard Rotor	Vintage Rotor / UTV Oversize Brake Kit	Contour Profile Rotor	CX Extreme® /Vee-Rotor
1	VR3006BLK						FA63		FA63HH			MD3002		MD3002C	VR3002	DB303/5
2						DB303/5	FA367X									
3	VR3006BLK						FA63		FA63HH			MD3002		MD3002C	VR3002	DB303/5
4						DB303/5	FA367X									
5	VR3006BLK						FA63		FA63HH			MD3002		MD3002C	VR3002	DB303/5
6						DB303/5	FA367X									
7							609									
8							FA137X		FA137R		FA137SV	MD6023D				
9							FA317X		FA317R		FA317SV	MD6196D				
10							634		634G							
11																
12																
13																
14																
15																
16																
17																
18																
19																
20																
21																
22																
23																
24							FA372X		FA372R		FA372SV	MD6196D				
25							634		634G							
26																
27							FA372X		FA372R		FA372SV	MD6196D				
28							634									
29							618		618G							
30							605		605G							
31							609									
32							609									
33							611									
34							FA36					MD3014RS	VMD3014			
35							606		606G							
36							FA63		FA63HH			MD3025				
37							FA36					MD3014RS	VMD3014			
38							FA36					MD3014RS	VMD3014			
39							FA36					MD3014RS	VMD3014			
40							611									
41							FA36					MD3014RS	VMD3014			
42							FA36					MD3014RS	VMD3014			
43							611									
44							611									
45							609									
46							609									
47	VR3003BLK*†					DB303/5	FA63		FA63HH			MD3008		MD3008C	VR3008	DB303/5
48																
49	VR3003BLK*†					DB303/5	FA63		FA63HH			MD3008		MD3008C	VR3008	DB303/5
50							FA63		FA63HH			MD3002		MD3002C	VR3002	DB303/5
51	VR3003BLK*†					DB303/5	FA63		FA63HH			MD3002		MD3002C	VR3002	DB303/5
52	VR3003BLK*†					DB303/5	FA63		FA63HH			MD3008		MD3008C	VR3008	DB303/5
53																
54	VR3090BLK*†					DB302/5	FA63		FA63HH			MD3008		MD3008C	VR3008	DB303/5
55																
56	VR3007BLK*†					DB303/5	FA63		FA63HH			MD3008		MD3008C	VR3008	DB303/5

BRAKE APPLICATIONS

⊛ This symbol indicates a rotor made of billet steel, and should be only used with EBC FA Organic or Vee pads. SAFETY NOTICE - With vehicles primarily designed for off highway use such as quads now being used on the highway, we would recommend the use of X or MXS pads for highway use and ONLY using the R and SV higher density / harder pad series for off road riding.

*-2 Sets Required. † For Vee disc colours add RED, BLU, GRN, GLD, ORG suffix to part number. **SAFETY WARNING:- DO NOT USE HH PADS ON REAR UNLESS ALSO USED ON FRONT TO AVOID BRAKE IMBALANCE**

FRONT: SUZUKI



SUZUKI



DISC PAD CHOICES - FRONT

BRAKE ROTOR CHOICES - FRONT

Model	Year	FA/SFA/X Pad or Brake Shoe	Specialty Pads SXR/ VEE/MXS Race	Sintered/ HH Pads/ Grooved Shoes	EPFA Sintered Fast Road/Track Pads	GPFAX Sintered RACE ONLY Pads	SV Series Severe Duty Pads	Standard Rotor		Vintage Rotor / UTV Oversize Brake Kit	Contour Profile Rotor	Line #
								Standard Rotor Left	Standard Rotor Right			
GSX-R 600	1997-2003	FA158*		FA158HH*	EPFA158HH*			MD3058X	MD3058X		MD3058XC*	1
GSX-R 600	2004-2005			FA379HH*	EPFA379HH*	GPFAX379HH*		MD3104X	MD3104X		MD3104XC*	2
GSX-R 600	2006-2007			FA379HH*	EPFA379HH*	GPFAX379HH*		MD3091X	MD3091X		MD3091XC*	3
GSX-R 600	2008-2010			FA379HH*	EPFA379HH*	GPFAX379HH*		MD3100X	MD3100X		MD3100XC*	4
GSX-R 600	2018-2023			FA447HH*	EPFA447HH*	GPFAX447HH*		MD3100X	MD3100X		MD3100XC*	5
GSX-R 600 100th Anniversary	2021-2024			FA447HH*	EPFA447HH*	GPFAX447HH*		MD3100X	MD3100X		MD3100XC*	6
RF 600 GN76A	1994-1997	FA142*		FA142HH*				MD3003X	MD3003X		MD3003XC*	7
SP 600 F	1985-1987	FA106/2X		FA106/2R				MD6075D				8
QUV 620 FK5 Side x Side	2005	719*										9
AN 650 Burgman	2004-2012	SFA142*		SFA142HH*				MD994D	MD994D			10
AN 650 Burgman	2004-2012	SFA142*		SFA142HH*				MD994D	MD994D			11
AN 650 Burgman	2013-2016	SFA142*		SFA142HH*				MD9144D	MD9144D			12
AN 650 Burgman Executive	2013-2019	SFA142*		SFA142HH*				MD9144D	MD9144D			13
AN 650 K3 Burgman	2003	SFA142*		SFA142HH*				MD987D	MD987D			14
DL 650 V-Strom	Left 2001-2024	FA229		FA229HH	EPFA229HH			MD3092X			MD3092XC*	15
	Right	FA231		FA231HH	EPFA231HH				MD3092X			16
DL 650 V-Strom	Left 2004-2006	FA229		FA229HH	EPFA229HH			MD3088X			MD3088XC*	17
	Right	FA231		FA231HH	EPFA231HH				MD3088X			18
DL 650 V-Strom	Left 2007-2009	FA229		FA229HH	EPFA229HH			MD3092X			MD3092XC*	19
	Right	FA231		FA231HH	EPFA231HH				MD3092X			20
DL 650 V-Strom XT Adventure	Left 2012-2024	FA229		FA229HH	EPFA229HH			MD3092X			MD3092XC*	21
	Right	FA231		FA231HH	EPFA231HH				MD3092X			22
DL 650 XT V-Strom	Left 2015-2024	FA229		FA229HH	EPFA229HH			MD3092X			MD3092XC*	23
	Right	FA231		FA231HH	EPFA231HH				MD3092X			24
DR 650	1990-1991	FA147X		FA147R				MD6076D				25
DR 650	1992-1995	FA147X		FA147R				MD6078D				26
DR 650 S-SE	1996-2024	FA185X	MXS185	FA185R	EPFA185HH			MD6094D				27
GR 650 Tempter	1983	FA65	FA65V					MD3014LS		VMD3014		28
GS 650	1981-1982	FA65*	FA65V*					MD3014LS	MD3014RS	VMD3014*		29
GS 650	1981-1983	FA65*	FA65V*					MD3014LS	MD3014RS	VMD3014*		30
GS 650	1981-1983	FA65	FA65V					MD3022LS				31
GS 650 MD	1983	FA65*	FA65V*					MD3014LS	MD3014RS	VMD3014*		32
GSX 650	2008-2010	FA158*		FA158HH*	EPFA158HH*			MD3092X	MD3092X		MD3092XC*	33
LS 650 Boulevard S40	2005-2015	FA106	FA106V					MD3017LS				34
LS 650 Savage	1986-1988	FA106	FA106V					MD3017LS				35
LS 650 Savage	1995-2004	FA106	FA106V					MD3017LS				36
SFV 650	Left 2009-2010	FA229		FA229HH	EPFA229HH			MD3103X			MD3103XC*	37
	Right	FA231		FA231HH	EPFA231HH				MD3103X			38
SFV 650	Left 2013-2015	FA229		FA229HH	EPFA229HH			MD3103X			MD3103XC*	39
	Right	FA231		FA231HH	EPFA231HH				MD3103X			40
SV 650	Left 1999-2002	FA229		FA229HH	EPFA229HH			MD3003X			MD3003XC*	41
	Right	FA231		FA231HH	EPFA231HH				MD3003X			42
SV 650	Left 2003-2010	FA229		FA229HH	EPFA229HH			MD3090X			MD3090XC*	43
	Right	FA231		FA231HH	EPFA231HH				MD3090X			44
SV 650	Left 2007-2010	FA229		FA229HH	EPFA229HH			MD3103X			MD3103XC*	45
	Right	FA231		FA231HH	EPFA231HH				MD3103X			46
SV 650	Left 2007-2010	FA229		FA229HH	EPFA229HH			MD3103X			MD3103XC*	47
	Right	FA231		FA231HH	EPFA231HH				MD3103X			48
SV 650	Left 2016-2021	FA229		FA229HH	EPFA229HH			MD3103X			MD3103XC*	49
	Right	FA231		FA231HH	EPFA231HH				MD3103X			50
SV 650	2019-2024	FA158*		FA158HH*	EPFA158HH*			MD3103X	MD3103X		MD3103XC*	51
SV 650 A	Left 2016-2018	FA229		FA229HH	EPFA229HH			MD3103X			MD3103XC*	52
	Right	FA231		FA231HH	EPFA231HH				MD3103X			53
SV 650 X	Left 2016-2018	FA229		FA229HH	EPFA229HH			MD3103X			MD3103XC*	54
	Right	FA231		FA231HH	EPFA231HH				MD3103X			55
SV 650 X	2019-2022	FA158*		FA158HH*	EPFA158HH*			MD3103X	MD3103X		MD3103XC*	56

APPLICATIONS
BRAKE

⚠ This symbol indicates a rotor made of billet steel, and should be only used with EBC FA Organic or Vee pads.
SAFETY NOTICE - With vehicles primarily designed for off highway use such as quads now being used on the highway, we would recommend the use of X or MXS pads for highway use and ONLY using the R and SV higher density / harder pad series for off road riding.

*-2 Sets Required. † For Vee disc colours add RED, BLU, GRN, GLD, ORG suffix to part number. SAFETY WARNING:- DO NOT USE HH PADS ON REAR UNLESS ALSO USED ON FRONT TO AVOID BRAKE IMBALANCE

FRONT: SUZUKI Cont'd

REAR: SUZUKI

Line #	BRAKE ROTOR CHOICES - FRONT					DISC PAD CHOICES - REAR						BRAKE ROTOR CHOICES - REAR				
	CX Extreme® /Vee-Rotor	OSX Series Oversize 280mm Rotor Kit	Relocating Bracket for Oversize Rotor	SMX Series Oversize 320mm Rotor Kit	Relocating Bracket for 320mm Rotor	Front Disc Bolt Kit	FA/SFA/X Pad or Brake Shoe	Specialty Pads SXR/ VEE/MXS Race	Sintered/ HH Pads/ Grooved Shoes	EPFA Sintered Fast Road/ Track Pads	SV Series Severe Duty Pads	Standard Rotor	Vintage Rotor / UTV Oversize Brake Kit	Contour Profile Rotor	CX Extreme® /Vee-Rotor	Rear Disc Bolt Kit
1	VR3058BLK*†					DB303/5	FA63		FA63HH			MD3060		MD3060C	VR3060	DB303/5
2	VR3104BLK*†					DB303/5	FA254		FA254HH			MD3060		MD3060C	VR3060	DB303/5
3	VR3091BLK*†					DB302/5	FA419		FA419HH			MD3060		MD3060C	VR3060	DB303/5
4	VR3100BLK*†						FA419		FA419HH			MD3060		MD3060C	VR3060	DB303/5
5	VR3100BLK*†						FA436		FA436HH			MD3060		MD3060C	VR3060	DB303/5
6	VR3100BLK*†						FA436		FA436HH			MD3060		MD3060C	VR3060	DB303/5
7	VR3003BLK*†					DB303/5	FA63		FA63HH			MD3008		MD3008C	VR3008	DB303/5
8							602		602G							
9							720*									
10	VR994*						SFA412		SFA412HH			MD998D			VR998	
11	VR994*						SFA412		SFA412HH			MD998D			VR998	
12	VR9144BLK*†						SFA412		SFA412HH			MD998D			VR998	
13	VR9144BLK*†						SFA412		SFA412HH			MD998D			VR998	
14	VR987*						SFA412		SFA412HH			MD988D			VR988	
15	VR3092BLK*†					DB302/5	FA174		FA174HH			MD6232D		MD6232CX		DB302/4
16																
17	VR3088BLK*†					DB302/5	FA174		FA174HH			MD6232D		MD6232CX		DB302/4
18																
19	VR3092BLK*†					DB302/5	FA174		FA174HH			MD6232D		MD6232CX		DB302/4
20																
21	VR3092BLK*†					DB302/5	FA174		FA174HH			MD6232D		MD6232CX		DB302/4
22																
23	VR3092BLK*†					DB302/5	FA174		FA174HH			MD6232D		MD6232CX		DB302/4
24																
25							FA157X		FA157R			MD6077D				
26							FA157X		FA157R			MD6077D				
27	MD6094CX			SMX6094	BRK003		FA152X	MXS152	FA152R			MD6095D		MD6095CX		
28							606		606G							
29							FA36					MD3027				
30							FA36					MD3027				
31							FA36					MD3027				
32							FA36					MD3027				
33	VR3092BLK*†					DB302/5	FA174		FA174HH			MD3093	MD3093C	VR3093		DB303/5
34							606		606G							
35							606		606G							
36							606		606G							
37						DB302/5	FA496		FA496HH			MD3093		MD3093C		DB303/5
38						DB302/5										
39						DB302/5	FA496		FA496HH			MD3093		MD3093C		DB303/5
40						DB302/5										
41	VR3003BLK*†					DB302/5	FA63		FA63HH			MD3008		MD3008C	VR3008	DB303/5
42						DB302/5										
43	VR3090BLK*†					DB302/5	FA174		FA174HH			MD3060		MD3060C	VR3060	DB303/5
44						DB302/5										
45						DB302/5	FA174		FA174HH			MD3093		MD3093C		DB303/5
46						DB302/5										
47						DB302/5	FA174		FA174HH			MD3093		MD3093C		DB303/5
48						DB302/5										
49						DB302/5	FA496		FA496HH			MD3093		MD3093C		DB303/5
50						DB302/5										
51						DB302/5	FA496		FA496HH			MD3093		MD3093C		DB303/5
52						DB302/5	FA496		FA496HH			MD3093		MD3093C		DB303/5
53						DB302/5										
54						DB302/5	FA496		FA496HH			MD3093		MD3093C		DB303/5
55						DB302/5										
56						DB302/5	FA496		FA496HH			MD3093		MD3093C		DB303/5

BRAKE APPLICATIONS
⚠ This symbol indicates a rotor made of billet steel, and should be only used with EBC FA Organic or Vee pads.
SAFETY NOTICE - With vehicles primarily designed for off highway use such as quads now being used on the highway, we would recommend the use of X or MXS pads for highway use and ONLY using the R and SV higher density / harder pad series for off road riding.

*-2 Sets Required. † For Vee disc colours add RED, BLU, GRN, GLD, ORG suffix to part number. **SAFETY WARNING:- DO NOT USE HH PADS ON REAR UNLESS ALSO USED ON FRONT TO AVOID BRAKE IMBALANCE**

FRONT: SUZUKI

APPLICATIONS

BRAKE



SUZUKI



Model	Side	Year Range
GS 700		1985
GV 700		1985
LT-A 700 King Quad	Left	2005-2007
	Right	
LT-V 700 Twin Peaks 700 4x4	Left	2004-2005
	Right	
VS 700		1986-1987
VS 700		1986-1987
VS 700		1986-1987
GS 750		1978-1979
GS 750		1978-1979
GS 750		1980-1982
GS 750		1980-1981
GS 750		1982-1983
GS 750		1983
GS 750 B		1977
GS 750 LN		1979
GS 750 SD		1983
GSR 750	Left	2015-2016
	Right	
GSR 750	Left	2015-2016
	Right	
GSX 750 Katana	Left	1998-2002
	Right	
GSX 750 Katana		1989-1997
GSX 750 Katana	Left	2003-2006
	Right	
GSX-R 750		1988-1993
GSX-R 750		2018-2020
GSX-R 750 100th Anniversary		2021-2024
GSX-R 750 GR75A		1986-1987
GSX-R 750 K		2004-2005
GSX-R 750 K		2006-2007
GSX-R 750 KIL		2008-2010
GSX-R 750 SRAD		1996-1999
GSX-R 750 W		1994-1995
GSX-R 750 YIK		2000-2003
GSX-S 750	Left	2015-2018
	Right	
GSX-S 750	Left	2015-2018
	Right	
GSX-S 750 A		2018-2024
GSX-S 750 Y		2018-2021
GSX-S 750 Z		2018-2024
GSX-S 750 ZL		2018-2021
GT 750		1973-1977
GT 750 J LE Mans		1972
LT-A 750 King Quad 750 AXI	Left	2008-2022
	Right	
LT-A 750 King Quad 750 Axi	Left	2009
	Right	
LT-A 750 King Quad 750 AXI	Left	2015-2016
	Right	
LT-A 750 King Quad 750 AXI Camo	Left	2008-2016
	Right	

FRONT

DISC PAD CHOICES - FRONT							BRAKE ROTOR CHOICES - FRONT				Line #
FA/SFA/X Pad or Brake Shoe	Specialty Pads SXR/VEE/MXS Race	Sintered/HH Pads/Grooved Shoes	EPFA Sintered Fast Road/Track Pads	GPFAX Sintered RACE ONLY Pads	SV Series Severe Duty Pads	Standard Rotor Left	Standard Rotor Right	Vintage Rotor / UTV Oversize Brake Kit	Contour Profile Rotor	Line #	
FA51*	FA51V*					MD3028LS	MD3028RS			1	
FA51*	FA51V*					MD3030LS	MD3030RS			2	
FA413X		FA413R			FA413SV	MD6261D				3	
FA414X		FA414R			FA414SV		MD6261D			4	
		FA342R			FA342SV	MD6188D		UTVX6188*		5	
		FA349R			FA349SV		MD6188D			6	
FA103	FA103V	FA103HH				MD3073LS				7	
FA103	FA103V	FA103HH				MD3032LS				8	
FA103	FA103V	FA103HH				MD3031LS				9	
FA35						MD3020LS				10	
FA35*						MD3014LS	MD3014RS	VMD3014*		11	
FA51*	FA51V*					MD3014LS	MD3014RS	VMD3014*		12	
FA51*	FA51V*					MD3014LS	MD3014RS	VMD3014*		13	
FA51*	FA51V*					MD3022LS				14	
FA51*	FA51V*					MD3028LS	MD3028RS			15	
FA35						MD3019LS		VMD3019		16	
FA38*	FA38V*					MD3014LS	MD3014RS	VMD3014*		17	
FA65*	FA65V*					MD3014LS	MD3014RS	VMD3014*		18	
FA229		FA229HH	EPFA229HH			MD3092X			MD3092XC*	19	
FA231		FA231HH	EPFA231HH				MD3092X			20	
FA229		FA229HH	EPFA229HH			MD3092X			MD3092XC*	21	
FA231		FA231HH	EPFA231HH				MD3092X			22	
FA229		FA229HH	EPFA229HH			MD3003X			MD3003XC*	23	
FA231		FA231HH	EPFA231HH				MD3003X			24	
FA146*		FA146HH*				MD3003X	MD3003X		MD3003XC*	25	
FA229		FA229HH	EPFA229HH			MD3090X			MD3090XC*	26	
FA231		FA231HH	EPFA231HH				MD3090X			27	
FA145*		FA145HH*	EPFA145HH*			MD3007X	MD3007X		MD3007XC*	28	
		FA447HH*	EPFA447HH*	GPFAX447HH*		MD3100X	MD3100X		MD3100XC*	29	
		FA447HH*	EPFA447HH*	GPFAX447HH*		MD3100X	MD3100X		MD3100XC*	30	
FA103*		FA103HH				MD3005	MD3005			31	
		FA379HH*	EPFA379HH*	GPFAX379HH*		MD3104X	MD3104X		MD3104XC*	32	
		FA379HH*	EPFA379HH*	GPFAX379HH*		MD3091X	MD3091X		MD3091XC*	33	
		FA379HH*	EPFA379HH*	GPFAX379HH*		MD3100X	MD3100X		MD3100XC*	34	
FA188*		FA188HH*	EPFA188HH*			MD3058X	MD3058X		MD3058XC*	35	
FA188*		FA188HH*	EPFA188HH*			MD3007X	MD3007X		MD3007XC*	36	
FA158*		FA158HH*	EPFA158HH*			MD3058X	MD3058X		MD3058XC*	37	
FA229		FA229HH	EPFA229HH			MD3092X			MD3092XC*	38	
FA231		FA231HH	EPFA231HH				MD3092X			39	
FA229		FA229HH	EPFA229HH			MD3092X			MD3092XC*	40	
FA231		FA231HH	EPFA231HH				MD3092X			41	
		FA347HH*	EPFA347HH*			MD3092X	MD3092X		MD3092XC*	42	
		FA347HH*	EPFA347HH*			MD3092X	MD3092X		MD3092XC*	43	
		FA347HH*	EPFA347HH*			MD3092X	MD3092X		MD3092XC*	44	
		FA347HH*	EPFA347HH*			MD3092X	MD3092X		MD3092XC*	45	
FA55*						MD3019LS	MD3019RS	VMD3019*		46	
FA413X		FA413R			FA413SV	MD6261D				47	
FA414X		FA414R			FA414SV		MD6261D			48	
FA413X		FA413R			FA413SV	MD6355D				49	
FA414X		FA414R			FA414SV		MD6355D			50	
FA413X		FA413R			FA413SV	MD6355D				51	
FA414X		FA414R			FA414SV		MD6355D			52	
FA413X		FA413R			FA413SV	MD6261D				53	
FA414X		FA414R			FA414SV		MD6261D			54	
FA413X		FA413R			FA413SV	MD6261D				55	
FA414X		FA414R			FA414SV		MD6261D			56	

*-2 Sets Required. † For Vee disc colours add RED, BLU, GRN, GLD, ORG suffix to part number. **SAFETY WARNING:- DO NOT USE HH PADS ON REAR UNLESS ALSO USED ON FRONT TO AVOID BRAKE IMBALANCE**

This symbol indicates a rotor made of billet steel, and should be only used with EBC FA Organic or Vee pads.
 SAFETY NOTICE - With vehicles primarily designed for off highway use such as quads now being used on the highway, we would recommend the use of X or MXS pads for highway use and ONLY using the R and SV higher density / harder pad series for off road riding.

FRONT: SUZUKI Cont'd

REAR: SUZUKI

Line #	BRAKE ROTOR CHOICES - FRONT					DISC PAD CHOICES - REAR					BRAKE ROTOR CHOICES - REAR					
	CX Extreme® /Vee-Rotor	OSX Series Oversize 280mm Rotor Kit	Relocating Bracket for Oversize Rotor	SMX Series Oversize 320mm Rotor Kit	Relocating Bracket for 320mm Rotor	Front Disc Bolt Kit	FA/SFA/X Pad or Brake Shoe	Specialty Pads SXR/ VEE/MXS Race	Sintered/ HH Pads/ Grooved Shoes	EPFA Sintered Fast Road/ Track Pads	SV Series Severe Duty Pads	Standard Rotor	Vintage Rotor / UTV Oversize Brake Kit	Contour Profile Rotor	CX Extreme® /Vee-Rotor	Rear Disc Bolt Kit
1							FA36					MD3029				
2							626									
3																
4																
5																
6																
7							626									
8							626									
9							626									
10							FA36					MD3014RS	VMD3014			
11							FA36					MD3014RS	VMD3014			
12							FA36					MD3014RS	VMD3014			
13							FA36					MD3014RS	VMD3014			
14							634									
15							FA36					MD3029				
16							FA36					MD3019RS	VMD3019			
17							FA36					MD3014RS	VMD3014			
18							FA36					MD3014RS	VMD3014			
19	VR3092BLK*†					DB302/5										DB303/5
20						DB302/5	FA174	FA174HH				MD3093	MD3093C	VR3093		DB303/5
21	VR3092BLK*†					DB302/5										DB303/5
22						DB302/5	FA174	FA174HH				MD3093	MD3093C	VR3093		DB303/5
23	VR3003BLK*†					DB303/5	FA63	FA63HH				MD3008	MD3008C	VR3008		DB303/5
24						DB303/5										
25	VR3003BLK*†					DB303/5	FA63	FA63HH				MD3002	MD3002C	VR3002		DB303/5
26	VR3090BLK*†					DB302/5	FA63	FA63HH				MD3008	MD3008C	VR3008		DB303/5
27																
28	VR3007BLK*†					DB303/5	FA63	FA63HH				MD3008	MD3008C	VR3008		DB303/5
29	VR3100BLK*†						FA436	FA436HH				MD3060	MD3060C	VR3060		DB303/5
30	VR3100BLK*†						FA436	FA436HH				MD3060	MD3060C	VR3060		DB303/5
31							FA63	FA63HH				MD3009				
32	VR3104BLK*†					DB303/5	FA254	FA254HH				MD3060	MD3060C	VR3060		DB303/5
33	VR3091BLK*†					DB302/5	FA419	FA419HH				MD3060	MD3060C	VR3060		DB303/5
34	VR3100BLK*†						FA419	FA419HH				MD3060	MD3060C	VR3060		DB303/5
35	VR3058BLK*†					DB303/5	FA63	FA63HH				MD3060	MD3060C	VR3060		DB303/5
36	VR3007BLK*†					DB303/5	FA63	FA63HH				MD3008	MD3008C	VR3008		DB303/5
37	VR3058BLK*†					DB303/5	FA63	FA63HH				MD3060	MD3060C	VR3060		DB303/5
38	VR3092BLK*†					DB302/5	FA174	FA174HH				MD3093	MD3093C	VR3093		DB303/5
39																
40	VR3092BLK*†					DB302/5	FA174	FA174HH				MD3093	MD3093C	VR3093		DB303/5
41																
42						DB302/5	FA174	FA174HH				MD3093				DB303/5
43						DB302/5	FA174	FA174HH				MD3093				DB303/5
44						DB302/5	FA174	FA174HH				MD3093				DB303/5
45						DB302/5	FA174	FA174HH				MD3093				DB303/5
46							634									
47							634									
48																
49																
50																
51																
52																
53																
54																
55																
56																

⚠ This symbol indicates a rotor made of billet steel, and should be only used with EBC FA Organic or Vee pads.
SAFETY NOTICE - With vehicles primarily designed for off highway use such as quads now being used on the highway, we would recommend the use of X or MXS pads for highway use and ONLY using the R and SV higher density / harder pad series for off road riding.

*-2 Sets Required. † For Vee disc colours add RED, BLU, GRN, GLD, ORG suffix to part number. **SAFETY WARNING:- DO NOT USE HH PADS ON REAR UNLESS ALSO USED ON FRONT TO AVOID BRAKE IMBALANCE**

FRONT: SUZUKI



SUZUKI



DISC PAD CHOICES - FRONT

BRAKE ROTOR CHOICES - FRONT

Model	Side	Year	FA/SFA/X Pad or Brake Shoe	Specialty Pads SXR/ VEE/MXS Race	Sintered/ HH Pads/ Grooved Shoes	EPFA Sintered Fast Road/Track Pads	GPFAX Sintered RACE ONLY Pads	SV Series Severe Duty Pads	Standard Rotor Left	Standard Rotor Right	Vintage Rotor / UTV Oversize Brake Kit	Contour Profile Rotor	Line #
			FA/SFA/X Pad or Brake Shoe	Specialty Pads SXR/ VEE/MXS Race	Sintered/ HH Pads/ Grooved Shoes	EPFA Sintered Fast Road/Track Pads	GPFAX Sintered RACE ONLY Pads	SV Series Severe Duty Pads	Standard Rotor Left	Standard Rotor Right	Vintage Rotor / UTV Oversize Brake Kit	Contour Profile Rotor	
LT-A 750 King Quad 750 AXi Limited	Left	2008-2009	FA413X		FA413R			FA413SV	MD6261D				1
	Right		FA414X		FA414R			FA414SV		MD6261D			2
LT-A 750 King Quad 750 AXi Limited	Left	2014	FA413X		FA413R			FA413SV	MD6261D				3
	Right		FA414X		FA414R			FA414SV		MD6261D			4
LT-A 750 King Quad 750 AXi Power Steering	Left	2009-2016	FA413X		FA413R			FA413SV	MD6355D				5
	Right		FA414X		FA414R			FA414SV		MD6355D			6
LT-A 750 King Quad 750 AXi	Left	2009-2022	FA413X		FA413R			FA413SV	MD6355D				7
	Right		FA414X		FA414R			FA414SV		MD6355D			8
LT-A 750 XRK9 King Quad 750 AXi Rockstar Edition	Left	2009	FA413X		FA413R			FA413SV	MD6355D				9
	Right		FA414X		FA414R			FA414SV		MD6355D			10
VS 750 Intruder		1988-1991	FA103	FA103V	FA103HH					MD3032RS			11
DL 800DE V-Strom		2023-2024	FA226*		FA226HH*				MD3092X	MD3092X		MD3092XC*	12
DL 800DE V-Strom Adventure		2023-2024	FA226*		FA226HH*				MD3092X	MD3092X		MD3092XC*	13
GSX-8S		2022-2024			FA347HH*	EPFA347HH*			MD3092X	MD3092X			14
VL 800 Boulevard Tourer		2005-2023	FA231	FA231V	FA231HH	EPFA231HH				MD3095RS			15
VL 800 BTL4		2014	FA231	FA231V	FA231HH	EPFA231HH				MD3095RS			16
VL 800 C50 Boulevard		2005-2023	FA231	FA231V	FA231HH	EPFA231HH				MD3095RS			17
VL 800 CL3		2013	FA231	FA231V	FA231HH	EPFA231HH				MD3095RS			18
VL 800 Intruder Volusia		2001-2004	FA231	FA231V	FA231HH	EPFA231HH				MD3095RS			19
VL 800 Intruder Volusia		2003-2004	FA231	FA231V	FA231HH	EPFA231HH				MD3095RS			20
VS 800 Boulevard		2005-2009	FA103	FA103V	FA103HH					MD3032RS			21
VS 800 Intruder		1992-2004	FA103	FA103V	FA103HH					MD3032RS			22
VX 800		1990-1993	FA129	FA129V	FA129HH	EPFA129HH			MD3033LS				23
VZ 800 Boulevard		2005-2010	FA231	FA231V	FA231HH	EPFA231HH				MD3096RS			24
VZ 800 Marauder		1997-2004	FA231	FA231V	FA231HH	EPFA231HH				MD3045			25
GS 850		1980-1981	FA51*	FA51V*					MD3014LS	MD3014RS	VMD3014*		26
GS 850		1980-1983	FA51*	FA51V*					MD3014LS	MD3014RS	VMD3014*		27
GS 850 GN		1979	FA35*						MD3014LS	MD3014RS	VMD3014*		28
DL 900 Migrator 900		2014-2017	FA229		FA229HH				MD3014LS				29
RF 900 R		1994-1995	FA145*		FA145HH*	EPFA145HH*			MD3006X	MD3006X		MD3006XC*	30
RF 900 R		1996-1998	FA145*		FA145HH*	EPFA145HH*			MD3006X	MD3006X		MD3006XC*	31
DL 1000 AL2 V-Strom Adventure	Left	2012	FA229		FA229HH	EPFA229HH			MD3088X			MD3088XC*	32
	Right		FA231		FA231HH	EPFA231HH				MD3088X			33
DL 1000 V-Strom	Left	2002-2012	FA229		FA229HH	EPFA229HH			MD3088X			MD3088XC*	34
	Right		FA231		FA231HH	EPFA231HH				MD3088X			35
DL 1000 V-Strom		2014-2020			FA379HH*	EPFA379HH*			MD3092X	MD3092X		MD3092XC*	36
DL 1000 V-Strom Adventure		2014-2019			FA379HH*	EPFA379HH*			MD3092X	MD3092X		MD3092XC*	37
GS 1000		1978-1979	FA38	FA38V					MD3020LS				38
GS 1000		1978-1979	FA38*	FA38V*					MD3014LS	MD3014RS	VMD3014*		39
GS 1000		1980-1982	FA65*						MD3014LS	MD3014RS	VMD3014*		40
GS 1000		1980-1981	FA51*						MD3014LS	MD3014RS	VMD3014*		41
GS 1000		1980-1981	FA51*						MD3014LS	MD3014RS	VMD3014*		42
GSX 1000 Katana		2019-2022			FA447HH*	EPFA447HH*	GPFAX447HH*						43
GSX-R 1000		2012-2016			FA447HH*	EPFA447HH*	GPFAX447HH*		MD3102X	MD3102X		MD3102XC*	44
GSX-R 1000		2015-2016			FA447HH*	EPFA447HH*	GPFAX447HH*		MD3102X	MD3102X		MD3102XC*	45
GSX-R 1000		2018-2020			FA447HH*	EPFA447HH*	GPFAX447HH*		MD3107X	MD3107X		MD3107XC*	46
GSX-R 1000 100th Anniversary		2021-2022			FA447HH*	EPFA447HH*	GPFAX447HH*		MD3107X	MD3107X		MD3107XC*	47
GSX-R 1000 A		2017-2024			FA447HH*	EPFA447HH*	GPFAX447HH*		MD3107X	MD3107X		MD3107XC*	48
GSX-R 1000 K1IK2		2001-2002	FA188*		FA188HH*	EPFA188HH*			MD3058X	MD3058X		MD3058XC*	49
GSX-R 1000 K3		2003			FA369/4HH*	EPFA369/4HH*			MD3089X	MD3089X		MD3089XC*	50
GSX-R 1000 K4		2004			FA379HH*	EPFA379HH*	GPFAX379HH*		MD3104X	MD3104X		MD3104XC*	51
GSX-R 1000 K5IK6		2005-2006			FA379HH*	EPFA379HH*	GPFAX379HH*		MD3091X	MD3091X		MD3091XC*	52
GSX-R 1000 K7IK8		2007-2008			FA379HH*	EPFA379HH*	GPFAX379HH*		MD3091X	MD3091X		MD3091XC*	53
GSX-R 1000 L		2009-2011			FA379HH*	EPFA379HH*	GPFAX379HH*		MD3102X	MD3102X		MD3102XC*	54
GSX-R 1000 R		2017-2024			FA447HH*	EPFA447HH*	GPFAX447HH*		MD3107X	MD3107X		MD3107XC*	55
GSX-R 1000 R 100th Anniversary		2021			FA447HH*	EPFA447HH*	GPFAX447HH*		MD3107X	MD3107X		MD3107XC*	56

APPLICATIONS

BRAKE

⚡ This symbol indicates a rotor made of billet steel, and should be only used with EBC FA Organic or Vee pads. SAFETY NOTICE - With vehicles primarily designed for off highway use such as quads now being used on the highway, we would recommend the use of X or MXS pads for highway use and ONLY using the R and SV higher density / harder pad series for off road riding.

*-2 Sets Required. † For Vee disc colours add RED, BLU, GRN, GLD, ORG suffix to part number. SAFETY WARNING:- DO NOT USE HH PADS ON REAR UNLESS ALSO USED ON FRONT TO AVOID BRAKE IMBALANCE

FRONT: SUZUKI Cont'd

REAR: SUZUKI

Line #	BRAKE ROTOR CHOICES - FRONT					REAR	DISC PAD CHOICES - REAR					BRAKE ROTOR CHOICES - REAR				
	CX Extreme® /Vee-Rotor	OSX Series Oversize 280mm Rotor Kit	Relocating Bracket for Oversize Rotor	SMX Series Oversize 320mm Rotor Kit	Relocating Bracket for 320mm Rotor		Front Disc Bolt Kit	FA/SFA/X Pad or Brake Shoe	Specialty Pads SXR/ VEE/MXS Race	Sintered/ HH Pads/ Grooved Shoes	EPFA Sintered Fast Road/ Track Pads	SV Series Severe Duty Pads	Standard Rotor	Vintage Rotor / UTV Oversize Brake Kit	Contour Profile Rotor	CX Extreme® /Vee-Rotor
1																
2																
3																
4																
5																
6																
7																
8																
9																
10																
11																
12	VR3092BLK*†					DB302/5	626									
13	VR3092BLK*†					DB302/5	FA174		FA174HH			MD6232D			MD6232CX	DB302/4
14						DB302/5	FA174		FA174HH			MD6232D			MD6232CX	DB302/4
15							626									
16							626									
17							626									
18							626									
19							626									
20							626									
21							626									
22							626									
23							FA146		FA146HH			MD3061				
24							626									
25							626									
26							FA36					MD3014RS	VMD3014			
27							FA36					MD3027				
28							FA36					MD3014RS	VMD3014			
29							FA174		FA174HH			MD6232D				DB302/4
30	VR3006BLK*†					DB303/5	FA222					MD3008		MD3008C	VR3008	DB303/5
31	VR3006BLK*†					DB303/5	FA63					MD3008		MD3008C	VR3008	DB303/5
32	VR3088BLK*†					DB302/5	FA174		FA174HH			MD6232D			MD6232CX	DB302/4
33						DB302/5										
34	VR3088BLK*†					DB302/5	FA174		FA174HH			MD6232D			MD6232CX	DB302/4
35						DB302/5										
36						DB302/5	FA419		FA419HH			MD6232D			MD6232CX	DB302/4
37						DB302/5	FA419		FA419HH			MD6232D			MD6232CX	DB302/4
38							FA36					MD3014RS	VMD3014			
39							FA36					MD3014RS	VMD3014			
40							FA36					MD3014RS	VMD3014			
41							FA36					MD3014RS	VMD3014			
42							FA36					MD3014RS	VMD3014			
43							FA436		FA436HH							
44	VR3102BLK*†						FA436		FA436HH			MD3060		MD3060C	VR3060	DB303/5
45	VR3102BLK*†						FA436		FA436HH			MD3106		MD3106C	VR3106	
46	VR3107BLK*†						FA436		FA436HH			MD3106		MD3106C	VR3106	
47	VR3107BLK*†						FA436		FA436HH			MD3106		MD3106C	VR3106	
48	VR3107BLK*†						FA436		FA436HH			MD3106		MD3106C	VR3106	
49	VR3058BLK*†					DB303/5	FA254		FA254HH			MD3060		MD3060C	VR3060	DB303/5
50	VR3089BLK*†						FA254		FA254HH			MD3060		MD3060C	VR3060	DB303/5
51	VR3104BLK*†					DB303/5	FA254		FA254HH			MD3060		MD3060C	VR3060	DB303/5
52	VR3091BLK*†					DB302/5	FA254		FA254HH			MD3060		MD3060C	VR3060	DB303/5
53	VR3091BLK*†					DB302/5	FA419		FA419HH			MD3060		MD3060C	VR3060	DB303/5
54	VR3102BLK*†						FA436		FA436HH			MD3060		MD3060C	VR3060	DB303/5
55	VR3107BLK*†						FA436		FA436HH			MD3106		MD3106C	VR3106	
56	VR3107BLK*†						FA436		FA436HH			MD3106		MD3106C	VR3106	

BRAKE APPLICATIONS
⊗ This symbol indicates a rotor made of billet steel, and should be only used with EBC FA Organic or Vee pads.
SAFETY NOTICE - With vehicles primarily designed for off highway use such as quads now being used on the highway, we would recommend the use of X or MXS pads for highway use and ONLY using the R and SV higher density / harder pad series for off road riding.

*-2 Sets Required. † For Vee disc colours add RED, BLU, GRN, GLD, ORG suffix to part number. **SAFETY WARNING:- DO NOT USE HH PADS ON REAR UNLESS ALSO USED ON FRONT TO AVOID BRAKE IMBALANCE**

FRONT: SUZUKI

APPLICATIONS

BRAKE



SUZUKI



DISC PAD CHOICES - FRONT

BRAKE ROTOR CHOICES - FRONT

Model	Year	DISC PAD CHOICES - FRONT					BRAKE ROTOR CHOICES - FRONT				Line #	
		FA/SFA/X Pad or Brake Shoe	Specialty Pads SXR/ VEE/MXS Race	Sintered/ HH Pads/ Grooved Shoes	EPFA Sintered Fast Road/Track Pads	GPFAX Sintered RACE ONLY Pads	SV Series Severe Duty Pads	Standard Rotor Left	Standard Rotor Right	Vintage Rotor / UTV Oversize Brake Kit		Contour Profile Rotor
GSX-R 1000 RZ	2022-2024			FA447HH*	EPFA447HH*	GPFAX447HH*		MD3107X	MD3107X		MD3107XC*	1
GSX-R 1000 ZL3 Special Edition	2013			FA447HH*	EPFA447HH*	GPFAX447HH*		MD3102X	MD3102X		MD3102XC*	2
GSX-S 1000	2021-2024			FA447HH*	EPFA447HH*	GPFAX447HH*		MD3109X	MD3109X		MD3109XC*	3
GSX-S 1000 F	2016-2020			FA447HH*	EPFA447HH*	GPFAX447HH*		MD3109X	MD3109X		MD3109XC*	4
GSX-S 1000 F	2016-2021			FA447HH*	EPFA447HH*	GPFAX447HH*		MD3109X	MD3109X		MD3109XC*	5
GSX-S 1000 F ZL8	2018-2020			FA447HH*	EPFA447HH*	GPFAX447HH*		MD3109X	MD3109X		MD3109XC*	6
GSX-S 1000 GT	2021-2024			FA447HH*	EPFA447HH*	GPFAX447HH*		MD3109X	MD3109X		MD3109XC*	7
GSX-S 1000 L	2016-2020			FA447HH*	EPFA447HH*	GPFAX447HH*		MD3109X	MD3109X		MD3109XC*	8
GSX-S 1000 L	2016-2024			FA447HH*	EPFA447HH*	GPFAX447HH*		MD3109X	MD3109X		MD3109XC*	9
SV 1000	2003-2007	FA158*		FA158HH*	EPFA158HH*			MD3088X	MD3088X		MD3088XC*	10
TL 1000 R	1998-2003	FA188*		FA188HH*	EPFA188HH*			MD3058X	MD3058X		MD3058XC*	11
TL 1000 S	1997-2001	FA158*		FA158HH*	EPFA158HH*			MD3058X	MD3058X		MD3058XC*	12
DL 1050 V-Strom	2020-2024			FA379HH*	EPFA379HH*			MD3092X	MD3092X		MD3092XC*	13
DL 1050 V-Strom Adventure	2020-2024			FA379HH*	EPFA379HH*			MD3092X	MD3092X		MD3092XC*	14
DL 1050 V-Strom XT	2020-2024			FA379HH*	EPFA379HH*			MD3092X	MD3092X		MD3092XC*	15
DL 1050 V-Strom XT Adventure	2020-2024			FA379HH*	EPFA379HH*			MD3092X	MD3092X		MD3092XC*	16
DL 1050DE V-Strom	2023-2024			FA379HH*	EPFA379HH*			MD3092X	MD3092X		MD3092XC*	17
DL 1050DE V-Strom XT Adventure	2023-2024			FA379HH*	EPFA379HH*			MD3092X	MD3092X		MD3092XC*	18
GS 1100	1980-1983	FA65*						MD3014LS	MD3014RS	VMD3014*		19
GS 1100	1982-1983	FA51*						MD3014LS	MD3014RS	VMD3014*		20
GS 1100	1982-1983	FA51*						MD3014LS	MD3014RS	VMD3014*		21
GS 1100	1982-1983	FA51*						MD3014LS	MD3014RS	VMD3014*		22
GS 1100 LT	1980	FA65*	FA65V*					MD3014LS	MD3014RS	VMD3014*		23
GS 1100 SD	1983	FA65*						MD3014LS	MD3014RS	VMD3014*		24
GSX 1100	1991-1993	FA129*		FA129HH*	EPFA129HH*			MD3037LS	MD3037RS			25
GSX 1100 Katana	1988-1993	FA146*		FA146HH*				MD3039LS	MD3039RS			26
GSX-R 1100	1986-1988	FA103*		FA103HH*				MD3004	MD3004			27
GSX-R 1100	1989-1992	FA145*		FA145HH*	EPFA145HH*			MD3007X	MD3007X		MD3007XC*	28
GSX-R 1100	1993-1998	FA188*		FA188HH*	EPFA188HH*			MD3007X	MD3007X		MD3007XC*	29
GS 1150	1983-1986	FA103*		FA103HH*				MD3039LS	MD3039RS			30
GSF 1200 Bandit	1996-1999	FA145*		FA145HH*	EPFA145HH*			MD3006X	MD3006X		MD3006XC*	31
GSF 1200 Bandit	2001-2005	FA188*		FA188HH*	EPFA188HH*			MD3006X	MD3006X		MD3006XC*	32
GSF 1200 SAV Bandit	1997	FA145*		FA145HH*	EPFA145HH*			MD3075LS	MD3075RS			33
GV 1200 Madura	1985-1986	FA51*						MD3030LS	MD3030RS			34
GSF 1250 Bandit	2007-2010	FA158*		FA158HH*	EPFA158HH*			MD3092X	MD3092X		MD3092XC*	35
GSF 1250 Bandit	2007-2010	FA158*		FA158HH*	EPFA158HH*			MD3092X	MD3092X		MD3092XC*	36
GSX 1250	2011-2014	FA158*		FA158HH*	EPFA158HH*			MD3092X	MD3092X		MD3092XC*	37
GSX 1250 Bandit	2016	FA158*		FA158HH*	EPFA158HH*			MD3092X	MD3092X		MD3092XC*	38
GSX 1300 B-King	2008-2010			FA347HH*	EPFA347HH*			MD3098X	MD3098X		MD3098XC*	39
GSX 1300 B-King	2008-2010			FA347HH*	EPFA347HH*			MD3098X	MD3098X		MD3098XC*	40
GSX 1300 Hayabusa	1999-2007	FA188*		FA188HH*	EPFA188HH*			MD3058X	MD3058X		MD3058XC*	41
GSX 1300 Hayabusa	2008-2012			FA379HH*	EPFA379HH*			MD3098X	MD3098X		MD3098XC*	42
GSX 1300 Hayabusa	2013-2020			FA447HH*	EPFA447HH*			MD3098X	MD3098X		MD3098XC*	43
GSX 1300 Hayabusa 25th Anniversary Edition	2021-2024			FA447HH*	EPFA447HH*			MD3115X	MD3115X			44
GSX 1300 RZL4 Hayabusa 50th Anniversary Edition	2014			FA447HH*	EPFA447HH*			MD3098X	MD3098X		MD3098XC*	45
GV 1400 Cavalcade	1986	FA103*	FA103V*	FA103HH*				MD3042	MD3042			46
GV 1400 Cavalcade	1986	FA146*	FA146V*	FA146HH*				MD3042	MD3042			47
GV 1400 Cavalcade	1986-1988	FA146*	FA146V*	FA146HH*				MD3042	MD3042			48
VS 1400 Boulevard	2005-2010	FA103	FA103V	FA103HH					MD3032RS			49
VS 1400 Intruder	1987-2004	FA103	FA103V	FA103HH					MD3032RS			50
VL 1500 Boulevard	Left 2005-2010	FA229	FA229V	FA229HH	EPFA229HH			MD3087LS				51
VL 1500 Boulevard	Right 2013	FA231	FA231V	FA231HH	EPFA231HH				MD3087RS			52
VL 1500 Boulevard	2013	FA196	FA196V	FA196HH								53
VL 1500 Boulevard	2013-2015	FA196	FA196V	FA196HH								54
VL 1500 Boulevard C90 B.O.S.S.	2013-2015	FA196	FA196V	FA196HH								55
VL 1500 Boulevard C90T B.O.S.S.	2013-2014	FA196	FA196V	FA196HH								56

FRONT

* This symbol indicates a rotor made of billet steel, and should be only used with EBC FA Organic or Vee pads.
 SAFETY NOTICE - With vehicles primarily designed for off highway use such as quads now being used on the highway, we would recommend the use of X or MXS pads for highway use and ONLY using the R and SV higher density / harder pad series for off road riding.

*-2 Sets Required. † For Vee disc colours add RED, BLU, GRN, GLD, ORG suffix to part number. **SAFETY WARNING:- DO NOT USE HH PADS ON REAR UNLESS ALSO USED ON FRONT TO AVOID BRAKE IMBALANCE**

FRONT: SUZUKI Cont'd

REAR: SUZUKI

Line #	BRAKE ROTOR CHOICES - FRONT					DISC PAD CHOICES - REAR					BRAKE ROTOR CHOICES - REAR					
	CX Extreme® /Vee-Rotor	OSX Series Oversize 280mm Rotor Kit	Relocating Bracket for Oversize Rotor	SMX Series Oversize 320mm Rotor Kit	Relocating Bracket for 320mm Rotor	Front Disc Bolt Kit	FA/SFA/X Pad or Brake Shoe	Specialty Pads SXR/ VEE/MXS Race	Sintered/ HH Pads/ Grooved Shoes	EPFA Sintered Fast Road/ Track Pads	SV Series Severe Duty Pads	Standard Rotor	Vintage Rotor / UTV Oversize Brake Kit	Contour Profile Rotor	CX Extreme® /Vee-Rotor	Rear Disc Bolt Kit
1	VR3107BLK*†						FA436		FA436HH			MD3106		MD3106C	VR3106	
2	VR3102BLK*†						FA436		FA436HH			MD3060		MD3060C	VR3060	DB303/5
3							FA174		FA174HH			MD3108		MD3108C	VR3108	
4	VR3109BLK*†						FA174		FA174HH			MD3108		MD3108C	VR3108	
5	VR3109BLK*†						FA174		FA174HH			MD3108		MD3108C	VR3108	
6	VR3109BLK*†						FA174		FA174HH			MD3108		MD3108C	VR3108	
7							FA174		FA174HH			MD3108		MD3108C	VR3108	
8	VR3109BLK*†						FA174		FA174HH			MD3108		MD3108C	VR3108	
9	VR3109BLK*†						FA174		FA174HH			MD3108		MD3108C	VR3108	
10	VR3088BLK*†					DB302/5	FA174		FA174HH			MD3060		MD3060C	VR3060	DB303/5
11	VR3058BLK*†					DB303/5	FA63		FA63HH			MD3060		MD3060C	VR3060	DB303/5
12	VR3058BLK*†					DB303/5	FA63		FA63HH			MD3060		MD3060C	VR3060	DB303/5
13						DB302/5	FA419		FA419HH			MD6232D				DB302/4
14						DB302/5	FA419		FA419HH			MD6232D				DB302/4
15						DB302/5	FA419		FA419HH			MD6232D				DB302/4
16						DB302/5	FA419		FA419HH			MD6232D				DB302/4
17						DB302/5	FA419		FA419HH			MD6232D				DB302/4
18						DB302/5	FA419		FA419HH			MD6232D				DB302/4
19							FA36					MD3014RS	VMD3014			
20							FA36					MD3027				
21							FA36					MD3027				
22							FA36					MD3027				
23							FA36					MD3014RS	VMD3014			
24							FA36					MD3014RS	VMD3014			
25							FA146		FA146HH			MD3038				
26							FA103		FA103HH			MD3036				
27							FA63		FA63HH			MD3009				
28	VR3007BLK*†					DB303/5	FA63		FA63HH			MD3008		MD3008C	VR3008	DB303/5
29	VR3007BLK*†					DB303/5	FA63		FA63HH			MD3008		MD3008C	VR3008	DB303/5
30							FA103		FA103HH			MD3039				
31	VR3006BLK*†					DB303/5	FA63		FA63HH			MD3008		MD3008C	VR3008	DB303/5
32	VR3006BLK*†					DB303/5	FA63		FA63HH			MD3008		MD3008C	VR3008	DB303/5
33							FA63		FA63HH			MD3076				
34							FA36					MD3041				
35	VR3092BLK*†					DB302/5	FA174		FA174HH			MD3093		MD3093C	VR3093	DB303/5
36	VR3092BLK*†					DB302/5	FA174		FA174HH			MD3093		MD3093C	VR3093	DB303/5
37	VR3092BLK*†					DB302/5	FA174		FA174HH			MD3093		MD3093C	VR3093	DB303/5
38	VR3092BLK*†					DB302/5	FA174		FA174HH			MD3093		MD3093C	VR3093	DB303/5
39	VR3098BLK*†					DB302/5	FA419		FA419HH			MD3099		MD3099C	VR3099	DB302/6
40	VR3098BLK*†					DB302/5	FA419		FA419HH			MD3099		MD3099C	VR3099	DB302/6
41	VR3058BLK*†					DB303/5	FA63		FA63HH			MD3008		MD3008C	VR3008	DB303/5
42	VR3098BLK*†					DB302/5	FA419		FA419HH			MD3099		MD3099C	VR3099	DB302/6
43	VR3098BLK*†					DB302/5	FA419		FA419HH			MD3099		MD3099C	VR3099	DB302/6
44							FA419		FA419HH			MD3099				DB302/6
45	VR3098BLK*†					DB302/5	FA419		FA419HH			MD3099		MD3099C	VR3099	DB302/6
46							FA103		FA103HH			MD3043				
47							FA150		FA150HH			MD3043				
48							FA150		FA150HH			MD3043				
49							FA103		FA103HH			MD3044				
50							FA103		FA103HH			MD3044				
51							FA366		FA366HH			MD3086				
52									FA231HH			MD3086				
53									FA231HH			MD3086				
54									FA231HH			MD3086				
55									FA231HH			MD3086				
56									FA231HH			MD3086				

BRAKE APPLICATIONS
 * This symbol indicates a rotor made of billet steel, and should be only used with EBC FA Organic or Vee pads.
 SAFETY NOTICE - With vehicles primarily designed for off highway use such as quads now being used on the highway, we would recommend the use of X or MXS pads for highway use and ONLY using the R and SV higher density / harder pad series for off road riding.

*-2 Sets Required. † For Vee disc colours add RED, BLU, GRN, GLD, ORG suffix to part number. **SAFETY WARNING:- DO NOT USE HH PADS ON REAR UNLESS ALSO USED ON FRONT TO AVOID BRAKE IMBALANCE**

FRONT: SUZUKI



SUZUKI



APPLICATIONS

BRAKE

⚠ This symbol indicates a rotor made of billet steel, and should be only used with EBC FA Organic or Vee pads.
SAFETY NOTICE - With vehicles primarily designed for off highway use such as quads now being used on the highway, we would recommend the use of X or MXS pads for highway use and ONLY using the R and SV higher density / harder pad series for off road riding.

DISC PAD CHOICES - FRONT

BRAKE ROTOR CHOICES - FRONT

Model	Left / Right	Year	DISC PAD CHOICES - FRONT					BRAKE ROTOR CHOICES - FRONT				Line #
			FA/SFA/X Pad or Brake Shoe	Specialty Pads SXR/VEE/MXS Race	Sintered/HH Pads/Grooved Shoes	EPFA Sintered Fast Road/Track Pads	GPFA Sintered RACE ONLY Pads	SV Series Severe Duty Pads	Standard Rotor Left	Standard Rotor Right	Vintage Rotor / UTV Oversize Brake Kit	
VL 1500 Intruder LC	Left	2002-2004	FA229	FA229V	FA229HH	EPFA229HH		MD3087LS				1
	Right		FA231	FA231V	FA231HH	EPFA231HH			MD3087RS			2
VL 1500 Legendary Classic		1998-1999	FA103	FA103V	FA103HH				MD3078RS			3
VL 1500 Legendary Classic		2000-2001	FA103	FA103V	FA103HH				MD3078RS			4
VZ 1500 Boulevard	Left	2009	FA229	FA229V	FA229HH	EPFA229HH		MD3090X			MD3090XC*	5
	Right		FA231	FA231V	FA231HH	EPFA231HH			MD3090X			6
VZ 1500 Boulevard	Left	2013-2015	FA229	FA229V	FA229HH	EPFA229HH		MD3090X			MD3090XC*	7
	Right		FA231	FA231V	FA231HH	EPFA231HH			MD3090X			8
VZ 1600 Boulevard		2005			FA369/4HH*	EPFA369/4HH*		MD4022X	MD4022X		MD4022XC*	9
VZ 1600 Marauder		2004	FA188		FA188HH	EPFA188HH*		MD4022X	MD4022X		MD4022XC*	10
VLR 1800 Boulevard		2008-2010	FA388*		FA388HH*	EPFA388HH*		MD3090X	MD3090X		MD3090XC*	11
VLR 1800 Boulevard Touring		2008-2010	FA388*		FA388HH*	EPFA388HH*		MD3090X	MD3090X		MD3090XC*	12
VZR 1800 Boulevard		2006-2014			FA379HH*	EPFA379HH*		MD3091X	MD3091X		MD3091XC*	13
VZR 1800 Boulevard M109R Boss		2014-2024			FA379HH*	EPFA379HH*		MD3091X	MD3091X		MD3091XC*	14
VZR 1800 Boulevard Limited		2008-2009			FA379HH*	EPFA379HH*		MD3091X	MD3091X		MD3091XC*	15
VZR 1800 Boulevard RZ Limited		2008-2014			FA379HH*	EPFA379HH*		MD3091X	MD3091X		MD3091XC*	16
												17
												18
												19
												20
												21
												22
												23
												24
												25
												26
												27
												28
												29
												30
												31
												32
												33
												34
												35
												36
												37
												38
												39
												40
												41
												42
												43
												44
												45
												46
												47
												48
												49
												50
												51
												52
												53
												54
												55
												56

FRONT

*-2 Sets Required. † For Vee disc colours add RED, BLU, GRN, GLD, ORG suffix to part number. **SAFETY WARNING:- DO NOT USE HH PADS ON REAR UNLESS ALSO USED ON FRONT TO AVOID BRAKE IMBALANCE**

FRONT: SUZUKI Cont'd

REAR: SUZUKI

Line #	BRAKE ROTOR CHOICES - FRONT					DISC PAD CHOICES - REAR					BRAKE ROTOR CHOICES - REAR					
	CX Extreme® /Vee-Rotor	OSX Series Oversize 280mm Rotor Kit	Relocating Bracket for Oversize Rotor	SMX Series Oversize 320mm Rotor Kit	Relocating Bracket for 320mm Rotor	Front Disc Bolt Kit	FA/SFA/X Pad or Brake Shoe	Specialty Pads SXR/ VEE/MXS Race	Sintered/ HH Pads/ Grooved Shoes	EPFA Sintered Fast Road/ Track Pads	SV Series Severe Duty Pads	Standard Rotor	Vintage Rotor / UTV Oversize Brake Kit	Contour Profile Rotor	CX Extreme® /Vee-Rotor	Rear Disc Bolt Kit
1							FA366		FA366HH			MD3086				
2																
3							FA103		FA103HH			MD3079				
4							FA103		FA103HH			MD3086				
5	VR3090BLK*†					DB302/5			FA231HH	EPFA231HH		MD3097				
6																
7	VR3090BLK*†					DB302/5			FA231HH	EPFA231HH		MD3097				
8																
9	VR4022BLK*†								FA231HH	EPFA231HH		MD4146				
10	VR4022BLK*†								FA231HH	EPFA231HH		MD4146				
11	VR3090BLK*†					DB302/5			FA231HH	EPFA231HH		MD3097				
12	VR3090BLK*†					DB302/5			FA231HH	EPFA231HH		MD3097				
13	VR3091BLK*†					DB302/5			FA231HH	EPFA231HH		MD3097				
14	VR3091BLK*†					DB302/5			FA231HH	EPFA231HH		MD3097				
15	VR3091BLK*†					DB302/5			FA231HH	EPFA231HH		MD3097				
16	VR3091BLK*†					DB302/5			FA231HH	EPFA231HH		MD3097				
17																
18																
19																
20																
21																
22																
23																
24																
25																
26																
27																
28																
29																
30																
31																
32																
33																
34																
35																
36																
37																
38																
39																
40																
41																
42																
43																
44																
45																
46																
47																
48																
49																
50																
51																
52																
53																
54																
55																
56																

REAR

BRAKE APPLICATIONS

⚠ This symbol indicates a rotor made of billet steel, and should be only used with EBC FA Organic or Vee pads. SAFETY NOTICE - With vehicles primarily designed for off highway use such as quads now being used on the highway, we would recommend the use of X or MXS pads for highway use and ONLY using the R and SV higher density / harder pad series for off road riding.

*-2 Sets Required. † For Vee disc colours add RED, BLU, GRN, GLD, ORG suffix to part number. **SAFETY WARNING:- DO NOT USE HH PADS ON REAR UNLESS ALSO USED ON FRONT TO AVOID BRAKE IMBALANCE**

FRONT: YAMAHA



YAMAHA



DISC PAD CHOICES - FRONT

BRAKE ROTOR CHOICES - FRONT

FA/SFA/X Pad or Brake Shoe	Specialty Pads SXR/VEE/MXS Race	Sintered/HH Pads/Grooved Shoes	EPFA Sintered Fast Road/Track Pads	GPFA Sintered RACE ONLY Pads	SV Series Severe Duty Pads	Standard Rotor Left	Standard Rotor Right	Vintage Rotor / UTV Oversize Brake Kit	Contour Profile Rotor
CA 50 Riva									
CE 50									
CG 50									
CV 50 L Riva									
CW 50	SFA193	SFA193HH				MD916D			
CW 50	SFA193	SFA193HH				MD904D			
CW 50	SFA193	SFA193HH				MD923D			
CW 50 K Riva									
CW 50 Riva Zuma									
CY 50 Jog									
CY 50 Jog									
CY 50 N Jog									
DT 50		518G							
EW 50 Stunt	SFA268	SFA268HH				MD923D			
LB 50 Chappy									
LC 50 Champ									
MJ 50 J Towny									
PW 50									
QT 50 Yamahopper									
RX 50 MKIKIL									
SH 50 ED Mint									
SH 50 Razz									
SH 50 Razz									
TT-R 50 E									
TT-R 50 E									
XC 50 Vino Classic									
XF 50 50cc Scooter									
YFM 50 Raptor	503*	503G*							
YFZ 50 Y	346*	346G*							
YJ 50 Vino 50									
YJ 50 Vino Classic									
YSR 50	FA101								
YZ 50 G		502G							
Zuma 50	SFA169	SFA169HH							
Zuma 50	SFA169	SFA169HH							
Zuma 50 F	SFA384								
Zuma 50 FX	SFA384								
YF 60 S									
YT 60									
YZ 60		502G							
YZ 65 J	FA119X	FA119R				MD6418D			MD6418C
YXE 70 Wolverine	Left	FA642X	FA642R		FA642SV	MD6382D		UTVX6382*	
	Right	FA645X	FA645R		FA645SV		MD6382D		
YXE 70 Wolverine EPS	Left	FA642X	FA642R		FA642SV	MD6382D		UTVX6382*	
	Right	FA645X	FA645R		FA645SV		MD6382D		
YXE 70 Wolverine EPS Hunter	Left	FA642X	FA642R		FA642SV	MD6382D		UTVX6382*	
	Right	FA645X	FA645R		FA645SV		MD6382D		
YXE 70 Wolverine Hunter	Left	FA642X	FA642R		FA642SV	MD6382D		UTVX6382*	
	Right	FA645X	FA645R		FA645SV		MD6382D		
YXE 70 Wolverine R Spec	Left	FA642X	FA642R		FA642SV	MD6382D		UTVX6382*	
	Right	FA645X	FA645R		FA645SV		MD6382D		
YXE 70 Wolverine R Spec	Left	FA642X	FA642R		FA642SV	MD6382D		UTVX6382*	
	Right	FA645X	FA645R		FA645SV		MD6382D		
YXE 70 Wolverine R Spec EPS	Left	FA642X	FA642R		FA642SV	MD6382D		UTVX6382*	
	Right	FA645X	FA645R		FA645SV		MD6382D		

FRONT

Line #
1
2
3
4
5
6
7
8
9
10
11
12
13
14
15
16
17
18
19
20
21
22
23
24
25
26
27
28
29
30
31
32
33
34
35
36
37
38
39
40
41
42
43
44
45
46
47
48
49
50
51
52
53
54
55
56

APPLIATIONS
BRAKE
SAFETY NOTICE - With vehicles primarily designed for off highway use such as quads now being used on the highway, we would recommend the use of X or MXS pads for highway use and ONLY using the R and SV higher density / harder pad series for off road riding.

*** This symbol indicates a rotor made of billet steel, and should be only used with EBC FA Organic or Vee pads.**

*-2 Sets Required. † For Vee disc colours add RED, BLU, GRN, GLD, ORG suffix to part number. **SAFETY WARNING:- DO NOT USE HH PADS ON REAR UNLESS ALSO USED ON FRONT TO AVOID BRAKE IMBALANCE**

FRONT: YAMAHA Cont'd

REAR: YAMAHA

Line #	BRAKE ROTOR CHOICES - FRONT						DISC PAD CHOICES - REAR						BRAKE ROTOR CHOICES - REAR				
	CX Extreme® /Vee-Rotor	OSX Series Oversize 280mm Rotor Kit	Relocating Bracket for Oversize Rotor	SMX Series Oversize 320mm Rotor Kit	Relocating Bracket for 320mm Rotor	Front Disc Bolt Kit	FA/SFA/X Pad or Brake Shoe	Specialty Pads SXR/ VEE/MXS Race	Sintered/ HH Pads/ Grooved Shoes	EPFA Sintered Fast Road/ Track Pads	SV Series Severe Duty Pads	Standard Rotor	Vintage Rotor / UTV Oversize Brake Kit	Contour Profile Rotor	CX Extreme® /Vee-Rotor	Rear Disc Bolt Kit	
1							519										
2							519										
3							519										
4							503										
5							503										
6							503										
7	VR923						503										
8							503										
9							518										
10							503										
11							503										
12							503										
13							518	518G									
14	VR923						503										
15							504										
16							519										
17							501										
18							501										
19							501										
20							504										
21							519										
22							519										
23							519										
24							301										
25							301										
26							530										
27							530										
28							527	527G									
29							307	307G									
30							530										
31							530										
32							503										
33							502	502G									
34							531										
35							531										
36	VR9159						530										
37	VR9159						530										
38							518	518G									
39							518	518G									
40							502	502G									
41	MD6418CX						FA84/3X	MXS84/3	FA84/3R			MD6419D		MD6419C	MD6419CX		
42							FA674X		FA674R	FA674SV	MD6382D*	UTVX6382*					
43							FA675X		FA675R	FA675SV							
44							FA674X		FA674R	FA674SV	MD6382D*	UTVX6382*					
45							FA675X		FA675R	FA675SV							
46							FA674X		FA674R	FA674SV	MD6382D*	UTVX6382*					
47							FA675X		FA675R	FA675SV							
48							FA674X		FA674R	FA674SV	MD6382D*	UTVX6382*					
49							FA675X		FA675R	FA675SV							
50							FA674X		FA674R	FA674SV	MD6382D*	UTVX6382*					
51							FA675X		FA675R	FA675SV							
52							FA674X		FA674R	FA674SV							
53							FA675X		FA675R	FA675SV							
54							FA674X		FA674R	FA674SV	MD6382D*	UTVX6382*					
55							FA675X		FA675R	FA675SV							

REAR

BRAKE APPLICATIONS

⚠ This symbol indicates a rotor made of billet steel, and should be only used with EBC FA Organic or Vee pads. SAFETY NOTICE - With vehicles primarily designed for off highway use such as quads now being used on the highway, we would recommend the use of X or MXS pads for highway use and ONLY using the R and SV higher density / harder pad series for off road riding.

*-2 Sets Required. † For Vee disc colours add RED, BLU, GRN, GLD, ORG suffix to part number. **SAFETY WARNING:- DO NOT USE HH PADS ON REAR UNLESS ALSO USED ON FRONT TO AVOID BRAKE IMBALANCE**

FRONT: YAMAHA

APPLICATIONS
BRAKE



YAMAHA



DISC PAD CHOICES - FRONT

BRAKE ROTOR CHOICES - FRONT

Model	Side	Year	DISC PAD CHOICES - FRONT					BRAKE ROTOR CHOICES - FRONT				Line #	
			FA/SFA/X Pad or Brake Shoe	Specialty Pads SXR/VEE/MXS Race	Sintered/HH Pads/Grooved Shoes	EPFA Sintered Fast Road/Track Pads	GPFAX Sintered RACE ONLY Pads	SV Series Severe Duty Pads	Standard Rotor Left	Standard Rotor Right	Vintage Rotor / UTV Oversize Brake Kit		Contour Profile Rotor
YXE 70 Wolverine R Spec EPS Hunter	Left	2016-2017	FA642X		FA642R			FA642SV	MD6382D		UTVX6382*		1
	Right		FA645X		FA645R			FA645SV		MD6382D			2
YXE 70 Wolverine R Spec EPS SE	Left	2016-2017	FA642X		FA642R			FA642SV	MD6382D		UTVX6382*		3
	Right		FA645X		FA645R			FA645SV		MD6382D			4
YXE 70 Wolverine R Spec Hunter	Left	2016	FA642X		FA642R			FA642SV	MD6382D		UTVX6382*		5
	Right		FA645X		FA645R			FA645SV		MD6382D			6
BW 80		1986-1988	502		502G								7
BW 80		1990	502		502G								8
CV 80 Riva		1983-1987	503										9
DT 80		1981-1982	504		504G								10
DT 80 K		1983	503		503G								11
LB 80 11 - A Chappy		1995-1998	503										12
PW 80		1983-1985	502		502G								13
PW 80		1991	502		502G								14
PW 80		1992-2008	502		502G								15
V 80		1994	503										16
V 80		1994-1996	503										17
V 80		1998	503										18
YFM 80		1985-1986											19
YFM 80		1987-1988	518*		518G*								20
YFM 80 Badger		1992-2001	503*		503G*								21
YFM 80 Grizzly		2005-2008	503*		503G*								22
YFM 80 Raptor		2002-2008	503*		503G*								23
YZ 80		1980-1985	502		502G								24
YZ 80		1986-1988	FA119X		FA119R				MD6029D				25
YZ 80		1989-1992	FA119X		FA119R				MD6029D				26
YZ 80		1993-2001	FA119X		FA119R				MD6030D			MD6030C	27
YXE 85W Wolverine X2	Left	2021-2024	FA642X		FA642R			FA642SV	MD6382D		UTVX6382*		28
	Right		FA645X		FA645R			FA645SV		MD6382D			29
YXF 85 Wolverine X4	Left	2018-2024	FA642X		FA642R			FA642SV	MD6382D		UTVX6382*		30
	Right		FA645X		FA645R			FA645SV		MD6382D			31
YXF 85 Wolverine X4 SE	Left	2018	FA642X		FA642R			FA642SV	MD6382D		UTVX6382*		32
	Right		FA645X		FA645R			FA645SV		MD6382D			33
YZ 85		2001-2024	FA119X		FA119R				MD6030D			MD6030C	34
YZ 85 LW		2021-2024	FA119X		FA119R				MD6030D			MD6030C	35
JYM 90 T Axis		2001	SFA169		SFA169HH				MD904D				36
TT-R 90		2000-2007	502		502G								37
YA 90 Axis		1996	SFA169		SFA169HH				MD904D				38
YA 90 Axis		1991-1995	SFA169		SFA169HH				MD904D				39
YFM 90 Raptor		2010-2013	536*		536G*								40
YFM 90 Raptor 90		2016-2017	346*		346G*								41
YFM 90 RY Raptor		2009	536*		536G*								42
DT 100		1980-1982	504		504G								43
DT 100 K		1983	503		503G								44
MX 100		1980-1982	504		504G								45
MX 100 K		1983	503		503G								46
RT 100		1991-2000	503		503G								47
RX 100		2001-2003	503										48
RX 100		2004	503										49
RX 100		2004	503										50
RXZ 100 S		1988-1995	503										51
XC 100 Jog		2005-2006	530										52
YA 100 W Grand Axis		2001-2003	SFA169		SFA169HH				MD904D				53
YFM 100 Champ		1987-1988	518*		518G*								54
YFM 100 Champ		1989-1991	503*		503G*								55
YW 100 BW's		1997-2008	SFA169		SFA169HH				MD904D				56

FRONT

⚠ This symbol indicates a rotor made of billet steel, and should be only used with EBC FA Organic or Vee pads. SAFETY NOTICE - With vehicles primarily designed for off highway use such as quads now being used on the highway, we would recommend the use of X or MXS pads for highway use and ONLY using the R and SV higher density / harder pad series for off road riding.

*-2 Sets Required. † For Vee disc colours add RED, BLU, GRN, GLD, ORG suffix to part number. SAFETY WARNING:- DO NOT USE HH PADS ON REAR UNLESS ALSO USED ON FRONT TO AVOID BRAKE IMBALANCE

FRONT: YAMAHA Cont'd

REAR: YAMAHA

Line #	BRAKE ROTOR CHOICES - FRONT						DISC PAD CHOICES - REAR						BRAKE ROTOR CHOICES - REAR				
	CX Extreme® /Vee-Rotor	OSX Series Oversize 280mm Rotor Kit	Relocating Bracket for Oversize Rotor	SMX Series Oversize 320mm Rotor Kit	Relocating Bracket for 320mm Rotor	Front Disc Bolt Kit	FA/SFA/X Pad or Brake Shoe	Specialty Pads SXR/ VEE/MXS Race	Sintered/ HH Pads/ Grooved Shoes	EPFA Sintered Fast Road/ Track Pads	SV Series Severe Duty Pads	Standard Rotor	Vintage Rotor / UTV Oversize Brake Kit	Contour Profile Rotor	CX Extreme® /Vee-Rotor	Rear Disc Bolt Kit	
1							FA674X		FA674R		FA674SV	MD6382D*	UTVX6382*				
2							FA675X		FA675R		FA675SV						
3							FA674X		FA674R		FA674SV	MD6382D*	UTVX6382*				
4							FA675X		FA675R		FA675SV						
5							FA674X		FA674R		FA674SV	MD6382D*	UTVX6382*				
6							FA675X		FA675R		FA675SV						
7							519										
8							519										
9							503										
10							504	504G									
11							503	503G									
12							503										
13							518	518G									
14							518	518G									
15							503	503G									
16							503										
17							503										
18							506	506G									
19							506	506G									
20							527	527G									
21							527	527G									
22							527	527G									
23							527	527G									
24							502	502G									
25							502	502G									
26							502	502G									
27	MD6030CX	OSXY6030	BRK036					MXS84/3	FA84/3R			MD6031D			MD6031CX		
28							FA674X		FA674R		FA674SV	MD6382D*	UTVX6382*				
29							FA675X		FA675R		FA675SV						
30							FA674X		FA674R		FA674SV	MD6382D*	UTVX6382*				
31							FA675X		FA675R		FA675SV						
32							FA674X		FA674R		FA674SV	MD6382D*					
33							FA675X		FA675R		FA675SV						
34	MD6030CX	OSXY6030	BRK036					MXS84/3	FA84/3R			MD6031D			MD6031CX		
35	MD6030CX	OSXY6030	BRK036					MXS84/3	FA84/3R			MD6031D			MD6031CX		
36							503										
37							503	503G									
38							503										
39							518										
40							FA67X	FA67R		FA67SV	MD6282D						
41							307	307G									
42							FA83X	FA83R			MD6282D						
43							504	504G									
44							503	503G									
45							504	504G									
46							503	503G									
47							503	503G									
48							503										
49							503										
50							503										
51							503										
52							530										
53							527										
54							506	506G									
55							506	506G									
56							527										

⚠ This symbol indicates a rotor made of billet steel, and should be only used with EBC FA Organic or Vee pads.
SAFETY NOTICE - With vehicles primarily designed for off highway use such as quads now being used on the highway, we would recommend the use of X or MXS pads for highway use and ONLY using the R and SV higher density / harder pad series for off road riding.

*-2 Sets Required. † For Vee disc colours add RED, BLU, GRN, GLD, ORG suffix to part number. **SAFETY WARNING:- DO NOT USE HH PADS ON REAR UNLESS ALSO USED ON FRONT TO AVOID BRAKE IMBALANCE**

FRONT: YAMAHA

APPLICATIONS
BRAKE



YAMAHA



DISC PAD CHOICES - FRONT

BRAKE ROTOR CHOICES - FRONT

Model	Year	FA/SFA/X Pad or Brake Shoe	Specialty Pads SXR/VEE/MXS Race	Sintered/HH Pads/Grooved Shoes	EPFA Sintered Fast Road/Track Pads	GPFAX Sintered RACE ONLY Pads	SV Series Severe Duty Pads	Standard Rotor		Vintage Rotor / UTV Oversize Brake Kit	Contour Profile Rotor	Line #
								Standard Rotor Left	Standard Rotor Right			
YZ 100	1980-1981	504		504G								1
YZ 100	1982-1983	503		503G								2
T 105 E Crypton R	1999-2002	SFA275		SFA275HH					MD963D			3
T 105 SE Crypton	2010	SFA464										4
T 110	2011-2013	SFA464										5
T 110 C	2011-2013	SFA464										6
TT-R 110 E	2008-2024	502		502G								7
AF 115 S Fino	2012	SFA464										8
AT 115	2007	SFA275		SFA275HH								9
AT 115 C Nuvo	2005-2006	SFA275		SFA275HH								10
RXS 115	1994-1997	FA81		FA81R								11
RXS 115	1999	FA275		FA275HH								12
Breeze 125 YFA1	1989-1991	503*		503G*								13
Breeze 125 YFA1	1992-2004	503*		503G*								14
DT 125	1980-1981	506		506G								15
GT 125 Hammerhead	2012-2018	FA181X		FA181HH				MD6158D			MD6158C	16
IT 125	1980-1981	504		504G								17
TT-R 125	2000-2009	503		503G								18
TT-R 125	2000-2009	FA119X		FA119R				MD6158D			MD6158C	19
TT-R 125 LE	2010-2024	FA119X		FA119R				MD6158D			MD6158C	20
WR 125 K	1998	FA135X	MXS135	FA135R				MD6028D			MD6028C	21
XA 125 Cygnus	2012	SFA464										22
XC 125 Riva	1985-1992	521										23
XC 125 Riva	1993-1994	521										24
XC 125 Riva	1998	521										25
XT 125	1982-1983	506		506G								26
YBA 125 Enticer	2005	FA181X		FA181HH								27
YBA 125 Enticer	2005	506										28
YBA 125 Enticer	2007-2012	FA181X		FA181HH								29
YBA 125 Vision	2001	FA142		FA142HH								30
YBR 125	2001	503										31
YBR 125	2011-2013	531										32
YBR 125 C	2008-2013	531										33
YBR 125 E	2006-2013	531										34
YBR 125 EB	2006-2008	FA197		FA197HH								35
YBR 125 EB	2002-2005	FA197		FA197HH								36
YBR 125 ED	2010-2013	FA101							MD2097RS			37
YBR 125 ED	2001	527										38
YBR 125 ED	2007-2009	FA101							MD2097RS			39
YBR 125 ESD	2007-2009	FA101							MD2097RS			40
YBR 125 ESD	2010-2013	FA101							MD2097RS			41
YBR 125 ESG	2011-2013	FA464							MD2104RS			42
YBR 125 K	2002-2006	527										43
YBR 125 R	2011-2012	FA464							MD2104RS			44
YFM 125 Grizzly	2004-2013	503*		503G*								45
YFM 125 Raptor	2011-2013	FA54X*		FA54R*			FA54SV*	MD6054D	MD6054D			46
YJ 125 Vino	2004-2009	SFA101		SFA101HH								47
YT 125	1980-1982											48
YT 125	1982-1985											49
YW 125 G Zuma	2016-2021	SFA196		SFA196HH								50
YW 125 MB Zuma	2021-2022	SFA196		SFA196HH								51
YW 125 X	2010-2013	SFAG32										52
YW 125 Zuma	2009-2015	SFA492						MD986D				53
YZ 125	1980-1982	507		507G								54
YZ 125	1986-1987	FA105X		FA105R				MD6067D				55
YZ 125	1992-1993	FA135X	MXS135	FA135R				MD6028D			MD6028C	56

FRONT

* This symbol indicates a rotor made of billet steel, and should be only used with EBC FA Organic or Vee pads.
SAFETY NOTICE - With vehicles primarily designed for off highway use such as quads now being used on the highway, we would recommend the use of X or MXS pads for highway use and ONLY using the R and SV higher density / harder pad series for off road riding.

*-2 Sets Required. † For Vee disc colours add RED, BLU, GRN, GLD, ORG suffix to part number. SAFETY WARNING:- DO NOT USE HH PADS ON REAR UNLESS ALSO USED ON FRONT TO AVOID BRAKE IMBALANCE

FRONT: YAMAHA Cont'd

REAR: YAMAHA

Line #	BRAKE ROTOR CHOICES - FRONT						DISC PAD CHOICES - REAR						BRAKE ROTOR CHOICES - REAR				
	CX Extreme® /Vee-Rotor	OSX Series Oversize 280mm Rotor Kit	Relocating Bracket for Oversize Rotor	SMX Series Oversize 320mm Rotor Kit	Relocating Bracket for 320mm Rotor	Front Disc Bolt Kit	FA/SFA/X Pad or Brake Shoe	Specialty Pads SXR/ VEE/MXS Race	Sintered/ HH Pads/ Grooved Shoes	EPFA Sintered Fast Road/ Track Pads	SV Series Severe Duty Pads	Standard Rotor	Vintage Rotor / UTV Oversize Brake Kit	Contour Profile Rotor	CX Extreme® /Vee-Rotor	Rear Disc Bolt Kit	
1							506		506G								
2							506		506G								
3							518										
4							530										
5							530										
6							530										
7							503		503G								
8							531										
9							531										
10							531										
11							518										
12							518										
13							506		506G								
14							527		527G								
15							506		506G								
16							FA152X	MXS152	FA152R			MD6011D					
17							506		506G								
18							503		503G								
19							503		503G								
20							503		503G								
21		OSX6028E	BRK035				FA152X	MXS152	FA152R			MD6011D					
22							530										
23							506										
24							527										
25							527										
26							503		503G								
27							506		506G								
28							506										
29							535										
30							527										
31							503										
32							527										
33							531										
34							531										
35							527										
36							527										
37							531										
38							527										
39							531										
40							531										
41							531										
42							531										
43							527										
44							531										
45							527		527G								
46							FA84X		FA84R		FA84SV	MD6236D					
47							530										
48							FA20X										
49							FA21X		FA21R		FA21SV						
50	VR9133						SFA213		SFA213HH			MD9150D	VR9150				
51	VR9133						SFA213		SFA213HH				VR927				
52	VR9133						533										
53							533										
54							506		506G								
55							506		506G								
56		OSX6028E	BRK035				FA152/2X	MXS152/2	FA152/2R			MD6011D					

BRAKE APPLICATIONS

⚠ This symbol indicates a rotor made of billet steel, and should be only used with EBC FA Organic or Vee pads. SAFETY NOTICE - With vehicles primarily designed for off highway use such as quads now being used on the highway, we would recommend the use of X or MXS pads for highway use and ONLY using the R and SV higher density / harder pad series for off road riding.

*-2 Sets Required. † For Vee disc colours add RED, BLU, GRN, GLD, ORG suffix to part number. **SAFETY WARNING:- DO NOT USE HH PADS ON REAR UNLESS ALSO USED ON FRONT TO AVOID BRAKE IMBALANCE**

FRONT: YAMAHA



YAMAHA



DISC PAD CHOICES - FRONT

BRAKE ROTOR CHOICES - FRONT

Model	Year	FA/SFA/X Pad or Brake Shoe	Specialty Pads SXR/VEE/MXS Race	Sintered/HH Pads/Grooved Shoes	EPFA Sintered Fast Road/Track Pads	GPFAX Sintered RACE ONLY Pads	SV Series Severe Duty Pads	Standard Rotor		Vintage Rotor / UTV Oversize Brake Kit	Contour Profile Rotor	Line #
								Standard Rotor Left	Standard Rotor Right			
YZ 125	1994-1997	FA135X	MXS135	FA135R				MD6028D			MD6028C	1
YZ 125	1998-2000	FA185X	MXS185	FA185R				MD6028D			MD6028C	2
YZ 125	2003-2004	FA185X	MXS185	FA185R				MD6356D			MD6356C	3
YZ 125	2005-2007	FA185X	MXS185	FA185R				MD6356D			MD6356C	4
YZ 125	2008-2016	FA450X	MXS450	FA450R							MD6356C	5
YZ 125	2017-2021	FA450X	MXS450	FA450R							MD6392C	6
YZ 125 2T	2021-2024	FA755X	MXS755	FA755R							MD6392C	7
YZ 125 2T 50th Anniversary Edition	2024	FA755X	MXS755	FA755R							MD6392C	8
YZ 125 2T Monster Energy	2022	FA755X	MXS755	FA755R							MD6392C	9
YZ 125 A	1990	FA135X	MXS135	FA135R				MD6012D				10
YZ 125 B	1991	FA135X	MXS135	FA135R				MD6012D				11
YZ 125 K	1983	507		507G								12
YZ 125 L	1984	508		508G								13
YZ 125 N	1985	FA105X		FA105R				MD6324D				14
YZ 125 N	2001	FA185X	MXS185	FA185R				MD6356D			MD6356C	15
YZ 125 P	2002	FA185X	MXS185	FA185R				MD6356D			MD6356C	16
YZ 125 U	1988	FA105X		FA105R				MD6039D				17
YZ 125 W	1989	FA135X	MXS135	FA135R				MD6016D				18
YZ 125 X Cross country	2021-2024	FA450X	MXS450	FA450R							MD6392C	19
RX-Z 135	1987-1989	FA81		FA81R								20
RX-Z 135	1993-1997	FA81		FA81R								21
RX-Z 135	2000-2005	FA81		FA81R								22
FZ 150	2007-2008	FA464										23
SR 150	1995	510										24
YZF-R 15	2010-2013	FA464										25
XC 155 S-Max	2015-2020	SFA196		SFA196HH								26
FZ 16 160cc	2010-2013	FA181X		FA181HH								27
FZ 16 S 160cc	2012-2013	FA181X		FA181HH								28
FZ 16 ST 160cc	2011-2013	FA181X		FA181HH								29
DT 175	1980-1981	506		506G								30
IT 175	1980-1983	507		507G								31
MX 175	1980-1981	504		504G								32
YT 175	1982-1983	503		503G								33
RT 180	1990-1992	FA101X		FA101R								34
RT 180	1993-1997	FA101X		FA101R								35
XC 180 Riva	1983-1985	521										36
SR 185	1981-1982	506										37
BW 200	1985-1987	503		503G								38
IT 200	1984-1985	517		517G								39
IT 200	1986	FA105X		FA105R				MD6039D				40
TW 200	1987-1991	506		506G								41
TW 200	1992-2000	527		527G								42
TW 200	2001-2024	FA275X		FA275HH				MD6067D				43
WR 200 D	1992	FA135X		FA135R				MD6066D				44
XC 200 Riva	1987-1991	521										45
XT 200	1982-1983	506		506G								46
YFM 200	1985-1989	503*		503G*								47
YFS 200 Blaster	1988-2002	503*		503G*								48
YFS 200 Blaster	2003-2006	FA54X*		FA54R*			FA54SV*	MD6054D	MD6054D			49
YTM 200	1983-1985	503		503G								50
YTM 200	1983-1984	503		503G								51
YTM 200 ERN	1985	503		503G								52
TT 225	1986-1987	FA101X		FA101R				MD6067D				53
TT-R 225	1999-2003	FA101X		FA101R				MD6067D				54
XT 225 Serraw	1992-2000	FA101X		FA101R				MD6067D				55
XT 225 Serraw	2001-2007	FA275X						MD6067D				56

FRONT

BRAKE APPLICATIONS

* This symbol indicates a rotor made of billet steel, and should be only used with EBC FA Organic or Vee pads.
 SAFETY NOTICE - With vehicles primarily designed for off highway use such as quads now being used on the highway, we would recommend the use of X or MXS pads for highway use and ONLY using the R and SV higher density / harder pad series for off road riding.

*-2 Sets Required. † For Vee disc colours add RED, BLU, GRN, GLD, ORG suffix to part number. **SAFETY WARNING:- DO NOT USE HH PADS ON REAR UNLESS ALSO USED ON FRONT TO AVOID BRAKE IMBALANCE**

FRONT: YAMAHA Cont'd

REAR: YAMAHA

Line #	BRAKE ROTOR CHOICES - FRONT					DISC PAD CHOICES - REAR					BRAKE ROTOR CHOICES - REAR					
	CX Extreme® /Vee-Rotor	OSX Series Oversize 280mm Rotor Kit	Relocating Bracket for Oversize Rotor	SMX Series Oversize 320mm Rotor Kit	Relocating Bracket for 320mm Rotor	Front Disc Bolt Kit	FA/SFA/X Pad or Brake Shoe	Specialty Pads SXR/ VEE/MXS Race	Sintered/ HH Pads/ Grooved Shoes	EPFA Sintered Fast Road/ Track Pads	SV Series Severe Duty Pads	Standard Rotor	Vintage Rotor / UTV Oversize Brake Kit	Contour Profile Rotor	CX Extreme® /Vee-Rotor	Rear Disc Bolt Kit
1		OSX6028E	BRK035				FA152/2X	MXS152/2	FA152/2R			MD6011D				
2	MD6028CX	OSX6028	BRK008	SMX6028	BRK009		FA131X	MXS131	FA131R			MD6135D		MD6135C	MD6135CX	
3	MD6356CX	OSX6028	BRK008	SMX6028	BRK009		FA367X	MXS367	FA367R			MD6190D		MD6190C	MD6190CX	
4	MD6356CX	OSX6028	BRK008	SMX6028	BRK009		FA367X	MXS367	FA367R			MD6190D		MD6190C	MD6190CX	
5	MD6356CX	OSX6728	BRK002	SMX6728	BRK034		FA367X	MXS367	FA367R	EPFA367HH				MD6190C	MD6190CX	
6	MD6392CX	OSX6392	BRK002				FA367X	MXS367	FA367R	EPFA367HH				MD6190C	MD6190CX	
7	MD6392CX	OSX6392	BRK002				FA367X	MXS367	FA367R	EPFA367HH				MD6135C	MD6135CX	
8	MD6392CX	OSX6392	BRK002				FA367X	MXS367	FA367R	EPFA367HH				MD6135C	MD6135CX	
9	MD6392CX	OSX6392	BRK002				FA367X	MXS367	FA367R	EPFA367HH				MD6135C	MD6135CX	
10							FA152X	MXS152	FA152R			MD6011D				
11							FA152/2X	MXS152/2	FA152/2R			MD6011D				
12							517		517G							
13							517		517G							
14							517		517G							
15	MD6356CX	OSX6028	BRK008	SMX6028	BRK009		FA131X	MXS131	FA131R			MD6135D		MD6135C	MD6135CX	
16	MD6356CX	OSX6028	BRK008	SMX6028	BRK009		FA131X	MXS131	FA131R			MD6190D		MD6190C	MD6190CX	
17							FA101X		FA101R			MD6011D				
18								MXS84/3	FA84/3R			MD6011D				
19	MD6392CX	OSX6392	BRK002				FA367X	MXS367	FA367R	EPFA367HH				MD6190C	MD6190CX	
20							504									
21							527									
22							527									
23							531									
24							528									
25							FA152X					MD9168D				
26	VR9145						SFA213		SFA213HH						VR9133	
27							535									
28							535									
29							535									
30							506		506G							
31							506		506G							
32							506		506G							
33							FA21X		FA21R		FA21SV					
34							506		506G							
35							527		527G							
36							537									
37							503									
38							503		503G							
39							517		517G							
40							517		517G							
41							503		503G							
42							503		503G							
43							503		503G							
44							FA152/2X		FA152/2R			MD6121D				
45							537									
46							503		503G							
47							FA21X		FA21R		FA21SV					
48							FA155X		FA155R			MD6050D				
49							FA84X		FA84R		FA84SV	MD6237D				
50							FA21X		FA21R		FA21SV					
51							FA21X		FA21R		FA21SV					
52							FA21X		FA21R		FA21SV					
53							503		503G							
54							527		527G							
55							503		503G							
56							503		503G							

BRAKE APPLICATIONS
⚠ This symbol indicates a rotor made of billet steel, and should be only used with EBC FA Organic or Vee pads.
SAFETY NOTICE - With vehicles primarily designed for off highway use such as quads now being used on the highway, we would recommend the use of X or MXS pads for highway use and ONLY using the R and SV higher density / harder pad series for off road riding.

*-2 Sets Required. † For Vee disc colours add RED, BLU, GRN, GLD, ORG suffix to part number. **SAFETY WARNING:- DO NOT USE HH PADS ON REAR UNLESS ALSO USED ON FRONT TO AVOID BRAKE IMBALANCE**

FRONT: YAMAHA

APPLICATIONS

BRAKE



YAMAHA



Model	Year Range	FA/SFA/X Pad or Brake Shoe	Specialty Pads SXR/VEE/MXS Race	Sintered/HH Pads/Grooved Shoes	EPFA Sintered Fast Road/Track Pads	GPFA Sintered RACE ONLY Pads	SV Series Severe Duty Pads	Standard Rotor Left	Standard Rotor Right	Vintage Rotor / UTV Oversize Brake Kit	Contour Profile Rotor
YFM 225	1986-1988	503*		503G*							
YTM 225	1983-1985	503		503G							
YTM 225	1985-1986	503		503G							
Pro Hauler Pro 4 YFU1TW	1989	528*		528G*							
Pro Hauler Pro 4 YFU1W	1989	528*		528G*							
TT-R 230	2005-2009	FA135X	MXS135	FA135R				MD6067D			
TT-R 230	2010-2024	FA135X	MXS135	FA135R				MD6067D			
CP 250 Morphus	2006-2008	SFA199		SFA199HH					MD9107D		
DT 250	1975-1979	528		528G							
DT 250 A	1974	510		510G							
IT 250	1977-1980	507		507G							
IT 250	1981-1982	507		507G							
IT 250 K	1983	508		508G							
SR 250	1993-2008	522									
SR 250 EXCiter III	1980-1982	528									
SR 250 K	1993	522									
SRX 250 51Y152E1JA	1987	FA104		FA104HH					MD2011		MD2011C
TT 250 R	1980-1982	507		507G							
TT-R 250	1999-2006	FA135X	MXS135	FA135R				MD6066D			
WR 250	1991	FA135X	MXS135	FA135R				MD6012D			
WR 250	1992-1997	FA135X	MXS135	FA135R				MD6028D			MD6028C
WR 250 F	2003-2004	FA185X	MXS185	FA185R				MD6356D			MD6356C
WR 250 F	2005-2006	FA185X	MXS185	FA185R				MD6356D			MD6356C
WR 250 F	2007-2018	FA185X	MXS185	FA185R							MD6356C
WR 250 F	2018-2022	FA450X	MXS450	FA450R							MD6392C
WR 250 FN	2001	FA185X	MXS185	FA185R				MD6356D			MD6356C
WR 250 FP	2002	FA185X	MXS185	FA185R				MD6356D			MD6356C
WR 250 FP2	2023-2024	FA755X	MXS755	FA755R							MD6392C
WR 250 R	2008-2017	FA185X	MXS185	FA185R							MD6320C
WR 250 X	2008-2011	FA142		FA142HH							MD6323C
XT 250	1980-1984	506		506G							
XT 250	2008-2024	FA275X		FA275HH				MD6067D			
XTZ 250 Lander	2016-2018	FA465X	MXS465	FA465R				MD6068D			
XTZ 250 Lander	2007-2014	FA135X	MXS135	FA135R				MD6068D			
XTZ 250 X	2008-2010	FA135X	MXS135	FA135R				MD6068D			
XV 250	1988-1990	FA81		FA81R					MD2019RS		
XV 250 Virago	1995-2007	FA199	FA199V	FA199HH				MD2067			
XV 250 V-Star	2008-2012	FA199	FA199V	FA199HH				MD2067			
XV 250 V-Star	2013-2022	FA199		FA199HH				MD2067			
YBR 250	2010-2012	FA464									
YFB 250 Timberwolf	1992-1994	503*		503G*							
YFB 250 Timberwolf	1994-2000	528*		528G*							
YFB 250 Timberwolf	1995-1998	528*		528G*							
YFM 250 Bear Tracker	1999-2000	528*		528G*							
YFM 250 Beartracker	2001-2004	FA54X*		FA54R*			FA54SV*	MD6054D	MD6054D		
YFM 250 Big Bear	2007-2009	FA54X*		FA54R*			FA54SV*	MD6054D	MD6054D		
YFM 250 Bruin	2005-2006	FA54X*		FA54R*			FA54SV*	MD6054D	MD6054D		
YFM 250 Raptor	2008-2013	FA443X		FA443R			FA443SV	MD6054D			
		Right		FA444X			FA444SV		MD6054D		
YFM 250 RSPA Special Edition	2011	Left		FA443X			FA443SV	MD6054D			
		Right		FA444X			FA444SV		MD6054D		
YFM 250 RSPXIRSEY Special Edition	2008-2009	Left		FA443X			FA443SV	MD6054D			
		Right		FA444X			FA444SV		MD6054D		
YFM 250 RSPXC Special Edition Custom	2008	Left		FA443X			FA443SV	MD6054D			
		Right		FA444X			FA444SV		MD6054D		

FRONT

DISC PAD CHOICES - FRONT

BRAKE ROTOR CHOICES - FRONT

Line #

MD6190C ● = PLAIN UNDRILLED DISC FOR ENDURO USE. REAR FITMENTS ONLY. ORDER MD6190CE

*-2 Sets Required. † For Vee disc colours add RED, BLU, GRN, GLD, ORG suffix to part number. **SAFETY WARNING:- DO NOT USE HH PADS ON REAR UNLESS ALSO USED ON FRONT TO AVOID BRAKE IMBALANCE**

⚠ This symbol indicates a rotor made of billet steel, and should be only used with EBC FA Organic or Vee pads. SAFETY NOTICE - With vehicles primarily designed for off highway use such as quads now being used on the highway, we would recommend the use of X or MXS pads for highway use and ONLY using the R and SV higher density / harder pad series for off road riding.

FRONT: YAMAHA Cont'd

REAR: YAMAHA

Line #	BRAKE ROTOR CHOICES - FRONT					DISC PAD CHOICES - REAR					BRAKE ROTOR CHOICES - REAR					
	CX Extreme® /Vee-Rotor	OSX Series Oversize 280mm Rotor Kit	Relocating Bracket for Oversize Rotor	SMX Series Oversize 320mm Rotor Kit	Relocating Bracket for 320mm Rotor	Front Disc Bolt Kit	FA/SFA/X Pad or Brake Shoe	Specialty Pads SXR/ VEE/MXS Race	Sintered/ HH Pads/ Grooved Shoes	EPFA Sintered Fast Road/ Track Pads	SV Series Severe Duty Pads	Standard Rotor	Vintage Rotor / UTV Oversize Brake Kit	Contour Profile Rotor	CX Extreme® /Vee-Rotor	Rear Disc Bolt Kit
1							FA21X		FA21R		FA21SV					
2							FA21X		FA21R		FA21SV					
3							FA21X		FA21R		FA21SV					
4							523*		523G*							
5							523*		523G*							
6							527		527G							
7							527		527G							
8							SFA408		SFA408HH			MD9108D				
9							510		510G							
10							510		510G							
11							528		528G							
12							510		510G							
13							510		510G							
14							527									
15							506									
16							506									
17	VR2011						537									
18							506		506G							
19							FA152X	MXS152	FA152R			MD6121D				
20							FA152X	MXS152	FA152R			MD6011D				
21							FA152X	MXS152	FA152R			MD6011D				
22	MD6356CX	OSX6028	BRK008	SMX6028	BRK009		FA367X	MXS367	FA367R			MD6190D	MD6190C●	MD6190CX		
23	MD6356CX	OSX6028	BRK008	SMX6028	BRK009		FA367X	MXS367	FA367R			MD6190D	MD6190C●	MD6190CX		
24	MD6356CX	OSX6028	BRK008	SMX6028	BRK009		FA367X	MXS367	FA367R				MD6190C●	MD6190CX		
25	MD6392CX	OSX6392	BRK002				FA367X	MXS367	FA367R				MD6190C●	MD6190CX		
26	MD6356CX	OSX6028	BRK008	SMX6028	BRK009		FA131X	MXS131	FA131R			MD6135D	MD6135C	MD6135CX		
27	MD6356CX	OSX6028	BRK008	SMX6028	BRK009		FA131X	MXS131	FA131R			MD6190D	MD6190C●	MD6190CX		
28	MD6392CX	OSX6392	BRK002				FA367X	MXS367	FA367R				MD6190C●	MD6190CX		
29							FA367X	MXS367	FA367R				MD6319C	MD6190CX		
30							FA367X	MXS367	FA367R				MD6319C			
31							506		506G							
32							FA152X	MXS152	FA152R			MD6244D				
33							FA152X	MXS152	FA152R			MD6244D				
34							FA152X	MXS152	FA152R			MD6244D				
35							FA152X	MXS152	FA152R			MD6244D				
36							506									
37						DB201/6	527									
38						DB201/6	527									
39						DB201/6	535									
40							535									
41							528		528G							
42							528		528G							
43							528		528G							
44							528		528G							
45							528		528G							
46							532		532G							
47							532		532G							
48							FA84X		FA84R		FA84SV	MD6236D				
49							FA84X		FA84R		FA84SV	MD6236D				
50							FA84X		FA84R		FA84SV	MD6236D				
51							FA84X		FA84R		FA84SV	MD6236D				
52							FA84X		FA84R		FA84SV	MD6236D				
53							FA84X		FA84R		FA84SV	MD6236D				
54							FA84X		FA84R		FA84SV	MD6236D				
55																
56																

BRAKE APPLICATIONS
 ● This symbol indicates a rotor made of billet steel, and should be only used with EBC FA Organic or Vee pads.
 SAFETY NOTICE - With vehicles primarily designed for off highway use such as quads now being used on the highway, we would recommend the use of X or MXS pads for highway use and ONLY using the R and SV higher density / harder pad series for off road riding.

*-2 Sets Required. † For Vee disc colours add RED, BLU, GRN, GLD, ORG suffix to part number. **SAFETY WARNING:- DO NOT USE HH PADS ON REAR UNLESS ALSO USED ON FRONT TO AVOID BRAKE IMBALANCE**

FRONT: YAMAHA

APPLICATIONS

BRAKE



YAMAHA



DISC PAD CHOICES - FRONT

BRAKE ROTOR CHOICES - FRONT

Model	Year	FA/SFA/X Pad or Brake Shoe	Specialty Pads SXR/VEE/MXS Race	Sintered/HH Pads/Grooved Shoes	EPFA Sintered Fast Road/Track Pads	GPFAX Sintered RACE ONLY Pads	SV Series Severe Duty Pads	Standard Rotor		Vintage Rotor / UTV Oversize Brake Kit	Contour Profile Rotor	Line #
								Standard Rotor Left	Standard Rotor Right			
YFM 250 W/AB	1989-1991	528*		528G*								1
YP 250 Majesty	1997	SFA199		SFA199HH					MD903D			2
YP 250 Majesty	2000-2003	SFA199		SFA199HH					MD903D			3
YS 250 Fazer	2006-2010	FA197		FA197HH					MD2106RS			4
YTZ 250 TR1-Z	1985-1986	FA101X		FA101R				MD6047D				5
YZ 250	1982-1984	508		508G								6
YZ 250	1990-1991	FA135X	MXS135	FA135R				MD6012D				7
YZ 250	1992-1993	FA135X	MXS135	FA135R				MD6028D			MD6028C	8
YZ 250	1994-1997	FA135X	MXS135	FA135R				MD6028D			MD6028C	9
YZ 250	1998-2000	FA185X	MXS185	FA185R				MD6028D			MD6028C	10
YZ 250	2003-2004	FA185X	MXS185	FA185R				MD6356D			MD6356C	11
YZ 250	2005-2007	FA185X	MXS185	FA185R				MD6356D			MD6356C	12
YZ 250	2008-2016	FA450X	MXS450	FA450R							MD6356C	13
YZ 250	2016-2020	FA450X	MXS450	FA450R							MD6356C	14
YZ 250	2021-2024	FA755X	MXS755	FA755R							MD6392C	15
YZ 250	2024	FA755X	MXS755	FA755R							MD6392C	16
YZ 250 F	2002	FA185X	MXS185	FA185R				MD6356D			MD6356C	17
YZ 250 F	2001	FA185X	MXS185	FA185R				MD6356D			MD6356C	18
YZ 250 F	2003-2004	FA185X	MXS185	FA185R				MD6356D			MD6356C	19
YZ 250 F	2005-2006	FA185X	MXS185	FA185R				MD6356D			MD6356C	20
YZ 250 F	2006-2015	FA450X	MXS450	FA450R							MD6356C	21
YZ 250 F	2016-2019	FA450X	MXS450	FA450R							MD6392C	22
YZ 250 F	2020-2024	FA755X	MXS755	FA755R							MD6392C	23
YZ 250 F 50th Anniversary Edition	2024	FA755X	MXS755	FA755R							MD6392C	24
YZ 250 F MME	2021	FA755X	MXS755	FA755R							MD6392C	25
YZ 250 FGY 60th Anniversary Model	2016	FA450X	MXS450	FA450R							MD6392C	26
YZ 250 FX	2021-2023	FA450X	MXS450	FA450R							MD6392C	27
YZ 250 G	1980	507		507G								28
YZ 250 H	1981	507		507G								29
YZ 250 Monster Energy	2022	FA755X	MXS755	FA755R							MD6392C	30
YZ 250 N	1985	FA105X		FA105R				MD6324D				31
YZ 250 N	2001	FA185X	MXS185	FA185R				MD6356D			MD6356C	32
YZ 250 P	2002	FA185X	MXS185	FA185R				MD6356D			MD6356C	33
YZ 250 SIT	1986-1987	FA105X		FA105R				MD6067D				34
YZ 250 U	1988	FA105X		FA105R				MD6039D				35
YZ 250 W	1989	FA135X	MXS135	FA135R				MD6016D				36
YZ 250 WRA	1990	FA135X	MXS135	FA135R				MD6028D			MD6028C	37
YZ 250 WRW	1989	FA135X	MXS135	FA135R				MD6016D				38
YZ 250 X	2017-2024	FA450X	MXS450	FA450R							MD6392C	39
MT-03	2016-2023	FA663		FA663HH		GPFAX663HH			MD2119X		MD2119XC	40
XMAX CZD300JW	2018-2021	SFA705		SFA705HH					MD9169D			41
YFM 300 Grizzly	2012-2013	FA83X*		FA83R*				MD6283D	MD6283D			42
YZF R3	2015-2023	FA663	FA663V	FA663HH		GPFAX663HH			MD2119X		MD2119XC	43
YZF R3 Monster Energy Yamaha Moto GP Edition 321cc	2019-2021	FA663	FA663V	FA663HH		GPFAX663HH			MD2119X		MD2119XC	44
BW 350	1987-1988	517		517G								45
RD 350	1973-1975	FA11										46
RZ 350 YPVS	1984-1985	FA81*		FA81R*				MD2011	MD2011		MD2011C*	47
TT 350 A 3GJ	1986-1987	FA105X		FA105R				MD6039D				48
TY 350	1985-1986	517		517G								49
XT 350	1985-1986	FA101X		FA101R				MD6068D				50
XT 350	1987-1990	FA101X		FA101R				MD6068D				51
XT 350	1991-2000	FA101X		FA101R				MD6068D				52
YFM 350	1989-1992	528*		528G*								53
YFM 350	1993-1995	528*		528G*								54
YFM 350	1996-1998	524*		524C*								55
YFM 350	1999	FA54X*		FA54R*			FA54SV*	MD6123D	MD6123D			56

FRONT

* This symbol indicates a rotor made of billet steel, and should be only used with EBC FA Organic or Vee pads.

SAFETY NOTICE - With vehicles primarily designed for off highway use such as quads now being used on the highway, we would recommend the use of X or MXS pads for highway use and ONLY using the R and SV higher density / harder pad series for off road riding.

*-2 Sets Required. † For Vee disc colours add RED, BLU, GRN, GLD, ORG suffix to part number. **SAFETY WARNING:- DO NOT USE HH PADS ON REAR UNLESS ALSO USED ON FRONT TO AVOID BRAKE IMBALANCE**

FRONT: YAMAHA Cont'd

REAR: YAMAHA

Line #

BRAKE ROTOR CHOICES - FRONT						DISC PAD CHOICES - REAR						BRAKE ROTOR CHOICES - REAR				
CX Extreme® /Vee-Rotor	OSX Series Oversize 280mm Rotor Kit	Relocating Bracket for Oversize Rotor	SMX Series Oversize 320mm Rotor Kit	Relocating Bracket for 320mm Rotor	Front Disc Bolt Kit	FA/SFA/X Pad or Brake Shoe	Specialty Pads SXR/ VEE/MXS Race	Sintered/ HH Pads/ Grooved Shoes	EPFA Sintered Fast Road/ Track Pads	SV Series Severe Duty Pads	Standard Rotor	Vintage Rotor / UTV Oversize Brake Kit	Contour Profile Rotor	CX Extreme® /Vee-Rotor	Rear Disc Bolt Kit	
1						FA21X		FA21R		FA21SV						
2	VR903					516										
3	VR903					SFA275		SFA275HH			MD953D		MD953C			
4						535										
5						FA101X		FA101R								
6						506		506G								
7						FA152X	MXS152	FA152R			MD6011D					
8		OSX6028E	BRK035			FA152/2X	MXS152/2	FA152/2R			MD6011D					
9		OSX6028E	BRK035			FA152/2X	MXS152/2	FA152/2R			MD6011D					
10	MD6028CX	OSX6028	BRK008	SMX6028	BRK009	FA131X	MXS131	FA131R			MD6135D		MD6135C	MD6135CX		
11	MD6356CX	OSX6028	BRK008	SMX6028	BRK009	FA367X	MXS367	FA367R			MD6190D		MD6190C	MD6190CX		
12	MD6356CX	OSX6028	BRK008	SMX6028	BRK009	FA367X	MXS367	FA367R			MD6190D		MD6190C	MD6190CX		
13	MD6356CX	OSX6728	BRK002	SMX6728	BRK034	FA367X	MXS367	FA367R	EPFA367HH				MD6190C	MD6190CX		
14	MD6356CX	OSX6728	BRK002	SMX6728	BRK034	FA367X	MXS367	FA367R	EPFA367HH				MD6190C	MD6190CX		
15	MD6392CX					FA367X	MXS367	FA367R	EPFA367HH				MD6135C	MD6135CX		
16	MD6392CX					FA367X	MXS367	FA367R	EPFA367HH				MD6135C	MD6135CX		
17	MD6356CX	OSX6028	BRK008	SMX6028	BRK009	FA131X	MXS131	FA131R			MD6190D		MD6190C	MD6190CX		
18	MD6356CX	OSX6028	BRK008	SMX6028	BRK009	FA131X	MXS131	FA131R			MD6135D		MD6135C	MD6135CX		
19	MD6356CX	OSX6028	BRK008	SMX6028	BRK009	FA367X	MXS367	FA367R			MD6190D		MD6190C	MD6190CX		
20	MD6356CX	OSX6028	BRK008	SMX6028	BRK009	FA367X	MXS367	FA367R			MD6190D		MD6190C	MD6190CX		
21	MD6356CX	OSX6728	BRK002	SMX6728	BRK034	FA367X	MXS367	FA367R	EPFA367HH				MD6190C	MD6190CX		
22	MD6392CX	OSX6392	BRK002			FA367X	MXS367	FA367R	EPFA367HH				MD6190C	MD6190CX		
23	MD6392CX	OSX6392	BRK002			FA367X	MXS367	FA367R	EPFA367HH				MD6190C	MD6190CX		
24	MD6392CX	OSX6392	BRK002			FA367X	MXS367	FA367R	EPFA367HH				MD6190C	MD6190CX		
25	MD6392CX	OSX6392	BRK002			FA367X	MXS367	FA367R	EPFA367HH				MD6190C	MD6190CX		
26	MD6392CX	OSX6392	BRK002			FA367X	MXS367	FA367R	EPFA367HH				MD6190C	MD6190CX		
27	MD6392CX	OSX6392	BRK002			FA367X	MXS367	FA367R	EPFA367HH				MD6135C	MD6135CX		
28						506		506G								
29						510		510G								
30	MD6392CX					FA367X	MXS367	FA367R	EPFA367HH				MD6135C	MD6135CX		
31						506		506G								
32	MD6356CX	OSX6028	BRK008	SMX6028	BRK009	FA131X	MXS131	FA131R			MD6135D		MD6135C	MD6135CX		
33	MD6356CX	OSX6028	BRK008	SMX6028	BRK009	FA131X	MXS131	FA131R			MD6190D		MD6190C	MD6190CX		
34						506		506G								
35						FA101X		FA101R			MD6011D					
36							MXS84/3	FA84/3R			MD6011D					
37		OSX6028E	BRK035			FA152X	MXS152	FA152R			MD6011D					
38								FA84/3R			MD6011D					
39	MD6392CX					FA367X	MXS367	FA367R	EPFA367HH				MD6190C	MD6190CX		
40	VR2119BLK†					FA662		FA662HH			MD2123		MD2123C	VR2123		
41						SFA706		SFA706HH			MD9168D					
42						FA67X		FA67R	FA67SV		MD6369D					
43	VR2119BLK†					FA662		FA662HH			MD2123		MD2123C	VR2123		
44	VR2119BLK†					FA662		FA662HH			MD2123		MD2123C	VR2123		
45						504		504G								
46						514										
47	VR2011*				DB201/6	FA88		FA88HH			MD2011		MD2011C	VR2011	DB201/6	
48						506		506G								
49						504		504G								
50						506		506G								
51						506		506G								
52						527		527G								
53						FA21X		FA21R		FA21SV						
54						FA21X		FA21R		FA21SV						
55						516		516G								
56						516		516G								

REAR

BRAKE APPLICATIONS

⚠ This symbol indicates a rotor made of billet steel, and should be only used with EBC FA Organic or Vee pads.
SAFETY NOTICE - With vehicles primarily designed for off highway use such as quads now being used on the highway, we would recommend the use of X or MXS pads for highway use and ONLY using the R and SV higher density / harder pad series for off road riding.

*-2 Sets Required. † For Vee disc colours add RED, BLU, GRN, GLD, ORG suffix to part number. **SAFETY WARNING:- DO NOT USE HH PADS ON REAR UNLESS ALSO USED ON FRONT TO AVOID BRAKE IMBALANCE**

FRONT: YAMAHA

APPLICATIONS
BRAKE



YAMAHA



DISC PAD CHOICES - FRONT

BRAKE ROTOR CHOICES - FRONT

YAMAHA	Year	Model	DISC PAD CHOICES - FRONT					BRAKE ROTOR CHOICES - FRONT				Line #	
			FA/SFA/X Pad or Brake Shoe	Specialty Pads SXR/VEE/MXS Race	Sintered/HH Pads/Grooved Shoes	EPFA Sintered Fast Road/Track Pads	GPFA Sintered RACE ONLY Pads	SV Series Severe Duty Pads	Standard Rotor Left	Standard Rotor Right	Vintage Rotor / UTV Oversize Brake Kit		Contour Profile Rotor
YFM 350 Big Bear	1987-1988		503*		503G*								1
YFM 350 Big Bear	1987-1988		520*		520G*								2
YFM 350 Big Bear	1989-1995		524*		524G*								3
YFM 350 Big Bear	1996-1998		524*		524G*								4
YFM 350 Big Bear	1999		FA54X*		FA54R*				FA54SV*	MD6123D	MD6123D		5
YFM 350 Bruin 2x4 Auto	2004-2006		FA54X*		FA54R*				FA54SV*	MD6215D	MD6215D		6
YFM 350 Bruin 4x4 Auto	2004-2006		FA54X*		FA54R*				FA54SV*	MD6215D	MD6215D		7
YFM 350 Grizzly 2x4	2007-2011		FA54X*		FA54R*				FA54SV*	MD6215D	MD6215D		8
YFM 350 Grizzly Auto 4x4	2006-2013		FA54X*		FA54R*				FA54SV*	MD6215D	MD6215D		9
YFM 350 Grizzly Auto IRS 4x4	2007-2011		FA54X*		FA54R*				FA54SV*	MD6215D	MD6215D		10
YFM 350 Raptor	2004-2013		FA84X*		FA84R*				FA84SV*	MD6054D	MD6054D		11
YFM 350 V Wolverine	2006		FA54X*		FA54R*				FA54SV*	MD6215D	MD6215D		12
YFM 350 Warrior	1990-2004		FA54X*		FA54R*				FA54SV*	MD6054D	MD6054D		13
YFM 350 Wolverine	1995-2005		FA54X*		FA54R*				FA54SV*	MD6123D	MD6123D		14
YFM 350 Wolverine	2006-2009		FA54X*		FA54R*				FA54SV*	MD6215D	MD6215D		15
YFM 350 XT	1987		FA101X*		FA101R*					MD6051D	MD6051D		16
YFM 350 XU Warrior	1988		FA101X*		FA101R*					MD6051D	MD6051D		17
YFM 350 XW Warrior	1989		FA54X*		FA54R*				FA54SV*	MD6054D	MD6054D		18
YFP 350 U Terrapro	1988		528*		528G*								19
YFZ 350 Banshee	1987-1989		FA101X*		FA101R*					MD6051D	MD6051D		20
YFZ 350 Banshee	1990-2006		FA54X*		FA54R*				FA54SV*	MD6054D	MD6054D		21
FZR 400	1988-1989		FA88*		FA88HH*	EPFA88HH*				MD2020LS	MD2020RS		22
FZR 400	1991-1992		FA252*		FA252HH*	EPFA252HH*				MD2001X	MD2001X	MD2001XC*	23
FZR 400 A	1990		FA123*		FA123HH*					MD2022LS	MD2022RS		24
RD 400	1976-1978		FA11										25
RD 400 F Daytona	1979		FA41	FA41V							MD2025	VMD2025	26
SR 400	2015-2020		FA179	FA179V	FA179HH						MD2076		27
WR 400	1999-2000		FA185X	MXS185	FA185R					MD6028D		MD6028C	28
WR 400 FK	1998		FA185X	MXS185	FA185R					MD6028D		MD6028C	29
WR 400 FN	2001		FA185X	MXS185	FA185R					MD6017D		MD6017C	30
XJ 400 S Seca II	1993		FA179		FA179HH					MD2031LS			31
XS 400	1980-1981		513										32
XS 400	1980-1981		FA41	FA41V							MD2019RS		33
XS 400 JJK Maxim	1982-1983		FA81		FA81R*						MD2019RS		34
XS 400 RJIRK	1982-1983		FA81		FA81R*						MD2011	MD2011C	35
XS 400 SJ	1982		513										36
YFM 400 2x4 Big Bear	2003-2004		FA54X*		FA54R*				FA54SV*	MD6123D	MD6123D		37
YFM 400 Big Bear	2000-2001		FA54X*		FA54R*				FA54SV*	MD6123D	MD6123D		38
YFM 400 Big Bear	2004-2006		FA54X*		FA54R*				FA54SV*	MD6123D	MD6123D		39
YFM 400 Big Bear	2000-2002		FA54X*		FA54R*				FA54SV*	MD6123D	MD6123D		40
YFM 400 Big Bear	2005-2006		FA54X*		FA54R*				FA54SV*	MD6123D	MD6123D		41
YFM 400 Big Bear 4WD IRS	2008-2012		FA54X*		FA54R*				FA54SV*	MD6215D	MD6215D		42
YFM 400 Big Bear Buckmaster	2001		FA54X*		FA54R*				FA54SV*	MD6123D	MD6123D		43
YFM 400 Big Bear Hunter IRS	2007-2010		FA54X*		FA54R*				FA54SV*	MD6215D	MD6215D		44
YFM 400 Big Bear Real Tree-tra	2000-2004		FA54X*		FA54R*				FA54SV*	MD6123D	MD6123D		45
YFM 400 FAR Kodiak Auto	2003		FA54X*		FA54R*				FA54SV*	MD6215D	MD6215D		46
YFM 400 FAS Kodiak	2004		FA54X*		FA54R*				FA54SV*	MD6215D	MD6215D		47
YFM 400 FBEW Big Bear IRS Exploring Edition	2007		FA54X*		FA54R*				FA54SV*	MD6215D	MD6215D		48
YFM 400 FWBL Kodiak	1999		FA54X*		FA54R*				FA54SV*	MD6123D	MD6123D		49
YFM 400 Grizzly	2007-2008		FA54X*		FA54R*				FA54SV*	MD6215D	MD6215D		50
YFM 400 Kodiak	1993-1998		524*		524G*								51
YFM 400 Kodiak	2000-2002		FA54X*		FA54R*				FA54SV*	MD6123D	MD6123D		52
YFM 400 Kodiak	2000-2001		FA54X*		FA54R*				FA54SV*	MD6123D	MD6123D		53
YFM 400 Kodiak	2003-2004		FA54X*		FA54R*				FA54SV*	MD6215D	MD6215D		54
YFM 400 Kodiak	2005-2006		FA54X*		FA54R*				FA54SV*	MD6215D	MD6215D		55
YFM 400 Kodiak 4x4Hunter	2000-2002		FA54X*		FA54R*				FA54SV*	MD6123D	MD6123D		56

* This symbol indicates a rotor made of billet steel, and should be only used with EBC FA Organic or Vee pads.
 SAFETY NOTICE - With vehicles primarily designed for off highway use such as quads now being used on the highway, we would recommend the use of X or MXS pads for highway use and ONLY using the R and SV higher density / harder pad series for off road riding.

*-2 Sets Required. † For Vee disc colours add RED, BLU, GRN, GLD, ORG suffix to part number. **SAFETY WARNING:- DO NOT USE HH PADS ON REAR UNLESS ALSO USED ON FRONT TO AVOID BRAKE IMBALANCE**

FRONT: YAMAHA Cont'd

REAR: YAMAHA

Line #	BRAKE ROTOR CHOICES - FRONT						DISC PAD CHOICES - REAR						BRAKE ROTOR CHOICES - REAR				
	CX Extreme® /Vee-Rotor	OSX Series Oversize 280mm Rotor Kit	Relocating Bracket for Oversize Rotor	SMX Series Oversize 320mm Rotor Kit	Relocating Bracket for 320mm Rotor	Front Disc Bolt Kit	FA/SFA/X Pad or Brake Shoe	Specialty Pads SXR/ VEE/MXS Race	Sintered/ HH Pads/ Grooved Shoes	EPFA Sintered Fast Road/ Track Pads	SV Series Severe Duty Pads	Standard Rotor	Vintage Rotor / UTV Oversize Brake Kit	Contour Profile Rotor	CX Extreme® /Vee-Rotor	Rear Disc Bolt Kit	
1							FA21X		FA21R		FA21SV						
2							FA21X		FA21R		FA21SV						
3							FA21X		FA21R		FA21SV						
4							516		516G								
5							516		516G								
6							532		532G								
7							532		532G								
8							532		532G								
9							532		532G								
10																	
11							FA84X		FA84R		FA84SV	MD6236D					
12							532		532G								
13							FA84X		FA84R		FA84SV	MD6055D					
14							FA84X		FA84R		FA84SV	MD6053D					
15							532		532G								
16							FA84X		FA84R		FA84SV						
17							FA84X		FA84R		FA84SV	MD6053D					
18							FA84X		FA84R		FA84SV	MD6053D					
19							523*		523G*								
20							FA84X		FA84R		FA84SV	MD6053D					
21							FA84X		FA84R		FA84SV	MD6237D					
22							FA104		FA104HH			MD2021					
23	VR2001BLK†					DB201/6	FA104		FA104HH			MD2021		MD2021C	VR2021		
24							FA104		FA104HH			MD2021					
25							FA11										
26							FA41				MD2025	VMD2025					
27							510										
28	MD6028CX	OSX6028	BRK008	SMX6028	BRK009		FA131X	MXS131	FA131R			MD6135D		MD6135C	MD6135CX		
29		OSX6028	BRK008	SMX6028	BRK009		FA152X	MXS152	FA152R			MD6011D					
30	MD6017CX	OSX6028	BRK008	SMX6028	BRK009		FA131X	MXS131	FA131R			MD6135D		MD6135C	MD6135CX		
31							FA88		FA88HH			MD2002				DB201/6	
32							516										
33							516										
34							516										
35	VR2011						516										
36							516										
37							516		516G								
38							516		516G								
39							532		532G								
40							516		516G								
41							532		532G								
42																	
43							516		516G								
44																	
45							516		516G								
46							516		516G								
47							532		532G								
48																	
49							528		528G								
50							FA307X		FA307R		FA307SV	MD6252D					
51							516		516G								
52							FA307X		FA307R		FA307SV	MD6174D					
53							FA307X		FA307R		FA307SV	MD6174D					
54							532		532G								
55							FA307X		FA307R		FA307SV	MD6252D					
56							FA307X		FA307R		FA307SV	MD6174D					

BRAKE APPLICATIONS
 * This symbol indicates a rotor made of billet steel, and should be only used with EBC FA Organic or Vee pads.
 SAFETY NOTICE - With vehicles primarily designed for off highway use such as quads now being used on the highway, we would recommend the use of X or MXS pads for highway use and ONLY using the R and SV higher density / harder pad series for off road riding.

*-2 Sets Required. † For Vee disc colours add RED, BLU, GRN, GLD, ORG suffix to part number. **SAFETY WARNING:- DO NOT USE HH PADS ON REAR UNLESS ALSO USED ON FRONT TO AVOID BRAKE IMBALANCE**

FRONT: YAMAHA

APPLICATIONS

BRAKE



YAMAHA



DISC PAD CHOICES - FRONT

BRAKE ROTOR CHOICES - FRONT

Model	Year	FA/SFA/X Pad or Brake Shoe	Specialty Pads SXR/VEE/MXS Race	Sintered/HH Pads/Grooved Shoes	EPFA Sintered Fast Road/Track Pads	GPFAX Sintered RACE ONLY Pads	SV Series Severe Duty Pads	Standard Rotor		Vintage Rotor / UTV Oversize Brake Kit	Contour Profile Rotor	Line #
								Standard Rotor Left	Standard Rotor Right			
YFM 400 S Big Bear	2004	FA54X*		FA54R*			FA54SV*	MD6123D	MD6123D			1
YP 400 Majesty	2005-2010	SFA179		SFA179HH				MD9102D				2
YP 400 Majesty	2012-2014	SFA179		SFA179HH				MD9102D				3
YZ 400 FK	1998	FA185X	MXS185	FA185R				MD6028D			MD6028C	4
YZ 400 FL	1999	FA185X	MXS185	FA185R				MD6028D			MD6028C	5
IT 425 G	1980	507		507G								6
WR 426 FN	2001	FA185X	MXS185	FA185R				MD6356D			MD6356C	7
WR 426 FP	2002	FA185X	MXS185	FA185R				MD6356D			MD6356C	8
YZ 426 FM	2000	FA185X	MXS185	FA185R				MD6028D			MD6028C	9
YZ 426 FN	2001	FA185X	MXS185	FA185R				MD6356D			MD6356C	10
YZ 426 FP	2002	FA185X	MXS185	FA185R				MD6356D			MD6356C	11
WR 450 F	2003-2004	FA185X	MXS185	FA185R				MD6356D			MD6356C	12
WR 450 F	2005-2006	FA185X	MXS185	FA185R				MD6356D			MD6356C	13
WR 450 F	2006-2015	FA185X	MXS185	FA185R							MD6356C	14
WR 450 F	2016-2020	FA450X	MXS450	FA450R							MD6392C	15
WR 450 FM	2021-2023	FA755X	MXS755	FA755R							MD6392C	16
WR 450 F	2024	FA755X	MXS755	FA755R							MD6392C	17
YFM 450 FXSEW Wolverine Sport Special Edition	2007	FA54X*		FA54R*			FA54SV*	MD6215D	MD6215D			18
YFM 450 Grizzly	2007-2008	FA54X*		FA54R*			FA54SV*	MD6215D	MD6215D			19
YFM 450 Grizzly	2008-2013	FA54X*		FA54R*			FA54SV*	MD6215D	MD6215D			20
YFM 450 Grizzly	2011-2013	FA54X*		FA54R*			FA54SV*	MD6215D	MD6215D			21
YFM 450 Grizzly IRS	2007	FA54X*		FA54R*			FA54SV*	MD6215D	MD6215D			22
YFM 450 Kodiak	2003-2004	FA54X*		FA54R*			FA54SV*	MD6215D	MD6215D			23
YFM 450 Kodiak	2021-2022	FA84X*		FA84R*				TBC	TBC			24
YFM 450 Kodiak	2005-2006	FA54X*		FA54R*			FA54SV*	MD6215D	MD6215D			25
YFM 450 Wolverine	2006-2010	FA54X*		FA54R*			FA54SV*	MD6215D	MD6215D			26
YFZ 450	2004-2005	Left	FA165X	FA165R			FA165SV	MD6054D				27
		Right	FA135X	FA135R			FA135SV		MD6054D			28
YFZ 450	2006-2009	Left	FA165X	FA165R			FA165SV	MD6054D				29
		Right	FA135X	FA135R			FA135SV		MD6054D			30
YFZ 450	2009-2012	Left	FA165X	FA165R			FA165SV	MD6054D				31
		Right	FA135X	FA135R			FA135SV		MD6054D			32
YFZ 450	2012-2013	Left	FA165X	FA165R			FA165SV	MD6054D				33
		Right	FA135X	FA135R			FA135SV		MD6054D			34
YFZ 450	2012-2013	Left	FA84X*	FA84R*			FA84SV*	MD6054D	MD6054D			35
YFZ 450	2014-2015	Left	FA165X	FA165R			FA165SV	MD6054D				36
		Right	FA135X	FA135R			FA135SV		MD6054D			37
YFZ 450	2014	Left	FA165X	FA165R			FA165SV	MD6054D				38
		Right	FA135X	FA135R			FA135SV		MD6054D			39
YFZ 450 Bill Balance Edition	2006-2007	Left	FA165X	FA165R			FA165SV	MD6054D				40
		Right	FA135X	FA135R			FA135SV		MD6054D			41
YFZ 450 LES Limited Edition	2004	Left	FA165X	FA165R			FA165SV	MD6054D				42
		Right	FA135X	FA135R			FA135SV		MD6054D			43
YFZ 450 SET Special Edition	2005	Left	FA165X	FA165R			FA165SV	MD6054D				44
		Right	FA135X	FA135R			FA135SV		MD6054D			45
YFZ 450 Special Edition	2006-2008	Left	FA165X	FA165R			FA165SV	MD6054D				46
		Right	FA135X	FA135R			FA135SV		MD6054D			47
YXR 450 F Rhino 4WD Side x Side	2004-2009	Left	FA165X	FA165R			FA165SV	MD6241D		UTVx6241*		48
		Right	FA135X	FA135R			FA135SV		MD6241D			49
YZ 450 F	2003-2004		FA185X	MXS185	FA185R			MD6356D			MD6356C	50
YZ 450 F	2005-2006		FA185X	MXS185	FA185R			MD6356D			MD6356C	51
YZ 450 F	2007		FA185X	MXS185	FA185R						MD6356C	52
YZ 450 F	2008-2015		FA450X	MXS450	FA450R						MD6356C	53
YZ 450 F	2016-2019		FA450X	MXS450	FA450R						MD6392C	54
YZ 450 F	2020-2023		FA755X	MXS755	FA755R						MD6392C	55
YZ 450 F	2024		FA755X	MXS755	FA755R						MD6392C	56

FRONT

* This symbol indicates a rotor made of billet steel, and should be only used with EBC FA Organic or Vee pads.

SAFETY NOTICE - With vehicles primarily designed for off highway use such as quads now being used on the highway, we would recommend the use of X or MXS pads for highway use and ONLY using the R and SV higher density / harder pad series for off road riding.

*-2 Sets Required. † For Vee disc colours add RED, BLU, GRN, GLD, ORG suffix to part number. **SAFETY WARNING:- DO NOT USE HH PADS ON REAR UNLESS ALSO USED ON FRONT TO AVOID BRAKE IMBALANCE**

FRONT: YAMAHA Cont'd

REAR: YAMAHA

Line #

BRAKE ROTOR CHOICES - FRONT						DISC PAD CHOICES - REAR						BRAKE ROTOR CHOICES - REAR				
CX Extreme® /Vee-Rotor	OSX Series Oversize 280mm Rotor Kit	Relocating Bracket for Oversize Rotor	SMX Series Oversize 320mm Rotor Kit	Relocating Bracket for 320mm Rotor	Front Disc Bolt Kit	FA/SFA/X Pad or Brake Shoe	Specialty Pads SXR/ VEE/MXS Race	Sintered/ HH Pads/ Grooved Shoes	EPFA Sintered Fast Road/ Track Pads	SV Series Severe Duty Pads	Standard Rotor	Vintage Rotor / UTV Oversize Brake Kit	Contour Profile Rotor	CX Extreme® /Vee-Rotor	Rear Disc Bolt Kit	
1						516										
2						SFA408		SFA408HH			MD9103D					
3						SFA408		SFA408HH			MD9103D					
4		OSX6028	BRK008	SMX6028	BRK009	FA152X	MXS152	FA152R			MD6011D					
5	MD6028CX	OSX6028	BRK008	SMX6028	BRK009	FA131X	MXS131	FA131R			MD6135D		MD6135C	MD6135CX		
6						528		528G								
7	MD6356CX	OSX6028	BRK008	SMX6028	BRK009	FA131X	MXS131	FA131R			MD6135D		MD6135C	MD6135CX		
8	MD6356CX	OSX6028	BRK008	SMX6028	BRK009	FA131X	MXS131	FA131R			MD6190D		MD6190C	MD6190CX		
9	MD6028CX	OSX6028	BRK008	SMX6028	BRK009	FA131X	MXS131	FA131R			MD6135D		MD6135C	MD6135CX		
10	MD6356CX	OSX6028	BRK008	SMX6028	BRK009	FA131X	MXS131	FA131R			MD6135D		MD6135C	MD6135CX		
11	MD6356CX	OSX6028	BRK008	SMX6028	BRK009	FA131X	MXS131	FA131R			MD6190D		MD6190C	MD6190CX		
12	MD6356CX	OSX6028	BRK008	SMX6028	BRK009	FA367X	MXS367	FA367R			MD6190D		MD6190C	MD6190CX		
13	MD6356CX	OSX6028	BRK008	SMX6028	BRK009	FA367X	MXS367	FA367R			MD6190D		MD6190C	MD6190CX		
14	MD6356CX	OSX6028	BRK008	SMX6028	BRK009	FA367X	MXS367	FA367R					MD6190C	MD6190CX		
15	MD6392CX	OSX6392	BRK002			FA367X	MXS367	FA367R	EPFA367HH				MD6190C	MD6190CX		
16	MD6392CX	OSX6392	BRK002			FA367X	MXS367	FA367R	EPFA367HH				MD6190C	MD6190CX		
17	MD6392CX	OSX6392	BRK002			FA346X	MXS346	FA346R	EPFA346HH				MD6190C	MD6190CX		
18						FA307X		FA307R		FA307SV	MD6174D					
19						FA307X		FA307R		FA307SV	MD6252D					
20																
21																
22						FA307X		FA307R		FA307SV	MD6252D					
23						FA307X		FA307R		FA307SV	MD6174D					
24																
25						FA307X		FA307R		FA307SV	MD6252D					
26						FA307X		FA307R		FA307SV	MD6174D					
27						FA84X		FA84R		FA84SV	MD6236D					
28																
29						FA323X		FA323R			MD6263D					
30																
31						FA323X		FA323R			MD6263D					
32																
33						FA323X		FA323R			MD6263D					
34																
35						FA323X		FA323R			MD6263D					
36						FA323X		FA323R					MD6263C			
37																
38						FA323X		FA323R					MD6263C			
39																
40						FA323X		FA323R			MD6263D					
41																
42						FA84X		FA84R		FA84SV	MD6236D					
43																
44						FA84X		FA84R		FA84SV	MD6236D					
45																
46						FA323X		FA323R			MD6263D					
47																
48						FA428X		FA428R		FA428SV	MD6242D	UTVX6242				
49																
50	MD6356CX	OSX6028	BRK008	SMX6028	BRK009	FA367X	MXS367	FA367R			MD6190D		MD6190C	MD6190CX		
51	MD6356CX	OSX6028	BRK008	SMX6028	BRK009	FA367X	MXS367	FA367R			MD6190D		MD6190C	MD6190CX		
52	MD6356CX	OSX6028	BRK008	SMX6028	BRK009	FA367X	MXS367	FA367R					MD6190C	MD6190CX		
53	MD6356CX	OSX6728	BRK002	SMX6728	BRK034	FA367X	MXS367	FA367R	EPFA367HH				MD6190C	MD6190CX		
54	MD6392CX	OSX6392	BRK002			FA367X	MXS367	FA367R	EPFA367HH				MD6190C	MD6190CX		
55	MD6392CX	OSX6392	BRK002			FA367X	MXS367	FA367R	EPFA367HH				MD6190C	MD6190CX		
56	MD6392CX	OSX6392	BRK002			FA346X	MXS346	FA346R	EPFA346HH				MD6190C	MD6190CX		

REAR

BRAKE APPLICATIONS

⚠ This symbol indicates a rotor made of billet steel, and should be only used with EBC FA Organic or Vee pads.
SAFETY NOTICE - With vehicles primarily designed for off highway use such as quads now being used on the highway, we would recommend the use of X or MXS pads for highway use and ONLY using the R and SV higher density / harder pad series for off road riding.

*-2 Sets Required. † For Vee disc colours add RED, BLU, GRN, GLD, ORG suffix to part number. **SAFETY WARNING:- DO NOT USE HH PADS ON REAR UNLESS ALSO USED ON FRONT TO AVOID BRAKE IMBALANCE**

FRONT: YAMAHA



YAMAHA



DISC PAD CHOICES - FRONT

BRAKE ROTOR CHOICES - FRONT

Model	Year	FA/SFA/X Pad or Brake Shoe	Specialty Pads SXR/VEE/MXS Race	Sintered/HH Pads/Grooved Shoes	EPFA Sintered Fast Road/Track Pads	GPFAX Sintered RACE ONLY Pads	SV Series Severe Duty Pads	Standard Rotor		Vintage Rotor / UTV Oversize Brake Kit	Contour Profile Rotor	Line #
								Standard Rotor Left	Standard Rotor Right			
YZ 450 F 50th Anniversary Edition	2024	FA755X	MXS755	FA755R							MD6392C	1
YZ 450 F 60th Anniversary Model	2016	FA450X	MXS450	FA450R							MD6392C	2
YZ 450 F F MME	2021-2023	FA755X	MXS755	FA755R							MD6392C	3
YZ 450 F FX	2021-2024	FA755X	MXS755	FA755R							MD6392C	4
IT 465 H	1981-1982	508		508G								5
YZ 465 G	1980	508		508G								6
YZ 465 H	1981	508		508G								7
IT 490 L	1983-1984	508		508G								8
YZ 490 J	1982	508		508G								9
YZ 490 K	1983	508		508G								10
YZ 490 L	1984	508		508G								11
YZ 490 N	1985	FA105X		FA105R				MD6324D				12
YZ 490 S	1986-1987	FA105X		FA105R				MD6067D				13
YZ 490 U	1988-1989	FA105X		FA105R				MD6039D				14
RZ 500 LC	1984-1986	FA88*		FA88HH*	EPFA88HH*			MD2069	MD2069			15
SR 500	1979-1981	FA34	FA34V					MD2023LS				16
TT 500	1980-1981	507		507G								17
WR 500	1992-1993	FA135X	MXS135	FA135R				MD6016D				18
XP 500 T-Max 4B51	2009-2011	SFA252*		SFA252HH*				MD2107	MD2107		MD2107C*	19
XP 500 T-Max 530cc	2015-2016	SFA252*		SFA252HH*				MD2098	MD2098		MD2098C*	20
XP 500 T-Max 530cc	2015-2016		SFA621V									21
XS 500	1976-1978	FA34						MD2024	MD2024	VMD2024*		22
XS 500 B	1975	FA11										23
XT 500	1980-1981	528		528G								24
XV 500 K Virago	1983	FA81		FA81R				MD2023LS				25
XV 535 Virago	1995-1999	FA179	FA179V	FA179HH					MD2076			26
XV 535 Virago	1987-1994	FA136							MD2023RS			27
XJ 550 Maxim	1981-1983	FA70							MD2023RS			28
XJ 550 Seca	1981-1983	FA70							MD2023RS			29
XT 550	1982-1983	510		510G								30
XZ 550 RJ	1982	FA81		FA81R				MD2076				31
XZ 550 RK	1983	FA81*		FA81R*				MD2011	MD2011		MD2011C*	32
YFM 550 EPS Grizzly Fi	Left 2009-2014	FA443X		FA443X			FA443SV	MD6291D				33
	Right	FA444X		FA444R			FA444SV		MD6291D			34
YFM 550 Grizzly Fi	Left 2009-2014	FA443X		FA443R			FA443SV	MD6291D				35
	Right	FA444X		FA444R			FA444SV		MD6291D			36
R515A15B 350cc	1970-1972	513										37
FJ 600	1984-1985	FA88*		FA88HH*	EPFA88HH*			MD2011	MD2011		MD2011C*	38
FZ 600	1986-1988	FA88*		FA88HH*	EPFA88HH*			MD2011	MD2011		MD2011C*	39
FZ6	2004-2006	FA199*		FA199HH*				MD2082X	MD2082X		MD2082XC*	40
FZ6	2007-2009	FA252*		FA252HH*	EPFA252HH*			MD2082X	MD2082X		MD2082XC*	41
FZ6R	2009-2017	FA199*		FA199HH*				MD2082X	MD2082X		MD2082XC*	42
FZR 600	1989	FA88*		FA88HH*	EPFA88HH*			MD2001X	MD2001X		MD2001XC*	43
FZR 600	1990-1999	FA160*		FA160HH*				MD2001X	MD2001X		MD2001XC*	44
SRX 600	1986	FA104*		FA104HH*				MD2011	MD2011		MD2011C*	45
TT 600	1983-1984	508		508G								46
TT 600	1985-1986	FA101X		FA101R				MD6039D				47
XJ 600 S Seca	1992-1998	FA179		FA179HH				MD2031LS				48
XT 600	1984-1986	FA81		FA81R				MD6070D				49
XT 600	1987-1989	FA81		FA81R				MD6070D				50
XT 600	1990-1995	FA172X		FA172R				MD6070D				51
YFM 600 Grizzly	1998-2000	FA84X*		FA84R*			FA84SV*	MD6140D	MD6140D			52
YFM 600 Grizzly/Hunter Edition	2001	FA84X*		FA84R*			FA84SV*	MD6140D	MD6140D			53
YX 600 Radian	1986-1990	FA88*		FA88HH*				MD2011	MD2011		MD2011C*	54
YZF 600	1995-1996	FA160*		FA160HH*				MD2001X	MD2001X		MD2001XC*	55
YZF 600 R Thundercat	1997-2007	FA252*		FA252HH*	EPFA252HH*			MD2074X	MD2074X		MD2074XC*	56

FRONT

APPLIATIONS
BRAKE
SAFETY NOTICE - With vehicles primarily designed for off highway use such as quads now being used on the highway, we would recommend the use of X or MXS pads for highway use and ONLY using the R and SV higher density / harder pad series for off road riding.

*** This symbol indicates a rotor made of billet steel, and should be only used with EBC FA Organic or Vee pads.**

*-2 Sets Required. † For Vee disc colours add RED, BLU, GRN, GLD, ORG suffix to part number. **SAFETY WARNING:- DO NOT USE HH PADS ON REAR UNLESS ALSO USED ON FRONT TO AVOID BRAKE IMBALANCE**

FRONT: YAMAHA Cont'd

REAR: YAMAHA

Line #	BRAKE ROTOR CHOICES - FRONT						DISC PAD CHOICES - REAR						BRAKE ROTOR CHOICES - REAR				
	CX Extreme® /Vee-Rotor	OSX Series Oversize 280mm Rotor Kit	Relocating Bracket for Oversize Rotor	SMX Series Oversize 320mm Rotor Kit	Relocating Bracket for 320mm Rotor	Front Disc Bolt Kit	FA/SFA/X Pad or Brake Shoe	Specialty Pads SXR/ VEE/MXS Race	Sintered/ HH Pads/ Grooved Shoes	EPFA Sintered Fast Road/ Track Pads	SV Series Severe Duty Pads	Standard Rotor	Vintage Rotor / UTV Oversize Brake Kit	Contour Profile Rotor	CX Extreme® /Vee-Rotor	Rear Disc Bolt Kit	
1	MD6392CX	OSX6392	BRK002				FA346X	MXS346	FA346R	EPFA346HH				MD6135C	MD6135CX		
2	MD6392CX	OSX6392	BRK002				FA367X	MXS367	FA367R	EPFA367HH				MD6190C	MD6190CX		
3	MD6392CX	OSX6392	BRK002				FA367X	MXS367	FA367R	EPFA367HH				MD6190C	MD6190CX		
4	MD6392CX						FA367X	MXS367	FA367R	EPFA367HH				MD6135C	MD6135CX		
5							510		510G								
6							528		528G								
7							510		510G								
8							510		510G								
9							510		510G								
10							506		506G								
11							510		510G								
12							510		510G								
13							510		510G								
14							510		510G								
15							FA104		FA104HH			MD2070				DB201/6	
16							510										
17							528		528G								
18							FA152X	MXS152	FA152R			MD6011D					
19							SFA408		SFA408HH			MD2011		MD2011C		DB201/6	
20							SFA319		SFA319HH			MD9143D		MD9143C			
21																	
22							FA34					MD2025	VMD2025				
23							512										
24							510		510G								
25							512										
26							515										
27							515										
28							512										
29							516										
30							510		510G								
31							512										
32	VR2011*						512										
33							FA445X		FA445R		FA445SV	MD6292D*					
34							FA446X		FA446R		FA446SV						
35							FA445X		FA445R		FA445SV	MD6292D*					
36							FA446X		FA446R		FA446SV						
37							514										
38	VR2011*						FA88		FA88HH	EPFA88HH		MD2011		MD2011C	VR2011	DB201/6	
39	VR2011*						FA104		FA104HH			MD2002		MD2002C	VR2002	DB201/6	
40	VR2082BLK*†						FA174		FA174HH			MD2093		MD2093C	VR2093		
41	VR2082BLK*†						FA174		FA174HH			MD2093		MD2093C	VR2093		
42	VR2082BLK*†						FA140		FA140HH			MD2117			VR2117		
43	VR2001BLK*†						FA88		FA88HH	EPFA88HH		MD2002		MD2002C	VR2002	DB201/6	
44	VR2001BLK*†						FA88		FA88HH			MD2002		MD2002C	VR2002	DB201/6	
45	VR2011*						FA104		FA104HH			MD2002		MD2002C	VR2002	DB201/6	
46							506		506G								
47							506		506G								
48							FA104		FA104HH			MD2002				DB201/6	
49							510		510G								
50							510		510G								
51							FA101X		FA101R			MD6072D					
52							516		516G								
53							516		516G								
54	VR2011*						512										
55	VR2001BLK*†						FA88		FA88HH			MD2002		MD2002C	VR2002	DB201/6	
56	VR2074BLK*†						FA88		FA88HH	EPFA88HH		MD2002		MD2002C	VR2002	DB201/6	

⊗ This symbol indicates a rotor made of billet steel, and should be only used with EBC FA Organic or Vee pads.
SAFETY NOTICE - With vehicles primarily designed for off highway use such as quads now being used on the highway, we would recommend the use of X or MXS pads for highway use and ONLY using the R and SV higher density / harder pad series for off road riding.

*-2 Sets Required. † For Vee disc colours add RED, BLU, GRN, GLD, ORG suffix to part number. **SAFETY WARNING:- DO NOT USE HH PADS ON REAR UNLESS ALSO USED ON FRONT TO AVOID BRAKE IMBALANCE**

FRONT: YAMAHA

APPLICATIONS

BRAKE



YAMAHA



DISC PAD CHOICES - FRONT

BRAKE ROTOR CHOICES - FRONT

Model	Year	FA/SFA/X Pad or Brake Shoe	Specialty Pads SXR/VEE/MXS Race	Sintered/HH Pads/Grooved Shoes	EPFA Sintered Fast Road/Track Pads	GPFA Sintered RACE ONLY Pads	SV Series Severe Duty Pads	Standard Rotor		Vintage Rotor / UTV Oversize Brake Kit	Contour Profile Rotor	Line #
								Standard Rotor Left	Standard Rotor Right			
YZF 600 R6	1999-2002	FA252*		FA252HH*	EPFA252HH*			MD2074X	MD2074X		MD2074XC*	1
YZF 600 R6	2003-2004	FA252*		FA252HH*	EPFA252HH*			MD2082X	MD2082X		MD2082XC*	2
YZF-R6	2005-2007			FA380HH*	EPFA380HH*	GPFA380HH*		MD2095X	MD2095X		MD2095XC*	3
YZF-R6	2008-2016			FA380HH*	EPFA380HH*	GPFA380HH*		MD2105X	MD2105X		MD2105XC*	4
YZF-R6 H	2017-2022			FA380HH*	EPFA380HH*	GPFA380HH*		MD2124X	MD2124X		MD2124XC*	5
YZF-R6 S	2006-2009	FA252*		FA252HH*	EPFA252HH*			MD2082X	MD2082X		MD2082XC*	6
TX 650	1974-1976	FA11										7
XJ 650 LH Midnight	1981	FA61	FA61V					MD2024		VMD2024		8
XJ 650 LJ Seca Turbo	1982	FA81*		FA81R*				MD2011	MD2011		MD2011C*	9
XJ 650 LK Seca	1983	FA81*		FA81R*				MD2011	MD2011		MD2011C*	10
XJ 650 Maxim	1980-1983	FA61	FA61V					MD2023LS		VMD2023		11
XJ 650 RJ Seca	1982	FA34*						MD2019LS	MD2019RS			12
XS 650	1977-1979	FA34	FA34V					MD2024		VMD2024		13
XS 650	1978-1980	FA34	FA34V						MD2023RS			14
XS 650	1980-1981	FA34	FA34V						MD2023RS			15
XS 650 Heritage Special	1982-1983	FA34	FA34V					MD2023LS	MD2023RS	VMD2023*		16
XS2/IX 650	1972-1973	FA11										17
XVS 650 V Star Classic	1998-2010	FA179	FA179V	FA179HH					MD2076			18
XVS 650 V Star Custom	1997-2011	FA179	FA179V	FA179HH					MD2076			19
XVS 650 V Star Custom	2013-2020	FA179	FA179V	FA179HH					MD2076			20
XVS 650 V-Star Silverado	2003-2010	FA179	FA179V	FA179HH					MD2076			21
YFM 660 Ducks Unlimited Edition	2006-2007	FA84X*		FA84R*			FA84SV*	MD6189D	MD6189D			22
YFM 660 Grizzly Hunter Edition	2002-2008	FA84X*		FA84R*			FA84SV*	MD6189D	MD6189D			23
YFM 660 Raptor	2001-2005	FA84X*		FA84R*			FA84SV*	MD6054D	MD6054D			24
YXR 660	2004-2007	Left Right		FA165X FA135X	FA165R FA135R		FA165SV FA135SV	MD6241D		UTV6241*		25
FZ 700 Genesis	1987		FA88V*	FA88HH*	EPFA88HH*			MD2011	MD2011		MD2011C*	26
FZ-07	2015-2017			FA252*	FA252HH*	EPFA252HH*		MD2127X	MD2127X		MD2127XC*	27
FZ-07 A	2017			FA252*	FA252HH*	EPFA252HH*		MD2127X	MD2127X		MD2127XC*	28
FZX 700 Fazer	1986-1987		FA88V*	FA88HH*	EPFA88HH*			MD2011	MD2011		MD2011C*	29
MT-07	2018-2023			FA252*	FA252HH*	EPFA252HH*		MD2127X	MD2127X		MD2127XC*	30
XJ 700	1985-1986			FA88*	FA88HH*	EPFA88HH*		MD2011	MD2011		MD2011C*	31
XSR 700 MTM 690-U	2018-2023			FA252*	FA252HH*	EPFA252HH*					MD2127XC*	32
XTZ 700 T7 Tenere	2019-2024			FA181X*	MXS181*	FA181R*		MD2127X	MD2127X		MD2127XC*	33
XTZ 700 T7 Tenere Rally	2020-2023			FA181X*	MXS181*	FA181R*		MD2127X	MD2127X		MD2127XC*	34
XV 700	1984-1987			FA88*	FA88HH*	EPFA88HH*		MD2011	MD2011		MD2011C*	35
YFM 700 DHFH Grizzly Hunter	2015-2022	Left Right		FA443X FA444X	FA443R FA444R		FA443SV FA444SV	MD6291D			MD6291D	36
YFM 700 Ducks Unlimited Edition	2007-2009	Left Right		FA443X*	FA443R*		FA443SV*	MD6291D			MD6291D	37
YFM 700 Grizzly	2008-2014	Left Right		FA443X FA444X	FA443R FA444R		FA443SV FA444SV	MD6291D			MD6291D	38
YFM 700 Grizzly	2007-2014	Left Right		FA443X FA444X	FA443R FA444R		FA443SV FA444SV	MD6291D			MD6291D	39
YFM 700 Grizzly	2015-2022	Left Right		FA443X FA444X	FA443R FA444R		FA443SV FA444SV	MD6291D			MD6291D	40
YFM 700 Grizzly FI EPS Special Edition	2009-2014	Left Right		FA443X FA444X	FA443R FA444R		FA443SV FA444SV	MD6291D			MD6291D	41
YFM 700 Kodiak 700 4WD	2016-2022	Left Right		FA443X FA444X	FA443R FA444R		FA443SV FA444SV	MD6291D			MD6291D	42
YFM 700 Kodiak 700 4WD Hunter	2016-2022	Left Right		FA443X FA444X	FA443R FA444R		FA443SV FA444SV	MD6291D			MD6291D	43
YFM 700 Kodiak 700 EPS 4WD	2016-2022	Left Right		FA443X FA444X	FA443R FA444R		FA443SV FA444SV	MD6291D			MD6291D	44
YFM 700 Kodiak 700 EPS 4WD Hunter	2016-2022	Left Right		FA443X FA444X	FA443R FA444R		FA443SV FA444SV	MD6291D			MD6291D	45

FRONT

* This symbol indicates a rotor made of billet steel, and should be only used with EBC FA Organic or Vee pads.
 SAFETY NOTICE - With vehicles primarily designed for off highway use such as quads now being used on the highway, we would recommend the use of X or MXS pads for highway use and ONLY using the R and SV higher density / harder pad series for off road riding.

*-2 Sets Required. † For Vee disc colours add RED, BLU, GRN, GLD, ORG suffix to part number. **SAFETY WARNING:- DO NOT USE HH PADS ON REAR UNLESS ALSO USED ON FRONT TO AVOID BRAKE IMBALANCE**

FRONT: YAMAHA Cont'd

REAR: YAMAHA

Line #	BRAKE ROTOR CHOICES - FRONT					DISC PAD CHOICES - REAR					BRAKE ROTOR CHOICES - REAR					
	CX Extreme® /Vee-Rotor	OSX Series Oversize 280mm Rotor Kit	Relocating Bracket for Oversize Rotor	SMX Series Oversize 320mm Rotor Kit	Relocating Bracket for 320mm Rotor	Front Disc Bolt Kit	FA/SFA/X Pad or Brake Shoe	Specialty Pads SXR/ VEE/MXS Race	Sintered/ HH Pads/ Grooved Shoes	EPFA Sintered Fast Road/ Track Pads	SV Series Severe Duty Pads	Standard Rotor	Vintage Rotor / UTV Oversize Brake Kit	Contour Profile Rotor	CX Extreme® /Vee-Rotor	Rear Disc Bolt Kit
1	VR2074BLK*†						FA275		FA275HH			MD2084		MD2084C	VR2084	
2	VR2082BLK*†						FA174		FA174HH			MD2091		MD2091C	VR2091	
3	VR2095BLK*†						FA174		FA174HH			MD2091		MD2091C	VR2091	
4	VR2105BLK*†						FA174		FA174HH			MD2091		MD2091C	VR2091	
5	VR2124BLK*†						FA436		FA436HH			MD2091		MD2091C	VR2091	
6	VR2082BLK*†						FA174		FA174HH			MD2091		MD2091C	VR2091	
7							514									
8							512									
9	VR2011*					DB201/6	515									
10	VR2011*					DB201/6	515									
11							512									
12							515									
13							514									
14							FA34					MD2025	VMD2025			
15							514									
16							514									
17							514									
18							515									
19							515									
20							515									
21							515									
22							FA344X		FA344R		FA344SV	MD6197D				
23							FA344X		FA344R		FA344SV	MD6197D				
24							FA84X		FA84R		FA84SV	MD6237D				
25							FA428X		FA428R		FA428SV	MD6242D	UTVX6242			
26																
27	VR2011*					DB201/6	FA88		FA88HH	EPFA88HH		MD2011		MD2011C	VR2011	DB201/6
28	VR2127BLK*†						FA174		FA174HH			MD2120		MD2120C	VR2120	
29	VR2127BLK*†						FA174		FA174HH			MD2120		MD2120C	VR2120	
30	VR2011*					DB201/6	FA88		FA88HH	EPFA88HH		MD2069				DB201/6
31	VR2127BLK*†						FA174		FA174HH			MD2120		MD2120C	VR2120	
32	VR2011*					DB201/6	515									
33	VR2127BLK*†						FA174		FA174HH			MD2120		MD2120C	VR2120	
34	VR2127BLK*†						FA208X	MXS208	FA208R			MD2120		MD2120C	VR2120	
35	VR2127BLK*†						FA208X	MXS208	FA208R			MD2120		MD2120C	VR2120	
36	VR2011*					DB201/6	515									
37							FA445X		FA445R		FA445SV	MD6292D*				
38							FA446X		FA446R		FA446SV					
39							FA445X		FA445R		FA445SV	MD6292D*				
40							FA446X		FA446R		FA446SV					
41							FA445X		FA445R		FA445SV	MD6292D*				
42							FA446X		FA446R		FA446SV					
43							FA445X		FA445R		FA445SV	MD6292D*				
44							FA446X		FA446R		FA446SV					
45							FA445X		FA445R		FA445SV	MD6292D*				
46							FA446X		FA446R		FA446SV					
47							FA445X		FA445R		FA445SV	MD6292D*				
48							FA446X		FA446R		FA446SV					
49																
50																
51																
52																
53																
54																
55																
56																

BRAKE APPLICATIONS

⚠ This symbol indicates a rotor made of billet steel, and should be only used with EBC FA Organic or Vee pads. SAFETY NOTICE - With vehicles primarily designed for off highway use such as quads now being used on the highway, we would recommend the use of X or MXS pads for highway use and ONLY using the R and SV higher density / harder pad series for off road riding.

*-2 Sets Required. † For Vee disc colours add RED, BLU, GRN, GLD, ORG suffix to part number. **SAFETY WARNING:- DO NOT USE HH PADS ON REAR UNLESS ALSO USED ON FRONT TO AVOID BRAKE IMBALANCE**

FRONT: YAMAHA



YAMAHA



DISC PAD CHOICES - FRONT

BRAKE ROTOR CHOICES - FRONT

YFM 700 Kodiak 700 EPS 4WD SE	Left	2016-2022	FA/SFA/X Pad or Brake Shoe	Specialty Pads SXR/VEE/MXS Race	Sintered/HH Pads/Grooved Shoes	EPFA Sintered Fast Road/Track Pads	GPFAX Sintered RACE ONLY Pads	SV Series Severe Duty Pads	Standard Rotor Left	Standard Rotor Right	Vintage Rotor / UTV Oversize Brake Kit	Contour Profile Rotor	Line #
			FA443X		FA443R				FA443SV	MD6291D			
	Right		FA444X		FA444R			FA444SV		MD6291D			1
YFM 700 PFG Grizzly EPS	Left	2015-2022	FA443X		FA443R			FA443SV	MD6291D				2
	Right		FA444X		FA444R			FA444SV		MD6291D			3
YFM 700 PHFH Grizzly EPS Hunter	Left	2015-2022	FA443X		FA443R			FA443SV	MD6291D				4
	Right		FA444X		FA444R			FA444SV		MD6291D			5
YFM 700 Raptor	Left	2006-2012	FA165X		FA165R			FA165SV	MD6054D				6
	Right		FA135X		FA135R			FA135SV		MD6054D			7
YFM 700 Raptor	Left	2013-2014	FA165X		FA165R			FA165SV	MD6054D				8
	Right		FA135X		FA135R			FA135SV		MD6054D			9
YFM 700 Raptor Special Edition	Left	2007-2008	FA165X		FA165R			FA165SV	MD6054D				10
	Right		FA135X		FA135R			FA135SV		MD6054D			11
YFM 700 Raptor Special Edition	Left	2009-2015	FA165X		FA165R			FA165SV	MD6054D				12
	Right		FA135X		FA135R			FA135SV		MD6054D			13
YFM 700 RSPV - Raptor 50th Anniversary Edition	Left	2006	FA165X		FA165R			FA165SV	MD6054D				14
	Right		FA135X		FA135R			FA135SV		MD6054D			15
YXC 700 PRGC Viking VI EPS Ranger Edition	Left	2016	FA642X		FA642R			FA642SV	MD6382D		UTVX6382*		16
	Right		FA645X		FA645R			FA645SV		MD6382D			17
YXC 700 PRGC Viking VI EPS Ranger Edition		2016											18
YXC 700 Viking VI		2015-2016											19
YXC 700 Viking VI	Left	2015-2016	FA642X		FA642R			FA642SV	MD6382D		UTVX6382*		20
	Right		FA645X		FA645R			FA645SV		MD6382D			21
YXC 700 Viking VI EPS	Left	2015-2016	FA642X		FA642R			FA642SV	MD6382D		UTVX6382*		22
	Right		FA645X		FA645R			FA645SV		MD6382D			23
YXC 700 Viking VI EPS		2015-2016											24
YXC 700 Viking VI EPS SE	Left	2015-2016	FA642X		FA642R			FA642SV	MD6382D		UTVX6382*		25
	Right		FA645X		FA645R			FA645SV		MD6382D			26
YXC 700 Viking VI EPS SE		2015-2016											27
YXM 700 Viking	Left	2014-2016	FA642X		FA642R			FA642SV	MD6382D		UTVX6382*		28
	Right		FA645X		FA645R			FA645SV		MD6382D			29
YXM 700 Viking		2014-2016											30
YXM 700 Viking EPS	Left	2014-2016	FA642X		FA642R			FA642SV	MD6382D		UTVX6382*		31
	Right		FA645X		FA645R			FA645SV		MD6382D			32
YXM 700 Viking EPS		2014-2016											33
YXM 700 Viking EPS SE	Left	2014-2016	FA642X		FA642R			FA642SV	MD6382D		UTVX6382*		34
	Right		FA645X		FA645R			FA645SV		MD6382D			35
YXM 700 Viking EPS SE		2014-2016											36
YXP 700 Pro Hauler 700		2004-2006											37
YXR 700 Rhino	Left	2008	FA165X		FA165R			FA165SV	MD6241D		UTVX6241*		38
	Right		FA135X		FA135R			FA135SV		MD6241D			39
YXR 700 Rhino		2008											40
YXR 700 Rhino FI	Left	2009	FA165X		FA165R			FA165SV	MD6241D		UTVX6241*		41
	Right		FA135X		FA135R			FA135SV		MD6241D			42
YXR 700 Rhino FI		2009											43
YXR 700 Rhino FI	Left	2011-2013	FA165X		FA165R			FA165SV	MD6241D		UTVX6241*		44
	Right		FA135X		FA135R			FA135SV		MD6241D			45
YXR 700 Rhino FI Sport Edition	Left	2011-2013	FA165X		FA165R			FA165SV	MD6241D		UTVX6241*		46
	Right		FA135X		FA135R			FA135SV		MD6241D			47
YXR 700 Rhino FI Sport Edition		2011-2013											48
YXR 700 Rhino FI Ducks Unlimited Version	Left	2009	FA165X		FA165R			FA165SV	MD6241D		UTVX6241*		49
	Right		FA135X		FA135R			FA135SV		MD6241D			50
YXR 700 Rhino FI Ducks Unlimited Version		2009											51
YXR 700 Rhino FI Sport Edition	Left	2009	FA165X		FA165R			FA165SV	MD6241D		UTVX6241*		52
	Right		FA135X		FA135R			FA135SV		MD6241D			53
YXR 700 Rhino FI Sport Edition		2009											54
YXR 700 Rhino FI Sport Edition	Left	2009	FA165X		FA165R			FA165SV	MD6241D		UTVX6241*		55
	Right		FA135X		FA135R			FA135SV		MD6241D			56

APPLICATIONS

BRAKE
 This symbol indicates a rotor made of billet steel, and should be only used with EBC FA Organic or Vee pads.
 SAFETY NOTICE - With vehicles primarily designed for off highway use such as quads now being used on the highway, we would recommend the use of X or MXS pads for highway use and ONLY using the R and SV higher density / harder pad series for off road riding.

*-2 Sets Required. † For Vee disc colours add RED, BLU, GRN, GLD, ORG suffix to part number. **SAFETY WARNING:- DO NOT USE HH PADS ON REAR UNLESS ALSO USED ON FRONT TO AVOID BRAKE IMBALANCE**

FRONT: YAMAHA Cont'd

REAR: YAMAHA

Line #	BRAKE ROTOR CHOICES - FRONT					DISC PAD CHOICES - REAR					BRAKE ROTOR CHOICES - REAR					
	CX Extreme® /Vee-Rotor	OSX Series Oversize 280mm Rotor Kit	Relocating Bracket for Oversize Rotor	SMX Series Oversize 320mm Rotor Kit	Relocating Bracket for 320mm Rotor	Front Disc Bolt Kit	FA/SFA/X Pad or Brake Shoe	Specialty Pads SXR/ VEE/MXS Race	Sintered/ HH Pads/ Grooved Shoes	EPFA Sintered Fast Road/ Track Pads	SV Series Severe Duty Pads	Standard Rotor	Vintage Rotor / UTV Oversize Brake Kit	Contour Profile Rotor	CX Extreme® /Vee-Rotor	Rear Disc Bolt Kit
1																
2																
3																
4							FA445X	FA445R		FA445SV	MD6292D*					
5							FA446X	FA446R		FA446SV						
6							FA445X	FA445R		FA445SV	MD6292D*					
7							FA446X	FA446R		FA446SV						
8							FA428X	FA428R		FA428SV	MD6263D					
9							FA323X	FA323R					MD6263C			
10							FA428X	FA428R		FA428SV	MD6263D					
11							FA428X	FA428R		FA428SV			MD6263C			
12							FA428X	FA428R		FA428SV	MD6263D					
13							FA674X	FA674R		FA674SV	MD6382D*	UTVX6382*				
14							FA675X	FA675R		FA675SV						
15							FA497X				MD6381D					
16							FA497X				MD6381D					
17							FA674X	FA674R		FA674SV	MD6382D*	UTVX6382*				
18							FA675X	FA675R		FA675SV						
19							FA674X	FA674R		FA674SV	MD6382D*	UTVX6382*				
20							FA675X	FA675R		FA675SV						
21							FA674X	FA674R		FA674SV	MD6382D*	UTVX6382*				
22							FA675X	FA675R		FA675SV						
23							FA674X	FA674R		FA674SV	MD6382D*	UTVX6382*				
24							FA675X	FA675R		FA675SV						
25							FA497X				MD6381D					
26							FA674X	FA674R		FA674SV	MD6382D*	UTVX6382*				
27							FA675X	FA675R		FA675SV						
28							FA497X				MD6381D					
29							FA674X	FA674R		FA674SV	MD6382D*	UTVX6382*				
30							FA675X	FA675R		FA675SV						
31							FA497X				MD6381D					
32							FA674X	FA674R		FA674SV	MD6382D*	UTVX6382*				
33							FA675X	FA675R		FA675SV						
34							FA497X				MD6381D					
35							FA674X	FA674R		FA674SV	MD6382D*	UTVX6382*				
36							FA675X	FA675R		FA675SV						
37							FA497X				MD6381D					
38							534*	534G*								
39							FA165X	FA165R		FA165SV	MD6332D*	UTVX6332*				
40							FA135X	FA135R		FA135SV						
41							FA497X				MD6333D					
42							FA165X	FA165R		FA165SV	MD6332D*	UTVX6332*				
43							FA135X	FA135R		FA135SV						
44							FA497X				MD6333D					
45							FA165X	FA165R		FA165SV	MD6332D*	UTVX6332*				
46							FA135X	FA135R		FA135SV						
47							FA497X				MD6333D					
48							FA165X	FA165R		FA165SV	MD6332D*	UTVX6332*				
49							FA135X	FA135R		FA135SV						
50							FA497X				MD6333D					
51							FA165X	FA165R		FA165SV	MD6332D*	UTVX6332*				
52							FA135X	FA135R		FA135SV						
53							FA497X				MD6333D					
54							FA165X	FA165R		FA165SV	MD6332D*	UTVX6332*				
55							FA135X	FA135R		FA135SV						
56							FA497X				MD6333D					

⊗ This symbol indicates a rotor made of billet steel, and should be only used with EBC FA Organic or Vee pads.
SAFETY NOTICE - With vehicles primarily designed for off highway use such as quads now being used on the highway, we would recommend the use of X or MXS pads for highway use and ONLY using the R and SV higher density / harder pad series for off road riding.

*-2 Sets Required. † For Vee disc colours add RED, BLU, GRN, GLD, ORG suffix to part number. **SAFETY WARNING:- DO NOT USE HH PADS ON REAR UNLESS ALSO USED ON FRONT TO AVOID BRAKE IMBALANCE**

FRONT: YAMAHA



YAMAHA



DISC PAD CHOICES - FRONT

BRAKE ROTOR CHOICES - FRONT

Model	Year	FA/SFA/X Pad or Brake Shoe	Specialty Pads SXR/VEE/MXS Race	Sintered/HH Pads/ Grooved Shoes	EPFA Sintered Fast Road/Track Pads	GPFA Sintered RACE ONLY Pads	SV Series Severe Duty Pads	Standard Rotor		Vintage Rotor / UTV Oversize Brake Kit	Contour Profile Rotor	Line #
								Standard Rotor Left	Standard Rotor Right			
YZF-R7	2022-2024			FA252HH*	EPFA252HH*			MD2119X	MD2119X		MD2119XC*	1
FZ 750	1985-1988	FA88*		FA88HH*	EPFA88HH*			MD2069	MD2069			2
FZR 750	1989-1992	FA145*		FA145HH*	EPFA145HH*			MD2009LS	MD2009RS			3
FZR 750 Genesis	1987-1988	FA123*		FA123HH*				MD2003X	MD2003X		MD2003XC*	4
TX 750ITX 750 A	1973-1974	FA11										5
XJ 750 Maxim	1982	FA81*		FA81R*				MD2019LS	MD2019RS			6
XJ 750 Seca	1981-1983	FA70*	FA70V*					MD2023LS	MD2023RS	VMD2023*		7
XS 750	1977-1979	FA34*	FA34V*					MD2025	MD2025	VMD2025*		8
XS 750	1978-1979	FA61	FA61V					MD2025		VMD2025*		9
		FA41	FA41V						MD2025			10
XV 750 Virago	1981-1983	FA61	FA61V					MD2023LS		VMD2023		11
XV 750 Virago	1988-1994	FA88*	FA88V*	FA88HH*	EPFA88HH*			MD2011	MD2011		MD2011C*	12
XV 750 Virago	1994-1997	FA88*	FA88V*	FA88HH*	EPFA88HH*			MD2067	MD2067			13
YZF 750	1993-1996	FA190*		FA190HH*	EPFA190HH*			MD2003X	MD2003X		MD2003XC*	14
YZF 750 Race Version	1999-2001			FA424HH*								15
YZF 750 Road Version	1999-2001			FA252HH*	EPFA252HH*			MD2083	MD2083			16
FZ8	2011-2013			FA380HH*	EPFA380HH*			MD2095X	MD2095X		MD2095XC*	17
Niken GT MXT 850D	2019-2020			FA380HH*	EPFA380HH*							18
Niken MXT850	2018-2021			FA380HH*	EPFA380HH*							19
TDM 850	1992-1993	FA123*	FA123V*	FA123HH*				MD2001X	MD2001X		MD2001XC*	20
XS 850	1980-1981	FA34*	FA34V*					MD2025	MD2025	VMD2025*		21
XS 850	1980-1981	FA61	FA61V					MD2024		VMD2024*		22
		FA41	FA41V						MD2024			23
MT-09 MTN 890	2018-2023	FA252*		FA252HH*	EPFA252HH*			MD2119X	MD2119X		MD2119XC*	24
MT-09 SP MTN 890D	2021-2024	FA252*		FA252HH*	EPFA252HH*			MD2082X	MD2082X		MD2082XC*	25
FJ-09	2015-2016	FA252*		FA252HH*	EPFA252HH*			MD2119X	MD2119X		MD2119XC*	26
FZ-09	2014-2017	FA252*		FA252HH*	EPFA252HH*			MD2119X	MD2119X		MD2119XC*	27
Tracer 9 GT	2019-2022	FA252*		FA252HH*	EPFA252HH*			MD2082X	MD2082X			28
Tracer 9 GT +	2024	FA252*		FA252HH*	EPFA252HH*			MD2082X	MD2082X			29
Tracer 900	2018-2023	FA252*		FA252HH*	EPFA252HH*			MD2119X	MD2119X		MD2119XC*	30
XJ 900 RK Seca	1983	FA88*	FA88V*	FA88HH*	EPFA88HH*			MD2069	MD2069			31
XSR 900 MTM 850	2016-2024			FA380HH*	EPFA380HH*			MD2119X	MD2119X		MD2119XC*	32
XV 920 J Virago	1982	FA70*	FA70V*					MD2019LS	MD2019RS			33
XV 920 K	1983	FA61	FA61V					MD2024		VMD2024		34
XV 920 MK Virago	1983	FA61	FA61V					MD2024		VMD2024		35
XV 920 RHRJ	1981-1982	FA34*	FA34V*					MD2019LS	MD2019RS			36
SCR 950	2017	FA179	FA179V	FA179HH								37
XVS 950 Bolt	2014-2016	FA179	FA179V	FA179HH							MD2074XC	38
XVS 950 Bolt C Spec	2015-2021	FA179	FA179V	FA179HH							MD2074XC	39
XVS 950 Bolt R Spec	2014-2023	FA179	FA179V	FA179HH							MD2074XC	40
XVS 950 V-Star 950	2009-2014	FA179	FA179V	FA179HH				MD2089X			MD2089XC	41
XVS 950 V-Star 950 Tourer	2009-2014	FA179	FA179V	FA179HH				MD2089X			MD2089XC	42
FZ1	2001-2005	FA252*		FA252HH*	EPFA252HH*			MD2074X	MD2074X		MD2074XC*	43
FZ1	2006-2014			FA380HH*	EPFA380HH*			MD2101X	MD2101X		MD2101XC*	44
FZ-10	2017			FA380HH*	EPFA380HH*			MD2124X	MD2124X		MD2124XC*	45
FZR 1000 EX UP	1990-1991	FA160*		FA160HH*				MD2003X	MD2003X		MD2003XC*	46
FZR 1000 EX UP	1992-1993	FA182*		FA182HH*				MD2003X	MD2003X		MD2003XC*	47
FZR 1000 EX UP	1994-1996	FA190*		FA190HH*	EPFA190HH*			MD2003X	MD2003X		MD2003XC*	48
FZR 1000 Genesis	1989	FA123*		FA123HH*				MD2003X	MD2003X		MD2003XC*	49
FZR 1000 Genesis	1987-1988	FA123*		FA123HH*				MD2003X	MD2003X		MD2003XC*	50
GTS 1000	1993-1996	FA191										51
MT 10 MTN 1000	2018-2023			FA380HH*	EPFA380HH*			MD2124X	MD2124X		MD2124XC*	52
MT 10 SP MTN 1000D	2022-2023			FA380HH*	EPFA380HH*			MD2124X	MD2124X		MD2124XC*	53
XV 1000	1984-1985	FA88*		FA88HH*	EPFA88HH*			MD2068	MD2068			54
YXE 1000 RMAX 2 YXE 10WP	2021-2024	FA676X*	SXR676HH*	FA676R*			FA676SV*	MD6443D	MD6443D			55
YXE 1000 RMAX 4 YXF 10W	2021-2024	FA676X*	SXR676HH*	FA676R*			FA676SV*	MD6443D	MD6443D			56

APPLICATIONS
BRAKE

⚠ This symbol indicates a rotor made of billet steel, and should be only used with EBC FA Organic or Vee pads.
SAFETY NOTICE - With vehicles primarily designed for off highway use such as quads now being used on the highway, we would recommend the use of X or MXS pads for highway use and ONLY using the R and SV higher density / harder pad series for off road riding.

FRONT

*-2 Sets Required. † For Vee disc colours add RED, BLU, GRN, GLD, ORG suffix to part number. SAFETY WARNING:- DO NOT USE HH PADS ON REAR UNLESS ALSO USED ON FRONT TO AVOID BRAKE IMBALANCE

FRONT: YAMAHA Cont'd

REAR: YAMAHA

Line #	BRAKE ROTOR CHOICES - FRONT					DISC PAD CHOICES - REAR					BRAKE ROTOR CHOICES - REAR					
	CX Extreme® /Vee-Rotor	OSX Series Oversize 280mm Rotor Kit	Relocating Bracket for Oversize Rotor	SMX Series Oversize 320mm Rotor Kit	Relocating Bracket for 320mm Rotor	Front Disc Bolt Kit	FA/SFA/X Pad or Brake Shoe	Specialty Pads SXR/ VEE/MXS Race	Sintered/ HH Pads/ Grooved Shoes	EPFA Sintered Fast Road/ Track Pads	SV Series Severe Duty Pads	Standard Rotor	Vintage Rotor / UTV Oversize Brake Kit	Contour Profile Rotor	CX Extreme® /Vee-Rotor	Rear Disc Bolt Kit
1								FA174HH				MD2120		MD2120C	VR2120	
2							FA88	FA88HH	EPFA88HH			MD2069				
3							FA88	FA88HH	EPFA88HH			MD2008				
4	VR2003BLK*†						FA88	FA88HH				MD2011		MD2011C		
5							515									
6							515									
7							515									
8							FA34					MD2025	VMD2025			
9							FA34					MD2025	VMD2025			
10																
11							512									
12	VR2011*						515									
13							515									
14	VR2003BLK*†						FA88	FA88HH	EPFA88HH			MD2002		MD2002C		DB201/6
15																
16							FA267	FA267HH				MD2086				
17	VR2095BLK*†						FA174	FA174HH				MD2116		MD2116C		
18								FA174HH								
19								FA174HH								
20	VR2001BLK*†						FA88	FA88HH				MD2002		MD2002C		DB201/6
21							FA34					MD2025	VMD2025			
22							FA34					MD2025	VMD2025			
23																
24	VR2119BLK*†						FA174	FA174HH				MD2120		MD2120C	VR2120	
25	VR2082BLK*†						FA174	FA174HH				MD2120		MD2120C	VR2120	
26	VR2119BLK*†						FA174	FA174HH				MD2120		MD2120C	VR2120	
27	VR2119BLK*†						FA174	FA174HH				MD2120		MD2120C	VR2120	
28							FA174	FA174HH				MD2120		MD2120C	VR2120	
29							FA174	FA174HH				MD2120		MD2120C	VR2120	
30	VR2119BLK*†						FA174	FA174HH				MD2120		MD2120C	VR2120	
31							FA88	FA88HH	EPFA88HH			MD2069				DB201/6
32	VR2119BLK*†						FA174	FA174HH				MD2120		MD2120C	VR2120	
33							515									
34							515									
35							515									
36							515									
37							FA319/2	FA319/2HH				MD2103		MD2130C		
38							FA319/2	FA319/2HH						MD2130C		
39							FA319/2	FA319/2HH						MD2130C		
40							FA319/2	FA319/2HH						MD2130C		
41	VR2089BLK†						FA319/2	FA319/2HH				MD2103			VR2103	
42	VR2089BLK†						FA319/2	FA319/2HH				MD2103			VR2103	
43	VR2074BLK*†						FA348	FA348HH				MD2011		MD2011C	VR2011	DB201/6
44	VR2101BLK*†						FA174	FA174HH				MD2093		MD2093C	VR2093	
45	VR2124BLK*†						FA174	FA174HH				MD2091		MD2091C	VR2091	
46	VR2003BLK*†						FA88	FA88HH				MD2011		MD2011C	VR2011	DB201/6
47	VR2003BLK*†						FA88	FA88HH				MD2011		MD2011C	VR2011	DB201/6
48	VR2003BLK*†						FA88	FA88HH	EPFA88HH			MD2011		MD2011C	VR2011	DB201/6
49	VR2003BLK*†						FA88	FA88HH				MD2011		MD2011C	VR2011	DB201/6
50	VR2003BLK*†						FA88	FA88HH				MD2011		MD2011C	VR2011	DB201/6
51							FA88	FA88HH				MD2075				
52	VR2124BLK*†						FA174	FA174HH				MD2091		MD2091C	VR2091	
53	VR2124BLK*†						FA174	FA174HH				MD2091		MD2091C	VR2091	
54							515									
55							FA677X*	FA677R*		FA677SV*		MD6442D*				
56							FA677X*	FA677R*		FA677SV*		MD6442D*				

BRAKE APPLICATIONS

⚠ This symbol indicates a rotor made of billet steel, and should be only used with EBC FA Organic or Vee pads. SAFETY NOTICE - With vehicles primarily designed for off highway use such as quads now being used on the highway, we would recommend the use of X or MXS pads for highway use and ONLY using the R and SV higher density / harder pad series for off road riding.

*-2 Sets Required. † For Vee disc colours add RED, BLU, GRN, GLD, ORG suffix to part number. **SAFETY WARNING:- DO NOT USE HH PADS ON REAR UNLESS ALSO USED ON FRONT TO AVOID BRAKE IMBALANCE**

FRONT: YAMAHA

APPLICATIONS
BRAKE



YAMAHA



DISC PAD CHOICES - FRONT

BRAKE ROTOR CHOICES - FRONT

Model	Year	FA/SFA/X Pad or Brake Shoe	Specialty Pads SXR/VEE/MXS Race	Sintered/HH Pads/Grooved Shoes	EPFA Sintered Fast Road/Track Pads	GPFAX Sintered RACE ONLY Pads	SV Series Severe Duty Pads	Standard Rotor		Vintage Rotor / UTV Oversize Brake Kit	Contour Profile Rotor	Line #
								Standard Rotor Left	Standard Rotor Right			
YXP 1000 Pro Hauler 1000	2004-2005	534*		534G*								1
YXZ 1000 EPS R	2016-2018	FA676X*	SXR676HH*	FA676R*			FA676SV*	MD6395D	MD6395D	UTVX6395*		2
YXZ 1000 EPS R	2019-2024	FA676X*	SXR676HH*	FA676R*			FA676SV*	MD6443D	MD6443D			3
YXZ 1000 EPS R SE	2016-2018	FA676X*	SXR676HH*	FA676R*			FA676SV*	MD6395D	MD6395D	UTVX6395*		4
YXZ 1000 EPS R SE	2019-2024	FA676X*	SXR676HH*	FA676R*			FA676SV*	MD6443D	MD6443D	UTVX6395*		5
YZF 1000 R Thunderace	1997	FA252*		FA252HH*	EPFA252HH*			MD2074X	MD2074X		MD2074XC*	6
YZF-R1	1998-2001	FA252*		FA252HH*	EPFA252HH*	GPFAX380HH*		MD2074X	MD2074X		MD2074XC*	7
YZF-R1	2002-2003	FA252*		FA252HH*	EPFA252HH*	GPFAX380HH*		MD2074X	MD2074X		MD2074XC*	8
YZF-R1	2007-2008	FA442/4*		FA442/4HH*	EPFA442/4HH*	GPFAX442/4HH*		MD2102X	MD2102X		MD2102XC*	9
YZF-R1	2009-2014	FA442/4*		FA442/4HH*	EPFA442/4HH*	GPFAX442/4HH*		MD2102X	MD2102X		MD2102XC*	10
YZF-R1	2015-2023			FA380HH*	EPFA380HH*	GPFAX380HH*		MD2124X	MD2124X		MD2124XC*	11
YZF-R1 5VY	2004-2006			FA380HH*	EPFA380HH*	GPFAX380HH*		MD2094X	MD2094X		MD2094XC*	12
YZF-R1 LE	2006			FA380HH*	EPFA380HH*	GPFAX380HH*		MD2112X	MD2112X			13
YZF-R1 M	2015-2023			FA380HH*	EPFA380HH*	GPFAX380HH*		MD2124X	MD2124X		MD2124XC*	14
YZF-R1 S	2016-2019			FA380HH*	EPFA380HH*	GPFAX380HH*		MD2124X	MD2124X		MD2124XC*	15
FJ 1100	1984-1985	FA88*		FA88HH*	EPFA88HH*			MD2068	MD2068			16
XJ 1100 J	1982	FA70*						MD2024	MD2024	VMD2024*		17
XS 1100	1978-1981	FA34*						MD2024	MD2024	VMD2024*		18
XS 1100	Left 1979-1981	FA61	FA61V					MD2024		VMD2024*		19
	Right	FA41	FA41V						MD2024			20
XS 1100 LG Midnight Special	Left 1980	FA61	FA61V					MD2024		VMD2024*		21
	Right	FA41	FA41V						MD2024			22
XS 1100 LH Midnight Special	1981	FA70*	FA70V*					MD2024	MD2024	VMD2024*		23
XV 1100 All models	1986-1997	FA88*	FA88V*	FA88HH*	EPFA88HH*			MD2011	MD2011		MD2011C*	24
XVS 1100 V-Star Classic	2001-2003	FA199*	FA199V*	FA199HH*				MD2076	MD2076			25
XVS 1100 V-Star Classic	2004-2009	FA199*	FA199V*	FA199HH*				MD2074X	MD2074X		MD2074XC*	26
XVS 1100 V-Star Custom	1999-2008	FA199*	FA199V*	FA199HH*				MD2076	MD2076			27
XVS 1100 V-Star Silverado	2003	FA199*	FA199V*	FA199HH*				MD2076	MD2076			28
XVS 1100 V-Star Silverado	2004-2009	FA199*	FA199V*	FA199HH*				MD2074X	MD2074X		MD2074XC*	29
XVS 1100 W-M V-Star Custom Midnight	2007-2008	FA199*	FA199V*	FA199HH*				MD2076	MD2076			30
FJ 1200	1986-1987	FA88*		FA88HH*	EPFA88HH*			MD2068	MD2068			31
FJ 1200	1989-1990	FA123*		FA123HH*				MD2001X	MD2001X		MD2001XC*	32
FJ 1200	1990-1992	FA123*		FA123HH*				MD2001X	MD2001X		MD2001XC*	33
FJ 1200	1992-1993	FA160*		FA160HH*				MD2046	MD2046			34
VMX 12 All Models	1993-2007	FA160*		FA160HH*				MD2129X	MD2129X		MD2129XC*	35
VMX 12 V-Max	1985-1992	FA88*		FA88HH*	EPFA88HH*			MD2068	MD2068			36
XT 1200 Z Super Tenere	2012-2019			FA380HH*	EPFA380HH*						MD2095XC*	37
XT 1200 Z Super Tenere ES	2014-2023			FA380HH*	EPFA380HH*						MD2095XC*	38
XVZ 12 Venture	1983	FA88*	FA88V*	FA88HH*	EPFA88HH*			MD2081	MD2081			39
XVZ 12 Venture	1984	FA88*	FA88V*	FA88HH*	EPFA88HH*			MD2081	MD2081			40
XVZ12 Venture Royale	1983-1984	FA88*	FA88V*	FA88HH*	EPFA88HH*			MD2081	MD2081			41
XVZ12 Venture Royale	1985	FA88*	FA88V*	FA88HH*	EPFA88HH*			MD2081	MD2081			42
FJR 1300	2003	FA252*		FA252HH*	EPFA252HH*			MD2074X	MD2074X		MD2074XC*	43
FJR 1300	2004-2005	FA252*		FA252HH*	EPFA252HH*			MD2089X	MD2089X		MD2089XC*	44
FJR 1300	2006-2012			FA423/4HH*				MD2089X	MD2089X		MD2089XC*	45
FJR 1300	2006-2009			FA423/4HH*				MD2089X	MD2089X		MD2089XC*	46
FJR 1300 A	2013-2020			FA423/4HH*				MD2089X	MD2089X		MD2089XC*	47
FJR 1300 ES	2014-2023			FA423/4HH*				MD2089X	MD2089X		MD2089XC*	48
XVS 1300 Stryker	2011-2014	FA179	FA179V	FA179HH				MD2101X			MD2101XC	49
XVS 1300 V-Star	2007-2014	FA199*	FA199V*	FA199HH*				MD2074X	MD2074X		MD2074XC*	50
XVS 1300 V-Star De Luxe	2013-2014	FA199*	FA199V*	FA199HH*				MD2074X	MD2074X		MD2074XC*	51
XVS 1300 V-Star Tourer	2007-2014	FA199*	FA199V*	FA199HH*				MD2074X	MD2074X		MD2074XC*	52
XVZ 13 D Series Venture Royale	1986-1993	FA123*	FA123V*	FA123HH*				MD2096	MD2096			53
XVZ 13 Venture	1987-1988	FA123*	FA123V*	FA123HH*				MD2096	MD2096			54
XVZ 1300 LTK Venture	1996-1998	FA123*	FA123V*	FA123HH*				MD2076	MD2076			55
XVZ 1300 Royal Star	1996-1997	FA123*	FA123V*	FA123HH*				MD2076	MD2076			56

*-2 Sets Required. † For Vee disc colours add RED, BLU, GRN, GLD, ORG suffix to part number. **SAFETY WARNING:- DO NOT USE HH PADS ON REAR UNLESS ALSO USED ON FRONT TO AVOID BRAKE IMBALANCE**

Part numbers, prefixes, suffixes, photos and illustrations shown in this catalog are trademarks and/or copyrights of EBC Brakes or the trademark owner A C Freeman Investments Ltd and use without express written permission of the owners is punishable by law.

This symbol indicates a rotor made of billet steel, and should be only used with EBC FA Organic or Vee pads.
 SAFETY NOTICE - With vehicles primarily designed for off highway use such as quads now being used on the highway, we would recommend the use of X or MXS pads for highway use and ONLY using the R and SV higher density / harder pad series for off road riding.

FRONT: YAMAHA Cont'd

REAR: YAMAHA

Line #	BRAKE ROTOR CHOICES - FRONT					DISC PAD CHOICES - REAR					BRAKE ROTOR CHOICES - REAR					
	CX Extreme® /Vee-Rotor	OSX Series Oversize 280mm Rotor Kit	Relocating Bracket for Oversize Rotor	SMX Series Oversize 320mm Rotor Kit	Relocating Bracket for 320mm Rotor	Front Disc Bolt Kit	FA/SFA/X Pad or Brake Shoe	Specialty Pads SXR/ VEE/MXS Race	Sintered/ HH Pads/ Grooved Shoes	EPFA Sintered Fast Road/ Track Pads	SV Series Severe Duty Pads	Standard Rotor	Vintage Rotor / UTV Oversize Brake Kit	Contour Profile Rotor	CX Extreme® /Vee-Rotor	Rear Disc Bolt Kit
1							534*		534G*							
2							FA677X*		FA677R*		FA677SV*	MD6395D*	UTVX6395*			
3							FA677X*		FA677R*		FA677SV*	MD6442D*				
4							FA677X*		FA677R*		FA677SV*	MD6395D*	UTVX6395*			
5							FA677X*		FA677R*		FA677SV*	MD6442D*				
6	VR2074BLK*†						FA88		FA88HH	EPFA88HH		MD2002		MD2002C	VR2002	DB201/6
7	VR2074BLK*†						FA267		FA267HH			MD2086		MD2086C	VR2086	
8	VR2074BLK*†						FA275		FA275HH			MD2084		MD2084C	VR2084	
9	VR2102BLK*†						FA174		FA174HH			MD2091		MD2091C	VR2091	
10	VR2102BLK*†						FA174		FA174HH			MD2091		MD2091C	VR2091	
11	VR2124BLK*†						FA436		FA436HH			MD2125		MD2125C	VR2125	
12	VR2094BLK*†						FA174		FA174HH			MD2091		MD2091C	VR2091	
13							FA174		FA174HH			MD2118				
14	VR2124BLK*†						FA436		FA436HH			MD2125		MD2125C	VR2125	
15	VR2124BLK*†						FA436		FA436HH			MD2125		MD2125C	VR2125	
16							FA88		FA88HH	EPFA88HH		MD2068				DB201/6
17							FA41					MD2024	VMD2024			
18							FA34					MD2024	VMD2024			
19							FA34					MD2024	VMD2024			
20																
21																
22																
23							FA41					MD2024	VMD2024			
24	VR2011*						515									
25							FA88		FA88HH			MD2092				
26	VR2074BLK*†						FA88		FA88HH			MD2092		MD2092C	VR2092	
27							FA88		FA88HH			MD2092				
28							FA88		FA88HH			MD2092				
29	VR2074BLK*†						FA88		FA88HH			MD2092		MD2092C	VR2092	
30							FA88		FA88HH			MD2092				
31							FA88		FA88HH	EPFA88HH		MD2068				DB201/6
32	VR2001BLK*†						FA88		FA88HH			MD2068				DB201/6
33	VR2001BLK*†						FA88		FA88HH			MD2068				DB201/6
34							FA88		FA88HH			MD2068				DB201/6
35							FA88		FA88HH			MD2068				DB201/6
36							FA88		FA88HH	EPFA88HH		MD2068				DB201/6
37							FA319/2		FA319/2HH					MD2115C		
38							FA319/2		FA319/2HH			MD2100		MD2115C		
39							FA88		FA88HH	EPFA88HH		MD2081				
40							FA88		FA88HH	EPFA88HH		MD2081				
41							FA88		FA88HH	EPFA88HH		MD2081				
42							FA88		FA88HH	EPFA88HH		MD2081				
43	VR2074BLK*†						FA319/2		FA319/2HH			MD2092		MD2092C	VR2092	
44	VR2089BLK*†						FA319/2		FA319/2HH			MD2092		MD2092C	VR2092	
45	VR2089BLK*†						FA319/2		FA319/2HH			MD2100		MD2100C	VR2100	
46	VR2089BLK*†						FA319/2		FA319/2HH			MD2100		MD2100C	VR2100	
47	VR2089BLK*†						FA319/2		FA319/2HH			MD2100		MD2100C	VR2100	
48	VR2089BLK*†						FA319/2		FA319/2HH			MD2100		MD2100C	VR2100	
49	VR2101BLK†						FA319/2		FA319/2HH			MD2114		MD2114C		
50	VR2074BLK*†						FA319/2		FA319/2HH			MD2103		MD2103C	VR2103	
51	VR2074BLK*†						FA319/2		FA319/2HH			MD2103		MD2103C	VR2103	
52	VR2074BLK*†						FA319/2		FA319/2HH			MD2103		MD2103C	VR2103	
53							FA123		FA123HH			MD2049				
54							FA123		FA123HH			MD2049				
55							FA123		FA123HH			MD2078				
56							FA123		FA123HH			MD2078				

BRAKE APPLICATIONS

⚠ This symbol indicates a rotor made of billet steel, and should be only used with EBC FA Organic or Vee pads. SAFETY NOTICE - With vehicles primarily designed for off highway use such as quads now being used on the highway, we would recommend the use of X or MXS pads for highway use and ONLY using the R and SV higher density / harder pad series for off road riding.

*-2 Sets Required. † For Vee disc colours add RED, BLU, GRN, GLD, ORG suffix to part number. **SAFETY WARNING:- DO NOT USE HH PADS ON REAR UNLESS ALSO USED ON FRONT TO AVOID BRAKE IMBALANCE**

FRONT: YAMAHA



YAMAHA



DISC PAD CHOICES - FRONT

BRAKE ROTOR CHOICES - FRONT

Model	Year	FA/SFA/X Pad or Brake Shoe	Specialty Pads SXR/VEE/MXS Race	Sintered/HH Pads/Grooved Shoes	EPFA Sintered Fast Road/Track Pads	GPFX Sintered RACE ONLY Pads	SV Series Severe Duty Pads	Standard Rotor		Vintage Rotor / UTV Oversize Brake Kit	Contour Profile Rotor	Line #
								Standard Rotor Left	Standard Rotor Right			
XVZ 1300 Royal Star Boulevard	1999-2001	FA123*	FA123V*	FA123HH*				MD2076	MD2076			1
XVZ 1300 Royal Star Midnight Tour Deluxe	2006-2007	FA179*	FA179V*	FA179HH*				MD2076	MD2076			2
XVZ 1300 Royal Star Midnight Venture	2002-2007	FA179*	FA179V*	FA179HH*				MD2076	MD2076			3
XVZ 1300 Royal Star Standard	1998	FA123*	FA123V*	FA123HH*				MD2076	MD2076			4
XVZ 1300 Royal Star Tour Classic	1996-2000	FA123*	FA123V*	FA123HH*				MD2076	MD2076			5
XVZ 1300 Royal Star Tour Deluxe	1997-2001	FA123*	FA123V*	FA123HH*				MD2076	MD2076			6
XVZ 1300 Royal Star Tour Deluxe	2005-2007	FA179*	FA179V*	FA179HH*				MD2076	MD2076			7
XVZ 1300 Royal Star Venture	1999-2007	FA123*	FA123V*	FA123HH*				MD2076	MD2076			8
XVZ 1300 Royal Star Venture S	2008-2013	FA179*	FA179V*	FA179HH*				MD2076	MD2076			9
XVZ 1300 Venture MM Limited Edition	2001	FA123*	FA123V*	FA123HH*				MD2076	MD2076			10
XV 1600 Midnight Star	2002-2003	FA179*	FA179V*	FA179HH*				MD2076	MD2076			11
XV 1600 Road Star	1999-2005	FA179*	FA179V*	FA179HH*				MD2076	MD2076			12
XV 1600 Road Star Midnight	2003	FA179*	FA179V*	FA179HH*				MD2076	MD2076			13
XV 1600 Road Star Silverado	1999-2009	FA179*	FA179V*	FA179HH*				MD2076	MD2076			14
VMX 1700 V-Max	2009-2016	FA442/4*		FA442/4HH*	EPFA442/4HH*						MD2109XC*	15
VMX 1700 V-Max	2017-2021	FA442/4*		FA442/4HH*	EPFA442/4HH*						MD2109XC*	16
XV 1700 Road Star	2005-2007	FA252*		FA252HH*	EPFA380HH*			MD2076	MD2076			17
XV 1700 Road Star	2004-2008	FA252*		FA252HH*	EPFA380HH*			MD2074X	MD2074X		MD2074XC*	18
XV 1700 Road Star Midnight	2004-2007	FA252*		FA252HH*	EPFA380HH*			MD2074X	MD2074X		MD2074XC*	19
XV 1700 Road Star Midnight Silverado	2004-2007	FA252*		FA252HH*	EPFA380HH*			MD2074X	MD2074X		MD2074XC*	20
XV 1700 Road Star Midnight Warrior	2005	FA252*		FA252HH*	EPFA380HH*			MD2074X	MD2074X		MD2074XC*	21
XV 1700 Road Star Midnight Warrior	2006-2009	FA252*		FA252HH*	EPFA380HH*			MD2082X	MD2082X		MD2082XC*	22
XV 1700 Road Star S	2008-2014	FA252*		FA252HH*	EPFA380HH*			MD2074X	MD2074X		MD2074XC*	23
XV 1700 Road Star Silverado	2007-2010	FA252*		FA252HH*	EPFA380HH*			MD2076	MD2076			24
XV 1700 Road Star Silverado S	2011-2014	FA252*		FA252HH*	EPFA380HH*			MD2074X	MD2074X		MD2074XC*	25
XV 1700 Road Star Warrior	2004-2005	FA252*		FA252HH*	EPFA380HH*			MD2074X	MD2074X		MD2074XC*	26
XV 1700 Road Star Warrior	2006-2008	FA252*		FA252HH*	EPFA380HH*			MD2082X	MD2082X		MD2082XC*	27
Star Eluder	2018-2022			FA380HH*				MD2119X	MD2119X		MD2119XC*	28
Star Eluder GT	2018-2022			FA380HH*				MD2119X	MD2119X		MD2119XC*	29
Star Venture	2018-2022			FA380HH*				MD2119X	MD2119X		MD2119XC*	30
Star Venture Transcontinental	2018-2022			FA380HH*				MD2119X	MD2119X		MD2119XC*	31
XV 1900 Raider	2008-2014	FA252*		FA252HH*	EPFA380HH*			MD2082X	MD2082X		MD2082XC*	32
XV 1900 Raider S	2008-2014	FA252*		FA252HH*	EPFA380HH*			MD2082X	MD2082X		MD2082XC*	33
XV 1900 Raider SCL	2012-2014	FA252*		FA252HH*	EPFA380HH*			MD2082X	MD2082X		MD2082XC*	34
XV 1900 Roadliner	2006-2007	FA252*		FA252HH*	EPFA380HH*			MD2074X	MD2074X		MD2074XC*	35
XV 1900 Roadliner Midnight	2006-2009	FA252*		FA252HH*	EPFA380HH*			MD2074X	MD2074X		MD2074XC*	36
XV 1900 Roadliner S	2006-2010	FA252*		FA252HH*	EPFA380HH*			MD2074X	MD2074X		MD2074XC*	37
XV 1900 Roadliner S	2012-2014	FA252*		FA252HH*	EPFA380HH*			MD2074X	MD2074X		MD2074XC*	38
XV 1900 Stratoliner	2006-2009	FA252*		FA252HH*	EPFA380HH*			MD2074X	MD2074X		MD2074XC*	39
XV 1900 Stratoliner Deluxe	2011-2014	FA252*		FA252HH*	EPFA380HH*			MD2074X	MD2074X		MD2074XC*	40
XV 1900 Stratoliner Midnite	2006-2008	FA252*		FA252HH*	EPFA380HH*			MD2074X	MD2074X		MD2074XC*	41
XV 1900 Stratoliner S	2006-2014	FA252*		FA252HH*	EPFA380HH*			MD2074X	MD2074X		MD2074XC*	42
												43
												44
												45
												46
												47
												48
												49
												50
												51
												52
												53
												54
												55
												56

APPLIATIONS
SAFETY NOTICE - With vehicles primarily designed for off highway use such as quads now being used on the highway, we would recommend the use of X or MXS pads for highway use and ONLY using the R and SV higher density / harder pad series for off road riding.

⚡ This symbol indicates a rotor made of billet steel, and should be only used with EBC FA Organic or Vee pads.

*-2 Sets Required. † For Vee disc colours add RED, BLU, GRN, GLD, ORG suffix to part number. **SAFETY WARNING:- DO NOT USE HH PADS ON REAR UNLESS ALSO USED ON FRONT TO AVOID BRAKE IMBALANCE**

FRONT: YAMAHA Cont'd

REAR: YAMAHA

Line #	BRAKE ROTOR CHOICES - FRONT					DISC PAD CHOICES - REAR					BRAKE ROTOR CHOICES - REAR					
	CX Extreme® /Vee-Rotor	OSX Series Oversize 280mm Rotor Kit	Relocating Bracket for Oversize Rotor	SMX Series Oversize 320mm Rotor Kit	Relocating Bracket for 320mm Rotor	Front Disc Bolt Kit	FA/SFA/X Pad or Brake Shoe	Specialty Pads SXR/ VEE/MXS Race	Sintered/ HH Pads/ Grooved Shoes	EPFA Sintered Fast Road/ Track Pads	SV Series Severe Duty Pads	Standard Rotor	Vintage Rotor / UTV Oversize Brake Kit	Contour Profile Rotor	CX Extreme® /Vee-Rotor	Rear Disc Bolt Kit
1							FA123		FA123HH			MD2078				
2							FA123		FA123HH			MD2078				
3							FA123		FA123HH			MD2078				
4							FA123		FA123HH			MD2078				
5							FA123		FA123HH			MD2078				
6							FA123		FA123HH			MD2078				
7							FA123		FA123HH			MD2078				
8							FA123		FA123HH			MD2078				
9							FA123		FA123HH			MD2078				
10							FA123		FA123HH			MD2078				
11							FA123		FA123HH			MD2088				
12							FA123		FA123HH			MD2088				
13							FA123		FA123HH			MD2088				
14							FA123		FA123HH			MD2088				
15							FA319/2		FA319/2HH				MD2108C			
16							FA319/2		FA319/2HH				MD2108C			
17								FA123HH				MD2088				
18	VR2074BLK*†							FA123HH				MD2088				
19	VR2074BLK*†							FA123HH				MD2088				
20	VR2074BLK*†							FA123HH				MD2088				
21	VR2074BLK*†							FA319/2HH				MD2092	MD2092C	VR2092		
22								FA319/2HH				MD2092	MD2092C	VR2092		
23	VR2074BLK*†							FA123HH				MD2088				
24								FA123HH				MD2088				
25	VR2074BLK*†							FA123HH				MD2088				
26	VR2074BLK*†							FA319/2HH				MD2092	MD2092C	VR2092		
27								FA319/2HH				MD2092	MD2092C	VR2092		
28	VR2119BLK*†							FA725HH				MD2131				
29	VR2119BLK*†							FA725HH				MD2131				
30	VR2119BLK*†							FA725HH				MD2131				
31	VR2119BLK*†							FA725HH				MD2131				
32	VR2082BLK*†						FA319/2		FA319/2HH			MD2114		MD2114C		
33	VR2082BLK*†						FA319/2		FA319/2HH			MD2114		MD2114C		
34	VR2082BLK*†						FA319/2		FA319/2HH			MD2114		MD2114C		
35	VR2074BLK*†						FA319/2		FA319/2HH			MD2099				
36	VR2074BLK*†						FA319/2		FA319/2HH			MD2099				
37	VR2074BLK*†						FA319/2		FA319/2HH			MD2099				
38	VR2074BLK*†						FA319/2		FA319/2HH			MD2099				
39	VR2074BLK*†						FA319/2		FA319/2HH			MD2099				
40	VR2074BLK*†						FA319/2		FA319/2HH			MD2099				
41	VR2074BLK*†						FA319/2		FA319/2HH			MD2099				
42	VR2074BLK*†						FA319/2		FA319/2HH			MD2099				
43																
44																
45																
46																
47																
48																
49																
50																
51																
52																
53																
54																
55																
56																

BRAKE APPLICATIONS
 * This symbol indicates a rotor made of billet steel, and should be only used with EBC FA Organic or Vee pads.
 SAFETY NOTICE - With vehicles primarily designed for off highway use such as quads now being used on the highway, we would recommend the use of X or MXS pads for highway use and ONLY using the R and SV higher density / harder pad series for off road riding.

*-2 Sets Required. † For Vee disc colours add RED, BLU, GRN, GLD, ORG suffix to part number. **SAFETY WARNING:- DO NOT USE HH PADS ON REAR UNLESS ALSO USED ON FRONT TO AVOID BRAKE IMBALANCE**

FRONT: Non-Japanese Bikes Cont'd

REAR: Non-Japanese Bikes

Line #	BRAKE ROTOR CHOICES - FRONT						DISC PAD CHOICES - REAR						BRAKE ROTOR CHOICES - REAR				
	CX Extreme® /Vee-Rotor	OSX Series Oversize 280mm Rotor Kit	Relocating Bracket for Oversize Rotor	SMX Series Oversize 320mm Rotor Kit	Relocating Bracket for 320mm Rotor	Front Disc Bolt Kit	FA/SFA/X Pad or Brake Shoe	Specialty Pads SXR/ VEE/MXS Race	Sintered/ HH Pads/ Grooved Shoes	EPFA Sintered Fast Road/ Track Pads	SV Series Severe Duty Pads	Standard Rotor	Vintage Rotor / UTV Oversize Brake Kit	Contour Profile Rotor	CX Extreme® /Vee-Rotor	Rear Disc Bolt Kit	
1							503										
2							503										
3							503										
4							503										
5																	
6																	
7																	
8																	
9																	
10							SFA83		SFA83HH			MD982D					
11																	
12							FA83X		FA83R								
13							FA83X		FA83R								
14																	
15																	
16																	
17							FA131X	MXS131	FA131R			MD6401D					
18							FA131X	MXS131	FA131R			MD6401D					
19							FA131X	MXS131	FA131R			MD6401D					
20							FA131X	MXS131	FA131R			MD6401D					
21							FA131X	MXS131	FA131R			MD6401D					
22							FA131X	MXS131	FA131R			MD6401D					
23							FA131X	MXS131	FA131R			MD6401D					
24							FA131X	MXS131	FA131R			MD6401D					
25							FA131X	MXS131	FA131R			MD6401D					
26							FA131X	MXS131	FA131R			MD6401D					
27							FA131X	MXS131	FA131R			MD6401D					
28							FA131X	MXS131	FA131R			MD6401D					
29							FA368X	MXS368	FA368R			MD6401D					
30							FA131X	MXS131	FA131R			MD6401D					
31							FA131X	MXS131	FA131R			MD6401D					
32							FA131X	MXS131	FA131R			MD6401D					
33							FA368X	MXS368	FA368R			MD6401D					
34							FA368X	MXS368	FA368R			MD6401D					
35							FA368X	MXS368	FA368R			MD6401D					
36							FA208X		FA208R								
37							FA208X		FA208R								
38																	
39																	
40																	
41																	
42							FA368X	MXS368	FA368R								
43							FA368X		FA368R								
44																	
45																	
46							817										
47							817										
48							FA60										
49							893										
50							FA60					MD664					
51							FA60										
52							SFA193		SFA193HH			MD943D					
53							893										
54							816										
55							SFA193		SFA193HH			MD943D					
56							SFA298		SFA298HH			MD996D					

⚠ This symbol indicates a rotor made of billet steel, and should be only used with EBC FA Organic or Vee pads.
SAFETY NOTICE - With vehicles primarily designed for off highway use such as quads now being used on the highway, we would recommend the use of X or MXS pads for highway use and ONLY using the R and SV higher density / harder pad series for off road riding.

*-2 Sets Required. † For Vee disc colours add RED, BLU, GRN, GLD, ORG suffix to part number. **SAFETY WARNING:- DO NOT USE HH PADS ON REAR UNLESS ALSO USED ON FRONT TO AVOID BRAKE IMBALANCE**

FRONT: Non-Japanese Bikes

APPLICATIONS
BRAKE



APRILIA



DISC PAD CHOICES - FRONT

BRAKE ROTOR CHOICES - FRONT

Model	Year	FA/SFA/X Pad or Brake Shoe	Specialty Pads SXR/VEE/MXS Race	Sintered/HH Pads/Grooved Shoes	EPFA Sintered Fast Road/Track Pads	GPFAX Sintered RACE ONLY Pads	SV Series Severe Duty Pads	Standard Rotor Left	Standard Rotor Right	Vintage Rotor / UTV Oversize Brake Kit	Contour Profile Rotor	Line #
SR 50 Motard	2012-2015	SFA353		SFA353HH				MD924D				1
Scarabeo 100	2004-2014	SFA193		SFA193HH				MD945D				2
RS 125	2006-2012	FA432		FA432HH					MD621X		MD621XC	3
Sport City 125	2008-2014	SFA256		SFA256HH				MD952D				4
Mojito 150 Custom	2005-2009	SFA301		SFA301HH				MD943D				5
Scarabeo 150	1999-2006	SFA256		SFA256HH				MD952D				6
Atlantic 200	2004-2006	SFA324		SFA324HH				MD997D				7
Scarabeo 200	2008-2014	SFA324		SFA324HH				MD952D				8
RS 250	1999-2003	FA244*		FA244HH*				MD660LS	MD660RS			9
Scarabeo 125/250 GT	2004-2005	SFA256		SFA256HH				MD952D				10
Scarabeo 250	2006-2008	SFA324		SFA324HH				MD952D				11
Sport City 250	2007-2014	SFA256*		SFA256HH*				MD952D	MD952D			12
Sport City 250 Cube	2008-2009	SFA256		SFA256HH				MD952D				13
MXV 4.5	2009-2012	FA185X	MXS185	FA185R	EPFA185HH							14
RVX 4.5/5.5	2006-2012	FA185X	MXS185	FA185R	EPFA185HH							15
SXV 4.5/5.5	2009-2012		MXS405		EPFA405HH							16
Atlantic 500 ie	2003-2005	SFA256*		SFA256HH*				MD952D	MD952D			17
Scarabeo 500 ie	2003-2014	SFA256*		SFA256HH*				MD952D	MD952D			18
Pegaso 650 ie	1999-2004	FA209/2		FA209/2HH				MD6129D				19
RS 660 8V	2020-2024			FA630HH*				MD2003X	MD2003X			20
RS 660 8V Tuono	2020-2024			FA630HH*				MD2003X	MD2003X			21
Tuareg 660	2021-2024			FA209/2HH*								22
Dorsoduro 750	2008-2015	FA432*		FA432HH*				MD621X	MD621X		MD621XC*	23
Shiver 750 SL	2007-2014	FA432*		FA432HH*				MD621X	MD621X		MD621XC*	24
Mana 850	2008-2012	FA432*		FA432HH*				MD621X	MD621X		MD621XC*	25
Mana 850 GT	2009-2016	FA432*		FA432HH*								26
Dorsoduro 900	2018-2021	FA432*		FA432HH*				MD2003X	MD2003X		MD2003XC*	27
Shiver 900	2018-2021	FA432*		FA432HH*				MD2003X	MD2003X		MD2003XC*	28
ETV 1000 Caponord	2001-2003	FA209/2*		FA209/2HH*				MD6307D	MD6307D			29
ETV 1000 Caponord	2004-2007	FA209/2*		FA209/2HH*				MD6406D	MD6406D			30
ETV 1000 Caponord Rally	2003	FA209/2*		FA209/2HH*				MD6406D	MD6406D			31
RST Futura 1000	2001-2005	FA244*		FA244HH*	EPFA244HH*			MD2001X	MD2001X		MD2001XC*	32
RSV 1000 Mille/R	2001-2003			FA322/4HH*	EPFA322/4HH*			MD621X	MD621X		MD621XC*	33
RSV 1000 Mille/SP	1998-2001	FA244*		FA244HH*	EPFA244HH*			MD666X	MD666X		MD666XC*	34
RSV 1000 R	2004-2012			FA322/4HH*	EPFA322/4HH*			MD621X	MD621X		MD621XC*	35
RSV 1000 Tuono	2002-2005	FA244*		FA244HH*	EPFA244HH*			MD621X	MD621X		MD621XC*	36
RSV 1000 Tuono R/Factory R	2002-2012			FA322/4HH*	EPFA322/4HH*			MD621X	MD621X		MD621XC*	37
RSV4 Factory	2009-2012			FA447HH*	EPFA447HH*			MD2003X	MD2003X		MD2003XC*	38
RSV4 Factory APRC	2013-2015			FA447HH*	EPFA447HH*			MD2003X	MD2003X		MD2003XC*	39
RSV4 Factory APRC SE	2011-2012			FA447HH*	EPFA447HH*			MD2003X	MD2003X		MD2003XC*	40
RSV4 R	2009-2012			FA447HH*	EPFA447HH*			MD2003X	MD2003X		MD2003XC*	41
RSV4 R APRC	2011-2012			FA447HH*	EPFA447HH*			MD2003X	MD2003X		MD2003XC*	42
RSV4 R APRC ABS	2013-2015			FA447HH*	EPFA447HH*			MD2003X	MD2003X		MD2003XC*	43
SL 1000 Falco	2000-2005	FA244*		FA244HH*	EPFA244HH*			MD666X	MD666X		MD666XC*	44
RSV4 1100	2021-2023			FA447HH*	EPFA447HH*			MD8004X	MD8004X			45
RSV4 1100 Factory	2022-2023			FA447HH*	EPFA447HH*			MD8004X	MD8004X			46
RSV4 1100 RF/RF/LE/RR	2018-2023			FA447HH*	EPFA447HH*			MD8004X	MD8004X			47
Tuono 1100 V4 Factory	2019-2023			FA447HH*	EPFA447HH*			MD8004X	MD8004X			48
Tuono 1100 V4 R APRC	2012-2015			FA630HH*	EPFA630HH*							49
Tuono 1100 V4 RR	2018-2023			FA447HH*	EPFA447HH*			MD8004X	MD8004X			50
Caponord 1200	2014-2015			FA630HH*	EPFA630HH*							51
Caponord 1200 Rally	2018-2019	FA244*		FA244HH*	EPFA244HH*							52
Dorsoduro 1200	2011-2014	FA244*		FA244HH*	EPFA244HH*							53
												54
												55
												56

FRONT

⚠ This symbol indicates a rotor made of billet steel, and should be only used with EBC FA Organic or Vee pads.
SAFETY NOTICE - With vehicles primarily designed for off highway use such as quads now being used on the highway, we would recommend the use of X or MXS pads for highway use and ONLY using the R and SV higher density / harder pad series for off road riding.

*-2 Sets Required. † For Vee disc colours add RED, BLU, GRN, GLD, ORG suffix to part number. **SAFETY WARNING:- DO NOT USE HH PADS ON REAR UNLESS ALSO USED ON FRONT TO AVOID BRAKE IMBALANCE**

FRONT: Non-Japanese Bikes Cont'd

REAR: Non-Japanese Bikes

Line #	BRAKE ROTOR CHOICES - FRONT					REAR	DISC PAD CHOICES - REAR					BRAKE ROTOR CHOICES - REAR				
	CX Extreme® /Vee-Rotor	OSX Series Oversize 280mm Rotor Kit	Relocating Bracket for Oversize Rotor	SMX Series Oversize 320mm Rotor Kit	Relocating Bracket for 320mm Rotor		Front Disc Bolt Kit	FA/SFA/X Pad or Brake Shoe	Specialty Pads SXR/ VEE/MXS Race	Sintered/ HH Pads/ Grooved Shoes	EPFA Sintered Fast Road/ Track Pads	SV Series Severe Duty Pads	Standard Rotor	Vintage Rotor / UTV Oversize Brake Kit	Contour Profile Rotor	CX Extreme® /Vee-Rotor
1							816									
2							816									
3							FA298		SFA298HH			MD664		MD664C		
4							816									
5							816									
6							SFA298		SFA298HH			MD942D				
7							SFA298		SFA298HH			MD996D				
8							SFA298		SFA298HH							
9							FA47		FA47HH			MD665				
10							SFA298		SFA298HH			MD942D				
11							SFA298		SFA298HH			MD942D				
12							SFA298		SFA298HH			MD942D				
13							SFA298		SFA298HH			MD942D				
14							FA367X	MXS367	FA367R							
15							FA367X	MXS367	FA367R							
16							FA367X	MXS367	FA367R							
17							SFA298		SFA298HH			MD990D				
18							SFA298		SFA298HH			MD990D				
19							FA173					MD6128D				
20							FA266		FA266HH	EPFA266HH		MD613		MD613C	VR613	DB604/5
21							FA266		FA266HH	EPFA266HH		MD613		MD613C	VR613	DB604/5
22							FA208X	MXS208	FA208R							
23	VR621BLK*†					DB604/6	FA213		FA213HH							
24	VR621BLK*†					DB604/6	FA213		FA213HH							
25	VR621BLK*†					DB604/6	FA256		FA256HH			MD858		MD858C	VR858	DB604/5
26							FA256		FA256HH			MD872		MD872C	VR872	DB604/5
27	VR2003BLK*†					DB201/6	FA213		FA213HH			MD613		MD613C	VR613	DB604/5
28	VR2003BLK*†					DB201/6	FA213		FA213HH			MD613		MD613C	VR613	DB604/5
29							FA266		FA266HH	EPFA266HH		MD6308D				
30							FA266		FA266HH	EPFA266HH		MD6308D				
31							FA266		FA266HH	EPFA266HH		MD6308D				
32	VR2001BLK*†						FA181X		FA181HH	EPFA181HH		MD697		MD697C		
33	VR621BLK*†					DB604/6	FA266		FA266HH	EPFA266HH		MD613		MD613C	VR613	DB604/5
34						DB604/6	FA266		FA266HH	EPFA266HH		MD613		MD613C	VR613	DB604/5
35	VR621BLK*†					DB604/6	FA266		FA266HH	EPFA266HH		MD613		MD613C	VR613	DB604/5
36	VR621BLK*†					DB604/6	FA266		FA266HH	EPFA266HH		MD613		MD613C	VR613	DB604/5
37	VR621BLK*†					DB604/6	FA266		FA266HH	EPFA266HH		MD613		MD613C	VR613	DB604/5
38	VR2003BLK*†					DB201/6	FA266		FA266HH	EPFA266HH		MD613		MD613C	VR613	DB604/5
39	VR2003BLK*†					DB201/6	FA266		FA266HH	EPFA266HH		MD613		MD613C	VR613	DB604/5
40	VR2003BLK*†					DB201/6	FA266		FA266HH	EPFA266HH		MD613		MD613C	VR613	DB604/5
41	VR2003BLK*†					DB201/6	FA266		FA266HH	EPFA266HH		MD613		MD613C	VR613	DB604/5
42	VR2003BLK*†					DB201/6	FA266		FA266HH	EPFA266HH		MD613		MD613C	VR613	DB604/5
43	VR2003BLK*†					DB201/6	FA266		FA266HH	EPFA266HH		MD613		MD613C	VR613	DB604/5
44						DB604/6	FA266		FA266HH	EPFA266HH		MD613		MD613C	VR613	DB604/5
45							FA266		FA266HH	EPFA266HH		MD613		MD613C	VR613	DB604/5
46							FA266		FA266HH	EPFA266HH		MD613		MD613C	VR613	DB604/5
47							FA266		FA266HH	EPFA266HH		MD613		MD613C	VR613	DB604/5
48							FA266		FA266HH	EPFA266HH		MD613		MD613C	VR613	DB604/5
49							FA266		FA266HH	EPFA266HH		MD613		MD613C	VR613	DB604/5
50							FA266		FA266HH	EPFA266HH		MD613		MD613C	VR613	DB604/5
51							FA213		FA213HH							
52							FA213		FA213HH							
53							FA213		FA213HH							
54																
55																
56																

BRAKE APPLICATIONS
⊗ This symbol indicates a rotor made of billet steel, and should be only used with EBC FA Organic or Vee pads.
SAFETY NOTICE - With vehicles primarily designed for off highway use such as quads now being used on the highway, we would recommend the use of X or MXS pads for highway use and ONLY using the R and SV higher density / harder pad series for off road riding.

*-2 Sets Required. † For Vee disc colours add RED, BLU, GRN, GLD, ORG suffix to part number. **SAFETY WARNING:- DO NOT USE HH PADS ON REAR UNLESS ALSO USED ON FRONT TO AVOID BRAKE IMBALANCE**

FRONT: Non-Japanese Bikes

APPLICATIONS
BRAKE



BENELLI



DISC PAD CHOICES - FRONT

BRAKE ROTOR CHOICES - FRONT

Model	Side	Year	FA/SFA/X	Specialty	Sintered/	EPFA	GPFAX	SV Series	Standard	Standard	Vintage	Contour	Line #
			Pad or Brake Shoe	Pads SXR/ VEE/MXS Race	HH Pads/ Grooved Shoes	Sintered Fast Road/Track Pads	Sintered RACE ONLY Pads	Severe Duty Pads	Rotor Left	Rotor Right	Rotor / UTV Oversize Brake Kit	Profile Rotor	
BN125		2018-2020	FA711	FA711V									1
Leoncino 125		2018-2020	FA658	FA658V									2
TNT 125 Tornado Naked T		2018-2020	FA711	FA711V									3
TRK125		2018-2019	FA658	FA658V	FA658HH								4
TNT 135 Tornado T		2021-2023	FA86		FA86HH								5
Leoncino 250		2018-2019	FA658	FA658V	FA658HH								6
TNT 300		2017-2018	FA658*	FA658V*	FA658HH*								7
302 S		2022-2023	FA658*		FA658HH*				MD2003X	MD2003X		MD2003XC*	8
Imperiale 400		2022-2023	FA209/2		FA209/2HH								9
Leoncino 500		2018-2019			FA322/4HH								10
Leoncino 500 Trail		2018-2019	FA142*		FA142HH*								11
502C		2018-2019			FA322/4HH*								12
TRK502		2018-2024			FA322/4HH*								13
TRK502 X		2018-2024	FA209/2*		FA209/2HH*				MD2003X	MD2003X		MD2003XC*	14
TRK702		2022-2024			FA322/4HH*								15
TRK702 X		2022-2024	FA209/2*		FA209/2HH*				MD2003X	MD2003X		MD2003XC*	16
BENNCHE													17
250 Cowboy	Left	2015-2016	FA165X		FA165R			FA165SV					19
	Right		FA135X		FA135R			FA135SV					20
250 Spire	Left	2015-2016	FA165X		FA165R			FA165SV					21
	Right		FA135X		FA135R			FA135SV					22
400 Bighorn	Left	2011-2016	FA165X		FA165R			FA165SV					23
	Right		FA135X		FA135R			FA135SV					24
400 Bighorn		2011-2016											25
400 Cowboy	Left	2015-2016	FA165X		FA165R			FA165SV					26
	Right		FA135X		FA135R			FA135SV					27
400 Cowboy		2015-2016											28
500 Bighorn	Left	2015-2016	FA165X		FA165R			FA165SV					29
	Right		FA135X		FA135R			FA135SV					30
500 Bighorn		2015-2016											31
500 Cowboy	Left	2014-2016	FA165X		FA165R			FA165SV					32
	Right		FA135X		FA135R			FA135SV					33
500 Cowboy		2014-2016											34
500 Gray Wolf		2015-2016	FA84X*		FA84R*			FA84SV*					35
700 Bighorn	Left	2015-2016	FA165X		FA165R			FA165SV					36
	Right		FA135X		FA135R			FA135SV					37
700 Bighorn		2015-2016											38
700 Cowboy	Left	2014-2016	FA165X		FA165R			FA165SV					39
	Right		FA135X		FA135R			FA135SV					40
700 Cowboy		2014-2016											41
700 Gray Wolf		2015-2016	FA84X*		FA84R*			FA84SV*					42
700 X Bighorn	Left	2015-2016	FA165X		FA165R			FA165SV					43
	Right		FA135X		FA135R			FA135SV					44
700 X Bighorn		2015-2016											45
800 Spire	Left	2014-2016	FA165X		FA165R			FA165SV					46
	Right		FA135X		FA135R			FA135SV					47
1000 Cowboy	Left	2015-2016	FA165X		FA165R			FA165SV					48
	Right		FA135X		FA135R			FA135SV					49
1000 Cowboy		2015-2016											50
1000 Spire	Left	2014-2016	FA165X		FA165R			FA165SV					51
	Right		FA135X		FA135R			FA135SV					52
1000 Spire		2014-2016											53
1000 X Spire	Left	2014-2016	FA165X		FA165R			FA165SV					54
	Right		FA135X		FA135R			FA135SV					55
1000 X Spire Parking Brake		2014-2016											56

⚠ This symbol indicates a rotor made of billet steel, and should be only used with EBC FA Organic or Vee pads.
SAFETY NOTICE - With vehicles primarily designed for off highway use such as quads now being used on the highway, we would recommend the use of X or MXS pads for highway use and ONLY using the R and SV higher density / harder pad series for off road riding.

*-2 Sets Required. † For Vee disc colours add RED, BLU, GRN, GLD, ORG suffix to part number. **SAFETY WARNING:- DO NOT USE HH PADS ON REAR UNLESS ALSO USED ON FRONT TO AVOID BRAKE IMBALANCE**

FRONT: Non-Japanese Bikes Cont'd

REAR: Non-Japanese Bikes

Line #	BRAKE ROTOR CHOICES - FRONT					Front Disc Bolt Kit	DISC PAD CHOICES - REAR					BRAKE ROTOR CHOICES - REAR				
	CX Extreme® /Vee-Rotor	OSX Series Oversize 280mm Rotor Kit	Relocating Bracket for Oversize Rotor	SMX Series Oversize 320mm Rotor Kit	Relocating Bracket for 320mm Rotor		FA/SFA/X Pad or Brake Shoe	Specialty Pads SXR/ VEE/MXS Race	Sintered/ HH Pads/ Grooved Shoes	EPFA Sintered Fast Road/ Track Pads	SV Series Severe Duty Pads	Standard Rotor	Vintage Rotor / UTV Oversize Brake Kit	Contour Profile Rotor	CX Extreme® /Vee-Rotor	Rear Disc Bolt Kit
1							FA629									
2							FA698									
3							FA629									
4							FA698		FA698HH							
5							FA629									
6							FA698		FA698HH							
7							FA698		FA698HH							
8						DB201/6	FA698		FA698HH							
9							FA698		FA698HH							
10							FA698		FA698HH							
11							FA698		FA698HH							
12							FA698		FA698HH							
13							FA698		FA698HH							
14						DB201/6	FA698		FA698HH							
15							FA698		FA698HH							
16						DB201/6	FA698		FA698HH							
17																
18																
19							FA428X		FA428R		FA428SV					
20																
21							FA428X		FA428R		FA428SV					
22																
23							FA165X		FA165R		FA165SV					
24							FA135X		FA135R		FA135SV					
25							FA428X		FA428R		FA428SV					
26							FA165X		FA165R		FA165SV					
27							FA135X		FA135R		FA135SV					
28							FA428X		FA428R		FA428SV					
29							FA165X		FA165R		FA165SV					
30							FA135X		FA135R		FA135SV					
31							FA428X		FA428R		FA428SV					
32							FA165X		FA165R		FA165SV					
33							FA135X		FA135R		FA135SV					
34							FA428X		FA428R		FA428SV					
35							FA344X		FA344R		FA344SV					
36							FA165X		FA165R		FA165SV					
37							FA135X		FA135R		FA135SV					
38							FA428X		FA428R		FA428SV					
39							FA165X		FA165R		FA165SV					
40							FA135X		FA135R		FA135SV					
41							FA428X		FA428R		FA428SV					
42							FA344X		FA344R		FA344SV					
43							FA165X		FA165R		FA165SV					
44							FA135X		FA135R		FA135SV					
45							FA428X		FA428R		FA428SV					
46							FA690X		FA690R							
47																
48							FA165X		FA165R		FA165SV					
49							FA135X		FA135R		FA135SV					
50							FA428X		FA428R		FA428SV					
51							FA165X		FA165R		FA165SV					
52							FA135X		FA135R		FA135SV					
53							FA428X		FA428R		FA428SV					
54							FA165X		FA165R		FA165SV					
55							FA135X		FA135R		FA135SV					
56							FA428X		FA428R		FA428SV					

⚠ This symbol indicates a rotor made of billet steel, and should be only used with EBC FA Organic or Vee pads.
SAFETY NOTICE - With vehicles primarily designed for off highway use such as quads now being used on the highway, we would recommend the use of X or MXS pads for highway use and ONLY using the R and SV higher density / harder pad series for off road riding.

*-2 Sets Required. † For Vee disc colours add RED, BLU, GRN, GLD, ORG suffix to part number. **SAFETY WARNING:- DO NOT USE HH PADS ON REAR UNLESS ALSO USED ON FRONT TO AVOID BRAKE IMBALANCE**

FRONT: Non-Japanese Bikes

APPLICATIONS

BRAKE



BETA



DISC PAD CHOICES - FRONT

BRAKE ROTOR CHOICES - FRONT

			FA/SFA/X Pad or Brake Shoe	Specialty Pads SXR/VEE/MXS Race	Sintered/HH Pads/Grooved Shoes	EPFA Sintered Fast Road/Track Pads	GPFAX Sintered RACE ONLY Pads	SV Series Severe Duty Pads	Standard Rotor Left	Standard Rotor Right	Vintage Rotor / UTV Oversize Brake Kit	Contour Profile Rotor	Line #
Electric 16		2018-2022	CFA327										1
Electric 20		2018-2022	CFA327										2
Electric 20XL		2018-2022	CFA327										3
Eikon 50 Team		2002-2003	SFA115		SFA115HH				MD901D				4
Mini Trial 50		2009-2012	FA351X										5
Rev 50/80		2002-2006	FA115X		FA115R								6
RR 50		2018-2019	FA194										7
RR 50 Motard		2006	FA167		FA167HH								8
RR 50 Sport/Racing		2018-2019	FA194										9
Evo 80		2009-2018	FA303X										10
Evo 80 Junior		2009-2012	FA303X										11
Evo 80 Junior		2018-2023	FA115X										12
Evo 80 Senior		2019-2023	FA303X										13
125 Evo		2010-2019	FA303X										14
125 RR Enduro		2018-2019	FA185X		FA185R								15
125 RR Enduro		2020-2024	FA185X		FA185R				MD6032D				16
125 RR Race		2020-2023	FA185X	MXS185	FA185R	EPFA185HH							17
125 TR32/33		1986-1987	FA99X										18
125 TR34		1988	FA99X										19
125 TR34/35		1989-1990	FA115X	MXS115	FA115R								20
125 Trial Evo		2020-2023	FA303X										21
RR 125		2018-2019	FA185X	MXS185	FA185R	EPFA185HH							22
RR 125 RC		2018-2022	FA185X	MXS185	FA185R	EPFA185HH							23
130 Eikon		2004	SFA47		SFA47HH								24
200 RR Enduro		2020-2024	FA185X		FA185R				MD6032D				25
200 RR Race		2020-2023	FA185X	MXS185	FA185R	EPFA185HH							26
Alp 200		2000-2006	FA115X	MXS115	FA115R								27
Evo 200		2010-2015	FA303X										28
Evo 200		2020-2023	FA303X										29
Rev 3 125/200		2005	FA303X										30
Rev 3 125/200		2006-2008	FA303X										31
TR33 240		1986-1988	FA99X										32
TR34 240		1986-1988	FA99X										33
250 RR Enduro		2020-2024	FA185X	MXS185	FA185R	EPFA185HH			MD6032D				34
250 RR Race		2020-2023	FA185X	MXS185	FA185R	EPFA185HH							35
Evo 250		2009-2019	FA303X										36
Evo 250		2009-2019	FA303X										37
Evo 250		2020-2023	FA303X										38
Evo 250		2020	FA303X										39
Evo 250 Factory		2018-2023	FA303X										40
Evo 250 Factory		2018-2019	FA303X										41
Rev 3		2000-2008	FA303X										42
RR 250		2005-2008	FA185X	MXS185	FA185R	EPFA185HH							43
RR 250		2013-2019	FA185X	MXS185	FA185R	EPFA185HH							44
RR 250		2018-2019	FA185X	MXS185	FA185R	EPFA185HH			MD6032D				45
Xtrainer 250		2018-2022	FA185X	MXS185	FA185R				MD6032D				46
Synt/Gara 260		1993-1996	FA115X	MXS115	FA115R								47
TR34 260 Zero		1989-1992	FA115X	MXS115	FA115R								48
Rev 3 250/270		2005-2008	FA303X										49
300 RR		2013-2019	FA185X	MXS185	FA185R	EPFA185HH							50
300 RR 300		2018-2019	FA185X		FA185R				MD6032D				51
300 RR Enduro		2020-2024	FA185X	MXS185	FA185R	EPFA185HH			MD6032D				52
300 RR Race		2020-2023	FA185X	MXS185	FA185R	EPFA185HH							53
300 RX		2023-2024	FA185X	MXS185	FA185R	EPFA185HH			MD6032D				54
Evo 300		2009-2023	FA303X										55
Evo 300 2T		2020	FA303X										56

FRONT

⚠ This symbol indicates a rotor made of billet steel, and should be only used with EBC FA Organic or Vee pads.
SAFETY NOTICE - With vehicles primarily designed for off highway use such as quads now being used on the highway, we would recommend the use of X or MXS pads for highway use and ONLY using the R and SV higher density / harder pad series for off road riding.

*-2 Sets Required. † For Vee disc colours add RED, BLU, GRN, GLD, ORG suffix to part number. SAFETY WARNING:- DO NOT USE HH PADS ON REAR UNLESS ALSO USED ON FRONT TO AVOID BRAKE IMBALANCE

FRONT: Non-Japanese Bikes Cont'd

REAR: Non-Japanese Bikes

Line #	BRAKE ROTOR CHOICES - FRONT					REAR	DISC PAD CHOICES - REAR					BRAKE ROTOR CHOICES - REAR				
	CX Extreme® /Vee-Rotor	OSX Series Oversize 280mm Rotor Kit	Relocating Bracket for Oversize Rotor	SMX Series Oversize 320mm Rotor Kit	Relocating Bracket for 320mm Rotor		Front Disc Bolt Kit	FA/SFA/X Pad or Brake Shoe	Specialty Pads SXR/ VEE/MXS Race	Sintered/ HH Pads/ Grooved Shoes	EPFA Sintered Fast Road/ Track Pads	SV Series Severe Duty Pads	Standard Rotor	Vintage Rotor / UTV Oversize Brake Kit	Contour Profile Rotor	CX Extreme® /Vee-Rotor
1							CFA327R									
2							CFA327R									
3							CFA327R									
4							SFA115		SFA115HH			MD901D				
5																
6							FA115X		FA115R							
7							FA367/2X		FA367/2R							
8							FA115		FA115HH							
9							FA367/2X		FA367/2R							
10							FA403X									
11							FA115X		FA115R							
12							FA115X		FA115R							
13							FA403X									
14							FA495X									
15							FA367/2X		FA367/2R			MD6269D			MD6269CX	
16	MD6032CX					DB603/6	FA367/2X		FA367/2R			MD6269D			MD6269CX	
17	MD6433CX					DB603/6	FA367/2X		FA367/2R			MD6269D			MD6269CX	
18									841G							
19							FA116									
20							FA115X	MXS115	FA115R							
21							FA495X									
22							FA367/2X		FA367/2R							
23							FA367/2X		FA367/2R							
24							SFA298		SFA298HH							
25	MD6032CX					DB603/6	FA367/2X		FA367/2R			MD6269D			MD6269CX	
26	MD6433CX					DB603/6	FA367/2X		FA367/2R			MD6269D			MD6269CX	
27							FA115X	MXS115	FA115R							
28							FA495X									
29							FA495X									
30							FA303X									
31							FA403X									
32									841G							
33							FA116									
34	MD6032CX					DB603/6	FA367/2X		FA367/2R			MD6269D			MD6269CX	
35	MD6433CX					DB603/6	FA367/2X		FA367/2R			MD6269D			MD6269CX	
36							FA495X									
37							FA495X									
38							FA495X									
39							FA495X									
40							FA495X									
41							FA495X									
42							FA495X									
43							FA303X									
44							FA367X	MXS367	FA367R							
45	MD6032CX					DB603/6	FA367/2X		FA367/2R			MD6269D			MD6269CX	
46	MD6032CX					DB603/6	FA367/2X		FA367/2R			MD6269D			MD6269CX	
47							FA156X									
48							FA164X		FA164R							
49							FA403X									
50							FA367X	MXS367	FA367R			MD6269D				
51	MD6032CX					DB603/6	FA367/2X		FA367/2R			MD6269D			MD6269CX	
52	MD6032CX					DB603/6	FA367/2X		FA367/2R			MD6269D			MD6269CX	
53	MD6433CX					DB603/6	FA367/2X		FA367/2R			MD6269D			MD6269CX	
54	MD6032CX					DB603/6	FA367/2X		FA367/2R			MD6269D			MD6269CX	
55							FA495X									
56							FA495X									

BRAKE APPLICATIONS

⚠ This symbol indicates a rotor made of billet steel, and should be only used with EBC FA Organic or Vee pads.
 SAFETY NOTICE - With vehicles primarily designed for off highway use such as quads now being used on the highway, we would recommend the use of X or MXS pads for highway use and ONLY using the R and SV higher density / harder pad series for off road riding.

*-2 Sets Required. † For Vee disc colours add RED, BLU, GRN, GLD, ORG suffix to part number. **SAFETY WARNING:- DO NOT USE HH PADS ON REAR UNLESS ALSO USED ON FRONT TO AVOID BRAKE IMBALANCE**

FRONT: Non-Japanese Bikes

APPLICATIONS
BRAKE



BETA



DISC PAD CHOICES - FRONT

BRAKE ROTOR CHOICES - FRONT

			FA/SFA/X Pad or Brake Shoe	Specialty Pads SXR/VEE/MXS Race	Sintered/HH Pads/Grooved Shoes	EPFA Sintered Fast Road/Track Pads	GPFAX Sintered RACE ONLY Pads	SV Series Severe Duty Pads	Standard Rotor Left	Standard Rotor Right	Vintage Rotor / UTV Oversize Brake Kit	Contour Profile Rotor	Line #
Evo 300 4T		2020-2023	FA303X										1
Evo 300 SS 2T		2020-2023	FA303X										2
Xtrainer 300		2018-2023	FA185X	MXS185	FA185R				MD6032D				3
350 RR Race		2020-2023	FA185X	MXS185	FA185R	EPFA185HH			MD6032D				4
350 RR RC		2011-2019	FA185X	MXS185	FA185R	EPFA185HH			MD6032D				5
350 RR-S Enduro		2020-2024	FA185X	MXS185	FA185R	EPFA185HH			MD6032D				6
350 RS		2011-2012	FA185X	MXS185	FA185R	EPFA185HH			MD6032D				7
390 RR Race		2020-2023	FA185X	MXS185	FA185R	EPFA185HH							8
390 RR RC		2015-2019	FA185X	MXS185	FA185R	EPFA185HH			MD6032D				9
390 RR-S Enduro		2020-2024	FA185X	MXS185	FA185R	EPFA185HH			MD6032D				10
400 RR		2005-2011	FA185X	MXS185	FA185R	EPFA185HH							11
400 RR		2012-2014	FA185X	MXS185	FA185R	EPFA185HH						MD6367C	12
400 SM Supermotard		2010-2011	FA185X	MXS185	FA185R	EPFA185HH							13
430 RR Race		2020-2023	FA185X	MXS185	FA185R	EPFA185HH							14
430 RR RC		2015-2019	FA185X	MXS185	FA185R	EPFA185HH			MD6032D				15
430 RR-S Enduro		2020-2024	FA185X	MXS185	FA185R	EPFA185HH			MD6032D				16
430 RS		2015	FA185X	MXS185	FA185R	EPFA185HH							17
450 RR		2005-2011	FA185X	MXS185	FA185R	EPFA185HH							18
450 RR		2012-2014	FA185X	MXS185	FA185R	EPFA185HH						MD6367C	19
450 RS		2008-2014	FA185X	MXS185	FA185R	EPFA185HH							20
450 SM 450		2010-2011	FA185X	MXS185	FA185R	EPFA185HH							21
480 RR Enduro		2020-2024	FA185X	MXS185	FA185R	EPFA185HH			MD6032D				22
480 RR Race		2020-2023	FA185X	MXS185	FA185R	EPFA185HH							23
480 RR RC		2015-2019	FA185X	MXS185	FA185R	EPFA185HH							24
498 RR		2015	FA185X	MXS185	FA185R	EPFA185HH							25
500 RR Enduro		2021-2022	FA185X	MXS185	FA185R	EPFA185HH			MD6032D				26
500 RS		2015	FA185X	MXS185	FA185R	EPFA185HH							27
520 RR		2011-2012	FA185X	MXS185	FA185R	EPFA185HH							28
520 RS		2008-2014	FA185X	MXS185	FA185R	EPFA185HH							29
525 RR		2005-2009	FA185X	MXS185	FA185R	EPFA185HH						MD6367C	30
525 RR		2010-2011	FA185X	MXS185	FA185R	EPFA185HH							31
525 SM		2010-2011	FA185X	MXS185	FA185R	EPFA185HH							32
♦ Remove old speedo pick up magnet and refit to new EBC disc													
BMW													
C Evolution Electric		2018-2020	SFA142*		SFA142HH*								36
CE04 Electric		2021-2023	FA606*		FA606HH*				MD671				37
C1 200		2001-2003	SFA209/2		SFA209/2HH				MD968D				38
G 310 GS		2017-2023	FA606		FA606HH				MD881				39
G 310 GS Edition 40		2020-2021	FA606		FA606HH				MD881				40
G 310 R		2017-2023	FA606		FA606HH				MD881				41
C 400 GT		2021-2023	FA606		FA606HH				MD671				42
C 400 X		2018-2021	FA606		FA606HH				MD671				43
R 45		1978-1980	FA57	FA57V					MD606LS				44
R 45		1978-1980	FA57*	FA57V*					MD606LS	MD606RS			45
R 45		1978-1980	FA18	FA18V	FA18HH				MD606LS				46
R 45		1978-1980	FA18*	FA18V*	FA18HH*				MD606LS	MD606RS			47
R 45		1980-1985	FA57	FA57V					MD606LS				48
R 45		1980-1985	FA57*	FA57V*					MD606LS	MD606RS			49
R 45		1980-1985	FA18*	FA18V*	FA18HH*				MD606LS				50
R 45		1980-1985	FA18*	FA18V*	FA18HH*				MD606LS	MD606RS			51
R 45 T		1980-1985	FA57	FA57V					MD606LS				52
G 450 X		2008-2011	FA181X	MXS181	FA181R	EPFA181HH						MD6343C	53
R 50/5/60/5/60/6/75/5		1969-1976	864										54
R 60 TIC		1978-1982	FA22	FA22V					MD602LS				55
R 60 TIC		1978-1982	FA22*	FA22V*					MD602LS	MD602RS			56

FRONT

⚡ This symbol indicates a rotor made of billet steel, and should be only used with EBC FA Organic or Vee pads.
SAFETY NOTICE - With vehicles primarily designed for off highway use such as quads now being used on the highway, we would recommend the use of X or MXS pads for highway use and ONLY using the R and SV higher density / harder pad series for off road riding.

*-2 Sets Required. † For Vee disc colours add RED, BLU, GRN, GLD, ORG suffix to part number. SAFETY WARNING:- DO NOT USE HH PADS ON REAR UNLESS ALSO USED ON FRONT TO AVOID BRAKE IMBALANCE

FRONT: Non-Japanese Bikes Cont'd

REAR: Non-Japanese Bikes

Line #	BRAKE ROTOR CHOICES - FRONT					DISC PAD CHOICES - REAR					BRAKE ROTOR CHOICES - REAR					
	CX Extreme® /Vee-Rotor	OSX Series Oversize 280mm Rotor Kit	Relocating Bracket for Oversize Rotor	SMX Series Oversize 320mm Rotor Kit	Relocating Bracket for 320mm Rotor	Front Disc Bolt Kit	FA/SFA/X Pad or Brake Shoe	Specialty Pads SXR/ VEE/MXS Race	Sintered/ HH Pads/ Grooved Shoes	EPFA Sintered Fast Road/ Track Pads	SV Series Severe Duty Pads	Standard Rotor	Vintage Rotor / UTV Oversize Brake Kit	Contour Profile Rotor	CX Extreme® /Vee-Rotor	Rear Disc Bolt Kit
1							FA495X									
2							FA495X									
3	MD6032CX					DB603/6	FA367/2X		FA367/2R			MD6269D			MD6269CX	
4	MD6433CX					DB603/6	FA367/2X		FA367/2R			MD6269D			MD6269CX	
5	MD6032CX					DB603/6	FA367X	MXS367	FA367R			MD6269D				
6	MD6032CX					DB603/6	FA367/2X		FA367/2R			MD6269D			MD6269CX	
7	MD6032CX					DB603/6	FA367X	MXS367	FA367R							
8	MD6433CX					DB603/6	FA367/2X		FA367/2R			MD6269D			MD6269CX	
9	MD6032CX					DB603/6	FA367X	MXS367	FA367R							
10	MD6032CX					DB603/6	FA367/2X		FA367/2R			MD6269D			MD6269CX	
11							FA367X	MXS367	FA367R							
12							FA367X	MXS367	FA367R					MD6368C		
13							FA367X	MXS367	FA367R							
14	MD6433CX					DB603/6	FA367/2X		FA367/2R			MD6269D			MD6269CX	
15	MD6032CX					DB603/6	FA367X	MXS367	FA367R			MD6269D			MD6269CX	
16	MD6032CX					DB603/6	FA367/2X		FA367/2R			MD6269D			MD6269CX	
17							FA367X	MXS367	FA367R							
18							FA367X	MXS367	FA367R							
19							FA367X	MXS367	FA367R					MD6368C		
20							FA367X	MXS367	FA367R							
21							FA367X	MXS367	FA367R							
22	MD6032CX					DB603/6	FA367/2X		FA367/2R						MD6269CX	
23	MD6433CX					DB603/6	FA367/2X		FA367/2R						MD6269CX	
24							FA367X	MXS367	FA367R							
25							FA367X	MXS367	FA367R							
26	MD6032CX					DB603/6	FA367/2X		FA367/2R						MD6269CX	
27							FA367X	MXS367	FA367R							
28							FA367X	MXS367	FA367R							
29							FA367X	MXS367	FA367R							
30							FA367X	MXS367	FA367R					MD6368C		
31							FA367X	MXS367	FA367R							
32							FA367X	MXS367	FA367R							
33																
34																
35																
36							SFA196		SFA196HH							
37							FA213		FA213HH			MD671				
38							SFA213		SFA213HH			MD968D				
39							FA213		FA213HH			MD882				
40							FA213		FA213HH			MD882				
41							FA213		FA213HH			MD882				
42							FA213		FA213HH			MD671				
43							FA213		FA213HH			MD671				
44							860									
45							860									
46							860									
47							860									
48							861									
49							861									
50							861									
51							861									
52							861									
53		OSX6343	BRK011	SMX6343	BRK012		FA368X	MXS368	FA368R	EPFA368HH		MD6342D		MD6342C		
54							860									
55							860									
56							860									

BRAKE APPLICATIONS
⚠ This symbol indicates a rotor made of billet steel, and should be only used with EBC FA Organic or Vee pads.
SAFETY NOTICE - With vehicles primarily designed for off highway use such as quads now being used on the highway, we would recommend the use of X or MXS pads for highway use and ONLY using the R and SV higher density / harder pad series for off road riding.

*-2 Sets Required. † For Vee disc colours add RED, BLU, GRN, GLD, ORG suffix to part number. **SAFETY WARNING:- DO NOT USE HH PADS ON REAR UNLESS ALSO USED ON FRONT TO AVOID BRAKE IMBALANCE**

FRONT: Non-Japanese Bikes

APPLICATIONS

BRAKE



BMW



DISC PAD CHOICES - FRONT

BRAKE ROTOR CHOICES - FRONT

Model	Year	FA/SFA/X Pad or Brake Shoe	Specialty Pads SXR/VEE/MXS Race	Sintered/HH Pads/Grooved Shoes	EPFA Sintered Fast Road/Track Pads	GPFAX Sintered RACE ONLY Pads	SV Series Severe Duty Pads	Standard Rotor		Vintage Rotor / UTV Oversize Brake Kit	Contour Profile Rotor	Line #
								Standard Rotor Left	Standard Rotor Right			
C 600 Sport	2012-2015	SFA142*		SFA142HH*				MD9182D	MD9182D			1
R 60/7	1976-1980	FA22	FA22V					MD602LS				2
R 60/7	1976-1980	FA22*	FA22V*					MD602LS	MD602RS			3
R 65	1988-1989	FA77	FA77V									4
R 65	1988-1989	FA18*	FA18V*	FA18HH*				MD605LS	MD605RS			5
R 65 GS	1987-1992	FA18	FA18V	FA18HH					MD606RS			6
R 65 GS	1987-1992	FA18	FA18V	FA18HH				MD606RS				7
R 65 LS	1981-1985	FA57*	FA57V*					MD606LS	MD606RS			8
R 65 LS	1981-1985	FA18*	FA18V*	FA18HH*				MD606LS	MD606RS			9
R 65 RT	1985-1988	FA18*	FA18V*	FA18HH*				MD605LS	MD605RS			10
R 65 T	1980-1985	FA57	FA57V					MD606LS				11
R 65 T	1980-1985	FA18	FA18V	FA18HH				MD606LS				12
C 650 GT	2012-2021	SFA142*		SFA142HH*				MD9182D	MD9182D			13
C 650 GT Special Edition	2015	SFA142*		SFA142HH*				MD9182D	MD9182D			14
C 650 SPORT	2016-2021	SFA142*		SFA142HH*				MD9182D	MD9182D			15
F 650	1997-2000	FA209/2	FA209/2V	FA209/2HH				MD650				16
F 650	1993-1996	FA209/2	FA209/2V	FA209/2HH				MD650				17
F 650 CS Scarver	2000-2003	FA209/2	FA209/2V	FA209/2HH				MD834				18
F 650 CS Scarver	2004-2007	FA209/2	FA209/2V	FA209/2HH				MD834				19
F 650 Funduro	1997-2000	FA209/2	FA209/2V	FA209/2HH				MD650				20
F 650 GS	2011	FA209/2	FA209/2V	FA209/2HH				MD834X				21
F 650 GS	1999-2007	FA209/2	FA209/2V	FA209/2HH				MD834				22
F 650 GS	2006-2013	FA209/2	FA209/2V	FA209/2HH				MD834X				23
F 650 GS Dakar	1999-2003	FA209/2	FA209/2V	FA209/2HH				MD834				24
F 650 GS Dakar	2004-2007	FA209/2	FA209/2V	FA209/2HH				MD834				25
G 650 GS	2009-2015	FA209/2	FA209/2V	FA209/2HH				MD834X				26
G 650 GS Sertao	2010-2014	FA209/2	FA209/2V	FA209/2HH				MD834X				27
G 650 XChallenge	2007-2009	FA209/2	FA209/2V	FA209/2HH				MD809			MD809C	28
G 650 XCountry	2007-2009	FA209/2	FA209/2V	FA209/2HH				MD809			MD809C	29
G 650 Xmoto	2007-2009	FA244	FA244V	FA244HH	EPFA244HH			MD621X			MD621XC	30
F 700 GS	2011-2018	FA209/2*	FA209/2V*	FA209/2HH*				MD834X	MD834X			31
K 75 75-2	1984-1990	FA18*	FA18V*	FA18HH*				MD603LSⓉ	MD603RSⓉ			32
K 75 75-2	1988-1996	FA171*	FA171V*	FA171HH*				MD604LS	MD604RS			33
K 75 75-S	1984-1988	FA18*	FA18V*	FA18HH*				MD604LS	MD604RS			34
K 75 75-S	1990-1996	FA171*	FA171V*	FA171HH*				MD603LSⓉ	MD603RSⓉ			35
K 75 C	1985-1988	FA18*	FA18V*	FA18HH*				MD604LS	MD604RS			36
K 75 C	1988-1990	FA171*	FA171V*	FA171HH*				MD604LS	MD604RS			37
K 75 RT	1989-1996	FA171*	FA171V*	FA171HH*				MD603LSⓉ	MD603RSⓉ			38
K 75 RT	1989-1996	FA171*	FA171V*	FA171HH*				MD604LS	MD604RS			39
K 75 S	1988-1995	FA171*	FA171V*	FA171HH*				MD604LS	MD604RS			40
K 75 S	1985-1988	FA18*	FA18V*	FA18HH*				MD604LS	MD604RS			41
K 75 S	1985-1988	FA18*	FA18V*	FA18HH*				MD603LSⓉ	MD603RSⓉ			42
K 75 S	1988-1995	FA171*	FA171V*	FA171HH*				MD603LSⓉ	MD603RSⓉ			43
F 750 GS	2018-2023	FA209/2*	FA209/2V*	FA209/2HH*				MD687Ⓣ	MD687Ⓣ			44
F 750 GS Edition 40	2020-2021	FA209/2*	FA209/2V*	FA209/2HH*				MD687Ⓣ	MD687Ⓣ			45
R 75/6 75/7	1973-1979	FA22	FA22V					MD602LS				46
R 75/6 75/7	1973-1979	FA22*	FA22V*					MD602LS	MD602RS			47
R 80	1982-1984	FA18	FA18V	FA18HH					MD606RS			48
R 80	1977-1980	FA22	FA22V					MD602LS				49
R 80	1977-1980	FA22*	FA22V*					MD602LS	MD602RS			50
R 80	1980-1984	FA22	FA22V					MD602LS				51
R 80	1980-1984	FA22*	FA22V*					MD602LS	MD602RS			52
R 80 GS	1980-1987	FA18		FA18HH				MD606RS				53

FRONT

① - remove rotor outer ring from centre casting and refit.

Ⓣ - remove ABS ring from old rotor and refit to new EBC rotor. Note: Ensure all mounting surfaces are clean and when refitting bolts use a thread lock cement to hold them in place.

Ⓣ - OEM rotor has a fixed bobbin - EBC rotor requires a fitting kit - Not supplied by EBC Brakes

*-2 Sets Required. † For Vee disc colours add RED, BLU, GRN, GLD, ORG suffix to part number. **SAFETY WARNING:- DO NOT USE HH PADS ON REAR UNLESS ALSO USED ON FRONT TO AVOID BRAKE IMBALANCE**

This symbol indicates a rotor made of billet steel, and should be only used with EBC FA Organic or Vee pads. SAFETY NOTICE - With vehicles primarily designed for off highway use such as quads now being used on the highway, we would recommend the use of X or MXS pads for highway use and ONLY using the R and SV higher density / harder pad series for off road riding.

FRONT: Non-Japanese Bikes Cont'd

REAR: Non-Japanese Bikes

Line #	BRAKE ROTOR CHOICES - FRONT					DISC PAD CHOICES - REAR					BRAKE ROTOR CHOICES - REAR					
	CX Extreme® /Vee-Rotor	OSX Series Oversize 280mm Rotor Kit	Relocating Bracket for Oversize Rotor	SMX Series Oversize 320mm Rotor Kit	Relocating Bracket for 320mm Rotor	Front Disc Bolt Kit	FA/SFA/X Pad or Brake Shoe	Specialty Pads SXR/ VEE/MXS Race	Sintered/ HH Pads/ Grooved Shoes	EPFA Sintered Fast Road/ Track Pads	SV Series Severe Duty Pads	Standard Rotor	Vintage Rotor / UTV Oversize Brake Kit	Contour Profile Rotor	CX Extreme® /Vee-Rotor	Rear Disc Bolt Kit
1							SFA196		SFA196HH			MD9182D				
2							860									
3							860									
4							861									
5							861									
6							861									
7							861									
8							862									
9							862									
10							861									
11							861									
12							861									
13							SFA196		SFA196HH			MD9182D				
14							SFA196		SFA196HH			MD9182D				
15							SFA196		SFA196HH			MD9182D				
16							FA213		FA213HH			MD651				
17							FA213		FA213HH			MD651				
18							FA213		FA213HH			MD651				
19							FA213		FA213HH			MD651				
20							FA213		FA213HH			MD651				
21							FA213		FA213HH			MD671				
22							FA213		FA213HH			MD651				
23							FA213		FA213HH			MD671				
24							FA213		FA213HH			MD651				
25							FA213		FA213HH			MD651				
26							FA213		FA213HH			MD651				
27							FA213		FA213HH			MD651				
28						DB604/6	FA213		FA213HH			MD810		MD810C		
29						DB604/6	FA213		FA213HH			MD810		MD810C		
30							FA213		FA213HH			MD845				
31							FA213		FA213HH			MD671				
32							861									
33							861									
34							863									
35							FA18		FA18HH			MD611Ⓢ				
36							861									
37							861									
38							FA18		FA18HH			MD661Ⓢ				
39							FA18		FA18HH			MD611				
40							FA18		FA18HH			MD611				
41							FA18		FA18HH			MD611				
42							FA18		FA18HH			MD661Ⓢ				
43							FA18		FA18HH			MD661Ⓢ				
44						DB602/5	FA213		FA213HH			MD671				
45						DB602/5	FA213		FA213HH			MD671				
46							860									
47							860									
48							861									
49							860									
50							860									
51							861									
52							861									
53							861									
54																
55																
56																

BRAKE APPLICATIONS
 Ⓢ This symbol indicates a rotor made of billet steel, and should be only used with EBC FA Organic or Vee pads.
 SAFETY NOTICE - With vehicles primarily designed for off highway use such as quads now being used on the highway, we would recommend the use of X or MXS pads for highway use and ONLY using the R and SV higher density / harder pad series for off road riding.

*-2 Sets Required. † For Vee disc colours add RED, BLU, GRN, GLD, ORG suffix to part number. **SAFETY WARNING:- DO NOT USE HH PADS ON REAR UNLESS ALSO USED ON FRONT TO AVOID BRAKE IMBALANCE**

FRONT: Non-Japanese Bikes

APPLICATIONS

BRAKE



BMW



DISC PAD CHOICES - FRONT

BRAKE ROTOR CHOICES - FRONT

Model	Year	FA/SFA/X Pad or Brake Shoe	Specialty Pads SXR/VEE/MXS Race	Sintered/HH Pads/Grooved Shoes	EPFA Sintered Fast Road/Track Pads	GPFAX Sintered RACE ONLY Pads	SV Series Severe Duty Pads	Standard Rotor Left	Standard Rotor Right	Vintage Rotor / UTV Oversize Brake Kit	Contour Profile Rotor	Line #
R 80 GS	1987-1995	FA77	FA77V					MD606RS				1
R 80 Mystic	1994-1995	FA407*		FA407HH*	EPFA407HH*			MD605LS	MD605RS			2
R 80 PD/CH	1990-1995	FA77	FA77V					MD606RS				3
R 80 R	1991-1994	FA407*		FA407HH*	EPFA407HH*			MD605LS	MD605RS			4
R 80 R 80 RT	1984-1990	FA77	FA77V									5
R 80 R 80 RT	1984-1988	FA18*	FA18V*	FA18HH*				MD605LS	MD605RS			6
R 80 R 80 RT	1988-1995	FA171*	FA171V*	FA171HH*				MD605LS	MD605RS			7
R 80 R 80 RT	1990-1995	FA77	FA77V						MD605RS			8
R 80 RT	1982-1984	FA18*	FA18V*	FA18HH*				MD602LS	MD602RS			9
R 80 TIC	1978-1980	FA22*	FA22V*					MD602LS	MD602RS			10
R 80 TIC	1980-1985	FA18*	FA18V*	FA18HH*				MD602LS	MD602RS			11
F 800	2009-2013	FA244*	FA244V*	FA244HH*	EPFA244HH*			MD804Ⓞ	MD804Ⓞ			12
F 800 GS	2008-2018	FA209/2*	FA209/2V*	FA209/2HH*				MD834X	MD834X			13
F 800 GS Adventure	2012-2018	FA209/2*	FA209/2V*	FA209/2HH*				MD834X	MD834X			14
F 800 GT	2013-2018	FA244*	FA244V*	FA244HH*	EPFA244HH*			MD804Ⓞ	MD804Ⓞ			15
F 800 R	2009-2014	FA244*	FA244V*	FA244HH*	EPFA244HH*			MD804Ⓞ	MD804Ⓞ			16
F 800 R	2015-2018			FA630HH*	EPFA630HH*			MD804Ⓞ	MD804Ⓞ			17
F 800 S/ST	2006-2008	FA244*	FA244V*	FA244HH*	EPFA244HH*			MD803	MD803			18
F 850 GS	2018-2023	FA209/2*	FA209/2V*	FA209/2HH*				MD687Ⓞ	MD687Ⓞ			19
F 850 GS Adventure	2018-2023	FA209/2*	FA209/2V*	FA209/2HH*				MD687Ⓞ	MD687Ⓞ			20
F 850 GS Edition 40	2020-2021	FA209/2*	FA209/2V*	FA209/2HH*				MD687Ⓞ	MD687Ⓞ			21
R 850 C	1997-2000	FA407*		FA407HH*	EPFA407HH*			MD652Ⓞ	MD652Ⓞ		MD652C*	22
R 850 C	1997-2000	FA407*		FA407HH*	EPFA407HH*			MD652Ⓞ	MD652Ⓞ		MD652C*	23
R 850 GS	1996	FA77	FA77V					MD605RS				24
R 850 GS	1996-2000	FA407*		FA407HH*	EPFA407HH*			MD652	MD652		MD652C*	25
R 850 R	1994-1996	FA407*		FA407HH*	EPFA407HH*			MD652	MD652		MD652C*	26
R 850 R	2003-2006			FA294HH*	EPFA294HH*			MD616	MD616			27
R 850 R	1994-2002	FA407*		FA407HH*	EPFA407HH*			MD607LSⓄ	MD607RSⓄ			28
R 850 RT	1996-2001	FA407*		FA407HH*	EPFA407HH*			MD607LSⓄ	MD607RSⓄ			29
R 850 RT	2006			FA335HH*	EPFA335HH*			MD620	MD620			30
R 850 RT	1996-2001	FA407*		FA407HH*	EPFA407HH*			MD652	MD652		MD652C*	31
R 90 S	1973-1976	FA22*	FA22V*					MD602LS	MD602RS			32
F 900 GS	2023-2024	FA209/2*	FA209/2V*	FA209/2HH*				MD687Ⓞ	MD687Ⓞ			33
F 900 GS Adventure	2023-2024	FA209/2*	FA209/2V*	FA209/2HH*				MD687Ⓞ	MD687Ⓞ			34
F 900 R	2020-2024			FA630HH*	EPFA630HH*			MD804Ⓞ	MD804Ⓞ			35
F 900 XR	2020-2024			FA630HH*	EPFA630HH*			MD804Ⓞ	MD804Ⓞ			36
R 90/6	1973-1976	FA22	FA22V					MD602LS				37
R 90/6	1973-1976	FA22*	FA22V*					MD602LS	MD602RS			38
K1	1988-1993	FA407*		FA407HH*	EPFA407HH*			MD607LS	MD607RS			39
K1	1988-1993	FA407*		FA407HH*	EPFA407HH*			MD607LSⓄ	MD607RSⓄ			40
K 100	1982-1988	FA18*	FA18V*	FA18HH*				MD604LS	MD604RS			41
K 100 LT	1986-1988	FA18*	FA18V*	FA18HH*				MD604LS	MD604RS			42
K 100 LT	1986-1988	FA18*	FA18V*	FA18HH*				MD603LSⓄ	MD603RSⓄ			43
K 100 LT	1988-1991	FA171*	FA171V*	FA171HH*				MD604LS	MD604RS			44
K 100 LT	1988-1991	FA171*	FA171V*	FA171HH*				MD603LSⓄ	MD603RSⓄ			45
K 100 RS	1983-1988	FA18*	FA18V*	FA18HH*				MD604LS	MD604RS			46
K 100 RS	1983-1988	FA18*	FA18V*	FA18HH*				MD603LSⓄ	MD603RSⓄ			47
K 100 RS	1988-1989	FA171*	FA171V*	FA171HH*				MD604LS	MD604RS			48
K 100 RS	1988-1989	FA171*	FA171V*	FA171HH*				MD603LSⓄ	MD603RSⓄ			49
K 100 RS	1989-1992	FA407*		FA407HH*	EPFA407HH*			MD607LS	MD607RS			50
K 100 RS	1989-1992	FA407*		FA407HH*	EPFA407HH*			MD607LSⓄ	MD607RSⓄ			51
K 100 RT	1983-1988	FA18*	FA18V*	FA18HH*				MD604LS	MD604RS			52
K 100 RT	1983-1988	FA18*	FA18V*	FA18HH*				MD603LSⓄ	MD603RSⓄ			53

FRONT

Ⓞ - remove rotor outer ring from centre casting and refit.

Ⓞ - remove ABS ring from old rotor and refit to new EBC rotor. Note: Ensure all mounting surfaces are clean and when refitting bolts use a thread lock cement to hold them in place.

Ⓞ - OEM rotor has a fixed bobbin - EBC rotor requires a fitting kit - Not supplied by EBC Brakes

*-2 Sets Required. † For Vee disc colours add RED, BLU, GRN, GLD, ORG suffix to part number. **SAFETY WARNING:- DO NOT USE HH PADS ON REAR UNLESS ALSO USED ON FRONT TO AVOID BRAKE IMBALANCE**

FRONT: Non-Japanese Bikes Cont'd

REAR: Non-Japanese Bikes

Line #	BRAKE ROTOR CHOICES - FRONT					DISC PAD CHOICES - REAR					BRAKE ROTOR CHOICES - REAR					BRAKE APPLICATIONS
	CX Extreme® /Vee-Rotor	OSX Series Oversize 280mm Rotor Kit	Relocating Bracket for Oversize Rotor	SMX Series Oversize 320mm Rotor Kit	Relocating Bracket for 320mm Rotor	Front Disc Bolt Kit	FA/SFA/X Pad or Brake Shoe	Specialty Pads SXR/ VEE/MXS Race	Sintered/ HH Pads/ Grooved Shoes	EPFA Sintered Fast Road/ Track Pads	SV Series Severe Duty Pads	Standard Rotor	Vintage Rotor / UTV Oversize Brake Kit	Contour Profile Rotor	CX Extreme® /Vee-Rotor	
1								859								
2								859								
3								859								
4								859								
5								861								
6								861								
7								859								
8								861								
9								861								
10								860								
11								861								
12						DB602/5		FA213		FA213HH			MD671			
13								FA213		FA213HH			MD671			
14								FA213		FA213HH			MD671			
15						DB602/5		FA213		FA213HH			MD671			
16						DB602/5		FA213		FA213HH			MD671			
17						DB602/5		FA213		FA213HH			MD671			
18						DB601/5		FA213		FA213HH			MD671			
19						DB602/5		FA213		FA213HH			MD671			
20						DB602/5		FA213		FA213HH			MD671			
21						DB602/5		FA213		FA213HH			MD671			
22						DB601/5		FA363		FA363HH						
23						DB601/5		FA363		FA363HH						
24								859								
25						DB601/5		FA363		FA363HH			MD653		MD653C	
26						DB601/5		FA363		FA363HH			MD653		MD653C	
27						DB601/5		FA363		FA363HH			MD653			
28						DB601/6		FA363		FA363HH			MD653Ⓢ			
29						DB601/6		FA363		FA363HH			MD653Ⓢ			
30						DB601/5		FA363		FA363HH			MD653			
31						DB601/5		FA363		FA363HH			MD653		MD653C	
32								860								
33						DB602/5		FA213		FA213HH			MD671			
34						DB602/5		FA213		FA213HH			MD671			
35						DB602/5		FA213		FA213HH						
36						DB602/5		FA213		FA213HH						
37								860								
38								860								
39						DB601/6		FA18		FA18HH			MD611			
40						DB601/6		FA18		FA18HH			MD661Ⓢ			
41								FA18		FA18HH			MD611			
42								FA18		FA18HH			MD611			
43								FA18		FA18HH			MD661Ⓢ			
44								FA18		FA18HH			MD611			
45								FA18		FA18HH			MD661Ⓢ			
46								FA18		FA18HH			MD611			
47								FA18		FA18HH			MD661Ⓢ			
48								FA18		FA18HH			MD611			
49								FA18		FA18HH			MD661Ⓢ			
50						DB601/6		FA18		FA18HH			MD611			
51						DB601/6		FA18		FA18HH			MD661Ⓢ			
52								FA18		FA18HH			MD611			
53								FA18		FA18HH			MD661			
54																
55																
56																

Ⓢ This symbol indicates a rotor made of billet steel, and should be only used with EBC FA Organic or Vee pads.
 SAFETY NOTICE - With vehicles primarily designed for off highway use such as quads now being used on the highway, we would recommend the use of X or MXS pads for highway use and ONLY using the R and SV higher density / harder pad series for off road riding.

*-2 Sets Required. † For Vee disc colours add RED, BLU, GRN, GLD, ORG suffix to part number. **SAFETY WARNING:- DO NOT USE HH PADS ON REAR UNLESS ALSO USED ON FRONT TO AVOID BRAKE IMBALANCE**

FRONT: Non-Japanese Bikes

APPLICATIONS

BRAKE



BMW



DISC PAD CHOICES - FRONT

BRAKE ROTOR CHOICES - FRONT

Model	Year	FA/SFA/X Pad or Brake Shoe	Specialty Pads SXR/VEE/MXS Race	Sintered/HH Pads/Grooved Shoes	EPFA Sintered Fast Road/Track Pads	GPFAX Sintered RACE ONLY Pads	SV Series Severe Duty Pads	Standard Rotor		Vintage Rotor / UTV Oversize Brake Kit	Contour Profile Rotor	Line #
								Standard Rotor Left	Standard Rotor Right			
K 100 RT	1988-1989	FA171*	FA171V*	FA171HH*				MD604LS	MD604RS			1
K 100 RT	1988-1989	FA171*	FA171V*	FA171HH*				MD603LS [Ⓢ]	MD603RS [Ⓢ]			2
R 100	1976-1977	FA22	FA22V					MD602LS				3
R 100	1976-1977	FA22*	FA22V*					MD602LS	MD602RS			4
R 100 7T	1977-1980	FA22	FA22V					MD602LS				5
R 100 7T	1977-1980	FA22*	FA22V*					MD602LS	MD602RS			6
R 100 7T	1980-1984	FA18*	FA18V*	FA18HH*				MD606LS	MD606RS			7
R 100 7T	1980-1984	FA18*	FA18V*	FA18HH*				MD602LS	MD602RS			8
R 100 GS	1986-1994	FA77	FA77V					MD605RS				9
R 100 GS	1986-1994	FA77	FA77V						MD605RS			10
R 100 Mystic	1993-1996	FA407*		FA407HH*	EPFA407HH*			MD605LS	MD605RS			11
R 100 PD	1989-1996	FA77	FA77V					MD605RS				12
R 100 PD	1989-1996	FA77	FA77V						MD605RS			13
R 100 R	1991-1995	FA407*		FA407HH*	EPFA407HH*			MD605LS	MD605RS			14
R 100 RS	1976-1980	FA22*	FA22V*					MD602LS	MD602RS			15
R 100 RS	1980-1984	FA18*	FA18V*	FA18HH*				MD602LS	MD602RS			16
R 100 RS	1986-1988	FA18*	FA18V*	FA18HH*				MD605LS	MD605RS			17
R 100 RS	1988-1989	FA171*	FA171V*	FA171HH*				MD605LS	MD605RS			18
R 100 RS	1989-1992	FA171*	FA171V*	FA171HH*				MD605LS	MD605RS			19
R 100 RT	1978-1980	FA22*	FA22V*					MD602LS	MD602RS			20
R 100 RT	1980-1984	FA18*	FA18V*	FA18HH*				MD602LS	MD602RS			21
R 100 RT	1987-1988	FA18*	FA18V*	FA18HH*				MD605LS	MD605RS			22
R 100 RT	1988-1989	FA171*	FA171V*	FA171HH*				MD605LS	MD605RS			23
R 100 RT	1989-1995	FA171*	FA171V*	FA171HH*				MD605LS	MD605RS			24
R 100 S	1976-1980	FA22*	FA22V*					MD602LS	MD602RS			25
HP4	2013-2014			FA447HH*	EPFA447HH*	GPFAX447HH*		MD862X	MD862X			26
M 1000 RR	2021-2023			FA757HH*	EPFA757HH*	GPFAX757HH*		MD8017X	MD8017X			27
S 1000 R	2018-2021			FA724HH*	EPFA724HH*	GPFAX724HH*		MD804 [Ⓢ]	MD804 [Ⓢ]			28
S 1000 R	2013-2022			FA604/4HH*	EPFA604/4HH*			MD862X	MD862X			29
S 1000 RR	2008-2018			FA604/4HH*	EPFA604/4HH*	GPFAX604/4HH*		MD862X	MD862X			30
S 1000 RR	2015-2017			FA604/4HH*	EPFA604/4HH*			MD862X	MD862X			31
S 1000 RR HP4 Race	2017-2018					GPFAX611HH*						32
S 1000 RR/RR Sport	2021-2023			FA757HH*	EPFA757HH*	GPFAX757HH*		MD8017X	MD8017X			33
S 1000 RR/RR Sport/RR M Sport	2019-2020			FA724HH*	EPFA724HH*	GPFAX724HH*		MD8017X	MD8017X			34
S 1000 XR	2014-2019			FA630HH*	EPFA630HH*			MD804 [Ⓢ]	MD804 [Ⓢ]			35
S 1000 XR	2014-2019			FA630HH*	EPFA630HH*			MD862X	MD862X			36
S 1000 XR	2019-2024			FA724HH*	EPFA724HH*	GPFAX724HH*		MD804 [Ⓢ]	MD804 [Ⓢ]			37
K 100/2	1987-1988	FA18*	FA18V*	FA18HH*				MD604LS	MD604RS			38
K 100/2	1987-1988	FA18*	FA18V*	FA18HH*				MD603LS [Ⓢ]	MD603RS [Ⓢ]			39
K 100/2	1988-1990	FA171*	FA171V*	FA171HH*				MD604LS	MD604RS			40
K 100/2	1988-1990	FA171*	FA171V*	FA171HH*				MD603LS [Ⓢ]	MD603RS [Ⓢ]			41
K 1100 LT	1989-1993	FA407*		FA407HH*	EPFA407HH*			MD607LS	MD607RS			42
K 1100 LT	1989-1993	FA407*		FA407HH*	EPFA407HH*			MD607LS	MD607RS			43
K 1100 LT	1993-1999	FA407*		FA407HH*	EPFA407HH*			MD607LS	MD607RS			44
K 1100 LT	1993-1999	FA407*		FA407HH*	EPFA407HH*			MD607LS	MD607RS			45
K 1100 RS	1992-1996	FA407*		FA407HH*	EPFA407HH*			MD607LS [Ⓢ]	MD607RS [Ⓢ]			46
K 1100 RS	1992-1996	FA407*		FA407HH*	EPFA407HH*			MD607LS	MD607RS			47
R 1100 GS	1993-1999	FA407*		FA407HH*	EPFA407HH*			MD652	MD652		MD652C*	48
R 1100 GS	1993-1999	FA407*		FA407HH*	EPFA407HH*			MD652	MD652		MD652C*	49
R 1100 R	1993-1996	FA407*		FA407HH*	EPFA407HH*			MD652	MD652		MD652C*	50
R 1100 R	1993-2001	FA407*		FA407HH*	EPFA407HH*			MD607LS	MD607RS			51
R 1100 RS	1992-2001	FA407*		FA407HH*	EPFA407HH*			MD607LS	MD607RS			52
R 1100 RT	1994-2001	FA407*		FA407HH*	EPFA407HH*			MD652	MD652		MD652C*	53
R 1100 RT	1994-2001	FA407*		FA407HH*	EPFA407HH*			MD607LS [Ⓢ]	MD607RS [Ⓢ]			54

FRONT

Ⓢ - remove ABS ring from old rotor and refit to new EBC rotor. Note: Ensure all mounting surfaces are clean and when refitting bolts use a thread lock cement to hold them in place.
 Ⓢ - OEM rotor has a fixed bobbin - EBC rotor requires a fitting kit - Not supplied by EBC Brakes

*-2 Sets Required. † For Vee disc colours add RED, BLU, GRN, GLD, ORG suffix to part number. **SAFETY WARNING:- DO NOT USE HH PADS ON REAR UNLESS ALSO USED ON FRONT TO AVOID BRAKE IMBALANCE**

FRONT: Non-Japanese Bikes Cont'd

REAR: Non-Japanese Bikes

Line #	BRAKE ROTOR CHOICES - FRONT					Front Disc Bolt Kit	DISC PAD CHOICES - REAR					BRAKE ROTOR CHOICES - REAR				
	CX Extreme® /Vee-Rotor	OSX Series Oversize 280mm Rotor Kit	Relocating Bracket for Oversize Rotor	SMX Series Oversize 320mm Rotor Kit	Relocating Bracket for 320mm Rotor		FA/SFA/X Pad or Brake Shoe	Specialty Pads SXR/ VEE/MXS Race	Sintered/ HH Pads/ Grooved Shoes	EPFA Sintered Fast Road/ Track Pads	SV Series Severe Duty Pads	Standard Rotor	Vintage Rotor / UTV Oversize Brake Kit	Contour Profile Rotor	CX Extreme® /Vee-Rotor	Rear Disc Bolt Kit
1							FA18		FA18HH			MD661				
2							FA18		FA18HH			MD661				
3							860									
4							860									
5							860									
6							860									
7							861									
8							861									
9							859									
10							859									
11							859									
12							859									
13							859									
14							859									
15							860									
16							FA18		FA18HH			MD602LS				
17							861									
18							861									
19							859									
20							860									
21							FA18		FA18HH			MD602LS				
22							861									
23							861									
24							859									
25							860									
26							FA213		FA213HH			MD832				
27							FA213		FA254HH	EPFA254HH		MD832				
28						DB602/5	FA213		FA213HH			MD832				
29							FA213		FA213HH			MD832				
30							FA213		FA213HH			MD832				
31							FA213		FA213HH			MD832				
32							FA213		FA730HH	EPFA730HH		MD832				
33							FA213		FA213HH			MD832				
34							FA213		FA213HH			MD832				
35						DB602/5	FA363		FA363HH			MD671				
36							FA363		FA363HH			MD671				
37						DB602/5	FA363		FA363HH			MD8022				
38							FA18		FA18HH			MD611				
39							FA18		FA18HH			MD661Ⓣ				
40							FA18		FA18HH			MD611				
41							FA18		FA18HH			MD661Ⓣ				
42						DB601/6	FA18		FA18HH			MD611				
43						DB601/6	FA18		FA18HH			MD661				
44						DB601/6	FA18		FA18HH			MD661				
45						DB601/6	FA18		FA18HH			MD661				
46						DB601/6	FA18		FA18HH			MD661Ⓣ				
47						DB601/6	FA18		FA18HH			MD661				
48						DB601/5	FA363		FA363HH			MD653		MD653C		
49						DB601/5	FA363		FA363HH			MD653		MD653C		
50						DB601/5	FA363		FA363HH			MD653		MD653C		
51						DB601/6	FA363		FA363HH			MD653				
52						DB601/6	FA18		FA18HH			MD661				
53						DB601/5	FA363		FA363HH			MD653		MD653C		
54						DB601/6	FA363		FA363HH			MD653Ⓣ				
55																
56																

BRAKE APPLICATIONS
 This symbol indicates a rotor made of billet steel, and should be only used with EBC FA Organic or Vee pads.
 SAFETY NOTICE - With vehicles primarily designed for off highway use such as quads now being used on the highway, we would recommend the use of X or MXS pads for highway use and ONLY using the R and SV higher density / harder pad series for off road riding.

*-2 Sets Required. † For Vee disc colours add RED, BLU, GRN, GLD, ORG suffix to part number. **SAFETY WARNING:- DO NOT USE HH PADS ON REAR UNLESS ALSO USED ON FRONT TO AVOID BRAKE IMBALANCE**

FRONT: Non-Japanese Bikes

APPLICATIONS

BRAKE



BMW



DISC PAD CHOICES - FRONT

BRAKE ROTOR CHOICES - FRONT

Model	Year	Left	Right	DISC PAD CHOICES - FRONT					BRAKE ROTOR CHOICES - FRONT				Line #		
				FA/SFA/X Pad or Brake Shoe	Specialty Pads SXR/ VEE/MXS Race	Sintered/ HH Pads/ Grooved Shoes	EPFA Sintered Fast Road/Track Pads	GPFAX Sintered RACE ONLY Pads	SV Series Severe Duty Pads	Standard Rotor Left	Standard Rotor Right	Vintage Rotor / UTV Oversize Brake Kit		Contour Profile Rotor	
R 1100 S	1996-2000			FA407*		FA407HH*	EPFA407HH*				MD652	MD652			1
R 1100 S	2000-2006					FA294HH*	EPFA294HH*				MD616	MD616			2
R 1100 S	2000-2006					FA335HH*	EPFA335HH*				MD803	MD803			3
R 1100 S	2001-2006					FA294HH*	EPFA335HH*				MD616Ⓣ	MD616Ⓣ			4
C1 125	1999-2003			SFA209/2		SFA209/2HH					MD968D				5
R 1150 GS	1998-2001			FA407*		FA407HH*	EPFA407HH*				MD652	MD652		MD652C*	6
R 1150 GS	2001-2003					FA335HH*	EPFA335HH*				MD652	MD652		MD652C*	7
R 1150 GS Adventure	2001-2004					FA335HH*	EPFA335HH*				MD652	MD652		MD652C*	8
R 1150 GS Adventure	2001-2005					FA294HH*	EPFA294HH*				MD652	MD652		MD652C*	9
R 1150 R	2001-2006					FA294HH*	EPFA294HH*				MD616	MD616			10
R 1150 R Rockster/Edition 80	2003-2005					FA294HH*	EPFA294HH*				MD616	MD616			11
R 1150 RS	2001-2005					FA294HH*	EPFA294HH*				MD616	MD616			12
R 1150 RT	2000-2005					FA335HH*	EPFA335HH*				MD620	MD620			13
K 1200 GT	2003-2006					FA335HH*	EPFA335HH*				MD620	MD620			14
K 1200 GT	2006-2008	Left	Right			FA335HH					MD804Ⓣ				15
						FA441HH						MD804Ⓣ			16
K 1200 LT	1997-2000			FA407*		FA407HH*	EPFA407HH*				MD652	MD652			17
K 1200 LT	2000-2007					FA294HH*	EPFA294HH*				MD616	MD616			18
K 1200 LT	2007-2009					FA294HH*	EPFA294HH*				MD804Ⓣ	MD804Ⓣ			19
K 1200 R	2005-2007					FA294HH*	EPFA294HH*				MD804Ⓣ	MD804Ⓣ			20
K 1200 R	2007-2010					FA294HH*	EPFA294HH*				MD804Ⓣ	MD804Ⓣ			21
K 1200 RS	2001-2005					FA335HH*	EPFA335HH*				MD620	MD620			22
K 1200 RS Non ABS & ABS Models	1996-2000			FA407*		FA407HH*	EPFA407HH*				MD652	MD652			23
K 1200 S	2003-2007					FA335HH*	EPFA335HH*				MD620	MD620			24
K 1200 S	2007-2008					FA335HH*	EPFA335HH*				MD804Ⓣ	MD804Ⓣ			25
G 1200 Gladiator	2013-2017			FA407*		FA407HH	EPFA407HH*				MD652	MD652		MD652C*	26
HP2	2005-2008			FA209/2	FA209/2V	FA209/2HH					MD687Ⓣ	MD687Ⓣ			27
HP2 Megamoto	2007					FA335HH*	EPFA335HH*				MD803	MD803			28
HP2 Megamoto	2007-2009					FA335HH*	EPFA335HH*				MD804Ⓣ	MD804Ⓣ			29
HP2 Sport	2008-2011					FA447HH*	EPFA447HH*				MD804Ⓣ	MD804Ⓣ			30
R 1200	2003-2007					FA335HH*	EPFA335HH*				MD803	MD803			31
R 1200	2007-2008					FA335HH*	EPFA335HH*				MD804Ⓣ	MD804Ⓣ			32
R 1200	2000-2003			FA407*		FA407HH*	EPFA407HH*				MD652	MD652		MD652C*	33
R 1200 C	1996-2003			FA407*		FA407HH*	EPFA407HH*				MD652Ⓣ	MD652Ⓣ		MD652C*	34
R 1200 C	1996-2003			FA407*		FA407HH*	EPFA407HH*				MD652Ⓣ	MD652Ⓣ		MD652C*	35
R 1200 C Montauk	2004-2005					FA294HH*	EPFA294HH*				MD652Ⓣ	MD652Ⓣ		MD652C*	36
R 1200 CL	2002-2004					FA294HH*	EPFA294HH*				MD652	MD652		MD652C*	37
R 1200 GS	2013-2018					FA630HH*	EPFA630HH*				MD687Ⓣ	MD687Ⓣ			38
R 1200 GS	2002-2007					FA335HH*	EPFA335HH*				MD687Ⓣ	MD687Ⓣ			39
R 1200 GS Adventure	2014-2018					FA630HH*	EPFA630HH*				MD687Ⓣ	MD687Ⓣ			40
R 1200 GS Adventure	2005-2007					FA335HH*	EPFA335HH*				MD687Ⓣ	MD687Ⓣ			41
R 1200 GS Adventure/M	2006-2013					FA335HH*	EPFA335HH*				MD687Ⓣ	MD687Ⓣ			42
R 1200 GS/M	2006-2012					FA335HH*	EPFA335HH*				MD687Ⓣ	MD687Ⓣ			43
R 1200 R	2006-2007					FA294HH*	EPFA294HH*				MD804Ⓣ	MD804Ⓣ			44
R 1200 R	2015-2018					FA630HH*	EPFA630HH*				MD804Ⓣ	MD804Ⓣ			45
R 1200 R	2008-2014					FA294HH*	EPFA294HH*				MD804Ⓣ	MD804Ⓣ			46
R 1200 RS	2015-2018					FA630HH*	EPFA630HH*				MD804Ⓣ	MD804Ⓣ			47
R 1200 RT	2014-2018					FA630HH*	EPFA630HH*				MD804Ⓣ	MD804Ⓣ			48
R 1200 RT	2003-2007					FA335HH*	EPFA335HH*				MD803	MD803			49
R 1200 RT	2010-2013					FA335HH*	EPFA335HH*				MD804Ⓣ	MD804Ⓣ			50
R 1200 S	2006-2007					FA335HH*	EPFA335HH*				MD803	MD803			51
R 1200 S	2007-2010					FA335HH*	EPFA335HH*				MD804Ⓣ	MD804Ⓣ			52
R nineT K21	2014-2018					FA630HH*	EPFA630HH*				MD804Ⓣ	MD804Ⓣ			53
R NineT Pure	2018-2024					FA244HH*					MD804Ⓣ	MD804Ⓣ			54

FRONT

Ⓣ - remove ABS ring from old rotor and refit to new EBC rotor. Note: Ensure all mounting surfaces are clean and when refitting bolts use a thread lock cement to hold them in place.
 Ⓣ - OEM rotor has a fixed bobbin - EBC rotor requires a fitting kit - Not supplied by EBC Brakes

*-2 Sets Required. † For Vee disc colours add RED, BLU, GRN, GLD, ORG suffix to part number. **SAFETY WARNING:- DO NOT USE HH PADS ON REAR UNLESS ALSO USED ON FRONT TO AVOID BRAKE IMBALANCE**

Part numbers, prefixes, suffixes, photos and illustrations shown in this catalog are trademarks and/or copyrights of EBC Brakes or the trademark owner A C Freeman Investments Ltd and use without express written permission of the owners is punishable by law.

This symbol indicates a rotor made of billet steel, and should be only used with EBC FA Organic or Vee pads.
 SAFETY NOTICE - With vehicles primarily designed for off highway use such as quads now being used on the highway, we would recommend the use of X or MXS pads for highway use and ONLY using the R and SV higher density / harder pad series for off road riding.

FRONT: Non-Japanese Bikes Cont'd

REAR: Non-Japanese Bikes

Line #	BRAKE ROTOR CHOICES - FRONT					REAR	DISC PAD CHOICES - REAR					BRAKE ROTOR CHOICES - REAR				
	CX Extreme® /Vee-Rotor	OSX Series Oversize 280mm Rotor Kit	Relocating Bracket for Oversize Rotor	SMX Series Oversize 320mm Rotor Kit	Relocating Bracket for 320mm Rotor		Front Disc Bolt Kit	FA/SFA/X Pad or Brake Shoe	Specialty Pads SXR/ VEE/MXS Race	Sintered/ HH Pads/ Grooved Shoes	EPFA Sintered Fast Road/ Track Pads	SV Series Severe Duty Pads	Standard Rotor	Vintage Rotor / UTV Oversize Brake Kit	Contour Profile Rotor	CX Extreme® /Vee-Rotor
1						DB601/5	FA363		FA363HH			MD653		MD653C		
2						DB601/5	FA363		FA363HH			MD653				
3						DB601/5	FA363		FA363HH			MD653				
4						DB601/5	FA363		FA363HH			MD653				
5						DB601/5	SFA213		SFA213HH			MD968D				
6						DB601/5	FA363		FA363HH			MD653		MD653C		
7						DB601/5	FA363		FA363HH			MD653		MD653C		
8						DB601/5	FA363		FA363HH			MD653		MD653C		
9						DB601/5	FA363		FA363HH			MD653		MD653C		
10						DB601/5	FA363		FA363HH			MD653				
11						DB601/5	FA363		FA363HH			MD653				
12						DB601/5	FA363		FA363HH			MD653				
13						DB601/5	FA363		FA363HH			MD653				
14						DB601/5	FA18		FA18HH			MD661				
15						DB602/5			FA438HH			MD688				
16									MWL002							
17						DB601/5	FA304		FA304HH			MD615				
18						DB601/5	FA304		FA304HH			MD615				
19						DB602/5	FA304		FA304HH			MD615				
20						DB602/5	FA671		FA671HH			MD671				
21						DB602/5	FA671		FA671HH			MD671				
22						DB601/5	FA18		FA18HH			MD661				
23						DB601/5	FA18		FA18HH			MD661				
24						DB601/5	FA671		FA671HH			MD671				
25						DB602/5	FA671		FA671HH			MD671				
26						DB601/5	FA363		FA363HH			MD671				
27						DB601/5	FA363		FA363HH			MD671				
28						DB601/5	FA363		FA363HH			MD671				
29						DB602/5	FA363		FA363HH			MD671				
30						DB602/5	FA363		FA363HH			MD671				
31						DB601/5	FA363		FA363HH			MD671				
32						DB602/5	FA363		FA363HH			MD671				
33						DB601/5	FA363		FA363HH							
34						DB601/5	FA363		FA363HH							
35						DB601/5	FA363		FA363HH							
36						DB601/5	FA363		FA363HH							
37						DB601/5	FA304		FA304HH							
38						DB602/5	FA209/2		FA209/2HH			MD8001				
39						DB601/5	FA363		FA363HH			MD671				
40						DB602/5	FA209/2		FA209/2HH			MD8001				
41						DB602/5	FA363		FA363HH			MD671				
42						DB601/5	FA363		FA363HH			MD671				
43						DB601/5	FA363		FA363HH			MD671				
44						DB602/5	FA363		FA363HH			MD671				
45						DB602/5			FA209/2HH			MD8001				
46						DB602/5	FA363		FA363HH			MD671				
47						DB602/5			FA209/2HH			MD8001				
48						DB602/5	FA209/2		FA209/2HH			MD8001				
49						DB601/5	FA363		FA363HH			MD671				
50						DB602/5	FA363		FA363HH			MD671				
51						DB601/5	FA363		FA363HH			MD671				
52						DB602/5	FA363		FA363HH			MD671				
53						DB602/5	FA363		FA363HH			MD671				
54						DB602/5	FA363		FA363HH			MD671				
55																
56																

BRAKE APPLICATIONS

⊗ This symbol indicates a rotor made of billet steel, and should be only used with EBC FA Organic or Vee pads.
SAFETY NOTICE - With vehicles primarily designed for off highway use such as quads now being used on the highway, we would recommend the use of X or MXS pads for highway use and ONLY using the R and SV higher density / harder pad series for off road riding.

*-2 Sets Required. † For Vee disc colours add RED, BLU, GRN, GLD, ORG suffix to part number. **SAFETY WARNING:- DO NOT USE HH PADS ON REAR UNLESS ALSO USED ON FRONT TO AVOID BRAKE IMBALANCE**

FRONT: Non-Japanese Bikes

APPLICATIONS
BRAKE



BMW



DISC PAD CHOICES - FRONT

BRAKE ROTOR CHOICES - FRONT

FA/SFA/X Pad or Brake Shoe	Specialty Pads SXR/ VEE/MXS Race	Sintered/ HH Pads/ Grooved Shoes	EPFA Sintered Fast Road/Track Pads	GPFA Sintered RACE ONLY Pads	SV Series Severe Duty Pads	Standard Rotor Left	Standard Rotor Right	Vintage Rotor / UTV Oversize Brake Kit	Contour Profile Rotor
		FA630HH*				MD804Ⓞ	MD804Ⓞ		
		FA244HH*				MD804Ⓞ	MD804Ⓞ		
		FA244HH*				MD804Ⓞ	MD804Ⓞ		
		FA244HH*				MD804Ⓞ	MD804Ⓞ		
		FA724HH*	EPFA724HH*			MD687Ⓞ	MD687Ⓞ		
		FA724HH*	EPFA724HH*			MD687Ⓞ	MD687Ⓞ		
		FA630HH*	EPFA630HH*			MD687Ⓞ	MD687Ⓞ		
		FA724HH*	EPFA724HH*			MD687Ⓞ	MD687Ⓞ		
		FA724HH*	EPFA724HH*			MD687Ⓞ	MD687Ⓞ		
		FA724HH*	EPFA724HH*			MD687Ⓞ	MD687Ⓞ		
		FA724HH*	EPFA724HH*			MD687Ⓞ	MD687Ⓞ		
		FA630HH*	EPFA630HH*			MD687Ⓞ	MD687Ⓞ		
		FA779HH*							
		FA779HH*							
		FA779HH*							
		FA630HH*	EPFA630HH*			MD804Ⓞ	MD804Ⓞ		
		FA630HH*	EPFA630HH*			MD804Ⓞ	MD804Ⓞ		
		FA724HH*	EPFA724HH*			MD804Ⓞ	MD804Ⓞ		
		FA724HH*	EPFA724HH*	GPFA724HH*		MD804Ⓞ	MD804Ⓞ		
		FA724HH*	EPFA724HH*	GPFA724HH*		MD804Ⓞ	MD804Ⓞ		
		FA335HH*	EPFA335HH*			MD804Ⓞ	MD804Ⓞ		
		FA294HH*	EPFA294HH*			MD804Ⓞ	MD804Ⓞ		
		FA335HH*	EPFA335HH*			MD804Ⓞ	MD804Ⓞ		
		FA613HH*				MD616	MD616		
		FA613HH*				TBC	TBC		
		FA613HH*				MD616	MD616		
		FA613HH*				MD616	MD616		
		FA613HH*				TBC	TBC		
		FA613HH*				TBC	TBC		
		FA613HH*				MD616	MD616		
		FA613HH*				MD616	MD616		
		FA613HH*				MD616	MD616		
		FA748HH*							
		FA748HH*							
		FA748HH*							
		FA748HH*							
		FA748HH*							
		FA748HH*							
		FA748HH*							
		FA95	FA95HH	EPFA95HH			MD614X		
			944G						
		FA47X							
		FA47X							
		FA134X	FA134R						
		FA134X	FA134R						
		FA47X							
		FA47	FA47HH						
						MD6265D			
		FA244*	FA244HH*	EPFA244HH*		MD660LS	MD660RS		
		FA142*	FA142HH*						
		FA244*	FA244HH*	EPFA244HH*		MD660LS	MD660RS		

CAGIVA

Mito 125	1992-2002
WMX 125	1985
WMX 125	1986
WMX 250	1985
WMX 250	1987-1988
WMX 250	1989-1991
WMX 500	1984-1986
Alazzurra/Elefant 650	1985-1986
Elefant 650	1986-1987
Raptor/V-Raptor 650	2000-2002
Gran Canyon 900	1999-2000
Raptor/V-Raptor 1000	2000-2002

FRONT

Line #
1
2
3
4
5
6
7
8
9
10
11
12
13
14
15
16
17
18
19
20
21
22
23
24
25
26
27
28
29
30
31
32
33
34
35
36
37
38
39
40
41
42
43
44
45
46
47
48
49
50
51
52
53
54
55
56

Ⓞ - OEM rotor has a fixed bobbin - EBC rotor requires a fitting kit - Not supplied by EBC Brakes

*-2 Sets Required. † For Vee disc colours add RED, BLU, GRN, GLD, ORG suffix to part number. **SAFETY WARNING:- DO NOT USE HH PADS ON REAR UNLESS ALSO USED ON FRONT TO AVOID BRAKE IMBALANCE**

* This symbol indicates a rotor made of billet steel, and should be only used with EBC FA Organic or Vee pads.
 SAFETY NOTICE - With vehicles primarily designed for off highway use such as quads now being used on the highway, we would recommend the use of X or MXS pads for highway use and ONLY using the R and SV higher density / harder pad series for off road riding.

FRONT: Non-Japanese Bikes Cont'd

REAR: Non-Japanese Bikes

Line #	BRAKE ROTOR CHOICES - FRONT					REAR	DISC PAD CHOICES - REAR					BRAKE ROTOR CHOICES - REAR				
	CX Extreme® /Vee-Rotor	OSX Series Oversize 280mm Rotor Kit	Relocating Bracket for Oversize Rotor	SMX Series Oversize 320mm Rotor Kit	Relocating Bracket for 320mm Rotor		Front Disc Bolt Kit	FA/SFA/X Pad or Brake Shoe	Specialty Pads SXR/ VEE/MXS Race	Sintered/ HH Pads/ Grooved Shoes	EPFA Sintered Fast Road/ Track Pads	SV Series Severe Duty Pads	Standard Rotor	Vintage Rotor / UTV Oversize Brake Kit	Contour Profile Rotor	CX Extreme® /Vee-Rotor
1						DB602/5	FA363		FA363HH			MD671				
2						DB602/5	FA363		FA363HH			MD671				
3						DB602/5	FA363		FA363HH			MD671				
4						DB602/5	FA363		FA363HH			MD671				
5						DB602/5	FA209/2		FA209/2HH			MD8001				
6						DB602/5	FA209/2		FA209/2HH			MD8001				
7						DB602/5	FA209/2		FA209/2HH			MD8001				
8						DB602/5	FA209/2		FA209/2HH			MD8001				
9						DB602/5	FA209/2		FA209/2HH			MD8001				
10						DB602/5	FA209/2		FA209/2HH			MD8001				
11						DB602/5	FA209/2		FA209/2HH			MD8001				
12						DB602/5	FA209/2		FA209/2HH			MD8001				
13						DB602/5	FA209/2		FA209/2HH			MD8001				
14							FA209/2		FA209/2HH							
15							FA209/2		FA209/2HH							
16							FA209/2		FA209/2HH							
17						DB602/5	FA209/2		FA209/2HH							
18						DB602/5	FA209/2		FA209/2HH							
19						DB602/5	FA209/2		FA209/2HH			MD8001				
20						DB602/5	FA209/2		FA209/2HH			MD8001				
21						DB602/5	FA209/2		FA209/2HH			MD8001				
22						DB602/5	FA363		FA363HH			MD688				
23						DB602/5	FA671		FA671HH			MD671				
24						DB602/5	FA671		FA671HH			MD671				
25						DB601/5			FA209/2HH							
26									FA209/2HH							
27						DB601/5			FA209/2HH							
28						DB601/5			FA209/2HH							
29						DB601/5			FA209/2HH							
30									FA209/2HH							
31									FA209/2HH							
32						DB601/5			FA209/2HH							
33						DB601/5			FA209/2HH							
34						DB601/5			FA209/2HH							
35									FA749HH							
36									FA749HH							
37									FA749HH							
38									FA749HH							
39									FA749HH							
40																
41																
42							FA47		FA47HH			MD638				
43									841G							
44																
45									841G							
46																
47							FA67X		FA67R							
48									982G							
49							FA47		FA47HH							
50							FA163					MD6259D				
51							FA266		FA266HH	EPFA266HH		MD617				
52							FA165/2X					MD6160D				
53							FA266		FA266HH	EPFA266HH		MD617				
54																
55																
56																

⚠ This symbol indicates a rotor made of billet steel, and should be only used with EBC FA Organic or Vee pads.
SAFETY NOTICE - With vehicles primarily designed for off highway use such as quads now being used on the highway, we would recommend the use of X or MXS pads for highway use and ONLY using the R and SV higher density / harder pad series for off road riding.

*-2 Sets Required. † For Vee disc colours add RED, BLU, GRN, GLD, ORG suffix to part number. **SAFETY WARNING:- DO NOT USE HH PADS ON REAR UNLESS ALSO USED ON FRONT TO AVOID BRAKE IMBALANCE**

FRONT: Non-Japanese Bikes

APPLICATIONS

BRAKE



CF MOTO



DISC PAD CHOICES - FRONT

BRAKE ROTOR CHOICES - FRONT

Model	Year	Side	FA/SFA/X Pad or Brake Shoe	Specialty Pads SXR/VEE/MXS Race	Sintered/HH Pads/Grooved Shoes	EPFA Sintered Fast Road/Track Pads	GPFAX Sintered RACE ONLY Pads	SV Series Severe Duty Pads	Standard Rotor		Vintage Rotor / UTV Oversize Brake Kit	Contour Profile Rotor	Line #
									Standard Rotor Left	Standard Rotor Right			
Papio 126	2021-2023		SFA228										1
CF 300 NK	2019-2022		FA95		FA95HH								2
CF 300 SS	2021-2023		FA95		FA95HH								3
CF 400 ATR-2L/2S Gen 1	2014-2021		FA453X*		FA453R*								4
CF 400 ATR-2L/2S Gen 2	2022-2023		FA726X*	SXR726HH*	FA726R*			FA726SV*					5
CF 400 AU	2017-2020		FA726X*	SXR726HH*	FA726R*			FA726SV*					6
CF 400 AU-A	2019-2020		FA453X*		FA453R*								7
CF 400 AU-A Gen 2	2021-2022		FA726X*	SXR726HH*	FA726R*			FA726SV*					8
CF 400 AU-A, B	2016-2018		FA726X*	SXR726HH*	FA726R*			FA726SV*					9
CF 400 AU-B Gen 2	2019-2021		FA726X*	SXR726HH*	FA726R*			FA726SV*					10
CF 400 AU-SF, LF Gen 2	2021-2022		FA726X*	SXR726HH*	FA726R*			FA726SV*					11
CF 400 SS	2023-2024		FA95		FA95HH								12
CF 450 ATR-3S, 3L	2022-2023		FA726X*	SXR726HH*	FA726R*			FA726SV*					13
CF 450 AU-3S, 3L	2022-2023		FA726X*	SXR726HH*	FA726R*			FA726SV*					14
CF 450 AU-SF, LF	2021-2022		FA726X*	SXR726HH*	FA726R*			FA726SV*					15
CF 500	2013-2016		FA453X*		FA453R*								16
CF 500 3	2011-2015	Left	FA135X		FA135R			FA135SV					17
		Right	FA165X		FA165R			FA165SV					18
CF 500 2-A-2A	2013-2016		FA453X*		FA453R*								19
CF 500 AU-6L	2016-2019		FA453X*		FA453R*								20
CF 500 AU-7L	2017		FA726X*	SXR726HH*	FA726R*								21
CF 500 AU-7S-1	2016-2017		FA726X*	SXR726HH*	FA726R*								22
CF 500 US U-Force	2015-2018	Left	FA135X		FA135R			FA135SV					23
		Right	FA165X		FA165R			FA165SV					24
CF 500 US-EX U-Force	2018-2020		FA726X*	SXR726HH*	FA726R*			FA726SV*					25
CF 500 US-EX Z-Force	2019	Left	FA135X		FA135R			FA135SV					26
		Right	FA165X		FA165R			FA165SV					27
CF 500 US-EX Z-Force	2018-2020		FA726X*	SXR726HH*	FA726R*			FA726SV*					28
CF 500 Z-Force	2014-2016	Left	FA135X		FA135R			FA135SV					29
		Right	FA165X		FA165R			FA165SV					30
CF 520 ATR-2L	2016-2020		FA453X*		FA453R*								31
CF 520 ATR-2L	2021-2022		FA726X*	SXR726HH*	FA726R*								32
CF 520 ATR-2S	2016-2020		FA453X*		FA453R*								33
CF 520 ATR-2S	2021-2022		FA726X*	SXR726HH*	FA726R*								34
CF 520 AU-7A, 7C	2016-2021		FA726X*	SXR726HH*	FA726R*			FA726SV*					35
CF 520 AU-7L	2016		FA726X*	SXR726HH*	FA726R*								36
CF 520 AU-7S-1	2016-2017		FA726X*	SXR726HH*	FA726R*								37
CF 520 AU-7SF, 7LF	2021-2022		FA726X*	SXR726HH*	FA726R*			FA726SV*					38
CF 520 AU-9S, 9L	2022-2023		FA726X*	SXR726HH*	FA726R*			FA726SV*					39
CF 550 UU U-Force	2015-2017	Left	FA135X		FA135R			FA135SV					40
		Right	FA165X		FA165R			FA165SV					41
CF 550 ATR-3	2016-2019		FA453X*		FA453R*								42
CF 550 ATR-A	2015-2016		FA453X*		FA453R*								43
CF 550 AU-6B	2016-2019		FA726X*	SXR726HH*	FA726R*			FA726SV*					44
CF 550 AU-6L	2014-2015		FA453X*		FA453R*								45
CF 550 AU-6L	2018-2019		FA453X*		FA453R*								46
CF 550 AU-6L	2018-2019		FA726X*	SXR726HH*	FA726R*								47
CF 550 US-EX Z-Force	2016-2020	Left	FA135X		FA135R			FA135SV					48
		Right	FA165X		FA165R			FA165SV					49
CF 550 US-EX Z-Force	2018-2020		FA726X*	SXR726HH*	FA726R*			FA726SV*					50
CF 550 UTR EX Z-Force	2017-2022		FA726X*	SXR726HH*	FA726R*			FA726SV*					51
CF 550 UTR-2 U-Force	2017-2020		FA726X*	SXR726HH*	FA726R*			FA726SV*					52
CF 600 5 U-Force	2011-2015	Left	FA135X		FA135R			FA135SV					53
		Right	FA165X		FA165R			FA165SV					54
CF 600 ATR-L T3b	2018-2020		FA726X*	SXR726HH*	FA726R*			FA726SV*					55
CF 600 AU-3L	2020		FA726X*	SXR726HH*	FA726R*			FA726SV*					56

FRONT

⚠ This symbol indicates a rotor made of billet steel, and should be only used with EBC FA Organic or Vee pads.
SAFETY NOTICE - With vehicles primarily designed for off highway use such as quads now being used on the highway, we would recommend the use of X or MXS pads for highway use and ONLY using the R and SV higher density / harder pad series for off road riding.

*-2 Sets Required. † For Vee disc colours add RED, BLU, GRN, GLD, ORG suffix to part number. **SAFETY WARNING:- DO NOT USE HH PADS ON REAR UNLESS ALSO USED ON FRONT TO AVOID BRAKE IMBALANCE**

FRONT: Non-Japanese Bikes Cont'd

REAR: Non-Japanese Bikes

Line #	BRAKE ROTOR CHOICES - FRONT					DISC PAD CHOICES - REAR					BRAKE ROTOR CHOICES - REAR					
	CX Extreme® /Vee-Rotor	OSX Series Oversize 280mm Rotor Kit	Relocating Bracket for Oversize Rotor	SMX Series Oversize 320mm Rotor Kit	Relocating Bracket for 320mm Rotor	Front Disc Bolt Kit	FA/SFA/X Pad or Brake Shoe	Specialty Pads SXR/ VEE/MXS Race	Sintered/ HH Pads/ Grooved Shoes	EPFA Sintered Fast Road/ Track Pads	SV Series Severe Duty Pads	Standard Rotor	Vintage Rotor / UTV Oversize Brake Kit	Contour Profile Rotor	CX Extreme® /Vee-Rotor	Rear Disc Bolt Kit
1							SFA343									
2							FA140		FA140HH							
3							FA140		FA140HH							
4							FA344X		FA344R							
5									FA747R*		FA747SV*					
6							FA344X		FA344R							
7							FA453X		FA453R							
8									FA747R*		FA747SV*					
9									FA747R*		FA747SV*					
10									FA747R*		FA747SV*					
11									FA747R*		FA747SV*					
12									FA747R*		FA747SV*					
13							FA140		FA140HH							
14									FA747R*		FA747SV*					
15									FA747R*		FA747SV*					
16									FA747R*		FA747SV*					
17							FA344X		FA344R							
18							FA344X		FA344R							
19																
20							FA344X		FA344R							
21							FA344X		FA344R							
22							FA344X		FA344R							
23							FA651X*		FA651R*		FA651SV*					
24																
25									FA747R*		FA747SV*					
26							FA651X*		FA651R*		FA651SV*					
27																
28									FA747R*		FA747SV*					
29							FA651X*		FA651R*		FA651SV*					
30																
31							FA344X		FA344R							
32							FA344X		FA344R							
33							FA344X		FA344R							
34							FA344X		FA344R							
35									FA747R*		FA747SV*					
36							FA344X		FA344R							
37							FA344X		FA344R							
38									FA747R*		FA747SV*					
39									FA747R*		FA747SV*					
40							FA67X*		FA67R*							
41																
42							FA344X		FA344R							
43							FA344X		FA344R							
44									FA747R*		FA747SV*					
45							FA317X		FA317R							
46							FA344X		FA344R							
47							FA344X		FA344R							
48							FA651X*		FA651R*		FA651SV*					
49																
50									FA747R*		FA747SV*					
51									FA747R*		FA747SV*					
52									FA747R*		FA747SV*					
53							FA344X		FA344R							
54																
55							FA344X		FA344R							
56									FA747R*		FA747SV*					

⚠ This symbol indicates a rotor made of billet steel, and should be only used with EBC FA Organic or Vee pads.
SAFETY NOTICE - With vehicles primarily designed for off highway use such as quads now being used on the highway, we would recommend the use of X or MXS pads for highway use and ONLY using the R and SV higher density / harder pad series for off road riding.

*-2 Sets Required. † For Vee disc colours add RED, BLU, GRN, GLD, ORG suffix to part number. **SAFETY WARNING:- DO NOT USE HH PADS ON REAR UNLESS ALSO USED ON FRONT TO AVOID BRAKE IMBALANCE**

FRONT: Non-Japanese Bikes Cont'd

REAR: Non-Japanese Bikes

Line #	BRAKE ROTOR CHOICES - FRONT					DISC PAD CHOICES - REAR					BRAKE ROTOR CHOICES - REAR					
	CX Extreme® /Vee-Rotor	OSX Series Oversize 280mm Rotor Kit	Relocating Bracket for Oversize Rotor	SMX Series Oversize 320mm Rotor Kit	Relocating Bracket for 320mm Rotor	Front Disc Bolt Kit	FA/SFA/X Pad or Brake Shoe	Specialty Pads SXR/ VEE/MXS Race	Sintered/ HH Pads/ Grooved Shoes	EPFA Sintered Fast Road/ Track Pads	SV Series Severe Duty Pads	Standard Rotor	Vintage Rotor / UTV Oversize Brake Kit	Contour Profile Rotor	CX Extreme® /Vee-Rotor	Rear Disc Bolt Kit
1							FA651X*			FA651R*						
2																
3																
4							FA651X*			FA747R*						
5										FA651R*						
6																
7										FA747R*						
8										FA747R*						
9										FA747R*						
10										FA747R*						
11							FA192			FA192HH						
12							FA209/2			FA209/2HH						
13							FA209/2			FA209/2HH						
14							FA67X*			FA67R*						
15																
16										FA747R*						
17							FA67X*			FA67R*						
18																
19							FA344X			FA344R						
20							FA344X			FA344R						
21										FA747R*						
22										FA747R*						
23										FA747R*						
24							FA651X*			FA651R*						
25																
26										FA747R*						
27										FA747R*						
28							FA209/2			FA209/2HH						
29							FA209/2			FA209/2HH						
30										FA747R*						
31										FA747R*						
32										FA747R*						
33										FA747R*						
34										FA747R*						
35										FA747R*						
36										FA747R*						
37										FA747R*						
38										FA747R*						
39																
40																
41							FA690X*			FA690R*						
42																
43							FA690X*			FA690R*						
44																
45							FA690X*			FA690R*						
46																
47							FA690X*			FA690R*						
48																
49							FA690X*			FA690R*						
50																
51							FA690X*			FA690R*						
52																
53																
54																
55																
56							FA115X			FA115R						

⚠ This symbol indicates a rotor made of billet steel, and should be only used with EBC FA Organic or Vee pads.
SAFETY NOTICE - With vehicles primarily designed for off highway use such as quads now being used on the highway, we would recommend the use of X or MXS pads for highway use and ONLY using the R and SV higher density / harder pad series for off road riding.

*-2 Sets Required. † For Vee disc colours add RED, BLU, GRN, GLD, ORG suffix to part number. **SAFETY WARNING:- DO NOT USE HH PADS ON REAR UNLESS ALSO USED ON FRONT TO AVOID BRAKE IMBALANCE**

FRONT: Non-Japanese Bikes

APPLICATIONS

BRAKE



CPI



GTR 50	2005-2009
GTR 50	2005-2009
Oliver City 50	2005-2009
GTR 125	2005-2009
GTR 125	2005-2009
GTR 150	2005-2009
GTR 150	2005-2009
Enduro 250	2007-2008

CSC

RX3 Cyclone 250	2015-2016
-----------------	-----------

CZ/JAWA

Scrambler Cross 125-380	1965-1976
Jawa Cross 250/400	1965-1976
Models 513/514 250/380	1977-1979

DAELIM

A-Four 50cc	2006-2008
Cordi 50	2001-2009
E-Five 50	2003-2009
S-Five 50	2001-2009
Delfino 100	2001-2009
Daystar 125	2003-2009
History 125	2001-2008
Roadwin 125	2004-2009
S2-125	2006-2009
S2-250	2006-2009
S1-125	2006-2009

DERBI

Atlantis 50	1999-2001
Atlantis Bullet/City	2002-2005
GPR 50 Nude	2004-2005
GPR 50 Replica	2003-2005
Predator	1999-2001
Senda R 50	2002-2005
Senda Supermoto	2004-2005
GPR 80 Cup	2005
GPR 125/Nude	2005-2006
Boulevard 150	2003-2005
GP 150	2002-2006

DINLI

Diamond Back 90	2006
DMX 270	2005-2006
DMX 450	2005-2006

DUCATI

250/350/450 Desmo/Single	1976
250/350/450 Desmo/Single	1974-1977
Monster 400	1995-1997
Monster 400	2000-2002
Monster 400	2000-2004
Monster 400	2003-2004
Monster 400	2005-2006

DISC PAD CHOICES - FRONT

BRAKE ROTOR CHOICES - FRONT

FA/SFA/X Pad or Brake Shoe	Specialty Pads SXR/VEE/MXS Race	Sintered/HH Pads/Grooved Shoes	EPFA Sintered Fast Road/Track Pads	GPFAX Sintered RACE ONLY Pads	SV Series Severe Duty Pads	Standard Rotor Left	Standard Rotor Right	Vintage Rotor / UTV Oversize Brake Kit	Contour Profile Rotor
SFA194		SFA194HH							
SFA266		SFA266HH							
SFA235									
SFA194		SFA194HH							
SFA266		SFA266HH							
SFA194		SFA194HH							
SFA266		SFA266HH							
FA115X		FA115R							
FA664									
950									
950									
SFA264		SFA264HH							
SFA54		SFA54HH							
SFA257									
SFA257									
SFA257									
FA196		FA196HH							
SFA54		SFA54HH							
FA196		FA196HH							
SFA142		SFA142HH							
SFA142		SFA142HH							
SFA661/4									
SFA115		SFA115HH				MD943D			
SFA115		SFA115HH				MD964D			
FA266		FA266HH							
FA167		FA167HH							
SFA115		SFA115HH				MD964D			
FA115X		FA115R							
FA115X		FA115R							
FA266		FA266HH							
FA399									
SFA350		SFA350HH				MD924D			
SFA115		SFA115HH				MD943D			
928									
FA18		FA18HH				MD634LS			
FA95		FA95HH	EPFA95HH			MD2003X			MD2003XC
FA244		FA244HH	EPFA244HH			MD614X			MD614XC
FA244		FA244HH	EPFA244HH			MD614X			MD614XC
FA244*		FA244HH*	EPFA244HH*			MD614X	MD614X		MD614XC*
FA244*		FA244HH*	EPFA244HH*			MD614X	MD614X		MD614XC*

FRONT

Line #
1
2
3
4
5
6
7
8
9
10
11
12
13
14
15
16
17
18
19
20
21
22
23
24
25
26
27
28
29
30
31
32
33
34
35
36
37
38
39
40
41
42
43
44
45
46
47
48
49
50
51
52
53
54
55
56

* This symbol indicates a rotor made of billet steel, and should be only used with EBC FA Organic or Vee pads.
 SAFETY NOTICE - With vehicles primarily designed for off highway use such as quads now being used on the highway, we would recommend the use of X or MXS pads for highway use and ONLY using the R and SV higher density / harder pad series for off road riding.

*-2 Sets Required. † For Vee disc colours add RED, BLU, GRN, GLD, ORG suffix to part number. **SAFETY WARNING:- DO NOT USE HH PADS ON REAR UNLESS ALSO USED ON FRONT TO AVOID BRAKE IMBALANCE**

FRONT: Non-Japanese Bikes Cont'd

REAR: Non-Japanese Bikes

Line #	BRAKE ROTOR CHOICES - FRONT					REAR	DISC PAD CHOICES - REAR					BRAKE ROTOR CHOICES - REAR				
	CX Extreme® /Vee-Rotor	OSX Series Oversize 280mm Rotor Kit	Relocating Bracket for Oversize Rotor	SMX Series Oversize 320mm Rotor Kit	Relocating Bracket for 320mm Rotor		Front Disc Bolt Kit	FA/SFA/X Pad or Brake Shoe	Specialty Pads SXR/ VEE/MXS Race	Sintered/ HH Pads/ Grooved Shoes	EPFA Sintered Fast Road/ Track Pads	SV Series Severe Duty Pads	Standard Rotor	Vintage Rotor / UTV Oversize Brake Kit	Contour Profile Rotor	CX Extreme® /Vee-Rotor
1							SFA260		SFA260HH							
2							SFA298		SFA298HH							
3							503									
4							SFA260		SFA260HH							
5							SFA298		SFA298HH							
6							SFA260		SFA260HH							
7							SFA298		SFA298HH							
8							FA115X		FA115R							
9																
10																
11							FA140									
12																
13																
14							950									
15							950									
16							950									
17																
18																
19																
20																
21																
22																
23																
24							824									
25							FA54X		FA54HH							
26							FA197		FA197HH			MD814				
27							SFA197		SFA197HH							
28							SFA197		SFA197HH							
29							SFA54		SFA54HH							
30																
31																
32							624									
33							816									
34							FA115		FA115HH							
35							FA115		FA115HH							
36							SFA115		SFA115HH			MD964D				
37							FA115X		FA115R							
38							FA115X		FA115R							
39							FA115		FA115HH							
40							FA115									
41							816									
42							624									
43																
44																
45							FA83X		FA83R							
46																
47																
48																
49																
50																
51							929									
52							921									
53	VR2003BLK						FA47		FA47HH			MD899				
54	VR614BLK						FA47		FA47HH			MD899				
55	VR614BLK						FA47		FA47HH			MD899				
56	VR614BLK†						FA47		FA47HH			MD899				
57	VR614BLK†						FA47		FA47HH			MD899				

⚠ This symbol indicates a rotor made of billet steel, and should be only used with EBC FA Organic or Vee pads.
SAFETY NOTICE - With vehicles primarily designed for off highway use such as quads now being used on the highway, we would recommend the use of X or MXS pads for highway use and ONLY using the R and SV higher density / harder pad series for off road riding.

*-2 Sets Required. † For Vee disc colours add RED, BLU, GRN, GLD, ORG suffix to part number. **SAFETY WARNING:- DO NOT USE HH PADS ON REAR UNLESS ALSO USED ON FRONT TO AVOID BRAKE IMBALANCE**

FRONT: Non-Japanese Bikes

APPLICATIONS

BRAKE



DUCATI



DISC PAD CHOICES - FRONT

BRAKE ROTOR CHOICES - FRONT

			DISC PAD CHOICES - FRONT					BRAKE ROTOR CHOICES - FRONT				Line #	
			FA/SFA/X Pad or Brake Shoe	Specialty Pads SXR/ VEE/MXS Race	Sintered/ HH Pads/ Grooved Shoes	EPFA Sintered Fast Road/Track Pads	GPFAX Sintered RACE ONLY Pads	SV Series Severe Duty Pads	Standard Rotor Left	Standard Rotor Right	Vintage Rotor / UTV Oversize Brake Kit		Contour Profile Rotor
Monster 400		2005	FA244		FA244HH	EPFA244HH			MD614X			MD614XC	1
Monster 400		2007-2008	FA181X*		FA181HH*				MD626X	MD626X		MD626XC*	2
Scrambler 400 Sixty 2		2016-2022	FA209/2	FA209/2V	FA209/2HH								3
Supersport 400		1993-1997	FA95		FA95HH	EPFA95HH			MD2003X			MD2003XC	4
Supersport 400		1993-1997	FA95*		FA95HH*	EPFA95HH*			MD2003X	MD2003X		MD2003XC*	5
500		1975	FA47*		FA47HH*								6
500 GTV Pantah		1977	FA47*		FA47HH*								7
500 Pantah		1979	FA47*		FA47HH*				MD657LS	MD657RS			8
500 Sport Desmo		1977	FA47*		FA47HH*								9
Supermono 549		1993-1995	FA95*		FA95HH*	EPFA95HH*							10
Monster 600		1993-1997	FA95*		FA95HH*	EPFA95HH*			MD2003X	MD2003X		MD2003XC*	11
Monster 600		1993-1999	FA95		FA95HH	EPFA95HH			MD2003X			MD2003XC	12
Monster 600		1998-1999	FA95		FA95HH	EPFA95HH			MD2003X			MD2003XC	13
Monster 600		1999	FA95		FA95HH	EPFA95HH			MD614X			MD614XC	14
Monster 600		2000-2001	FA244		FA244HH	EPFA244HH			MD614X			MD614XC	15
Pantah 600		1981	FA18*		FA18HH*				MD657LS	MD657RS			16
Supersport 600		1991-1997	FA95		FA95HH	EPFA95HH			MD2003X			MD2003XC	17
Monster 620		2003-2004	FA244		FA244HH	EPFA244HH			MD2003X			MD2003XC	18
Monster 620 IE		2002-2004	FA244*		FA244HH*	EPFA244HH*			MD614X	MD614X		MD614XC*	19
Monster 620 IE		2005	FA244*		FA244HH*	EPFA244HH*			MD614X	MD614X		MD614XC*	20
Monster 620 IE		2005-2006	FA181X*		FA181HH*				MD626X	MD626X		MD626XC*	21
Multistrada 620		2006	FA181X*		FA181HH*				MD626X	MD626X		MD626XC*	22
Multistrada 620		2006	FA244		FA244HH	EPFA244HH			MD2003X			MD2003XC*	23
Sport 620		2003	FA244*		FA244HH*	EPFA244HH*			MD614X	MD614X		MD614XC*	24
Pantah 650		1984	FA18*		FA18HH*								25
Monster 695		2006-2009	FA181X*		FA181HH*				MD626X	MD626X		MD626XC*	26
Monster 696		2008-2015	FA244*		FA244HH*	EPFA244HH*			MD614X	MD614X		MD614XC*	27
Monster 696 M 20th Anniversary Model		2013-2014	FA244*		FA244HH*	EPFA244HH*			MD614X	MD614X		MD614XC*	28
748		2000-2002	FA244*		FA244HH*	EPFA244HH*	GPFAX244HH*						29
748		2000-2002	FA244*		FA244HH*	EPFA244HH*	GPFAX244HH*						30
748 Biposto		1995-1998	FA95*		FA95HH*	EPFA95HH*			MD2003X	MD2003X		MD2003XC*	31
748 Biposto		1999-2002	FA244*		FA244HH*	EPFA244HH*	GPFAX244HH*		MD614X	MD614X		MD614XC*	32
748 R		2001-2002			FA322/4HH*	EPFA322/4HH*			MD636X	MD636X		MD636XC*	33
748 SP		1995-1997	FA95*		FA95HH*	EPFA95HH*			MD2003X	MD2003X		MD2003XC*	34
748 SP		1998	FA95*		FA95HH*	EPFA95HH*			MD2003X	MD2003X		MD2003XC*	35
748 SP/Monoposto		1999-2002	FA244*		FA244HH*	EPFA244HH*	GPFAX244HH*		MD614X	MD614X		MD614XC*	36
748 SPS		1998-1999	FA244*		FA244HH*	EPFA244HH*	GPFAX244HH*		MD633X	MD633X		MD633XC*	37
748 Testa Bassa		2001	FA244*		FA244HH*	EPFA244HH*	GPFAX244HH*		MD614X	MD614X		MD614XC*	38
749		2003-2006			FA322/4HH*	EPFA322/4HH*			MD622X	MD622X		MD622XC*	39
749		2004-2006			FA322/4HH*	EPFA322/4HH*			MD622X	MD622X		MD622XC*	40
749 R		2004-2006			FA322/4HH*	EPFA322/4HH*			MD622X	MD622X		MD622XC*	41
749 S		2003-2006			FA322/4HH*	EPFA322/4HH*			MD622X	MD622X		MD622XC*	42
750 Paso		1987-1990	FA18*		FA18HH*				MD630LS	MD630RS			43
750 Sport		1974	FA16		FA16HH	EPFA16HH			MD634LS				44
750 Sport		1988-1990	FA18*		FA18HH*				MD630LS	MD630RS			45
750 SS		1975-1976	FA18*		FA18HH*				MD634LS	MD634RS			46
750 Supersport		1991-1998	FA95*		FA95HH*	EPFA95HH*			MD2003X	MD2003X		MD2003XC*	47
750 Supersport		1991-1998	FA95		FA95HH	EPFA95HH			MD2003X			MD2003XC	48
750 Supersport		1999	FA244*		FA244HH*	EPFA244HH*			MD2003X	MD2003X		MD2003XC*	49
750 Supersport IE		2000-2002	FA244*		FA244HH*	EPFA244HH*			MD614X	MD614X		MD614XC*	50
Monster 750		2000-2001	FA244*		FA244HH*	EPFA244HH*			MD614X	MD614X		MD614XC*	51
Monster 750 City and City Dark		1999	FA95*		FA95HH*	EPFA95HH*			MD2003X	MD2003X		MD2003XC*	52
Monster 750 ie		2002	FA244*		FA244HH*	EPFA244HH*			MD614X	MD614X		MD614XC*	53
Monster 750 Monster Dark		1999	FA95*		FA95HH*	EPFA95HH*			MD2003X	MD2003X		MD2003XC*	54
Monster 750 Single disc		1996-1997	FA95		FA95HH	EPFA95HH			MD2003X			MD2003XC	55
Monster 750 Twin disc		1996-1998	FA95*		FA95HH*	EPFA95HH*			MD2003X	MD2003X		MD2003XC*	56

FRONT

* This symbol indicates a rotor made of billet steel, and should be only used with EBC FA Organic or Vee pads.
 SAFETY NOTICE - With vehicles primarily designed for off highway use such as quads now being used on the highway, we would recommend the use of X or MXS pads for highway use and ONLY using the R and SV higher density / harder pad series for off road riding.

*-2 Sets Required. † For Vee disc colours add RED, BLU, GRN, GLD, ORG suffix to part number. **SAFETY WARNING:- DO NOT USE HH PADS ON REAR UNLESS ALSO USED ON FRONT TO AVOID BRAKE IMBALANCE**

FRONT: Non-Japanese Bikes Cont'd

REAR: Non-Japanese Bikes

Line #	BRAKE ROTOR CHOICES - FRONT					REAR	DISC PAD CHOICES - REAR					BRAKE ROTOR CHOICES - REAR				
	CX Extreme® /Vee-Rotor	OSX Series Oversize 280mm Rotor Kit	Relocating Bracket for Oversize Rotor	SMX Series Oversize 320mm Rotor Kit	Relocating Bracket for 320mm Rotor		Front Disc Bolt Kit	FA/SFA/X Pad or Brake Shoe	Specialty Pads SXR/ VEE/MXS Race	Sintered/ HH Pads/ Grooved Shoes	EPFA Sintered Fast Road/ Track Pads	SV Series Severe Duty Pads	Standard Rotor	Vintage Rotor / UTV Oversize Brake Kit	Contour Profile Rotor	CX Extreme® /Vee-Rotor
1	VR614BLK†						FA47		FA47HH			MD899				
2	VR626BLK†						FA47		FA47HH			MD899				
3							FA213		FA213HH			MD899				
4	VR2003BLK						FA47		FA47HH			MD899				
5	VR2003BLK†						FA47		FA47HH			MD899				
6																
7							FA47		FA47HH							
8							FA47		FA47HH			MD657LS				
9							FA47		FA47HH							
10							FA115		FA115HH							
11	VR2003BLK†						FA47		FA47HH			MD899				
12	VR2003BLK†						FA47		FA47HH			MD899				
13	VR2003BLK†						FA47		FA47HH			MD899				
14	VR614BLK†						FA47		FA47HH			MD899				
15	VR614BLK†						FA47		FA47HH			MD899				
16							FA47		FA47HH			MD899				
17	VR2003BLK†						FA47		FA47HH			MD899				
18	VR2003BL†						FA47		FA47HH			MD899				
19	VR614BLK†						FA47		FA47HH			MD899				
20	VR614BLK†						FA47		FA47HH			MD899				
21	VR626BLK†						FA47		FA47HH			MD899				
22	VR626BLK†						FA47		FA47HH			MD899				
23	VR2003BLK						FA47		FA47HH							
24	VR614BLK†						FA266		FA266HH	EPFA266HH		MD899				
25							FA18		FA18HH							
26	VR626BLK†						FA47		FA47HH			MD899				
27	VR614BLK†						FA266		FA266HH	EPFA266HH		MD899				
28	VR614BLK†						FA266		FA266HH	EPFA266HH		MD899				
29							FA47		FA47HH			MD632		VR632		
30							FA47		FA47HH			MD632				
31	VR2003BLK†						FA47		FA47HH			MD632	MD632C	VR632		
32	VR614BLK†						FA47		FA47HH			MD632		VR632		
33							FA47		FA47HH			MD632	MD632C			
34							FA47		FA47HH			MD632	MD632C			
35	VR2003BLK†						FA47		FA47HH			MD632	MD632C	VR632		
36	VR614BLK†						FA47		FA47HH			MD899		VR632		
37							FA47		FA47HH			MD632	MD632C	VR632		
38	VR614BLK†						FA47		FA47HH			MD632	MD632C	VR632		
39	VR622BLK†						FA266		FA266HH	EPFA266HH		MD618	MD618C	VR618		
40	VR622BLK†						FA266		FA266HH	EPFA266HH		MD618	MD618C	VR618		
41	VR622BLK†						FA266		FA266HH	EPFA266HH		MD618	MD618C	VR618		
42	VR622BLK†						FA266		FA266HH	EPFA266HH		MD618	MD618C	VR618		
43							FA47		FA47HH			MD631				
44																
45							FA18		FA18HH			MD631				
46							FA18		FA18HH							
47	VR2003BLK†						FA47		FA47HH			MD899				
48	VR2003BLK†						FA47		FA47HH			MD899				
49	VR2003BLK†						FA266		FA266HH	EPFA266HH		MD899				
50	VR614BLK†						FA266		FA266HH	EPFA266HH		MD899				
51	VR614BLK†						FA47		FA47HH			MD899				
52	VR2003BLK†						FA47		FA47HH			MD899				
53	VR614BLK†						FA47		FA47HH			MD899				
54	VR2003BLK†						FA47		FA47HH			MD899				
55	VR2003BLK†						FA47		FA47HH			MD899				
56	VR2003BLK†						FA47		FA47HH			MD899				

BRAKE APPLICATIONS
 This symbol indicates a rotor made of billet steel, and should be only used with EBC FA Organic or Vee pads.
 SAFETY NOTICE - With vehicles primarily designed for off highway use such as quads now being used on the highway, we would recommend the use of X or MXS pads for highway use and ONLY using the R and SV higher density / harder pad series for off road riding.

*-2 Sets Required. † For Vee disc colours add RED, BLU, GRN, GLD, ORG suffix to part number. **SAFETY WARNING:- DO NOT USE HH PADS ON REAR UNLESS ALSO USED ON FRONT TO AVOID BRAKE IMBALANCE**

FRONT: Non-Japanese Bikes

APPLICATIONS
BRAKE



DUCATI



DISC PAD CHOICES - FRONT

BRAKE ROTOR CHOICES - FRONT

Model	Year	FA/SFA/X Pad or Brake Shoe	Specialty Pads SXR/ VEE/MXS Race	Sintered/ HH Pads/ Grooved Shoes	EPFA Sintered Fast Road/Track Pads	GPFAX Sintered RACE ONLY Pads	SV Series Severe Duty Pads	Standard Rotor		Vintage Rotor / UTV Oversize Brake Kit	Contour Profile Rotor	Line #
								Standard Rotor Left	Standard Rotor Right			
Sport 750	2001-2002	FA244*		FA244HH*	EPFA244HH*			MD614X	MD614X		MD614XC*	1
751 F1	1986	FA18*		FA18HH*								2
Hypermotard 796	2010-2012	FA244*		FA244HH*	EPFA244HH*			MD865X	MD865X		MD865XC*	3
Monster 800	2003-2004	FA244*		FA244HH*	EPFA244HH*			MD614X	MD614X		MD614XC*	4
Monster S2R	2005-2007	FA181X*		FA181HH*	EPFA181HH*			MD626X	MD626X		MD626XC*	5
Monster S2R Dark 803cc	2005-2006	FA181X*		FA181HH*	EPFA181HH*			MD626X	MD626X		MD626XC*	6
Sport 800	2003	FA244*		FA244HH*	EPFA244HH*			MD614X	MD614X		MD614XC*	7
Supersport 800	2003-2005	FA244*		FA244HH*	EPFA244HH*			MD614X	MD614X		MD614XC*	8
Monster 796	2010-2013	FA244*		FA244HH*	EPFA244HH*			MD841X	MD841X		MD841XC*	9
Monster 796	2010-2015	FA244*		FA244HH*	EPFA244HH*			MD841X	MD841X		MD841XC*	10
Monster 796 M	2013-2014	FA244*		FA244HH*	EPFA244HH*			MD841X	MD841X		MD841XC*	11
Monster 797 Plus	2017-2022			FA630HH*	EPFA630HH*			MD841X	MD841X		MD841XC*	12
Scrambler Café Racer	2017-2021			FA630HH	EPFA630HH			MD868X			MD868XC	13
Scrambler Classic	2015-2019			FA630HH	EPFA630HH			MD868X			MD868XC	14
Scrambler Desert Sled	2018-2023			FA630HH	EPFA630HH			MD868X			MD868XC	15
Scrambler Flat Track Pro	2016-2017			FA630HH	EPFA630HH			MD868X			MD868XC	16
Scrambler Full Throttle	2015-2024			FA630HH	EPFA630HH			MD868X			MD868XC	17
Scrambler Icon	2015-2024			FA630HH	EPFA630HH			MD868X			MD868XC	18
Scrambler Icon Dark	2020-2023			FA630HH	EPFA630HH			MD868X			MD868XC	19
Scrambler Nightshift	2020-2024			FA630HH	EPFA630HH			MD868X			MD868XC	20
Scrambler Urban Enduro	2015-2017			FA630HH	EPFA630HH			MD868X			MD868XC	21
Scrambler Urban Motard	2022-2023			FA630HH	EPFA630HH			MD868X			MD868XC	22
Hypermotard 821 SP	2013-2015			FA630HH*	EPFA630HH*			MD841X	MD841X		MD841XC*	23
Hyperstrada 821	2013-2015			FA630HH*	EPFA630HH*			MD841X	MD841X		MD841XC*	24
Monster 821	2015-2022			FA630HH*	EPFA630HH*			MD841X	MD841X		MD841XC*	25
Monster 821 Dark	2015-2020			FA630HH*	EPFA630HH*			MD841X	MD841X		MD841XC*	26
Monster 821 Stealth	2020-2022			FA630HH*	EPFA630HH*			MD841X	MD841X		MD841XC*	27
Monster 821 Stripe	2015-2017			FA630HH*	EPFA630HH*			MD841X	MD841X		MD841XC*	28
848	2008-2010	FA244*		FA244HH*	EPFA244HH*	GPFAX244HH*		MD843X	MD843X		MD843XC*	29
848 Evo	2010-2013			FA447HH*	EPFA447HH*	GPFAX447HH*		MD843X	MD843X		MD843XC*	30
848 Evo Corse Special Edition	2012-2013			FA447HH*	EPFA447HH*	GPFAX447HH*						31
848 Streetfighter	2012-2015	FA244*		FA244HH*	EPFA244HH*	GPFAX244HH*						32
851 Superbike Biposto	1989-1992	FA95*		FA95HH*	EPFA95HH*			MD2003X	MD2003X		MD2003XC*	33
860 GT/GTS	1975-1976	FA18*		FA18HH*				MD634LS	MD634RS			34
888 SP4/SP5	1992-1993	FA95*		FA95HH*	EPFA95HH*							35
888 Superbike Strada	1994-1995	FA95*		FA95HH*	EPFA95HH*			MD2003X	MD2003X		MD2003XC*	36
Panigale 899	2014-2015			FA630HH*	EPFA630HH*			MD843X	MD843X		MD843XC*	37
900 GTS	1975-1976	FA18*		FA18HH*				MD634LS	MD634RS			38
900 Hailwood Replica	1979	FA18*		FA18HH*				MD609LS	MD609RS			39
900 MH Evoluzione	2000-2001	FA244*		FA244HH*	EPFA244HH*			MD614X	MD614X		MD614XC*	40
900 SS - Darmah	1978	FA18*		FA18HH*				MD609LS	MD609RS			41
900 SS Darmah	1976-1977	FA18*		FA18HH*				MD634LS	MD634RS			42
Monster 900	1993-1999	FA95*		FA95HH*	EPFA95HH*			MD2003X	MD2003X		MD2003XC*	43
Monster 900 City/City Dark	1999	FA95*		FA95HH*	EPFA95HH*			MD2003X	MD2003X		MD2003XC*	44
Monster 900 Cromo/Special	1998	FA95*		FA95HH*	EPFA95HH*			MD2003X	MD2003X		MD2003XC*	45
Monster 900 IE	2000-2001	FA244*		FA244HH*	EPFA244HH*			MD614X	MD614X		MD614XC*	46
Sport 900	2002	FA244*		FA244HH*	EPFA244HH*			MD614X	MD614X		MD614XC*	47
Supersport 900	1989-1990	FA95*		FA95HH*	EPFA95HH*			MD2001X	MD2001X		MD2001XC*	48
Supersport 900	1998-1999	FA244*		FA244HH*	EPFA244HH*			MD2003X	MD2003X		MD2003XC*	49
Supersport 900 CR USA	1998	FA95*		FA95HH*	EPFA95HH*			MD2003X	MD2003X		MD2003XC*	50
Supersport 900 FE	1998	FA95*		FA95HH*	EPFA95HH*			MD2003X	MD2003X		MD2003XC*	51
Supersport 900 IE	2000-2001	FA244*		FA244HH*	EPFA244HH*			MD614X	MD614X		MD614XC*	52
Supersport 900 Superlight	1991-1997	FA95*		FA95HH*	EPFA95HH*			MD2003X	MD2003X		MD2003XC*	53
906 Paso	1988-1989	FA18*		FA18HH*								54
907 IE	1990-1991	FA95*		FA95HH*	EPFA95HH*			MD2001X	MD2001X		MD2001XC*	55
907 IE	1992-1993	FA95*		FA95HH*	EPFA95HH*			MD2003X	MD2003X		MD2003XC*	56

*-2 Sets Required. † For Vee disc colours add RED, BLU, GRN, GLD, ORG suffix to part number. **SAFETY WARNING:- DO NOT USE HH PADS ON REAR UNLESS ALSO USED ON FRONT TO AVOID BRAKE IMBALANCE**

Part numbers, prefixes, suffixes, photos and illustrations shown in this catalog are trademarks and/or copyrights of EBC Brakes or the trademark owner A C Freeman Investments Ltd and use without express written permission of the owners is punishable by law.

This symbol indicates a rotor made of billet steel, and should be only used with EBC FA Organic or Vee pads.
 SAFETY NOTICE - With vehicles primarily designed for off highway use such as quads now being used on the highway, we would recommend the use of X or MXS pads for highway use and ONLY using the R and SV higher density / harder pad series for off road riding.

FRONT: Non-Japanese Bikes Cont'd

REAR: Non-Japanese Bikes

Line #	BRAKE ROTOR CHOICES - FRONT					REAR	DISC PAD CHOICES - REAR					BRAKE ROTOR CHOICES - REAR				
	CX Extreme® /Vee-Rotor	OSX Series Oversize 280mm Rotor Kit	Relocating Bracket for Oversize Rotor	SMX Series Oversize 320mm Rotor Kit	Relocating Bracket for 320mm Rotor		Front Disc Bolt Kit	FA/SFA/X Pad or Brake Shoe	Specialty Pads SXR/ VEE/MXS Race	Sintered/ HH Pads/ Grooved Shoes	EPFA Sintered Fast Road/ Track Pads	SV Series Severe Duty Pads	Standard Rotor	Vintage Rotor / UTV Oversize Brake Kit	Contour Profile Rotor	CX Extreme® /Vee-Rotor
1	VR614BLK†						FA266		FA266HH	EPFA266HH		MD899				
2							FA18		FA18HH							
3							FA266		FA266HH	EPFA266HH		MD627		MD627C	VR627	
4	VR614BLK†						FA47		FA47HH			MD899				
5	VR626BLK†						FA47		FA47HH			MD627		MD627C	VR627	
6	VR626BLK†						FA47		FA47HH			MD627		MD627C	VR627	
7	VR614BLK†						FA47		FA47HH			MD899				
8	VR614BLK†						FA266		FA266HH	EPFA266HH		MD899				
9	VR841BLK†						FA266		FA266HH	EPFA266HH		MD627		MD627C	VR627	
10	VR841BLK†						FA266		FA266HH	EPFA266HH		MD878		MD878C	VR878	
11	VR841BLK†						FA266		FA266HH	EPFA266HH		MD627		MD627C	VR627	
12	VR841BLK†						FA213		FA213HH			MD899				
13							FA213		FA213HH			MD899				
14							FA213		FA213HH			MD899				
15							FA213		FA213HH			MD899				
16							FA213		FA213HH			MD899				
17							FA213		FA213HH			MD899				
18							FA213		FA213HH			MD899				
19							FA213		FA213HH			MD899				
20							FA213		FA213HH			MD899				
21							FA213		FA213HH			MD899				
22							FA213		FA213HH			MD899				
23	VR841BLK†								FA266HH	EPFA266HH		MD627				
24	VR841BLK†								FA266HH	EPFA266HH		MD627				
25	VR841BLK†								FA266HH	EPFA266HH		MD899				
26	VR841BLK†								FA266HH	EPFA266HH		MD899				
27	VR841BLK†								FA266HH	EPFA266HH		MD899				
28	VR841BLK†								FA266HH	EPFA266HH		MD899				
29	VR843BLK†						FA266		FA266HH	EPFA266HH		MD627		MD2002C	VR627	
30	VR843BLK†						FA266		FA266HH	EPFA266HH		MD627		MD627C	VR627	
31							FA266		FA266HH	EPFA266HH		MD695		MD695C	VR695	
32							FA266		FA266HH	EPFA266HH		MD627				
33	VR2003BLK†						FA47		FA47HH			MD899				
34							FA18		FA18HH			MD634LS				
35							FA47		FA47HH			MD899		MD2002C		
36	VR2003BLK†						FA47		FA47HH			MD899				
37	VR843BLK†						FA266		FA266HH	EPFA266HH		MD899				
38							FA18		FA18HH			MD634LS				
39							FA18		FA18HH			MD609LS				
40	VR614BLK†						FA266		FA266HH	EPFA266HH		MD632		MD632C	VR632	
41							FA18		FA18HH			MD634LS				
42							FA18		FA18HH			MD634LS				
43	VR2003BLK†						FA47		FA47HH			MD899				
44	VR2003BLK†						FA47		FA47HH			MD899				
45	VR2003BLK†						FA47		FA47HH			MD899				
46	VR614BLK†						FA47		FA47HH			MD899				
47	VR614BLK†						FA266		FA266HH	EPFA266HH		MD899				
48	VR2001BLK†						FA47		FA47HH			MD899				
49	VR2003BLK†						FA266		FA266HH	EPFA266HH		MD899				
50	VR2003BLK†						FA47		FA47HH			MD899				
51	VR2003BLK†						FA47		FA47HH			MD899				
52	VR614BLK†						FA266		FA266HH	EPFA266HH		MD899				
53	VR2003BLK†						FA47		FA47HH			MD899				
54							FA18		FA18HH			MD631				
55	VR2001BLK†						FA47		FA47HH			MD899				
56	VR2003BLK†						FA47		FA47HH			MD899				

BRAKE APPLICATIONS
 This symbol indicates a rotor made of billet steel, and should be only used with EBC FA Organic or Vee pads.
 SAFETY NOTICE - With vehicles primarily designed for off highway use such as quads now being used on the highway, we would recommend the use of X or MXS pads for highway use and ONLY using the R and SV higher density / harder pad series for off road riding.

*-2 Sets Required. † For Vee disc colours add RED, BLU, GRN, GLD, ORG suffix to part number. **SAFETY WARNING:- DO NOT USE HH PADS ON REAR UNLESS ALSO USED ON FRONT TO AVOID BRAKE IMBALANCE**

FRONT: Non-Japanese Bikes

APPLICATIONS
BRAKE



DUCATI



DISC PAD CHOICES - FRONT

BRAKE ROTOR CHOICES - FRONT

Model	Year	FA/SFA/X Pad or Brake Shoe	Specialty Pads SXR/VEE/MXS Race	Sintered/HH Pads/Grooved Shoes	EPFA Sintered Fast Road/Track Pads	GPFAX Sintered RACE ONLY Pads	SV Series Severe Duty Pads	Standard Rotor		Vintage Rotor / UTV Oversize Brake Kit	Contour Profile Rotor	Line #
								Standard Rotor Left	Standard Rotor Right			
916 Biposto	1994-1996	FA95*		FA95HH*	EPFA95HH*			MD2003X	MD2003X		MD2003XC*	1
916 Sienna	1994-1998	FA95*		FA95HH*	EPFA95HH*							2
916 SPS 996cc	1997-1998	FA244*		FA244HH*	EPFA244HH*	GPFAX244HH*						3
Monster S4 916cc	2001-2002	FA244*		FA244HH*	EPFA244HH*			MD624	MD624			4
Monster S4 Foggy 916cc	2002	FA244*		FA244HH*	EPFA244HH*			MD624	MD624			5
ST4 916cc	1999	FA244*		FA244HH*	EPFA244HH*			MD2003X	MD2003X		MD2003XC*	6
ST4 916cc	2001-2002	FA244*		FA244HH*	EPFA244HH*			MD614X	MD614X		MD614XC*	7
Desert X 937	2022-2024			FA447HH*	EPFA447HH*			MD841X	MD841X		MD841XC*	8
Hyperstrada	2016			FA630HH*	EPFA630HH*			MD841X	MD841X		MD841XC*	9
Monster Plus	2021-2024			FA630HH*	EPFA630HH*			MD841X	MD841X			10
Monster 30th Anniversary Edition	2023-2024			FA447HH*	EPFA447HH*			TBC	TBC			11
Monster R R	2021-2023			FA630HH*	EPFA630HH*			MD841X	MD841X			12
Monster SP SP	2023			FA447HH*	EPFA447HH*			TBC	TBC			13
Multistrada V2	2021-2023			FA630HH*	EPFA630HH*			MD841X	MD841X		MD841XC*	14
Multistrada V2 S	2021-2023			FA630HH*	EPFA630HH*			MD841X	MD841X		MD841XC*	15
ST2	1997-1999	FA244*		FA244HH*	EPFA244HH*			MD2003X	MD2003X		MD2003XC*	16
ST2	2000-2003	FA244*		FA244HH*	EPFA244HH*			MD614X	MD614X		MD614XC*	17
Hypermotard 950	2016-2023			FA630HH*	EPFA630HH*			MD841X	MD841X		MD841XC*	18
Hypermotard 950 RVE	2021-2023			FA630HH*	EPFA630HH*			MD841X	MD841X		MD841XC*	19
Hypermotard 950 SP	2016-2023			FA447HH*	EPFA447HH*	GPFAX447HH*						20
Multistrada 950	2017-2021			FA630HH*	EPFA630HH*			MD841X	MD841X		MD841XC*	21
Multistrada 950 S	2020-2021			FA630HH*	EPFA630HH*			MD841X	MD841X		MD841XC*	22
Multistrada 950 S Touring	2020-2021			FA630HH*	EPFA630HH*			MD841X	MD841X		MD841XC*	23
Supersport 950	2017-2023			FA630HH*	EPFA630HH*			MD841X	MD841X		MD841XC*	24
Supersport 950 S	2017-2024			FA630HH*	EPFA630HH*			MD841X	MD841X		MD841XC*	25
Panigale 955 V2	2019-2024			FA630HH*	EPFA630HH*	GPFAX630HH*		MD843X	MD843X		MD843XC*	26
Panigale 955 V2 Bayliss 1ST Champion	2022-2023			FA630HH*	EPFA630HH*	GPFAX630HH*		MD843X	MD843X		MD843XC*	27
Streetfighter 955 V2	2022-2023			FA630HH*	EPFA630HH*			MD843X	MD843X		MD843XC*	28
959 Panigale ABS	2016-2019			FA630HH*	EPFA630HH*			MD843X	MD843X		MD843XC*	29
959 Panigale S Corse	2018-2019			FA630HH*	EPFA630HH*			MD843X	MD843X		MD843XC*	30
Desmosedici RR D16RR/989cc	2008			FA447HH*	EPFA447HH*	GPFAX447HH*		MD694X	MD694X		MD694XC*	31
ST3 S 992cc	2006-2007	FA244*		FA244HH*	EPFA244HH*			MD624	MD624			32
996	1999-2001	FA244*		FA244HH*	EPFA244HH*	GPFAX244HH*		MD624	MD624			33
996 R	2001			FA322/4HH*	EPFA322/4HH*			MD636X	MD636X		MD636XC*	34
996 S	2001	FA244*		FA244HH*	EPFA244HH*			MD624	MD624			35
996 SPS	1999	FA244*		FA244HH*	EPFA244HH*	GPFAX244HH*		MD624	MD624			36
Monster S4R 996cc	2003-2006	FA244*		FA244HH*	EPFA244HH*			MD624	MD624			37
Monster S4R S 996cc	2006			FA322/4HH*	EPFA322/4HH*			MD843X	MD843X		MD843XC*	38
ST4S 996cc	2001-2005	FA244*		FA244HH*	EPFA244HH*			MD624	MD624			39
ST4S 996cc	2003-2005	FA244*		FA244HH*	EPFA244HH*			MD624	MD624			40
998 Matrix	2004			FA322/4HH*	EPFA322/4HH*			MD633X	MD633X		MD633XC*	41
998 Monoposto/Biposto	2002-2003	FA244*		FA244HH*	EPFA244HH*	GPFAX244HH*		MD633X	MD633X		MD633XC*	42
998 Panigale V4 Superleggera	2021-2022			FA447HH*	EPFA447HH*	GPFAX447HH*						43
998 R	2002			FA322/4HH*	EPFA322/4HH*							44
998 S	2002-2004			FA322/4HH*	EPFA322/4HH*			MD633X	MD633X		MD633XC*	45
998 S Bayliss/Bostrom	2002			FA322/4HH*	EPFA322/4HH*			MD633X	MD633X		MD633XC*	46
Panigale V4 R	2022-2024			FA447HH*	EPFA447HH*	GPFAX447HH*		MD694X	MD694X		MD694XC*	47
Panigale V4 Superleggera	2023			FA447HH*	EPFA447HH*	GPFAX447HH*		MD694X	MD694X		MD694XC*	48
999	2003-2006			FA322/4HH*	EPFA322/4HH*			MD622X	MD622X		MD622XC*	49
999 R	2003-2006			FA322/4HH*	EPFA322/4HH*			MD622X	MD622X		MD622XC*	50
999 R Fila	2003			FA322/4HH*	EPFA322/4HH*			MD622X	MD622X		MD622XC*	51
999 R Xerox	2006			FA322/4HH*	EPFA322/4HH*			MD622X	MD622X		MD622XC*	52
999 S Monoposto/Biposto	2003-2004			FA322/4HH*	EPFA322/4HH*			MD622X	MD622X		MD622XC*	53
999 S Monoposto/Biposto	2005-2006			FA322/4HH*	EPFA322/4HH*			MD622X	MD622X		MD622XC*	54
1000 R1 Hailwood Replica	1984	FA18*		FA18HH*				MD609LS	MD609RS			55
GT 1000	2007-2010	FA209/2*		FA209/2HH*				MD614X	MD614X		MD614XC*	56

FRONT

* This symbol indicates a rotor made of billet steel, and should be only used with EBC FA Organic or Vee pads.
 SAFETY NOTICE - With vehicles primarily designed for off highway use such as quads now being used on the highway, we would recommend the use of X or MXS pads for highway use and ONLY using the R and SV higher density / harder pad series for off road riding.

*-2 Sets Required. † For Vee disc colours add RED, BLU, GRN, GLD, ORG suffix to part number. **SAFETY WARNING:- DO NOT USE HH PADS ON REAR UNLESS ALSO USED ON FRONT TO AVOID BRAKE IMBALANCE**

FRONT: Non-Japanese Bikes Cont'd

REAR: Non-Japanese Bikes

Line #	BRAKE ROTOR CHOICES - FRONT					REAR	DISC PAD CHOICES - REAR					BRAKE ROTOR CHOICES - REAR				
	CX Extreme® /Vee-Rotor	OSX Series Oversize 280mm Rotor Kit	Relocating Bracket for Oversize Rotor	SMX Series Oversize 320mm Rotor Kit	Relocating Bracket for 320mm Rotor		Front Disc Bolt Kit	FA/SFA/X Pad or Brake Shoe	Specialty Pads SXR/ VEE/MXS Race	Sintered/ HH Pads/ Grooved Shoes	EPFA Sintered Fast Road/ Track Pads	SV Series Severe Duty Pads	Standard Rotor	Vintage Rotor / UTV Oversize Brake Kit	Contour Profile Rotor	CX Extreme® /Vee-Rotor
1	VR2003BLK†						FA47		FA47HH			MD632		MD632C	VR632	
2							FA47		FA47HH			MD632		MD632C	VR632	
3							FA47		FA47HH			MD632		MD632C	VR632	
4	VR624BLK†						FA47		FA47HH			MD899				
5	VR624BLK†						FA47		FA47HH			MD899				
6	VR2003BLK†						FA266		FA266HH	EPFA266HH		MD899				
7	VR614BLK†						FA47		FA47HH			MD899				
8							FA181X		FA181HH			MD879				
9	VR841BLK†							FA266HH	EPFA266HH			MD627		MD627C	VR627	
10								FA266HH				TBC				
11								FA266HH				TBC				
12								FA266HH				TBC				
13								FA266HH				TBC				
14							FA181X		FA181HH			MD879				
15							FA181X		FA181HH			MD879				
16	VR2003BLK†						FA266		FA266HH	EPFA266HH		MD899				
17	VR614BLK†						FA266		FA266HH	EPFA266HH		MD899				
18	VR841BLK†							FA266HH	EPFA266HH			MD878		MD878C	VR878	
19	VR841BLK†							FA266HH	EPFA266HH			MD878		MD878C	VR878	
20								FA266HH	EPFA266HH			MD878		MD878C	VR878	
21	VR841BLK†						FA181X		FA181HH			MD879				
22							FA181X		FA181HH			MD879				
23							FA181X		FA181HH			MD879				
24	VR841BLK†						FA266		FA266HH	EPFA266HH				MD880C	VR880	
25	VR841BLK†						FA266		FA266HH	EPFA266HH				MD880C	VR880	
26	VR843BLK†							FA266HH	EPFA266HH			MD880		MD880C		
27	VR843BLK†							FA266HH	EPFA266HH			MD880		MD880C		
28	VR843BLK†							FA266HH	EPFA266HH			MD880		MD880C		
29	VR843BLK†							FA266HH	EPFA266HH			MD880		MD880C		
30	VR843BLK†							FA266HH	EPFA266HH			MD880		MD880C	VR880	
31	VR694BLK†						FA266		FA266HH	EPFA266HH		MD618		MD618C	VR618	
32	VR624BLK†						FA266		FA266HH	EPFA266HH		MD899				
33	VR624BLK†						FA47		FA47HH			MD632		MD632C	VR632	
34							FA47		FA47HH			MD632		MD632C	VR632	
35	VR624BLK†						FA47		FA47HH			MD632		MD632C	VR632	
36	VR624BLK†						FA47		FA47HH			MD632		MD632C	VR632	
37	VR624BLK†						FA47		FA47HH			MD627			VR627	
38	VR843BLK†						FA47		FA47HH			MD627		MD627C	VR627	
39	VR624BLK†						FA266		FA266HH	EPFA266HH		MD899				
40	VR624BLK†						FA266		FA266HH	EPFA266HH		MD899				
41							FA47		FA47HH			MD632		MD632C	VR632	
42							FA47		FA47HH			MD632		MD632C	VR632	
43							FA266		FA266HH	EPFA266HH		MD880		MD880C	VR880	
44							FA47		FA47HH			MD632		MD632C	VR632	
45							FA47		FA47HH			MD632		MD632C	VR632	
46							FA47		FA47HH			MD632		MD632C	VR632	
47								FA266HH	EPFA266HH			MD880		MD880C	VR880	
48								FA266HH	EPFA266HH			MD880		MD880C	VR880	
49	VR622BLK†						FA266		FA266HH	EPFA266HH		MD618		MD618C	VR618	
50	VR622BLK†						FA266		FA266HH	EPFA266HH		MD618		MD618C	VR618	
51	VR622BLK†						FA266		FA266HH	EPFA266HH		MD618		MD618C	VR618	
52	VR622BLK†						FA266		FA266HH	EPFA266HH		MD618		MD618C	VR618	
53	VR622BLK†						FA266		FA266HH	EPFA266HH		MD618		MD618C	VR618	
54	VR622BLK†						FA266		FA266HH	EPFA266HH		MD618		MD618C	VR618	
55							FA18		FA18HH			MD609LS				
56	VR614BLK†						FA213		FA213HH			MD899				

BRAKE APPLICATIONS
⚠ This symbol indicates a rotor made of billet steel, and should be only used with EBC FA Organic or Vee pads.
SAFETY NOTICE - With vehicles primarily designed for off highway use such as quads now being used on the highway, we would recommend the use of X or MXS pads for highway use and ONLY using the R and SV higher density / harder pad series for off road riding.

*-2 Sets Required. † For Vee disc colours add RED, BLU, GRN, GLD, ORG suffix to part number. **SAFETY WARNING:- DO NOT USE HH PADS ON REAR UNLESS ALSO USED ON FRONT TO AVOID BRAKE IMBALANCE**

FRONT: Non-Japanese Bikes

APPLICATIONS

BRAKE



DUCATI



DISC PAD CHOICES - FRONT

BRAKE ROTOR CHOICES - FRONT

Model	Year	FA/SFA/X Pad or Brake Shoe	Specialty Pads SXR/ VEE/MXS Race	Sintered/ HH Pads/ Grooved Shoes	EPFA Sintered Fast Road/Track Pads	GPFAX Sintered RACE ONLY Pads	SV Series Severe Duty Pads	Standard Rotor		Vintage Rotor / UTV Oversize Brake Kit	Contour Profile Rotor	Line #
								Standard Rotor Left	Standard Rotor Right			
GT 1000 Touring - Sport Classic	2009	FA209/2*		FA209/2HH*				MD614X	MD614X		MD614XC*	1
Monster 1000 Dark	2003	FA244*		FA244HH*	EPFA244HH*			MD614X	MD614X		MD614XC*	2
Monster 1000 ie	2004-2005	FA244*		FA244HH*	EPFA244HH*			MD614X	MD614X		MD614XC*	3
Monster 1000 S ie	2003-2005	FA244*		FA244HH*	EPFA244HH*			MD614X	MD614X		MD614XC*	4
Monster 1000 S2R	2006-2008	FA244*		FA244HH*	EPFA244HH*			MD614X	MD614X		MD614XC*	5
Multistrada 1000 DS	2003-2005	FA244*		FA244HH*	EPFA244HH*			MD682	MD682			6
Multistrada 1000 S DS	2005-2006	FA244*		FA244HH*	EPFA244HH*			MD682	MD682			7
Paul Smart 1000 LE	2006	FA209/2*		FA209/2HH*				MD614X	MD614X		MD614XC*	8
S4R Monster 996cc	2005-2006	FA244*		FA244HH*	EPFA244HH*			MD624	MD624			9
S4R Testastretta Monster 998cc	2007-2008			FA322/4HH*	EPFA322/4HH*			MD843X	MD843X		MD843XC*	10
S4RS Testastretta Monster 998cc	2007			FA322/4HH*	EPFA322/4HH*			MD843X	MD843X		MD843XC*	11
S4RS Tricolore/Monster Testastretta 998cc	2008			FA322/4HH*	EPFA322/4HH*			MD843X	MD843X		MD843XC*	12
Sport 1000 S	2007-2009	FA244*		FA244HH*	EPFA244HH*			MD614X	MD614X		MD614XC*	13
Sport Classic 1000	2006-2008	FA209/2*		FA209/2HH*				MD614X	MD614X		MD614XC*	14
Supersport 1000 DS	2003-2006	FA244*		FA244HH*	EPFA244HH*			MD614X	MD614X		MD614XC*	15
1098	2007-2008			FA447HH*	EPFA447HH*	GPFAX447HH*		MD694X	MD694X		MD694XC*	16
1098 R	2008-2009			FA447HH*	EPFA447HH*	GPFAX447HH*						17
1098 S	2007-2008			FA447HH*	EPFA447HH*	GPFAX447HH*		MD694X	MD694X		MD694XC*	18
1098 S Tricolore	2007			FA447HH*	EPFA447HH*	GPFAX447HH*		MD694X	MD694X		MD694XC*	19
Streetfighter 1099	2009-2012			FA447HH*	EPFA447HH*			MD694X	MD694X		MD694XC*	20
Streetfighter 1099 S	2009-2012			FA447HH*	EPFA447HH*			MD694X	MD694X		MD694XC*	21
Hypermotard 1100	2007-2009	FA244*		FA244HH*	EPFA244HH*			MD865X	MD865X		MD865XC*	22
Hypermotard 1100 Evo	2010-2012			FA447HH*	EPFA447HH*			MD865X	MD865X		MD865XC*	23
Hypermotard 1100 Evo SP	2010-2013			FA447HH*	EPFA447HH*			MD865X	MD865X		MD865XC*	24
Hypermotard 1100 S	2007-2009			FA447HH*	EPFA447HH*			MD865X	MD865X		MD865XC*	25
Monster 1100	2009-2010	FA244*		FA244HH*	EPFA244HH*			MD843X	MD843X		MD843XC*	26
Monster 1100	2012	FA244*		FA244HH*	EPFA244HH*			MD843X	MD843X		MD843XC*	27
Monster 1100 Diesel	2013-2014	FA244*		FA244HH*	EPFA244HH*			MD843X	MD843X		MD843XC*	28
Monster 1100 Evo	2012-2014	FA244*		FA244HH*	EPFA244HH*			MD843X	MD843X		MD843XC*	29
Monster 1100 M Evo	2013-2014	FA244*		FA244HH*	EPFA244HH*			MD843X	MD843X		MD843XC*	30
Monster 1100 S	2009-2010	FA244*		FA244HH*	EPFA244HH*			MD843X	MD843X		MD843XC*	31
Monster 1100 S	2012	FA244*		FA244HH*	EPFA244HH*			MD843X	MD843X		MD843XC*	32
Multistrada 1100	2007-2009	FA244*		FA244HH*	EPFA244HH*			MD682	MD682			33
Multistrada 1100 S	2007-2009	FA244*		FA244HH*	EPFA244HH*			MD682	MD682			34
Panigale V4	2018-2023			FA447HH*	EPFA447HH*	GPFAX447HH*		MD694X	MD694X		MD694XC*	35
Panigale V4 S	2018-2023			FA447HH*	EPFA447HH*	GPFAX447HH*		MD694X	MD694X		MD694XC*	36
Panigale V4 SP	2021-2022			FA447HH*	EPFA447HH*	GPFAX447HH*		MD694X	MD694X		MD694XC*	37
Panigale V4 SP2	2023			FA447HH*	EPFA447HH*	GPFAX447HH*		MD694X	MD694X		MD694XC*	38
Scrambler 1100	2018-2021			FA630HH*	EPFA630HH*			MD841X	MD841X		MD841XC*	39
Scrambler 1100 Dark Pro	2022-2023			FA630HH*	EPFA630HH*			MD841X	MD841X		MD841XC*	40
Scrambler 1100 Pro	2020-2022			FA630HH*	EPFA630HH*			MD841X	MD841X		MD841XC*	41
Scrambler 1100 Special	2018-2021			FA630HH*	EPFA630HH*			MD841X	MD841X		MD841XC*	42
Scrambler 1100 Sport	2018-2021			FA630HH*	EPFA630HH*			MD841X	MD841X		MD841XC*	43
Scrambler 1100 Sport Pro	2020-2023			FA630HH*	EPFA630HH*			MD841X	MD841X		MD841XC*	44
Scrambler 1100 Tribute Pro	2022-2023			FA630HH*	EPFA630HH*			MD841X	MD841X		MD841XC*	45
Streetfighter V4	2020-2024			FA447HH*	EPFA447HH*			MD694X	MD694X		MD694XC*	46
Streetfighter V4 Lamborghini	2023			FA447HH*	EPFA447HH*			MD694X	MD694X		MD694XC*	47
Streetfighter V4 S	2020-2023			FA447HH*	EPFA447HH*			MD694X	MD694X		MD694XC*	48
Streetfighter V4 SP2	2023-2024			FA447HH*	EPFA447HH*			MD694X	MD694X		MD694XC*	49
Diavel V4	2023-2024			FA447HH*	EPFA447HH*							50
Multistrada V4	2021-2023			FA630HH*	EPFA630HH*			MD841X	MD841X		MD841XC*	51
Multistrada V4 Pikes Peak	2021-2023			FA447HH*	EPFA447HH*			MD841X	MD841X		MD841XC*	52
Multistrada V4 Rally	2023-2024			FA447HH*	EPFA447HH*			MD841X	MD841X		MD841XC*	53
Multistrada V4 S	2021-2024			FA447HH*	EPFA447HH*			MD841X	MD841X		MD841XC*	54
Multistrada V4 Sport	2021-2022			FA630HH*	EPFA630HH*			MD841X	MD841X		MD841XC*	55
1198	2009-2012			FA447HH*	EPFA447HH*			MD694X	MD694X		MD694XC*	56

FRONT

⚠ This symbol indicates a rotor made of billet steel, and should be only used with EBC FA Organic or Vee pads.
SAFETY NOTICE - With vehicles primarily designed for off highway use such as quads now being used on the highway, we would recommend the use of X or MXS pads for highway use and ONLY using the R and SV higher density / harder pad series for off road riding.

*-2 Sets Required. † For Vee disc colours add RED, BLU, GRN, GLD, ORG suffix to part number. **SAFETY WARNING:- DO NOT USE HH PADS ON REAR UNLESS ALSO USED ON FRONT TO AVOID BRAKE IMBALANCE**

FRONT: Non-Japanese Bikes Cont'd

REAR: Non-Japanese Bikes

Line #	BRAKE ROTOR CHOICES - FRONT					REAR	DISC PAD CHOICES - REAR					BRAKE ROTOR CHOICES - REAR				
	CX Extreme® /Vee-Rotor	OSX Series Oversize 280mm Rotor Kit	Relocating Bracket for Oversize Rotor	SMX Series Oversize 320mm Rotor Kit	Relocating Bracket for 320mm Rotor		Front Disc Bolt Kit	FA/SFA/X Pad or Brake Shoe	Specialty Pads SXR/ VEE/MXS Race	Sintered/ HH Pads/ Grooved Shoes	EPFA Sintered Fast Road/ Track Pads	SV Series Severe Duty Pads	Standard Rotor	Vintage Rotor / UTV Oversize Brake Kit	Contour Profile Rotor	CX Extreme® /Vee-Rotor
1	VR614BLK*†						FA213		FA213HH			MD899				
2	VR614BLK*†						FA47		FA47HH			MD899				
3	VR614BLK*†						FA47		FA47HH			MD899				
4	VR614BLK*†						FA47		FA47HH			MD899				
5	VR614BLK*†						FA47		FA47HH			MD627				
6							FA266		FA266HH	EPFA266HH		MD627				
7							FA266		FA266HH	EPFA266HH		MD627				
8	VR614BLK*†						FA213		FA213HH			MD899				
9	VR624BLK*†						FA47		FA47HH			MD627				
10	VR843BLK*†						FA47		FA47HH			MD627		MD627C	VR627	
11	VR843BLK*†						FA47		FA47HH			MD627		MD627C	VR627	
12							FA47		FA47HH			MD627		MD627C	VR627	
13	VR614BLK*†						FA213		FA213HH			MD899				
14	VR614BLK*†						FA213		FA213HH			MD899				
15	VR614BLK*†						FA266		FA266HH	EPFA266HH		MD899				
16	VR694BLK*†						FA266		FA266HH	EPFA266HH		MD695		MD695C	VR695	
17							FA266		FA266HH	EPFA266HH		MD695		MD695C	VR695	
18	VR694BLK*†						FA266		FA266HH	EPFA266HH		MD695		MD695C	VR695	
19	VR694BLK*†						FA266		FA266HH	EPFA266HH		MD695		MD695C	VR695	
20	VR694BLK*†						FA266		FA266HH	EPFA266HH		MD695		MD695C	VR695	
21	VR694BLK*†						FA266		FA266HH	EPFA266HH		MD695		MD695C	VR695	
22							FA266		FA266HH	EPFA266HH		MD627		MD627C	VR627	
23							FA266		FA266HH	EPFA266HH		MD627		MD627C	VR627	
24							FA266		FA266HH	EPFA266HH		MD627		MD627C	VR627	
25							FA266		FA266HH	EPFA266HH		MD627		MD627C	VR627	
26	VR843BLK*†						FA266		FA266HH	EPFA266HH		MD627		MD627C	VR627	
27	VR843BLK*†						FA266		FA266HH	EPFA266HH						
28	VR843BLK*†						FA266		FA266HH	EPFA266HH						
29	VR843BLK*†						FA266		FA266HH	EPFA266HH						
30	VR843BLK*†						FA266		FA266HH	EPFA266HH						
31	VR843BLK*†						FA266		FA266HH	EPFA266HH		MD627		MD627C	VR627	
32	VR843BLK*†						FA266		FA266HH	EPFA266HH						
33							FA266		FA266HH	EPFA266HH		MD627				
34							FA266		FA266HH	EPFA266HH		MD627				
35									FA266HH	EPFA266HH		MD880		MD880C	VR880	
36									FA266HH	EPFA266HH		MD880		MD880C	VR880	
37									FA266HH	EPFA266HH		MD880		MD880C	VR880	
38									FA266HH	EPFA266HH		MD880		MD880C	VR880	
39							FA213		FA213HH			MD899				
40							FA213		FA213HH			MD899				
41							FA213		FA213HH			MD899				
42							FA213		FA213HH			MD899				
43							FA213		FA213HH			MD899				
44							FA213		FA213HH			MD899				
45							FA213		FA213HH			MD899				
46	VR694BLK*†								FA266HH	EPFA266HH		MD695		MD695C		
47									FA266HH	EPFA266HH		MD695		MD695C		
48	VR694BLK*†								FA266HH	EPFA266HH		MD695		MD695C		
49									FA266HH	EPFA266HH		MD695		MD695C		
50									FA209/2HH			MD695		MD695C		
51	VR841BLK*†								FA181HH			MD8006		MD8006C		
52	VR841BLK*†								FA181HH			MD8006		MD8006C		
53	VR841BLK*†								FA181HH			MD8006		MD8006C		
54	VR841BLK*†								FA181HH			MD8006		MD8006C		
55	VR841BLK*†								FA181HH			MD8006		MD8006C		
56							FA266		FA266HH	EPFA266HH		MD695		MD695C	VR695	

BRAKE APPLICATIONS
 * This symbol indicates a rotor made of billet steel, and should be only used with EBC FA Organic or Vee pads.
 SAFETY NOTICE - With vehicles primarily designed for off highway use such as quads now being used on the highway, we would recommend the use of X or MXS pads for highway use and ONLY using the R and SV higher density / harder pad series for off road riding.

*-2 Sets Required. † For Vee disc colours add RED, BLU, GRN, GLD, ORG suffix to part number. **SAFETY WARNING:- DO NOT USE HH PADS ON REAR UNLESS ALSO USED ON FRONT TO AVOID BRAKE IMBALANCE**

FRONT: Non-Japanese Bikes

APPLICATIONS

BRAKE



DUCATI



			DISC PAD CHOICES - FRONT					BRAKE ROTOR CHOICES - FRONT				
FA/SFA/X Pad or Brake Shoe	Specialty Pads SXR/ VEE/MXS Race	Sintered/ HH Pads/ Grooved Shoes	EPFA Sintered Fast Road/Track Pads	GPFAX Sintered RACE ONLY Pads	SV Series Severe Duty Pads	Standard Rotor Left	Standard Rotor Right	Vintage Rotor / UTV Oversize Brake Kit	Contour Profile Rotor	Line #		
		FA447HH*	EPFA447HH*	GPFAX447HH*		MD694X	MD694X			1		
1198 R Special Edition	2011	FA447HH*	EPFA447HH*	GPFAX447HH*		MD694X	MD694X		MD694XC*	2		
1198 S	2009-2010	FA447HH*	EPFA447HH*	GPFAX447HH*		MD694X	MD694X			3		
1198 SP	2011-2012	FA447HH*	EPFA447HH*	GPFAX447HH*		MD694X	MD694X			4		
Diavel	2011-2017	FA447HH*	EPFA447HH*			MD841X	MD841X		MD841XC*	5		
Diavel AMG	2012-2013	FA447HH*	EPFA447HH*			MD841X	MD841X		MD841XC*	6		
Diavel Carbon	2011-2015	FA447HH*	EPFA447HH*			MD841X	MD841X		MD841XC*	7		
Diavel Carbon	2016-2019	FA447HH*	EPFA447HH*			MD841X	MD841X		MD841XC*	8		
Diavel Cromo	2011-2014	FA447HH*	EPFA447HH*			MD841X	MD841X		MD841XC*	9		
Diavel Dark	2013-2015	FA447HH*	EPFA447HH*			MD841X	MD841X		MD841XC*	10		
Diavel Strada	2013-2015	FA447HH*	EPFA447HH*			MD841X	MD841X		MD841XC*	11		
Panigale 1199	2012-2015	FA447HH*	EPFA447HH*	GPFAX447HH*		MD694X	MD694X		MD694XC*	12		
Panigale 1199 R	2013-2015	FA447HH*	EPFA447HH*	GPFAX447HH*		MD694X	MD694X		MD694XC*	13		
Panigale 1199 S	2012-2015	FA447HH*	EPFA447HH*	GPFAX447HH*		MD694X	MD694X		MD694XC*	14		
Panigale 1199 S Tricolore	2012-2014	FA447HH*	EPFA447HH*	GPFAX447HH*		MD694X	MD694X		MD694XC*	15		
Panigale 1199 Superleggera	2014	FA447HH*	EPFA447HH*	GPFAX447HH*		MD694X	MD694X		MD694XC*	16		
Monster 1200	2014-2021	FA630HH*	EPFA630HH*			MD841X	MD841X		MD841XC*	17		
Monster 1200 R	2016-2017	FA447HH*	EPFA447HH*			MD841X	MD841X		MD841XC*	18		
Monster 1200 S	2014-2021	FA447HH*	EPFA447HH*			MD841X	MD841X		MD841XC*	19		
Monster 1200 Stripe	2015	FA447HH*	EPFA447HH*							20		
Multistrada 1200	2010-2015	FA244*	EPFA244HH*			MD841X	MD841X		MD841XC*	21		
Multistrada 1200	2016-2017	FA630HH*	EPFA630HH*			MD841X	MD841X		MD841XC*	22		
Multistrada 1200 DVT	2015-2016	FA630HH*	EPFA630HH*			MD8011X	MD8011X			23		
Multistrada 1200 Enduro	2016	FA630HH*	EPFA630HH*			MD841X	MD841X		MD841XC*	24		
Multistrada 1200 Enduro	2017-2019	FA630HH*	EPFA630HH*			MD841X	MD841X		MD841XC*	25		
Multistrada 1200 Enduro Pro	2018-2019	FA630HH*	EPFA630HH*			MD841X	MD841X		MD841XC*	26		
Multistrada 1200 Pikes Peak	2016-2017	FA447HH*	EPFA447HH*			MD8011X	MD8011X			27		
Multistrada 1200 S	2010	FA244*	EPFA244HH*			MD8011X	MD8011X			28		
Multistrada 1200 S	2016-2017	FA447HH*	EPFA447HH*			MD8011X	MD8011X			29		
Multistrada 1200 S D/Air	2016-2017	FA447HH*	EPFA447HH*			MD8011X	MD8011X			30		
Multistrada 1200 S DVT	2015-2017	FA447HH*	EPFA447HH*			MD8011X	MD8011X			31		
Multistrada 1200 S Grandturismo	2013-2014	FA244*	EPFA244HH*			MD8011X	MD8011X			32		
Multistrada 1200 S Pikes Peak	2011-2014	FA244*	EPFA244HH*			MD8011X	MD8011X			33		
Multistrada 1200 S Touring	2010-2014	FA244*	EPFA244HH*			MD8011X	MD8011X			34		
Diavel 1260	2020-2023	FA630HH*				MD841X	MD841X		MD841XC*	35		
Diavel 1260 S	2020-2023	FA447HH*				MD841X	MD841X		MD841XC*	36		
Multistrada 1260	2018-2021	FA630HH*	EPFA447HH*			MD8011X	MD8011X			37		
Multistrada 1260 Enduro	2018-2021	FA447HH*	EPFA447HH*			MD8011X	MD8011X			38		
Multistrada 1260 Pikes Peak	2018-2021	FA447HH*	EPFA447HH*			MD8011X	MD8011X			39		
Multistrada 1260 S	2018-2021	FA447HH*	EPFA447HH*			MD8011X	MD8011X			40		
Multistrada 1260 S Grand Tour	2018-2021	FA447HH*				MD8011X	MD8011X			41		
Multistrada 1260 S Touring	2020	FA447HH*				MD8011X	MD8011X			42		
Multistrada 1260 Touring	2020	FA630HH*				MD8011X	MD8011X			43		
1262 X Diavel Black Star X Diavel	2020-2021	FA447HH*	EPFA447HH*			MD841X	MD841X		MD841XC*	44		
1262 X Diavel Dark X Diavel	2020-2023	FA447HH*	EPFA447HH*			MD841X	MD841X		MD841XC*	45		
1262 X Diavel Nera	2023	FA447HH*	EPFA447HH*			MD841X	MD841X		MD841XC*	46		
1262 X Diavel S X Diavel S	2016-2023	FA447HH*	EPFA447HH*			MD841X	MD841X		MD841XC*	47		
1262 X Diavel X Diavel	2016-2023	FA630HH*	EPFA630HH*			MD841X	MD841X		MD841XC*	48		
1299 Panigale	2015-2021	FA447HH*	EPFA447HH*			MD694X	MD694X		MD694XC*	49		
1299 Panigale R	2015-2021	FA447HH*	EPFA447HH*			MD694X	MD694X		MD694XC*	50		
1299 Panigale R Final Edition	2018-2021	FA447HH*	EPFA447HH*	GPFAX447HH*		MD694X	MD694X		MD694XC*	51		
1299 Panigale S	2015-2021	FA447HH*	EPFA447HH*			MD694X	MD694X		MD694XC*	52		
1299 Panigale S Corse	2018-2021	FA447HH*	EPFA447HH*	GPFAX447HH*		MD694X	MD694X		MD694XC*	53		
1299 Panigale Speciale	2018-2021	FA447HH*	EPFA447HH*	GPFAX447HH*		MD694X	MD694X		MD694XC*	54		
										55		
										56		

* This symbol indicates a rotor made of billet steel, and should be only used with EBC FA Organic or Vee pads.
 SAFETY NOTICE - With vehicles primarily designed for off highway use such as quads now being used on the highway, we would recommend the use of X or MXS pads for highway use and ONLY using the R and SV higher density / harder pad series for off road riding.

*-2 Sets Required. † For Vee disc colours add RED, BLU, GRN, GLD, ORG suffix to part number. **SAFETY WARNING:- DO NOT USE HH PADS ON REAR UNLESS ALSO USED ON FRONT TO AVOID BRAKE IMBALANCE**

FRONT: Non-Japanese Bikes Cont'd

REAR: Non-Japanese Bikes

Line #	BRAKE ROTOR CHOICES - FRONT					REAR	DISC PAD CHOICES - REAR					BRAKE ROTOR CHOICES - REAR				
	CX Extreme® /Vee-Rotor	OSX Series Oversize 280mm Rotor Kit	Relocating Bracket for Oversize Rotor	SMX Series Oversize 320mm Rotor Kit	Relocating Bracket for 320mm Rotor		Front Disc Bolt Kit	FA/SFA/X Pad or Brake Shoe	Specialty Pads SXR/ VEE/MXS Race	Sintered/ HH Pads/ Grooved Shoes	EPFA Sintered Fast Road/ Track Pads	SV Series Severe Duty Pads	Standard Rotor	Vintage Rotor / UTV Oversize Brake Kit	Contour Profile Rotor	CX Extreme® /Vee-Rotor
1							FA266		FA266HH	EPFA266HH		MD695		MD695C	VR695	
2							FA266		FA266HH	EPFA266HH		MD695		MD695C	VR695	
3							FA266		FA266HH	EPFA266HH		MD695		MD695C	VR695	
4	VR841BLK*†								FA209/2HH			MD879				
5	VR841BLK*†								FA209/2HH			MD879				
6									FA209/2HH			MD879				
7	VR841BLK*†								FA209/2HH			MD879				
8	VR841BLK*†								FA209/2HH							
9	VR841BLK*†								FA209/2HH							
10	VR841BLK*†								FA209/2HH							
11	VR694BLK*†						FA266		FA266HH	EPFA266HH		MD880		MD880C	VR880	
12	VR694BLK*†						FA266		FA266HH	EPFA266HH		MD880		MD880C	VR880	
13	VR694BLK*†						FA266		FA266HH	EPFA266HH		MD880		MD880C	VR880	
14	VR694BLK*†						FA266		FA266HH	EPFA266HH		MD880		MD880C	VR880	
15	VR694BLK*†						FA266		FA266HH	EPFA266HH		MD880		MD880C	VR880	
16	VR841BLK*†						FA266		FA266HH	EPFA266HH		MD880		MD880C	VR880	
17	VR841BLK*†						FA266		FA266HH	EPFA266HH		MD880		MD880C	VR880	
18	VR841BLK*†						FA266		FA266HH	EPFA266HH		MD880		MD880C	VR880	
19							FA266		FA266HH	EPFA266HH		MD880		MD880C	VR880	
20	VR841BLK*†						FA266		FA266HH	EPFA266HH		MD880		MD880C	VR880	
21	VR841BLK*†						FA181X		FA181HH			MD879				
22							FA181X		FA181HH			MD879				
23	VR841BLK*†						FA181X		FA181HH			MD8006		MD8006C		
24	VR841BLK*†						FA181X		FA181HH			MD8006		MD8006C		
25	VR841BLK*†						FA181X		FA181HH			MD8006		MD8006C		
26							FA181X		FA181HH			MD879				
27							FA266		FA266HH	EPFA266HH		MD880				
28							FA181X		FA181HH			MD879				
29							FA181X		FA181HH			MD879				
30							FA181X		FA181HH			MD879				
31							FA266		FA266HH	EPFA266HH		MD880				
32							FA266		FA266HH	EPFA266HH		MD880				
33							FA266		FA266HH	EPFA266HH		MD880				
34							FA209/2		FA209/2HH			MD879				
35							FA209/2		FA209/2HH			MD879				
36							FA181X		FA181R			MD879				
37							FA181X		FA181R			MD879				
38							FA181X		FA181R			MD879				
39							FA181X		FA181R			MD879				
40							FA209/2		FA209/2HH			MD879				
41							FA209/2		FA209/2HH			MD879				
42							FA209/2		FA209/2HH			MD879				
43	VR841BLK*†								FA209/2HH			MD879				
44	VR841BLK*†								FA209/2HH			MD879				
45	VR841BLK*†								FA209/2HH			MD879				
46	VR841BLK*†								FA209/2HH			MD879				
47	VR841BLK*†								FA209/2HH			MD879				
48	VR694BLK*†						FA266		FA266HH	EPFA266HH		MD880		MD880C	VR880	
49	VR694BLK*†						FA266		FA266HH	EPFA266HH		MD880		MD880C	VR880	
50	VR694BLK*†						FA266		FA266HH	EPFA266HH		MD880		MD880C	VR880	
51	VR694BLK*†						FA266		FA266HH	EPFA266HH		MD880		MD880C	VR880	
52	VR694BLK*†						FA266		FA266HH	EPFA266HH		MD880		MD880C		
53	VR694BLK*†						FA266		FA266HH	EPFA266HH		MD880		MD880C		
54																
55																
56																

BRAKE APPLICATIONS
 * This symbol indicates a rotor made of billet steel, and should be only used with EBC FA Organic or Vee pads.
 SAFETY NOTICE - With vehicles primarily designed for off highway use such as quads now being used on the highway, we would recommend the use of X or MXS pads for highway use and ONLY using the R and SV higher density / harder pad series for off road riding.

*-2 Sets Required. † For Vee disc colours add RED, BLU, GRN, GLD, ORG suffix to part number. **SAFETY WARNING:- DO NOT USE HH PADS ON REAR UNLESS ALSO USED ON FRONT TO AVOID BRAKE IMBALANCE**

FRONT: Non-Japanese Bikes Cont'd

REAR: Non-Japanese Bikes

Line #	BRAKE ROTOR CHOICES - FRONT					DISC PAD CHOICES - REAR					BRAKE ROTOR CHOICES - REAR				
	CX Extreme® /Vee-Rotor	OSX Series Oversize 280mm Rotor Kit	Relocating Bracket for Oversize Rotor	SMX Series Oversize 320mm Rotor Kit	Relocating Bracket for 320mm Rotor	Front Disc Bolt Kit	FA/SFA/X Pad or Brake Shoe	Specialty Pads SXR/ VEE/MXS Race	Sintered/ HH Pads/ Grooved Shoes	EPFA Sintered Fast Road/ Track Pads	SV Series Severe Duty Pads	Standard Rotor	Vintage Rotor / UTV Oversize Brake Kit	Contour Profile Rotor	CX Extreme® /Vee-Rotor
1							FA266		FA266HH	EPFA266HH					
2							FA266		FA266HH	EPFA266HH					
3							FA266		FA266HH	EPFA266HH					
4							FA266		FA266HH	EPFA266HH					
5															
6															
7							330		330G						
8							330		330G						
9															
10															
11															
12							FA83X		FA83R						
13							SFA83		SFA83HH						
14															
15															
16															
17							FA83X		FA83R						
18							FA83X		FA83R						
19							FA83X		FA83R						
20							330		330G						
21							330		330G						
22							330		330G						
23							330		330G						
24							FA83X		FA83R						
25							FA83X		FA83R						
26							FA83X		FA83R						
27							FA165X		FA165R						
28							330		330G						
29							330		330G						
30							SFA83		SFA83HH						
31							FA165X		FA165R						
32							FA165X		FA165R						
33							330		330G						
34							330		330G						
35							FA83X		FA83R						
36															
37															
38							FA351X								
39							FA325X		FA325R						
40							FA325X		FA325R						
41							FA291X								
42							FA291X								
43							FA351X								
44							FA351X								
45							FA291X								
46							FA181X	MXS181	FA181R	EPFA181HH					
47							FA291X								
48							FA291X								
49							FA291X								
50							FA115X		FA115R						
51							FA291X								
52							FA325X		FA325R						
53							FA115X								
54							FA357X		FA357R				MD6249C		
55							FA351X								
56							FA351X								

⚠ This symbol indicates a rotor made of billet steel, and should be only used with EBC FA Organic or Vee pads.
SAFETY NOTICE - With vehicles primarily designed for off highway use such as quads now being used on the highway, we would recommend the use of X or MXS pads for highway use and ONLY using the R and SV higher density / harder pad series for off road riding.

*-2 Sets Required. † For Vee disc colours add RED, BLU, GRN, GLD, ORG suffix to part number. **SAFETY WARNING:- DO NOT USE HH PADS ON REAR UNLESS ALSO USED ON FRONT TO AVOID BRAKE IMBALANCE**

FRONT: Non-Japanese Bikes

APPLICATIONS

BRAKE



GAS-GAS



		DISC PAD CHOICES - FRONT						BRAKE ROTOR CHOICES - FRONT				Line #
FA/SFA/X Pad or Shoe	Specialty Pads SXR/ VEE/MXS Race	Sintered/ HH Pads/ Grooved Shoes	EPFA Sintered Fast Road/Track Pads	GPFAX Sintered RACE ONLY Pads	SV Series Severe Duty Pads	Standard Rotor Left	Standard Rotor Right	Vintage Rotor / UTV Oversize Brake Kit	Contour Profile Rotor			
TXT 80 Cadet Pro											1	
TXT 80 Rookie/Cadet											2	
MC 85 BW 19/16										MD6379C	3	
MC 85 SW 17/14										MD6379C	4	
EC 125/200/250/300										MD6289C	5	
EC 125/200/250/300										MD6289C	6	
HP 125											7	
JTX 125/200/270/320											8	
MC 125										MD6289C	9	
MX 125/250										MD6289C	10	
Pampera 125/250/280											11	
Pampera 125/250/370											12	
Pampera 125/450											13	
SM 125/250											14	
Trial GP 125/250/280/300											15	
TXT 125/200/249/280/321											16	
TXT 125/200/250/280/300											17	
TXT 125/200/250/280/300											18	
TXT 125/250/280/300											19	
MC 125										MD6032C	20	
EC 200/250/300											21	
EC Ranger 200/300											22	
EC Six Days 250/300											23	
Enduro EC 200/250/300											24	
HP 200											25	
MX 200/250/300											26	
TX 200 Radonne											27	
TX 200/270/320											28	
TX 200/270/321											29	
XC 200/250/300											30	
Contact JT25 238											31	
HP 240 Wild											32	
Contact RR 250/280											33	
HP 250 Wild											34	
Pampera 250											35	
Pampera 250/320											36	
Trial GP 250/300											37	
TXT 250/280/300 Raga											38	
EC 250 Enduro										MD6032C	39	
EC 250F Enduro										MD6032C	40	
EX 250 Cross Country										MD6032C	41	
EX 250F Cross Country										MD6032C	42	
MC 250										MD6032C	43	
MC 250F										MD6032C	44	
HP 300 RV											45	
HP 300 Wild Quad											46	
TXT 300 Raga											47	
EC 300 Enduro										MD6032C	48	
EX 300 Cross Country										MD6032C	49	
EC 350F Enduro										MD6032C	50	
ES 350F										MD6032C	51	
EX 350F Cross Country										MD6032C	52	
MC 350F										MD6032C	53	
SM 400 FSE											54	
EC 450											55	
FSE 450											56	

⚠ This symbol indicates a rotor made of billet steel, and should be only used with EBC FA Organic or Vee pads.
SAFETY NOTICE - With vehicles primarily designed for off highway use such as quads now being used on the highway, we would recommend the use of X or MXS pads for highway use and ONLY using the R and SV higher density / harder pad series for off road riding.

*-2 Sets Required. † For Vee disc colours add RED, BLU, GRN, GLD, ORG suffix to part number. **SAFETY WARNING:- DO NOT USE HH PADS ON REAR UNLESS ALSO USED ON FRONT TO AVOID BRAKE IMBALANCE**

FRONT: Non-Japanese Bikes Cont'd

REAR: Non-Japanese Bikes

Line #	BRAKE ROTOR CHOICES - FRONT					REAR	DISC PAD CHOICES - REAR					BRAKE ROTOR CHOICES - REAR				
	CX Extreme® /Vee-Rotor	OSX Series Oversize 280mm Rotor Kit	Relocating Bracket for Oversize Rotor	SMX Series Oversize 320mm Rotor Kit	Relocating Bracket for 320mm Rotor		Front Disc Bolt Kit	FA/SFA/X Pad or Brake Shoe	Specialty Pads SXR/ VEE/MXS Race	Sintered/ HH Pads/ Grooved Shoes	EPFA Sintered Fast Road/ Track Pads	SV Series Severe Duty Pads	Standard Rotor	Vintage Rotor / UTV Oversize Brake Kit	Contour Profile Rotor	CX Extreme® /Vee-Rotor
1							FA351X									
2							FA351X									
3							FA368X	MXS368	FA368R					MD6407C		
4							FA368X	MXS368	FA368R					MD6407C		
5							FA131X	MXS131	FA131R			MD6253D		MD6253C		
6							FA367X	MXS367	FA367R			MD6253D		MD6253C		
7							FA181X	MXS181	FA181R	EPFA181HH						
8							FA115X	MXS115	FA115R							
9							FA131X	MXS131	FA131R			MD6253D		MD6253C		
10							FA131X	MXS131	FA131R			MD6253D		MD6253C		
11							FA291X									
12							FA115X	MXS115	FA115R							
13							FA131X		FA131R			MD6253D		MD6253C		
14							FA131X					MD6253D		MD6253C		
15							FA351X									
16							FA291X									
17							FA351X									
18							FA351X									
19							FA351X									
20	MD6032CX					DB603/6	FA368X	MXS368	FA368R			MD6035D		MD6035C	MD6035CX	DB603/6
21							FA367X		FA367R							
22							FA368X		FA368R							
23							FA367X		FA367R							
24							FA131X	MXS131	FA131R	EPFA131HH		MD6253D		MD6253C		
25							FA181X	MXS181	FA181R	EPFA181HH						
26							FA131X	MXS131	FA131R	EPFA131HH		MD6253D		MD6253C		
27							FA351X									
28							FA115X	MXS115	FA115R							
29							FA291X									
30							FA367X		FA367R							
31							FA115X	MXS115	FA115R							
32							FA181X	MXS181	FA181R	EPFA181HH						
33							FA351X									
34							FA181X	MXS181	FA181R	EPFA181HH						
35							FA291X									
36							FA115X	MXS115	FA115R							
37							FA351X									
38							FA351X									
39	MD6032CX					DB603/6	FA368X	MXS368	FA368R			MD6035D		MD6035C	MD6035CX	DB603/6
40	MD6032CX					DB603/6	FA368X	MXS368	FA368R			MD6035D		MD6035C	MD6035CX	DB603/6
41	MD6032CX					DB603/6	FA368X	MXS368	FA368R			MD6035D		MD6035C	MD6035CX	DB603/6
42	MD6032CX					DB603/6	FA368X	MXS368	FA368R			MD6035D		MD6035C	MD6035CX	DB603/6
43	MD6032CX					DB603/6	FA368X	MXS368	FA368R			MD6035D		MD6035C	MD6035CX	DB603/6
44	MD6032CX					DB603/6	FA368X	MXS368	FA368R			MD6035D		MD6035C	MD6035CX	DB603/6
45							FA181X	MXS181	FA181R	EPFA181HH						
46							FA181X	MXS181	FA181R	EPFA181HH						
47							FA351X									
48	MD6032CX					DB603/6	FA368X	MXS368	FA368R			MD6035D		MD6035C	MD6035CX	DB603/6
49	MD6032CX					DB603/6	FA368X	MXS368	FA368R			MD6035D		MD6035C	MD6035CX	DB603/6
50	MD6032CX					DB603/6	FA368X	MXS368	FA368R			MD6035D		MD6035C	MD6035CX	DB603/6
51	MD6032CX					DB603/6	FA368X	MXS368	FA368R			MD6035D		MD6035C	MD6035CX	DB603/6
52	MD6032CX					DB603/6	FA368X	MXS368	FA368R			MD6035D		MD6035C	MD6035CX	DB603/6
53	MD6032CX					DB603/6	FA368X	MXS368	FA368R			MD6035D		MD6035C	MD6035CX	DB603/6
54							FA131X	MXS131	FA131R	EPFA131HH		MD6253D		MD6253C		
55							FA131X	MXS131	FA131R							
56							FA131X	MXS131	FA131R							

BRAKE APPLICATIONS
 This symbol indicates a rotor made of billet steel, and should be only used with EBC FA Organic or Vee pads.
 SAFETY NOTICE - With vehicles primarily designed for off highway use such as quads now being used on the highway, we would recommend the use of X or MXS pads for highway use and ONLY using the R and SV higher density / harder pad series for off road riding.

*-2 Sets Required. † For Vee disc colours add RED, BLU, GRN, GLD, ORG suffix to part number. **SAFETY WARNING:- DO NOT USE HH PADS ON REAR UNLESS ALSO USED ON FRONT TO AVOID BRAKE IMBALANCE**

FRONT: Non-Japanese Bikes

APPLICATIONS

BRAKE



GAS-GAS



HP 450 Wild Quad		2003-2008
SM 450		2003-2005
EC 450F Enduro		2023-2024
EX 450F Cross Country		2021-2024
MC 450F		2021-2024
ES 500F		2024
EW 500F		2024
EC 515		2009
HP 515 Wild		2009
ES 700		2022-2024
SM 700		2022-2024

MD6035D ● SOLID ROTOR MD6035CE FOR ENDURO USE, REAR FITMENTS

GOGORO ELECTRIC SCOOTER

Smart Scooter		2015-2017
---------------	--	-----------

HISUN

110 Axis		2014-2016
110 Forge		2014-2016
250 Sector	Left	2015-2016
	Right	
250 Strike	Left	2015-2016
	Right	
400 Forge	Left	2015-2016
	Right	
400 Forge		2015-2016
HS 400	Left	2015-2016
	Right	
HS 400		2015-2016
450 Sector	Left	2015-2016
	Right	
450 Sector		2015-2016
500 Forge	Left	2015-2016
	Right	
500 Forge		2015-2016
HS 500	Left	2015-2016
	Right	
HS 500		2015-2016
550 Sector	Left	2015-2016
	Right	
550 Sector		2015-2016
700 Forge	Left	2015-2016
	Right	
700 Forge		2015-2016
HS 700	Left	2015-2016
	Right	
HS 700		2015-2016
750 Sector	Left	2015-2016
	Right	
750 Sector		2015-2016
HS 750 Crew		2015-2016
HS 750 Crew	Left	2015-2016
	Right	
800 Tactic	Left	2015-2016
	Right	
800 Tactic		2015-2016

DISC PAD CHOICES - FRONT							BRAKE ROTOR CHOICES - FRONT				Line #
FA/SFA/X Pad or Brake Shoe	Specialty Pads SXR/VEE/MXS Race	Sintered/HH Pads/Grooved Shoes	EPFA Sintered Fast Road/Track Pads	GPFAX Sintered RACE ONLY Pads	SV Series Severe Duty Pads	Standard Rotor Left	Standard Rotor Right	Vintage Rotor / UTV Oversize Brake Kit	Contour Profile Rotor		
FA181X*	MXS181*	FA181R*	EPFA181HH*							1	
FA95		FA95HH	EPFA95HH							2	
FA181X	MXS181	FA181R							MD6032C	3	
FA181X	MXS181	FA181R							MD6032C	4	
FA181X	MXS181	FA181R							MD6032C	5	
FA181X	MXS181	FA181R							MD6032C	6	
FA181X	MXS181	FA181R							MD6032C	7	
FA185X	MXS185	FA185R	EPFA185HH							8	
FA181X*	MXS181*	FA181R*	EPFA181HH*							9	
FA209/2		FA209/2HH							MD844XC	10	
		FA630HH	EPFA630HH				MD6414D			11	
										12	
										13	
										14	
SFA266		SFA266HH					MD9162D			15	
										16	
FA83X*		FA83R*								17	
FA83X*		FA83R*								18	
FA165X		FA165R				FA165SV				19	
FA135X		FA135R				FA135SV				20	
FA165X		FA165R				FA165SV				21	
FA135X		FA135R				FA135SV				22	
FA165X		FA165R				FA165SV				23	
FA135X		FA135R				FA135SV				24	
FA165X		FA165R				FA165SV				25	
FA135X		FA135R				FA135SV				26	
FA165X		FA165R				FA165SV				27	
FA135X		FA135R				FA135SV				28	
FA165X		FA165R				FA165SV				29	
FA135X		FA135R				FA135SV				30	
FA165X		FA165R				FA165SV				31	
FA135X		FA135R				FA135SV				32	
FA165X		FA165R				FA165SV				33	
FA135X		FA135R				FA135SV				34	
FA165X		FA165R				FA165SV				35	
FA135X		FA135R				FA135SV				36	
FA165X		FA165R				FA165SV				37	
FA135X		FA135R				FA135SV				38	
FA165X		FA165R				FA165SV				39	
FA135X		FA135R				FA135SV				40	
FA165X		FA165R				FA165SV				41	
FA135X		FA135R				FA135SV				42	
FA165X		FA165R				FA165SV				43	
FA135X		FA135R				FA135SV				44	
FA165X		FA165R				FA165SV				45	
FA135X		FA135R				FA135SV				46	
FA165X		FA165R				FA165SV				47	
FA135X		FA135R				FA135SV				48	
FA165X		FA165R				FA165SV				49	
FA135X		FA135R				FA135SV				50	
FA165X		FA165R				FA165SV				51	
FA135X		FA135R				FA135SV				52	
FA165X		FA165R				FA165SV				53	
FA135X		FA135R				FA135SV				54	
FA165X		FA165R				FA165SV				55	
FA135X		FA135R				FA135SV				56	

FRONT

⚠ This symbol indicates a rotor made of billet steel, and should be only used with EBC FA Organic or Vee pads. SAFETY NOTICE - With vehicles primarily designed for off highway use such as quads now being used on the highway, we would recommend the use of X or MXS pads for highway use and ONLY using the R and SV higher density / harder pad series for off road riding.

*-2 Sets Required. † For Vee disc colours add RED, BLU, GRN, GLD, ORG suffix to part number. SAFETY WARNING:- DO NOT USE HH PADS ON REAR UNLESS ALSO USED ON FRONT TO AVOID BRAKE IMBALANCE

FRONT: Non-Japanese Bikes Cont'd

REAR: Non-Japanese Bikes

Line #	BRAKE ROTOR CHOICES - FRONT					DISC PAD CHOICES - REAR					BRAKE ROTOR CHOICES - REAR					BRAKE APPLICATIONS
	CX Extreme® /Vee-Rotor	OSX Series Oversize 280mm Rotor Kit	Relocating Bracket for Oversize Rotor	SMX Series Oversize 320mm Rotor Kit	Relocating Bracket for 320mm Rotor	Front Disc Bolt Kit	FA/SFA/X Pad or Brake Shoe	Specialty Pads SXR/ VEE/MXS Race	Sintered/ HH Pads/ Grooved Shoes	EPFA Sintered Fast Road/ Track Pads	SV Series Severe Duty Pads	Standard Rotor	Vintage Rotor / UTV Oversize Brake Kit	Contour Profile Rotor	CX Extreme® /Vee-Rotor	
1							FA181X	MXS181	FA181R	EPFA181HH						
2							FA131X	MXS131	FA131R	EPFA131HH		MD6253D		MD6253C		
3	MD6032CX					DB603/6	FA368X	MXS368	FA368R			MD6035D●		MD6035C	MD6035CX	DB603/6
4	MD6032CX					DB603/6	FA368X	MXS368	FA368R			MD6035D●		MD6035C	MD6035CX	DB603/6
5	MD6032CX					DB603/6	FA368X	MXS368	FA368R			MD6035D●		MD6035C	MD6035CX	DB603/6
6	MD6032CX					DB603/6	FA368X	MXS368	FA368R			MD6035D●		MD6035C	MD6035CX	DB603/6
7	MD6032CX					DB603/6	FA368X	MXS368	FA368R			MD6035D●		MD6035C	MD6035CX	DB603/6
8							FA131X	MXS131	FA131R							
9							FA181X	MXS181	FA181R	EPFA181HH						
10							FA208X		FA208R				MD6417C			
11							FA208X		FA208R			TBC				
12																
13																
14																
15	VR9162						SFA67		SFA67HH			MD9163D			VR9163	
16																
17																
18							FA67X		FA67R							
19							FA67X		FA67R							
20							FA428X		FA428R		FA428SV					
21																
22							FA428X		FA428R		FA428SV					
23																
24							FA135X		FA135R		FA135SV					
25							FA165X		FA165R		FA165SV					
26							FA428X		FA428R							
27							FA135X		FA135R		FA135SV					
28							FA165X		FA165R		FA165SV					
29							FA428X		FA428R							
30							FA135X		FA135R		FA135SV					
31							FA165X		FA165R		FA165SV					
32							FA428X		FA428R							
33							FA135X		FA135R		FA135SV					
34							FA165X		FA165R		FA165SV					
35							FA428X		FA428R							
36							FA135X		FA135R		FA135SV					
37							FA165X		FA165R		FA165SV					
38							FA428X		FA428R							
39							FA135X		FA135R		FA135SV					
40							FA165X		FA165R		FA165SV					
41							FA428X		FA428R							
42							FA135X		FA135R		FA135SV					
43							FA165X		FA165R		FA165SV					
44							FA428X		FA428R							
45							FA135X		FA135R		FA135SV					
46							FA165X		FA165R		FA165SV					
47							FA428X		FA428R							
48							FA135X		FA135R		FA135SV					
49							FA165X		FA165R		FA165SV					
50							FA428X		FA428R							
51							FA428X		FA428R							
52							FA135X		FA135R		FA135SV					
53							FA165X		FA165R		FA165SV					
54							FA135X		FA135R		FA135SV					
55							FA165X		FA165R		FA165SV					
56							FA428X		FA428R							

● This symbol indicates a rotor made of billet steel, and should be only used with EBC FA Organic or Vee pads.
SAFETY NOTICE - With vehicles primarily designed for off highway use such as quads now being used on the highway, we would recommend the use of X or MXS pads for highway use and ONLY using the R and SV higher density / harder pad series for off road riding.

*-2 Sets Required. † For Vee disc colours add RED, BLU, GRN, GLD, ORG suffix to part number. **SAFETY WARNING:- DO NOT USE HH PADS ON REAR UNLESS ALSO USED ON FRONT TO AVOID BRAKE IMBALANCE**

FRONT: Non-Japanese Bikes

BRAKE APPLICATIONS



HISUN



Model	Side	Year
800 Strike	Left	2015-2016
	Right	
HS 800 Crew	Left	2015-2016
	Right	
HS 800 Crew		2015-2016
1000 Tactic	Left	2015-2016
	Right	
1000 Tactic		2015-2016
1000 Sector	Left	2015-2016
	Right	
1000 Sector		2015-2016
1000 Strike		2015-2016
1000 Strike	Left	2015-2016
	Right	
1000 Strike Crew	Left	2015-2016
	Right	
1000 Strike Crew		2015-2016

HUSABERG

Model	Year
TE 250	2011-2014
TE 300	2011-2014
FE 390	2010-2012
All models	1989-1992
All models	1993-1994
All MX/Enduro models	2000-2008
FE 450	2009-2014
FX 450	2010-2011
FE 501	2013-2014
FE 570	2009-2012
FS 570 Supermoto	2010-2011
All models	1995-1999
All supermotard models	2000-2003
FS Supermotard models	2004
FS Supermotard models	2005-2008

HUSQVARNA

Model	Year
EE 3 Electric	2022-2024
EE 5 Electric	2021-2024
CR 50	2011
CR 50 Junior	2005
CR 50 Junior Basic	2005
CR 50 Senior Pro	2005
Husky Boy	2000-2002
Husky Boy J	2001-2002
Husky Boy R	2001
Husky Boy S	2001-2002
SM 50	2002
SM 50	2011
TC 50 50	2018-2023
WR 50	2002
WRS 50 Scooter	1998-2000
CR 65	2012
TC 65	2018-2022
TC 65	2023
TC 85	2014-2020

DISC PAD CHOICES - FRONT

BRAKE ROTOR CHOICES - FRONT

FA/SFA/X Pad or Brake Shoe	Specialty Pads SXR/ VEE/MXS Race	Sintered/ HH Pads/ Grooved Shoes	EPFA Sintered Fast Road/Track Pads	GPFAX Sintered RACE ONLY Pads	SV Series Severe Duty Pads	Standard Rotor Left	Standard Rotor Right	Vintage Rotor / UTV Oversize Brake Kit	Contour Profile Rotor
FA165X		FA165R			FA165SV				
FA135X		FA135R			FA135SV				
FA165X		FA165R			FA165SV				
FA135X		FA135R			FA135SV				
FA165X		FA165R			FA165SV				
FA135X		FA135R			FA135SV				
FA165X		FA165R			FA165SV				
FA135X		FA135R			FA135SV				
FA165X		FA165R			FA165SV				
FA135X		FA135R			FA135SV				
FA165X		FA165R			FA165SV				
FA135X		FA135R			FA135SV				
FA181X	MXS181	FA181R	EPFA181HH						MD6032C
FA181X	MXS181	FA181R	EPFA181HH						MD6032C
FA181X	MXS181	FA181R	EPFA181HH						MD6032C
FA134X		FA134R							
FA181X	MXS181	FA181R	EPFA181HH			MD6125D			
FA181X	MXS181	FA181R	EPFA181HH			MD6032D			MD6032C
FA181X	MXS181	FA181R	EPFA181HH						MD6032C
FA181X	MXS181	FA181R	EPFA181HH						MD6032C
FA181X	MXS181	FA181R	EPFA181HH						MD6032C
FA181X	MXS181	FA181R	EPFA181HH						MD6032C
FA433/4		FA433/4HH	EPFA433/4HH						
FA181X	MXS181	FA181R	EPFA181HH			MD6125D			
FA158		FA158HH	EPFA158HH			MD6270D			MD6270C
	MXS406		EPFA406HH			MD6270D			MD6270C
	MXS405		EPFA405HH			MD6270D			MD6270C
FA47X									
FA325X		FA325R							
FA325X		FA325R							
FA351X									
FA351X									
984									
FA115X	MXS115	FA115R							
FA115X	MXS115	FA115R							
FA115X	MXS115	FA115R							
FA167		FA167HH							
FA325X		FA325R							
FA325X		FA325R							
FA167		FA167HH							
SFA115		SFA115HH					MD964D		
FA357X		FA357R							
FA357X		FA357R							MD6243C
FA368X	MXS368	FA368R							MD6243C
FA612X		FA612R							MD6407C

Line #

⚠ This symbol indicates a rotor made of billet steel, and should be only used with EBC FA Organic or Vee pads.
SAFETY NOTICE - With vehicles primarily designed for off highway use such as quads now being used on the highway, we would recommend the use of X or MXS pads for highway use and ONLY using the R and SV higher density / harder pad series for off road riding.

*-2 Sets Required. † For Vee disc colours add RED, BLU, GRN, GLD, ORG suffix to part number. **SAFETY WARNING:- DO NOT USE HH PADS ON REAR UNLESS ALSO USED ON FRONT TO AVOID BRAKE IMBALANCE**

FRONT: Non-Japanese Bikes Cont'd

REAR: Non-Japanese Bikes

Line #	BRAKE ROTOR CHOICES - FRONT					DISC PAD CHOICES - REAR					BRAKE ROTOR CHOICES - REAR					
	CX Extreme® /Vee-Rotor	OSX Series Oversize 280mm Rotor Kit	Relocating Bracket for Oversize Rotor	SMX Series Oversize 320mm Rotor Kit	Relocating Bracket for 320mm Rotor	Front Disc Bolt Kit	FA/SFA/X Pad or Brake Shoe	Specialty Pads SXR/ VEE/MXS Race	Sintered/ HH Pads/ Grooved Shoes	EPFA Sintered Fast Road/ Track Pads	SV Series Severe Duty Pads	Standard Rotor	Vintage Rotor / UTV Oversize Brake Kit	Contour Profile Rotor	CX Extreme® /Vee-Rotor	Rear Disc Bolt Kit
1							FA135X		FA135R		FA135SV					
2							FA165X		FA165R		FA165SV					
3							FA135X		FA135R		FA135SV					
4							FA165X		FA165R		FA165SV					
5							FA428X		FA428R							
6							FA135X		FA135R		FA135SV					
7							FA165X		FA165R		FA165SV					
8							FA428X		FA428R							
9							FA135X		FA135R		FA135SV					
10							FA165X		FA165R		FA165SV					
11							FA428X		FA428R							
12							FA428X		FA428R							
13							FA135X		FA135R		FA135SV					
14							FA165X		FA165R		FA165SV					
15							FA135X		FA135R		FA135SV					
16							FA165X		FA165R		FA165SV					
17							FA428X		FA428R							
18																
19																
20	MD6032CX	OSX6932	BRK013	SMX6932	BRK014		FA368X	MXS368	FA368R	EPFA368HH		MD6035D	MD6035C	MD6035CX	DB603/6	
21	MD6032CX	OSX6932	BRK013	SMX6932	BRK014		FA368X	MXS368	FA368R	EPFA368HH		MD6035D	MD6035C	MD6035CX	DB603/6	
22	MD6032CX	OSX6932	BRK013	SMX6932	BRK014		FA368X	MXS368	FA368R	EPFA368HH		MD6035D	MD6035C	MD6035CX	DB603/6	
23							FA67X		FA67R							
24		OSX6125	BRK010	SMX6125	BRK007		FA67X		FA67R			MD6126D				
25	MD6032CX	OSX6032	BRK011	SMX6032	BRK012	DB603/6	FA208X	MXS208	FA208R			MD6035D	MD6035C	MD6035CX	DB603/6	
26	MD6032CX	OSX6932	BRK013	SMX6932	BRK014		FA368X	MXS368	FA368R	EPFA368HH		MD6035D	MD6035C	MD6035CX	DB603/6	
27	MD6032CX	OSX6932	BRK013	SMX6932	BRK014		FA368X	MXS368	FA368R	EPFA368HH		MD6035D	MD6035C	MD6035CX	DB603/6	
28	MD6032CX	OSX6932	BRK013	SMX6932	BRK014		FA368X	MXS368	FA368R	EPFA368HH		MD6035D	MD6035C	MD6035CX	DB603/6	
29	MD6032CX	OSX6932	BRK013	SMX6932	BRK014		FA368X	MXS368	FA368R	EPFA368HH		MD6035D	MD6035C	MD6035CX	DB603/6	
30							FA368X	MXS368	FA368R	EPFA368HH		MD6035D	MD6035C	MD6035CX	DB603/6	
31		OSX6125	BRK010	SMX6125	BRK007		FA208X	MXS208	FA208R			MD6126D				
32							FA208X	MXS208	FA208R			MD6035D	MD6035C	MD6035CX	DB603/6	
33							FA208X	MXS208	FA208R			MD6035D	MD6035C	MD6035CX	DB603/6	
34							FA208X	MXS208	FA208R			MD6035D	MD6035C	MD6035CX	DB603/6	
35																
36																
37																
38							FA47X									
39							FA325X		FA325R							
40							FA325X		FA325R							
41																
42																
43							FA325X									
44							984									
45							984									
46							984									
47							984									
48							FA115		FA115HH							
49							FA325X		FA325R							
50							FA325X		FA325R							
51							FA115		FA115HH							
52							624									
53							FA602X		FA602R							
54							FA357X		FA357R				MD6249C			
55							FA368X	MXS368	FA368R							
56							FA602X		FA602R				MD6360C			

BRAKE APPLICATIONS
 This symbol indicates a rotor made of billet steel, and should be only used with EBC FA Organic or Vee pads.
 SAFETY NOTICE - With vehicles primarily designed for off highway use such as quads now being used on the highway, we would recommend the use of X or MXS pads for highway use and ONLY using the R and SV higher density / harder pad series for off road riding.

*-2 Sets Required. † For Vee disc colours add RED, BLU, GRN, GLD, ORG suffix to part number. **SAFETY WARNING:- DO NOT USE HH PADS ON REAR UNLESS ALSO USED ON FRONT TO AVOID BRAKE IMBALANCE**

FRONT: Non-Japanese Bikes

APPLICATIONS

BRAKE



HUSQVARNA



DISC PAD CHOICES - FRONT

BRAKE ROTOR CHOICES - FRONT

Model	Year	FA/SFA/X Pad or Brake Shoe	Specialty Pads SXR/VEE/MXS Race	Sintered/HH Pads/Grooved Shoes	EPFA Sintered Fast Road/Track Pads	GPFAX Sintered RACE ONLY Pads	SV Series Severe Duty Pads	Standard Rotor		Vintage Rotor / UTV Oversize Brake Kit	Contour Profile Rotor	Line #
								Standard Rotor Left	Standard Rotor Right			
TC 85	2014-2020	FA612X		FA612R							MD6407C	1
TC 85	2021-2024	FA181X	MXS181	FA181R							MD6379C	2
TC 85	2021-2024	FA181X	MXS181	FA181R							MD6379C	3
TE 100	2005	FA351X										4
CR 125	1973-1977											5
CR 125	1978			801G								6
CR 125	1979-1981			801G								7
CR 125	1982-1984			803G								8
CR 125	1985-1986	FA47X										9
CR 125	1991	FA134X		FA134R								10
CR 125	1992-1994	FA135X	MXS135	FA135R				MD6125D				11
CR 125	1995-1999	FA181X	MXS181	FA181R	EPFA181HH			MD6125D				12
CR 125	2000-2001	FA181X	MXS181	FA181R	EPFA181HH			MD6184D			MD6184C	13
CR 125	2000-2001	FA181X	MXS181	FA181R	EPFA181HH			MD6184D			MD6184C	14
CR 125	2002-2004	FA181X	MXS181	FA181R	EPFA181HH			MD6184D			MD6184C	15
CR 125	2002-2004	FA181X	MXS181	FA181R	EPFA181HH			MD6184D			MD6184C	16
CR 125	2005	FA181X	MXS181	FA181R	EPFA181HH			MD6184D			MD6184C	17
CR 125	2005	FA181X	MXS181	FA181R	EPFA181HH			MD6184D			MD6184C	18
CR 125	2006-2008	FA181X	MXS181	FA181R	EPFA181HH			MD6184D			MD6184C	19
CR 125	2006-2008	FA181X	MXS181	FA181R	EPFA181HH			MD6184D			MD6184C	20
CR 125	2009-2013	FA181X	MXS181	FA181R	EPFA181HH			MD6184D			MD6184C	21
SC 125	1973-1974											22
SM 125	1998-1999	FA181X	MXS181	FA181R	EPFA181HH			MD6125D				23
SMS 125	2002-2011	FA181X	MXS181	FA181R	EPFA181HH			MD6184D			MD6184C	24
SMS 125	2002-2011	FA181X	MXS181	FA181R	EPFA181HH			MD6184D			MD6184C	25
SMS-4 125	2010-2011	FA181X	MXS181	FA181R	EPFA181HH			MD6184D			MD6184C	26
SMS-4 125	2010-2011	FA181X	MXS181	FA181R	EPFA181HH			MD6184D			MD6184C	27
TC 125	2014-2024	FA181X	MXS181	FA181R	EPFA181HH			MD6032D			MD6032C	28
TE 125	2011	FA181X	MXS181	FA181R	EPFA181HH			MD6184D			MD6184C	29
TE 125	2011	FA181X	MXS181	FA181R	EPFA181HH			MD6184D			MD6184C	30
TE 125	2014-2017	FA181X	MXS181	FA181R	EPFA181HH			MD6032D			MD6032C	31
TX125	2018-2019	FA181X	MXS181	FA181R	EPFA181HH			MD6032D			MD6032C	32
WR 125	1973-1974											33
WR 125	1979			801G								34
WR 125	1980-1981			802G								35
WR 125	1982-1984			803G								36
WR 125	1987-1988	FA134X		FA134R								37
WR 125	1991	FA134X		FA134R								38
WR 125	1993-1994	FA135X	MXS135	FA135R				MD6125D				39
WR 125	1995-1999	FA181X	MXS181	FA181R	EPFA181HH			MD6125D				40
WR 125	2000-2001	FA181X	MXS181	FA181R	EPFA181HH			MD6184D			MD6184C	41
WR 125	2000-2001	FA181X	MXS181	FA181R	EPFA181HH			MD6184D			MD6184C	42
WR 125	2002-2005	FA181X	MXS181	FA181R	EPFA181HH			MD6184D			MD6184C	43
WR 125	2002-2005	FA181X	MXS181	FA181R	EPFA181HH			MD6184D			MD6184C	44
WR 125	2006-2008	FA181X	MXS181	FA181R	EPFA181HH			MD6184D			MD6184C	45
WR 125	2006-2008	FA181X	MXS181	FA181R	EPFA181HH			MD6184D			MD6184C	46
WR 125	2009-2013	FA181X	MXS181	FA181R	EPFA181HH			MD6184D			MD6184C	47
WRE 125	1993-1999	FA181X	MXS181	FA181R	EPFA181HH			MD6125D				48
WRE 125	2002-2011	FA181X	MXS181	FA181R	EPFA181HH			MD6184D			MD6184C	49
WRE 125	2002-2011	FA181X	MXS181	FA181R	EPFA181HH			MD6184D			MD6184C	50
WXE 125	2007	FA167		FA167HH				MD6184D			MD6184C	51
XC 125	1982-1984			803G								52
XC 125	1985-1986	FA47X										53
TE 150 Tpi	2018-2024	FA181X	MXS181	FA181R				MD6032D			MD6032C	54
CR 240	1980-1981			802G								55
CR 240	1982-1984			803G								56

FRONT

⚠ This symbol indicates a rotor made of billet steel, and should be only used with EBC FA Organic or Vee pads.

SAFETY NOTICE - With vehicles primarily designed for off highway use such as quads now being used on the highway, we would recommend the use of X or MXS pads for highway use and ONLY using the R and SV higher density / harder pad series for off road riding.

*-2 Sets Required. † For Vee disc colours add RED, BLU, GRN, GLD, ORG suffix to part number. **SAFETY WARNING:- DO NOT USE HH PADS ON REAR UNLESS ALSO USED ON FRONT TO AVOID BRAKE IMBALANCE**

FRONT: Non-Japanese Bikes Cont'd

REAR: Non-Japanese Bikes

Line # 1
2
3
4
5
6
7
8
9
10
11
12
13
14
15
16
17
18
19
20
21
22
23
24
25
26
27
28
29
30
31
32
33
34
35
36
37
38
39
40
41
42
43
44
45
46
47
48
49
50
51
52
53
54
55
56

BRAKE ROTOR CHOICES - FRONT						DISC PAD CHOICES - REAR						BRAKE ROTOR CHOICES - REAR				
CX Extreme® /Vee-Rotor	OSX Series Oversize 280mm Rotor Kit	Relocating Bracket for Oversize Rotor	SMX Series Oversize 320mm Rotor Kit	Relocating Bracket for 320mm Rotor	Front Disc Bolt Kit	FA/SFA/X Pad or Brake Shoe	Specialty Pads SXR/ VEE/MXS Race	Sintered/ HH Pads/ Grooved Shoes	EPFA Sintered Fast Road/ Track Pads	SV Series Severe Duty Pads	Standard Rotor	Vintage Rotor / UTV Oversize Brake Kit	Contour Profile Rotor	CX Extreme® /Vee-Rotor	Rear Disc Bolt Kit	
						FA602X		FA602R					MD6360C			
						FA368X	MXS368	FA368R			MD6035D●		MD6035C	MD6035CX	DB603/6	
						FA368X	MXS368	FA368R			MD6035D●		MD6035C	MD6035CX	DB603/6	
								801G								
								801G								
								802G								
						FA251					MD6126D					
						FA84X	MXS84	FA84R			MD6126D					
						FA208X	MXS208	FA208R			MD6126D					
	OSX6125	BRK010	SMX6125	BRK007		FA208X	MXS208	FA208R			MD6287D					
	OSX6184	BRK010	SMX6184H	BRK007		FA208X	MXS208	FA208R			MD6287D					
	OSX6184K	BRK011	SMX6184K	BRK012		FA208X	MXS208	FA208R			MD6287D					
	OSX6184	BRK010	SMX6184H	BRK007		FA208X	MXS208	FA208R			MD6295D					
	OSX6184K	BRK011	SMX6184K	BRK012		FA208X	MXS208	FA208R			MD6295D					
	OSX6184	BRK010	SMX6184H	BRK007		FA368X	MXS368	FA368R	EPFA368HH		MD6295D					
	OSX6184K	BRK011	SMX6184K	BRK012		FA368X	MXS368	FA368R	EPFA368HH		MD6295D					
	OSX6184	BRK010	SMX6184H	BRK007		FA368X	MXS368	FA368R	EPFA368HH		MD6288D		MD6288C			
	OSX6184K	BRK011	SMX6184K	BRK012		FA368X	MXS368	FA368R	EPFA368HH		MD6288D		MD6288C			
	OSX6184K	BRK011	SMX6184K	BRK011		FA368X	MXS368	FA368R	EPFA368HH							
	OSX6125	BRK010	SMX6125	BRK007		FA208X	MXS208	FA208R			MD6126D					
	OSX6184	BRK010	SMX6184H	BRK007		FA208X	MXS208	FA208R			MD6287D					
	OSX6184K	BRK011	SMX6184K	BRK012		FA208X	MXS208	FA208R			MD6287D					
	OSX6184	BRK010	SMX6184H	BRK007		FA208X	MXS208	FA208R			MD6287D					
	OSX6184K	BRK011	SMX6184K	BRK012		FA208X	MXS208	FA208R			MD6287D					
MD6032CX	OSX6932	BRK013	SMX6032	BRK014	DB603/6	FA368X	MXS368	FA368R			MD6035D●		MD6035C	MD6035CX	DB603/6	
	OSX6184	BRK010	SMX6184H	BRK007		FA368X	MXS368	FA368R	EPFA368HH							
	OSX6184K	BRK011	SMX6184K	BRK012		FA368X	MXS368	FA368R	EPFA368HH							
MD6032CX	OSX6932	BRK013	SMX6032	BRK014	DB603/6	FA368X	MXS368	FA368R	EPFA368HH		MD6035D●		MD6035C	MD6035CX	DB603/6	
MD6032CX					DB603/6	FA368X	MXS368	FA368R	EPFA368HH		MD6035D●		MD6035C	MD6035CX	DB603/6	
								801G								
								802G								
								802G								
								802G								
						FA251					MD6126D					
						FA84X	MXS84	FA84R			MD6126D					
	OSX6125	BRK010	SMX6125	BRK007		FA208X	MXS208	FA208R			MD6126D					
	OSX6184	BRK010	SMX6184H	BRK007		FA208X	MXS208	FA208R			MD6287D					
	OSX6184K	BRK011	SMX6184K	BRK012		FA208X	MXS208	FA208R			MD6287D					
	OSX6184	BRK010	SMX6184H	BRK007		FA208X	MXS208	FA208R			MD6295D					
	OSX6184K	BRK011	SMX6184K	BRK012		FA208X	MXS208	FA208R			MD6295D					
	OSX6184	BRK010	SMX6184H	BRK007		FA368X	MXS368	FA368R	EPFA368HH		MD6288D		MD6288C			
	OSX6184K	BRK011	SMX6184K	BRK012		FA368X	MXS368	FA368R	EPFA368HH		MD6288D		MD6288C			
	OSX6184K	BRK011	SMX6184K	BRK011		FA368X	MXS368	FA368R	EPFA368HH							
	OSX6125	BRK010	SMX6125	BRK007		FA208X	MXS208	FA208R			MD6126D					
	OSX6184	BRK010	SMX6184H	BRK007		FA208X	MXS208	FA208R			MD6287D					
	OSX6184K	BRK011	SMX6184K	BRK012		FA208X	MXS208	FA208R			MD6287D					
						FA131X	MXS131	FA131R								
								802G								
								801G								
					DB603/6	FA368X	MXS368	FA368R			MD6035D●		MD6035C	MD6035CX	DB603/6	
								801G								
								801G								

REAR

BRAKE APPLICATIONS

⚠ This symbol indicates a rotor made of billet steel, and should be only used with EBC FA Organic or Vee pads. SAFETY NOTICE - With vehicles primarily designed for off highway use such as quads now being used on the highway, we would recommend the use of X or MXS pads for highway use and ONLY using the R and SV higher density / harder pad series for off road riding.

*-2 Sets Required. † For Vee disc colours add RED, BLU, GRN, GLD, ORG suffix to part number. SAFETY WARNING:- DO NOT USE HH PADS ON REAR UNLESS ALSO USED ON FRONT TO AVOID BRAKE IMBALANCE

FRONT: Non-Japanese Bikes

APPLICATIONS

BRAKE



HUSQVARNA



DISC PAD CHOICES - FRONT

BRAKE ROTOR CHOICES - FRONT

Model	Year	FA/SFA/X Pad or Brake Shoe	Specialty Pads SXR/VEE/MXS Race	Sintered/HH Pads/Grooved Shoes	EPFA Sintered Fast Road/Track Pads	GPFAX Sintered RACE ONLY Pads	SV Series Severe Duty Pads	Standard Rotor		Vintage Rotor / UTV Oversize Brake Kit	Contour Profile Rotor
								Standard Rotor Left	Standard Rotor Right		
CR 240	1985-1986	FA47X									
CR 240	1987-1988	FA134X		FA134R							
WR 240	1978			801G							
WR 240	1980-1981			802G							
WR 240	1982-1984			803G							
WR 240	1987-1988	FA134X		FA134R							
WR 240	1990-1991	FA134X		FA134R							
CR 250	1971-1974										
CR 250	1975-1979			801G							
CR 250	1980-1981			802G							
CR 250	1982-1984			803G							
CR 250	1985-1986	FA47X									
CR 250	1987-1988	FA134X		FA134R							
CR 250	1991	FA134X		FA134R							
CR 250	1992-1994	FA135X	MXS135	FA135R				MD6125D			
CR 250	1995-1999	FA181X	MXS181	FA181R	EPFA181HH			MD6125D			
CR 250	2000-2001	FA181X	MXS181	FA181R	EPFA181HH			MD6184D		MD6184C	
CR 250	2000-2001	FA181X	MXS181	FA181R	EPFA181HH			MD6184D		MD6184C	
CR 250	2002-2004	FA181X	MXS181	FA181R	EPFA181HH			MD6184D		MD6184C	
CR 250	2002-2004	FA181X	MXS181	FA181R	EPFA181HH			MD6184D		MD6184C	
CR 250	2005	FA181X	MXS181	FA181R	EPFA181HH			MD6184D		MD6184C	
CR 250	2005	FA181X	MXS181	FA181R	EPFA181HH			MD6184D		MD6184C	
FC 250	2014-2024	FA181X	MXS181	FA181R	EPFA181HH			MD6032D		MD6032C	
FE 250	2014-2023	FA181X	MXS181	FA181R	EPFA181HH			MD6032D		MD6032C	
FX 250	2023	FA181X	MXS181	FA181R	EPFA181HH			MD6032D		MD6032C	
TC 250	2002-2003	FA181X	MXS181	FA181R	EPFA181HH			MD6184D		MD6184C	
TC 250	2002-2003	FA181X	MXS181	FA181R	EPFA181HH			MD6184D		MD6184C	
TC 250	2005-2008	FA181X	MXS181	FA181R	EPFA181HH			MD6184D		MD6184C	
TC 250	2005-2008	FA181X	MXS181	FA181R	EPFA181HH			MD6184D		MD6184C	
TC 250	2009-2012	FA181X	MXS181	FA181R	EPFA181HH			MD6184D		MD6184C	
TC 250	2009-2012	FA181X	MXS181	FA181R	EPFA181HH			MD6184D		MD6184C	
TC 250	2013	FA181X	MXS181	FA181R	EPFA181HH			MD6184D		MD6184C	
TC 250	2014-2024	FA181X	MXS181	FA181R	EPFA181HH			MD6032D		MD6032C	
TE 250	2002-2005	FA181X	MXS181	FA181R	EPFA181HH			MD6184D		MD6184C	
TE 250	2002-2005	FA181X	MXS181	FA181R	EPFA181HH			MD6184D		MD6184C	
TE 250	2006-2008	FA181X	MXS181	FA181R	EPFA181HH			MD6184D		MD6184C	
TE 250	2006-2008	FA181X	MXS181	FA181R	EPFA181HH			MD6184D		MD6184C	
TE 250	2009-2012	FA181X	MXS181	FA181R	EPFA181HH			MD6184D		MD6184C	
TE 250	2009-2012	FA181X	MXS181	FA181R	EPFA181HH			MD6184D		MD6184C	
TE 250	2014-2019	FA181X	MXS181	FA181R	EPFA181HH			MD6032D		MD6032C	
TE 250 TPI	2019-2024	FA181X	MXS181	FA181R	EPFA181HH			MD6032D		MD6032C	
TXC 250 Cross Country	2008	FA181X	MXS181	FA181R	EPFA181HH			MD6184D		MD6184C	
TXC 250 Cross Country	2009-2012	FA181X	MXS181	FA181R	EPFA181HH			MD6184D		MD6184C	
TXC 250 Cross Country	2008	FA181X	MXS181	FA181R	EPFA181HH			MD6184D		MD6184C	
TXC 250 Cross Country	2009-2012	FA181X	MXS181	FA181R	EPFA181HH			MD6184D		MD6184C	
TXC 250 Cross Country	2013	FA181X	MXS181	FA181R	EPFA181HH			MD6184D		MD6184C	
WR 250	1971-1974										
WR 250	1975-1978			801G							
WR 250	1980-1981			802G							
WR 250	1982-1984			803G							
WR 250	1987-1988	FA134X		FA134R							
WR 250	1990-1991	FA134X		FA134R							
WR 250	1992-1994	FA135X	MXS135	FA135R				MD6125D			
WR 250	1995-1999	FA181X	MXS181	FA181R	EPFA181HH			MD6125D			
WR 250	2000-2001	FA181X	MXS181	FA181R	EPFA181HH			MD6184D		MD6184C	
WR 250	2000-2001	FA181X	MXS181	FA181R	EPFA181HH			MD6184D		MD6184C	

Line #

FRONT

⚠ This symbol indicates a rotor made of billet steel, and should be only used with EBC FA Organic or Vee pads.
SAFETY NOTICE - With vehicles primarily designed for off highway use such as quads now being used on the highway, we would recommend the use of X or MXS pads for highway use and ONLY using the R and SV higher density / harder pad series for off road riding.

*-2 Sets Required. † For Vee disc colours add RED, BLU, GRN, GLD, ORG suffix to part number. SAFETY WARNING:- DO NOT USE HH PADS ON REAR UNLESS ALSO USED ON FRONT TO AVOID BRAKE IMBALANCE

FRONT: Non-Japanese Bikes Cont'd

REAR: Non-Japanese Bikes

Line # 1 2 3 4 5 6 7 8 9 10 11 12 13 14 15 16 17 18 19 20 21 22 23 24 25 26 27 28 29 30 31 32 33 34 35 36 37 38 39 40 41 42 43 44 45 46 47 48 49 50 51 52 53 54 55 56

BRAKE ROTOR CHOICES - FRONT						DISC PAD CHOICES - REAR						BRAKE ROTOR CHOICES - REAR				
CX Extreme® /Vee-Rotor	OSX Series Oversize 280mm Rotor Kit	Relocating Bracket for Oversize Rotor	SMX Series Oversize 320mm Rotor Kit	Relocating Bracket for 320mm Rotor	Front Disc Bolt Kit	FA/SFA/X Pad or Brake Shoe	Specialty Pads SXR/ VEE/MXS Race	Sintered/ HH Pads/ Grooved Shoes	EPFA Sintered Fast Road/ Track Pads	SV Series Severe Duty Pads	Standard Rotor	Vintage Rotor / UTV Oversize Brake Kit	Contour Profile Rotor	CX Extreme® /Vee-Rotor	Rear Disc Bolt Kit	
								802G								
								802G								
								801G								
								802G								
								802G								
								802G								
							FA251				MD6126D					
								801G								
								801G								
								801G								
								802G								
								802G								
							FA251				MD6126D					
						FA84X	MXS84	FA84R			MD6126D					
	OSX6125	BRK010	SMX6125	BRK007		FA208X	MXS208	FA208R			MD6126D					
	OSX6184	BRK010	SMX6184H	BRK007		FA208X	MXS208	FA208R			MD6287D					
	OSX6184K	BRK011	SMX6184K	BRK012		FA208X	MXS208	FA208R			MD6287D					
	OSX6184	BRK010	SMX6184H	BRK007		FA208X	MXS208	FA208R			MD6295D					
	OSX6184K	BRK011	SMX6184K	BRK012		FA208X	MXS208	FA208R			MD6295D					
	OSX6184	BRK010	SMX6184H	BRK007		FA368X	MXS368	FA368R	EPFA368HH		MD6295D					
	OSX6184K	BRK011	SMX6184K	BRK012		FA368X	MXS368	FA368R	EPFA368HH		MD6295D					
MD6032CX	OSX6932	BRK013	SMX6032	BRK014	DB603/6	FA368X	MXS368	FA368R			MD6035D●	MD6035C	MD6035CX	DB603/6		
MD6032CX	OSX6932	BRK013	SMX6032	BRK014	DB603/6	FA368X	MXS368	FA368R	EPFA368HH		MD6035D●	MD6035C	MD6035CX	DB603/6		
MD6032CX	OSX6932	BRK013			DB603/6	FA368X	MXS368	FA368R	EPFA368HH		MD6035D●	MD6035C	MD6035CX	DB603/6		
	OSX6184	BRK010	SMX6184H	BRK007		FA208X	MXS208	FA208R			MD6295D					
	OSX6184K	BRK011	SMX6184K	BRK012		FA208X	MXS208	FA208R			MD6295D					
	OSX6184	BRK010	SMX6184H	BRK007		FA368X	MXS368	FA368R	EPFA368HH		MD6288D		MD6288C			
	OSX6184K	BRK011	SMX6184K	BRK012		FA368X	MXS368	FA368R	EPFA368HH		MD6288D		MD6288C			
	OSX6184	BRK010	SMX6184H	BRK007		FA368X	MXS368	FA368R	EPFA368HH							
	OSX6184K	BRK011	SMX6184K	BRK012		FA368X	MXS368	FA368R	EPFA368HH							
	OSX6184	BRK010	SMX6184H	BRK007		FA368X	MXS368	FA368R	EPFA368HH							
	OSX6184K	BRK011	SMX6184K	BRK012		FA368X	MXS368	FA368R	EPFA368HH							
MD6032CX	OSX6932	BRK013	SMX6032	BRK014	DB603/6	FA368X	MXS368	FA368R			MD6035D●	MD6035C	MD6035CX	DB603/6		
	OSX6184	BRK010	SMX6184H	BRK007		FA208X	MXS208	FA208R			MD6295D					
	OSX6184K	BRK011	SMX6184K	BRK012		FA208X	MXS208	FA208R			MD6295D					
	OSX6184	BRK010	SMX6184H	BRK007		FA368X	MXS368	FA368R	EPFA368HH		MD6288D		MD6288C			
	OSX6184K	BRK011	SMX6184K	BRK012		FA368X	MXS368	FA368R	EPFA368HH		MD6288D		MD6288C			
	OSX6184	BRK010	SMX6184H	BRK007		FA368X	MXS368	FA368R	EPFA368HH							
	OSX6184K	BRK011	SMX6184K	BRK012		FA368X	MXS368	FA368R	EPFA368HH							
MD6032CX	OSX6932	BRK013	SMX6032	BRK014	DB603/6	FA368X	MXS368	FA368R	EPFA368HH		MD6035D●	MD6035C	MD6035CX	DB603/6		
MD6032CX	OSX6932	BRK013			DB603/6	FA368X	MXS368	FA368R	EPFA368HH		MD6035D●	MD6035C	MD6035CX	DB603/6		
	OSX6184	BRK010	SMX6184H	BRK007		FA368X	MXS368	FA368R	EPFA368HH		MD6288D		MD6288C			
	OSX6184K	BRK011	SMX6184K	BRK012		FA368X	MXS368	FA368R	EPFA368HH							
	OSX6184	BRK010	SMX6184H	BRK007		FA368X	MXS368	FA368R	EPFA368HH		MD6288D		MD6288C			
	OSX6184K	BRK011	SMX6184K	BRK012		FA368X	MXS368	FA368R	EPFA368HH							
	OSX6184	BRK010	SMX6184H	BRK007		FA368X	MXS368	FA368R	EPFA368HH							
	OSX6184K	BRK011	SMX6184K	BRK012		FA368X	MXS368	FA368R	EPFA368HH							
	OSX6184	BRK010	SMX6184H	BRK007		FA368X	MXS368	FA368R	EPFA368HH							
	OSX6184K	BRK011	SMX6184K	BRK012		FA368X	MXS368	FA368R	EPFA368HH							
								801G								
								801G								
								802G								
								802G								
								802G								
							FA251				MD6126D					
						FA84X	MXS84	FA84R			MD6126D					
	OSX6125	BRK010	SMX6125	BRK007		FA208X	MXS208	FA208R			MD6126D					
	OSX6184	BRK010	SMX6184H	BRK007		FA208X	MXS208	FA208R			MD6287D					
	OSX6184K	BRK011	SMX6184K	BRK012		FA208X	MXS208	FA208R			MD6287D					

REAR

⚠ This symbol indicates a rotor made of billet steel, and should be only used with EBC FA Organic or Vee pads.
SAFETY NOTICE - With vehicles primarily designed for off highway use such as quads now being used on the highway, we would recommend the use of X or MXS pads for highway use and ONLY using the R and SV higher density / harder pad series for off road riding.

BRAKE APPLICATIONS

*-2 Sets Required. † For Vee disc colours add RED, BLU, GRN, GLD, ORG suffix to part number. **SAFETY WARNING:- DO NOT USE HH PADS ON REAR UNLESS ALSO USED ON FRONT TO AVOID BRAKE IMBALANCE**

FRONT: Non-Japanese Bikes

APPLICATIONS

BRAKE



HUSQVARNA



DISC PAD CHOICES - FRONT

BRAKE ROTOR CHOICES - FRONT

Model	Year	FA/SFA/X Pad or Brake Shoe	Specialty Pads SXR/ VEE/MXS Race	Sintered/ HH Pads/ Grooved Shoes	EPFA Sintered Fast Road/Track Pads	GPFAX Sintered RACE ONLY Pads	SV Series Severe Duty Pads	Standard Rotor		Vintage Rotor / UTV Oversize Brake Kit	Contour Profile Rotor
								Standard Rotor Left	Standard Rotor Right		
WR 250	2002-2005	FA181X	MXS181	FA181R	EPFA181HH			MD6184D			MD6184C
WR 250	2002-2005	FA181X	MXS181	FA181R	EPFA181HH			MD6184D			MD6184C
WR 250	2006-2009	FA181X	MXS181	FA181R	EPFA181HH			MD6184D			MD6184C
WR 250	2006-2009	FA181X	MXS181	FA181R	EPFA181HH			MD6184D			MD6184C
WR 250	2009-2013	FA181X	MXS181	FA181R	EPFA181HH						MD6184C
XC 250	1980-1981			802G							
XC 250	1982-1984			803G							
XC 250	1985-1986	FA47X									
XC 250	1987-1988	FA134X		FA134R							
WR 260	1990-1991	FA134X		FA134R							
TE 300	2014-2019	FA181X	MXS181	FA181R	EPFA181HH			MD6032D			MD6032C
TE 300 TPI	2019-2024	FA181X	MXS181	FA181R	EPFA181HH			MD6032D			MD6032C
TE 300 TPI RockStar	2022	FA181X	MXS181	FA181R	EPFA181HH			MD6032D			MD6032C
TX 300 TPI	2018-2024	FA181X	MXS181	FA181R	EPFA181HH			MD6032D			MD6032C
WR 300	2009-2013	FA181X	MXS181	FA181R	EPFA181HH			MD6184D			MD6184C
TE 310	2009-2010	FA181X	MXS181	FA181R	EPFA181HH			MD6184D			MD6184C
TE 310	2011-2012	FA181X	MXS181	FA181R	EPFA181HH			MD6184D			MD6184C
TE 310	2013	FA181X	MXS181	FA181R	EPFA181HH			MD6184D			MD6184C
TE 310	2009-2010	FA181X	MXS181	FA181R	EPFA181HH			MD6184D			MD6184C
TE 310	2011-2012	FA181X	MXS181	FA181R	EPFA181HH			MD6184D			MD6184C
TXC 310 Cross Country	2012	FA181X	MXS181	FA181R	EPFA181HH			MD6184D			MD6184C
TXC 310 R Cross Country	2013	FA181X	MXS181	FA181R	EPFA181HH			MD6184D			MD6184C
FC 350	2014-2024	FA181X	MXS181	FA181R	EPFA181HH			MD6032D			MD6032C
FE 350	2014-2024	FA181X	MXS181	FA181R	EPFA181HH			MD6032D			MD6032C
FE 350 W	2024	FA181X	MXS181	FA181R	EPFA181HH			MD6032D			MD6032C
FX 350	2018-2024	FA181X	MXS181	FA181R	EPFA181HH			MD6032D			MD6032C
TE 350	1990-1991	FA134X		FA134R							
TE 350	1992-1994	FA135X	MXS135	FA135R				MD6125D			
TE 350	1995-1997	FA181X	MXS181	FA181R	EPFA181HH			MD6125D			
360 Automatic	1975-1977										
CR 360	1975-1978			801G							
CR 360	1992-1994	FA135X	MXS135	FA135R				MD6125D			
WR 360	1975-1978			801G							
WR 360	1992-1994	FA135X	MXS135	FA135R				MD6125D			
WR 360	1995-1999	FA181X	MXS181	FA181R	EPFA181HH			MD6125D			
WR 360 Cross Country	2002	FA181X	MXS181	FA181R	EPFA181HH			MD6184D			MD6184C
WR 360 Cross Country	2000-2001	FA181X	MXS181	FA181R	EPFA181HH			MD6184D			MD6184C
WR 360 Cross Country	2000-2001	FA181X	MXS181	FA181R	EPFA181HH			MD6184D			MD6184C
WR 360 Cross Country	2002	FA181X	MXS181	FA181R	EPFA181HH			MD6184D			MD6184C
ACC 390	1980-1981			801G							
ACCE 390	1980-1981			801G							
CR 390	1975-1979			801G							
CR 390	1980-1981			801G							
CR 390 Automatic	1978			801G							
WR 390	1978			801G							
CR 400	1971-1974			801G							
SM 400 R	2002	FA95		FA95HH	EPFA95HH			MD6293D			
TE 400	2002	FA181X	MXS181	FA181R	EPFA181HH			MD6184D			MD6184C
TE 400	2002	FA181X	MXS181	FA181R	EPFA181HH			MD6184D			MD6184C
WR 400	1975-1978			801G							
WR 400	1987-1988	FA134X		FA134R							
Svartpilen 401	2018-2023	FA606		FA606HH	EPFA606HH						
Vitpilen 401	2018-2023	FA606		FA606HH	EPFA606HH						
TE 410	1995-1999	FA181X	MXS181	FA181R	EPFA181HH			MD6125D			
TE 410	2006	FA181X	MXS181	FA181R	EPFA181HH			MD6184D			MD6184C
TE 410	2006	FA181X	MXS181	FA181R	EPFA181HH			MD6184D			MD6184C

FRONT

Line #

⚠ This symbol indicates a rotor made of billet steel, and should be only used with EBC FA Organic or Vee pads.

SAFETY NOTICE - With vehicles primarily designed for off highway use such as quads now being used on the highway, we would recommend the use of X or MXS pads for highway use and ONLY using the R and SV higher density / harder pad series for off road riding.

*-2 Sets Required. † For Vee disc colours add RED, BLU, GRN, GLD, ORG suffix to part number. SAFETY WARNING:- DO NOT USE HH PADS ON REAR UNLESS ALSO USED ON FRONT TO AVOID BRAKE IMBALANCE

FRONT: Non-Japanese Bikes Cont'd

REAR: Non-Japanese Bikes

Line #	BRAKE ROTOR CHOICES - FRONT					DISC PAD CHOICES - REAR					BRAKE ROTOR CHOICES - REAR					
	CX Extreme® /Vee-Rotor	OSX Series Oversize 280mm Rotor Kit	Relocating Bracket for Oversize Rotor	SMX Series Oversize 320mm Rotor Kit	Relocating Bracket for 320mm Rotor	Front Disc Bolt Kit	FA/SFA/X Pad or Brake Shoe	Specialty Pads SXR/ VEE/MXS Race	Sintered/ HH Pads/ Grooved Shoes	EPFA Sintered Fast Road/ Track Pads	SV Series Severe Duty Pads	Standard Rotor	Vintage Rotor / UTV Oversize Brake Kit	Contour Profile Rotor	CX Extreme® /Vee-Rotor	Rear Disc Bolt Kit
1		OSX6184	BRK010	SMX6184H	BRK007		FA208X	MXS208	FA208R			MD6295D				
2		OSX6184K	BRK011	SMX6184K	BRK012		FA208X	MXS208	FA208R			MD6295D				
3		OSX6184	BRK010	SMX6184H	BRK007		FA208X	MXS208	FA208R			MD6288D		MD6288C		
4		OSX6184K	BRK011	SMX6184K	BRK012		FA208X	MXS208	FA208R			MD6288D		MD6288C		
5		OSX6184K	BRK011	SMX6184K	BRK011		FA208X	MXS208	FA208R							
6								802G								
7								802G								
8								801G								
9								802G								
10							FA251					MD6126D				
11	MD6032CX	OSX6932	BRK013	SMX6032	BRK014	DB603/6	FA368X	MXS368	FA368R	EPFA368HH		MD6035D		MD6035C	MD6035CX	DB603/6
12	MD6032CX					DB603/6	FA368X	MXS368	FA368R	EPFA368HH		MD6035D		MD6035C	MD6035CX	DB603/6
13	MD6032CX					DB603/6	FA368X	MXS368	FA368R	EPFA368HH		MD6035D		MD6035C	MD6035CX	DB603/6
14	MD6032CX	OSX6932	BRK013			DB603/6	FA368X	MXS368	FA368R	EPFA368HH		MD6035D		MD6035C	MD6035CX	DB603/6
15		OSX6184K	BRK011	SMX6184K	BRK011		FA208X	MXS208	FA208R							
16		OSX6184	BRK010	SMX6184H	BRK007		FA368X	MXS368	FA368R	EPFA368HH		MD6288D				
17		OSX6184	BRK010	SMX6184H	BRK007		FA368X	MXS368	FA368R	EPFA368HH		MD6288D				
18		OSX6184K	BRK011	SMX6184K	BRK011		FA368X	MXS368	FA368R	EPFA368HH		MD6288D				
19		OSX6184K	BRK011	SMX6184K	BRK012		FA368X	MXS368	FA368R	EPFA368HH		MD6288D				
20		OSX6184K	BRK011	SMX6184K	BRK012		FA368X	MXS368	FA368R	EPFA368HH		MD6288D				
21		OSX6184	BRK010	SMX6184H	BRK007		FA368X	MXS368	FA368R	EPFA368HH		MD6288D				
22		OSX6184K	BRK011	SMX6184K	BRK011		FA368X	MXS368	FA368R	EPFA368HH		MD6288D				
23	MD6032CX	OSX6932	BRK013	SMX6032	BRK014	DB603/6	FA368X	MXS368	FA368R	EPFA368HH		MD6035D		MD6035C	MD6035CX	DB603/6
24	MD6032CX	OSX6932	BRK013	SMX6032	BRK014	DB603/6	FA368X	MXS368	FA368R	EPFA368HH		MD6035D		MD6035C	MD6035CX	DB603/6
25	MD6032CX	OSX6932	BRK013	SMX6032	BRK014	DB603/6	FA368X	MXS368	FA368R	EPFA368HH		MD6035D		MD6035C	MD6035CX	DB603/6
26	MD6032CX	OSX6932	BRK013			DB603/6	FA368X	MXS368	FA368R	EPFA368HH		MD6035D		MD6035C	MD6035CX	DB603/6
27							FA251					MD6126D				
28							FA84X	MXS84	FA84R			MD6126D				
29		OSX6125	BRK010	SMX6125	BRK007		FA208X	MXS208	FA208R			MD6126D				
30								801G								
31								801G								
32							FA84X	MXS84	FA84R			MD6126D				
33								801G								
34							FA84X	MXS84	FA84R			MD6126D				
35		OSX6125	BRK010	SMX6125	BRK007		FA208X	MXS208	FA208R			MD6126D				
36		OSX6184	BRK010	SMX6184H	BRK007		FA208X	MXS208	FA208R			MD6295D				
37		OSX6184	BRK010	SMX6184H	BRK007		FA208X	MXS208	FA208R			MD6287D				
38		OSX6184K	BRK011	SMX6184K	BRK012		FA208X	MXS208	FA208R			MD6287D				
39		OSX6184K	BRK011	SMX6184K	BRK012		FA208X	MXS208	FA208R			MD6295D				
40								801G								
41								801G								
42								801G								
43								801G								
44								801G								
45								801G								
46								801G								
47							FA208X	MXS208	FA208R			MD6295D				
48		OSX6184	BRK010	SMX6184H	BRK007		FA208X	MXS208	FA208R			MD6295D				
49		OSX6184K	BRK011	SMX6184K	BRK012		FA208X	MXS208	FA208R			MD6295D				
50								801G								
51								802G								
52							FA208X	MXS208	FA208R							
53							FA208X	MXS208	FA208R							
54		OSX6125	BRK010	SMX6125	BRK007		FA208X	MXS208	FA208R			MD6126D				
55		OSX6184	BRK010	SMX6184H	BRK007		FA368X	MXS368	FA368R	EPFA368HH		MD6288D		MD6288C		
56		OSX6184K	BRK011	SMX6184K	BRK012		FA368X	MXS368	FA368R	EPFA368HH		MD6288D		MD6288C		

BRAKE APPLICATIONS
⚠ This symbol indicates a rotor made of billet steel, and should be only used with EBC FA Organic or Vee pads.
SAFETY NOTICE - With vehicles primarily designed for off highway use such as quads now being used on the highway, we would recommend the use of X or MXS pads for highway use and ONLY using the R and SV higher density / harder pad series for off road riding.

*-2 Sets Required. † For Vee disc colours add RED, BLU, GRN, GLD, ORG suffix to part number. **SAFETY WARNING:- DO NOT USE HH PADS ON REAR UNLESS ALSO USED ON FRONT TO AVOID BRAKE IMBALANCE**

FRONT: Non-Japanese Bikes

APPLICATIONS

BRAKE



HUSQVARNA



DISC PAD CHOICES - FRONT

BRAKE ROTOR CHOICES - FRONT

Model	Year	FA/SFA/X Pad or Brake Shoe	Specialty Pads SXR/ VEE/MXS Race	Sintered/ HH Pads/ Grooved Shoes	EPFA Sintered Fast Road/Track Pads	GPFAX Sintered RACE ONLY Pads	SV Series Severe Duty Pads	Standard Rotor		Vintage Rotor / UTV Oversize Brake Kit	Contour Profile Rotor	Line #
								Standard Rotor Left	Standard Rotor Right			
430 Automatic	1987-1988	FA134X		FA134R								1
CR 430	1980-1981			802G								2
CR 430	1987-1988	FA134X		FA134R								3
WR 430	1980-1981			802G								4
WR 430	1987-1988	FA134X		FA134R								5
WR-E 430	1980-1981			802G								6
WR-E 430	1982-1984			803G								7
WRU 430	1982-1984			803G								8
XC 430	1980-1981			802G								9
XC 430	1987-1988	FA134X		FA134R								10
TC 449	2011-2012	FA181X	MXS181	FA181R	EPFA181HH			MD6184D			MD6184C	11
TC 449	2011-2012	FA181X	MXS181	FA181R	EPFA181HH			MD6184D			MD6184C	12
TE 449	2011-2012	FA181X	MXS181	FA181R	EPFA181HH			MD6184D			MD6184C	13
TE 449	2011-2012	FA181X	MXS181	FA181R	EPFA181HH			MD6184D			MD6184C	14
CR 450	1971-1974			801G								15
FC 450	2014-2023	FA181X	MXS181	FA181R	EPFA181HH			MD6032D			MD6032C	16
FC 450 Rockstar Edition	2019-2024	FA181X	MXS181	FA181R	EPFA181HH							17
FE 450	2014-2024	FA181X	MXS181	FA181R	EPFA181HH			MD6032D			MD6032C	18
FR 450 Rally	2020-2023	FA209/2		FA209/2HH								19
FS 450 Supermoto	2014-2023			FA447HH	EPFA447HH							20
FX 450	2018-2024	FA181X	MXS181	FA181R	EPFA181HH			MD6032D			MD6032C	21
SM 450 R	2003-2006	FA95		FA95HH	EPFA95HH			MD6293D				22
SM 450 R	2007-2010			FA322/4HH	EPFA322/4HH			MD6293D				23
SMR 450 RR	2006-2008			FA322/4HH	EPFA322/4HH			MD6293D				24
TC 450	2003	FA181X	MXS181	FA181R	EPFA181HH			MD6184D			MD6184C	25
TC 450	2003	FA181X	MXS181	FA181R	EPFA181HH			MD6184D			MD6184C	26
TC 450	2005-2008	FA181X	MXS181	FA181R	EPFA181HH			MD6184D			MD6184C	27
TC 450	2005-2008	FA181X	MXS181	FA181R	EPFA181HH			MD6184D			MD6184C	28
TC 450	2009-2010	FA181X	MXS181	FA181R	EPFA181HH			MD6184D			MD6184C	29
TC 450	2009-2010	FA181X	MXS181	FA181R	EPFA181HH			MD6184D			MD6184C	30
TE 450	2003-2005	FA181X	MXS181	FA181R	EPFA181HH			MD6184D			MD6184C	31
TE 450	2003-2005	FA181X	MXS181	FA181R	EPFA181HH			MD6184D			MD6184C	32
TE 450	2006-2008	FA181X	MXS181	FA181R	EPFA181HH			MD6184D			MD6184C	33
TE 450	2006-2008	FA181X	MXS181	FA181R	EPFA181HH			MD6184D			MD6184C	34
TE 450	2010	FA181X	MXS181	FA181R	EPFA181HH			MD6184D			MD6184C	35
TE 450	2010	FA181X	MXS181	FA181R	EPFA181HH			MD6184D			MD6184C	36
TXC 450 Cross Country	2008	FA181X	MXS181	FA181R	EPFA181HH			MD6184D			MD6184C	37
TXC 450 Cross Country	2008	FA181X	MXS181	FA181R	EPFA181HH			MD6184D			MD6184C	38
TXC 450 Cross Country	2009-2011	FA181X	MXS181	FA181R	EPFA181HH			MD6184D			MD6184C	39
TXC 450 Cross Country	2009-2011	FA181X	MXS181	FA181R	EPFA181HH			MD6184D			MD6184C	40
WR 450	1971-1972			801G								41
AE 500	1982-1984			803G								42
CR 500	1982-1984			803G								43
CR 500	1985-1986	FA47X										44
CR 500	1987-1988	FA134X		FA134R								45
XC 500	1982-1984			803G								46
XC 500	1985-1986	FA47X										47
XC 500	1987-1988	FA134X		FA134R								48
FC 501	2014	FA181X	MXS181	FA181R	EPFA181HH			MD6032D			MD6032C	49
FE 501	2014-2015	FA181X	MXS181	FA181R	EPFA181HH			MD6032D			MD6032C	50
FE 501 inc S Model	2019-2024	FA181X	MXS181	FA181R				MD6032D				51
FE 501 W	2024	FA181X	MXS181	FA181R				MD6032D				52
SM 510 R	2005	FA95		FA95HH	EPFA95HH			MD6293D				53
SM 510 R	2006-2010			FA322/4HH	EPFA322/4HH			MD6293D				54
TC 510	1987-1988	FA47X										55
TC 510	1989-2019	FA134X		FA134R								56

FRONT

⚠ This symbol indicates a rotor made of billet steel, and should be only used with EBC FA Organic or Vee pads.
SAFETY NOTICE - With vehicles primarily designed for off highway use such as quads now being used on the highway, we would recommend the use of X or MXS pads for highway use and ONLY using the R and SV higher density / harder pad series for off road riding.

*-2 Sets Required. † For Vee disc colours add RED, BLU, GRN, GLD, ORG suffix to part number. SAFETY WARNING:- DO NOT USE HH PADS ON REAR UNLESS ALSO USED ON FRONT TO AVOID BRAKE IMBALANCE

FRONT: Non-Japanese Bikes

APPLICATIONS

BRAKE



HUSQVARNA



DISC PAD CHOICES - FRONT

BRAKE ROTOR CHOICES - FRONT

Model	Year	FA/SFA/X Pad or Brake Shoe	Specialty Pads SXR/VEE/MXS Race	Sintered/HH Pads/Grooved Shoes	EPFA Sintered Fast Road/Track Pads	GPFAX Sintered RACE ONLY Pads	SV Series Severe Duty Pads	Standard Rotor		Vintage Rotor / UTV Oversize Brake Kit	Contour Profile Rotor	Line #
								Standard Rotor Left	Standard Rotor Right			
TC 510	1990	FA134X		FA134R								1
TC 510	2004	FA181X	MXS181	FA181R	EPFA181HH			MD6184D			MD6184C	2
TC 510	2004	FA181X	MXS181	FA181R	EPFA181HH			MD6184D			MD6184C	3
TC 510	2005-2009	FA181X	MXS181	FA181R	EPFA181HH			MD6184D			MD6184C	4
TC 510	2005-2009	FA181X	MXS181	FA181R	EPFA181HH			MD6184D			MD6184C	5
TE 510	1987-1988	FA47X										6
TE 510	1989	FA134X		FA134R								7
TE 510	1990	FA134X		FA134R								8
TE 510	2004-2005	FA181X	MXS181	FA181R	EPFA181HH			MD6184D			MD6184C	9
TE 510	2004-2005	FA181X	MXS181	FA181R	EPFA181HH			MD6184D			MD6184C	10
TE 510	2006-2008	FA181X	MXS181	FA181R	EPFA181HH			MD6184D			MD6184C	11
TE 510	2006-2008	FA181X	MXS181	FA181R	EPFA181HH			MD6184D			MD6184C	12
TE 510	2009-2010	FA181X	MXS181	FA181R	EPFA181HH			MD6184D			MD6184C	13
TE 510	2009-2010	FA181X	MXS181	FA181R	EPFA181HH			MD6184D			MD6184C	14
TX 510	1987-1988	FA47X										15
TXC 510 Cross Country	2009-2010	FA181X	MXS181	FA181R	EPFA181HH			MD6184D			MD6184C	16
TXC 510 Cross Country	2008	FA181X	MXS181	FA181R	EPFA181HH			MD6184D			MD6184C	17
TXC 510 Cross Country	2008	FA181X	MXS181	FA181R	EPFA181HH			MD6184D			MD6184C	18
TXC 510 Cross Country	2009-2010	FA181X	MXS181	FA181R	EPFA181HH			MD6184D			MD6184C	19
WMX 510	1989	FA134X		FA134R								20
WXE 510	1989	FA134X		FA134R								21
TE 511	2011-2012	FA181X	MXS181	FA181R	EPFA181HH			MD6184D			MD6184C	22
TE 511	2011-2012	FA181X	MXS181	FA181R	EPFA181HH			MD6184D			MD6184C	23
TXC 511 Cross Country	2011-2012	FA181X	MXS181	FA181R	EPFA181HH			MD6184D			MD6184C	24
TXC 511 Cross Country	2011-2012	FA181X	MXS181	FA181R	EPFA181HH			MD6184D			MD6184C	25
SM 570 R	2001	FA95		FA95HH	EPFA95HH			MD6293D				26
SM 570 R	2002-2004	FA95		FA95HH	EPFA95HH			MD6293D				27
TC 570	2002-2003	FA181X	MXS181	FA181R	EPFA181HH			MD6184D			MD6184C	28
TC 570	2002-2003	FA181X	MXS181	FA181R	EPFA181HH			MD6184D			MD6184C	29
TE 570	2001	FA181X	MXS181	FA181R	EPFA181HH			MD6184D			MD6184C	30
TE 570	2001	FA181X	MXS181	FA181R	EPFA181HH			MD6184D			MD6184C	31
TE 570	2002-2004	FA181X	MXS181	FA181R	EPFA181HH			MD6184D			MD6184C	32
TE 570	2002-2004	FA181X	MXS181	FA181R	EPFA181HH			MD6184D			MD6184C	33
SM 610	1998-1999	FA244		FA244HH	EPFA244HH			MD6294D				34
SM 610 IE	2007-2009			FA322/4HH	EPFA322/4HH			MD6293D				35
SM 610 S	2002-2006	FA244		FA244HH	EPFA244HH			MD6293D				36
SM 610 S	2006			FA322/4HH	EPFA322/4HH			MD6293D				37
TC 610	1991	FA134X		FA134R								38
TC 610	1992-1994	FA135X	MXS135	FA135R				MD6125D				39
TC 610 /E	1995-1999	FA181X	MXS181	FA181R	EPFA181HH			MD6125D				40
TE 610	1991	FA134X		FA134R								41
TE 610	1992-1994	FA135X	MXS135	FA135R				MD6125D				42
TE 610 E	1995-1999	FA181X	MXS181	FA181R	EPFA181HH			MD6125D				43
TE 610 E	2002-2003	FA181X	MXS181	FA181R	EPFA181HH			MD6184D			MD6184C	44
TE 610 E	2002-2003	FA181X	MXS181	FA181R	EPFA181HH			MD6184D			MD6184C	45
TE 610 IE	2006-2009	FA181X	MXS181	FA181R	EPFA181HH			MD6184D			MD6184C	46
TE 610 IE	2006-2009	FA181X	MXS181	FA181R	EPFA181HH			MD6184D			MD6184C	47
SM 630	2009-2010			FA322/4HH	EPFA322/4HH			MD6293D				48
SMR 630	2006	FA95		FA95HH	EPFA95HH			MD6293D				49
SMS 630	2010-2011			FA322/4HH	EPFA322/4HH			MD6293D				50
TE 630	2010	FA181X	MXS181	FA181R	EPFA181HH			MD6184D			MD6184C	51
TE 630	2010	FA181X	MXS181	FA181R	EPFA181HH			MD6184D			MD6184C	52
STR 650 CRC	2007			FA322/4HH	EPFA322/4HH			MD6293D				53
TR 650 Strada	2013	FA209/2	FA209/2V	FA209/2HH				MD834				54
TR 650 Terra	2013	FA209/2	FA209/2V	FA209/2HH				MD834				55
701 Enduro	2016-2024	FA209/2	FA209/2V	FA209/2HH				MD844X			MD844XC	56

FRONT

⚠ This symbol indicates a rotor made of billet steel, and should be only used with EBC FA Organic or Vee pads. SAFETY NOTICE - With vehicles primarily designed for off highway use such as quads now being used on the highway, we would recommend the use of X or MXS pads for highway use and ONLY using the R and SV higher density / harder pad series for off road riding.

*-2 Sets Required. † For Vee disc colours add RED, BLU, GRN, GLD, ORG suffix to part number. SAFETY WARNING:- DO NOT USE HH PADS ON REAR UNLESS ALSO USED ON FRONT TO AVOID BRAKE IMBALANCE

FRONT: Non-Japanese Bikes Cont'd

REAR: Non-Japanese Bikes

Line #	BRAKE ROTOR CHOICES - FRONT					REAR	DISC PAD CHOICES - REAR					BRAKE ROTOR CHOICES - REAR				
	CX Extreme® /Vee-Rotor	OSX Series Oversize 280mm Rotor Kit	Relocating Bracket for Oversize Rotor	SMX Series Oversize 320mm Rotor Kit	Relocating Bracket for 320mm Rotor		Front Disc Bolt Kit	FA/SFA/X Pad or Brake Shoe	Specialty Pads SXR/ VEE/MXS Race	Sintered/ HH Pads/ Grooved Shoes	EPFA Sintered Fast Road/ Track Pads	SV Series Severe Duty Pads	Standard Rotor	Vintage Rotor / UTV Oversize Brake Kit	Contour Profile Rotor	CX Extreme® /Vee-Rotor
1							FA251					MD6126D				
2		OSX6184	BRK010	SMX6184H	BRK007		FA208X	MXS208	FA208R			MD6295D				
3		OSX6184K	BRK011	SMX6184K	BRK012		FA208X	MXS208	FA208R			MD6295D				
4		OSX6184	BRK010	SMX6184H	BRK007		FA368X	MXS368	FA368R	EPFA368HH		MD6288D		MD6288C		
5		OSX6184K	BRK011	SMX6184K	BRK012		FA368X	MXS368	FA368R	EPFA368HH		MD6288D		MD6288C		
6								801G								
7								801G								
8							FA251					MD6126D				
9		OSX6184	BRK010	SMX6184H	BRK007		FA208X	MXS208	FA208R			MD6295D				
10		OSX6184K	BRK011	SMX6184K	BRK012		FA208X	MXS208	FA208R			MD6295D				
11		OSX6184	BRK010	SMX6184H	BRK007		FA368X	MXS368	FA368R	EPFA368HH		MD6288D		MD6288C		
12		OSX6184K	BRK011	SMX6184K	BRK012		FA368X	MXS368	FA368R	EPFA368HH		MD6288D		MD6288C		
13		OSX6184	BRK010	SMX6184H	BRK007		FA368X	MXS368	FA368R	EPFA368HH						
14		OSX6184K	BRK011	SMX6184K	BRK012		FA368X	MXS368	FA368R	EPFA368HH						
15								801G								
16		OSX6184K	BRK011	SMX6184K	BRK012		FA368X	MXS368	FA368R	EPFA368HH						
17				SMX6184H	BRK007		FA368X	MXS368	FA368R	EPFA368HH		MD6288D		MD6288C		
18		OSX6184K	BRK011	SMX6184K	BRK012		FA368X	MXS368	FA368R	EPFA368HH		MD6288D		MD6288C		
19				SMX6184H	BRK007		FA368X	MXS368	FA368R	EPFA368HH						
20								801G								
21								801G								
22		OSX6184	BRK010	SMX6184H	BRK007		FA368X	MXS368	FA368R	EPFA368HH						
23		OSX6184K	BRK011	SMX6184K	BRK012		FA368X	MXS368	FA368R	EPFA368HH						
24				SMX6184H	BRK007		FA368X	MXS368	FA368R	EPFA368HH						
25		OSX6184K	BRK011	SMX6184K	BRK012		FA368X	MXS368	FA368R	EPFA368HH						
26							FA208X	MXS208	FA208R			MD6287D				
27							FA208X	MXS208	FA208R			MD6295D				
28				SMX6184H	BRK007		FA208X	MXS208	FA208R			MD6295D				
29		OSX6184K	BRK011	SMX6184K	BRK012		FA208X	MXS208	FA208R			MD6295D				
30				SMX6184H	BRK007		FA208X	MXS208	FA208R			MD6287D				
31		OSX6184K	BRK011	SMX6184K	BRK012		FA208X	MXS208	FA208R			MD6287D				
32				SMX6184H	BRK007		FA208X	MXS208	FA208R			MD6287D				
33		OSX6184K	BRK011	SMX6184K	BRK012		FA208X	MXS208	FA208R			MD6287D				
34							FA208X	MXS208	FA208R			MD6126D				
35							FA208X	MXS208	FA208R			MD6295D				
36							FA208X	MXS208	FA208R			MD6287D				
37							FA208X	MXS208	FA208R			MD6288D				
38							FA251					MD6126D				
39							FA84X	MXS84	FA84R			MD6126D				
40		OSX6125	BRK010	SMX6125	BRK007		FA208X	MXS208	FA208R			MD6126D				
41							FA251					MD6126D				
42							FA84X	MXS84	FA84R			MD6126D				
43		OSX6125	BRK010	SMX6125	BRK007		FA208X	MXS208	FA208R			MD6126D				
44				SMX6184H	BRK007		FA208X	MXS208	FA208R			MD6287D				
45		OSX6184K	BRK011	SMX6184K	BRK012		FA208X	MXS208	FA208R			MD6287D				
46		OSX6184K	BRK011	SMX6184K	BRK012		FA208X	MXS208	FA208R			MD6287D				
47				SMX6184H	BRK007		FA208X	MXS208	FA208R			MD6287D				
48							FA208X	MXS208	FA208R			MD6295D				
49							FA208X	MXS208	FA208R			MD6295D				
50							FA208X	MXS208	FA208R			MD6295D				
51				SMX6184H	BRK007		FA208X	MXS208	FA208R			MD6295D				
52		OSX6184K	BRK011	SMX6184K	BRK012		FA208X	MXS208	FA208R			MD6295D				
53							FA208X	MXS208	FA208R			MD6295D				
54							FA213		FA213HH			MD671				
55							FA213		FA213HH			MD671				
56							FA208X	MXS208	FA208R					MD6417C		

BRAKE APPLICATIONS
⚠ This symbol indicates a rotor made of billet steel, and should be only used with EBC FA Organic or Vee pads.
SAFETY NOTICE - With vehicles primarily designed for off highway use such as quads now being used on the highway, we would recommend the use of X or MXS pads for highway use and ONLY using the R and SV higher density / harder pad series for off road riding.

*-2 Sets Required. † For Vee disc colours add RED, BLU, GRN, GLD, ORG suffix to part number. **SAFETY WARNING:- DO NOT USE HH PADS ON REAR UNLESS ALSO USED ON FRONT TO AVOID BRAKE IMBALANCE**

FRONT: Non-Japanese Bikes

APPLICATIONS
BRAKE



HUSQVARNA



701 Supermoto		2018-2024
701 Svartpilen		2018-2021
701 Vitpilen		2018-2021
900 Nuda		2012-2013
900 Nuda R		2012-2013

MD6035D ● SOLID ROTOR MD6035CE FOR ENDURO USE, REAR FITMENTS

HYOSUNG

SB 50 M		2006-2008
SD 50 Sense		2006-2012
SF 50 B Prima		2006-2012
SF 50 Rally		2006-2012
TE 50		2005-2008
TE 90		2005-2008
TE 100		2005-2008
MS3 125		2006-2007
RX 125		2006-2008
GT 250		2006-2012
GT 250 R		2006-2012
GV 250		2006-2012
MS3 250		2006-2012
TE 450 S		2007-2012
GT 650		2006-2012
GT 650 R		2006-2012
GT 650 S		2006-2012
GV 650		2006-2012
ST7 Custom		2010-2011

ITALJET

Dragster 50 LC		1998-2003
Formula 50		1996-2003
Formula 50		1999-2003
Jet Set 50		2003
Torpedo 50		1998-2004
Velocifero 50		1998-2003
Formula 125		1996-2003
Torpedo 125		1999-2004
Jet Set 125/150		2003
Torpedo 150		2003

JOHN DEERE UTV & ATV

Buck 500/650 EX/EXT	Left	2004-2008
	Right	
Trail Buck 500/650 EX/EXT	Left	2004-2005
	Right	
XUV 620i - Gator		2010
XUV 625i - Gator		2011
XUV 825i - Gator		2011
XUV 850 D - Gator		2010
4PX Gator 4x2/4 x 4 4 x 4 Trail 9345		2004-2005
HPX 4 x 4 - Gator		2010
HPX 4 x 4 - Gator		2010-2011
HPX 4 x 4/4 x 4 Trail Gator		2010-2011
HPX 4x2 Gator		2010-2011
HPX Gator 4x2/4 x 4 9446		2004-2008
TX Gator Utility 9461		2004-2005

DISC PAD CHOICES - FRONT

BRAKE ROTOR CHOICES - FRONT

FA/SFA/X Pad or Brake Shoe	Specialty Pads SXR/ VEE/MXS Race	Sintered/ HH Pads/ Grooved Shoes	EPFA Sintered Fast Road/Track Pads	GPFAX Sintered RACE ONLY Pads	SV Series Severe Duty Pads	Standard Rotor Left	Standard Rotor Right	Vintage Rotor / UTV Oversize Brake Kit	Contour Profile Rotor
		FA322/4HH	EPFA322/4HH			MD6414D			
FA244		FA244HH	EPFA244HH						
FA244		FA244HH	EPFA244HH						
FA244*		FA244HH*	EPFA244HH*						
		FA447HH*	EPFA447HH*						
SFA83		SFA83HH							
SFA83		SFA83HH							
SFA83		SFA83HH							
SFA83		SFA83HH							
938*									
938*									
938*									
SFA86*		SFA86HH*							
FA86		FA86HH				MD690			MD690C
FA86*		FA86HH*				MD690	MD690		MD690C*
FA86		FA86HH							
SFA86*		SFA86HH*							
FA54X*	MXS54*	FA54R*							
FA86*		FA86HH*				MD690	MD690		MD690C*
FA86*		FA86HH*				MD690	MD690		MD690C*
FA86*		FA86HH*				MD690	MD690		MD690C*
FA86*		FA86HH*				MD691	MD691		
		FA296HH							
SFA115		SFA115HH				MD941D			
SFA115		SFA115HH				MD941D			
SFA115		SFA115HH				MD941D			
SFA350		SFA350HH							
SFA115		SFA115HH				MD951D			
350									
SFA115		SFA115HH				MD941D			
SFA115		SFA115HH				MD951D			
SFA350		SFA350HH							
SFA115		SFA115HH				MD951D			
FA307X	SXR307HH	FA307R			FA307SV	MD6245D			
FA317X	SXR317HH	FA317R			FA317SV		MD6245D		
FA307X	SXR307HH	FA307R			FA307SV	MD6245D			
FA317X	SXR317HH	FA317R			FA317SV		MD6245D		
		FA609R*							
		FA610R*							
		FA610R*							
		FA609R*							
		FA398R*			FA398SV*				
		FA398R*			FA398SV*				
		FA609R*							
		FA398R*			FA398SV*				
		FA398R*			FA398SV*				
		FA398R*			FA398SV*				
		FA398R*			FA398SV*				
		FA398R*			FA398SV*				

Line #
1
2
3
4
5
6
7
8
9
10
11
12
13
14
15
16
17
18
19
20
21
22
23
24
25
26
27
28
29
30
31
32
33
34
35
36
37
38
39
40
41
42
43
44
45
46
47
48
49
50
51
52
53
54
55
56

* This symbol indicates a rotor made of billet steel, and should be only used with EBC FA Organic or Vee pads.
 SAFETY NOTICE - With vehicles primarily designed for off highway use such as quads now being used on the highway, we would recommend the use of X or MXS pads for highway use and ONLY using the R and SV higher density / harder pad series for off road riding.

*-2 Sets Required. † For Vee disc colours add RED, BLU, GRN, GLD, ORG suffix to part number. **SAFETY WARNING:- DO NOT USE HH PADS ON REAR UNLESS ALSO USED ON FRONT TO AVOID BRAKE IMBALANCE**

FRONT: Non-Japanese Bikes Cont'd

REAR: Non-Japanese Bikes

Line #	BRAKE ROTOR CHOICES - FRONT					REAR	DISC PAD CHOICES - REAR					BRAKE ROTOR CHOICES - REAR				
	CX Extreme® /Vee-Rotor	OSX Series Oversize 280mm Rotor Kit	Relocating Bracket for Oversize Rotor	SMX Series Oversize 320mm Rotor Kit	Relocating Bracket for 320mm Rotor		Front Disc Bolt Kit	FA/SFA/X Pad or Brake Shoe	Specialty Pads SXR/ VEE/MXS Race	Sintered/ HH Pads/ Grooved Shoes	EPFA Sintered Fast Road/ Track Pads	SV Series Severe Duty Pads	Standard Rotor	Vintage Rotor / UTV Oversize Brake Kit	Contour Profile Rotor	CX Extreme® /Vee-Rotor
1							FA208X	MXS208	FA208R			MD6415D		MD6415C		
2							FA208X	MXS208	FA208R							
3							FA208X	MXS208	FA208R							
4							FA213		FA213HH			MD671				
5							FA213		FA213HH			MD671				
6																
7																
8																
9																
10																
11																
12																
13												MD6301D				
14												MD6301D				
15												MD6301D				
16							SFA86		SFA86HH							
17							602									
18							FA86		FA86HH			MD689		MD689C		
19							FA86		FA86HH			MD689		MD689C		
20							606		606G							
21							SFA86		SFA86HH							
22							FA54X	MXS54	FA54R							
23							FA86		FA86HH			MD689		MD689C		
24							FA86		FA86HH			MD689		MD689C		
25							FA86		FA86HH			MD689		MD689C		
26							FA86		FA86HH							
27							FA86		FA86HH							
28																
29																
30							SFA115		SFA115HH			MD948D				
31							SFA115		SFA115HH			MD950D				
32							624									
33																
34							624									
35							624									
36							SFA115		SFA115HH			MD950D				
37							816									
38							DB201/6									
39							DB201/6									
40							DB201/6									
41																
42							DB201/6									
43							FA317X		FA317R		FA317SV	MD6225D				
44							DB201/6									
45							FA317X		FA317R		FA317SV	MD6225D				
46									FA609R*							
47									FA609R*							
48									FA609R*							
49									FA609R*							
50									FA398R*		FA398SV*					
51									FA398R*		FA398SV*					
52									FA609R*							
53									FA398R*		FA398SV*					
54									FA398R*		FA398SV*					
55									FA398R*		FA398SV*					
56									FA398R*		FA398SV*					

⚠ This symbol indicates a rotor made of billet steel, and should be only used with EBC FA Organic or Vee pads.
SAFETY NOTICE - With vehicles primarily designed for off highway use such as quads now being used on the highway, we would recommend the use of X or MXS pads for highway use and ONLY using the R and SV higher density / harder pad series for off road riding.

*-2 Sets Required. † For Vee disc colours add RED, BLU, GRN, GLD, ORG suffix to part number. **SAFETY WARNING:- DO NOT USE HH PADS ON REAR UNLESS ALSO USED ON FRONT TO AVOID BRAKE IMBALANCE**

FRONT: Non-Japanese Bikes

APPLICATIONS

BRAKE



JOHN DEERE UTV & ATV



TX Turf Gator 9462	2004-2005
XUV 855 D - Gator	2011
HPX 4x2 Gator	2010-2011

KAYO

K2 230	2023
--------	------

KIOTI/MECHRON

2200 UTV Side x Side	2009-2014
----------------------	-----------

KTM

SX-E 3 Electric	2022-2024
SX-E 5 Electric	2020-2024
Freeride E-XC Electric	2019-2023
Supermoto 50	2006
SX 50	2008-2023
SX 50 Factory Edition	2022-2023
SX 50 Junior LC	2007-2009
SX 50 Mini	2009-2023
SX 50 Mini Adventure	2004-2007
SX 50 Pro Senior LC	2002-2003
SX 50 Pro Senior LC	2004-2007
SX 50 Pro Senior LC/Mini Senior Adventure	2002-2007
SX/SXR 50 Pro Junior/Senior/Adventure	1996-2003
SX 60	1998-2000
SX 65	1998-1999
SX 65	2000-2001
SX 65	2002-2003
SX 65	2004-2008
SX 65	2009-2022
SX 65	2023-2024
XC 65	2008-2010
MX 80	1986-1992
SX 85	2003-2010
SX 85	2003-2010
SX 85	2011
SX 85	2011
SX 85	2012-2020
SX 85	2012-2020
SX 85	2021-2024
SX 85	2021-2024
XC 85	2008-2009
SX 105	2007-2011
XC 105	2008-2009
125 D-XC/E-XC/E-GS	1990-1991
125 D-XC/E-XC/E-GS	1990-1991
125 D-XC/E-XC/E-GS	1992-1993
125 D-XC/E-XC/E-GS	1992-1993
125 XC	2020-2024
EXC 125	1987
EXC 125	1988
EXC 125	1989
EXC 125	1989
EXC 125	1995-1999
EXC 125	2000-2003
EXC 125	2004-2008

FA/SFA/X Pad or Brake Shoe	DISC PAD CHOICES - FRONT					BRAKE ROTOR CHOICES - FRONT				Line #
	Specialty Pads SXR/VEE/MXS Race	Sintered/HH Pads/Grooved Shoes	EPFA Sintered Fast Road/Track Pads	GPFAX Sintered RACE ONLY Pads	SV Series Severe Duty Pads	Standard Rotor Left	Standard Rotor Right	Vintage Rotor / UTV Oversize Brake Kit	Contour Profile Rotor	
		FA398R*			FA398SV*					1
		FA610R*								2
		FA398R*			FA398SV*					3
										4
FA622X		FA622R								5
										6
										7
FA622X*		FA622R*			FA622SV*					8
										9
										10
FA325X		FA325R								11
FA325X		FA325R								12
FA357X		FA357R							MD6426C	13
FA325X		FA325R								14
FA325X		FA325R								15
FA325X		FA325R								16
FA325X		FA325R								17
FA325X		FA325R								18
FA325X		FA325R								19
FA325X		FA325R								20
FA325X		FA325R								21
FA325X		FA325R								22
FA325X		FA325R								23
										24
FA115X	MXS115	FA115R				MD6192D			MD6192C	25
FA115X	MXS115	FA115R				MD6192D			MD6192C	26
FA115X	MXS115	FA115R				MD6192D			MD6192C	27
FA357X		FA357R				MD6192D			MD6192C	28
FA357X		FA357R							MD6243C	29
FA357X		FA357R							MD6243C	30
FA368X	MXS368	FA368R							MD6243C	31
FA357X		FA357R							MD6243C	32
FA47/2X										33
FA357X		FA357R							MD6258C	34
FA357X		FA357R							MD6258C	35
FA357X		FA357R							MD6258C	36
FA357X		FA357R							MD6258C	37
FA612X		FA612R							MD6407C	38
FA612X		FA612R							MD6407C	39
FA181X	MXS181	FA181R							MD6379C	40
FA181X	MXS181	FA181R							MD6379C	41
FA357X		FA357R							MD6258C	42
FA357X		FA357R							MD6258C	43
FA357X		FA357R							MD6258C	44
FA67X		FA67R				MD6034D				45
FA132X		FA132R				MD6034D				46
FA181X	MXS181	FA181R	EPFA181HH			MD6034D				47
FA132X		FA132R				MD6034D				48
FA181X	MXS181	FA181R	EPFA181HH			MD6032D				49
FA126X										50
FA132X		FA132R								51
FA67X		FA67R				MD6034D				52
FA132X		FA132R				MD6034D				53
FA181X	MXS181	FA181R	EPFA181HH			MD6032D				54
FA181X	MXS181	FA181R	EPFA181HH			MD6032D				55
FA181X	MXS181	FA181R	EPFA181HH			MD6032D				56

FRONT

⚠ This symbol indicates a rotor made of billet steel, and should be only used with EBC FA Organic or Vee pads. SAFETY NOTICE - With vehicles primarily designed for off highway use such as quads now being used on the highway, we would recommend the use of X or MXS pads for highway use and ONLY using the R and SV higher density / harder pad series for off road riding.

*-2 Sets Required. † For Vee disc colours add RED, BLU, GRN, GLD, ORG suffix to part number. SAFETY WARNING:- DO NOT USE HH PADS ON REAR UNLESS ALSO USED ON FRONT TO AVOID BRAKE IMBALANCE

FRONT: Non-Japanese Bikes Cont'd

REAR: Non-Japanese Bikes

Line #	BRAKE ROTOR CHOICES - FRONT					DISC PAD CHOICES - REAR					BRAKE ROTOR CHOICES - REAR				
	CX Extreme® /Vee-Rotor	OSX Series Oversize 280mm Rotor Kit	Relocating Bracket for Oversize Rotor	SMX Series Oversize 320mm Rotor Kit	Relocating Bracket for 320mm Rotor	Front Disc Bolt Kit	FA/SFA/X Pad or Brake Shoe	Specialty Pads SXR/ VEE/MXS Race	Sintered/ HH Pads/ Grooved Shoes	EPFA Sintered Fast Road/ Track Pads	SV Series Severe Duty Pads	Standard Rotor	Vintage Rotor / UTV Oversize Brake Kit	Contour Profile Rotor	CX Extreme® /Vee-Rotor
1								FA398R*		FA398SV*					
2								FA609R*							
3								FA398R*		FA398SV*					
4															
5															
6							FA346X	FA346R							
7															
8															
9							FA622X*	FA622R*		FA622SV*					
10															
11															
12							FA325X	FA325R							
13							FA325X	FA325R							
14							FA602X	FA602R							
15							FA325X	FA325R							
16							FA325X	FA325R							
17							FA325X	FA325R							
18															
19							FA325X	FA325R							
20															
21															
22							FA325X	FA325R							
23															
24															
25							873								
26							873								
27							FA337X	FA337R			MD6216D				
28							FA337X	FA337R			MD6216D				
29	MD6243CX						FA325X	FA325R				MD6249C	MD6249CX		
30	MD6243CX						FA357X	FA357R				MD6249C	MD6249CX		
31	MD6243CX						FA368X	MXS368	FA368R						
32	MD6243CX						FA357X	FA357R				MD6249C	MD6249CX		
33								814G							
34		OSX6258	BRK028				FA357X	FA357R				MD6257C			
35		OSX6258	BRK028				FA357X	FA357R				MD6257C			
36		OSX6258	BRK028				FA602X	FA602R				MD6360C			
37		OSX6258	BRK028				FA602X	FA602R				MD6360C			
38		OSX6407	BRK027				FA602X	FA602R				MD6360C			
39		OSX6407	BRK027				FA602X	FA602R				MD6360C			
40		TBC	TBC				FA368X	MXS368	FA368R		MD6035D●	MD6035C	MD6035CX	DB603/6	
41		TBC	TBC				FA368X	MXS368	FA368R		MD6035D●	MD6035C	MD6035CX	DB603/6	
42		OSX6258	BRK028				FA357X	FA357R				MD6257C			
43		OSX6258	BRK028				FA357X	FA357R				MD6257C			
44		OSX6258	BRK028				FA357X	FA357R				MD6257C			
45							FA67X	FA67R							
46							FA132X	FA132R							
47							FA67X	FA67R							
48							FA67X	FA67R							
49	MD6032CX	OSX6932	BRK013	SMX6932	BRK014	DB603/6	FA368X	MXS368	FA368R		MD6035D●	MD6035C	MD6035CX	DB603/6	
50							FA126X								
51							FA132X	FA132R			MD6227D				
52							FA67X	FA67R			MD6227D				
53							FA132X	FA132R			MD6227D				
54	MD6032CX	OSX6032E	BRK015	SMX6032E	BRK016	DB603/6	FA208X	MXS208	FA208R		MD6035D●	MD6035C	MD6035CX	DB603/6	
55	MD6032CX	OSX6032	BRK011	SMX6032	BRK012	DB603/6	FA208X	MXS208	FA208R		MD6035D●	MD6035C	MD6035CX	DB603/6	
56	MD6032CX	OSX6032	BRK011	SMX6032	BRK012	DB603/6	FA368X	MXS368	FA368R	EPFA368HH	MD6035D●	MD6035C	MD6035CX	DB603/6	

BRAKE APPLICATIONS
 ● This symbol indicates a rotor made of billet steel, and should be only used with EBC FA Organic or Vee pads.
 SAFETY NOTICE - With vehicles primarily designed for off highway use such as quads now being used on the highway, we would recommend the use of X or MXS pads for highway use and ONLY using the R and SV higher density / harder pad series for off road riding.

*-2 Sets Required. † For Vee disc colours add RED, BLU, GRN, GLD, ORG suffix to part number. **SAFETY WARNING:- DO NOT USE HH PADS ON REAR UNLESS ALSO USED ON FRONT TO AVOID BRAKE IMBALANCE**

FRONT: Non-Japanese Bikes

APPLICATIONS

BRAKE



KTM



DISC PAD CHOICES - FRONT

BRAKE ROTOR CHOICES - FRONT

Model	Year	DISC PAD CHOICES - FRONT						BRAKE ROTOR CHOICES - FRONT				Line #	
		FA/SFA/X Pad or Brake Shoe	Specialty Pads SXR/ VEE/MXS Race	Sintered/ HH Pads/ Grooved Shoes	EPFA Sintered Fast Road/Track Pads	GPFAX Sintered RACE ONLY Pads	SV Series Severe Duty Pads	Standard Rotor Left	Standard Rotor Right	Vintage Rotor / UTV Oversize Brake Kit	Contour Profile Rotor		
EXC/EGS 125	1994	FA181X	MXS181	FA181R	EPFA181HH					MD6032D			1
GSXC/GS 125	1985	FA47X											2
LC2 125	1996-1998	FA181X	MXS181	FA181R	EPFA181HH								3
MX 125	1983			811G									4
MX 125	1984			814G									5
MX 125	1987	FA126X											6
MX 125	1988	FA132X		FA132R									7
MX 125	1989	FA67X		FA67R									8
MX 125	1989	FA132X		FA132R									9
MX 125	1990-1991	FA67X		FA67R									10
MX 125	1990-1991	FA132X		FA132R									11
MX 125	1992-1993	FA181X	MXS181	FA181R	EPFA181HH					MD6032D			12
MX 125	1992-1993	FA132X		FA132R						MD6032D			13
MX/MXC 125	1985	FA47X											14
MX/MXC/GS 125	1986	FA47X											15
Sting 125	1997-1999	FA95		FA95HH	EPFA95HH								16
SX 125	1994-1999	FA181X	MXS181	FA181R	EPFA181HH					MD6032D			17
SX 125	2000-2003	FA181X	MXS181	FA181R	EPFA181HH					MD6032D			18
SX 125	2004-2008	FA181X	MXS181	FA181R	EPFA181HH					MD6032D			19
SX 125	2009-2024	FA181X	MXS181	FA181R	EPFA181HH					MD6032D			20
XC 125	2023-2024	FA181X	MXS181	FA181R	EPFA181HH					MD6032D			21
150 EXC Tpi 2T	2022-2023	FA181X	MXS181	FA181R	EPFA181HH					MD6032D			22
SX 150	2008	FA181X	MXS181	FA181R	EPFA181HH					MD6032D			23
SX 150	2009-2022	FA181X	MXS181	FA181R	EPFA181HH					MD6032D			24
XC 150	2010-2019	FA181X	MXS181	FA181R	EPFA181HH					MD6032D			25
XC-W 150 TPI	2020-2024	FA181X	MXS181	FA181R						MD6032D			26
200 Duke	2021-2022	FA606		FA606HH						MD8009			27
EXC/EGS 200	1998-1999	FA181X	MXS181	FA181R	EPFA181HH					MD6032D			28
EXC/EGS 200	2000-2003	FA181X	MXS181	FA181R	EPFA181HH					MD6032D			29
XC 200	2006-2009	FA181X	MXS181	FA181R	EPFA181HH					MD6032D			30
XC/EXC 200	2004-2008	FA181X	MXS181	FA181R	EPFA181HH					MD6032D			31
XC-W 200	2007-2009	FA181X	MXS181	FA181R	EPFA181HH					MD6032D			32
XC-W 200	2010-2016	FA181X	MXS181	FA181R	EPFA181HH					MD6032D			33
250 R Freeride	2015-2021	FA612X		FA612R									34
DXC/EXC 250	1990	FA132X		FA132R						MD6034D			35
D-XC/E-XC/E-GS 250	1991	FA67X		FA67R						MD6034D			36
D-XC/E-XC/E-GS 250	1991	FA132X		FA132R						MD6034D			37
D-XC/E-XC/T-XC/E-GS 250	1992-1993	FA132X		FA132R						MD6032D			38
EXC 250	1995-1999	FA181X	MXS181	FA181R	EPFA181HH					MD6032D			39
EXC 250	2000-2003	FA181X	MXS181	FA181R	EPFA181HH					MD6032D			40
EXC 250	2004-2007	FA181X	MXS181	FA181R	EPFA181HH					MD6032D			41
EXC/EGS 250	1988	FA132X		FA132R									42
EXC/EGS 250	1989	FA67X		FA67R						MD6034D			43
EXC/EGS 250	1989	FA132X		FA132R						MD6034D			44
EXC/EGS 250	1994	FA181X	MXS181	FA181R	EPFA181HH					MD6032D			45
EXC-F 250	2006-2007	FA181X	MXS181	FA181R	EPFA181HH					MD6032D			46
EXC-F 250	2018-2022	FA181X	MXS181	FA181R	EPFA181HH					MD6032D			47
GS 250	1986	FA47X											48
GSXC/GS 250	1985	FA47X											49
MX 250	1988	FA132X		FA132R									50
MX 250	1989	FA132X		FA132R									51
MX 250	1989	FA67X		FA67R									52
MX 250	1990	FA67X		FA67R									53
MX 250	1991	FA67X		FA67R									54
MX 250	1991	FA132X		FA132R									55
MX 250	1992-1993	FA181X	MXS181	FA181R	EPFA181HH					MD6032D			56

FRONT

⚠ This symbol indicates a rotor made of billet steel, and should be only used with EBC FA Organic or Vee pads. SAFETY NOTICE - With vehicles primarily designed for off highway use such as quads now being used on the highway, we would recommend the use of X or MXS pads for highway use and ONLY using the R and SV higher density / harder pad series for off road riding.

*-2 Sets Required. † For Vee disc colours add RED, BLU, GRN, GLD, ORG suffix to part number. SAFETY WARNING:- DO NOT USE HH PADS ON REAR UNLESS ALSO USED ON FRONT TO AVOID BRAKE IMBALANCE

FRONT: Non-Japanese Bikes Cont'd

REAR: Non-Japanese Bikes

Line #

BRAKE ROTOR CHOICES - FRONT						DISC PAD CHOICES - REAR						BRAKE ROTOR CHOICES - REAR				
CX Extreme® /Vee-Rotor	OSX Series Oversize 280mm Rotor Kit	Relocating Bracket for Oversize Rotor	SMX Series Oversize 320mm Rotor Kit	Relocating Bracket for 320mm Rotor	Front Disc Bolt Kit	FA/SFA/X Pad or Brake Shoe	Specialty Pads SXR/ VEE/MXS Race	Sintered/ HH Pads/ Grooved Shoes	EPFA Sintered Fast Road/ Track Pads	SV Series Severe Duty Pads	Standard Rotor	Vintage Rotor / UTV Oversize Brake Kit	Contour Profile Rotor	CX Extreme® /Vee-Rotor	Rear Disc Bolt Kit	
1	MD6032CX	OSX6032E	BRK015	SMX6032E	BRK016	DB603/6	FA208X	MXS208	FA208R			MD6035D		MD6035C	MD6035CX	DB603/6
2								814G								
3							FA208X	MXS208	FA208R							
4								812G								
5								814G								
6							FA126X									
7							FA132X		FA132R			MD6227D				
8							FA67X		FA67R			MD6227D				
9							FA132X		FA132R			MD6227D				
10							FA67X		FA67R							
11							FA132X		FA132R							
12	MD6032CX	OSX6032E	BRK015	SMX6032E	BRK016	DB603/6	FA67X		FA67R							
13						DB603/6	FA67X		FA67R							
14								814G								
15							FA47X		FA47R			MD6227D				
16							FA208X		FA208R							
17	MD6032CX	OSX6032E	BRK015	SMX6032E	BRK016	DB603/6	FA208X	MXS208	FA208R			MD6035D		MD6035C	MD6035CX	DB603/6
18	MD6032CX	OSX6032	BRK011	SMX6032	BRK012	DB603/6	FA208X	MXS208	FA208R			MD6035D		MD6035C	MD6035CX	DB603/6
19	MD6032CX	OSX6032	BRK011	SMX6032	BRK012	DB603/6	FA368X	MXS368	FA368R	EPFA368HH		MD6035D		MD6035C	MD6035CX	DB603/6
20	MD6032CX	OSX6932	BRK013	SMX6932	BRK014	DB603/6	FA368X	MXS368	FA368R			MD6035D		MD6035C	MD6035CX	DB603/6
21	MD6032CX	OSX6932	BRK013	SMX6932	BRK014	DB603/6	FA368X	MXS368	FA368R	EPFA368HH		MD6035D		MD6035C	MD6035CX	DB603/6
22	MD6032CX	OSX6932	BRK013			DB603/6	FA368X	MXS368	FA368R	EPFA368HH		MD6035D		MD6035C	MD6035CX	DB603/6
23	MD6032CX	OSX6032	BRK011	SMX6032	BRK012	DB603/6	FA368X	MXS368	FA368R	EPFA368HH		MD6035D		MD6035C	MD6035CX	DB603/6
24	MD6032CX	OSX6932	BRK013	SMX6932	BRK014	DB603/6	FA368X	MXS368	FA368R			MD6035D		MD6035C	MD6035CX	DB603/6
25	MD6032CX	OSX6932	BRK013	SMX6932	BRK014	DB603/6	FA368X	MXS368	FA368R	EPFA368HH		MD6035D		MD6035C	MD6035CX	DB603/6
26	MD6032CX					DB603/6	FA368X	MXS368	FA368R			MD6035D		MD6035C	MD6035CX	DB603/6
27							FA213		FA213HH			MD850				
28	MD6032CX	OSX6032E	BRK015	SMX6032E	BRK016	DB603/6	FA208X	MXS208	FA208R			MD6035D		MD6035C	MD6035CX	DB603/6
29	MD6032CX	OSX6032	BRK011	SMX6032	BRK012	DB603/6	FA208X	MXS208	FA208R			MD6035D		MD6035C	MD6035CX	DB603/6
30	MD6032CX	OSX6032	BRK011	SMX6032	BRK012	DB603/6	FA368X	MXS368	FA368R	EPFA368HH		MD6035D		MD6035C	MD6035CX	DB603/6
31	MD6032CX	OSX6032	BRK011	SMX6032	BRK012	DB603/6	FA368X	MXS368	FA368R	EPFA368HH		MD6035D		MD6035C	MD6035CX	DB603/6
32	MD6032CX	OSX6032	BRK011	SMX6032	BRK012	DB603/6	FA368X	MXS368	FA368R	EPFA368HH		MD6035D		MD6035C	MD6035CX	DB603/6
33	MD6032CX	OSX6932	BRK013	SMX6932	BRK014	DB603/6	FA368X	MXS368	FA368R	EPFA368HH		MD6035D		MD6035C	MD6035CX	DB603/6
34							FA602X		FA602R					MD6360C		
35							FA132X		FA132R							
36							FA67X		FA67R							
37							FA132X		FA132R							
38						DB603/6	FA67X		FA67R							
39	MD6032CX	OSX6032E	BRK015	SMX6032E	BRK016	DB603/6	FA208X	MXS208	FA208R			MD6035D		MD6035C	MD6035CX	DB603/6
40	MD6032CX	OSX6032	BRK011	SMX6032	BRK012	DB603/6	FA208X	MXS208	FA208R			MD6035D		MD6035C	MD6035CX	DB603/6
41	MD6032CX	OSX6032	BRK011	SMX6032	BRK012	DB603/6	FA368X	MXS368	FA368R	EPFA368HH		MD6035D		MD6035C	MD6035CX	DB603/6
42							FA132X		FA132R			MD6227D				
43							FA67X		FA67R			MD6227D				
44							FA132X		FA132R			MD6227D				
45	MD6032CX	OSX6032E	BRK015	SMX6032E	BRK016	DB603/6	FA208X	MXS208	FA208R			MD6035D		MD6035C	MD6035CX	DB603/6
46	MD6032CX	OSX6032	BRK011	SMX6032	BRK012	DB603/6	FA368X	MXS368	FA368R	EPFA368HH		MD6035D		MD6035C	MD6035CX	DB603/6
47	MD6032CX						FA368X	MXS368	FA368R	EPFA368HH		MD6035D		MD6035C	MD6035CX	DB603/6
48							FA47X		FA47R			MD6227D				
49								814G								
50							FA132X		FA132R			MD6227D				
51							FA132X		FA132R			MD6227D				
52							FA67X		FA67R			MD6227D				
53							FA67X		FA67R							
54							FA67X		FA67R							
55							FA132X		FA132R							
56	MD6032CX	OSX6032E	BRK015	SMX6032E	BRK016	DB603/6	FA67		FA67R							

REAR

BRAKE APPLICATIONS

This symbol indicates a rotor made of billet steel, and should be only used with EBC FA Organic or Vee pads. SAFETY NOTICE - With vehicles primarily designed for off highway use such as quads now being used on the highway, we would recommend the use of X or MXS pads for highway use and ONLY using the R and SV higher density / harder pad series for off road riding.

*-2 Sets Required. † For Vee disc colours add RED, BLU, GRN, GLD, ORG suffix to part number. SAFETY WARNING:- DO NOT USE HH PADS ON REAR UNLESS ALSO USED ON FRONT TO AVOID BRAKE IMBALANCE

FRONT: Non-Japanese Bikes

APPLICATIONS

BRAKE



KTM



DISC PAD CHOICES - FRONT

BRAKE ROTOR CHOICES - FRONT

Model	Year	FA/SFA/X Pad or Brake Shoe	Specialty Pads SXR/VEE/MXS Race	Sintered/HH Pads/Grooved Shoes	EPFA Sintered Fast Road/Track Pads	GPFAX Sintered RACE ONLY Pads	SV Series Severe Duty Pads	Standard Rotor		Vintage Rotor / UTV Oversize Brake Kit	Contour Profile Rotor	Line #
								Standard Rotor Left	Standard Rotor Right			
MX/EXC 250	1987	FA126X										1
MX/MXC 250	1985	FA47X										2
MX/MXC 250	1986	FA47X										3
MX/MXC/GS 250	1984			814G								4
SX 250	1994-1999	FA181X	MXS181	FA181R	EPFA181HH			MD6032D				5
SX 250	2000-2002	FA181X	MXS181	FA181R	EPFA181HH			MD6032D				6
SX 250	2003-2008	FA181X	MXS181	FA181R	EPFA181HH			MD6032D				7
SX 250	2009-2024	FA181X	MXS181	FA181R	EPFA181HH			MD6032D				8
SX-F 250	2005-2008	FA181X	MXS181	FA181R	EPFA181HH			MD6032D				9
SX-F 250	2009-2024	FA181X	MXS181	FA181R	EPFA181HH			MD6032D				10
SX-F 250 Factory Edition	2015	FA181X	MXS181	FA181R	EPFA181HH			MD6032D				11
SX-F 250 Factory Edition	2022-2023	FA181X	MXS181	FA181R	EPFA181HH							12
SX-F 250 Troy Lee Designs	2021-2022	FA181X	MXS181	FA181R	EPFA181HH							13
XC 250	2006-2009	FA181X	MXS181	FA181R	EPFA181HH			MD6032D				14
XC 250	2010-2019	FA181X	MXS181	FA181R	EPFA181HH			MD6032D				15
XC 250 TPI	2019-2024	FA181X	MXS181	FA181R				MD6032D				16
XC-F 250	2006-2009	FA181X	MXS181	FA181R	EPFA181HH			MD6032D				17
XC-F 250	2010-2024	FA181X	MXS181	FA181R	EPFA181HH			MD6032D				18
XCF-W 250	2006-2010	FA181X	MXS181	FA181R	EPFA181HH			MD6032D				19
XCF-W 250	2012-2019	FA181X	MXS181	FA181R	EPFA181HH			MD6032D				20
XCF-W 250 Six Days	2011	FA181X	MXS181	FA181R	EPFA181HH			MD6032D				21
XC-W 250	2006-2008	FA181X	MXS181	FA181R	EPFA181HH			MD6032D				22
XC-W 250	2010-2023	FA181X	MXS181	FA181R	EPFA181HH			MD6032D				23
XC-W 250 Tpi	2019-2024	FA181X	MXS181	FA181R	EPFA181HH			MD6032D				24
EGS 300	1994-1998	FA181X	MXS181	FA181R	EPFA181HH			MD6032D				25
EXC 300	1994-1998	FA181X	MXS181	FA181R	EPFA181HH			MD6032D				26
EXC 300	1999-2003	FA181X	MXS181	FA181R	EPFA181HH			MD6032D				27
EXC 300	2004-2005	FA181X	MXS181	FA181R	EPFA181HH			MD6032D				28
EXC 300 TPI	2020-2022	FA181X		FA181R				MD6032D				29
GSXC/GS 300	1985	FA47X										30
MX/MXC 300	1985	FA47X										31
MX/MXC/GS 300	1986	FA47X										32
MXC 300	1994-1998	FA181X	MXS181	FA181R	EPFA181HH			MD6032D				33
MXC 300	1999-2003	FA181X	MXS181	FA181R	EPFA181HH			MD6032D				34
MXC 300	2004-2006	FA181X	MXS181	FA181R	EPFA181HH			MD6032D				35
SX 300	1994-1996	FA181X	MXS181	FA181R	EPFA181HH			MD6032D				36
SX 300	2023-2024	FA181X	MXS181	FA181R	EPFA181HH			MD6032D				37
XC 300	2006-2009	FA181X	MXS181	FA181R	EPFA181HH			MD6032D				38
XC 300	2010-2019	FA181X	MXS181	FA181R	EPFA181HH			MD6032D				39
XC 300 TPI	2019-2024	FA181X	MXS181	FA181R				MD6032D				40
XC-W 300	2006-2009	FA181X	MXS181	FA181R	EPFA181HH			MD6032D				41
XC-W 300	2010-2018	FA181X	MXS181	FA181R	EPFA181HH			MD6032D				42
XC-W 300 Six Days	2014-2018	FA181X	MXS181	FA181R	EPFA181HH			MD6032D				43
XC-W 300 Tpi	2020-2024	FA181X		FA181R								44
XC-W 300 Tpi ErzbergRodeo	2020-2024	FA181X		FA181R								45
DXC/EXC/EGS 350	1990-1991	FA67X		FA67R				MD6034D				46
DXC/EXC/EGS 350	1990-1991	FA132X		FA132R				MD6034D				47
EXC 350	1989	FA67X		FA67R				MD6034D				48
EXC 350	1989	FA132X		FA132R				MD6034D				49
EXC 350	1994-1995	FA181X	MXS181	FA181R	EPFA181HH			MD6032D				50
EXC 350	1996-1997	FA181X	MXS181	FA181R	EPFA181HH			MD6032D				51
EXC-F 350	2012-2024	FA181X	MXS181	FA181R	EPFA181HH							52
MX 350	1989	FA67X		FA67R								53
MX 350	1989	FA132X		FA132R								54
MX 350	1990-1991	FA67X		FA67R								55
MX 350	1990-1991	FA132X		FA132R								56

FRONT

⚠ This symbol indicates a rotor made of billet steel, and should be only used with EBC FA Organic or Vee pads.
SAFETY NOTICE - With vehicles primarily designed for off highway use such as quads now being used on the highway, we would recommend the use of X or MXS pads for highway use and ONLY using the R and SV higher density / harder pad series for off road riding.

*-2 Sets Required. † For Vee disc colours add RED, BLU, GRN, GLD, ORG suffix to part number. **SAFETY WARNING:- DO NOT USE HH PADS ON REAR UNLESS ALSO USED ON FRONT TO AVOID BRAKE IMBALANCE**

FRONT: Non-Japanese Bikes Cont'd

REAR: Non-Japanese Bikes

Line #	BRAKE ROTOR CHOICES - FRONT					DISC PAD CHOICES - REAR					BRAKE ROTOR CHOICES - REAR					
	CX Extreme® /Vee-Rotor	OSX Series Oversize 280mm Rotor Kit	Relocating Bracket for Oversize Rotor	SMX Series Oversize 320mm Rotor Kit	Relocating Bracket for 320mm Rotor	Front Disc Bolt Kit	FA/SFA/X Pad or Brake Shoe	Specialty Pads SXR/ VEE/MXS Race	Sintered/ HH Pads/ Grooved Shoes	EPFA Sintered Fast Road/ Track Pads	SV Series Severe Duty Pads	Standard Rotor	Vintage Rotor / UTV Oversize Brake Kit	Contour Profile Rotor	CX Extreme® /Vee-Rotor	Rear Disc Bolt Kit
1							FA126									
2								814G								
3							FA47X		FA47R			MD6227D				
4								814G								
5	MD6032CX	OSX6032E	BRK015	SMX6032E	BRK016	DB603/6	FA208X	MXS208	FA208R			MD6035D		MD6035C	MD6035CX	DB603/6
6	MD6032CX	OSX6032	BRK011	SMX6032	BRK012	DB603/6	FA208X	MXS208	FA208R			MD6035D		MD6035C	MD6035CX	DB603/6
7	MD6032CX	OSX6032	BRK011	SMX6032	BRK012	DB603/6	FA368X	MXS368	FA368R	EPFA368HH		MD6035D		MD6035C	MD6035CX	DB603/6
8	MD6032CX	OSX6932	BRK013	SMX6932	BRK014	DB603/6	FA368X	MXS368	FA368R	EPFA368HH		MD6035D		MD6035C	MD6035CX	DB603/6
9	MD6032CX	OSX6032	BRK011	SMX6032	BRK012	DB603/6	FA368X	MXS368	FA368R	EPFA368HH		MD6035D		MD6035C	MD6035CX	DB603/6
10	MD6032CX	OSX6932	BRK013	SMX6932	BRK014	DB603/6	FA368X	MXS368	FA368R	EPFA368HH		MD6035D		MD6035C	MD6035CX	DB603/6
11	MD6032CX	OSX6932	BRK013	SMX6932	BRK014	DB603/6	FA368X	MXS368	FA368R	EPFA368HH		MD6035D		MD6035C	MD6035CX	DB603/6
12	MD6433CX	OSX6932	BRK013	SMX6932	BRK014		FA368X	MXS368	FA368R	EPFA368HH		MD6035D		MD6035C	MD6035CX	DB603/6
13	MD6433CX	OSX6932	BRK013	SMX6932	BRK014		FA368X	MXS368	FA368R	EPFA368HH		MD6035D		MD6035C	MD6035CX	DB603/6
14	MD6032CX	OSX6032	BRK011	SMX6032	BRK012	DB603/6	FA368X	MXS368	FA368R	EPFA368HH		MD6035D		MD6035C	MD6035CX	DB603/6
15	MD6032CX	OSX6932	BRK013	SMX6932	BRK014	DB603/6	FA368X	MXS368	FA368R	EPFA368HH		MD6035D		MD6035C	MD6035CX	DB603/6
16	MD6032CX	OSX6932	BRK013			DB603/6	FA368X	MXS368	FA368R			MD6035D		MD6035C	MD6035CX	DB603/6
17	MD6032CX	OSX6032	BRK011	SMX6032	BRK012	DB603/6	FA368X	MXS368	FA368R	EPFA368HH		MD6035D		MD6035C	MD6035CX	DB603/6
18	MD6032CX	OSX6932	BRK013	SMX6932	BRK014	DB603/6	FA368X	MXS368	FA368R	EPFA368HH		MD6035D		MD6035C	MD6035CX	DB603/6
19	MD6032CX	OSX6032	BRK011	SMX6032	BRK012	DB603/6	FA368X	MXS368	FA368R	EPFA368HH		MD6035D		MD6035C	MD6035CX	DB603/6
20	MD6032CX	OSX6932	BRK013	SMX6932	BRK014	DB603/6	FA368X	MXS368	FA368R	EPFA368HH		MD6035D		MD6035C	MD6035CX	DB603/6
21	MD6032CX	OSX6032	BRK011	SMX6032	BRK012	DB603/6	FA368X	MXS368	FA368R	EPFA368HH		MD6035D		MD6035C	MD6035CX	DB603/6
22	MD6032CX	OSX6032	BRK011	SMX6032	BRK012	DB603/6	FA368X	MXS368	FA368R	EPFA368HH		MD6035D		MD6035C	MD6035CX	DB603/6
23	MD6032CX	OSX6932	BRK013	SMX6932	BRK014	DB603/6	FA368X	MXS368	FA368R	EPFA368HH		MD6035D		MD6035C	MD6035CX	DB603/6
24	MD6032CX	OSX6932	BRK013	SMX6932	BRK014	DB603/6	FA368X	MXS368	FA368R	EPFA368HH		MD6035D		MD6035C	MD6035CX	DB603/6
25	MD6032CX	OSX6032E	BRK015	SMX6032E	BRK016	DB603/6	FA208X	MXS208	FA208R			MD6035D		MD6035C	MD6035CX	DB603/6
26	MD6032CX	OSX6032E	BRK015	SMX6032E	BRK016	DB603/6	FA208X	MXS208	FA208R			MD6035D		MD6035C	MD6035CX	DB603/6
27	MD6032CX	OSX6032	BRK011	SMX6032	BRK012	DB603/6	FA208X	MXS208	FA208R			MD6035D		MD6035C	MD6035CX	DB603/6
28	MD6032CX	OSX6032	BRK011	SMX6032	BRK012	DB603/6	FA368X	MXS368	FA368R	EPFA368HH		MD6035D		MD6035C	MD6035CX	DB603/6
29						DB603/6	FA368X	MXS368	FA368R			MD6035D		MD6035C	MD6035CX	DB603/6
30								814G								
31	MD6032CX							814G								
32							FA47X		FA47R			MD6227D				
33	MD6032CX	OSX6032E	BRK015	SMX6032E	BRK016	DB603/6	FA208X	MXS208	FA208R			MD6035D		MD6035C	MD6035CX	DB603/6
34	MD6032CX	OSX6032	BRK011	SMX6032	BRK012	DB603/6	FA208X	MXS208	FA208R			MD6035D		MD6035C	MD6035CX	DB603/6
35	MD6032CX	OSX6032	BRK011	SMX6032	BRK012	DB603/6	FA368X	MXS368	FA368R	EPFA368HH		MD6035D		MD6035C	MD6035CX	DB603/6
36	MD6032CX	OSX6032	BRK011	SMX6032	BRK012	DB603/6	FA208X	MXS208	FA208R			MD6035D		MD6035C	MD6035CX	DB603/6
37	MD6032CX	OSX6032	BRK011	SMX6032	BRK012	DB603/6	FA368X	MXS368	FA368R			MD6035D		MD6035C	MD6035CX	DB603/6
38	MD6032CX	OSX6032	BRK011	SMX6032	BRK012	DB603/6	FA368X	MXS368	FA368R	EPFA368HH		MD6035D		MD6035C	MD6035CX	DB603/6
39	MD6032CX	OSX6932	BRK013	SMX6932	BRK014	DB603/6	FA368X	MXS368	FA368R	EPFA368HH		MD6035D		MD6035C	MD6035CX	DB603/6
40	MD6032CX	OSX6392	BRK002				FA368X	MXS368	FA368R			MD6035D		MD6035C	MD6035CX	DB603/6
41	MD6032CX	OSX6032	BRK011	SMX6032	BRK012	DB603/6	FA368X	MXS368	FA368R	EPFA368HH		MD6035D		MD6035C	MD6035CX	DB603/6
42	MD6032CX	OSX6932	BRK013	SMX6932	BRK014	DB603/6	FA368X	MXS368	FA368R	EPFA368HH		MD6035D		MD6035C	MD6035CX	DB603/6
43	MD6032CX	OSX6932	BRK013	SMX6932	BRK014	DB603/6	FA368X	MXS368	FA368R	EPFA368HH		MD6035D		MD6035C	MD6035CX	DB603/6
44							FA368X	MXS368	FA368R			MD6035D		MD6035C	MD6035CX	DB603/6
45	MD6032CX						FA368X	MXS368	FA368R			MD6035D		MD6035C	MD6035CX	DB603/6
46							FA67		FA67R							
47							FA132X		FA132R							
48							FA67X		FA67R			MD6227D				
49							FA132X		FA132R			MD6227D				
50	MD6032CX	OSX6032	BRK011	SMX6032	BRK012	DB603/6	FA208X	MXS208	FA208R			MD6371D		MD6371C		
51	MD6032CX	OSX6032	BRK011	SMX6032	BRK012	DB603/6	FA208X	MXS208	FA208R			MD6035D		MD6035C	MD6035CX	DB603/6
52	MD6032CX	OSX6932	BRK013	SMX6932	BRK014		FA368X	MXS368	FA368R	EPFA368HH		MD6035D		MD6035C	MD6035CX	DB603/6
53							FA67X		FA67R			MD6227D				
54							FA132X		FA132R			MD6227D				
55							FA67X		FA67R							
56							FA132X		FA132R							

BRAKE APPLICATIONS
 This symbol indicates a rotor made of billet steel, and should be only used with EBC FA Organic or Vee pads. SAFETY NOTICE - With vehicles primarily designed for off highway use such as quads now being used on the highway, we would recommend the use of X or MXS pads for highway use and ONLY using the R and SV higher density / harder pad series for off road riding.

*-2 Sets Required. † For Vee disc colours add RED, BLU, GRN, GLD, ORG suffix to part number. **SAFETY WARNING:- DO NOT USE HH PADS ON REAR UNLESS ALSO USED ON FRONT TO AVOID BRAKE IMBALANCE**

FRONT: Non-Japanese Bikes

APPLICATIONS

BRAKE



KTM



DISC PAD CHOICES - FRONT

BRAKE ROTOR CHOICES - FRONT

Model	Year	FA/SFA/X Pad or Brake Shoe	Specialty Pads SXR/VEE/MXS Race	Sintered/HH Pads/Grooved Shoes	EPFA Sintered Fast Road/Track Pads	GPFAX Sintered RACE ONLY Pads	SV Series Severe Duty Pads	Standard Rotor		Vintage Rotor / UTV Oversize Brake Kit	Contour Profile Rotor	Line #
								Standard Rotor Left	Standard Rotor Right			
MX/EXC 350	1987	FA126X										1
MX/EXC/EGS 350	1988	FA132X		FA132R								2
MX/MXC/GS 350	1986	FA47X										3
SX-F 350	2010-2024	FA181X	MXS181	FA181R	EPFA181HH			MD6032D				4
XC-F 350	2010-2024	FA181X	MXS181	FA181R	EPFA181HH							5
XC-F 350 Factory Edition	2022-2024	FA181X	MXS181	FA181R	EPFA181HH							6
XC-F 350 Kailub Russel	2021	FA181X	MXS181	FA181R	EPFA181HH							7
XCF-W 350	2012-2022	FA181X	MXS181	FA181R	EPFA181HH							8
XCF-W 350 Six Days	2014-2019	FA181X	MXS181	FA181R	EPFA181HH							9
XW-F 350	2023-2024	FA181X	MXS181	FA181R	EPFA181HH							10
SX 360	1996-1997	FA181X	MXS181	FA181R	EPFA181HH			MD6032D				11
EXC 380	1998-1999	FA181X	MXS181	FA181R	EPFA181HH			MD6032D				12
EXC 380	2000-2003	FA181X	MXS181	FA181R	EPFA181HH			MD6032D				13
SX 380	1998-1999	FA181X	MXS181	FA181R	EPFA181HH			MD6032D				14
SX 380	2000-2003	FA181X	MXS181	FA181R	EPFA181HH			MD6032D				15
390 Adventure	2021-2022	FA606		FA606HH				MD864			MD864XC	16
390 Duke	2015-2022	FA606		FA606HH				MD864			MD864XC	17
RC 390	2015-2022	FA606		FA606HH				MD864			MD864XC	18
Duke 400	1994-1998	FA95		FA95HH	EPFA95HH			MD6199D			MD6199C	19
EGS 400/EGS-E/LSE	1996-1999	FA181X	MXS181	FA181R	EPFA181HH			MD6130D				20
EXC 400 Racing	2000-2003	FA181X	MXS181	FA181R	EPFA181HH			MD6032D				21
EXC/EGS 400	2000-2002	FA181X	MXS181	FA181R	EPFA181HH			MD6032D				22
LC4-E 400 Enduro	2000-2001	FA181X	MXS181	FA181R	EPFA181HH			MD6130D				23
SC 400 Supercompetition LC4	1996-1999	FA181X	MXS181	FA181R	EPFA181HH			MD6032D				24
SX 400	2000-2002	FA181X	MXS181	FA181R	EPFA181HH			MD6032D				25
XC/EXC 400	2004-2007	FA181X	MXS181	FA181R	EPFA181HH			MD6032D				26
XC-W 400	2008-2009	FA181X	MXS181	FA181R	EPFA181HH			MD6032D				27
XC-W 400	2010-2011	FA181X	MXS181	FA181R	EPFA181HH			MD6032D				28
EXC 440	1994-1995	FA181X	MXS181	FA181R	EPFA181HH			MD6032D				29
SX 440	1994-1995	FA181X	MXS181	FA181R	EPFA181HH			MD6032D				30
450 Rally	2017-2021			FA209/2HH				MD6130D				31
450 SMR	2007-2012	FA433/4		FA433/4HH	EPFA433/4HH						MD6313C	32
450 SMR	2021-2024			FA447HH	EPFA447HH	GPFAX447HH		TBC				33
EXC 450	2003	FA181X	MXS181	FA181R	EPFA181HH			MD6032D				34
EXC 450	2009	FA181X	MXS181	FA181R	EPFA181HH			MD6032D				35
EXC 450	2010-2011	FA181X	MXS181	FA181R	EPFA181HH			MD6032D				36
EXC-F 450/Six Days	2018-2019	FA181X	MXS181	FA181R	EPFA181HH			MD6032D				37
EXC-R 450	2008	FA181X	MXS181	FA181R	EPFA181HH			MD6032D				38
SMR 450	2004		MXS406		EPFA406HH			MD6270D			MD6270C	39
SMR 450	2005-2006		MXS405		EPFA405HH			MD6270D			MD6270C	40
SX 450	2009-2012			FA462R*							MD6336C*	41
SX-F 450	2003-2008	FA181X	MXS181	FA181R	EPFA181HH			MD6032D				42
SX-F 450	2009-2024	FA181X	MXS181	FA181R	EPFA181HH			MD6032D				43
SX-F 450 Factory Edition	2018-2023	FA181X	MXS181	FA181R	EPFA181HH							44
XC 450 Quad	2008-2012			FA462R*							MD6336C*	45
XC/EXC 450	2004-2007	FA181X	MXS181	FA181R	EPFA181HH			MD6032D				46
XC-F 450	2008-2009	FA181X	MXS181	FA181R	EPFA181HH			MD6032D				47
XC-F 450	2013-2024	FA181X	MXS181	FA181R	EPFA181HH			MD6032D				48
XCF-W 450	2008-2009	FA181X	MXS181	FA181R	EPFA181HH			MD6032D				49
XCF-W 450	2012-2016	FA181X	MXS181	FA181R	EPFA181HH			MD6032D				50
XCF-W 450	2023-2024	FA181X	MXS181	FA181R	EPFA181HH			MD6032D				51
XCF-W 450 Champions Edition	2010	FA181X	MXS181	FA181R	EPFA181HH			MD6032D				52
XCF-W 450 Six Days	2010-2011	FA181X	MXS181	FA181R	EPFA181HH			MD6032D				53
XCF-W 450 Six Days/Champion Edition	2010	FA181X	MXS181	FA181R	EPFA181HH			MD6032D				54
XCR-W 450	2008	FA181X	MXS181	FA181R	EPFA181HH			MD6032D				55
XCR-W 450	2013	FA181X	MXS181	FA181R	EPFA181HH			MD6032D				56

FRONT

⚠ This symbol indicates a rotor made of billet steel, and should be only used with EBC FA Organic or Vee pads.
SAFETY NOTICE - With vehicles primarily designed for off highway use such as quads now being used on the highway, we would recommend the use of X or MXS pads for highway use and ONLY using the R and SV higher density / harder pad series for off road riding.

*-2 Sets Required. † For Vee disc colours add RED, BLU, GRN, GLD, ORG suffix to part number. SAFETY WARNING:- DO NOT USE HH PADS ON REAR UNLESS ALSO USED ON FRONT TO AVOID BRAKE IMBALANCE

FRONT: Non-Japanese Bikes

APPLICATIONS

BRAKE



KTM



DISC PAD CHOICES - FRONT

BRAKE ROTOR CHOICES - FRONT

Model	Year	FA/SFA/X Pad or Brake Shoe	Specialty Pads SXR/VEE/MXS Race	Sintered/HH Pads/Grooved Shoes	EPFA Sintered Fast Road/Track Pads	GPFAX Sintered RACE ONLY Pads	SV Series Severe Duty Pads	Standard Rotor		Vintage Rotor / UTV Oversize Brake Kit	Contour Profile Rotor	Line #
								Standard Rotor Left	Standard Rotor Right			
EXC-F 500	2012-2024	FA181X	MXS181	FA181R	EPFA181HH			MD6032D				1
EXC-F 500 Six Days	2016-2023	FA181X	MXS181	FA181R	EPFA181HH							2
LC-4 EXC 500	1990-1991	FA67X		FA67R				MD6034D				3
LC-4 EXC 500	1990-1991	FA132X		FA132R				MD6034D				4
LC-4 MX 500	1990-1991	FA67X		FA67R								5
LC-4 MX 500	1990-1991	FA132X		FA132R								6
LC-4 MX/EXC 500	1989	FA132X		FA132R				MD6034D				7
MX 500	1992-1994	FA181X	MXS181	FA181R	EPFA181HH							8
MX 500	1995	FA181X	MXS181	FA181R	EPFA181HH							9
MX/MXC/XC-GS 500	1985	FA47X										10
XCF-W 500	2012-2022	FA181X	MXS181	FA181R	EPFA181HH			MD6032D				11
XW-F 500	2023-2024	FA181X	MXS181	FA181R	EPFA181HH			MD6032D				12
SX 505	2009-2012			FA462R*							MD6336C*	13
SX-F 505	2007-2008	FA181X	MXS181	FA181R	EPFA181HH			MD6032D				14
XC-F 505	2008-2009	FA181X	MXS181	FA181R	EPFA181HH			MD6032D				15
EXC 520	2001-2003	FA181X	MXS181	FA181R	EPFA181HH			MD6032D				16
SX 520	2001-2003	FA181X	MXS181	FA181R	EPFA181HH			MD6032D				17
EXC 525	2003	FA181X	MXS181	FA181R	EPFA181HH			MD6032D				18
EXC 525	2004-2007	FA181X	MXS181	FA181R	EPFA181HH			MD6032D				19
MXC 525	2003	FA181X	MXS181	FA181R	EPFA181HH			MD6032D				20
MXC 525	2004	FA181X	MXS181	FA181R	EPFA181HH			MD6032D				21
SMR 525	2004		MXS406		EPFA406HH							22
SMR 525	2005		MXS405		EPFA405HH							23
SX 525	2003-2006	FA181X	MXS181	FA181R	EPFA181HH			MD6032D				24
XC 525	2008-2012			FA462R*							MD6336C*	25
XC 525 Desert Racing	2007	FA181X	MXS181	FA181R	EPFA181HH			MD6032D				26
EXC 530	2009-2010	FA181X	MXS181	FA181R	EPFA181HH			MD6032D				27
EXC 530	2011	FA181X	MXS181	FA181R	EPFA181HH			MD6032D				28
EXC-R 530	2008	FA181X	MXS181	FA181R	EPFA181HH			MD6032D				29
XCR-W 530	2008	FA181X	MXS181	FA181R	EPFA181HH			MD6032D				30
XC-W 530	2008-2009	FA181X	MXS181	FA181R	EPFA181HH			MD6032D				31
XC-W 530 Six Days	2010	FA181X	MXS181	FA181R	EPFA181HH			MD6032D				32
MXC 550	1996	FA181X	MXS181	FA181R	EPFA181HH			MD6032D				33
SMR 560	2006		MXS405		EPFA405HH			MD6270D			MD6270C	34
SMR 560	2007	FA433/4		FA433/4HH	EPFA433/4HH						MD6313C	35
LC4 EXC 600	1990-1991	FA67X		FA67R				MD6034D				36
LC4 EXC 600	1990-1991	FA132X		FA132R				MD6034D				37
LC4 EXC 600	1992-1993	FA132X		FA132R				MD6034D				38
LC4 MX 600	1990-1991	FA67X		FA67R								39
LC4 MX 600	1990-1991	FA132X		FA132R								40
LC4 MX/EXC 600	1989	FA132X		FA132R				MD6034D				41
Duke 620	1994-1998	FA95		FA95HH				MD6199D			MD6199C	42
EGS 620 Enduro/EGS-E/LSE	1996-1999	FA181X	MXS181	FA181R	EPFA181HH			MD6130D			MD6130CF	43
EGS-E 620 Adventure/Rallye	1999	FA181X	MXS181	FA181R	EPFA181HH			MD6032D				44
SC 620 Supercompetition	1996-2000	FA181X	MXS181	FA181R	EPFA181HH			MD6032D				45
SX 620	1996-1999	FA181X	MXS181	FA181R	EPFA181HH			MD6032D				46
SX 620/EXC/EGS	1994	FA181X	MXS181	FA181R	EPFA181HH			MD6032D				47
SX EXC/EGS 620	1995	FA181X	MXS181	FA181R	EPFA181HH			MD6032D				48
LC4 625 SC Supercompetition	2002	FA181X	MXS181	FA181R	EPFA181HH			MD6032D				49
LC4 625 SC Supermoto	2002	FA181X	MXS181	FA181R	EPFA181HH			MD6199D			MD6199C	50
SMC 625	2005-2006	FA244		FA244HH	EPFA244HH						MD6199C	51
SXC 625	2003-2004	FA181X	MXS181	FA181R	EPFA181HH			MD6032D				52
SXC 625	2005-2006	FA181X	MXS181	FA181R	EPFA181HH			MD6032D				53
640 Duke Jet Black/Yellow/Adrenalin Orange	2003-2006	FA244		FA244HH	EPFA244HH			MD6199D			MD6199C	54
Duke II 640 Black/Orange	2002	FA244		FA244HH	EPFA244HH			MD6199D			MD6199C	55
Duke II 640 Orpheus/Titan/Lime	2001	FA244		FA244HH	EPFA244HH			MD6199D			MD6199C	56

FRONT

⚠ This symbol indicates a rotor made of billet steel, and should be only used with EBC FA Organic or Vee pads. SAFETY NOTICE - With vehicles primarily designed for off highway use such as quads now being used on the highway, we would recommend the use of X or MXS pads for highway use and ONLY using the R and SV higher density / harder pad series for off road riding.

*-2 Sets Required. † For Vee disc colours add RED, BLU, GRN, GLD, ORG suffix to part number. SAFETY WARNING:- DO NOT USE HH PADS ON REAR UNLESS ALSO USED ON FRONT TO AVOID BRAKE IMBALANCE

FRONT: Non-Japanese Bikes Cont'd

REAR: Non-Japanese Bikes

Line #

BRAKE ROTOR CHOICES - FRONT						DISC PAD CHOICES - REAR						BRAKE ROTOR CHOICES - REAR				
CX Extreme® /Vee-Rotor	OSX Series Oversize 280mm Rotor Kit	Relocating Bracket for Oversize Rotor	SMX Series Oversize 320mm Rotor Kit	Relocating Bracket for 320mm Rotor	Front Disc Bolt Kit	FA/SFA/X Pad or Brake Shoe	Specialty Pads SXR/VEE/MXS Race	Sintered/HH Pads/Grooved Shoes	EPFA Sintered Fast Road/Track Pads	SV Series Severe Duty Pads	Standard Rotor	Vintage Rotor / UTV Oversize Brake Kit	Contour Profile Rotor	CX Extreme® /Vee-Rotor	Rear Disc Bolt Kit	
1	MD6032CX	OSX6932	BRK013	SMX6932	BRK014	DB603/6	FA368X	MXS368	FA368R	EPFA368HH		MD6035D		MD6035C	MD6035CX	DB603/6
2	MD6433CX	OSX6932	BRK013	SMX6932	BRK014		FA368X	MXS368	FA368R	EPFA368HH					MD6035CX	DB603/6
3							FA67X		FA67R			MD6035D		MD6035C	MD6035CX	DB603/6
4							FA132X		FA132R			MD6035D		MD6035C	MD6035CX	DB603/6
5							FA67X		FA67R			MD6035D		MD6035C	MD6035CX	DB603/6
6							FA132X		FA132R			MD6035D		MD6035C	MD6035CX	DB603/6
7							FA132X		FA132R							
8							FA67X		FA67R							
9							FA208X	MXS208	FA208R							
10								814G								
11	MD6032CX	OSX6932	BRK013	SMX6932	BRK014	DB603/6	FA368X	MXS368	FA368R	EPFA368HH		MD6035D		MD6035C	MD6035CX	DB603/6
12	MD6032CX	OSX6932	BRK013	SMX6932	BRK014	DB603/6	FA368X	MXS368	FA368R	EPFA368HH		MD6035D		MD6035C	MD6035CX	DB603/6
13									FA463R			MD6337D				
14	MD6032CX	OSX6032	BRK011	SMX6032	BRK012	DB603/6	FA368X	MXS368	FA368R	EPFA368HH		MD6035D		MD6035C	MD6035CX	DB603/6
15	MD6032CX	OSX6032	BRK011	SMX6032	BRK012	DB603/6	FA368X	MXS368	FA368R	EPFA368HH		MD6035D		MD6035C	MD6035CX	DB603/6
16	MD6032CX	OSX6032	BRK011	SMX6032	BRK012	DB603/6	FA208X	MXS208	FA208R			MD6035D		MD6035C	MD6035CX	DB603/6
17	MD6032CX	OSX6032	BRK011	SMX6032	BRK012	DB603/6	FA208X	MXS208	FA208R			MD6035D		MD6035C	MD6035CX	DB603/6
18	MD6032CX	OSX6032	BRK011	SMX6032	BRK012	DB603/6	FA208X	MXS208	FA208R			MD6035D		MD6035C	MD6035CX	DB603/6
19	MD6032CX	OSX6032	BRK011	SMX6032	BRK012	DB603/6	FA368X	MXS368	FA368R	EPFA368HH		MD6035D		MD6035C	MD6035CX	DB603/6
20	MD6032CX	OSX6032	BRK011	SMX6032	BRK012	DB603/6	FA208X	MXS208	FA208R			MD6035D		MD6035C	MD6035CX	DB603/6
21	MD6032CX	OSX6032	BRK011	SMX6032	BRK012	DB603/6	FA208X	MXS208	FA208R			MD6035D		MD6035C	MD6035CX	DB603/6
22							FA368X	MXS368	FA368R							
23							FA368X	MXS368	FA368R			MD6035D		MD6035C	MD6035CX	DB603/6
24	MD6032CX	OSX6032	BRK011	SMX6032	BRK012	DB603/6	FA368X	MXS368	FA368R	EPFA368HH		MD6035D		MD6035C	MD6035CX	DB603/6
25									FA463R			MD6337D				
26	MD6032CX	OSX6032	BRK011	SMX6032	BRK012	DB603/6	FA368X	MXS368	FA368R	EPFA368HH		MD6035D		MD6035C	MD6035CX	DB603/6
27	MD6032CX	OSX6032	BRK011	SMX6032	BRK012	DB603/6	FA368X	MXS368	FA368R	EPFA368HH		MD6035D		MD6035C	MD6035CX	DB603/6
28	MD6032CX	OSX6932	BRK013	SMX6932	BRK014	DB603/6	FA368X	MXS368	FA368R	EPFA368HH		MD6035D		MD6035C	MD6035CX	DB603/6
29	MD6032CX	OSX6032	BRK011	SMX6032	BRK012	DB603/6	FA368X	MXS368	FA368R	EPFA368HH		MD6035D		MD6035C	MD6035CX	DB603/6
30	MD6032CX	OSX6032	BRK011	SMX6032	BRK012	DB603/6	FA368X	MXS368	FA368R	EPFA368HH		MD6035D		MD6035C	MD6035CX	DB603/6
31	MD6032CX	OSX6032	BRK011	SMX6032	BRK012	DB603/6	FA368X	MXS368	FA368R	EPFA368HH		MD6035D		MD6035C	MD6035CX	DB603/6
32	MD6032CX	OSX6932	BRK013	SMX6932	BRK014	DB603/6	FA368X	MXS368	FA368R	EPFA368HH		MD6035D		MD6035C	MD6035CX	DB603/6
33	MD6032CX	OSX6032E	BRK015	SMX6032E	BRK016	DB603/6	FA208X	MXS208	FA208R			MD6035D		MD6035C	MD6035CX	DB603/6
34							FA368X	MXS368	FA368R			MD6035D		MD6035C	MD6035CX	DB603/6
35							FA368X	MXS368	FA368R	EPFA368HH		MD6035D		MD6035C	MD6035CX	DB603/6
36							FA67X		FA67R			MD6371D				DB603/6
37							FA132X		FA132R			MD6371D				DB603/6
38							FA67X		FA67R			MD6371D				DB603/6
39							FA67X		FA67R			MD6371D				DB603/6
40							FA132X		FA132R			MD6371D				DB603/6
41							FA132X		FA132R							
42							FA208X	MXS208	FA208R			MD6371D		MD6371C		DB603/6
43							FA208X	MXS208	FA208R			MD6371D		MD6371C		DB603/6
44		OSX6032E	BRK015	SMX6032E	BRK016	DB603/6	FA208X	MXS208	FA208R			MD6371D		MD6371C		DB603/6
45		OSX6032E	BRK015	SMX6032E	BRK016	DB603/6	FA208X	MXS208	FA208R			MD6371D		MD6371C		DB603/6
46		OSX6032E	BRK015	SMX6032E	BRK016	DB603/6	FA208X	MXS208	FA208R			MD6371D		MD6371C		DB603/6
47		OSX6032E	BRK015	SMX6032E	BRK016	DB603/6	FA67X		FA67R			MD6371D		MD6371C		DB603/6
48		OSX6032E	BRK015	SMX6032E	BRK016	DB603/6	FA208X	MXS208	FA208R			MD6371D		MD6371C		DB603/6
49		OSX6032	BRK011	SMX6032	BRK012	DB603/6	FA208X	MXS208	FA208R			MD6371D		MD6371C		DB603/6
50							FA208X	MXS208	FA208R			MD6371D		MD6371C		DB603/6
51							FA208X	MXS208	FA208R			MD6035D		MD6035C	MD6035CX	DB603/6
52	MD6032CX	OSX6032	BRK011	SMX6032	BRK012	DB603/6	FA208X	MXS208	FA208R			MD6035D		MD6035C	MD6035CX	DB603/6
53	MD6032CX	OSX6032	BRK011	SMX6032	BRK012	DB603/6	FA368X	MXS368	FA368R	EPFA368HH		MD6035D		MD6035C	MD6035CX	DB603/6
54							FA213		FA213HH			MD6371D		MD6371C		DB603/6
55							FA208X	MXS208	FA208R			MD6371D				DB603/6
56							FA208X	MXS208	FA208R			MD6371D				DB603/6

REAR
BRAKE
APPLICATIONS
⚠ This symbol indicates a rotor made of billet steel, and should be only used with EBC FA Organic or Vee pads.
SAFETY NOTICE - With vehicles primarily designed for off highway use such as quads now being used on the highway, we would recommend the use of X or MXS pads for highway use and ONLY using the R and SV higher density / harder pad series for off road riding.

*-2 Sets Required. † For Vee disc colours add RED, BLU, GRN, GLD, ORG suffix to part number. **SAFETY WARNING:- DO NOT USE HH PADS ON REAR UNLESS ALSO USED ON FRONT TO AVOID BRAKE IMBALANCE**

FRONT: Non-Japanese Bikes

APPLICATIONS
BRAKE



KTM



DISC PAD CHOICES - FRONT

BRAKE ROTOR CHOICES - FRONT

Model	Year	FA/SFA/X Pad or Brake Shoe	Specialty Pads SXR/VEE/MXS Race	Sintered/HH Pads/ Grooved Shoes	EPFA Sintered Fast Road/Track Pads	GPFAX Sintered RACE ONLY Pads	SV Series Severe Duty Pads	Standard Rotor		Vintage Rotor / UTV Oversize Brake Kit	Contour Profile Rotor	Line #
								Standard Rotor Left	Standard Rotor Right			
LC-4 640 Adventure	2005-2007	FA209/2*		FA209/2HH*	EPFA209/2HH*			MD6266D	MD6266D			1
LC-4 640 Adventure R	1999-2002	FA181X	MXS181	FA181R	EPFA181HH			MD6130D			MD6130CF	2
LC-4 640 Adventure R	2004	FA209/2*		FA209/2HH*	EPFA209/2HH*			MD6266D	MD6266D			3
LC-4 Adventure	2003	FA181X	MXS181	FA181R	EPFA181HH			MD6130D			MD6130CF	4
LC4-E 640 Enduro	2000-2004	FA181X	MXS181	FA181R	EPFA181HH			MD6130D			MD6130CF	5
LC4-E 640 Supermoto	2000-2004	FA181X	MXS181	FA181R	EPFA181HH			MD6199D			MD6199C	6
SMC 640 LC4	2005-2006	FA244		FA244HH	EPFA244HH							7
SMC 660 Supermoto	2003-2004	FA95		FA95HH	EPFA95HH							8
SMC 660 Supermoto	2005-2006	FA244		FA244HH	EPFA244HH							9
690 Duke	2008-2011			FA322/4HH	EPFA322/4HH			MD614X			MD614XC	10
690 Duke	2010-2011			FA322/4HH	EPFA322/4HH			MD614X			MD614XC	11
690 Duke	2012-2019	FA244		FA244HH	EPFA244HH			MD856X			MD856XC	12
690 Enduro	2008	FA181X	MXS181	FA181R	EPFA181HH			MD6130D			MD6130CF	13
690 Enduro	2009-2024	FA209/2		FA209/2HH	EPFA209/2HH			MD844X			MD844XC	14
690 Enduro	2010-2016	FA209/2		FA209/2HH				MD6299D			MD6299C	15
690 Rally Factory Rep	2007-2008	FA209/2		FA209/2HH								16
690 SMC	2008-2011			FA322/4HH	EPFA322/4HH			MD6199D			MD6199C	17
690 SMC	2014-2020			FA322/4HH	EPFA322/4HH			MD6414D			MD6414C	18
690 SMC R	2021-2023			FA630HH	EPFA630HH			MD6414D			MD6414C	19
690 SMR	2007-2009			FA322/4HH	EPFA322/4HH			MD614X			MD614XC	20
690 Supermoto	2002-2008	FA244		FA244HH	EPFA244HH							21
790 Adventure	2018-2024	FA244		FA244HH*	EPFA244HH*			MD896X	MD896X			22
790 Adventure R	2018-2021	FA244		FA244HH*	EPFA244HH*			MD896X	MD896X			23
790 Adventure R Rally	2021	FA244		FA244HH*	EPFA244HH*			MD896X	MD896X			24
790 Duke	2018-2023	FA244		FA244HH*	EPFA244HH*			TBC	TBC			25
890 Adventure Inc L	2021-2024	FA244		FA244HH*	EPFA244HH*			MD896X	MD896X			26
890 Adventure R	2021-2024	FA244		FA244HH*	EPFA244HH*			MD896X	MD896X			27
890 Adventure R Rally	2021-2024	FA244		FA244HH*	EPFA244HH*			MD896X	MD896X			28
890 Duke	2021-2023			FA244HH*	EPFA244HH*			MD856X	MD856X			29
890 RC8 R	2022-2023			FA447HH*	EPFA447HH*							30
950 Adventure S	2004-2006	FA209/2*		FA209/2HH*				MD6266D	MD6266D			31
950 Super Enduro	2007-2008	FA209/2		FA209/2HH				MD6299D				32
950 Supermoto	2005-2007			FA322/4HH*	EPFA322/4HH*			MD680	MD680		MD680C*	33
950 Supermoto	2007-2008			FA322/4HH*	EPFA322/4HH*			MD680	MD680		MD680C*	34
990 Adventure	2006-2008	FA209/2*		FA209/2HH*				MD6299D	MD6299D		MD6299C*	35
990 Adventure	2006-2008	FA209/2*		FA209/2HH*				MD844X			MD844XC	36
990 Adventure		Left										37
990 Adventure	2007-2012	Right							MD848X		MD848XC	37
990 Adventure		Left										38
990 Adventure		Right							MD848X		MD848XC	39
990 Adventure	2009-2012							MD6299D	MD6299D		MD6299C*	40
990 Adventure Baja Edition	2013-2014	Left						MD844X			MD844XC	41
990 Adventure		Right										42
990 SM-R	2009-2011			FA447HH*	EPFA447HH*			MD680	MD680		MD680C*	43
990 SM-T	2010-2014			FA322/4HH*				MD680	MD680		MD680C*	44
990 Super Duke	2005-2011			FA322/4HH*	EPFA322/4HH*			MD633X	MD633X		MD633XC*	45
990 Super Duke R	2009-2011			FA322/4HH*	EPFA322/4HH*			MD633X	MD633X		MD633XC*	46
1090 Adventure L & R	2018-2019	FA244*		FA244HH*	EPFA244HH*			MD6424D	MD6424D		MD6424C*	47
1190 Adventure	2013-2016	FA244*		FA244HH*	EPFA244HH*			MD6424D	MD6424D		MD6424C*	48
1190 Adventure R	2013-2016	FA244*		FA244HH*	EPFA244HH*			MD896X	MD896X			49
RC8 1190	2008-2012			FA447HH*	EPFA447HH*			MD633X	MD633X		MD633XC*	50
RC8 R 1190	2009-2014			FA447HH*	EPFA447HH*			MD633X	MD633X		MD633XC*	51
1290 Super Adventure R	2015-2024	FA244*		FA244HH*	EPFA244HH*			MD896X	MD896X			52
1290 Super Adventure S	2015-2024	FA244*		FA244HH*	EPFA244HH*			MD896X	MD896X			53
1290 Super Duke	2014-2022			FA447HH*	EPFA447HH*			MD2112XBLK	MD2112XBLK			54
1290 Super Duke GT	2019-2024			FA447HH*	EPFA447HH*			MD2112XBLK	MD2112XBLK			55
1290 Super Duke RR	2021-2022			FA447HH*	EPFA447HH*	GPFAX447HH*		TBC	TBC			56

* This symbol indicates a rotor made of billet steel, and should be only used with EBC FA Organic or Vee pads.
 SAFETY NOTICE - With vehicles primarily designed for off highway use such as quads now being used on the highway, we would recommend the use of X or MXS pads for highway use and ONLY using the R and SV higher density / harder pad series for off road riding.

*-2 Sets Required. † For Vee disc colours add RED, BLU, GRN, GLD, ORG suffix to part number. **SAFETY WARNING:- DO NOT USE HH PADS ON REAR UNLESS ALSO USED ON FRONT TO AVOID BRAKE IMBALANCE**

FRONT: Non-Japanese Bikes Cont'd

REAR: Non-Japanese Bikes

Line #	BRAKE ROTOR CHOICES - FRONT						DISC PAD CHOICES - REAR						BRAKE ROTOR CHOICES - REAR				
	CX Extreme® /Vee-Rotor	OSX Series Oversize 280mm Rotor Kit	Relocating Bracket for Oversize Rotor	SMX Series Oversize 320mm Rotor Kit	Relocating Bracket for 320mm Rotor	Front Disc Bolt Kit	FA/SFA/X Pad or Brake Shoe	Specialty Pads SXR/ VEE/MXS Race	Sintered/ HH Pads/ Grooved Shoes	EPFA Sintered Fast Road/ Track Pads	SV Series Severe Duty Pads	Standard Rotor	Vintage Rotor / UTV Oversize Brake Kit	Contour Profile Rotor	CX Extreme® /Vee-Rotor	Rear Disc Bolt Kit	
1							FA208X	MXS208	FA208R			MD6371D				DB603/6	
2							FA208X	MXS208	FA208R			MD6371D				DB603/6	
3							FA208X	MXS208	FA208R			MD6371D				DB603/6	
4							FA208X	MXS208	FA208R			MD6371D				DB603/6	
5							FA208X	MXS208	FA208R			MD6371D				DB603/6	
6							FA208X	MXS208	FA208R			MD6371D				DB603/6	
7							FA208X	MXS208	FA208R			MD6371D				DB603/6	
8							FA208X	MXS208	FA208R			MD6371D				DB603/6	
9							FA208X	MXS208	FA208R			MD6371D				DB603/6	
10	VR614BLK						FA213		FA213HH			MD681	MD681C	VR681			
11	VR614BLK						FA213		FA213HH			MD681	MD681C	VR681			
12							FA213		FA213HH			MD857	MD857C				
13							FA208X	MXS208	FA208R			MD6035D	MD6035C	MD6035CX		DB603/6	
14							FA208X	MXS208	FA208R			MD6415D	MD6415C				
15							FA208X	MXS208	FA208R				MD6269C				
16							FA208X	MXS208	FA208R			MD6269D					
17							FA208X	MXS208	FA208R			MD6298D					
18							FA208X	MXS208	FA208R			MD6415D	MD6415C				
19							FA208X	MXS208	FA208R			MD6415D	MD6415C				
20	VR614BLK						FA208X	MXS208	FA208R			MD681	MD681C	VR681			
21							FA208X	MXS208	FA208R			MD681					
22							FA181X	MXS181	FA181R	EPFA181HH							
23							FA181X	MXS181	FA181R	EPFA181HH							
24							FA181X	MXS181	FA181R	EPFA181HH							
25									FA213HH		MD681	MD681C	VR681				
26							FA181X	MXS181	FA181R	EPFA181HH							
27							FA181X	MXS181	FA181R	EPFA181HH							
28							FA181X	MXS181	FA181R	EPFA181HH							
29									FA213HH								
30									FA266HH	EPFA266HH							
31							FA181X		FA181HH		MD6269D						
32							FA181X		FA181HH		MD6298D						
33							FA181X		FA181HH	EPFA181HH	MD681	MD681C					
34							FA181X		FA181HH	EPFA181HH	MD681	MD681C					
35							FA181X		FA181HH		MD6298D						
36											MD6298D						
37							FA181X		FA181HH								
38											MD6298D						
39							FA181X		FA181HH								
40							FA181X		FA181R		MD6298D						
41											MD6298D						
42							FA181X		FA181HH								
43							FA181X		FA181HH	EPFA181HH	MD681	MD681C					
44							FA181X		FA181HH		MD681	MD681C					
45							FA213		FA213HH		MD681	MD681C					
46							FA213		FA213HH		MD681	MD681C					
47							FA181X		FA181HH	EPFA181HH	MD6424D						
48							FA181X		FA181HH	EPFA181HH	MD6424D						
49							FA181X		FA181HH	EPFA181HH	MD6424D						
50							FA266		FA266HH	EPFA266HH	MD812						
51							FA266		FA266HH	EPFA266HH	MD812						
52							FA181X		FA181HH	EPFA181HH	MD6424D						
53							FA181X		FA181HH	EPFA181HH	MD6424D						
54							FA266		FA266HH	EPFA266HH	MD6423D	MD6423C					
55							FA266		FA266HH	EPFA266HH	MD6423D	MD6423C					
56									FA266HH	EPFA266HH	MD6423D	MD6423C					

BRAKE APPLICATIONS
 This symbol indicates a rotor made of billet steel, and should be only used with EBC FA Organic or Vee pads.
 SAFETY NOTICE - With vehicles primarily designed for off highway use such as quads now being used on the highway, we would recommend the use of X or MXS pads for highway use and ONLY using the R and SV higher density / harder pad series for off road riding.

*-2 Sets Required. † For Vee disc colours add RED, BLU, GRN, GLD, ORG suffix to part number. **SAFETY WARNING:- DO NOT USE HH PADS ON REAR UNLESS ALSO USED ON FRONT TO AVOID BRAKE IMBALANCE**

FRONT: Non-Japanese Bikes Cont'd

REAR: Non-Japanese Bikes

Line #	BRAKE ROTOR CHOICES - FRONT					REAR	DISC PAD CHOICES - REAR					BRAKE ROTOR CHOICES - REAR				
	CX Extreme® /Vee-Rotor	OSX Series Oversize 280mm Rotor Kit	Relocating Bracket for Oversize Rotor	SMX Series Oversize 320mm Rotor Kit	Relocating Bracket for 320mm Rotor		Front Disc Bolt Kit	FA/SFA/X Pad or Brake Shoe	Specialty Pads SXR/ VEE/MXS Race	Sintered/ HH Pads/ Grooved Shoes	EPFA Sintered Fast Road/ Track Pads	SV Series Severe Duty Pads	Standard Rotor	Vintage Rotor / UTV Oversize Brake Kit	Contour Profile Rotor	CX Extreme® /Vee-Rotor
1									FA266HH	EPFA266HH		MD6423D		MD6423C		
2																
3																
4																
5								FA305X		FA305R		MD6267D				
6								307		307G						
7								303								
8								303								
9								302								
10								303								
11								303								
12								303								
13								303								
14								303								
15								303								
16								303								
17								818								
18								818								
19								303								
20								303								
21								820								
22								820								
23								303								
24								303								
25								303								
26								FA305X		FA305R		MD6267D				
27								FA305X		FA305R		MD6267D				
28								FA355/4X		FA355/4R		MD6268D				
29								FA305X		FA305R		MD6267D				
30								FA305X		FA305R		MD6267D				
31								FA305X		FA305R		MD6267D				
32								302								
33								303								
34								303								
35								340								
36								SFA498		SFA498HH						
37								818								
38								FA305X		FA305R		MD6267D				
39								FA305X		FA305R		MD6267D				
40								FA305X		FA305R		MD6267D				
41								SFA197		SFA197HH		MD974D				
42								SFA197		SFA197HH						
43								SFA197		SFA197HH						
44								818								
45								SFA607		SFA607HH		MD9100D				
46								FA197		FA197HH						
47								340								
48								818								
49								818								
50								SFA305		SFA305HH		MD971D				
51	VR9128							SFA498		SFA498HH		MD9129D				
52								SFA197		SFA197HH						
53								SFA607		SFA607HH						
54								818								
55								SFA197		SFA197HH		MD974D				
56								FA355/4X		FA355/4R		MD6268D				

⚠ This symbol indicates a rotor made of billet steel, and should be only used with EBC FA Organic or Vee pads.
SAFETY NOTICE - With vehicles primarily designed for off highway use such as quads now being used on the highway, we would recommend the use of X or MXS pads for highway use and ONLY using the R and SV higher density / harder pad series for off road riding.

*-2 Sets Required. † For Vee disc colours add RED, BLU, GRN, GLD, ORG suffix to part number. **SAFETY WARNING:- DO NOT USE HH PADS ON REAR UNLESS ALSO USED ON FRONT TO AVOID BRAKE IMBALANCE**

FRONT: Non-Japanese Bikes

APPLICATIONS

BRAKE



KYMCO



DISC PAD CHOICES - FRONT

BRAKE ROTOR CHOICES - FRONT

Model	Year	Left Right	FA/SFA/X Pad or Brake Shoe	Specialty Pads SXR/ VEE/MXS Race	Sintered/ HH Pads/ Grooved Shoes	EPFA Sintered Fast Road/Track Pads	GPFAX Sintered RACE ONLY Pads	SV Series Severe Duty Pads	Standard Rotor Left 	Standard Rotor Right 	Vintage Rotor / UTV Oversize Brake Kit	Contour Profile Rotor	Line #
			FA/SFA/X Pad or Brake Shoe	Specialty Pads SXR/ VEE/MXS Race	Sintered/ HH Pads/ Grooved Shoes	EPFA Sintered Fast Road/Track Pads	GPFAX Sintered RACE ONLY Pads	SV Series Severe Duty Pads	Standard Rotor Left 	Standard Rotor Right 	Vintage Rotor / UTV Oversize Brake Kit	Contour Profile Rotor	
MXU 250	2004-2010		FA377X*	FA377V*	FA377R*				MD6267D	MD6267D			1
Grandvista 250	2005-2010		SFA197		SFA197HH					MD973D			2
People 250	2003-2007		SFA197		SFA197HH					MD9100D			3
People S 250	2007-2011	Left Right	SFA228		SFA228HH								4
			SFA197		SFA197HH								5
Venox 250	2003-2008		FA196		FA196HH				MD1101				6
XCiting 250	2005-2011		SFA142*		SFA142HH*								7
Mongoose 270 Inc Euro	2020-2021		FA377X*	FA377V*	FA377R*								8
MXU 270	2016-2020		FA377X*	FA377V*	FA377R*								9
MXU 270 i Euro	2020-2021		FA377X*	FA377V*	FA377R*								10
MXU 300	2005-2021		FA377X*	FA377V*	FA377R*				MD6267D	MD6267D			11
Downtown 300i	2010-2015		SFA142		SFA142HH								12
People GT 300i	2011-2015		SFA324		SFA324HH								13
X Town 300i	2018-2023		SFA324		SFA324HH								14
Downtown 350i	2018-2019		SFA324		SFA324HH								15
Maxxer 375 4 x 4 IRS	2010-2012		FA395X*		FA395R*			FA395SV*	MD6173D	MD6173D	UTVX6173*		16
MXU 375 4 x 4 IRS	2008-2012		FA395X*		FA395R*			FA395SV*	MD6173D	MD6173D	UTVX6173*		17
Maxxer 450 4 x 4 IRS	2011-2016		FA395X*		FA395R*			FA395SV*	MD6173D	MD6173D	UTVX6173*		18
MXU 450 4 x 4 IRS	2011-2014		FA395X*		FA395R*			FA395SV*	MD6173D	MD6173D	UTVX6173*		19
MXU 450 4 x 4 IRS LE	2011-2014		FA395X*		FA395R*			FA395SV*	MD6173D	MD6173D	UTVX6173*		20
MXU 450 i	2020-2021		FA395X*		FA395R*			FA395SV*	MD6173D	MD6173D	UTVX6173*		21
MXU 450 i LE	2020-2021		FA395X*		FA395R*			FA395SV*	MD6173D	MD6173D	UTVX6173*		22
MXU 450 i LE Prime	2020-2021		FA395X*		FA395R*			FA395SV*	MD6173D	MD6173D	UTVX6173*		23
UXV 450i	2015-2021		FA377X*	FA377V*	FA377R*								24
MXU 500 4 x 4	2007-2009		FA377X*	FA377V*	FA377R*				MD6173D	MD6173D	UTVX6173*		25
MXU 500 4 x 4 IRS	2010-2011		FA600X*		FA600R*				MD6173D	MD6173D	UTVX6173*		26
MXU 500i IRS	2010-2011		FA600X*		FA600R*				MD6173D	MD6173D	UTVX6173*		27
UXV 500 4 x 4	2008-2021		FA377X*	FA377V*	FA377R*				MD6393D	MD6393D	MD6393C	MD6393C	28
UXV 500 i	2013-2021		FA377X*	FA377V*	FA377R*				MD6393D	MD6393D	MD6393C	MD6393C	29
XCiting 500 All models	2004-2014		SFA142*		SFA142HH*								30
AK 550	2017-2023				FA630HH*				MD9174D	MD9174D			31
MXU 700i	2020-2021		FA600X*		FA600R*				MD6173D	MD6173D	UTVX6173*		32
UXV 700i 4 x 4	2014-2021		FA377X*	FA377V*	FA377R*								33
My Road 700 i	2011-2015		SFA432*		SFA432HH*								34
													35
													36
LAVERDA													37
Alpino 500/Montjuic	1976		FA47		FA47HH								37
650 Sport Formula	1994-1995		FA95*		FA95HH*	EPFA95HH*			MD2003X	MD2003X		MD2003XC*	38
668 Diamante/Ghost/Strike	1996-1998		FA95*		FA95HH*	EPFA95HH*			MD2003X	MD2003X		MD2003XC*	39
750 S Carenata	1998-2000		FA95*		FA95HH*	EPFA95HH*			MD2003X	MD2003X		MD2003XC*	40
750 S Formula/Sport	1998-2000		FA95*		FA95HH*	EPFA95HH*			MD2003X	MD2003X		MD2003XC*	41
750 Strike Bifaro/Mono	1998-2000		FA95*		FA95HH*	EPFA95HH*			MD2003X	MD2003X		MD2003XC*	42
1000 Jota	1976		FA18*		FA18HH*				MD609LS	MD609RS			43
1000 RGS	1983		FA18*		FA18HH*				MD609ALS	MD609ARS			44
1000 SFC	1985-1986		FA18*		FA18HH*				MD668LS	MD668RS			45
1200 Mirage	1976		FA18*		FA18HH*				MD609LS	MD609RS			46
													47
													48
LEM													49
RX 2/3	2003-2008				FA325R								49
													50
													51
LIFAN													52
LF 200 GY-S	2005-2008		FA56										52
													53
													54
MAICO/M-STAR													55
MX 250/360/500	1989		FA132X		FA132R								55
All Models	1984-1985				821G								56

FRONT

* This symbol indicates a rotor made of billet steel, and should be only used with EBC FA Organic or Vee pads.
SAFETY NOTICE - With vehicles primarily designed for off highway use such as quads now being used on the highway, we would recommend the use of X or MXS pads for highway use and ONLY using the R and SV higher density / harder pad series for off road riding.

*-2 Sets Required. † For Vee disc colours add RED, BLU, GRN, GLD, ORG suffix to part number. SAFETY WARNING:- DO NOT USE HH PADS ON REAR UNLESS ALSO USED ON FRONT TO AVOID BRAKE IMBALANCE

FRONT: Non-Japanese Bikes Cont'd

REAR: Non-Japanese Bikes

Line #	BRAKE ROTOR CHOICES - FRONT					DISC PAD CHOICES - REAR					BRAKE ROTOR CHOICES - REAR					
	CX Extreme® /Vee-Rotor	OSX Series Oversize 280mm Rotor Kit	Relocating Bracket for Oversize Rotor	SMX Series Oversize 320mm Rotor Kit	Relocating Bracket for 320mm Rotor	Front Disc Bolt Kit	FA/SFA/X Pad or Brake Shoe	Specialty Pads SXR/ VEE/MXS Race	Sintered/ HH Pads/ Grooved Shoes	EPFA Sintered Fast Road/ Track Pads	SV Series Severe Duty Pads	Standard Rotor	Vintage Rotor / UTV Oversize Brake Kit	Contour Profile Rotor	CX Extreme® /Vee-Rotor	Rear Disc Bolt Kit
1							FA355/4X		FA355/4R			MD6268D				
2							SFA356		SFA356HH			MD974D				
3							SFA197		SFA197HH			MD9100D				
4							SFA607		SFA607HH							
5																
6							321									
7							SFA607		SFA607HH							
8							FA377X		FA377R							
9							FA377X		FA377R							
10							FA377X		FA377R							
11							FA377X		FA377R			MD6267D				
12	VR9128						SFA498		SFA498HH			MD9129D				
13							SFA607		SFA607HH							
14							SFA498		SFA498HH							
15							SFA498		SFA498HH							
16							FA395X		FA395R		FA395SV	MD6173D	UTVX6173			
17							FA395X		FA395R		FA395SV	MD6173D	UTVX6173			
18							FA395X		FA395R		FA395SV	MD6173D	UTVX6173			
19							FA395X		FA395R		FA395SV	MD6173D	UTVX6173			
20							FA395X		FA395R		FA395SV	MD6173D	UTVX6173			
21							FA395X		FA395R		FA395SV	MD6173D	UTVX6173			
22							FA395X		FA395R		FA395SV	MD6173D	UTVX6173			
23							FA395X		FA395R		FA395SV	MD6173D	UTVX6173			
24							FA377X		FA377R							
25							FA377X*		FA377R*							
26							FA600/2X*		FA600/2R*			MD6376D	UTVX6376			
27							FA600/2X*		FA600/2R*			MD6376D	UTVX6376			
28							FA377X		FA377R			MD6376D	UTVX6376			
29							FA377X		FA377R			MD6376D	UTVX6376			
30							SFA608		SFA608HH							
31							SFA719		SFA719HH			MD9173D				
32							FA600/2X*		FA600/2R*			MD6376D	UTVX6376			
33							FA377X		FA377R			MD6376D	UTVX6376			
34							SFA607		SFA607HH							
35																
36																
37							FA47		FA47HH							
38	VR2003BLK*†						FA47		FA47HH			MD2002				DB201/6
39	VR2003BLK*†						FA47		FA47HH			MD2002				DB201/6
40	VR2003BLK*†						FA47		FA47HH			MD2002				DB201/6
41	VR2003BLK*†						FA47		FA47HH			MD2002				DB201/6
42	VR2003BLK*†						FA47		FA47HH			MD2002				DB201/6
43							FA18		FA18HH							
44							FA18		FA18HH							
45							FA18		FA18HH			MD609LS				
46							FA18		FA18HH							
47																
48																
49																
50																
51																
52							FA165/2X									
53																
54																
55							FA132X		FA132R							
56																

BRAKE APPLICATIONS
 * This symbol indicates a rotor made of billet steel, and should be only used with EBC FA Organic or Vee pads.
 SAFETY NOTICE - With vehicles primarily designed for off highway use such as quads now being used on the highway, we would recommend the use of X or MXS pads for highway use and ONLY using the R and SV higher density / harder pad series for off road riding.

*-2 Sets Required. † For Vee disc colours add RED, BLU, GRN, GLD, ORG suffix to part number. **SAFETY WARNING:- DO NOT USE HH PADS ON REAR UNLESS ALSO USED ON FRONT TO AVOID BRAKE IMBALANCE**

FRONT: Non-Japanese Bikes

APPLICATIONS
BRAKE



MAICO/M-STAR



Front rotor models 1985	1985
Most 1986 models	1986
Rotor Models	1986
Rotor Models	1987-1988
Rotor Models	1989-1996
Rotor Models	1997-1999
MX 500	1995

MALAGUTI

Ciak 50	2002-2004
F10 Jet Line	2002-2004
F12 Phantom	1998-2004
F12 Phantom	1998-2004
F15 Firefox	2002-2003
F15 Firefox	2004
Phantom F12 Foggy Replica	2000-2002
Yesterday 50	1998-2004
Ciak 150	2002-2003
F18	2002-2004

MONTESA

4RT Cota	2005-2008
4RT Cota Repsol Edition 260/301	2014-2021
4RT Cota Standard Edition 260	2009-2023
4RT Cota 301	2016-2023
314 R	1994-1996
315 R	1997-2000
315 R	2001-2004

MOTO-GUZZI

V50 /50 III - 500	1977-1984
V50 C - 500	1982-1986
Nevada 350	1992-1997
Nevada Club 350	1998-1999
NTX 350	1987-1990
V35 /35 II/35 III - 350	1977-1987
V35 C - 350	1982-1986
V35 Florida - 350	1986-1990
NTX 650	1987-1990
V65 C - 650	1982-1985
V65 Florida - 650	1986-1992
750 SP	1990-1992
750 Targa	1990-1992
Breva V750 ie	2003-2008
California Vintage 750	2006-2010
Nevada 750	1991-1997
Nevada 750 Base/Club	2002-2003
Nevada Classic 750ie	2004-2009
Nevada Club 750	1998-2001
Nevada Club 750	1998-2001
V7 750 III Carbon	2018-2021
V7 750 III Limited	2018-2021
V7 750 III Racer	2018-2021
V7 750 III Rough	2018-2021
V7 750 III Special	2018-2023
V7 750 III Stone	2018-2023

FA/SFA/X Pad or Brake Shoe	DISC PAD CHOICES - FRONT					BRAKE ROTOR CHOICES - FRONT				Line #
	Specialty Pads SXR/ VEE/MXS Race	Sintered/ HH Pads/ Grooved Shoes	EPFA Sintered Fast Road/Track Pads	GPFAX Sintered RACE ONLY Pads	SV Series Severe Duty Pads	Standard Rotor Left	Standard Rotor Right	Vintage Rotor / UTV Oversize Brake Kit	Contour Profile Rotor	
FA47X										1
FA106/2X		FA106/2R								2
FA99X										3
FA99X										4
FA115X	MXS115	FA115R								5
FA181X	MXS181	FA181R	EPFA181HH							6
FA132X		FA132R								7
										8
										9
SFA193		SFA193HH				MD955D				10
SFA193		SFA193HH				MD915D				11
SFA116						MD946D				12
SFA193		SFA193HH				MD946D				13
SFA116						MD901D				14
SFA116						MD946D				15
SFA193		SFA193HH				MD946D				16
SFA116						MD915D				17
SFA47		SFA47HH				MD955D				18
SFA47		SFA47HH								19
										20
										21
FA303X										22
FA644X										23
FA303X										24
FA644X										25
FA115X	MXS115									26
FA115X	MXS115									27
FA303X										28
										29
										30
FA47*		FA47HH*								31
FA47*		FA47HH*								32
FA47*		FA47HH*								33
FA47*		FA47HH*								34
FA47		FA47HH								35
FA47*		FA47HH*								36
FA47*		FA47HH*								37
FA47*		FA47HH*								38
FA47		FA47HH								39
FA47*		FA47HH*								40
FA47*		FA47HH*								41
FA47*		FA47HH*								42
FA47*		FA47HH*								43
FA244		FA244HH	EPFA244HH			MD614X			MD614XC	44
FA244		FA244HH				MD614X	MD614X		MD614XC*	45
FA47*		FA47HH*								46
FA244		FA244HH	EPFA244HH			MD614X			MD614XC	47
FA244		FA244HH	EPFA244HH			MD614X			MD614XC	48
FA47*		FA47HH*								49
FA47*		FA47HH*								50
FA244		FA244HH								51
FA244		FA244HH								52
FA244		FA244HH								53
FA244		FA244HH								54
FA244		FA244HH								55
FA244		FA244HH								56

FRONT

⚡ This symbol indicates a rotor made of billet steel, and should be only used with EBC FA Organic or Vee pads.
SAFETY NOTICE - With vehicles primarily designed for off highway use such as quads now being used on the highway, we would recommend the use of X or MXS pads for highway use and ONLY using the R and SV higher density / harder pad series for off road riding.

*-2 Sets Required. † For Vee disc colours add RED, BLU, GRN, GLD, ORG suffix to part number. SAFETY WARNING:- DO NOT USE HH PADS ON REAR UNLESS ALSO USED ON FRONT TO AVOID BRAKE IMBALANCE

FRONT: Non-Japanese Bikes Cont'd

REAR: Non-Japanese Bikes

Line #	BRAKE ROTOR CHOICES - FRONT					DISC PAD CHOICES - REAR					BRAKE ROTOR CHOICES - REAR					
	CX Extreme® /Vee-Rotor	OSX Series Oversize 280mm Rotor Kit	Relocating Bracket for Oversize Rotor	SMX Series Oversize 320mm Rotor Kit	Relocating Bracket for 320mm Rotor	Front Disc Bolt Kit	FA/SFA/X Pad or Brake Shoe	Specialty Pads SXR/ VEE/MXS Race	Sintered/ HH Pads/ Grooved Shoes	EPFA Sintered Fast Road/ Track Pads	SV Series Severe Duty Pads	Standard Rotor	Vintage Rotor / UTV Oversize Brake Kit	Contour Profile Rotor	CX Extreme® /Vee-Rotor	Rear Disc Bolt Kit
1								822G								
2							FA106/2X		FA106/2R							
3								841G								
4							FA99X									
5							FA115X	MXS115	FA115R							
6							FA208X	MXS208	FA208R							
7							FA67X		FA67R							
8																
9																
10							893									
11							893									
12							SFA193					MD901D				
13							SFA193	SFA193HH				MD901D				
14							893									
15							SFA193					MD901D				
16							SFA193	SFA193HH				MD901D				
17							893									
18							818									
19							SFA298	SFA298HH								
20																
21																
22							FA351X									
23							FA351X									
24							FA351X									
25							FA351X									
26							FA47X		FA47R							
27							FA47X		FA47R							
28							FA351X									
29																
30																
31							FA47		FA47HH							
32							FA47		FA47HH							
33							FA47		FA47HH							
34							FA47		FA47HH							
35							FA47		FA47HH							
36							FA47		FA47HH							
37							FA47		FA47HH							
38							FA47		FA47HH							
39							FA47		FA47HH							
40							FA47		FA47HH							
41							FA47		FA47HH							
42							FA47		FA47HH							
43							FA47		FA47HH							
44	VR614BLK						FA266		FA266HH	EPFA266HH		MD871				
45	VR614BLK						FA209/2		FA209/2HH			MD692		MD692C		
46							FA47		FA47HH							
47	VR614BLK						FA266		FA266HH	EPFA266HH		MD871				
48	VR614BLK						FA266		FA266HH	EPFA266HH		MD871				
49							FA47		FA47HH							
50							FA266		FA266HH	EPFA266HH		MD871				
51							FA256		FA256HH							
52							FA256		FA256HH							
53							FA256		FA256HH							
54							FA256		FA256HH							
55							FA256		FA256HH							
56							FA256		FA256HH							

⚠ This symbol indicates a rotor made of billet steel, and should be only used with EBC FA Organic or Vee pads.
SAFETY NOTICE - With vehicles primarily designed for off highway use such as quads now being used on the highway, we would recommend the use of X or MXS pads for highway use and ONLY using the R and SV higher density / harder pad series for off road riding.

*-2 Sets Required. † For Vee disc colours add RED, BLU, GRN, GLD, ORG suffix to part number. **SAFETY WARNING:- DO NOT USE HH PADS ON REAR UNLESS ALSO USED ON FRONT TO AVOID BRAKE IMBALANCE**

FRONT: Non-Japanese Bikes

APPLICATIONS

BRAKE



MOTO-GUZZI



DISC PAD CHOICES - FRONT

BRAKE ROTOR CHOICES - FRONT

			FA/SFA/X Pad or Brake Shoe	Specialty Pads SXR/ VEE/MXS Race	Sintered/ HH Pads/ Grooved Shoes	EPFA Sintered Fast Road/Track Pads	GPFAX Sintered RACE ONLY Pads	SV Series Severe Duty Pads	Standard Rotor Left	Standard Rotor Right	Vintage Rotor / UTV Oversize Brake Kit	Contour Profile Rotor	Line #
V75 - 750		1992-1996	FA47*		FA47HH*								1
850 II/III Le Mans		1978-1984	FA18*		FA18HH*								2
850 T3/T4/T5		1979-1988	FA18*		FA18HH*								3
V 85 TT		2019-2023			FA244HH*				MD614X	MD614X			4
V 85 TT Adventure		2023-2024			FA244HH*				MD614X	MD614X			5
V 85 TT Centenario		2023-2024			FA244HH*				MD614X	MD614X			6
V 85 TT Guardia d'Onore		2023-2024			FA244HH*				MD614X	MD614X			7
V 85 TT Travel		2019-2024			FA244HH*				MD614X	MD614X			8
V7 850 III Special		2021-2023	FA244		FA244HH								9
V7 850 III Special Edition		2023	FA244		FA244HH								10
V7 850 III Stone		2021-2023	FA244		FA244HH								11
V7 850 III Stone Centenario		2023	FA244		FA244HH								12
V7 Café Classic		2011-2012	FA244		FA244HH	EPFA244HH			MD614X			MD614XC	13
V7 Classic		2008-2012	FA244		FA244HH	EPFA244HH			MD614X			MD614XC	14
V7 Racer		2010-2011	FA244		FA244HH	EPFA244HH			MD614X			MD614XC	15
V7 Racer		2012-2015	FA244		FA244HH	EPFA244HH			MD614X			MD614XC	16
V7 Special		2012-2015	FA244		FA244HH	EPFA244HH			MD614X			MD614XC	17
V7 Stone		2012-2015	FA244		FA244HH	EPFA244HH			MD614X			MD614XC	18
V9 Bobber Centenario		2023-2024	FA244		FA244HH				MD859				19
V9 Bobber Special Edition		2023-2024	FA244		FA244HH				MD859				20
V9 Bobber/Sport		2018-2024	FA244		FA244HH				MD859				21
V9 Roamer		2018-2021	FA244		FA244HH				MD859				22
1000 GT		1987-1991	FA18*		FA18HH*								23
1000 Le Mans		1984-1993	FA18*		FA18HH*				MD693LS	MD693RS			24
1000 MGS-01		2004-2005			FA322/4HH*	EPFA322/4HH*			MD621X	MD621X		MD621XC*	25
1000 S		1989-1994	FA18*		FA18HH*								26
1000 SP II/III		1983-1994	FA18*		FA18HH*								27
1000 Strada		1993-1994	FA18*		FA18HH*								28
California 1000 II/III		1983-1993	FA18*		FA18HH*				MD835	MD835			29
Daytona 1000		1992-1995	FA95*		FA95HH*	EPFA95HH			MD667	MD667			30
Daytona 1000 RS		1997-1998	FA95*		FA95HH*	EPFA95HH							31
Quota 1000		1992-1997	FA126X*		FA126HH*								32
V10 Centauro		1997-1999	FA95*		FA95HH*				MD614X	MD614X		MD614XC*	33
V100 Mandello		2021-2024			FA630HH*	EPFA630HH*							34
V100 Mandello S		2022-2024			FA630HH*	EPFA630HH*							35
Breva 1100		2002-2007	FA244*		FA244HH*				MD2003X	MD2003X		MD2003XC*	36
Breva 1100		2005-2012	FA244*		FA244HH*				MD624	MD624			37
California 1100		1994-1997	FA18*		FA18HH*				MD835	MD835			38
California EV/Special Series		2002-2006	FA244*	FA244V*	FA244HH*				MD614X	MD614X		MD614XC*	39
California EVII		1997-2001	FA95*	FA95V*	FA95HH*				MD614X	MD614X		MD614XC*	40
California Jacket 1100		1999-2001	FA244*	FA244V*	FA244HH*				MD614X	MD614X		MD614XC*	41
California Special 1100		1999-2001	FA244*	FA244V*	FA244HH*				MD614X	MD614X		MD614XC*	42
California Stone Series		2002-2006	FA244	FA244V	FA244HH				MD614X			MD614XC	43
Griso 1100		2005-2012	FA244*		FA244HH*				MD621X	MD621X		MD621XC*	44
Quota 1100 ES		1999-2001	FA209/2*		FA209/2HH*								45
Sport 1100		1994-1999	FA95*		FA95HH*				MD614X	MD614X		MD614XC*	46
Sport Corsa 1100		1998-1999	FA95*		FA95HH*								47
VII Le Mans Series		2001-2006	FA244*		FA244HH*				MD614X	MD614X		MD614XC*	48
VII Sport/Scura/Naked		1999-2000	FA244*		FA244HH*				MD614X	MD614X		MD614XC*	49
Griso 1200 8V		2009-2012	FA244*		FA244HH*				MD2003X	MD2003X		MD621XC*	50
Griso SE 1200 8V		2009-2019	FA244*		FA244HH*				MD2003X	MD2003X		MD621XC*	51
Norge 1200 GT 4V		2006-2012	FA244*		FA244HH*				MD624	MD624			52
Norge 1200 GT 8V		2010-2019	FA244*		FA244HH*				MD2003X	MD2003X			53
Stelvio 1200 NTX		2009-2019	FA244*		FA244HH*				MD2003X	MD2003X			54
California 1400 Custom		2013-2019	FA244*		FA244HH*				MD2003X	MD2003X			55
California 1400 Touring		2013-2019	FA244*	FA244V*	FA244HH*				MD2003X	MD2003X			56

FRONT

⚠ This symbol indicates a rotor made of billet steel, and should be only used with EBC FA Organic or Vee pads.

SAFETY NOTICE - With vehicles primarily designed for off highway use such as quads now being used on the highway, we would recommend the use of X or MXS pads for highway use and ONLY using the R and SV higher density / harder pad series for off road riding.

*-2 Sets Required. † For Vee disc colours add RED, BLU, GRN, GLD, ORG suffix to part number. **SAFETY WARNING:- DO NOT USE HH PADS ON REAR UNLESS ALSO USED ON FRONT TO AVOID BRAKE IMBALANCE**

FRONT: Non-Japanese Bikes Cont'd

REAR: Non-Japanese Bikes

Line #	BRAKE ROTOR CHOICES - FRONT					DISC PAD CHOICES - REAR					BRAKE ROTOR CHOICES - REAR				
	CX Extreme® /Vee-Rotor	OSX Series Oversize 280mm Rotor Kit	Relocating Bracket for Oversize Rotor	SMX Series Oversize 320mm Rotor Kit	Relocating Bracket for 320mm Rotor	Front Disc Bolt Kit	FA/SFA/X Pad or Brake Shoe	Specialty Pads SXR/ VEE/MXS Race	Sintered/ HH Pads/ Grooved Shoes	EPFA Sintered Fast Road/ Track Pads	SV Series Severe Duty Pads	Standard Rotor	Vintage Rotor / UTV Oversize Brake Kit	Contour Profile Rotor	CX Extreme® /Vee-Rotor
1							FA47		FA47HH						
2							FA18		FA18HH						
3							FA18		FA18HH						
4							FA256		FA256HH						
5							FA256		FA256HH						
6							FA256		FA256HH						
7							FA256		FA256HH						
8							FA256		FA256HH						
9							FA256		FA256HH						
10							FA256		FA256HH						
11							FA256		FA256HH						
12							FA256		FA256HH						
13	VR614BLK						FA266		FA266HH	EPFA266HH		MD871			
14	VR614BLK						FA266		FA266HH	EPFA266HH		MD871			
15	VR614BLK						FA266		FA266HH	EPFA266HH		MD871			
16	VR614BLK						FA256		FA256HH						
17	VR614BLK						FA256		FA256HH						
18	VR614BLK						FA256		FA256HH						
19							FA256		FA256HH			MD871			
20							FA256		FA256HH			MD871			
21							FA256		FA256HH			MD871			
22							FA256		FA256HH			MD871			
23							FA18		FA18HH						
24							FA18		FA18HH						
25	VR621BLK*						FA266		FA266HH	EPFA266HH					
26							FA18		FA18HH						
27							FA18		FA18HH						
28							FA18		FA18HH						
29							FA18		FA18HH						
30							FA47		FA47HH						
31							FA47		FA47HH						
32							FA163								
33	VR614BLK*						FA47		FA47HH						
34									FA181HH						
35									FA181HH						
36	VR2003BLK*						FA181X		FA181HH						
37	VR624BLK*						FA181X		FA181HH			MD840			
38							FA18		FA18HH						
39	VR614BLK*						FA209/2		FA209/2HH			MD692		MD692C	
40	VR614BLK*						FA209/2		FA209/2HH						
41	VR614BLK*						FA209/2		FA209/2HH						
42	VR614BLK*						FA209/2		FA209/2HH						
43	VR614BLK*						FA209/2		FA209/2HH			MD692		MD692C	
44	VR621BLK*						FA181X		FA181HH			MD840		MD840C	
45							FA181X		FA181HH						
46	VR614BLK*						FA47		FA47HH						
47							FA47		FA47HH						
48	VR614BLK*						FA47		FA47HH			MD692		MD692C	
49	VR614BLK*						FA47		FA47HH			MD692		MD692C	
50	VR621BLK*						FA181X		FA181HH			MD840		MD840C	
51	VR621BLK*						FA181X		FA181HH			MD840		MD840C	
52	VR624BLK*						FA181X		FA181HH			MD840			
53							FA181X		FA181HH			MD840			
54							FA181X		FA181HH			MD840			
55							FA209/2		FA209/2HH			MD840			
56							FA209/2		FA209/2HH			MD840			

BRAKE APPLICATIONS
 * This symbol indicates a rotor made of billet steel, and should be only used with EBC FA Organic or Vee pads.
 SAFETY NOTICE - With vehicles primarily designed for off highway use such as quads now being used on the highway, we would recommend the use of X or MXS pads for highway use and ONLY using the R and SV higher density / harder pad series for off road riding.

*-2 Sets Required. † For Vee disc colours add RED, BLU, GRN, GLD, ORG suffix to part number. **SAFETY WARNING:- DO NOT USE HH PADS ON REAR UNLESS ALSO USED ON FRONT TO AVOID BRAKE IMBALANCE**

FRONT: Non-Japanese Bikes Cont'd

REAR: Non-Japanese Bikes

Line #	BRAKE ROTOR CHOICES - FRONT					REAR	DISC PAD CHOICES - REAR					BRAKE ROTOR CHOICES - REAR				
	CX Extreme® /Vee-Rotor	OSX Series Oversize 280mm Rotor Kit	Relocating Bracket for Oversize Rotor	SMX Series Oversize 320mm Rotor Kit	Relocating Bracket for 320mm Rotor		Front Disc Bolt Kit	FA/SFA/X Pad or Brake Shoe	Specialty Pads SXR/ VEE/MXS Race	Sintered/ HH Pads/ Grooved Shoes	EPFA Sintered Fast Road/ Track Pads	SV Series Severe Duty Pads	Standard Rotor	Vintage Rotor / UTV Oversize Brake Kit	Contour Profile Rotor	CX Extreme® /Vee-Rotor
1							FA209/2		FA209/2HH			MD840				
2																
3																
4							FA266		FA266HH	EPFA266HH		MD885		MD885C		
5							FA266		FA266HH	EPFA266HH		MD885		MD885C		
6							FA266		FA266HH	EPFA266HH		MD885		MD885C		
7									FA320HH			MD696				
8									FA320HH			MD696				
9							FA266		FA266HH	EPFA266HH		MD885		MD885C		
10							FA266		FA266HH	EPFA266HH		MD885		MD885C		
11							FA266		FA266HH	EPFA266HH		MD885		MD885C		
12							FA266		FA266HH	EPFA266HH		MD885		MD885C		
13							FA266		FA266HH	EPFA266HH						
14							FA266		FA266HH	EPFA266HH						
15							FA266		FA266HH	EPFA266HH		MD885		MD885C		
16							FA266		FA266HH	EPFA266HH		MD885		MD885C		
17									FA320HH			MD696				
18									FA320HH			MD696				
19									FA320HH			MD696				
20									FA320HH			MD696				
21									FA320HH							
22									FA320HH			MD696				
23									FA320HH			MD696				
24									FA320HH			MD696				
25									FA320HH			MD696				
26									FA320HH			MD696				
27									FA320HH			MD696				
28									FA320HH			MD696				
29									FA320HH			MD696				
30									FA320HH			MD696				
31									FA320HH			MD696				
32									FA320HH			MD696				
33									FA320HH			MD696				
34																
35																
36							503									
37																
38							FA165/2X									
39							FA165/2X									
40							978									
41							FA173									
42							FA173									
43							FA47		FA47HH			MD637				
44							FA254		FA254HH							
45																
46																
47																
48																
49																
50																
51																
52																
53																
54									FA602R			MD904D				
55																
56																

⚠ This symbol indicates a rotor made of billet steel, and should be only used with EBC FA Organic or Vee pads.
SAFETY NOTICE - With vehicles primarily designed for off highway use such as quads now being used on the highway, we would recommend the use of X or MXS pads for highway use and ONLY using the R and SV higher density / harder pad series for off road riding.

*-2 Sets Required. † For Vee disc colours add RED, BLU, GRN, GLD, ORG suffix to part number. **SAFETY WARNING:- DO NOT USE HH PADS ON REAR UNLESS ALSO USED ON FRONT TO AVOID BRAKE IMBALANCE**

FRONT: Non-Japanese Bikes

APPLICATIONS
BRAKE



PEUGEOT



DISC PAD CHOICES - FRONT

BRAKE ROTOR CHOICES - FRONT

Model	Year	FA/SFA/X Pad or Brake Shoe	Specialty Pads SXR/VEE/MXS Race	Sintered/HH Pads/Grooved Shoes	EPFA Sintered Fast Road/Track Pads	GPFAX Sintered RACE ONLY Pads	SV Series Severe Duty Pads	Standard Rotor		Vintage Rotor / UTV Oversize Brake Kit	Contour Profile Rotor	Line #
								Standard Rotor Left	Standard Rotor Right			
Scoot Elec Electric	2004-2005	303										1
Elyseo 50	2002	SFA115		SFA115HH				MD901D				2
Elyseo 50	2003-2005	SFA115		SFA115HH				MD901D				3
Elystar 50 P	2003-2005	SFA115		SFA115HH				MD947D				4
Jet Force 50	2003-2005	SFA115		SFA115HH								5
Looxor 50	2002-2005	SFA115		SFA115HH				MD954D				6
Ludix 50 Elegance/Ambition	2004-2005	SFA115		SFA115HH				MD901D				7
Ludix 50 Trend/One/Snake/Bullet	2004-2005	SFA115		SFA115HH				MD904D				8
Metal-X All models	2002-2005	SFA115		SFA115HH				MD901D				9
Speedfight 2 X-Team 50	2002-2005	SFA115		SFA115HH				MD925D				10
Trekker 50	2002-2005	SFA115		SFA115HH				MD901D				11
Vivacity X-Race/Pulsa 50	2002-2005	SFA115		SFA115HH				MD901D				12
X Race 50 LNDP LC/100 NP AC Speedfight	2003-2005	SFA115		SFA115HH				MD925D				13
Elyseo 100	2003-2005	SFA115		SFA115HH				MD947D				14
Looxor 100	2002-2005	SFA115		SFA115HH				MD954D				15
Elyseo 125/150	2003-2005	SFA194		SFA194HH				MD977D				16
Elystar 125/150 P	2003-2005	SFA194		SFA194HH				MD980D				17
Jet Force 125 EFI/Compressor	2003-2005	SFA194		SFA194HH								18
Ludix 125	2004-2005	SFA115		SFA115HH				MD901D				19
PIAGGIO												
WI-Bike Active Electric	2019-2020	CFA327		CFA327HH								20
WI-Bike Comfort Electric	2019-2020	CFA327		CFA327HH								21
Fly 50	2005-2006	SFA353		SFA353HH				MD910D				22
Fly 50	2007-2010	SFA353		SFA353HH				MD910D				23
Fly 50	2011-2015	SFA353		SFA353HH				MD910D				24
Liberty 50	2017-2023	SFA353		SFA353HH				MD959D				25
Liberty 50 S	2017-2023	SFA353		SFA353HH				MD959D				26
LT 50	1997-2005	SFA260		SFA260HH				MD956D				27
Typhoon 50	2007-2009	SFA83/2		SFA83/2HH				MD9126D				28
Typhoon 50	2010-2020	SFA83/2		SFA83/2HH				MD9126D				29
Typhoon 50	2012-2015	SFA353		SFA353HH								30
Typhoon 50/SE	2006	SFA83/2		SFA83/2HH				MD9126D				31
Typhoon 125	2010-2020	SFA353		SFA353HH								32
Fly 150	2006-2012	SFA353		SFA353HH				MD910D				33
Fly 150	2013-2020	SFA353		SFA353HH				MD9126D				34
Liberty 150	2017-2023	SFA353		SFA353HH				MD959D				35
Liberty 150 S	2017-2023	SFA353		SFA353HH				MD959D				36
LT 150	1998-2005	SFA260		SFA260HH				MD956D				37
BV 200	2002-2006	SFA194		SFA194HH				MD961D				38
BV 250	2006-2011	SFA353		SFA353HH				MD961D				39
MP3 3 Wheeler	2007-2009	SFA257/2										40
MP3 3 Wheeler	2010-2015	SFA260*		SFA260HH*				MD9112D	MD9112D			41
MP3 3 Wheeler	2007-2009	SFA260*		SFA260HH*				MD9112D	MD9112D			42
MP3 3 Wheeler	2010-2015	SFA257/2										43
BV 300 Tourer	2010-2012	SFA353		SFA353HH				MD9172D				44
BV 350	2012-2020	SFA353		SFA353HH				MD9172D				45
MP3 400 ie	2006-2015	SFA260*		SFA260HH*				MD9112D	MD9112D			46
MP3 400 ie	2006-2015	SFA257/2										47
BV 500	2006-2012	SFA266*		SFA266HH*				MD961D	MD961D			48
MP3 500	2007-2014	SFA260*		SFA260HH*				MD9112D	MD9112D			49
MP3 500	2007-2014	SFA257/2										50
MP3 500	2015-2016	SFA681*		SFA681HH*				MD9158D	MD9158D			51
MP3 500 Sport	2015-2020	SFA257/2										52
X9 500 Evolution	2005-2009	SFA181*		SFA181HH*				MD983D	MD983D			53

*-2 Sets Required. † For Vee disc colours add RED, BLU, GRN, GLD, ORG suffix to part number. **SAFETY WARNING:- DO NOT USE HH PADS ON REAR UNLESS ALSO USED ON FRONT TO AVOID BRAKE IMBALANCE**

This symbol indicates a rotor made of billet steel, and should be only used with EBC FA Organic or Vee pads.
 SAFETY NOTICE - With vehicles primarily designed for off highway use such as quads now being used on the highway, we would recommend the use of X or MXS pads for highway use and ONLY using the R and SV higher density / harder pad series for off road riding.

FRONT: Non-Japanese Bikes Cont'd

REAR: Non-Japanese Bikes

Line #	BRAKE ROTOR CHOICES - FRONT					DISC PAD CHOICES - REAR					BRAKE ROTOR CHOICES - REAR					
	CX Extreme® /Vee-Rotor	OSX Series Oversize 280mm Rotor Kit	Relocating Bracket for Oversize Rotor	SMX Series Oversize 320mm Rotor Kit	Relocating Bracket for 320mm Rotor	Front Disc Bolt Kit	FA/SFA/X Pad or Brake Shoe	Specialty Pads SXR/ VEE/MXS Race	Sintered/ HH Pads/ Grooved Shoes	EPFA Sintered Fast Road/ Track Pads	SV Series Severe Duty Pads	Standard Rotor	Vintage Rotor / UTV Oversize Brake Kit	Contour Profile Rotor	CX Extreme® /Vee-Rotor	Rear Disc Bolt Kit
1								303								
2								303								
3								SFA115	SFA115HH			MD925D				
4								SFA350	SFA350HH			MD978D				
5								SFA115	SFA115HH			MD901D				
6								303								
7								303								
8								303								
9								303								
10								303								
11								303								
12								303								
13								SFA115	SFA115HH			MD925D				
14								SFA115	SFA115HH			MD925D				
15								SFA115	SFA115HH			MD901D				
16								SFA350	SFA350HH			MD978D				
17								SFA350	SFA350HH			MD978D				
18								SFA350	SFA350HH			MD978D				
19								303								
20																
21																
22								CFA327	CFA327HH							
23								CFA327	CFA327HH							
24								816								
25								816								
26								816								
27								816								
28								816								
29								816								
30								893								
31								893								
32								816								
33								899								
34								816								
35								816								
36								SFA321	SFA321HH			MD956D				
37								816								
38								816								
39								816								
40								SFA194	SFA194HH			MD961D				
41								SFA353	SFA353HH			MD961D				
42																
43		MD9175D						SFA418	SFA418HH			MD960D				
44		MD9175D						SFA425	SFA425HH			MD960D				
45																
46	VR9172							SFA353	SFA353HH			MD9155D			VR9155	
47	VR9172							SFA418	SFA418HH			MD9164D			VR9164	
48								SFA353	SFA353HH			MD960D				
49																
50								SFA266	SFA266HH			MD960D				
51								SFA353	SFA353HH			MD960D				
52																
53								SFA353	SFA353HH			MD960D				
54																
55								SFA266	SFA266HH			MD960D				
56																

⚠ This symbol indicates a rotor made of billet steel, and should be only used with EBC FA Organic or Vee pads.
SAFETY NOTICE - With vehicles primarily designed for off highway use such as quads now being used on the highway, we would recommend the use of X or MXS pads for highway use and ONLY using the R and SV higher density / harder pad series for off road riding.

*-2 Sets Required. † For Vee disc colours add RED, BLU, GRN, GLD, ORG suffix to part number. **SAFETY WARNING:- DO NOT USE HH PADS ON REAR UNLESS ALSO USED ON FRONT TO AVOID BRAKE IMBALANCE**

FRONT: Non-Japanese Bikes Cont'd

REAR: Non-Japanese Bikes

Line #	BRAKE ROTOR CHOICES - FRONT					DISC PAD CHOICES - REAR					BRAKE ROTOR CHOICES - REAR					BRAKE APPLICATIONS
	CX Extreme® /Vee-Rotor	OSX Series Oversize 280mm Rotor Kit	Relocating Bracket for Oversize Rotor	SMX Series Oversize 320mm Rotor Kit	Relocating Bracket for 320mm Rotor	Front Disc Bolt Kit	FA/SFA/X Pad or Brake Shoe	Specialty Pads SXR/ VEE/MXS Race	Sintered/ HH Pads/ Grooved Shoes	EPFA Sintered Fast Road/ Track Pads	SV Series Severe Duty Pads	Standard Rotor	Vintage Rotor / UTV Oversize Brake Kit	Contour Profile Rotor	CX Extreme® /Vee-Rotor	
1								FA690X*		FA690R*						
2								FA690X*		FA690R*						
3								FA690X*		FA690R*						
4								FA690X*		FA690R*						
5								FA690X*		FA690R*						
6								FA690X*		FA690R*						
7																
8																
9								FA213		FA213HH						
10								FA213		FA213HH						
11								FA213		FA213HH						
12								FA208X		FA208R			MD894			
13								FA208X		FA208R			MD894			
14																
15								FA213		FA213HH			MD651			
16																
17								FA213		FA213HH			MD651			
18																
19								FA213		FA213HH			MD651			
20																
21																
22								FA213		FA213HH			MD651			
23								FA213		FA213HH			MD877			
24								FA213		FA213HH			MD894			
25								FA213		FA213HH			MD894			
26																
27																
28								SFA54		SFA54HH						
29								SFA54		SFA54HH						
30																
31																
32								FA351X								
33								FA351X								
34								FA350X								
35								FA351X								
36								FA351X								
37								FA351X								
38								FA351X								
39																
40								FA351X								
41								FA351X								
42								FA351X								
43								FA351X								
44								FA115X		FA115HH						
45								FA350X								
46								FA351X								
47																
48																
49																
50																
51																
52								FA83X		FA83R						
53								FA83X		FA83R						
54								FA83X		FA83R						
55								FA83X		FA83R						
56								FA83X		FA83R						

⚠ This symbol indicates a rotor made of billet steel, and should be only used with EBC FA Organic or Vee pads.
SAFETY NOTICE - With vehicles primarily designed for off highway use such as quads now being used on the highway, we would recommend the use of X or MXS pads for highway use and ONLY using the R and SV higher density / harder pad series for off road riding.

*-2 Sets Required. † For Vee disc colours add RED, BLU, GRN, GLD, ORG suffix to part number. **SAFETY WARNING:- DO NOT USE HH PADS ON REAR UNLESS ALSO USED ON FRONT TO AVOID BRAKE IMBALANCE**

FRONT: Non-Japanese Bikes

APPLICATIONS

BRAKE



SHERCO



DISC PAD CHOICES - FRONT

BRAKE ROTOR CHOICES - FRONT

Model	Year	FA/SFA/X Pad or Brake Shoe	Specialty Pads SXR/ VEE/MXS Race	Sintered/ HH Pads/ Grooved Shoes	EPFA Sintered Fast Road/Track Pads	GPFAX Sintered RACE ONLY Pads	SV Series Severe Duty Pads	Standard Rotor		Vintage Rotor / UTV Oversize Brake Kit	Contour Profile Rotor	Line #
								Standard Rotor Left	Standard Rotor Right			
50cc Factory SM-RS	2019-2021	FA83X		FA83R								1
125 FST	2018-2019	FA303X										2
125 SC-Factory	2019-2021	FA181X	MXS181	FA181R							MD6426C	3
125 SE-Factory	2019-2024	FA181X	MXS181	FA181R							MD6426C	4
125 SE-R	2019-2021	FA181X	MXS181	FA181R							MD6426C	5
125 ST-R	2018-2019	FA303X										6
125 TY Classic	2018-2019	FA303X										7
125 X-Ride	2019-2021	FA83X		FA83R								8
ST 1.25	2012-2014	FA612X		FA612R								9
0.5/0.8/1.25/2.0	2003-2010	FA115X	MXS115	FA115R								10
2.5i Enduro	2005-2010	FA181X	MXS181	FA181R	EPFA181HH							11
250 SC-Factory	2019-2021	FA181X	MXS181	FA181R							MD6429C	12
250 SCF-Factory	2019-2021	FA181X	MXS181	FA181R							MD6429C	13
250 SE-Factory	2019-2024	FA181X	MXS181	FA181R							MD6429C	14
250 SEF-Factory	2019-2024	FA181X	MXS181	FA181R							MD6429C	15
250 SEF-R	2019-2021	FA181X	MXS181	FA181R							MD6429C	16
250 SE-R	2019-2021	FA181X	MXS181	FA181R							MD6429C	17
250 SE-Racing	2021-2023	FA181X	MXS181	FA181R							MD6429C	18
250 ST Factory	2018-2019	FA303X										19
250 ST-R	2018-2019	FA303X										20
ST 2.5	2012-2014	FA612X		FA612R								21
ST 2.9	2012-2014	FA612X		FA612R								22
2.5/2.9	2003-2009	FA303X										23
290 X-Ride	2012-2014	FA83X		FA83R								24
300 FST	2018-2019	FA303X										25
300 SC-Factory	2019-2021	FA181X	MXS181	FA181R							MD6429C	26
300 SCF-Factory	2019-2021	FA181X	MXS181	FA181R							MD6429C	27
300 SE-Factory	2019-2024	FA181X	MXS181	FA181R							MD6429C	28
300 SEF-Factory	2019-2024	FA181X	MXS181	FA181R							MD6429C	29
300 SEF-R	2019-2021	FA181X	MXS181	FA181R							MD6429C	30
300 SEF-Racing	2019-2023	FA181X	MXS181	FA181R							MD6429C	31
300 SE-R	2019-2021	FA181X	MXS181	FA181R							MD6429C	32
300 SE-Racing	2019-2023	FA181X	MXS181	FA181R							MD6429C	33
300 ST-R	2018-2019	FA303X										34
3.2	2005-2010	FA303X										35
4.5 Supermoto	2004-2007	FA181X	MXS181	FA181R	EPFA181HH							36
4.5i Enduro	2005-2010	FA181X	MXS181	FA181R	EPFA181HH							37
4.5i F Supermoto	2008-2010			FA322/4HH	EPFA322/4HH							38
4.5i SM	2012-2014			FA322/4HH	EPFA322/4HH							39
450 SCF-Factory	2019-2021	FA181X	MXS181	FA181R							MD6429C	40
450 SEF-Factory	2019-2024	FA181X	MXS181	FA181R							MD6429C	41
450 SE-R	2019-2021	FA181X	MXS181	FA181R							MD6429C	42
500 SCF-Factory	2019-2021	FA181X	MXS181	FA181R							MD6429C	43
500 SEF-Factory	2019-2024	FA181X	MXS181	FA181R							MD6429C	44
500 SEF-R	2019-2021	FA181X	MXS181	FA181R							MD6429C	45
5.1i Enduro	2005-2010	FA181X	MXS181	FA181R	EPFA181HH							46
												47
												48
STARK												49
Varg MX	2023	FA181X	MXS181	FA181R				TBC				50
												51
SYM												52
DD 50	2002-2012	SFA151						MD933D				53
Fiddle 50	1999-2012	303										54
Fiddle 50	2008-2011	SFA264		SFA264HH								55
Jet 50 EVO	2014	SFA264		SFA264HH				MD9116D				56
Jet Euro 50	1999-2012	SFA264		SFA264HH				MD9116D				56

FRONT

⚡ This symbol indicates a rotor made of billet steel, and should be only used with EBC FA Organic or Vee pads.

SAFETY NOTICE - With vehicles primarily designed for off highway use such as quads now being used on the highway, we would recommend the use of X or MXS pads for highway use and ONLY using the R and SV higher density / harder pad series for off road riding.

*-2 Sets Required. † For Vee disc colours add RED, BLU, GRN, GLD, ORG suffix to part number. **SAFETY WARNING:- DO NOT USE HH PADS ON REAR UNLESS ALSO USED ON FRONT TO AVOID BRAKE IMBALANCE**

FRONT: Non-Japanese Bikes Cont'd

REAR: Non-Japanese Bikes

Line #	BRAKE ROTOR CHOICES - FRONT					REAR	DISC PAD CHOICES - REAR					BRAKE ROTOR CHOICES - REAR				
	CX Extreme® /Vee-Rotor	OSX Series Oversize 280mm Rotor Kit	Relocating Bracket for Oversize Rotor	SMX Series Oversize 320mm Rotor Kit	Relocating Bracket for 320mm Rotor		Front Disc Bolt Kit	FA/SFA/X Pad or Brake Shoe	Specialty Pads SXR/ VEE/MXS Race	Sintered/ HH Pads/ Grooved Shoes	EPFA Sintered Fast Road/ Track Pads	SV Series Severe Duty Pads	Standard Rotor	Vintage Rotor / UTV Oversize Brake Kit	Contour Profile Rotor	CX Extreme® /Vee-Rotor
1							FA83X		FA83R							
2							FA351X									
3							FA368X	MXS368	FA368R					MD6430C		
4							FA368X	MXS368	FA368R					MD6430C		
5							FA368X	MXS368	FA368R					MD6430C		
6							FA351X									
7							FA351X									
8							FA83X		FA83R							
9							FA351X									
10							FA115X	MXS115	FA115R							
11							FA367X	MXS367	FA367R	EPFA367HH						
12							FA368X	MXS368	FA368R					MD6430C		
13							FA368X	MXS368	FA368R					MD6430C		
14							FA368X	MXS368	FA368R					MD6430C		
15							FA368X	MXS368	FA368R					MD6430C		
16							FA368X	MXS368	FA368R					MD6430C		
17							FA368X	MXS368	FA368R					MD6430C		
18							FA368X	MXS368	FA368R					MD6430C		
19																
20							FA351X									
21							FA351X									
22							FA351X									
23							FA351X									
24							FA83X		FA83R							
25							FA351X									
26							FA368X	MXS368	FA368R					MD6430C		
27							FA368X	MXS368	FA368R					MD6430C		
28							FA368X	MXS368	FA368R					MD6430C		
29							FA368X	MXS368	FA368R					MD6430C		
30							FA368X	MXS368	FA368R					MD6430C		
31							FA368X	MXS368	FA368R					MD6430C		
32							FA368X	MXS368	FA368R					MD6430C		
33							FA368X	MXS368	FA368R					MD6430C		
34							FA351X									
35							FA351X									
36							FA367X	MXS367	FA367R	EPFA367HH						
37							FA367X	MXS367	FA367R	EPFA367HH						
38							FA367X	MXS367	FA367R	EPFA367HH						
39							FA367X	MXS367	FA367R	EPFA367HH						
40	MD6429CX						FA368X	MXS368	FA368R					MD6430C		
41	MD6429CX						FA368X	MXS368	FA368R					MD6430C		
42	MD6429CX						FA368X	MXS368	FA368R					MD6430C		
43	MD6429CX						FA368X	MXS368	FA368R					MD6430C		
44	MD6429CX						FA368X	MXS368	FA368R					MD6430C		
45	MD6429CX						FA368X	MXS368	FA368R					MD6430C		
46							FA367X	MXS367	FA367R	EPFA367HH						
47																
48																
49	TBC						FA368X	MXS368	FA368R			TBC				
50																
51																
52							333									
53							302									
54							303									
55							303									
56							303									

BRAKE APPLICATIONS
 This symbol indicates a rotor made of billet steel, and should be only used with EBC FA Organic or Vee pads.
 SAFETY NOTICE - With vehicles primarily designed for off highway use such as quads now being used on the highway, we would recommend the use of X or MXS pads for highway use and ONLY using the R and SV higher density / harder pad series for off road riding.

*-2 Sets Required. † For Vee disc colours add RED, BLU, GRN, GLD, ORG suffix to part number. **SAFETY WARNING:- DO NOT USE HH PADS ON REAR UNLESS ALSO USED ON FRONT TO AVOID BRAKE IMBALANCE**

FRONT: Non-Japanese Bikes

APPLICATIONS
BRAKE



SYM



Mio 50		2005-2014
RS 50		2004-2012
Simply 50		2007-2012
Symba 100		2009-2014
Fiddle II 125		2008-2014
HD 125		2008-2012
Wolf 150 Classic		2011-2014
HD 200		2008-2012
HD 200 EVO		2012-2014
HS 125/200		2004-2008
RD 200 EVO		2012-2014
RV 250		2007-2012
Citycom 300i		2008-2014
Quadlander 300		2007-2010
Quadlander 600		2008-2010

TGB/PEIRSPEED

101S 50 Key West		2005-2011
Delivery 50		2004-2005
Delivery 50		2006-2011
Laser R5/1		2008-2011
R 50 X		2006-2011
Sunset 50		2006-2008
Delivery 151		2004-2011
Laser R9/1		2008-2011
Sunset 151		2006-2008
Ouck 425 C 4 x 4		2007-2009
Ouck 425 Real Tree Camo Edition 4 x 4 Auto		2007-2009
Ouck 425 SE 4 x 4 Auto		2007-2009

THUMPSTAR

Junior 90cc		2004-2007
Supa 110cc		2004-2007
Expert 125		2006-2007
Pro 125		2005-2007

TM

MX 85 JNR		2010-2021
MX 85 JNR		2010-2021
MX 85 JR		2004
MX 85 JR		2005-2008
MX 85/100		2002-2003
MX 100 JNR		2019-2021
MX 100 JNR		2019-2021
EN 125	Left	2001-2004
	Right	
EN 125		2005-2008
EN 125		2010-2021
MX 125		2010-2021
SMM 125 Black Dream	Left	2004-2008
	Right	
SMR 125		2005-2008
SMR 125		2010-2021
EN 144		2010-2021
MX 144		2007-2008
MX 144		2010-2021

DISC PAD CHOICES - FRONT

BRAKE ROTOR CHOICES - FRONT

FA/SFA/X Pad or Brake Shoe	Specialty Pads SXR/VEE/MXS Race	Sintered/HH Pads/Grooved Shoes	EPFA Sintered Fast Road/Track Pads	GPFAX Sintered RACE ONLY Pads	SV Series Severe Duty Pads	Standard Rotor Left	Standard Rotor Right	Vintage Rotor / UTV Oversize Brake Kit	Contour Profile Rotor
SFA151						MD933D			
SFA306									
SFA264		SFA264HH							
820									
SFA264		SFA264HH							
SFA305		SFA305HH							
FA86		FA86							
SFA305		SFA305HH							
SFA264		SFA264HH							
SFA305		SFA305HH							
SFA306									
SFA355/4		SFA355/4HH							
SFA264		SFA264HH							
FA377X*	FA377V*	FA377R*							
FA54X*		FA54R*			FA54SV*				
SFA83		SFA83HH				MD923D			
SFA264		SFA264HH				MD923D			
SFA83		SFA83HH				MD923D			
SFA83		SFA83HH							
SFA93						MD9115D			
SFA83		SFA83HH				MD923D			
SFA93						MD9115D			
SFA93						MD9115D			
SFA83		SFA83HH				MD923D			
FA377X*	FA377V*	FA377R*							
FA377X*	FA377V*	FA377R*							
FA377X*	FA377V*	FA377R*							
SFA169		SFA169HH							
SFA169		SFA169HH							
SFA169		SFA169HH							
SFA169		SFA169HH							
FA367X	MXS367	FA367R							
FA367X	MXS367	FA367R							
FA181X	MXS181	FA181R	EPFA181HH						
FA181X	MXS181	FA181R	EPFA181HH						
FA181X	MXS181	FA181R	EPFA181HH						
FA367X	MXS367	FA367R							
FA367X	MXS367	FA367R							
FA181X	MXS181	FA181R	EPFA181HH						
FA181X	MXS181	FA181R	EPFA181HH						
FA181X	MXS181	FA181R	EPFA181HH						
FA95		FA95HH	EPFA95HH						
		FA447HH	EPFA447HH						
FA181X	MXS181	FA181R							
FA181X	MXS181	FA181R	EPFA181HH						
FA181X	MXS181	FA181R							

FRONT

Line #
1
2
3
4
5
6
7
8
9
10
11
12
13
14
15
16
17
18
19
20
21
22
23
24
25
26
27
28
29
30
31
32
33
34
35
36
37
38
39
40
41
42
43
44
45
46
47
48
49
50
51
52
53
54
55
56

⚠ This symbol indicates a rotor made of billet steel, and should be only used with EBC FA Organic or Vee pads.
SAFETY NOTICE - With vehicles primarily designed for off highway use such as quads now being used on the highway, we would recommend the use of X or MXS pads for highway use and ONLY using the R and SV higher density / harder pad series for off road riding.

*-2 Sets Required. † For Vee disc colours add RED, BLU, GRN, GLD, ORG suffix to part number. SAFETY WARNING:- DO NOT USE HH PADS ON REAR UNLESS ALSO USED ON FRONT TO AVOID BRAKE IMBALANCE

FRONT: Non-Japanese Bikes Cont'd

REAR: Non-Japanese Bikes

Line #	BRAKE ROTOR CHOICES - FRONT					REAR	DISC PAD CHOICES - REAR					BRAKE ROTOR CHOICES - REAR				
	CX Extreme® /Vee-Rotor	OSX Series Oversize 280mm Rotor Kit	Relocating Bracket for Oversize Rotor	SMX Series Oversize 320mm Rotor Kit	Relocating Bracket for 320mm Rotor		Front Disc Bolt Kit	FA/SFA/X Pad or Brake Shoe	Specialty Pads SXR/ VEE/MXS Race	Sintered/ HH Pads/ Grooved Shoes	EPFA Sintered Fast Road/ Track Pads	SV Series Severe Duty Pads	Standard Rotor	Vintage Rotor / UTV Oversize Brake Kit	Contour Profile Rotor	CX Extreme® /Vee-Rotor
1							302									
2																
3							303									
4							303									
5							820									
6							820									
7							820									
8							820									
9							SFA427		SFA427HH							
10							820									
11							SFA427									
12							SFA427		SFA427HH							
13							SFA264		SFA264HH							
14							FA377X		FA377R							
15							FA377X		FA377R							
16																
17																
18							897									
19							897									
20							897									
21							897									
22							SFA83					MD9115D				
23							897									
24							820									
25							820									
26							820									
27							FA377X		FA377R							
28							FA377X		FA377R							
29							FA377X		FA377R							
30																
31																
32							SFA169		SFA169HH							
33							SFA169		SFA169HH							
34							SFA169		SFA169HH							
35							SFA169		SFA169HH							
36																
37																
38							FA367X	MXS367	FA367R							
39							FA367X	MXS367	FA367R							
40							FA131X	MXS131	FA131R	EPFA131HH						
41							FA367X	MXS367	FA367R	EPFA367HH						
42							FA208X	MXS208	FA208R							
43							FA367X	MXS367	FA367R							
44							FA367X	MXS367	FA367R							
45							FA131X	MXS131	FA131R	EPFA131HH						
46							FA367X									
47							FA367X*	MXS367	FA367R	EPFA367HH						
48							FA367X	MXS367	FA367R							
49							FA367X	MXS367	FA367R							
50							FA47		FA47HH							
51							FA367X									
52							FA367X*	MXS367	FA367R	EPFA367HH						
53							FA367X	MXS367	FA367R							
54							FA367X	MXS367	FA367R							
55							FA367X*	MXS367	FA367R	EPFA367HH						
56							FA367X	MXS367	FA367R							

BRAKE APPLICATIONS

⚠ This symbol indicates a rotor made of billet steel, and should be only used with EBC FA Organic or Vee pads. SAFETY NOTICE - With vehicles primarily designed for off highway use such as quads now being used on the highway, we would recommend the use of X or MXS pads for highway use and ONLY using the R and SV higher density / harder pad series for off road riding.

*-2 Sets Required. † For Vee disc colours add RED, BLU, GRN, GLD, ORG suffix to part number. **SAFETY WARNING:- DO NOT USE HH PADS ON REAR UNLESS ALSO USED ON FRONT TO AVOID BRAKE IMBALANCE**

FRONT: Non-Japanese Bikes

APPLICATIONS

BRAKE



TM



DISC PAD CHOICES - FRONT

BRAKE ROTOR CHOICES - FRONT

FRONT

Model	Side	Year	FA/SFA/X Pad or Brake Shoe	Specialty Pads SXR/ VEE/MXS Race	Sintered/ HH Pads/ Grooved Shoes	EPFA Sintered Fast Road/Track Pads	GPFAX Sintered RACE ONLY Pads	SV Series Severe Duty Pads	Standard Rotor Left	Standard Rotor Right	Vintage Rotor / UTV Oversize Brake Kit	Contour Profile Rotor	Line #
EN 250	Left	2001-2004	FA181X	MXS181	FA181R	EPFA181HH							1
	Right												2
EN 250		2010-2021	FA181X	MXS181	FA181R								3
EN 250 F-ES	Left	2001-2004	FA181X	MXS181	FA181R	EPFA181HH							4
	Right												5
EN 250 Fi-ES		2010-2021	FA181X	MXS181	FA181R								6
MX 250		2010-2021	FA181X	MXS181	FA181R								7
MX 250		2010-2021	FA181X	MXS181	FA181R								8
MX 250 F	Left	2002-2004	FA181X	MXS181	FA181R	EPFA181HH							9
	Right												10
MX 250 F		2005-2007	FA181X	MXS181	FA181R	EPFA181HH							11
MX 250/300	Left	2004	FA181X	MXS181	FA181R	EPFA181HH							12
	Right												13
MX 250/300		2005-2008	FA181X	MXS181	FA181R	EPFA181HH							14
EN 300		2005-2008	FA181X	MXS181	FA181R	EPFA181HH							15
EN 300	Left	2001-2004	FA181X	MXS181	FA181R	EPFA181HH							16
	Right												17
EN 300		2010-2021	FA181X	MXS181	FA181R								18
EN 300		2010-2021	FA181X	MXS181	FA181R								19
FT 300		2019-2021	FA181X	MXS181	FA181R								20
MX 300		2010-2021	FA181X	MXS181	FA181R								21
MX 300		2010-2021	FA181X	MXS181	FA181R								22
SMR 300		2019-2021			FA447HH	EPFA447HH							23
SMX 300		2019-2021			FA447HH	EPFA447HH							24
EN 450		2010-2021	FA181X	MXS181	FA181R								25
EN 450 F-ES		2005-2008	FA181X	MXS181	FA181R	EPFA181HH							26
FT 450		2019-2021	FA181X	MXS181	FA181R								27
MX 450		2010-2021	FA181X	MXS181	FA181R								28
MX 450 F	Left	2005-2008	FA181X	MXS181	FA181R	EPFA181HH							29
	Right												30
SMM 450 Black Dream ES	Left	2005-2008											31
	Right												32
SMR 450		2019-2021			FA447HH	EPFA447HH							33
SMR 450 F ES	Left	2005-2008	FA95		FA95HH	EPFA95HH							34
	Right												35
EN 530		2010-2021	FA181X	MXS181	FA181R								36
EN 530 F-ES		2005-2008	FA181X	MXS181	FA181R	EPFA181HH							37
EN 530 F-ES	Left	2004-2008	FA181X	MXS181	FA181R	EPFA181HH							38
	Right												39
MX 530		2010-2021	FA181X	MXS181	FA181R								40
MX 530 F	Left	2004	FA181X	MXS181	FA181R	EPFA181HH							41
	Right												42
MX 530 F		2005-2008	FA181X	MXS181	FA181R	EPFA181HH							43
SMM 530 Black Dream ES	Left	2005-2008											44
	Right												45
SMR 530		2019-2021			FA447HH	EPFA447HH							46
SMR 530 F ES		2005-2008	FA95		FA95HH	EPFA95HH							47
SMX 530 F Competition		2005-2008			FA322/4HH	EPFA322/4HH							48
SMX 660 F	Left	2004	FA95		FA95HH	EPFA95HH							49
	Right												50
													51
													52
													53
													54
													55
													56

⚠ This symbol indicates a rotor made of billet steel, and should be only used with EBC FA Organic or Vee pads.
SAFETY NOTICE - With vehicles primarily designed for off highway use such as quads now being used on the highway, we would recommend the use of X or MXS pads for highway use and ONLY using the R and SV higher density / harder pad series for off road riding.

TOMOS

MC 36		2005-2007											53
MC 50 Junior		2003-2004											54
MC 50 Junior		2005-2007											55
MC 50 Senior		2003-2007											56

*-2 Sets Required. † For Vee disc colours add RED, BLU, GRN, GLD, ORG suffix to part number. SAFETY WARNING:- DO NOT USE HH PADS ON REAR UNLESS ALSO USED ON FRONT TO AVOID BRAKE IMBALANCE

FRONT: Non-Japanese Bikes Cont'd

REAR: Non-Japanese Bikes

Line #	BRAKE ROTOR CHOICES - FRONT						DISC PAD CHOICES - REAR					BRAKE ROTOR CHOICES - REAR				
	CX Extreme® /Vee-Rotor	OSX Series Oversize 280mm Rotor Kit	Relocating Bracket for Oversize Rotor	SMX Series Oversize 320mm Rotor Kit	Relocating Bracket for 320mm Rotor		Front Disc Bolt Kit	FA/SFA/X Pad or Brake Shoe	Specialty Pads SXR/ VEE/MXS Race	Sintered/ HH Pads/ Grooved Shoes	EPFA Sintered Fast Road/ Track Pads	SV Series Severe Duty Pads	Standard Rotor	Vintage Rotor / UTV Oversize Brake Kit	Contour Profile Rotor	CX Extreme® /Vee-Rotor
1							FA131X	MXS131	FA131R	EPFA131HH						
2							FA367X									
3							FA367X	MXS367	FA367R							
4							FA131X	MXS131	FA131R	EPFA131HH						
5							FA367X									
6							FA367X	MXS367	FA367R							
7							FA367X	MXS367	FA367R							
8							FA367X	MXS367	FA367R							
9							FA131X	MXS131	FA131R	EPFA131HH						
10							FA367X									
11							FA367X*	MXS367	FA367R	EPFA367HH						
12							FA131X	MXS131	FA131R	EPFA131HH						
13							FA367X									
14							FA367X*	MXS367	FA367R	EPFA367HH						
15							FA367X*	MXS367	FA367R	EPFA367HH						
16							FA131X	MXS131	FA131R	EPFA131HH						
17							FA367X									
18							FA367X	MXS367	FA367R							
19							FA367X	MXS367	FA367R							
20							FA367X	MXS367	FA367R							
21							FA367X	MXS367	FA367R							
22							FA367X	MXS367	FA367R							
23							FA367X	MXS367	FA367R							
24							FA367X	MXS367	FA367R							
25							FA367X	MXS367	FA367R							
26							FA367X*	MXS367	FA367R	EPFA367HH						
27							FA367X	MXS367	FA367R							
28							FA367X	MXS367	FA367R							
29							FA131X	MXS131	FA131R	EPFA131HH						
30							FA367X									
31							FA47		FA47HH							
32							FA367X									
33							FA367X	MXS367	FA367R							
34							FA131X	MXS131	FA131R	EPFA131HH						
35							FA367X									
36							FA367X	MXS367	FA367R							
37							FA367X*	MXS367	FA367R	EPFA367HH						
38							FA131X	MXS131	FA131R	EPFA131HH						
39							FA367X									
40							FA367X	MXS367	FA367R							
41							FA131X	MXS131	FA131R	EPFA131HH						
42							FA367X									
43							FA367X*	MXS367	FA367R	EPFA367HH						
44							FA47		FA47HH							
45							FA367X									
46							FA367X	MXS367	FA367R							
47							FA367X*	MXS367	FA367R	EPFA367HH						
48							FA367X*	MXS367	FA367R	EPFA367HH						
49							FA131X	MXS131	FA131R	EPFA131HH						
50																
51																
52																
53																
54																
55																
56																

⚠ This symbol indicates a rotor made of billet steel, and should be only used with EBC FA Organic or Vee pads.
SAFETY NOTICE - With vehicles primarily designed for off highway use such as quads now being used on the highway, we would recommend the use of X or MXS pads for highway use and ONLY using the R and SV higher density / harder pad series for off road riding.

*-2 Sets Required. † For Vee disc colours add RED, BLU, GRN, GLD, ORG suffix to part number. **SAFETY WARNING:- DO NOT USE HH PADS ON REAR UNLESS ALSO USED ON FRONT TO AVOID BRAKE IMBALANCE**

FRONT: Non-Japanese Bikes

APPLICATIONS

BRAKE



TOMOS



MC 50 Senior Pro	Left	2003-2008
	Right	
MC 50 Senior Pro		2005-2007
Revival/TS/Streetmate		2003-2008
MC 80 Drum Model		2005-2007

TRIUMPH MERIDEN PRODUCED

Cub 500		1968
T120		1966-1970
T140 V Bonneville		1973-1974
T140 V Bonneville		1975-1978
T140 Silver Jubilee Bonneville		1977
T140 D Bonneville		1979-1981
T140 E Bonneville		1978-1983
T140 ES		1980-1981
T140		1981-1983
Bonneville T140		1985-1988
TSS 750		1983
TSX 750		1983

TRIUMPH HINCKLEY PRODUCED

TX 250F		2024
Speed 400		2024
Scrambler 400x		2024
Bonneville T100		2010-2015
Bonneville T100		2002-2009
Bonneville T100		2016-2020
Bonneville T100		2021-2023
Bonneville T100 - Steve McQueen SE		2012
Bonneville T100 Black		2014-2015
Bonneville T100 Black		2016-2021
Bonneville T100 Black		2021-2022
Bonneville T100 Chrome Edition		2023
Bonneville T100 Newchurch		2015
Bonneville T100 Spirit SE		2015
Bonneville T120		2016-2020
Bonneville T120		2021-2023
Bonneville T120 Black		2016-2020
Bonneville T120 Black		2021-2023
Bonneville T120 Black DGR Limited Edition		2023
Bonneville T120 Black Gold Line		2023
Bonneville T120 Chrome Edition		2023
Bonneville T214		2015
Speed Triple T509		1997-1998
Daytona T595		1997-1998
Daytona 600		2003-2004
Speedfour 600		2002-2005
TT 600		2000-2003
Daytona 650		2005
Tiger Sport 660		2021-2024
Trident 660cc		2021-2024
Daytona 675		2006-2008
Daytona 675		2009-2012
Daytona 675		2013-2017
Daytona 675 R		2013-2019
Daytona 675 R		2011-2012

FRONT

DISC PAD CHOICES - FRONT

BRAKE ROTOR CHOICES - FRONT

FA/SFA/X Pad or Brake Shoe	Specialty Pads SXR/VEE/MXS Race	Sintered/HH Pads/Grooved Shoes	EPFA Sintered Fast Road/Track Pads	GPFAX Sintered RACE ONLY Pads	SV Series Severe Duty Pads	Standard Rotor Left	Standard Rotor Right	Vintage Rotor / UTV Oversize Brake Kit	Contour Profile Rotor
FA116									
SFA116									
858									
853									
FA16		FA16HH	EPFA16HH			MD656	MD656	VMD656*	
FA16		FA16HH	EPFA16HH			MD656		VMD656*	
FA16		FA16HH	EPFA16HH			MD656		VMD656*	
FA16		FA16HH	EPFA16HH			MD838			
FA16		FA16HH	EPFA16HH			MD656		VMD656*	
FA16		FA16HH	EPFA16HH			MD656		VMD656*	
FA16		FA16HH	EPFA16HH					VMD656*	
FA16		FA16HH	EPFA16HH					VMD656*	
FA18*	FA18V*	FA18HH*							
FA16		FA16HH	EPFA16HH			MD656		VMD656*	
FA16		FA16HH	EPFA16HH			MD656		VMD656*	
FA181X	MXS181	FA181R							
FA606		FA606HH							
FA606		FA606HH							
FA196		FA196HH				MD822			
FA196		FA196HH				MD649			
FA142		FA142HH				MD886X			
FA181		FA181HH				MD886X			
FA196		FA196HH				MD822			
FA196		FA196HH				MD822			
FA142		FA142HH				MD886X			
FA181		FA181HH				MD886X			
FA181		FA181HH				MD886X			
FA196		FA196HH				MD821			
FA196		FA196HH				MD822			
FA142*	FA142V*	FA142HH*				MD873	MD873		
FA181*		FA181HH*				MD873	MD873		
FA142*	FA142V*	FA142HH*				MD873	MD873		
FA181*		FA181HH*				MD873	MD873		
FA181*		FA181HH*				MD873	MD873		
FA181*		FA181HH*				MD873	MD873		
FA181*		FA181HH*				MD873	MD873		
FA196	FA196V	FA196HH				MD822			
FA236*		FA236HH*				MD647X	MD647X		MD647XC*
FA236*		FA236HH*				MD647X	MD647X		MD647XC*
FA236*		FA236HH*				MD662X	MD662X		MD662XC*
FA236*		FA236HH*				MD662X	MD662X		MD662XC*
FA236*		FA236HH*				MD662X	MD662X		MD662XC*
FA236*		FA236HH*				MD662X	MD662X		MD662XC*
FA236*		FA236HH*				MD662X	MD662X		MD662XC*
FA226*		FA226HH*							
FA226*		FA226HH*							
		FA347HH*	EPFA347HH*			MD800X	MD800X		MD800XC*
		FA491HH*	EPFA491HH*	GPFAX491HH*		MD800X	MD800X		MD800XC*
		FA491HH*	EPFA491HH*	GPFAX491HH*		MD800X	MD800X		MD800XC*
		FA447HH*	EPFA447HH*			MD852X	MD852X		
		FA447HH*	EPFA447HH*			MD800X	MD800X		MD800XC*

Line #
1
2
3
4
5
6
7
8
9
10
11
12
13
14
15
16
17
18
19
20
21
22
23
24
25
26
27
28
29
30
31
32
33
34
35
36
37
38
39
40
41
42
43
44
45
46
47
48
49
50
51
52
53
54
55
56

*-2 Sets Required. † For Vee disc colours add RED, BLU, GRN, GLD, ORG suffix to part number. **SAFETY WARNING:- DO NOT USE HH PADS ON REAR UNLESS ALSO USED ON FRONT TO AVOID BRAKE IMBALANCE**

This symbol indicates a rotor made of billet steel, and should be only used with EBC FA Organic or Vee pads.
 SAFETY NOTICE - With vehicles primarily designed for off highway use such as quads now being used on the highway, we would recommend the use of X or MXS pads for highway use and ONLY using the R and SV higher density / harder pad series for off road riding.

FRONT: Non-Japanese Bikes Cont'd

REAR: Non-Japanese Bikes

Line #	BRAKE ROTOR CHOICES - FRONT						DISC PAD CHOICES - REAR						BRAKE ROTOR CHOICES - REAR				
	CX Extreme® /Vee-Rotor	OSX Series Oversize 280mm Rotor Kit	Relocating Bracket for Oversize Rotor	SMX Series Oversize 320mm Rotor Kit	Relocating Bracket for 320mm Rotor	Front Disc Bolt Kit	FA/SFA/X Pad or Brake Shoe	Specialty Pads SXR/ VEE/MXS Race	Sintered/ HH Pads/ Grooved Shoes	EPFA Sintered Fast Road/ Track Pads	SV Series Severe Duty Pads	Standard Rotor	Vintage Rotor / UTV Oversize Brake Kit	Contour Profile Rotor	CX Extreme® /Vee-Rotor	Rear Disc Bolt Kit	
1							FA116										
2																	
3																	
4																	
5																	
6																	
7																	
8							858										
9							854										
10																	
11							FA16		FA16HH	EPFA16HH		MD656	VMD656				
12							FA16		FA16HH	EPFA16HH		MD656	VMD656				
13							FA16		FA16HH	EPFA16HH		MD838					
14							FA16		FA16HH	EPFA16HH		MD656	VMD656				
15							FA16		FA16HH	EPFA16HH		MD656	VMD656				
16							FA16		FA16HH	EPFA16HH							
17							FA18		FA18HH								
18							FA16		FA16HH	EPFA16HH		MD656	VMD656				
19							FA16		FA16HH	EPFA16HH		MD656	VMD656				
20																	
21																	
22							FA368X	MXS368	FA368R								
23							FA213		FA213HH								
24							FA213		FA213HH								
25							FA214/2		FA214/2HH			MD663	MD663C	VR663	DB605/4		
26							FA214/2		FA214/2HH			MD663		VR663	DB605/4		
27							FA214/2		FA214/2HH			MD874					
28							FA214/2		FA214/2HH			MD874					
29							FA214/2		FA214/2HH			MD663	MD663C	VR663	DB605/4		
30							FA214/2		FA214/2HH			MD663	MD663C	VR663	DB605/4		
31							FA214/2		FA214/2HH			MD874					
32							FA214/2		FA214/2HH			MD874					
33							FA214/2		FA214/2HH			MD874					
34							FA214/2		FA214/2HH			MD663	MD663C		DB605/4		
35							FA214/2		FA214/2HH			MD663	MD663C	VR663	DB605/4		
36							FA214		FA214HH			MD874					
37							FA214		FA214HH			MD874					
38							FA214		FA214HH			MD874					
39							FA214		FA214HH			MD874					
40							FA214		FA214HH			MD874					
41							FA214		FA214HH			MD874					
42							FA214		FA214HH			MD874					
43							FA214/2		FA214/2HH			MD663	MD663C	VR663	DB605/4		
44						DB605/6	FA214/2		FA214/2HH			MD648	MD648C	VR648	DB605/4		
45	VR647BLK*†					DB605/6	FA214/2		FA214/2HH			MD648	MD648C	VR648	DB605/4		
46	VR662BLK*†					DB605/6	FA140		FA140HH			MD648	MD648C	VR648	DB605/4		
47	VR662BLK*†					DB605/6	FA140		FA140HH			MD648	MD648C	VR648	DB605/4		
48	VR662BLK*†					DB605/6	FA140		FA140HH			MD648	MD648C	VR648	DB605/4		
49	VR662BLK*†					DB605/6	FA140		FA140HH			MD648	MD648C	VR648	DB605/4		
50							FA140		FA140HH								
51							FA140		FA140HH								
52	VR800BLK*†						FA140		FA140HH			MD648	MD648C	VR648	DB605/4		
53	VR800BLK*†						FA140		FA140HH			MD648	MD648C	VR648	DB605/4		
54	VR800BLK*†						FA213		FA213HH			MD851	MD851C				
55							FA213		FA213HH			MD851	MD851C				
56	VR800BLK*†						FA140		FA140HH			MD648	MD648C	VR648	DB605/4		

BRAKE APPLICATIONS

⚠ This symbol indicates a rotor made of billet steel, and should be only used with EBC FA Organic or Vee pads. SAFETY NOTICE - With vehicles primarily designed for off highway use such as quads now being used on the highway, we would recommend the use of X or MXS pads for highway use and ONLY using the R and SV higher density / harder pad series for off road riding.

*-2 Sets Required. † For Vee disc colours add RED, BLU, GRN, GLD, ORG suffix to part number. **SAFETY WARNING:- DO NOT USE HH PADS ON REAR UNLESS ALSO USED ON FRONT TO AVOID BRAKE IMBALANCE**

FRONT: Non-Japanese Bikes

APPLICATIONS

BRAKE



TRIUMPH HINCKLEY PRODUCED



DISC PAD CHOICES - FRONT

BRAKE ROTOR CHOICES - FRONT

Model	Year	FA/SFA/X Pad or Brake Shoe	Specialty Pads SXR/ VEE/MXS Race	Sintered/ HH Pads/ Grooved Shoes	EPFA Sintered Fast Road/Track Pads	GPFAX Sintered RACE ONLY Pads	SV Series Severe Duty Pads	Standard Rotor		Vintage Rotor / UTV Oversize Brake Kit	Contour Profile Rotor	Line #
								Standard Rotor Left	Standard Rotor Right			
Daytona 675 SE	2012			FA491HH*	EPFA491HH*	GPFAX491HH*		MD800X	MD800X		MD800XC*	1
Street Triple 675	2007-2012	FA226*		FA226HH*	EPFA226HH*			MD800X	MD800X		MD800XC*	2
Street Triple 675	2013-2019	FA226*		FA226HH*	EPFA226HH*			MD852X	MD852X			3
Street Triple 675RX SE	2015			FA347HH*	EPFA347HH*			MD800X	MD800X		MD800XC*	4
Street Triple R 675	2009-2012			FA347HH*	EPFA347HH*			MD800X	MD800X		MD800XC*	5
Street Triple R 675	2013-2017			FA347HH*	EPFA347HH*			MD800X	MD800X		MD800XC*	6
Daytona	1994-1997	FA190*		FA190HH*				MD640	MD640			7
Daytona 750	1992	FA236*		FA236HH*				MD640	MD640			8
Speed Triple 750/900	1994-1996	FA236*		FA236HH*				MD640	MD640			9
Street Triple 765R	2022-2024			FA630HH*	EPFA630HH*	GPFAX630HH*		MD852X	MD852X		MD852XC*	10
Street Triple R 765	2018-2019			FA630HH*	EPFA630HH*	GPFAX630HH*		MD852X	MD852X		MD852XC*	11
Street Triple R 765	2020-2022			FA447HH*	EPFA447HH*	GPFAX447HH*		MD852X	MD852X		MD852XC*	12
Street Triple RS 765	2022-2024			FA447HH*	EPFA447HH*	GPFAX447HH*		MD8016X	MD8016X			13
Street Triple 765RS	2023-2024			FA447HH*	EPFA447HH*	GPFAX447HH*		MD8016X	MD8016X			14
Street Triple RS 765	2018-2021			FA447HH*	EPFA447HH*	GPFAX447HH*		MD852X	MD852X		MD852XC*	15
Street Triple S 765	2018-2021	FA226*		FA226HH*	EPFA226HH*							16
Bonneville America	2002-2006	FA196	FA196V	FA196HH				MD649				17
Speedmaster	2003-2004	FA142*	FA142V*	FA142HH*				MD649	MD649			18
Bonneville 800	2001-2006	FA196	FA196V	FA196HH				MD649				19
Tiger 800	2011-2014	FA226*		FA226HH*	EPFA226HH*			MD842X	MD842X		MD842XC*	20
Tiger 800 XC	2011-2020	FA226*		FA226HH*	EPFA226HH*			MD842X	MD842X		MD842XC*	21
Tiger 800 XC	2015	FA226*		FA226HH*	EPFA226HH*			MD842X	MD842X		MD842XC*	22
Tiger 800 Xca	2015-2018	FA181X*		FA181HH*	EPFA181HH*			MD842X	MD842X		MD842XC*	23
Tiger 800 XC-SE	2014	FA226*		FA226HH*	EPFA226HH*			MD842X	MD842X		MD842XC*	24
Tiger 800 XCx	2015-2018	FA181X*		FA181HH*	EPFA181HH*			MD842X	MD842X		MD842XC*	25
Tiger 800 XR	2015-2018	FA226*		FA226HH*	EPFA226HH*			MD842X	MD842X		MD842XC*	26
Tiger 800 XR	2015	FA226*		FA226HH*	EPFA226HH*			MD842X	MD842X		MD842XC*	27
Tiger 800 XRt	2016-2020	FA181X*		FA181HH*	EPFA181HH*			MD842X	MD842X		MD842XC*	28
Tiger 800 XRx	2015-2020	FA181X*		FA181HH*	EPFA181HH*			MD842X	MD842X		MD842XC*	29
Tiger 850 Sport	2021-2023			FA447HH*	EPFA447HH*			MD8014X	MD8014X			30
America	2006-2009	FA196	FA196V	FA196HH				MD649				31
America	2010-2019	FA196	FA196V	FA196HH				MD822				32
America	2014-2019	FA196	FA196V	FA196HH				MD822				33
Bonneville	2009-2015	FA196	FA196V	FA196HH				MD821				34
Bonneville Bonneville Black	2006-2008	FA196	FA196V	FA196HH				MD649				35
Bonneville SE	2009-2012	FA196	FA196V	FA196HH				MD821				36
Scrambler	2006-2009	FA196	FA196V	FA196HH				MD649				37
Scrambler	2010-2016	FA196	FA196V	FA196HH				MD822				38
Speedmaster	2005-2007	FA142*	FA142V*	FA142HH*				MD649	MD649			39
Speedmaster	2008-2010	FA142*	FA142V*	FA142HH*				MD649	MD649			40
Speedmaster	2009-2010	FA196	FA196V	FA196HH				MD822				41
Speedmaster	2011-2020	FA196	FA196V	FA196HH				MD821				42
Speedmaster	2021-2023	FA181*		FA181HH*				MD821	MD821			43
Legend TT	1998-2001	FA196	FA196V	FA196HH				MD642LS				44
Sprint	1993	FA214	FA214V	FA214HH				MD646LS				45
		FA215	FA215V	FA215HH								46
Sprint	1994-1998	FA236*		FA236HH*				MD640	MD646RS			47
Tiger	1992-1997	FA214	FA214V	FA214HH				MD644	MD640			48
		FA215	FA215V	FA215HH								49
Tiger	1998-1999	FA196*	FA196V*	FA196HH*				MD649	MD644			50
Adventurer	1996-2001	FA196	FA196V	FA196HH				MD642LS				51
Daytona 900	1993-1996	FA236*		FA236HH*				MD640	MD640			52
Scrambler	2017	FA196	FA196V	FA196HH				MD822				53
Scrambler 900	2022-2023			FA604/4HH								54
Speed Twin 900	2022-2023			FA604/4HH				MD873				55
Street Cup 900cc	2016-2020	FA142	FA142V	FA142HH				MD886X				56

FRONT

* This symbol indicates a rotor made of billet steel, and should be only used with EBC FA Organic or Vee pads.
 SAFETY NOTICE - With vehicles primarily designed for off highway use such as quads now being used on the highway, we would recommend the use of X or MXS pads for highway use and ONLY using the R and SV higher density / harder pad series for off road riding.

*-2 Sets Required. † For Vee disc colours add RED, BLU, GRN, GLD, ORG suffix to part number. **SAFETY WARNING:- DO NOT USE HH PADS ON REAR UNLESS ALSO USED ON FRONT TO AVOID BRAKE IMBALANCE**

FRONT: Non-Japanese Bikes Cont'd

REAR: Non-Japanese Bikes

Line #	BRAKE ROTOR CHOICES - FRONT					REAR	DISC PAD CHOICES - REAR					BRAKE ROTOR CHOICES - REAR				
	CX Extreme® /Vee-Rotor	OSX Series Oversize 280mm Rotor Kit	Relocating Bracket for Oversize Rotor	SMX Series Oversize 320mm Rotor Kit	Relocating Bracket for 320mm Rotor		Front Disc Bolt Kit	FA/SFA/X Pad or Brake Shoe	Specialty Pads SXR/ VEE/MXS Race	Sintered/ HH Pads/ Grooved Shoes	EPFA Sintered Fast Road/ Track Pads	SV Series Severe Duty Pads	Standard Rotor	Vintage Rotor / UTV Oversize Brake Kit	Contour Profile Rotor	CX Extreme® /Vee-Rotor
1	VR800BLK*†						FA140		FA140HH			MD648		MD648C	VR648	DB605/4
2	VR800BLK*†						FA140		FA140HH			MD648		MD648C	VR648	DB605/4
3							FA213		FA213HH			MD851		MD851C		
4	VR800BLK*†						FA213		FA213HH			MD851		MD851C		
5	VR800BLK*†						FA140		FA140HH			MD648		MD648C	VR648	DB605/4
6	VR800BLK*†						FA213		FA213HH			MD851		MD851C		
7	VR640BLK*†						FA215/2		FA215/2HH			MD641			VR641	
8	VR640BLK*†						FA215/2		FA215/2HH			MD641			VR641	
9							FA215/2		FA215/2HH			MD641			VR641	
10							FA213		FA213HH			MD851		MD851C		
11							FA213		FA213HH			MD851		MD851C		
12							FA213		FA213HH			MD851		MD851C		
13							FA213		FA213HH			MD851		MD851C		
14							FA213		FA213HH			MD851		MD851C		
15							FA213		FA213HH			MD851		MD851C		
16							FA213		FA213HH			MD851		MD851C		
17							FA214/2		FA214/2HH			MD643			VR643	
18							FA214/2		FA214/2HH			MD643			VR643	
19							FA214/2		FA214/2HH			MD663			VR663	DB605/4
20	VR842BLK*†						FA140		FA140HH			MD820		MD820C	VR820	
21	VR842BLK*†						FA140		FA140HH			MD663		MD663C	VR663	DB605/4
22	VR842BLK*†						FA140		FA140HH			MD820		MD820C	VR820	
23	VR842BLK*†						FA140		FA140HH			MD820		MD820C	VR820	
24	VR842BLK*†						FA140		FA140HH			MD820		MD820C	VR820	
25	VR842BLK*†						FA140		FA140HH			MD820		MD820C	VR820	
26	VR842BLK*†						FA140		FA140HH			MD820		MD820C	VR820	
27	VR842BLK*†						FA140		FA140HH			MD820		MD820C	VR820	
28	VR842BLK*†						FA140		FA140HH			MD820		MD820C	VR820	
29	VR842BLK*†						FA140		FA140HH			MD820		MD820C	VR820	
30							FA140		FA140HH			MD820		MD820C	VR820	
31	MD649CX						FA214/2		FA214/2HH			MD643			VR643	
32							FA214/2		FA214/2HH			MD643				
33							FA214/2		FA214/2HH			MD643				
34							FA214/2		FA214/2HH			MD663		MD663C		DB605/4
35							FA214/2		FA214/2HH			MD663		MD663C	VR663	DB605/4
36							FA214/2		FA214/2HH			MD663		MD663C		DB605/4
37							FA214/2		FA214/2HH			MD663		MD663C	VR663	DB605/4
38							FA214/2		FA214/2HH			MD663		MD663C	VR663	DB605/4
39							FA214/2		FA214/2HH			MD643			VR643	
40							FA214/2		FA214/2HH			MD643			VR643	
41							FA214/2		FA214/2HH			MD643				
42							FA214/2		FA214/2HH			MD643				
43							FA214/2		FA214/2HH			MD643				
44							FA196		FA196HH			MD643			VR643	
45	VR646BLK*†						FA215/2		FA215/2HH			MD641			VR641	
46																
47	VR640BLK*†						FA215/2		FA215/2HH			MD641			VR641	
48							FA215/2		FA215/2HH			MD645				
49																
50												MD643			VR643	
51	VR629BLK*†						FA196		FA196HH			MD643			VR643	
52	VR640BLK*†						FA215/2		FA215/2HH			MD641			VR614	
53							FA214/2		FA214/2HH			MD663		MD663C	VR663	DB605/4
54							FA214/2		FA214/2HH							
55							FA214/2		FA214/2HH			MD874				
56							FA214/2		FA214/2HH			MD874				

BRAKE APPLICATIONS
⚠ This symbol indicates a rotor made of billet steel, and should be only used with EBC FA Organic or Vee pads.
SAFETY NOTICE - With vehicles primarily designed for off highway use such as quads now being used on the highway, we would recommend the use of X or MXS pads for highway use and ONLY using the R and SV higher density / harder pad series for off road riding.

*-2 Sets Required. † For Vee disc colours add RED, BLU, GRN, GLD, ORG suffix to part number. **SAFETY WARNING:- DO NOT USE HH PADS ON REAR UNLESS ALSO USED ON FRONT TO AVOID BRAKE IMBALANCE**

FRONT: Non-Japanese Bikes



TRIUMPH HINCKLEY PRODUCED



DISC PAD CHOICES - FRONT

BRAKE ROTOR CHOICES - FRONT

Model	Year	FA/SFA/X Pad or Brake Shoe	Specialty Pads SXR/ VEE/MXS Race	Sintered/ HH Pads/ Grooved Shoes	EPFA Sintered Fast Road/Track Pads	GPFAX Sintered RACE ONLY Pads	SV Series Severe Duty Pads	Standard Rotor		Vintage Rotor / UTV Oversize Brake Kit	Contour Profile Rotor	Line #
								Standard Rotor Left	Standard Rotor Right			
Street Scrambler	2018-2021			FA604/4HH								1
Street Twin 900cc	2016-2017	FA142	FA142V	FA142HH				MD873				2
Street Twin 900cc	2018-2021			FA604/4HH				MD873				3
Thruxton 900	2004-2015	FA142	FA142V	FA142HH				MD629X			MD629XC	4
Thruxton 900 Ace Café SE	2014-2015	FA142	FA142V	FA142HH				MD629X			MD629XC	5
Thruxton 900 SE	2012	FA142	FA142V	FA142HH				MD629X			MD629XC	6
Thunderbird	1995-2003	FA196	FA196V	FA196HH				MD642LS				7
Thunderbird Sport	1998-2003	FA196*	FA196V*	FA196HH*				MD649	MD649			8
Tiger 900	2019-2023			FA447HH*	EPFA447HH*	GPFAX447HH*		MD8014X	MD8014X		MD8014XC*	9
Tiger 900 GT	2019-2023			FA447HH*	EPFA447HH*	GPFAX447HH*					MD8008XC*	10
Tiger 900 GT Low	2019-2023			FA447HH*	EPFA447HH*	GPFAX447HH*		MD8014X	MD8014X		MD8014XC*	11
Tiger 900 GT Pro	2019-2024			FA447HH*	EPFA447HH*	GPFAX447HH*		MD8014X	MD8014X		MD8014XC*	12
Tiger 900 Rally	2019-2023			FA447HH*	EPFA447HH*	GPFAX447HH*		MD8014X	MD8014X		MD8014XC*	13
Tiger 900 Rally Pro	2019-2024			FA447HH*	EPFA447HH*	GPFAX447HH*		MD8014X	MD8014X		MD8014XC*	14
Trident 900	1992-1998	FA214	FA214V	FA214HH				MD646LS				15
	Left											
	Right											
Trophy 900	1992-1993	FA214	FA214V	FA214HH				MD646LS				16
	Left											
	Right											
Trophy 900	1994-2001	FA236*		FA236HH*				MD640	MD640			17
Daytona 955i	1998-2000	FA236*		FA236HH*				MD647X	MD647X		MD647XC*	18
Daytona 955i	2001-2004	FA236*		FA236HH*				MD669X	MD669X		MD669XC*	19
Daytona 955i	2001-2004	FA236*		FA236HH*				MD669X	MD669X		MD669XC*	20
Speed Triple 955i	1999-2004	FA236*		FA236HH*				MD647X	MD647X		MD647XC*	21
Sprint RS	2002	FA236*		FA236HH*				MD647X	MD647X		MD647XC*	22
Sprint RS	1999-2001	FA236*		FA236HH*				MD647X	MD647X		MD647XC*	23
Sprint RS	2003-2004	FA236*		FA236HH*				MD647X	MD647X		MD647XC*	24
Sprint ST 955i	1999-2004	FA236*		FA236HH*				MD647X	MD647X		MD647XC*	25
Tiger 955i	1999-2004	FA196*	FA196V*	FA196HH*				MD649	MD649			26
Tiger 955i	2004-2006	FA196*	FA196V*	FA196HH*				MD676	MD676			27
Daytona 1000	1992	FA236*		FA236HH*				MD640	MD640			28
Speed Triple 1050	2005-2006			FA347HH*	EPFA347HH*			MD679X	MD679X		MD679XC*	29
Speed Triple 1050	2007-2011			FA322/4HH*	EPFA322/4HH*			MD817X	MD817X		MD817XC*	30
Speed Triple 1050	2007-2011			FA322/4HH*	EPFA322/4HH*			MD817X	MD817X		MD817XC*	31
Speed Triple 1050	2011-2016			FA604/4HH*	EPFA604/4HH*			MD817X	MD817X		MD817XC*	32
Speed Triple 1050	2011-2016			FA604/4HH*	EPFA604/4HH*			MD817X	MD817X		MD817XC*	33
Speed Triple 1050 RS	2016-2021			FA447HH*	EPFA447HH*			MD8014X	MD8014X		MD8014XC*	34
Speed Triple 1050 S	2016-2021			FA447HH*	EPFA447HH*			MD8014X	MD8014X		MD8014XC*	35
Speed Triple R 1050	2013-2015			FA447HH*	EPFA447HH*			MD679X	MD679X		MD679XC*	36
Speed Triple R 1050	2013-2017			FA447HH*	EPFA447HH*			MD679X	MD679X		MD679XC*	37
Sprint GT	2010-2011	FA236*		FA236HH*				MD817X	MD817X		MD817XC*	38
Sprint GT SE	2013-2020	FA236*		FA236HH*				MD817X	MD817X		MD817XC*	39
Sprint ST 1050	2005-2010	FA236*		FA236HH*				MD669X	MD669X		MD669XC*	40
Sprint ST 1050	2005-2010	FA236*		FA236HH*				MD669X	MD669X		MD669XC*	41
Sprint ST 1050i	2011-2012	FA236*		FA236HH*				MD817X	MD817X		MD817XC*	42
Sprint ST 1050i	2011-2012	FA236*		FA236HH*				MD817X	MD817X		MD817XC*	43
Tiger 1050	2006-2015			FA347HH*	EPFA347HH*			MD679X	MD679X		MD679XC*	44
Tiger 1050 SE	2011-2013			FA347HH*	EPFA347HH*			MD679X	MD679X		MD679XC*	45
Tiger 1050 Sport	2013-2021			FA347HH*				MD679X	MD679X		MD679XC*	46
Bonneville Bobber	2017-2020	FA142	FA142V	FA142HH								47
Bonneville Bobber	2021-2023	FA181		FA181HH								48
Bonneville Bobber Black Twin disc	2018-2020	FA196*	FA196V*	FA196HH*								49
Bonneville Bobber Black Twin disc	2021-2023	FA181*		FA181HH*				MD873	MD873			50
Bonneville Speedmaster 1200 Twin	2018-2023	FA181X*	FA181V*	FA181HH*				MD873	MD873			51
Daytona 1200	1993-1998	FA236*		FA236HH*				MD640	MD640			52
Scrambler XC 1200	2019-2023			FA447HH*				MD8014X	MD8014X		MD8014XC*	53
Scrambler XC 1200 Gold Line	2023			FA447HH*				MD8008XC	MD8008XC			54

APPLIATIONS

SAFETY NOTICE - With vehicles primarily designed for off highway use such as quads now being used on the highway, we would recommend the use of X or MXS pads for highway use and ONLY using the R and SV higher density / harder pad series for off road riding.

*-2 Sets Required. † For Vee disc colours add RED, BLU, GRN, GLD, ORG suffix to part number. **SAFETY WARNING:- DO NOT USE HH PADS ON REAR UNLESS ALSO USED ON FRONT TO AVOID BRAKE IMBALANCE**

FRONT: Non-Japanese Bikes Cont'd

REAR: Non-Japanese Bikes

Line #	BRAKE ROTOR CHOICES - FRONT					REAR	DISC PAD CHOICES - REAR					BRAKE ROTOR CHOICES - REAR				
	CX Extreme® /Vee-Rotor	OSX Series Oversize 280mm Rotor Kit	Relocating Bracket for Oversize Rotor	SMX Series Oversize 320mm Rotor Kit	Relocating Bracket for 320mm Rotor		Front Disc Bolt Kit	FA/SFA/X Pad or Brake Shoe	Specialty Pads SXR/ VEE/MXS Race	Sintered/ HH Pads/ Grooved Shoes	EPFA Sintered Fast Road/ Track Pads	SV Series Severe Duty Pads	Standard Rotor	Vintage Rotor / UTV Oversize Brake Kit	Contour Profile Rotor	CX Extreme® /Vee-Rotor
1							FA214/2		FA214/2HH							
2							FA214/2		FA214/2HH			MD874				
3							FA214/2		FA214/2HH			MD874				
4	VR629BLK*†						FA214/2		FA214/2HH			MD663		MD663C	VR663	DB605/4
5	VR629BLK*†						FA214/2		FA214/2HH			MD663		MD663C	VR663	DB605/4
6	VR629BLK*†						FA214/2		FA214/2HH			MD663		MD663C	VR663	DB605/4
7	VR629BLK*†						FA196		FA196HH			MD643			VR643	
8							FA196		FA196HH			MD643			VR643	
9							FA213		FA213HH							
10							FA213		FA213HH							
11							FA213		FA213HH							
12							FA213		FA213HH							
13							FA213		FA213HH							
14							FA213		FA213HH							
15	VR646BLK*†						FA215/2		FA215/2HH			MD641			VR641	
16	VR646BLK*†						FA215/2		FA215/2HH			MD641			VR641	
17																
18																
19	VR640BLK*†						FA215/2		FA215/2HH			MD641			VR641	
20	VR647BLK*†					DB605/6	FA214/2		FA214/2HH			MD648		MD648C	VR648	DB605/4
21	VR669BLK*†						FA140		FA140HH			MD648		MD648C	VR648	DB605/4
22	VR669BLK*†						FA140		FA140HH			MD648		MD648C	VR648	DB605/4
23						DB605/6	FA214/2		FA214/2HH			MD648		MD648C	VR648	DB605/4
24	VR647BLK*†					DB605/6	FA215/2		FA215/2HH			MD663		MD663C	VR663	DB605/4
25	VR647BLK*†					DB605/6	FA215/2		FA215/2HH			MD663		MD663C	VR663	DB605/4
26	VR647BLK*†					DB605/6	FA214/2		FA214/2HH			MD663		MD663C	VR663	DB605/4
27						DB605/6	FA214/2		FA214/2HH			MD663		MD663C	VR663	DB605/4
28							FA196		FA196HH			MD643			VR643	
29							FA215/2		FA215/2HH			MD677				
30	VR640BLK*†						FA215/2		FA215/2HH			MD641			VR643	
31							FA214/2		FA214/2HH			MD648		MD648C	VR648	DB605/4
32							FA214/2		FA214/2HH			MD648				DB605/4
33							FA214/2		FA214/2HH			MD648				DB605/4
34							FA214/2		FA214/2HH			MD663		MD663C	VR663	DB605/4
35							FA214/2		FA214/2HH			MD820				
36							FA214/2		FA214/2HH							
37							FA214/2		FA214/2HH							
38							FA214/2		FA214/2HH			MD663		MD663C	VR663	DB605/4
39							FA214/2		FA214/2HH							
40	VR817BLK*†						FA214/2		FA214/2HH			MD820		MD820C	VR820	
41	VR817BLK*†						FA214/2		FA214/2HH			MD820		MD820C	VR820	
42	VR669BLK*†						FA214/2		FA214/2HH			MD663		MD663C	VR663	DB605/4
43	VR669BLK*†						FA214/2		FA214/2HH			MD820		MD820C	VR820	
44	VR817BLK*†						FA214/2		FA214/2HH			MD820		MD820C	VR820	
45	VR817BLK*†						FA214/2		FA214/2HH			MD820		MD820C	VR820	
46	VR679BLK*†						FA214/2		FA214/2HH			MD663		MD663C	VR663	DB605/4
47	VR679BLK*†						FA214/2		FA214/2HH			MD663		MD663C	VR663	DB605/4
48	VR679BLK*†						FA214/2		FA214/2HH			MD663		MD663C	VR663	DB605/4
49																
50							FA140		FA140HH			MD874				
51							FA140		FA140HH			MD874				
52							FA140		FA140HH							
53							FA140		FA140HH							
54	VR640BLK*†						FA215/2		FA215/2HH			MD641			VR641	
55							FA209/2		FA209/2HH			MD874				
56							FA209/2		FA209/2HH			MD874				

BRAKE APPLICATIONS

⊗ This symbol indicates a rotor made of billet steel, and should be only used with EBC FA Organic or Vee pads.
SAFETY NOTICE - With vehicles primarily designed for off highway use such as quads now being used on the highway, we would recommend the use of X or MXS pads for highway use and ONLY using the R and SV higher density / harder pad series for off road riding.

*-2 Sets Required. † For Vee disc colours add RED, BLU, GRN, GLD, ORG suffix to part number. **SAFETY WARNING:- DO NOT USE HH PADS ON REAR UNLESS ALSO USED ON FRONT TO AVOID BRAKE IMBALANCE**

FRONT: Non-Japanese Bikes Cont'd

REAR: Non-Japanese Bikes

Line #	BRAKE ROTOR CHOICES - FRONT					REAR	DISC PAD CHOICES - REAR					BRAKE ROTOR CHOICES - REAR				
	CX Extreme® /Vee-Rotor	OSX Series Oversize 280mm Rotor Kit	Relocating Bracket for Oversize Rotor	SMX Series Oversize 320mm Rotor Kit	Relocating Bracket for 320mm Rotor		Front Disc Bolt Kit	FA/SFA/X Pad or Brake Shoe	Specialty Pads SXR/ VEE/MXS Race	Sintered/ HH Pads/ Grooved Shoes	EPFA Sintered Fast Road/ Track Pads	SV Series Severe Duty Pads	Standard Rotor	Vintage Rotor / UTV Oversize Brake Kit	Contour Profile Rotor	CX Extreme® /Vee-Rotor
1							FA209/2		FA209/2HH			MD874				
2							FA209/2		FA209/2HH			MD874				
3									FA266HH			MD851				
4									FA266HH			MD851				
5							FA214/2		FA214/2HH			MD851		MD851C		
6									FA209/2HH			MD851		MD851C		
7							FA214/2		FA214/2HH			MD851				
8							FA214/2		FA214/2HH			MD851				
9							FA214/2		FA214/2HH			MD851				
10	VR842BLK*†						FA214/2		FA214/2HH			MD863				
11	VR842BLK*†						FA214/2		FA214/2HH			MD863				
12									FA213HH			MD863				
13									FA213HH			MD863				
14									FA213HH			MD863				
15									FA213HH			MD863				
16									FA213HH			MD863				
17	VR842BLK*†						FA214/2		FA214/2HH			MD863				
18	VR842BLK*†						FA214/2		FA214/2HH			MD863				
19	VR842BLK*†						FA214/2		FA214/2HH			MD863				
20	VR842BLK*†						FA214/2		FA214/2HH			MD863				
21	VR842BLK*†						FA214/2		FA214/2HH			MD863				
22	VR842BLK*†						FA214/2		FA214/2HH			MD863				
23	VR842BLK*†						FA214/2		FA214/2HH			MD863				
24	VR842BLK*†						FA214/2		FA214/2HH			MD863				
25	VR646BLK*†						FA215/2		FA215/2HH			MD641			VR641	
26																
27	VR640BLK*†						FA215/2		FA215/2HH			MD641			VR641	
28							FA214/2		FA214/2HH							
29									FA209/2HH			MD831				
30									FA209/2HH			MD831				
31									FA209/2HH			MD831				
32									FA209/2HH			MD831				
33									FA209/2HH			MD831				
34									FA209/2HH			MD831				
35	VR669BLK*†								FA209/2HH			MD699				
36	VR669BLK*†								FA209/2HH			MD699				
37									FA209/2HH			MD699				
38									FA209/2HH			MD8015X				
39									FA630HH							
40									FA630HH							
41																
42																
43																
44																
45							FA83X		FA83R							
46																
47																
48							503									
49							504									
50																
51																
52							FA83X		FA83R							
53							FA83X		FA83R							
54																
55																
56																

BRAKE APPLICATIONS

⚠ This symbol indicates a rotor made of billet steel, and should be only used with EBC FA Organic or Vee pads. SAFETY NOTICE - With vehicles primarily designed for off highway use such as quads now being used on the highway, we would recommend the use of X or MXS pads for highway use and ONLY using the R and SV higher density / harder pad series for off road riding.

*-2 Sets Required. † For Vee disc colours add RED, BLU, GRN, GLD, ORG suffix to part number. **SAFETY WARNING:- DO NOT USE HH PADS ON REAR UNLESS ALSO USED ON FRONT TO AVOID BRAKE IMBALANCE**

FRONT: Non-Japanese Bikes

APPLICATIONS
BRAKE



U.M. UNITED MOTORS



DISC PAD CHOICES - FRONT

BRAKE ROTOR CHOICES - FRONT

Model	Year	FA/SFA/X Pad or Brake Shoe	Specialty Pads SXR/ VEE/MXS Race	Sintered/ HH Pads/ Grooved Shoes	EPFA Sintered Fast Road/Track Pads	GPFAX Sintered RACE ONLY Pads	SV Series Severe Duty Pads	Standard Rotor		Vintage Rotor / UTV Oversize Brake Kit	Contour Profile Rotor	Line #
								Standard Rotor Left	Standard Rotor Right			
Matrix 150 XX	2005-2006	SFA54		SFA54HH								1
Matrix II - 150	2007-2008	SFA323		SFA323HH								2
Matrix II - 150	2007-2008											3
Powermax 150 XX	2005-2006	SFA54		SFA54HH								4
Powermax 150 XX	2005-2006											5
Powermax 150 XX	2005-2006	SFA323		SFA323HH								6
Powermax 150 XX	2005-2006											7
DSF 200	2006-2008	FA135X	MXS135	FA135R								8
DTF 200	2006-2008	FA135X	MXS135	FA135R								9
Duel Sport Moto 2000 DS 200	2000-2005	FA56										10
Earthlander 200	2005-2006											11
Renegade 200	2003-2006	FA196		FA196HH								12
SMF 200	2008	FA135X	MXS135	FA135R								13
V2C 250 T	2006-2008	FA86		FA86HH								14
V2S 250 R	2006-2008	FA86*		FA86HH*				MD691	MD691			15
Xpeed 250 i	2008	SFA228		SFA228HH								16
		SFA197		SFA197HH								17
Bull 320	2008											18
MTX 450	2008	FA54X*		FA54R*								19
V2C 650 S	2006-2008	FA86*		FA86HH*								20
V2S 650 R	2006-2008	FA86*		FA86HH*				MD690	MD690	MD690C*		21
												22
												23
Desert Cat Mini 50	2004	346*		346G*								24
Desert Cat	2004	346*		346G*								25
Desert Cat 90	2004	346*		346G*								26
Black Widow 150	2004	FA83X*		FA83R*								27
Desert Cat 150	2004	FA83X*		FA83R*								28
Mobility 250	2004	FA83X*		FA83R*								29
Rage 250	2004											30
Mobility 500	2004	FA232X		FA232R								31
Mobility 500	2012	FA453X*		FA453R*								32
Mobility 650	2012											33
												34
												35
												36
												37
												38
												39
												40
												41
												42
												43
												44
												45
												46
												47
												48
												49
												50
												51
												52
												53
												54
												55
												56

FRONT

* This symbol indicates a rotor made of billet steel, and should be only used with EBC FA Organic or Vee pads.
 SAFETY NOTICE - With vehicles primarily designed for off highway use such as quads now being used on the highway, we would recommend the use of X or MXS pads for highway use and ONLY using the R and SV higher density / harder pad series for off road riding.

UNISON

VERTEMATI

VESPA

*-2 Sets Required. † For Vee disc colours add RED, BLU, GRN, GLD, ORG suffix to part number. **SAFETY WARNING:- DO NOT USE HH PADS ON REAR UNLESS ALSO USED ON FRONT TO AVOID BRAKE IMBALANCE**

FRONT: Non-Japanese Bikes Cont'd

REAR: Non-Japanese Bikes

Line #	BRAKE ROTOR CHOICES - FRONT					DISC PAD CHOICES - REAR					BRAKE ROTOR CHOICES - REAR					BRAKE APPLICATIONS
	CX Extreme® /Vee-Rotor	OSX Series Oversize 280mm Rotor Kit	Relocating Bracket for Oversize Rotor	SMX Series Oversize 320mm Rotor Kit	Relocating Bracket for 320mm Rotor	Front Disc Bolt Kit	FA/SFA/X Pad or Brake Shoe	Specialty Pads SXR/ VEE/MXS Race	Sintered/ HH Pads/ Grooved Shoes	EPFA Sintered Fast Road/ Track Pads	SV Series Severe Duty Pads	Standard Rotor	Vintage Rotor / UTV Oversize Brake Kit	Contour Profile Rotor	CX Extreme® /Vee-Rotor	
1																
2							SFA264		SFA264HH							
3																
4																
5																
6																
7																
8							FA115X		FA115R							
9							FA115X		FA115R							
10																
11							FA83X		FA83R							
12																
13							FA115X		FA115R							
14							602									
15							FA86		FA86HH							
16							SFA197		SFA197HH							
17																
18																
19							FA54X	MXS54	FA54R							
20							FA86		FA86HH							
21							FA86		FA86HH		MD689		MD689C			
22																
23																
24																
25							307		307G							
26							307		307G							
27																
28																
29																
30																
31																
32																
33																
34																
35																
36							FA208X	MXS208	FA208R							
37							FA208X	MXS208	FA208R							
38							FA208X	MXS208	FA208R							
39							FA208X	MXS208	FA208R							
40							FA208X	MXS208	FA208R							
41																
42																
43							899									
44							816									
45							816									
46							816									
47							899									
48							816									
49							SFA321		SFA321HH		MD956D					
50							SFA321		SFA321HH							
51							SFA321		SFA321HH							
52							816									
53							816									
54							816									
55							816									
56							816									

⚠ This symbol indicates a rotor made of billet steel, and should be only used with EBC FA Organic or Vee pads.
SAFETY NOTICE - With vehicles primarily designed for off highway use such as quads now being used on the highway, we would recommend the use of X or MXS pads for highway use and ONLY using the R and SV higher density / harder pad series for off road riding.

*-2 Sets Required. † For Vee disc colours add RED, BLU, GRN, GLD, ORG suffix to part number. **SAFETY WARNING:- DO NOT USE HH PADS ON REAR UNLESS ALSO USED ON FRONT TO AVOID BRAKE IMBALANCE**

FRONT: Non-Japanese Bikes

APPLICATIONS

BRAKE



VESPA



DISC PAD CHOICES - FRONT

BRAKE ROTOR CHOICES - FRONT

Model	Year	FA/SFA/X Pad or Brake Shoe	Specialty Pads SXR/VEE/MXS Race	Sintered/HH Pads/Grooved Shoes	EPFA Sintered Fast Road/Track Pads	GPFAX Sintered RACE ONLY Pads	SV Series Severe Duty Pads	Standard Rotor Left	Standard Rotor Right	Vintage Rotor / UTV Oversize Brake Kit	Contour Profile Rotor	Line #
ET4 150	1999-2004	SFA260		SFA260HH				MD910D				1
GTS 4V ABS 150	2018-2019	SFA353		SFA353HH								2
LX 150 ie	2005-2015	SFA260		SFA260HH				MD910D				3
LXV 150 ie	2010-2015	SFA260		SFA260HH				MD910D				4
Primavera 150	2013-2020	SFA353		SFA353HH				MD910D				5
PX 150 All models	2005-2006	SFA186							MD910D			6
S150 ie	2008-2015	SFA260		SFA260HH				MD910D				7
Sprint 150	2014-2015	SFA353		SFA353HH				MD910D				8
Sprint 150	2016-2020	SFA260		SFA260HH				MD910D				9
GT 200 L	2005-2009	SFA194		SFA194HH				MD956D				10
GT 200 L Gran Turismo	2005-2009	SFA353		SFA353HH				MD956D				11
ET 250	1997-2004	SFA260		SFA260HH				MD910D				12
GTS 250	2005-2009	SFA353		SFA353HH				MD956D				13
GTV 250	2007-2009	SFA353		SFA353HH				MD956D				14
LXV 250	2007-2009	SFA353		SFA353HH				MD956D				15
GTS 300	2018-2021	SFA353		SFA353HH				MD956D				16
GTS 300	2020-2023	SFA353		SFA353HH				MD956D				17
GTS 300 ie	2008-2015	SFA353		SFA353HH				MD956D				18
GTS 300 Super	2010-2015	SFA353		SFA353HH				MD956D				19
GTS 300 Super	2020-2023	SFA353		SFA353HH				MD956D				20
GTS 300 Super Tech	2022-2023	SFA353		SFA353HH				MD956D				21
GTS Super 300 HPE-Tech	2018-2021	SFA353		SFA353HH				MD956D				22
GTV 300 ie	2010-2015	SFA353		SFA353HH				MD956D				23
GTV SEI GIORNI	2019-2020	SFA353		SFA353HH				MD956D				24
946	2013-2015	SFA353		SFA353HH				MD956D				25
												26
												27
VOR												28
EVEN-E 450/530	2004	FA181X	MXS181	FA181R	EPFA181HH							28
MX 450/530	2004	FA181X	MXS181	FA181R	EPFA181HH							29
SM-E 450/530	2004	FA95		FA95HH	EPFA95HH							30
												31
												32
												33
												34
												35
												36
												37
												38
												39
												40
												41
												42
												43
												44
												45
												46
												47
												48
												49
												50
												51
												52
												53
												54
												55
												56

FRONT

⚠ This symbol indicates a rotor made of billet steel, and should be only used with EBC FA Organic or Vee pads. SAFETY NOTICE - With vehicles primarily designed for off highway use such as quads now being used on the highway, we would recommend the use of X or MXS pads for highway use and ONLY using the R and SV higher density / harder pad series for off road riding.

*-2 Sets Required. † For Vee disc colours add RED, BLU, GRN, GLD, ORG suffix to part number. **SAFETY WARNING:- DO NOT USE HH PADS ON REAR UNLESS ALSO USED ON FRONT TO AVOID BRAKE IMBALANCE**

FRONT: Non-Japanese Bikes Cont'd

REAR: Non-Japanese Bikes

Line #	BRAKE ROTOR CHOICES - FRONT					DISC PAD CHOICES - REAR					BRAKE ROTOR CHOICES - REAR					
	CX Extreme® /Vee-Rotor	OSX Series Oversize 280mm Rotor Kit	Relocating Bracket for Oversize Rotor	SMX Series Oversize 320mm Rotor Kit	Relocating Bracket for 320mm Rotor	Front Disc Bolt Kit	FA/SFA/X Pad or Brake Shoe	Specialty Pads SXR/ VEE/MXS Race	Sintered/ HH Pads/ Grooved Shoes	EPFA Sintered Fast Road/ Track Pads	SV Series Severe Duty Pads	Standard Rotor	Vintage Rotor / UTV Oversize Brake Kit	Contour Profile Rotor	CX Extreme® /Vee-Rotor	Rear Disc Bolt Kit
1								899								
2							SFA321	SFA321HH								
3								899								
4								899								
5								816								
6								903								
7								899								
8								816								
9								816								
10							SFA321	SFA321HH				MD956D				
11							SFA321	SFA321HH				MD956D				
12								899								
13							SFA321	SFA321HH				MD956D				
14							SFA321	SFA321HH				MD956D				
15							SFA321	SFA321HH				MD956D				
16							SFA321	SFA321HH				MD956D				
17							SFA321	SFA321HH				MD956D				
18							SFA321	SFA321HH				MD956D				
19							SFA321	SFA321HH				MD956D				
20							SFA321	SFA321HH				MD956D				
21							SFA321	SFA321HH				MD956D				
22							SFA321	SFA321HH				MD956D				
23							SFA321	SFA321HH				MD956D				
24							SFA321	SFA321HH				MD956D				
25							SFA321	SFA321HH				MD956D				
26																
27																
28							FA208X	MXS208	FA208R							
29							FA208X	MXS208	FA208R							
30							FA208X	MXS208	FA208R							
31																
32																
33																
34																
35																
36																
37																
38																
39																
40																
41																
42																
43																
44																
45																
46																
47																
48																
49																
50																
51																
52																
53																
54																
55																
56																

⚠ This symbol indicates a rotor made of billet steel, and should be only used with EBC FA Organic or Vee pads.
SAFETY NOTICE - With vehicles primarily designed for off highway use such as quads now being used on the highway, we would recommend the use of X or MXS pads for highway use and ONLY using the R and SV higher density / harder pad series for off road riding.

*-2 Sets Required. † For Vee disc colours add RED, BLU, GRN, GLD, ORG suffix to part number. **SAFETY WARNING:- DO NOT USE HH PADS ON REAR UNLESS ALSO USED ON FRONT TO AVOID BRAKE IMBALANCE**

RECOMMENDED DEALER INVENTORY - BRAKE PADS

BRAKE APPLICATIONS

Honda (S suffix = Street, D= Dirt, A= ATV)	Kawasaki (S suffix = Street, D= Dirt, A= ATV)	Suzuki (S suffix = Street, D= Dirt, A= ATV)	Yamaha (S suffix = Street, D= Dirt, A= ATV) Contd.	Accessory Store (In this column suffixes mean Model i.e. S means Suzuki) — NO HARLEY DAVIDSON FITMENTS INC
FA84R (A) 10	FA129 (S) 4	FA188HH (S) 6	FA88HH (S) 4	FA63 (S) 6
FA261HH (S) 8	FA158 (S) 4	FA379HH (S) 6	FA123V (S) 3	FA69 (H) 6
FA390HH (S) 8	FA158HH (S) 4	FA63 (S) 6	FA88 (S) 3	FA68 (K) 5
FA69/3 (S) 8	FA347HH (S) 4	FA128X (D/A) 4	FA101R (A/D) 2	FA158 (S/K) 4
FA84X (A) 8	FA36 (S) 4	FA129 (S) 4	FA101X (A/D) 2	FA188HH (S/K) 4
FA54R (D) 6	FA369/4HH (S) 4	FA145 (S) 4	FA104 (S) 2	FA261HH (H) 4
FA69 (S) 6	FA379HH (S) 4	FA152R (S) 4	FA123 (S) 2	FA379HH (K/S) 4
FA69/3HH (S) 6	FA84R (A) 4	FA152X (D) 4	FA123HH (S) 2	FA390HH (H) 4
FA124/2HH (S) 4	FA85 (S) 4	FA158HH (S) 4	FA135R (D/A) 2	FA447HH (T/D/BMW/S) 4
FA131R (D) 4	FA161 (S) 3	FA188 (S) 4	FA135X (D/A) 2	FA54X (H/S/K/Y) 4
FA131X (D) 4	FA229HH (S) 3	FA36 (S) 4	FA160 (S) 2	FA630HH (BMW/D) 4
FA174HH (S) 4	FA231HH (S) 3	FA369/4HH (S) 4	FA160HH (S) 2	FA85 (K) 4
FA265HH (S) 4	FA128R (A) 2	FA447HH (S) 4	FA165R (D/A) 2	FA88 (Y) 4
FA296HH (S) 4	FA128X (A) 2	FA63HH (S) 4	FA165X (D/A) 2	FA34 (Y) 3
FA388HH (S) 4	FA129V (S) 2	FA84R (A) 4	FA179 (A) 2	FA36 (S) 3
FA436 (S) 4	FA129V (S) 2	FA103V (S) 3	FA179V (S) 2	FA69/3 (K) 3
FA54X (D) 4	FA130X (D) 2	FA137R (A) 3	FA182 (S) 2	FA84R (K/K/S/Y) 3
MXS346 (D) 4	FA131R (D) 2	FA146 (S) 3	FA182HH (S) 2	FA101X (Y) 2
FA174 (S) 3	FA131X (D) 2	FA103 (S) 2	FA190 (S) 2	FA103 (S) 2
FA185X (D) 3	FA135R (D/A) 2	FA103HH (S) 2	FA190HH (S) 2	FA121 (H) 2
FA189 (S) 3	FA135X (D/A) 2	FA128R (D/A) 2	FA199HH (S) 2	FA123 (Y) 2
FA189HH (S) 3	FA141 (S) 2	FA135R (D) 2	FA199V (S) 2	FA123HH (Y) 2
FA121 (S) 2	FA152R (D) 2	FA135X (D) 2	FA267HH (S) 2	FA124 (H) 2
FA124 (S) 2	FA152X (D) 2	FA142 (S) 2	FA275HH (S) 2	FA124/2 (H) 2
FA124/2 (S) 2	FA161HH (S) 2	FA142HH (S) 2	FA307R (A) 2	FA125X (H) 2
FA124/2V (S) 2	FA188 (S) 2	FA145HH (S) 2	FA307X (A) 2	FA128R (K/S) 2
FA124HH (S) 2	FA188HH (S) 2	FA145V (S) 2	FA323R (A) 2	FA129 (K/S) 2
FA124V (D) 2	FA192HH (S) 2	FA146HH (S) 2	FA34 (S) 2	FA129HH (K/S) 2
FA125R (S) 2	FA249 (S) 2	FA146V (S) 2	FA348HH (S) 2	FA142 (H/S/T) 2
FA125X (D) 2	FA249HH (S) 2	FA150HH (S) 2	FA367R (S/H) 2	FA142HH (S/H) 2
FA142 (S) 2	FA33 (S) 2	FA150V (S) 2	FA41 (S) 2	FA145 (S) 2
FA142HH (S) 2	FA447HH (S) 2	FA158 (S) 2	FA41V (S) 2	FA146 (S) 2
FA142V (S) 2	FA54X (D) 2	FA35 (S) 2	FA423/4HH (S) 2	FA158HH (S/K) 2
FA185R (D) 2	FA62 (S) 2	FA366 (S) 2	FA442/4HH (S) 2	FA160 (Y) 2
FA187 (S) 2	FA67R (D) 2	FA372R (A) 2	FA488HH (S) 2	FA161 (K) 2
FA187HH (S) 2	FA67X (D) 2	FA38 (S) 2	FA499/4HH (S) 2	FA161HH (K) 2
FA196 (S) 2	FA68 (S) 2	FA38V (S) 2	FA61V (S) 2	FA171 (BMW) 2
FA196HH (S) 2	FA68HH (S) 2	FA51 (S) 2	FA642X (A) 2	FA179 (Y) 2
FA203 (S) 2	FA68V (S) 2	FA51V (S) 2	FA642R (A) 2	FA18 (D) 2
FA203HH (S) 2	FA73 (S) 2	FA54R (D) 2	FA642SV (A) 2	FA181R (KTM) 2
FA226 (S) 2	FA83R (D) 2	FA54X (D) 2	FA676 (A) 2	FA185X (H/K/S/Y) 2
FA226HH (S) 2	FA83X (S) 2	FA63V (S) 2	FA676R (A) 2	FA187 (H) 2
FA261/2HH (S) 2	FA84X (A) 2	FA65 (S) 2	FA70 (S) 2	FA187HH (H) 2
FA29 (S) 2	FA85HH (S) 2	FA65V (S) 2	FA70V (S) 2	FA188 (S/K) 2
FA30 (S) 2	FA85V (S) 2	FA84X (S) 2	FA81 (S) 2	FA196 (H/T) 2
FA31 (S) 2	MXS131 (D) 2	MXS131 (D) 2	FA84/3R (D/A) 2	FA203 (H) 2
FA346HH (S) 2	MXS135 (D) 2	MXS152 (D) 2	FA88V (S) 2	FA208R (KTM) 2
FA346R (D) 2	MXS152 (D) 2	MXS185 (D) 2	FA95 (S) 2	FA213 (BMW/S) 2
FA346X (D) 2	MXS185 (D) 2	MXS367 (D) 2	MXS131 (D) 2	FA216/3 (HD) 2
FA373R (A) 2	MXS367 (D) 2	FA715 (S) 2	MXS135 (D) 2	FA22 (BMW) 2
FA373X (A) 2	FA691 (S) 2	FA715HH (D) 2	MXS152 (D) 2	FA226 (H/T) 2
FA436HH (S) 2	FA691HH (S) 2	FA106X (D) 2	MXS185 (D) 2	FA226HH (H/T) 2
FA447HH (S) 2	FA137R (A) 1	FA137X (A) 1	FA676X (A) 2	FA252 (Y) 2
FA499/4HH (S) 2	FA161V (A) 1	FA147X (S) 1	FA676R (A) 2	FA252HH (Y) 2
FA679HH (S) 2	FA165X (D/A) 1	FA152/2R (D) 1	FA677X (A) 2	FA265HH (H) 2
FA69/2 (S) 2	FA174 (S) 1	FA152/2X (D) 1	FA677R (A) 2	FA29 (H) 2
FA69/3V (S) 2	FA185X (D) 1	FA157X (D) 1	MXS367 (D) 2	FA294HH (BMW) 2
FA69HH (S) 2	FA192 (S) 1	FA222 (S) 1	FA104HH (S) 1	FA236HH (H/H) 2
FA69V (S) 2	FA192V (S) 1	FA229 (S) 1	FA105X (S) 1	FA33 (D) 2
FA90 (S) 2	FA229 (S) 1	FA229V (S) 1	FA11 (S) 1	FA335HH (BMW) 2
FA90V (S) 2	FA231 (S) 1	FA230R (D) 1	FA119R (D) 1	FA346R (H) 2
FA92X (D/A) 2	FA231V (S) 1	FA230X (D) 1	FA119X (D) 1	FA367R (K/S/Y) 2
MXS125 (D) 2	FA237X (S) 1	FA231 (S) 1	FA136 (D) 1	FA368R (KTM) 2
MXS131 (D) 2	FA254 (S) 1	FA231HH (S) 1	FA152/2R (D) 1	FA369/4HH (K/S) 2
MXS185 (D) 2	FA258R (D) 1	FA231V (D) 1	FA152/2X (S) 1	FA38 (S) 2
MXS54 (D) 2	FA258X (D) 1	FA258R (D) 1	FA174V (S) 1	FA380HH (Y) 2
FA636HH (S) 2	FA302R (D) 1	FA258X (D) 1	FA199 (S) 1	FA407 (BMW) 2
FA679HH (S) 2	FA302X (D) 1	FA302X (D) 1	FA21X (A) 1	FA41 (Y) 2
FA701X (D/A) 2	FA305R (D) 1	FA317R (A) 1	FA267 (S) 1	FA442/4HH (Y) 2
FA701R (D/A) 2	FA305X (D) 1	FA366 (S) 1	FA275 (S) 1	FA491HH (T) 2
FA702X (D/A) 2	FA342R (A) 1	FA366HH (S) 1	FA275X (D) 1	FA51 (S) 2
FA702R (D/A) 2	FA342SV (A) 1	FA366V (S) 1	FA319/2HH (S) 1	FA54R (H/K/S/Y) 2
FA703X (D/A) 2	FA349R (A) 1	FA367R (D) 1	FA323X (D) 1	FA604/4HH (BMW) 2
FA703R (D/A) 2	FA349SV (A) 1	FA367X (S) 1	FA344R (A) 1	FA604/4HH (BMW/S) 2
FA704X (D/A) 2	FA37 (S) 1	FA36V (S) 1	FA345V (A) 1	FA61 (Y) 2
FA704R (D/A) 2	FA55 (S) 1	FA401R (D) 1	FA344X (A) 1	FA62 (K) 2
FA712X (D/A) 2	FA690HH (S) 1	FA401X (D) 1	FA428R (A) 1	FA63HH (S) 2
FA712R (D/A) 2	MXS258 (D) 1	FA413R (A) 1	FA428X (A) 1	FA65 (S) 2
FA714X (D/A) 2	MXS84 (D) 1	FA414R (A) 1	FA443X (A) 1	FA69/2 (H) 2
FA714R (D/A) 2	FA417/4HH (S) 2	FA419 (S) 1	FA444X (A) 1	FA69/3HH (H) 2
FA717 (S) 2	FA738R (A) 12	FA436 (S) 1	FA444X (A) 1	FA69HH (H) 2
FA717HH (S) 2	FA739R (A) 12	FA436HH (S) 1	FA445R (A) 1	FA70 (Y) 2
MXS84 (D) 2	FA197 (S) 2	FA496 (S) 1	FA445X (A) 1	FA81 (Y) 2
FA111R (A) 1	FA197HH (S) 2	FA496HH (S) 1	FA446R (A) 1	FA85HH (K) 2
FA111X (A) 1	FA377X (A) 4	FA496HH (S) 1	FA446X (A) 1	FA88HH (Y) 2
FA12 (S) 1	FA296HH (S) 2	FA84/3R (S) 1	FA450R (D) 1	FA90 (H) 2
FA12V (S) 1	FA436HH (S) 1	MXS135 (D) 1	FA450X (A) 1	FA95 (D) 2
FA13 (S) 1	FA261 (S) 1	MXS152/2 (D) 1	FA476X (A) 1	FA104 (Y) 1
FA13V (S) 1	FA226HH (S) 2	MXS54 (D) 1	FA477X (A) 1	FA125R (H) 1
FA140 (S) 1	FA228 (S) 1	SFA197 (S) 2	FA478R (A) 1	FA13 (H) 1
FA174V (S) 1	FA228HH (S) 1	SFA413 (S) 1	FA478R (A) 1	FA131R (H) 1
FA32 (S) 1	FA142HH (S) 2	FA226 (S) 1	FA478X (A) 1	FA131X (H) 1
FA32V (S) 1	FA686X (D/A) 2	SFA228 (S) 1	FA497X (A) 1	FA135R (K/S) 1
FA410R (A) 1		FA347HH (S) 2	FA674 (A) 2	FA135X (K/S) 1
FA410X (A) 1			FA674R (A) 2	FA140 (H/T) 1
FA84/2R (A) 1			FA675 (A) 2	FA152/2X (K/S) 1
FA86 (S) 1			FA675R (A) 2	FA152R (K/S) 1
FA92R (D/A) 1			FA676X (A) 2	FA152X (K/S) 1
FA759HH (S) 2			FA676R (A) 2	FA174 (H/K/S/Y) 1
FA757HH (S) 2			FA677 (A) 1	FA192 (K) 1
SFA693 (S) 1			FA677R (A) 1	FA192HH (K) 1
FA700HH (S) 2			MXS152/2 (D) 1	FA32 (H) 1
SFA723 (S) 1			FA662 (S) 1	FA363 (BMW) 1
			FA662 (S) 1	FA363HH (BMW) 1
			FA663 (S) 1	FA84X (H/K/S/Y) 1
			FA663HH (S) 1	
			FA725HH (S) 8	
			FA755X (D) 2	
			FA755R (D) 2	
			MXS755 (D) 2	
			FA677X (A) 2	
			FA677R (A) 2	
			FA181HH (D) 2	
			FA208R (D) 2	
			FA645X (A) 2	
			FA645R (A) 2	
			FA645SV (A) 2	

Yamaha
(S suffix = Street,
D= Dirt, A= ATV)

RECOMMENDED DEALER INVENTORY - BRAKE PADS/SHOES

BRAKE APPLICATIONS

Harley Davidson (S Suffix means Streetbike)	
FA400HH	(S) 6
FA94HH	(S) 4
FA409HH	(S) 4
FA200HH	(S) 3
FA400V	(S) 3
FA409V	(S) 3
FA71	(S) 2
FA72	(S) 2
FA200	(S) 2
FA381	(S) 2
FA400	(S) 2
FA409	(S) 2
FA434	(S) 2
FA381HH	(S) 2
FA94V	(S) 2
FA434HH	(S) 2
FA457HH	(S) 2
FA458HH	(S) 2
FA605/4HH	(S) 2
FA242	(S) 2
FA24/2V	(S) 2
FA71V	(S) 2
FA94V	(S) 2
FA216/3	(S) 2
FA216/3HH	(S) 2
FA216/3V	(S) 2
FA296HH	(S) 2
FA381	(S) 2
FA381V	(S) 2
FA381HH	(S) 2
FA387	(S) 2
FA387HH	(S) 2
FA409	(S) 2
FA457V	(S) 2
FA434HH	(S) 2
FA457HH	(S) 2
FA458V	(S) 2
FA605/4V	(S) 2
FA640	(S) 2
FA640V	(S) 2
FA640HH	(S) 2
FA78	(S) 1
FA79	(S) 1
FA201	(S) 1
FA387	(S) 1
FA201HH	(S) 1
FA387HH	(S) 1
FA72V	(S) 1
FA78V	(S) 1
FA79V	(S) 1
FA200V	(S) 1
FA201V	(S) 1
FA254	(S) 1
FA254V	(S) 1
FA254HH	(S) 1
FA434V	(S) 1
FA638	(S) 2
FA638V	(S) 2
FA638HH	(S) 2
FA710V	(S) 2
FA710HH	(S) 2
FA760V	(S) 2
FA760HH	(S) 2

BMW (S Suffix means Streetbike)

FA171	(S) 2
FA171V	(S) 2
FA209/2	(S) 2
FA209/2V	(S) 2
FA209/2HH	(S) 2
FA213HH	(S) 2
FA22	(S) 2
FA22V	(S) 2
FA294HH	(S) 2
FA363	(S) 2
FA363HH	(S) 2
FA407	(S) 2
FA407HH	(S) 2
FA57	(S) 2
FA57V	(S) 2
FA604/4HH	(S) 2
FA613HH	(S) 2
FA630HH	(S) 2
FA77	(S) 2
FA671	(S) 2
FA671HH	(S) 2
FA77V	(S) 2
FA213	(S) 1
FA213V	(S) 1
FA304HH	(S) 1
FA304V	(S) 1
FA335HH	(S) 1
FA363V	(S) 1
FA438HH	(S) 1
FA441HH	(S) 1
FA724HH	(S) 2
FA730HH	(S) 4
FA748HH	(S) 8
FA749HH	(S) 8
FA757HH	(S) 4
FA779HH	(S) 4

Ducati (S Suffix means Streetbike)

FA18V	(S) 2
FA209/2	(S) 2
FA209/2HH	(S) 2
FA209/2V	(S) 2
FA244	(S) 2
FA244HH	(S) 2
FA244V	(S) 2
FA266HH	(S) 2
FA322/2HH	(S) 2
FA447HH	(S) 2
FA47	(S) 2
FA630HH	(S) 2
FA95	(S) 2
FA95HH	(S) 2
FA95V	(S) 2
FA266	(S) 1
FA266V	(S) 1
FA47HH	(S) 1
FA447HH	(S) 2
FA181HH	(S) 2

Triumph (S Suffix means Streetbike)

FA196	(S) 2
FA196HH	(S) 2
FA196V	(S) 2
FA209/2	(S) 2
FA209/2HH	(S) 2
FA209/2V	(S) 2
FA214	(S) 1
FA214HH	(S) 2
FA215	(S) 1
FA215/2	(S) 1
FA215/2HH	(S) 2
FA226	(S) 2
FA226HH	(S) 2
FA236	(S) 2
FA236HH	(S) 2
FA236V	(S) 2
FA322/2HH	(S) 2
FA347HH	(S) 2
FA447HH	(S) 2
FA491HH	(S) 2
FA604/4HH	(S) 2
FA630HH	(S) 2
FA606	(S) 1
FA606HH	(S) 1
FA266HH	(S) 1
FA213	(S) 1
FA213HH	(S) 1
FA214/2HH	(S) 1
FA140	(S) 1
FA140HH	(S) 1

Polaris (A Suffix means ATV)

FA159R	(A) 4
FA354R	(A) 3
FA354SV	(A) 3
FA159SV	(A) 2
FA159X	(A) 2
FA232R	(A) 2
FA270R	(A) 2
FA452R	(A) 2
FA452X	(A) 2
FA456R	(A) 2
FA456X	(A) 2
FA475R	(A) 2
FA475X	(A) 2
FA489R	(A) 2
FA490R	(A) 2
FA656R	(A) 2
FA656X	(A) 2
FA657X	(A) 2
FA657R	(A) 2
FA680R	(A) 2
FA83R	(A) 2
FA270X	(A) 1
FA273R	(A) 1
FA314R	(A) 1
FA728	(A) 4
FA728SV	(A) 4

KTM (D Suffix means Dirtbike, S means Streetbike)

FA181R	(D) 4
FA181X	(D) 2
FA208R	(D) 4
FA208X	(D) 2
FA325R	(D) 1
FA325X	(D) 1
FA357R	(D) 1
FA357X	(D) 1
FA368R	(D) 4
FA368X	(D) 3
FA433/3HH	(D) 2
FA447HH	(S) 2
FA462R	(D) 1
FA463R	(D) 2
FA612R	(D) 1
FA612X	(D) 1
FA606	(S) 2
FA606HH	(S) 2
FA213	(S) 2
FA213HH	(S) 2
FA209/2	(D) 2
FA209/2HH	(D) 2
FA630HH	(S) 2
FA244	(S) 2
FA244HH	(S) 2
FA266	(S) 1
FA266HH	(S) 2

Honda — Shoes

Item Code	Qty for Dealer to Stock	Franchise	Market Segment
347	6	H	A
351	4	H	A
333	4	H	D/S
315	4	H	S/A
343	3	H	S/A
304	3	H	D
306	3	H	A
340	3	H	D/A
303	3	H	A
345	2	H	A
338	2	KT/M/P	D
330	2	H	D
321	2	H	S
301	2	H	A
347G	2	H	A
347S	2	H	A
351G	2	H	A
313	2	H	S
333G	1	H	D
304G	1	H	D
338G	1	H/K	D/A
322	1	KT/M	D
315G	1	H	D/A
310	1	H	S/D
320	1	H	S
306G	1	H	A
340G	1	H	A
318	1	H	S/D
343G	1	H	A
307G	1	P	A
339	1	H	A
346	1	H	A

Kawasaki — Shoes

Item Code	Rank in Overall Shoe Sales (not just this franchise)	Franchise	Market Segment
706	4	K	D/A
709	3	K	S
715	2	K/S	D
705	2	K	D/A
720	2	K/S	A
710	2	K	A/S
718	2	K	A
719	1	K	A
715G	1	K/S	D
705G	1	K	D/A
706G	1	K	A

Suzuki — Shoes

Item Code	Rank in Overall Shoe Sales (not just this franchise)	Franchise	Market Segment
606	4	S/K	D/A
626	3	S	S/A
602	3	S/K	S/D
636	3	S	A
604	2	S	D
603	2	S/K	D/A
628	2	S/K	A
633	2	S	A
634	2	S	A/S
614	2	S/K	D/A
636G	2	S	A
605	2	S	D/A
629	1	S	A
618	1	S/K	D/A
603G	1	K	D/A
634G	1	S	A
633G	1	S	A
604G	1	S	D/A
613	1	S/K	D/A
602G	1	S	D
606G	1	S	A
628G	1	K/S	A

Yamaha — Shoes

Item Code	Rank in Overall Shoe Sales (not just this franchise)	Franchise	Market Segment
503	5	Y	A/D
516	4	Y	S/A
528	4	Y	S/D/A
515	4	Y	S
527	3	Y	S/D/A
524	3	Y	A
532	3	Y	S
506	3	Y	D/A/S
503G	3	Y	D/A
501	3	Y	S/D/A
516G	3	Y	A
531	2	Y	S
524G	2	Y	A
532G	2	Y	D
502	2	S/Y	D
512	2	Y	S
528G	2	Y	D/A
530	1	Y	S
510	1	Y	D/S
506G	1	Y	D/A
518	1	Y	D/A
504	1	Y	D
527G	1	Y	D/A
514	1	Y	S
507	1	Y	D
520	1	Y	A

Accessory Store — Shoes

Item Code	Rank in Overall Shoe Sales (not just this franchise)	Franchise	Market Segment
347	1	H	A
351	2	H	A
333	3	H	D/S
503	4	Y	A/D
315	5	H	S/A
343	6	H	S/A
304	7	H	D
516	8	Y	S/A
306	9	H	A
340	10	H	D/A
303	11	H	A
345	12	H	A
528	13	H	S/D/A
338	14	KT/M/P	D
330	15	H	D
321	16	H	S
515	17	Y	S
301	18	H	S
527	19	Y	S/D/A
347G	20	H	A
524	21	Y	A
532	22	Y	S
606	23	S/K	D/A
626	24	S	S/A
602	25	S/K	S/D
347S	26	H	A
706	27	K	D/A
506	28	Y	D/A/S
709	29	K	S
636	30	S	A

ROAD RACING APPLICATIONS

BRAKE APPLICATIONS

Make & Model	Year	FRONT					REAR		
		Organic Pads or Shoes	Sintered/HH Pads Grooved Shoes	Sintered Pads EPFA	Sintered Pads GPFAX	Brake Rotor Left	Brake Rotor Right	Organic Pads or Shoes	Brake Rotor
HONDA									
NSF250 R (Moto 3)	2012-2013		FA347HH	EPFA347HH	GPFAX347HH		N/A	FA151	N/A
RS125	1988-1989	FA124						FA151	MD713
RS125	1990-1994	FA226	FA226HH	EPFA226HH			MD1003X	FA151	MD713
RS125	1995-2003	FA239		EPFA239HH			MD1003X	FA151	MD713
RS125 (Radial caliper)	2004-2007		FA347HH	EPFA347HH	GPFAX347HH		MD1003X	FA151	MD713
RS250	1988-1989	FA124*				MD1003X	MD1003X	FA151	MD724
RS250	1990-1994	FA226*	FA226HH*	EPFA226HH*		MD1003X	MD1003X	FA151	MD724
RS250	1995-2002	FA239*		EPFA239HH*		MD1003X	MD1003X	FA151	MD724
MORIWAKI									
MD250H	2008-2013		FA347HH	EPFA347HH	GPFAX347HH		MD1003X	FA151	N/A
YAMAHA									
TZ125	1994-1997	FA145	FA145HH	EPFA145HH			MD711RD	FA162	MD732
TZ250	1989-1990	FA145*	FA145HH*	EPFA145HH*		MD711LD	MD711RD	FA162	MD732
TZ250	1991-	FA145*	FA145HH*	EPFA145HH*		MD711LD	MD711RD	FA162	MD2021
TZ250	1992-1996	FA145*	FA145HH*	EPFA145HH*		MD711LD	MD711RD	FA162	MD732
TZ250	1997-2001	FA145*	FA145HH*	EPFA145HH*		MD730LD	MD730RD	FA162	MD732
TZ250 (Radial Caliper)	2002-2010		FA347HH*	EPFA347HH*	GPFAX347HH*	MD730LD	MD730RD	FA162	MD732
TZ350	1980-1990				GPFAX646HH*	MD-TZ350/500	MD-TZ350/500	FA162	MD732
TZ500	1975-1985					MD-TZ350/500	MD-TZ350/500		

PADS FOR AFTERMARKET CALIPERS

AMERICAN SUSPENSION CALIPERS	Standard Organic Pad	Optional Organic Pad	Semi-Sintered VEE Pad	Chrome Backed Semi-Sintered VEE Pad	Fully Sintered Pad	EPFA Fully Sintered Track Day Pad	GPFAX Fully Sintered Race Pad
B17 Mach 8 Radial mount 4 Piston caliper							
B17 Mach 8 Standard mount 2 Piston caliper	FA18		FA18V				
B17 Phantom 2 piston brake caliper	FA18		FA18V				
P26 2 Piston Caliper	FA18		FA18V				
AP LOCKHEED							
2 Piston 2 Pin CP2195CP2696 38E0	FA16	FA16S	FA16		FA16HH	EPFA16HH	GPFAX16HH
2 Piston 1 Pin CP4227 2S0	FA272						
2 Piston 1 Pin CP4226 2S0	FA272						
2 Piston 1 Pin CP70032S0 Radial mount	FA272						
2 Piston Sidecar caliper CP25762577317631773178							
4 Piston CP3086CP3369CP4484 D27	FA107A						
4 Piston CP4485CP4679	FA107/2A						
4 Piston CP4680 1 Piece Pad							
4 Piston Radial 2 Piece CP4488							
4 Piston Radial Monobloc 1 Piece Pad CP7853 D27 2E03E0							
4 Piston Radial Mount 4 Seperate Pads CP6688 8E0M9E0M					FA435/4HH	EPFA435/4HH	GPFAX435/4HH
4 Piston Sidecar Caliper CP70303S0 5S0							
6 Piston 2 Pins CP4466						EPFA263HH	
6 Piston No Pins CP336667	FA217						
BEHRINGER							
2 Piston Quad Caliper							
4 Piston Old Design	FA158				FA158HH	EPFA158HH	
4 Piston Radial					MXS405	EPFA405HH	
6 Piston New Design					MXS406	EPFA406HH	
6 Piston Old Design	FA249				FA249HH	EPFA249HH	
6 Piston Old Design Endurance	FA249/2						
6 Piston Old design2 piston	FA47	FA47S			FA47HH		

PADS FOR AFTERMARKET CALIPERS

BREMBO

	Standard Organic Pad	Optional Organic Pad	Semi-Sintered VEE Pad	Chrome Backed Semi-Sintered VEE Pad	Fully Sintered Pad	EPFA Fully Sintered Track Day Pad	GPFA Fully Sintered Race Pad
120A44110 P234 Supersport Rear Caliper	FA266		FA266V		FA266HH		
122A99021 P224 Off Road Caliper	FA181X				FA181R	EPFA181HH	
20 4756 5262 4 Piston P4 3034 @40mm Spacing Single pin pad fixing	FA95		FA95V		FA95HH	EPFA95HH	
20 5161 43 or 81 2 Piston P 232 Rear caliper Single Pad Fixing Pin With Anti Rattle Shim	FA47	FA47S			FA47HH		
20 5165 5568 Goldline 4 piston P4 3034 @ 40mm Spacing Single Pin pad Fixing	FA95		FA95V		FA95HH	EPFA95HH	
20 6800 1020 Goldline4 piston P4 3034 @ 65mm Spacing Two Pin Pad Fixing	FA244		FA244V		FA244HH	EPFA244HH	GPFA244HH
20 6950 51 2 Piston P232 Rear Caliper Single Pad Fixing Pin With Wire Clip	FA266		FA266V		FA266HH		
20 6951 125063 P234 Rear Caliper Single Pad Fixing Pin With Wire Clip	FA266		FA266V		FA266HH		
20 7850 1121 4 Piston P4 34 @ 65mm Spacing Wire clip pad retention Only					FA322/4HH	EPFA322/4HH	
20 8343 1121 or 3545 4 Piston P4 34 @ 100mm Spacing Wire clip pad retention Only					FA322/4HH	EPFA322/4HH	
20.9883 Radial Mount 100mm Monobloc Caliper					FA447HH	EPFA447HH	GPFA447HH
206121 P424 Rear Caliper							
220988530 P434 Radial Mount 100mm Monobloc Caliper					FA447HH	EPFA447HH	GPFA447HH
220A0610 P4 3034 Radial Mount Caliper 108mm 2 PinPad Fixing	FA244		FA244V		FA244HH	EPFA244HH	GPFA244HH
220A16810 P4 3034 Radial Mount Caliper 100mm 2 PinPad Fixing	FA244		FA244V		FA244HH	EPFA244HH	GPFA244HH
220A16820 P3034 Yamaha R1 0710 Radial Mount	FA244		FA244V		FA244HH	EPFA244HH	GPFA244HH
220A39710 P434 Radial Mount 108mm Monobloc Caliper	TBC				FA447HH	EPFA447HH	GPFA447HH
220A80210 P4 3034 Radial Mount Caliper 108mm 2 PinPad Fixing	FA244		FA244V		FA244HH	EPFA244HH	GPFA244HH
220A80310 P4 3034 Radial Mount 100mm 2 Pin Pad Fixing	FA244		FA244V		FA244HH	EPFA244HH	GPFA244HH
220B01010 GP4RX 4 Piston Radial Mount @ 108mm Spacing					FA447HH	EPFA447HH	GPFA447HH
M432 Monobloc Radial Front Caliper					FA630HH	EPFA630HH	GPFA630HH
X1017.4041 4 Piston 40mm Axial Monobloc Caliper						EPFA218/2HH	GPFA218HH
X206001 2 Piston P224 Rear Caliper Rear caliper @ 64mm Spacing							
X206101 4 Piston P424 Rear Caliper Rear caliper @ 64mm Spacing							
X97.37.6061 4 Piston Monobloc 3236 Radial mount@ 108mm Single Pin Fixing					FA218HH	EPFA218HH	
X9737 8081 Radial Mount 108mm Endurance Caliper						EPFA295HH	GPFA295HH
X97C4 6061 P434 Radial Monobloc 108mm 4 Pad Type Caliper					FA435/4HH	EPFA435/4HH	
X988870 2 Piston P234 Rear Caliper Rear caliper @ 64mm Spacing							
X99.C04 6061 4 Piston P 3434 Radial Mount Caliper @ 108mm Spacing 4 Pad Set						EPFA435/4HH	
XA07680 2 Piston P2 34 Radial Mount Note Only Sold As Set Of 4 pads					FA435/4HH	EPFA435/4HH	
XA1J040 P230 Rear Caliper							
XA1K480 Motocross Radial Caliper							
XA3.B8.3031 4 Piston P3236 Radial Mount Caliper @ 108mm Spacing Titanium Pistons						EPFA218/2HH	GPFA218HH
XA3.B8.6061 4 Piston P3236 Radial Mount Caliper @ 108mm Spacing Aluminium Pistons						EPFA218/2HH	GPFA218HH
XA3.J7.5051 4 Piston P 3438 Radial Mount @ 108mm Spacing Pinless Fixing							GPFA611HH
XA3.J7.6061 4 Piston P 3438 Radial Mount @ 108mm Spacing Pinless Fixing Lithium Body							GPFA611HH
XA32950 P434 Axial Radial Mount 65mm 4 Pad Set					FA322/4HH	EPFA322/4HH	
XA69510 P4 3034 Motard Radial Mount 108mm 2 Pin Pad Fixing	FA244		FA244V		FA244HH	EPFA244HH	GPFA244HH
XA78910 P4 3034 Motard Radial Caliper 100mm Mount 2 Pin Pad Fixing	FA244		FA244V		FA244HH	EPFA244HH	GPFA244HH
XA7G2 1011 P4 3236 Radial Mount Caliper 100mm						EPFA218/2HH	GPFA218HH
XA7G2.4041 4 Piston 100mm CNC Monobloc Caliper						EPFA218/2HH	GPFA218HH
XA8.Y3.31011 4 Piston P 3438 Radial Mount @ 130mm Spacing Pinless Fixing							GPFA611HH
XA9.33.1011 4 Piston P3236 Radial Mount Monobloc @108mm Spacing Single Pin fixing					FA218HH	EPFA218HH	
XB0 B1 3031 P4 3034							GPFA673HH
XB2P710XB2P711 Endurance Caliper							GPFA646HH
XQ21361 P228 Off Road Caliper	FA181				FA181R	EPFA181HH	
XQ21390 PF 26 Off Road Rear Caliper	FA368				FA368R	EPFA368HH	
EBC							
4 Piston	FA216/2				FA216/2HH		
FTE							
4 Piston Radial Supermoto					MXS405	EPFA405HH	
Piston Radial Supermoto					MXS406	EPFA406HH	

PADS FOR AFTERMARKET CALIPERS

GMA	Standard Organic Pad	Optional Organic Pad	Semi-Sintered VEE Pad	Chrome Backed Semi-Sintered VEE Pad	Fully Sintered Pad	EPFA Fully Sintered Track Day Pad	GPFAX Fully Sintered Race Pad
2 Piston rear large caliper model A CCI #09997	FA36		FA36V				
2 Piston small caliper model B CCI # 09996	FA76		FA76V		FA76HH		
4 Piston model F	FA115		FA115V		FA115HH		
HARRISON BILLET							
2 Piston 1296040	FA175				FA175HH	EPFA175HH	
Big 4 Piston 1296033	FA47	FA47S			FA47HH		
Big 6 Piston 1296033	FA47	FA47S			FA47HH		
Mini 6	FA175				FA175HH	EPFA175HH	
Slim Design	FA175				FA175HH	EPFA175HH	
HHI - HAWG HALTER							
4 Piston All Types	FA216/3		FA216/3V	FA216/3VLD	FA216/3HH		
4 Piston Sprocket brake	FA623				FA623HH		
6 Piston All Types	FA424				FA424HH	EPFA424HH	
IRON PEGASUS							
Small caliper 2 Pin Fixing	FA115		FA115V		FA115HH		
Small caliper Single Pin Fixing	FA47	FA47S			FA47HH		
ISR							
220230A 2 Piston	FA11						
22025XX 4 Piston	FA47	FA47S			FA47HH		
220260A Sprocket Caliper	FA11						
22027 2 Piston Rear	FA47	FA47S			FA47HH		
22028 2 Piston	FA47	FA47S			FA47HH		
22029 Rear 2 Piston	FA47	FA47S			FA47HH		
22030 2 Piston Rear	FA16	FA16S			FA16HH	EPFA16HH	GPFAX16HH
22032 6 Piston Large	FA175				FA175HH		
22033 2 Piston HD	FA16	FA16S			FA16HH	EPFA16HH	GPFAX16HH
22034 6 Piston Small	FA184						
22036 2 Piston	FA184						
22042 6 Piston Racing	FA175				FA175HH		
22043 4 Piston	FA184						
Radial 6 Piston Monoblock	FA184						
JAYBRAKE							
6 PFL 6 Piston for 11.5" disc Lower Height Friction					FA649HH		
6 PFL 6 Piston for 13" disc Full Height Friction					FA455HH		
Dual Quad 30004 2 & 4 Piston	FA115		FA115V		FA115HH		
Early Design 2 Piston	FA76		FA76V		FA76HH		
JFour 30044 4 Piston	FA188				FA188HH	EPFA188HH	
JSix 30064 6 Piston	FA243				FA243HH		
LYNDALL							
IMPORTANT NOTE DO NOT USE FULLY SINTERED PADS ON LYNDALL COMPOSITE ROTORS.							
PAD REF 7058	FA200		FA200V				
PAD REF 7059			FA94	FA94V			
PAD REF 7138	FA95		FA95V				
PAD REF 7153	FA115		FA115V				
PAD REF 7157	FA201		FA201V				
PAD REF 7174	FA244		FA244V				
PAD REF 7175							
PAD REF 7176	FA196		FA196V				
PAD REF 7177							
PAD REF 7182	FA216/3		FA216/3V				
PAD REF 7183	FA216/3		FA216/3V				
PAD REF 7195	FA400		FA400V				

PADS FOR AFTERMARKET CALIPERS

LYNDALL BRAKES Contd.

	Standard Organic Pad	Optional Organic Pad	Semi-Sintered VEE Pad	Chrome Backed Semi-Sintered VEE Pad	Fully Sintered Pad	EPFA Fully Sintered Track Day Pad	GPFAX Fully Sintered Race Pad
PAD REF 7196	FA434		FA434V				
PAD REF 7202	FA424						
PAD REF 7230	FA209/2		FA209/2V				
PAD REF 7231							
PAD REF 7233	FA381		FA381V				
PAD REF 7234	FA387		FA387V				
PAD REF 7254	FA409		FA409V				
PAD REF 7255			FA605/4V				
PAD REF 7256			FA457V				
PAD REF 7257			FA458V				

MAGURA

4 Piston Radial Supermoto Caliper	FA433/4				FA433/4HH	EPFA433/4HH	
-----------------------------------	---------	--	--	--	-----------	-------------	--

MOTOMASTER

4 Piston	FA158				FA158HH	EPFA158HH	
----------	-------	--	--	--	---------	-----------	--

NOVA/LEGENDS

4 Piston	FA216/3		FA216/3V		FA216/3HH		
----------	---------	--	----------	--	-----------	--	--

OMP

4 Piston Front and Rear fitment	FA95		FA95V		FA95HH	EPFA95HH	
6 Piston	FA116						
Sprocket caliper	FA116						

PERFORMANCE MACHINE

112 X 6B	FA249				FA249HH	EPFA249HH	
112 X 6QC	FA249				FA249HH	EPFA249HH	
112 X 6RSB	FA190		FA190V		FA190HH	EPFA190HH	
112 X 6SSB	FA190		FA190V		FA190HH	EPFA190HH	
124 X 4HR	FA216/2				FA216/2HH		
125 X 2	FA115		FA115V		FA115HH		
125 X 4R	FA216/3		FA216/3V		FA216/3HH		
125 X 4RSPH	FA216/3		FA216/3V		FA216/3HH		
125 X 4S	FA115		FA115V		FA115HH		
125 X 4SL	FA115		FA115V		FA115HH		
125 X 6	FA210		FA210V				
125 X 6QC	FA190		FA190V		FA190HH		
137 X 4	FA216/2				FA216/2HH		
137 X 4 2006					FA420HH		
137 X 4B	FA216/3		FA216/3V		FA216/3HH		
137 X 6	FA210		FA210V				
162 X 2	FA32		FA32V				

PFM

6 Piston Superbike caliper						EPFA263HH	
----------------------------	--	--	--	--	--	-----------	--

PRE TECH

4 Piston P402 Lockheed Replacement Caliper	FA158				FA158HH	EPFA158HH	
4 Piston Uni P401	FA180				FA180HH		
6 Piston	FA190		FA190V		FA190HH	EPFA190HH	
6 Piston Radial Mount	FA249				FA249HH	EPFA249HH	

PRO-ONE

2 Piston	FA47	FA47S			FA47HH		
4 Piston	FA158				FA158HH	EPFA158HH	

BRAKE LINES

EBC Brakes braided brake lines are manufactured in Great Britain from the highest quality materials, with braided stainless steel PTFE hose and grade 303 stainless steel precision machined fittings. At EBC Brakes we do not use mild steel or aluminum components in our brake lines, instead we choose stainless steel for every fitting, as this material offers maximum quality in terms of strength and corrosion resistance. EBC brake line kits are supplied 100% complete and include brand new stainless steel bolts for maximum visuals.

EBC Brakes braided hoses fit many bikes in front, rear and race designs. Braided hoses improve brake pressure transfer to the caliper and disc pads, they help improve lever feel and reduce "bulging" which may happen with standard rubber hoses. Braided hoses are also more resistant to abrasion or cuts common with off road riding and thereby improve safety.

EBC brake lines are designed and built to last, that's why every line is offered with a lifetime warranty. Every individual line is pressure tested after assembly and as an absolute guarantee of quality, EBC brake lines are manufactured to Federal Motor Vehicle Safety Standards (FMVSS-106) and have the following approvals: DOT, TÜV, ISO9001, DEKRA, ARAI, CQC AND ADR.



BLM is our standard braided hose series whereas BLMR series race hoses have fewer lines and are the choice for track and performance use giving an even firmer lever feel and improving service time. Racing kits take the shortest route from the master cylinder to the caliper. The lines usually bypass any Y-splitters in the existing system, this reduces the number of places where the brakes can leak. The two lines from the master cylinder are a lot easier to bleed than a system with a Y piece as each line bleeds independent of the other whereas with a Y piece they don't until fluid is below the Y piece.

Hose numbers are suffixed with a number and letter designating the number of hoses in the kits and front or rear, for example;

- BLM6038-1F is a kit with a single hose for front fitment
- BLM8111-3F is a kit with three hoses for front fitment
- BLM8113-1R is a kit with a single hose for rear fitment
- BLMR8114-2F is a race kit with two hoses for front fitment.

We do not sell BLMR race hoses for rear fitments, only front.

Some kits are sold as complete bike sets only and examples of numbering are:
BLM8169-4FR which is a four hose kit for a complete bike (front and rear).

All motorcycle brake lines (except Harley) are supplied with black stainless fittings, clear hose and red/blue EBC Brakes heat shrink.

HARLEY-DAVIDSON® BRAKE LINES

EBC Harley-Davidson® lines are supplied in a unique finish, with chromed stainless fittings, black hose and black/space-grey EBC Brakes heat shrink. Additionally, where many competitors use 'off the shelf' components, EBC Harley-Davidson® lines are manufactured using our own bespoke design of chrome plated hardware and brackets, ensuring perfect fitment for complex Harley-Davidson® brake line assemblies.

MOTOCROSS AND OFF-ROAD BRAKE LINES

EBC Brakes motocross and off-road brake lines are supplied with a hardened plastic sheath around the lower portion of the hose, to provide additional protection against damage which could otherwise result from the harsh and unforgiving conditions of off-road terrain. These brake lines are built to withstand a lifetime of off-road abuse, ensuring high performance and safe riding for the lifetime of the vehicle.



BRAKE LINES

APPLI
CATIONS
BRAKE



APRILIA



		OE Replacement Brake Lines (Front)	Race Standard Brake Lines (Front)	OE Replacement Brake Lines (Rear)	Line #
RS 250	1994-1997	BLM8008-3F	BLMR8008-2F	BLM8008-1R	1
RS 250	1998-1999	BLM8009-3F	BLMR8009-2F	BLM8009-1R	2
RS 250	2000-2002	BLM8010-3F	BLMR8010-2F	BLM8010-1R	3
Pegaso 650	1993-1996	BLM8002-1F		BLM8002-1R	4
Pegaso 650	1997-2003	BLM8003-1F		BLM8002-1R	5
Pegaso Strada 650	1997-2009	BLM8004-1F		BLM8004-1R	6
RST 1000 Futura	2001-2004	BLM8013-3F	BLMR8013-2F	BLM8013-1R	7
RSV 1000 Mille	1998-2003	BLM8015-3F	BLMR8015-2F	BLM8015-1R	8
RSV 1000 Mille R	2003-2004	BLM8017-3F	BLMR8017-2F	BLM8017-1R	9
RSV 1000 Mille Tuono	2003-2009	BLM8018-3F	BLMR8018-2F	BLM8018-1R	10
RSV 1000 R + RSV4	2008-2013	BLM8019-3F	BLMR8019-2F	BLM8019-1R	11
RSV 1000 R Factory My	2004-2009	BLM8020-3F	BLMR8019-2F	BLM8020-1R	12
SL 1000 Falco	1999-2003	BLM8022-3F	BLMR8022-2F	BLM8022-1R	13
Tuono V4 R + V4 R APRC	2011	BLM8023-2F	BLMR8023-2F	BLM8023-1R	14
					15
					16
BIMOTA					17
SB6	ALL	BLM8024-3F	BLMR8024-2F	BLM8024-1R	18
					19
BMW					20
F650	1994-2000	BLM8025-1F		BLM8025-1R	21
F650 GS/Dakar	2000-2007	BLM8026-1F		BLM8026-1R	22
K75 C Full Front	1986-1988	BLM8039-3F			23
K75 RT	1991-1996	BLM8040-3F		BLM8040-1R	24
K75 S ABS	1990-1996	BLM8041-2F		BLM8041-2R	25
K75 S Full Rear	1986-1990	BLM8042-3F		BLM8042-1R	26
K100/K100 RS/K100 RT Front	1983-1988	BLM8027-3F			27
K100 LT ABS	1990-1991	BLM8028-2F		BLM8028-2R	28
K100 LT	1987-1988	BLM8029-3F		BLM8029-1R	29
K100 RS Full Front	1986-1990	BLM8030-3F		BLM8030-1R	30
K100 RS 16V ABS	1990-1993	BLM8031-4F		BLM8031-2R	31
K100 RS ABS	1988-1990	BLM8032-4F		BLM8032-2R	32
K100 RS Flexible Front	1986-1990	BLM8033-3F		BLM8033-1R	33
K1100 LT ABS	1989-1999	BLM8034-4F		BLM8031-2R	34
K1100 RS 16V ABS	1994-1997	BLM8031-4F		BLM8031-2R	35
K1100 RS 16V ABS 2	1994-1997	BLM8036-4F		BLM8036-1R	36
K1100 RS	1992-1993	BLM8037-3F			37
K1200 RS ABS	1997-2001	BLM8038-6FR			38
R45/R65 Flexible Front	1978-1980	BLM8074-3F			39
R45/R65 Full Front	1979-1985	BLM8075-3F			40
R65	1985-1988	BLM8076-1F			41
R65 Flexible Front	1981-1985	BLM8077-3F			42
R65 Flexible Front	1985-1988	BLM8078-1F			43
R65 Full Front	1981-1985	BLM8079-3F			44
R75 Gears	1975	BLM8080-2F			45
R75/6 Front ATE Calipers	1976	BLM8081-1F			46
R75/6 Full Front	1975	BLM8082-1F			47
R75/6 Long Front	1974	BLM8083-1F			48
R80/7 Flexible Front	1977-1980	BLM8084-2F			49
R80/7 Full Front	1977-1980	BLM8085-2F			50
R80 GS Flexible Front	1986-1994	BLM8086-1F			51
R80 GS Full Front	1980-1985	BLM8087-1F			52
R80 R Flexible Front	1994	BLM8088-1F			53
R80 RT	1984-1990	BLM8089-2F		BLM8089-1R	54
R80 RT Flexible Front	1982-1984	BLM8090-3F			55
R80 ST Flexible Front	1982-1985	BLM8091-1F			56
R100/R100 CS Full Front	1980-1984	BLM8043-3F			

FRONT

REAR

BRAKE LINES



Line #

BMW

1	R100 GS	1991-1996
2	R100 GS Flexible Front	1991-1996
3	R100 RS	1987-1993
4	R100 RS Full Front	1977-1980
5	R100 RS Flexible Front	1981-1986
6	R100 RR Flexible Front	1980
7	R100 RT Full Front	1980
8	R100 S ATE Flexible Front	1977-1980
9	R100 S Flexible Front	1976-1980
10	R100 T Flexible Front	1979-1980
11	R1100 GS ABS	1994-2000
12	R1100 GS	1994-2000
13	R1100 R	1995-1996
14	R1100 R	1997-2001
15	R1100 RS ABS	1993-2000
16	R1100 RT ABS	1995-2000
17	R1100 S ABS	1998-2004
18	R1100 S Boxer Cup Replica	2003
19	R1100 S	1998-2001
20	R1100 S	2001-2003
21	R1150 GS ABS	1999-2001
22	R1150 GS ABS 2	2001-2002
23	R1150 GS	1999-2002
24	R1150 GS	1999-2002
25	R1150 GS Evo Brakes	2003-2004
26	R1150 GS Evo Brakes	2003-2004
27	R1150 R	2000-2002
28	R1150 RT ABS	2001
29	R1200 C ABS	1996-2005
30	R1200 R ABS	2011-2013
31	R850 C ABS	2000-2001
32	R850 GS ABS	2000-2001
33	R850 R ABS	1997-2001
34	R850 R	1995-1996
35	R850 R	1997-2001
36	R90 Flexible Front	1976
37	S1000 RR	2010-2014

FRONT

OE Replacement
Brake Lines (Front)

Race Standard
Brake Lines (Front)

OE Replacement
Brake Lines (Rear)

38		
39		
40	Raptor 650	2003-2006
41	Elefant 750	1987-1988
42	Elefant 900	1993-2000
43	Elefant 900 IE	1991-1992
44	V-Raptor 1000	2003

DUCATI

47	M 400 Monster	1994-2002
48	Pantah 500/600SL	1980-1984
49	Pantah 600TL	1984-1985
50	600 SS	1994-1998
51	M 600 Monster	1994-2002
52	M 620 Monster	2002-2004
53	M 696 Monster	2006-2008
54	748 Biposta/Strada	1995-1998
55	748 Biposta/Strada/SPS	1999-2003
56	748R	1999-2002

REAR

BLM8044-1F

BLM8044-1F

BLM8046-4F

BLM8047-2F

BLM8048-3F

BLM8049-2F

BLM8050-2F

BLM8051-2F

BLM8052-3F

BLM8053-2F

BLM8054-4F

BLM8055-3F

BLM8056-4FR

BLM8057-4FR

BLM8058-5FR

BLM8059-5FR

BLM8060-5FR

BLM8061-4FR

BLM8062-4FR

BLM8063-4FR

BLM8064-5FR

BLM8065-5FR

BLM8066-3F

BLM8067-3F

BLM8068-4F

BLM8069-4F

BLM8070-5FR

BLM8071-4F

BLM8072-4F

BLM8073-4F

BLM8072-4F

BLM8054-4F

BLM8094-5FR

BLM8056-4FR

BLM8057-4FR

BLM8097-2F

BLM8100-3F

BLMR8100-2F

BLM8107-3F

BLM8103-1F

BLM8104-3F

BLM8103-1F

BLM8108-3F

BLM8141-1F

BLM8147-3F

BLM8148-3F

BLM8116-1F

BLM8141-1F

BLM8143-3F

BLM8144-2F

BLM8117-3F

BLM8111-3F

BLM8119-3F

BLMR8143-2F

BLMR8117-2F

BLMR8118-2F

BLMR8119-2F

BLM8048-1R

BLM8051-1R

BLM8052-1R

BLM8054-1R

BLM8066-1R

BLM8066-1R

BLM8066-1R

BLM8066-1R

BLM8072-1R

BLM8073-1R

BLM8072-1R

BLM8054-1R

BLM8103-1R

BLM8104-1R

BLM8103-1R

BLM8108-1R

BLM8141-1R

BLM8147-1R

BLM8148-1R

BLM8116-1R

BLM8141-1R

BLM8143-1R

BLM8144-1R

BLM8117-1R

BLM8111-1R

BLM8119-1R

BRAKE
APPLICATIONS

BRAKE LINES

APPLIICATIONS
BRAKE



DUCATI



		OE Replacement Brake Lines (Front)	Race Standard Brake Lines (Front)	OE Replacement Brake Lines (Rear)	Line #
749	2003-2005	BLM8109-2F		BLM8109-1R	1
749S	2004-2005		BLMR8120-2F	BLM8120-1R	2
750/906 Paso	1986-1994	BLM8121-3F		BLM8121-1R	3
750 GT	1974	BLM8122-1F			4
750 SS	1991-1993	BLM8116-1F		BLM8116-1R	5
750 SS	1994-1997		BLMR8124-2F	BLM8116-1R	6
750 SS	1998-2002		BLMR8125-2F	BLM8125-1R	7
M 750 Monster	1996-2002	BLM8141-1F		BLM8141-1R	8
851 SP/888 Strada	1992-1993		BLMR8126-2F	BLM8126-1R	9
851 SP3	1991	BLM8127-3F		BLM8127-1R	10
851 Strada	1988-1992	BLM8128-3F		BLM8128-1R	11
848	2007		BLMR8110-2F		12
900 Supertlight	1994-1997		BLMR8129-2F	BLM8129-1R	13
900 SS	1994-1997		BLMR8129-2F	BLM8130-1R	14
900 SS	1998-2002		BLMR8125-2F	BLM8125-1R	15
900 SS Supersport	1977		BLMR8132-3F	BLM8132-1R	16
900 SS/Supertlight	1991-1993		BLMR8129-2F	BLM8133-1R	17
M 900 Monster	1993-1999	BLM8146-3F	BLMR8146-2F	BLM8146-1R	18
907 IE	1991-1994	BLM8134-3F		BLM8134-1R	19
916 Biposta/SP	1998-2001	BLM8111-3F	BLMR8118-2F	BLM8111-1R	20
916 Biposta/Strada	1994-1997	BLM8117-3F	BLMR8117-2F	BLM8117-1R	21
ST2	1997-2003	BLM8151-3F		BLM8151-1R	22
ST4	1998-2003	BLM8152-3F		BLM8152-1R	23
996	1998-2001	BLM8111-3F	BLMR8111-2F	BLM8111-1R	24
996 R	2000-2001	BLM8119-3F	BLMR8119-2F	BLM8119-1R	25
S4/S4R Monster	2000-2008		BLMR8149-2F	BLM8146-1R	26
999 R	2003-2005	BLM8138-2F	BLMR8138-2F	BLM8138-1R	27
998	2001-2003	BLM8111-3F	BLMR8111-2F	BLM8111-1R	28
999	2002-2005		BLMR8113-2F	BLM8113-1R	29
Sport Classic 2006	2006	BLM8150-3F		BLM8150-1R	30
1098/1098R/1098S/1198/1198S	2007	BLM8114-3F	BLMR8114-2F	BLM8114-1R	31
					32
					33
HARLEY-DAVIDSON® SPORTSTER					
XL 50	2007	BLM5112-1F		BLM5105-2R	34
XL All Models	2004-2013			BLM5105-2R	35
XL All Models	1987-2003			BLM5106-2R	36
XL 883 Custom	2004-2010	BLM5112-1F		BLM5105-2R	37
XL 883 Custom	1996-2003	BLM5108-1F		BLM5106-2R	38
XL 883 Deluxe	1987-1991	BLM5108-1F		BLM5106-2R	39
XL 883 Deluxe	1992-2003	BLM5111-1F		BLM5106-2R	40
XL 883 R	2004-2013	BLM5109-3F		BLM5105-2R	41
XL 883 R	2002-2003	BLM5126-3F		BLM5106-2R	42
XL 883 Standard	2004-2009	BLM5113-1F		BLM5105-2R	43
XL 883 Standard	1987-2003	BLM5108-1F		BLM5106-2R	44
XL 883L Low	2005-2015	BLM5115-1F			45
XL 883 N Iron	2010-2013	BLM5113-1F		BLM5105-2R	46
XL 883 N Iron	2014-2015	BLM5119-1F			47
XL 1200 Classic	1996-2003	BLM5107-1F		BLM5106-2R	48
XL 1200 Custom	1996-2003	BLM5108-1F		BLM5106-2R	49
XL 1200 R	2004-2011	BLM5109-3F		BLM5105-2R	50
XL 1200 Sport	1996-2003	BLM5110-3F		BLM5106-2R	51
XL 1200 Sportster	1988-2003	BLM5111-1F		BLM5106-2R	52
XL 1200C	2004-2013	BLM5112-1F		BLM5105-2R	53
XL 1200C/XL 1200CP	2012-2013	BLM5113-1F		BLM5105-2R	54
XL 1200 CP	2012	BLM5114-1F		BLM5105-2R	55
XL 1200 L Low	2007-2011	BLM5115-1F		BLM5105-2R	56

FRONT

REAR

BRAKE LINES



Line #

HARLEY-DAVIDSON® SPORTSTER



1	XL 1200 N Nightster	2008-2012
2	XL 1200 V Seventy Two	2012-2015
3	XL 1200 X Forty Eight	2012-2013
4	XL 1200 X Forty Eight	2014-2015

HARLEY-DAVIDSON® DYNA

7	FLD Switchback	2012-2014
8	FXD	1991-1999
9	FXD	2000-2007
10	FXD	2008-2013
11	FXD/FXDC	2000-2005
12	FXD35 35th Anniversary	2006-2007
13	FXDB Dyna Daytona	1991-1992
14	FXDB-S Sturgis	1991-1992
15	FXDBI Street Bob	2006-2015
16	FXDC	2006-2014
17	FXDC Dyna Glide Custom	1990-1992
18	FXDC Dyna Glide Custom	1991-1992
19	FXDC/FXDCI Dyna Super Glide	2005
20	FXDF Dyna Fat Bob	2008-2015
21	FXDL Dyna Low Rider	1993-2000
22	FXDL Dyna Low Rider	2001-2005
23	FXDL Dyna Low Rider	2006-2013
24	FXDS-Con Dyna Low Rider Convertible	1993-2000
25	FXDWG Dyna Wide Glide	1993-2005
26	FXDWG Dyna Wide Glide	2006-2008
27	FXDWG Dyna Wide Glide	2010-2014
28	FXDX Super Glide Sport	1999-2005
29	FXDXT Dyna Super Glide	2001-2003
30	FXR	1987-1994
31	FXR Super Glide	1987-1994
32	FXRS Low Rider Custom	1987-1994
33	FXRS-C Low Rider Convertible	1987-1994
34	FXRS-SP Low Rider Sport	1987-1994
35	FXRT Sport Glide Tourer	1987-1992

HARLEY-DAVIDSON® TOURING

38	FLH/FLT Except FLTR ABS	2009-2013
39	FLH/FLT	1992-1996
40	FLH/FLT	1997-2007
41	FLH/FLT	2008-2013
42	FLH/FLT	2009-2013
43	FLH/FLT	2014-2016
44	FLH/FLT	2008-2013
45	FLHR Road King	2008
46	FLHR	2014-2015
47	FLHR/FLHR-I Road King	1994-2007
48	FLHR/FLHRC	2008
49	FLHRC Road King Classic	1999-2007
50	FLHRS/FLHRSI Road King	2004-2007
51	FLHT/FLHTC/FLHTCU Electra Glide	1996-2007
52	FLHT/FLHTC/FLHTCU/FLHX	2008
53	FLHX Street Glide	2006-2007
54	FLHX	2014-2015
55	FLTR Road Glide ABS	2008-2013
56	FLTR/FLTR-I Road Glide	1998-2007

OE Replacement
Brake Lines (Front)

Race Standard
Brake Lines (Front)

OE Replacement
Brake Lines (Rear)

FRONT

REAR

BRAKE
APPLICATIONS

BRAKE LINES

APPLIICATIONS
BRAKE



HARLEY-DAVIDSON® TOURING



FLTRX/FLTRXS ABS	2015
FLTRX/FLTRXS	2015

HARLEY-DAVIDSON® SOFTAIL

FLS Softail Slim	2013-2015
FLS Softail Slim	2017-2018
FLST	2008-2013
FLST Fat Boy	1984-1999
FLST Fat Boy	2000-2006
FLST Heritage	1984-1990
FLST Heritage	2007
FLST-SB Cross Bones	2010-2011
FLSTC	2011-2015
FLSTC Heritage Classic	2011-2015
FLSTC Heritage Softail Classic	1987-2008
FLSTC Heritage Softail Classic	2009-2012
FLSTF	2011
FLSTF Fat Boy	1990-2011
FLSTF Fat Boy	2007
FLSTF Fatboy	2011
FLSTF/FLSTFB/FLSTF	2012-2013
FLSTF/FLSTN/FLSTB/FLS ABS	2012-2016
FLSTF/FLSTN/FLSTFB/FLS ABS	2012-2016
FLSTFB ABS	2011
FLSTFB Fatboy Low ABS	2011
FLSTN Softail Deluxe	2005-2013
FLSTN Softail Deluxe ABS	2011-2012
FLSTS Heritage Softail	1997-2003
FLSTSC Heritage Softail Classic	2005-2007
FXCW/FXCWC Softail Rocker	2008-2011
FXCWC ABS	2011
FXCWC Rocker ABS	2011
FXLR Low Rider Custom Low Bars	1987-1994
FXS Blackline	2011-2013
FXSB Breakout ABS	2014-2015
FXSB Breakout	2011-2014
FXSB Breakout	2015-2017
FXST	1984-1999
FXST	2000-2005
FXST ABS	2011-2015
FXST Softail	1984-1990
FXST Softail Standard	1999-2012
FXST/FXCW	2008-2013
FXST/FXSTB/FXSTC	2007
FXST/FXSTS/FXSTB	2006
FXSTB Softail Night Train	1999-2009
FXSTC Softail Custom	1987-1999
FXSTC Softail Custom	2007-2010
FXSTD	2000-2006
FXSTD	2007
FXSTD Deuce	2000-2007
FXSTS Springer Softail	1987-2006
FXSTSB Bad Boy	1995-1997

FRONT

OE Replacement
Brake Lines (Front)

Race Standard
Brake Lines (Front)

REAR

OE Replacement
Brake Lines (Rear)

Line #

		BLM5044-1F			1
		BLM5045-3F			2
					3
					4
		BLM5018-1F			5
		BLM5120-1F			6
				BLM5019-2R	7
				BLM5020-2R	8
				BLM5021-2R	9
		BLM5022-1F			10
				BLM5023-2R	11
		BLM5024-1F			12
		BLM5025-1F			13
		BLM5026-2F			14
		BLM5022-1F			15
		BLM5028-1F			16
		BLM5029-1F			17
		BLM5022-1F			18
				BLM5031-2R	19
		BLM5032-2F			20
		BLM5018-1F			21
		BLM5034-1F			22
		BLM5035-2F			23
		BLM5036-1F			24
		BLM5037-2F			25
		BLM5018-1F			26
		BLM5035-2F			27
		BLM5040-1F			28
		BLM5041-1F			29
		BLM5046-1F			30
		BLM5047-1F			31
		BLM5048-2F			32
		BLM5072-1F			33
		BLM5078-1F			34
		BLM5079-1F			35
		BLM5127-3F			36
		BLM5128-3F			37
				BLM5080-2R	38
				BLM5021-2R	39
		BLM5082-1F			40
		BLM5083-1F			41
		BLM5083-1F			42
				BLM5019-2R	43
				BLM5031-2R	44
				BLM5087-2R	45
		BLM5088-1F			46
		BLM5083-1F			47
		BLM5090-1F			48
				BLM5021-2R	49
				BLM5023-2R	50
		BLM5093-1F			51
		BLM5094-1F			52
		BLM5095-1F			53
					54
					55
					56

BRAKE LINES

APPLIICATIONS
BRAKE



HONDA

		OE Replacement Brake Lines (Front)	Race Standard Brake Lines (Front)	OE Replacement Brake Lines (Rear)	Line #
CBR 600 RR3-RR4	2003-2004	BLM1069-3F	BLMR1069-2F	BLM1069-1R	1
CBR 600 RR5	2005		BLMR1070-2F	BLM1070-1R	2
CBR 600 RR6	2006		BLMR1071-2F	BLM1071-1R	3
CBR 600 RR7	2007		BLMR1072-2F	BLM1072-1R	4
NTV 600 J-M	1988-1991	BLM1116-1F		BLM1116-1R	5
VT 600 CN-CW Shadow	1992-1998	BLM1146-1F			6
XL 600 LMF Paris Dakar	1985	BLM1154-1F			7
XL 600 RD-RF	1984-1985	BLM1155-1F			8
XL 600 VH-VT Transalp	1987-1996	BLM1156-1F		BLM1156-1R	9
XL 600 VV-VX Transalp	1997-1999		BLMR1157-2F	BLM1156-1R	10
CB 650 SC Nighthawk	1982	BLM1030-3F			11
CB 650 Z-B	1979-1981	BLM1031-3F			12
CX 650 ED	1983	BLM1092-3F		BLM1092-1R	13
CX 650 TD Turbo	1983	BLM1093-3F			14
NT 650 V Deauville	1998-2003	BLM1115-3F		BLM1115-1R	15
NX 650 J-T Dominator	1988-1996	BLM1117-1F		BLM1117-1R	16
NX 650 V-X Dominator	1997-1999	BLM1118-1F		BLM1117-1R	17
SLR 650 V-W	1997-1998	BLM1123-1F			18
XL 650 Y-3 Transalp	2000-2005		BLMR1157-2F	BLM1156-1R	19
CB 750 F1 High Bar	1976-1978	BLM1033-2F		BLM1033-1R	20
CB 750 F1 Twin Disc	1976	BLM1035-3F		BLM1035-1R	21
CB 750 F2	1977-1979	BLM1036-3F		BLM1036-1R	22
CB 750 F2N-Y	1992-2002	BLM1037-3F		BLM1037-1R	23
CB 750 FZ-FD	1979-1983	BLM1038-3F		BLM1038-1R	24
CB 750 KZ	1978-1980	BLM1041-3F	BLMR1041-2F	BLM1041-1R	25
CBX 750 FE	1984	BLM1084-3F		BLM1084-1R	26
NC750S/SD/SA	-2017	BLM1171-2F		BLM1171-2R	27
NC700SD	-2017	BLM1171-2F		BLM1171-2R	28
RVF 750 RR-RS	1994	BLM1121-3F	BLMR1121-2F	BLM1121-1R	29
VF 750 FD-FE	1983-1984	BLM1132-3F		BLM1132-1R	30
VFR 750 FG-FH	1986-1987	BLM1136-3F	BLMR1136-2F	BLM1136-1R	31
VFR 750 FJ-FK	1988-1989	BLM1137-3F	BLMR1137-2F	BLM1137-1R	32
VFR 750 FL-FP	1990-1993	BLM1138-3F	BLMR1138-2F	BLM1138-1R	33
VFR 750 FR-FV	1994-1997	BLM1139-3F	BLMR1139-2F	BLM1139-1R	34
VFR 750 RJ-RL	1988-1990		BLMR1140-2F	BLM1140-1R	35
VT 750 Shadow	2004-2010	BLM1147-1F			36
VT 750 V-W Shadow	1997-1998	BLM1148-1F			37
XLV 750	1984-1987	BLM1160-1F			38
XRV 750 L-3 Africa Twin	1990-2003	BLM1161-3F	BLMR1161-2F	BLM1161-1R	39
Pacific Coast PC800	1989-1998	BLM1119-3F			40
VFR 800 FW-FY	1998-2000	BLM1141-10FR			41
VFR 800 V-TEC ABS	2002-2010	BLM1142-13FR			42
VFR 800 V-TEC	2002-2010	BLM1143-10FR			43
CB 900 F2-F3 Hornet	2002-2006	BLM1042-3F	BLMR1042-2F	BLM1042-1R	44
CB 900 FA-FB	1980-1981	BLM1043-3F		BLM1043-1R	45
CB 900 FC-FD	1982-1983	BLM1044-3F		BLM1043-1R	46
CB 900 FZ	1979	BLM1045-3F		BLM1045-1R	47
CBR 900 RR2-RR3	2002-2003		BLMR1073-2F	BLM1073-1R	48
CBR 900 RRN-RRS Retaining Bundy	1992-1994	BLM1074-3F			49
CBR 900 RRN-S Fireblade	1992-1994	BLM1075-3F	BLMR1075-2F	BLM1075-1R	50
CBR 900 RRT-RRX Retaining Bundy	1996-1999	BLM1076-3F	BLMR1076-2F	BLM1076-1R	51
CBR 900 RRT-X Fireblade	1996-1999	BLM1077-3F	BLMR1076-2F	BLM1076-1R	52
CBR 900 RRY-RR1	2000-2001		BLMR1073-2F	BLM1078-1R	53
CB 1000 P-T Big One	1993-1996	BLM1001-3F	BLMR1001-2F	BLM1001-1R	54
CB 1000 R	2008-2014		BLMR1002-2F	BLM1002-1R	55
CBF 1000	2006	BLM1046-3F		BLM1046-1R	56

FRONT

REAR

BRAKE LINES



Line #

HONDA

1	CBR 1000 FH-FJ	1987-1988
2	CBR 1000 FK-FN	1989-1992
3	CBR 1000 FP-FR	1993-1999
4	CBR 1000 RR	2004-2005
5	CBR 1000 RR	2006-2008
6	CBR 1000 RR	2009-2014
7	CBX 1000 A	1980
8	CBX 1000 B Pro Link	1981
9	CBX 1000 Z	1979
10	GL 1000 KZ-K1	1979-1980
11	VF 1000 FE-FF	1984-1985
12	VF 1000 RE-RG	1984-1986
13	VTR 1000 SP1-SP2	1999-2008
14	VTR 1000 FV-F4	1997-2005
15	XL 1000 VW-V3 Varedero	1998-2006
16	CB 1100 RC-RD	1982-1983
17	CB 1100 SF-X11	1999-2002
18	CBR 1100 XX Blackbird	1996-2008
19	GL 1100 A-B Goldwing	1980-1981
20	GL 1100 AD Aspencade	1983
21	GL 1100 DC Deluxe	1982
22	ST 1100 AN-AS Pan European ABS	1992-1994
23	ST 1100 L-2 Pan European	1990-2002
24	GL 1200 AE-AH Aspencade	1984-1987
25	CB 1300	1997-2003
26	CB 1300 UK Model	2002-2003
27	CB 1300 SA ABS	2005-2006
28	F6C	1996-2003
29	GL 1500 J-SEY Goldwing	1988-2000

FRONT

OE Replacement
Brake Lines (Front)

Race Standard
Brake Lines (Front)

OE Replacement
Brake Lines (Rear)

HONDA OFF-ROAD

32	CR 85 R	2003-2008
33	CR 85 R Expert	2003-2008
34	CR 125 R/250 R	1997-2007
35	CRF 230 L	2008
36	CRF 250 F/450 F	2003-2004
37	CRF 250 L	2013-2017
38	CRF 250 R/CRF 450 R	2004-2008
39	CRF 250 R/CRF 450 R	2009-2017
40	CRF 250 X/CRF 450 X	2005-2017
41	XR 400 R	1996-2004
42	CR 500	1997-2004
43	XR 650 L	2004
44	XR 650 R	2000-2003
45	XR 650 R	2004

REAR

KAWASAKI

48	KDX 125 A1-B2	1990-1994
49	KMX 125/200	1986-2002
50	Z 125 Pro	2017
51	KDX 200/220	1995-1999
52	KDX 200 E1	1990-1994
53	GPX 250 R F2-F9	1988-1996
54	KLR 250 D2-D16	1984-2001
55	Z 250 A1-A3	1979-1982
56	ZZR 250 H1-H2	1990-1992

BRAKE
APPLICATIONS

BRAKE LINES

BRAKE APPLICATIONS



KAWASAKI



		OE Replacement Brake Lines (Front)	Race Standard Brake Lines (Front)	OE Replacement Brake Lines (Rear)	Line #
KR1-KR1S	1989-1992	BLM4051-3F	BLMR4051-2F	BLM4051-1R	1
KLX 300 R	1997-1999	BLM4048-1F		BLM4048-1R	2
EX300 Ninja	2013-2015	BLM4182-1F		BLM4182-1R	3
KH 400	1977-1980	BLM4041-2F			4
ZR 400 A1-B1	1983-1985	BLM4134-3F			5
ZXR 400 L1-L9	1991-2003	BLM4169-3F	BLMR4169-2F	BLM4169-1R	6
GPZ 500 S A1-A6	1987-1993	BLM4018-1F			7
GPZ 500 S D1-E8	1994-2001	BLM4019-1F		BLM4019-1R	8
GPZ 500 S E9-E10	2002-2004	BLM4020-2F	BLMR4020-2F	BLM4019-1R	9
KH 500	1976	BLM4042-2F			10
KLE 500 A1-A7	1991-1999	BLM4043-1F		BLM4043-1R	11
KLE 500 B	2005-2006	BLM4044-1F		BLM4044-1R	12
Vulcan 500	1996-1997	BLM4066-1F			13
Z 500	1980-1983	BLM4099-3F			14
GT 550 G1-G9	1983-2001	BLM4026-3F			15
Z 550 A1	1980	BLM4100-3F			16
Z 550 D1	1981	BLM4101-3F		BLM4101-1R	17
Z 550 H1-H2	1982-1983	BLM4102-3F		BLM4102-1R	18
Z 550 LTD C1-C2	1980-1983	BLM4103-3F			19
ZR 550 A1-A2	1982-1987	BLM4135-3F			20
ZR 550 B2-B6 Zephyr	1991-1998	BLM4136-3F		BLM4136-1R	21
ZX 550 A1-A4	1983-1991	BLM4150-5F		BLM4150-1R	22
ER6 F/N	2013-2014	BLM4008-2F		BLM4008-1R	23
ER6 F/N	2006-2009	BLM4009-2F	BLMR4009-2F	BLM4009-1R	24
ER6 F/N	2010-2012	BLM4010-2F	BLMR4010-2F	BLM4010-1R	25
GPX 600 R C1-C7	1988-1996	BLM4012-3F	BLMR4012-2F	BLM4012-1R	26
GPZ 600 R A1-A5	1985-1990	BLM4021-5F		BLM4021-1R	27
KLR 600 A1/B1-B4	1984-1990	BLM4046-1F			28
ZL 600 B1 Eliminator	1995-1997	BLM4129-1F			29
ZZR 600 D1-D3	1990-1993	BLM4179-3F	BLMR4179-2F	BLM4179-1R	30
ZZR 600 D4-E12H	1994-2006	BLM4180-3F	BLMR4179-2F	BLM4180-1R	31
ZX6R	2007-2008	BLM4151-2F	BLMR4151-2F	BLM4151-1R	32
ZX6R	2009-2012	BLM4152-3F	BLMR4152-2F	BLM4152-1R	33
ZX6R	2013-2014	BLM4153-2F	BLMR4153-2F	BLM4153-1R	34
ZX6R B1/ZX6RR K1	2003	BLM4154-2F	BLMR4154-2F	BLM4154-1R	35
ZX6R F1-F3	1995-1997	BLM4155-3F	BLMR4155-2F	BLM4155-1R	36
ZX6R G1-G2	1998-1999	BLM4156-3F	BLMR4156-2F	BLM4156-1R	37
ZX6R J1-J2/A1P	2000-2002	BLM4157-3F	BLMR4157-2F	BLM4157-1R	38
ZX6RR 04	2004	BLM4158-2F	BLMR4158-2F	BLM4158-1R	39
ZX6RR ZX636	2005-2006	BLM4159-2F	BLMR4159-2F	BLM4159-1R	40
KLR 650 A1-A3/C1-C8	1987-2002	BLM4047-1F		BLM4047-1R	41
KLX 650 C1-C2	1993-1996	BLM4049-1F		BLM4049-1R	42
Versys 650 ABS	2006-2010	BLM4052-5FR			43
Versys 650 ABS	2011-2013	BLM4053-7FR			44
Versys 650	2006-2010	BLM4054-2F		BLM4054-1R	45
Versys 650	2011	BLM4055-2F		BLM4055-1R	46
W 650	2003-2004	BLM4067-1F			47
Z 650 B1 Full Front	1977	BLM4104-2F			48
Z 650 B1 Twin Disc Front	1978	BLM4105-3F			49
Z 650 B2-B3	1978-1979	BLM4106-2F			50
Z 650 C2-C3	1978-1980	BLM4107-3F		BLM4107-1R	51
Z 650 D1	1978	BLM4108-3F			52
Z 650 D2-D3	1979-1980	BLM4109-3F			53
Z 650 F1	1980	BLM4110-3F			54
Z 650 F2-F4	1981-1983	BLM4111-3F			55
ZX7R P1-P7/ZX7RR N1	1996-2003	BLM4160-3F	BLMR4160-2F	BLM4160-1R	56

FRONT

REAR

BRAKE LINES



Line #

KAWASAKI

1	Z 1000 H	1980-1981
2	Z 1000 R2	1983
3	Z 1000 ST	1979
4	Z 1000 ST	1980
5	Z 1000 SX	2011-2013
6	Z 1000 SX	2014-2017
7	ZL 1000	1987-1990
8	ZR 1000 A1-A2	2003-2006
9	ZX10 B1-B3	1988-1991
10	ZX10R	2004-2005
11	ZX10R	2006
12	ZX10R	2007
13	ZX10R	2008-2010
14	ZX10R	2011-2014
15	ZX10R ABS	2011-2017
16	GPZ 1100 A1-A3	1983-1985
17	GPZ 1100 S E1-E2	1995-1999
18	Z 1100 A1-A3	1981-1984
19	Z 1100 A1-A3	1981-1983
20	Z 1100 B1-B2	1981-1982
21	Z 1100 R	1984-1986
22	ZR 1100 A1-A4/B1 Zephyr	1992-1997
23	ZRX 1100 C1-C2	1997-2001
24	ZZR 1100 C1-C3	1990-1992
25	ZZR 1100 D1-D9	1992-2001
26	ZRX 1200 A1-A3P/ZRX 1200S B1-B3P	2001-2004
27	ZRX 1200 R	2006
28	ZX12R A1-B2	1999-2003
29	ZX12R B3-B4	2004-2005
30	ZX12R B6	2005-2007
31	ZZR 1200	2002-2004
32	Z 1300 A1-A5	1979-1984
33	ZG 1300 A1-A3	1987-1990
34	ZZR 1400	2006-2010
35	VN 1500 B2-B6 Vulcan/C1-C2 Classic	1988-1996
36	VN 1500 D1-D2/E1 Classic/J1-J2 Drifter	1996-1999
37	VN 1500 E2 Classic Tourer/Nomad	2001-2004
38	VN 1500 E2 Classic/G1-G2 Nomad	1998-1999
39	VN 1600 A3H Classic	2003-2006
40	VN 1600 B2H Meanstreak	2003-2006
41	VN 1700 Classic	2009
42	VN 2000	2003-2009

FRONT

OE Replacement
Brake Lines (Front)

Race Standard
Brake Lines (Front)

OE Replacement
Brake Lines (Rear)

KAWASAKI OFF ROAD

43		
44		
45	KX 85	2000-2011
46	KX 100	1997-2011
47	KX 125/250	2003-2005
48	KDX 200 R/220 R	2005-2006
49	KX 250	2006-2007
50	KX 250 F	2004-2005
51	KX 250 F	2006
52	KX 250 F	2007-2008
53	KX 250 F	2009
54	KX 250 F	2011
55	KLX 300 R	2005-2008
56	KLX 450 R	2008-2009

REAR

BLM4081-3F

BLM4082-3F

BLM4083-3F

BLM4084-3F

BLMR4085-2F

BLM4189-4F

BLM4128-3F

BLM4132-2F

BLM4141-3F

BLM4142-2F

BLM4143-2F

BLM4144-2F

BLMR4132-2F

BLMR4141-2F

BLMR4142-2F

BLMR4143-2F

BLMR4144-2F

BLMR4145-2F

BLMR4146-2F

BLM4146-3F

BLM4185-4F

BLM4015-5F

BLM4016-3F

BLM4086-3F

BLM4087-3F

BLM4088-3F

BLM4089-3F

BLM4133-3F

BLM4138-3F

BLM4174-3F

BLM4175-3F

BLM4139-3F

BLM4140-3F

BLM4147-3F

BLMR4133-2F

BLMR4138-2F

BLMR4174-2F

BLMR4175-2F

BLMR4139-2F

BLMR4147-2F

BLMR4148-2F

BLMR4149-2F

BLM4149-3F

BLM4176-3F

BLM4090-3F

BLM4127-3F

BLM4177-3F

BLMR4177-2F

BLM4056-1F

BLM4057-1F

BLM4058-3F

BLM4059-2F

BLMR4060-2F

BLM4061-3F

BLMR4062-2F

BLM4063-3F

BLMR4063-2F

BLM6017-1F

BLM6017-1F

BLM6018-1F

BLM6014-1F

BLM6019-1F

BLM6018-1F

BLM6021-1F

BLM6022-1F

BLM6023-1F

BLM6024-1F

BLM6015-1F

BLM6016-1F

BLM4081-1R

BLM4082-1R

BLM4083-1R

BLM4084-1R

BLM4085-1R

BLM4189-1R

BLM4128-1R

BLM4132-1R

BLM4141-1R

BLM4142-1R

BLM4143-1R

BLM4144-1R

BLM4145-1R

BLM4146-1R

BLM4185-2R

BLM4015-1R

BLM4016-1R

BLM4086-1R

BLM4087-1R

BLM4088-1R

BLM4089-1R

BLM4133-1R

BLM4138-1R

BLM4174-1R

BLM4175-1R

BLM4139-1R

BLM4140-1R

BLM4147-1R

BLM4147-1R

BLM4147-1R

BLM4176-1R

BLM4090-1R

BLM4127-1R

BLM4177-1R

BLM4056-1R

BLM4057-1R

BLM4058-1R

BLM4059-1R

BLM4060-1R

BLM4061-1R

BLM4063-1R

BLM6017-1R

BLM6017-1R

BLM6017-1R

BLM6014-1R

BLM6019-1R

BLM6017-1R

BLM6021-1R

BLM6022-1R

BLM6023-1R

BLM6024-1R

BLM6015-1R

BLM6016-1R

BRAKE
APPLICATIONS

BRAKE LINES

APPLIICATIONS
BRAKE



KAWASAKI OFF ROAD

KX 450 F	2006-2008
KX 450 F	2009-2011
KX 500	1995-2004

KTM OFF ROAD

125/200/250 EXC	2000-2003
125/200/250 SX	2004-2005
125/200 EXC	1998-1999
125/200 SX/MXC	2000-2003
125/200 SX/MXC	1995-1999
125 EXC/SX/SXS	2004-2009
200 EXC/XC/XCW MXC	2000-2009
250 MXC/SXC	2000-2001
250 EXC/SX	2003-2009
250 EXC/XC/XCF	2002-2009
250 SX/MXC	2000-2002
250 SX/MXC	1994-1999
360/380 EXC	2000-2003
300/360/380 SX/MXC	2000-2002
360/380 SX/MXC	1994-1999
300 EXC/MXC	2004-2009
300 EXC/XC/MXC	2006-2009
380 EXC/MXC/SX	2000-2002
400/520 SX/MXC	2000-2002
400/540/620 SC/EXC	1998-1999
400/540/620 SX	1996-1999
400 EXC/MXC	2000-2009
450/525 SX	2004-2005
450 EXC/MXC/SXS/XC	2003-2009
505 XC	2008-2009
520 SC/EXC	2000-2002
520 EXC/SX/MXC	2000-2002
525 EXC/MXC/SX/XC	2003-2007
525 MXC	2003
525 SX/450SX	2003
530 EXC/XCR/XCW	2008-2009
625 SC/SXC	2002-2007
660 Rallye	2000-2003

LAVERDA

Jota 120/180	1978-1982
Montjuic 500	1979-1983
750 Formula/750 SS	1997-2002
Mirage 1200	1978-1979

MOTO GUZZI

V50 Monza MK1	1980-1981
V50 Monza MK2	1982-1983
V50 Monza MK3	1984-1986
V65 Lario	1985-1988
V65/V65 SP/V65 ST	1984-1991
V65 TT	1985-1988
750 Targa	1990-1994
850 Le Mans MK1	1978-1979
850 Le Mans MK2-MK3	1979-1985
850 T3	1980

OE Replacement
Brake Lines (Front)

Race Standard
Brake Lines (Front)

OE Replacement
Brake Lines (Rear)

FRONT

REAR

Line #

1
2
3
4
5
6
7
8
9
10
11
12
13
14
15
16
17
18
19
20
21
22
23
24
25
26
27
28
29
30
31
32
33
34
35
36
37
38
39
40
41
42
43
44
45
46
47
48
49
50
51
52
53
54
55
56

BRAKE LINES



Line #

MOTO GUZZI

1	850 T3 California	1977-1982
2	850 T5	1983-1988
3	1000 California MK2	1982-1987
4	1000 Le Mans MK4	1985-1988
5	1000 Le Mans MK5	1988-1994
6	1000 Mille Gt	1988-1991
7	1000 Spada MK1-MK2	1980-1988
8	1000 Spada MK3	1989-1994
9	1100 California EV	1997-2002
10	1100 California Jackal	1999-2001
11	1100 California MK3	1994-1997
12	1100 Sport Carb	1996-1999

MV AGUSTA

15	F3 675 Agusta	2013
16	Brutale S 750	2004
17	F4 750	2000-2004
18	850 Monza	1977
19	F4 1000 S	2004

SUZUKI

22	DR 125 SF-SJ	1985-1994
23	GP 125 X-D	1982-1989
24	RG 125 FUN-FUR	1991-1994
25	TS 125 RK-RR	1990-1996
26	GS 250 TT-TX	1980-1981
27	GSX 250 ET-EX	1980-1981
28	GSX 250 EZ Katana	1982
29	RG 250 FG-FH	1985-1989
30	RG 250 WD	1983
31	RG 250 WE	1984
32	RGV 250 K-L	1989-1990
33	RGV 250 M-N	1991-1992
34	RGV 250 P-R	1993-1997
35	DR 350 SES-SEX	1995-1999
36	DR 350 SL-SR	1990-1994
37	GT 380 M	1975
38	GS 400/425	1977-1980
39	GSF 400 M-R Bandit	1991-1994
40	GSX 400 EZ	1982
41	GSX 400 FX Non Anti-Dive	1981
42	GSX 400 FZ-FD Anti-Dive	1982-1986
43	GSZ 400 FZ-FD Twin Anti-Dive	1982-1986
44	GSXR 400 RRK-RRN	1989-1992
45	GS 450 EG-EJ	1985-1989
46	GS 500 EK-ER	1989-1994
47	GS 500 ES-K4	1995-2005
48	GS 500 F	2003-2009
49	RG 500 G-CH	1985-1989
50	GS 550 EN	1979
51	GS 550 ET-EX	1980-1981
52	GS 550 LT-LX	1980-1982
53	GS 550 MX Katana	1981
54	GSX 550 E	1985-1988
55	GSX 550 E	1983-1984
56	GT 550 A	1976

OE Replacement
Brake Lines (Front)

Race Standard
Brake Lines (Front)

OE Replacement
Brake Lines (Rear)

FRONT

REAR

BRAKE
APPLICATIONS

BRAKE LINES

APPLICATIONS
BRAKE



SUZUKI



		OE Replacement Brake Lines (Front)	Race Standard Brake Lines (Front)	OE Replacement Brake Lines (Rear)	Line #
DR 600 SF-RG	1984-1987	BLM3007-1F			1
GSF 600 S Bandit	1995	BLM3042-3F	BLMR3042-2F	BLM3042-1R	2
GSF 600 T-X Bandit	1996-1999	BLM3043-3F	BLMR3043-2F	BLM3042-1R	3
GSF 600 Y-K4 Bandit	2000-2005	BLM3044-3F	BLMR3044-2F	BLM3044-1R	4
GSR 600	2006-2010	BLM3049-2F	BLMR3049-2F	BLM3049-1R	5
GSR 600 ABS	2006-2011	BLM3050-5FR			6
GSX 600 FJ-FV	1988-1997	BLM3071-3F	BLMR3071-2F	BLM3071-1R	7
GSX 600 FW-K3	1998-2003	BLM3072-3F	BLMR3072-2F	BLM3072-1R	8
GSXR 600	2004-2005	BLM3097-2F	BLMR3097-2F	BLM3097-1R	9
GSXR 600	2006-2010	BLM3098-2F	BLMR3098-2F	BLM3098-1R	10
GSXR 600	2011-2014	BLM3099-2F	BLMR3099-2F	BLM3099-1R	11
GSXR 600 K1-K3	2001-2003	BLM3100-2F	BLMR3100-2F	BLM3100-1R	12
GSXR 600 V-W	1997-1998	BLM3101-2F	BLMR3101-2F	BLM3101-1R	13
GSXR 600 X-Y	1999-2000	BLM3102-2F	BLMR3101-2F	BLM3102-1R	14
RF 600 RP-RV	1993-1997	BLM3130-3F	BLMR3130-2F	BLM3130-1R	15
VS 600 GLS-GLT Intruder	1995-1997	BLM3155-1F			16
DL 650 ABS	2013	BLM3003-5FR			17
DR 650 RSEM-SET	1991-1997	BLM3008-1F		BLM3008-1R	18
GX 650 GTX-GTD	1981-1985	BLM3031-3F		BLM3031-1R	19
GS 650 GX Katana	1981	BLM3032-3F		BLM3032-1R	20
GSF 650 Bandit	2008	BLM3045-2F			21
GSF 650 Bandit	2005-2007	BLM3046-2F	BLMR3046-2F	BLM3046-1R	22
GSF 650 A Bandit ABS	2005-2013	BLM3047-7FR			23
GSF 650 S Bandit K5 - K8	2005-2013	BLM3048-2F	BLMR3048-2F	BLM3048-1R	24
GSX 650 F	2007-2013	BLM3073-2F	BLMR3073-2F	BLM3073-1R	25
LS 650 FG/PJ-PT Savage	1987-1998	BLM3129-1F			26
SV 650 Unfaired	2003-2013	BLM3143-3F	BLMR3143-2F	BLM3143-1R	27
SV 650 S Faired	2003-2013	BLM3144-3F	BLMR3144-2F	BLM3143-1R	28
SV 650 SX-SK2	1999-2002	BLM3145-3F	BLMR3145-2F	BLM3145-1R	29
SV 650 X-K1	1999-2002	BLM3146-3F	BLMR3146-2F	BLM3145-1R	30
SVF 650 Gladius	2009-2013	BLM3147-2F	BLMR3147-2F	BLM3147-1R	31
V-Strom 650	2004-2012	BLM3153-3F		BLM3153-1R	32
DR 750 SJ-SL	1988-1990	BLM3009-1F		BLM3009-1R	33
GS 750 DB	1977	BLM3033-3F		BLM3033-1R	34
GS 750 EN	1979	BLM3034-3F		BLM3034-1R	35
GSR 750 model only	2011-2013	BLM3051-2F		BLM3051-1R	36
GSX 750 EE/EF/ES	1984-1989	BLM3074-5F		BLM3074-1R	37
GSX 750 ESD	1983	BLM3075-5F		BLM3075-1R	38
GSX 750 ET-EX	1980-1981	BLM3076-3F		BLM3076-1R	39
GSX 750 FK-FV	1989-1997	BLM3077-3F	BLMR3077-2F	BLM3077-1R	40
GSX 750 FW-K3	1998-2003	BLM3078-3F	BLMR3078-2F	BLM3078-1R	41
GSX 750 R	1985	BLM3079-3F		BLM3079-1R	42
GSX 750 SE Katana	1983-1986	BLM3080-3F		BLM3080-1R	43
GSX 750 W-K1	1997-2002	BLM3081-3F	BLMR3081-2F	BLM3081-1R	44
GSXR 750	2011-2014	BLM3099-2F	BLMR3099-2F	BLM3099-1R	45
GSXR 750	2006-2010	BLM3098-2F	BLMR3098-2F	BLM3098-1R	46
GSXR 750 F-H	1985-1987	BLM3105-3F	BLMR3105-2F	BLM3105-1R	47
GSXR 750 J	1988	BLM3106-3F	BLMR3106-2F	BLM3106-1R	48
GSXR 750 K	1989	BLM3091-3F	BLMR3091-2F	BLM3091-1R	49
GSXR 750 K4/K5	2004-2005	BLM3097-2F	BLMR3097-2F	BLM3097-1R	50
GSXR 750 L	1990	BLM3109-3F	BLMR3109-2F	BLM3109-1R	51
GSXR 750 M	1991	BLM3110-3F	BLMR3110-2F	BLM3110-1R	52
GSXR 750 T-W	1996-1998	BLM3101-2F	BLMR3101-2F	BLM3101-1R	53
GSXR 750 WN-WP	1992-1993	BLM3112-3F	BLMR3112-2F	BLM3112-1R	54
GSXR 750 WR-WS	1994	BLM3113-2F	BLMR3113-2F	BLM3113-1R	55
GSXR 750 X	1999	BLM3102-2F	BLMR3101-2F	BLM3102-1R	56

FRONT

REAR

BRAKE LINES



Line #

SUZUKI

Line #	Model	Year Range
1	GSXR 750 Y-K3	2000-2003
2	VS 750 GLPG-GLPM Intruder	1985-1991
3	DR 800 SL-SM	1990-1991
4	VS 800 GLM-GLV Intruder	1991-1997
5	VX 800 L-R	1990-1994
6	VZ 800 V-W Marauder	1997-1998
7	GS 850 GN-GT	1979-1980
8	GS 850 GX-GG	1981-1988
9	XN 85 D Turbo	1983
10	RF 900 RR-RW	1994-1998
11	DL 1000 V-Strom ABS	2014
12	DL 1000 K2 V-Strom	2002-2006
13	DL1000 V Strom	2017-2018
14	DL1000 V Strom XT	2017-2018
15	GS 1000 ET/GT	1980-1984
16	GS 1000 S	1979
17	GSX 1000 SZ-SD Katana	1981-1984
18	GSXR 1000	2012-2014
19	GSXR 1000 ABS	2015
20	GSXR 1000 K5/K6	2005-2006
21	GSXR 1000 K7 - K8	2007-2008
22	GSXR 1000 K9 - K11	2009-2011
23	GSXR 1000 ABS	2017-2018
24	GSXR 1000 K1-K2	2001-2002
25	GSXR 1000 K3-K4	2003-2004
26	SV 1000 N	2003-2006
27	SV 1000 SK3-K7	2003-2007
28	TL 1000 RW-RK1	1998-2002
29	TL 1000 SV-SX	1997-2001
30	GS 1100 G	1982-1984
31	GSX 1100 EE/EF/EG	1984-1988
32	GSX 1100 ESD	1983
33	GSX 1100 ET-EX	1980-1981
34	GSX 1100 EZ/SZ Katana	1982
35	GSX 1100 FJ-FR	1988-1994
36	GSX 1100 GM-GN	1991-1994
37	GSX 1100 SD Katana	1983
38	GSXR 1100 G-H	1986-1987
39	GSXR 1100 J	1988
40	GSXR 1100 K	1989
41	GSXR 1100 L	1990
42	GSXR 1100 M	1991
43	GSXR 1100 N	1992
44	GSXR 1100 WP-WT	1993-1996
45	GSF 1200 K1-K5 Bandit	2001-2006
46	GSF 1200 T-Y Bandit	1996-2000
47	GSF 1250 Bandit	2006-2013
48	GSF 1250 A Bandit ABS	2007-2013
49	B-King	2007-2010
50	GSX 1300 R Hayabusa	1999-2006
51	GSX 1300 R Hayabusa	2007-2013
52	GSX1300R Hayabusa ABS	2013-2018
53	GSX1300R Hayabusa ABS	2013-2018
54	GSX1300R Hayabusa ABS	2013-2018
55	GSX 1400	2001-2009
56	VS 1400 GLPH-GLPV Intruder	1987-1999

FRONT

OE Replacement
Brake Lines (Front)

Race Standard
Brake Lines (Front)

OE Replacement
Brake Lines (Rear)

OE Replacement Brake Lines (Front)	Race Standard Brake Lines (Front)	OE Replacement Brake Lines (Rear)
BLM3115-2F	BLMR3115-2F	BLM3115-1R
BLM3155-1F		
BLM3010-1F		BLM3010-1R
BLM3155-1F		
BLM3158-1F		BLM3158-1R
BLM3159-1F		
BLM3035-3F		BLM3035-1R
BLM3036-3F		BLM3036-1R
BLM3161-5F		BLM3161-1R
BLM3131-3F	BLMR3131-2F	BLM3131-1R
BLM3001-3F		BLM3001-2R
BLM3002-3F	BLMR3002-2F	BLM3002-1R
BLM3172-3F		BLM3172-2R
BLM3173-3F		BLM3173-2R
BLM3017-3F		BLM3017-1R
BLM3018-3F		BLM3018-1R
BLM3052-5F		BLM3052-1R
BLM3082-2F	BLMR3082-2F	BLM3082-1R
BLM3083-3F		BLM3082-1R
BLM3084-2F	BLMR3084-2F	BLM3084-1R
BLM3085-2F	BLMR3085-2F	BLM3085-1R
BLM3086-2F	BLMR3086-2F	BLM3086-1R
BLM3167-3F		BLM3167-2R
BLM3087-2F	BLMR3087-2F	BLM3087-1R
BLM3088-2F	BLMR3088-2F	BLM3088-1R
BLM3141-2F	BLMR3141-2F	BLM3141-1R
BLM3142-2F	BLMR3142-2F	BLM3142-1R
BLM3148-2F	BLMR3148-2F	BLM3148-1R
BLM3149-2F	BLMR3149-2F	BLM3149-1R
BLM3019-3F		BLM3019-1R
BLM3053-3F		BLM3053-1R
BLM3054-5F		BLM3054-1R
BLM3055-3F		BLM3055-1R
BLM3056-5F		BLM3056-1R
BLM3057-3F		BLM3057-1R
BLM3058-3F		BLM3058-1R
BLM3059-5F		BLM3059-1R
BLM3089-3F	BLMR3089-2F	BLM3089-1R
BLM3090-3F	BLMR3090-2F	BLM3090-1R
BLM3091-3F	BLMR3091-2F	BLM3091-1R
BLM3092-3F	BLMR3092-2F	BLM3092-1R
BLM3093-3F	BLMR3093-2F	BLM3093-1R
BLM3094-3F	BLMR3094-2F	BLM3094-1R
BLM3095-2F	BLMR3095-2F	BLM3095-1R
BLM3037-3F	BLMR3037-2F	BLM3037-1R
BLM3038-3F	BLMR3038-2F	BLM3038-1R
BLM3039-2F	BLMR3039-2F	BLM3039-1R
BLM3040-8F		
BLM3000-2F		BLM3000-1R
BLM3060-2F	BLMR3060-2F	BLM3060-1R
BLM3061-2F	BLMR3061-2F	BLM3061-1R
BLM3169-3F		BLM3169-2R
BLM3169A-3F		BLM3169A-2R
BLM3170-3F		BLM3170-2R
BLM3062-3F	BLMR3062-2F	BLM3062-1R
BLM3154-1F		BLM3154-1R

REAR

BRAKE
APPLICATIONS

BRAKE LINES

APPLIICATIONS
BRAKE



SUZUKI



VZR 1800 2006

SUZUKI OFF ROAD

DRZ 125/DRZ 125L 2003
 DRZ 250 2004-2007
 RM-Z 250 2004-2009
 RM-Z 250 2011
 RM 250 2006-2008
 DR-Z 400 E 2000-2007
 DRZ 400 2005-2007
 RM-Z 450 2005-2007
 RM-Z 450 2008-2009
 RM-Z 450 2011

TRIUMPH

Bonneville/T100 2001-2012
 Bonneville America 2003-2006
 Bonneville Thrupton 900 2003-2013
 Daytona 600 2003-2004
 Daytona 675 2006-2013
 Daytona 750/1000 1991-1993
 Daytona 900/1200 1992-1997
 Daytona 955i 2001-2003
 Daytona 955i 1999-2000
 Daytona T595 1997-2000
 Legend 1998-2001
 Rocket III 2004-2015
 Rocket III Classic 2004-2015
 Scrambler 865 2006-2013
 Speed Four 2003-2006
 Speed III 1994-1996
 Speed III T509 1997-2003
 Speed Triple 1050 2004-2010
 Speedmaster 2003-2011
 Sprint 1993-1997
 Sprint RS 1999-2005
 Sprint ST 1050 2005-2012
 Sprint ST/Executive 1998-2003
 Sprint ST/Executive Late 03 On 2003
 Street Triple 675 2006-2015
 Street Triple 675R 2009-2015
 Street Twin -2017
 Thunderbird 1995-2002
 Thunderbird 900 Sport 1998-2003
 Thunderbird/Adventurer 1995-2003
 Tiger 1993-1999
 Tiger 1050 2013
 Tiger 800 XC 2011-2014
 Tiger 955 2000-2003
 Trident 750/900 -1991
 Trident 750/900 1991-1998
 Trophy 900/1200 2003
 Trophy 900/1200 -2003
 TT 600 2000-2003

OE Replacement
Brake Lines (Front)

Race Standard
Brake Lines (Front)

OE Replacement
Brake Lines (Rear)

FRONT

REAR

BLM3160-3F

BLMR3160-2F

BLM3160-1R

BLM6077-1F

BLM6078-1F

BLM6080-1F

BLM6081-1F

BLM6029-1F

BLM6013-1F

BLM6079-1F

BLM6080-1F

BLM6083-1F

BLM6084-1F

BLM8195-1F

BLM8196-1F

BLM8197-1F

BLM8198-2F

BLM8199-2F

BLM8200-3F

BLM8201-3F

BLM8202-2F

BLM8202-2F

BLM8202-2F

BLM8202-2F

BLM8205-1F

BLM8206-3F

BLM8207-3F

BLM8208-1F

BLM8209-2F

BLM8210-3F

BLM8211-2F

BLM8212-3F

BLM8213-2F

BLM8214-3F

BLM8215-2F

BLM8216-2F

BLM8217-2F

BLM8218-2F

BLM8219-2F

BLM8220-2F

BLM8240-3F

BLM8221-1F

BLM8222-3F

BLM8223-1F

BLM8224-3F

BLM8225-3F

BLM8227-2F

BLM8228-3F

BLM8229-3F

BLM8230-2F

BLM8231-3F

BLM8232-2F

BLMR8198-2F

BLMR8199-2F

BLMR8200-2F

BLMR8201-2F

BLMR8202-2F

BLMR8202-2F

BLMR8202-2F

BLMR8202-2F

BLMR8210-2F

BLMR8211-2F

BLMR8212-2F

BLMR8213-2F

BLMR8214-2F

BLMR8217-2F

BLMR8219-2F

BLMR8220-2F

BLMR8224-2F

BLMR8226-2F

BLMR8228-2F

BLMR8229-2F

BLMR8231-2F

BLMR8232-2F

Line #

1
2
3
4
5
6
7
8
9
10
11
12
13
14
15
16
17
18
19
20
21
22
23
24
25
26
27
28
29
30
31
32
33
34
35
36
37
38
39
40
41
42
43
44
45
46
47
48
49
50
51
52
53
54
55
56

BRAKE LINES



YAMAHA



Line #

Line #	Model	Year
1	DT 125 X	2006
2	TDR 125	1993-1997
3	TZR 125	1987-1997
4	YZFR 125	2008-2013
5	YZF-R125	2014-2016
6	YZF-R125 ABS	2015-2017
7	MT125 ABS	2015-2017
8	FZ1 Fazer	2006-2013
9	TDR 250	1988-1992
10	TDM 250	1988-1990
11	RD 250 LC	1980-1985
12	TZ 250	-1991
13	XS 250 SE	1980-1985
14	YZF300R	2017
15	YZF 300 R ABS	2017
16	RD 350 LC	1980-1983
17	XT 350	1985-1996
18	FZR 400 Exup Import	1985-1989
19	FZR 400 Genesis Import	1985-1987
20	FZR 400 RR	1992-1996
21	FZR 400 RRSP	1991-1992
22	XS 400 SE Single Disc	1980-1983
23	XS 400 SE Single Disc	1978
24	SR 500 Single Disc	1978-1983
25	XS 500 C	1976
26	XV 535	1988-2003
27	XV 535	1988-2002
28	XJ 550	1981-1985
29	XZ 550	1982-1985
30	FZ6	2004-2006
31	FZ6 S2	2007-2008
32	FZ 600	1987-1988
33	FZR 600	1989-1990
34	FZR 600 Genesis	1991-1993
35	FZR 600 R	1994-1996
36	FZS 600 Fazer	1998-2003
37	R6	2008-2015
38	R6	2006-2007
39	R6	2005
40	R6	2003-2004
41	R6	1998-2002
42	XJ 600	1984-1992
43	XJ 600 N	1994-1997
44	XJ 600 N/S Diversion	1998-2003
45	XJ 600 S Diversion	1992-1997
46	XJ6/XJ6 Diversion/XJ6 SP	2009-2013
47	XT 600 Tenere	1986-1990
48	XT 600 E	1993-2003
49	YF 600 R Thundercat	1996-2003
50	XJ 650	1980-1984
51	XJ 650 Turbo	1982-1985
52	XS 650	1977
53	XS 650	1981-1982
54	XS 650	1975
55	XS 650	1972
56	XS 650 C	1975

FRONT

OE Replacement
Brake Lines (Front)

Race Standard
Brake Lines (Front)

OE Replacement
Brake Lines (Rear)

OE Replacement Brake Lines (Front)	Race Standard Brake Lines (Front)	OE Replacement Brake Lines (Rear)
BLM2002-1F		BLM2002-1R
BLM2072-1F		BLM2072-1R
BLM2079-1F		BLM2079-1R
BLM2146-1F		BLM2146-1R
BLM2163-1F		BLM2163-1R
BLM2159-2F		BLM2159-2R
BLM2164-2F		BLM2159-2R
BLM2010-3F	BLMR2010-2F	BLM2010-1R
BLM2073-1F		BLM2073-1R
BLM2068-1F		
BLM2057-1F		
	BLMR2078-2F	BLM2078-1R
BLM2101-1F		
BLM2156-1F		BLM2156-1R
BLM2155-3F		BLM2155-1R
BLM2058-3F	BLMR2058-2F	
BLM2116-1F		BLM2116-1R
BLM2022-3F	BLMR2022-2F	BLM2022-1R
BLM2023-3F	BLMR2023-2F	
BLM2024-3F	BLMR2024-2F	BLM2024-1R
BLM2025-3F	BLMR2025-2F	BLM2025-1R
BLM2102-2F		
BLM2103-1F		
BLM2065-2F		
BLM2104-1F		BLM2104-1R
BLM2131-1F		
BLM2132-1F		
BLM2082-3F		
BLM2141-3F		
BLM2011-3F	BLMR2011-2F	BLM2011-1R
BLM2012-2F	BLMR2012-2F	BLM2011-1R
BLM2013-3F	BLMR2013-2F	BLM2013-1R
BLM2026-3F	BLMR2026-2F	BLM2026-1R
BLM2027-3F	BLMR2027-2F	BLM2027-1R
BLM2028-2F		BLM2028-1R
BLM2032-3F	BLMR2032-2F	BLM2032-1R
	BLMR2049-2F	BLM2049-1R
	BLMR2048-2F	BLM2048-1R
BLM2047-3F	BLMR2047-2F	BLM2047-1R
BLM2046-2F		BLM2046-1R
BLM2045-2F		BLM2045-1R
BLM2084-3F		BLM2084-1R
BLM2085-1F		BLM2085-1R
BLM2086-2F		BLM2086-1R
BLM2087-1F		BLM2085-1R
BLM2083-2F	BLMR2083-2F	BLM2083-1R
BLM2118-1F		BLM2118-1R
BLM2119-1F		BLM2119-1R
BLM2144-2F		BLM2144-1R
BLM2088-3F		
BLM2089-3F		
BLM2105-2F		
BLM2106-3F		
BLM2107-3F		
BLM2108-1F		
BLM2109-3F		

REAR

BRAKE
APPLICATIONS

BRAKE LINES

APPLIICATIONS
BRAKE



YAMAHA



		OE Replacement Brake Lines (Front)	Race Standard Brake Lines (Front)	OE Replacement Brake Lines (Rear)	Line #
XS 650 E	1979-1980	BLM2110-3F			1
XVS 650 Drag Star	1997-2003	BLM2137-1F			2
XVS 650 A Drag Star Classic	1998-2003	BLM2138-1F			3
SZR 660	1996-1997	BLM2067-1F		BLM2067-1R	4
XT 660 R	2004-2013	BLM2120-1F		BLM2120-1R	5
XT 660 X	2004-2013	BLM2121-1F		BLM2121-1R	6
XT 660 Z	2009-2013	BLM2122-3F		BLM2122-1R	7
XTZ 660	1991-1999	BLM2119-1F		BLM2119-1R	8
FZ-07 ABS	2016-2017	BLM2157-3F			9
MT-07	2014-2017	BLM2153-3F		BLM2153-4R	10
MT-07 Tracer	2016-2017	BLM2160-3F		BLM2160-4R	11
XSR 700	2016-2017	BLM2154-3F		BLM2154-4R	12
FZ 750	1985-1986	BLM2014-3F	BLMR2014-2F	BLM2014-1R	13
FZ 750	1987-1988	BLM2015-3F	BLMR2015-2F	BLM2015-1R	14
FZR 750	1989-1992	BLM2029-3F	BLMR2029-2F	BLM2029-1R	15
FZR 750 R OW01	1989-1992	BLM2030-2F		BLM2030-1R	16
FZS 750	1987-1989	BLM2033-3F	BLMR2033-2F	BLM2033-1R	17
XJ 750 Antidive	1982-1984	BLM2090-5F			18
XS 750	1978-1979	BLM2111-3F		BLM2111-1R	19
XS 750 E	1977-1978	BLM2112-3F		BLM2112-1R	20
XS 750 SE	1980-1982	BLM2113-3F		BLM2113-1R	21
XTZ 750 Super Tenere	1989-1996	BLM2124-3F	BLMR2124-2F	BLM2124-1R	22
XV 750	1992-1997	BLM2133-3F			23
XV 750 SE	1981-1983	BLM2134-1F			24
YZF 750	1993-1997	BLM2145-2F		BLM2145-1R	25
FZ8-	2010-2013		BLMR2016-2F	BLM2016-1R	26
TDM 850	1991-1996	BLM2069-3F	BLMR2069-2F	BLM2069-1R	27
TDM 850	1997-2002	BLM2070-3F	BLMR2070-2F	BLM2069-1R	28
TRX 850	1996-2000	BLM2074-2F		BLM2074-1R	29
XS 850	1980-1985	BLM2114-3F		BLM2114-1R	30
MT-09	2013-2016	BLM2037-2F		BLM2037-1R	31
TDM 900	2002-2013	BLM2071-3F	BLMR2071-2F	BLM2071-1R	32
XJ 900	1983-1985	BLM2091-3F		BLM2091-1R	33
XJ 900 F	1985-1994	BLM2092-3F		BLM2092-1R	34
XJ 900 S Diversion	1994-1996	BLM2093-2F		BLM2093-1R	35
XJ 900 S Diversion	1997-2003	BLM2094-3F	BLMR2094-2F	BLM2094-1R	36
FZR 1000 Ex-Up	1995-1996	BLM2017-2F		BLM2017-1R	37
FZR 1000 Ex-Up	1989-1990	BLM2018-2F		BLM2018-1R	38
FZR 1000 Ex-Up	1991	BLM2019-3F	BLMR2019-2F	BLM2019-1R	39
FZR 1000 Genesis	1987-1988	BLM2020-3F	BLMR2020-2F	BLM2020-1R	40
FZR 1000 RU	1992-1994	BLM2021-3F	BLMR2021-2F	BLM2021-1R	41
FZS 1000 Fazer	2001-2005	BLM2031-3F	BLMR2031-2F	BLM2031-1R	42
GTS 1000 A	1993-1996	BLM2034-7FR			43
XV 1000 TR1	1981-1985	BLM2125-3F			44
XV 1000 Virago	1986-1989	BLM2126-3F			45
XV 1000 Virago	1989-1999	BLM2127-3F	BLMR2127-2F		46
YZF 1000 R Thunderace	1996-2002	BLM2143-2F		BLM2143-1R	47
R1	1998-2001	BLM2039-2F		BLM2039-1R	48
R1	2002-2003		BLMR2040-2F	BLM2040-1R	49
R1	2004-2005		BLMR2041-2F	BLM2041-1R	50
R1	2006		BLMR2041-2F	BLM2042-1R	51
R1	2007-2008		BLMR2043-2F	BLM2043-1R	52
R1	2009-2014		BLMR2044-2F	BLM2044-1R	53
BT 1100 Bulldog	2001-2003	BLM2000-3F		BLM2000-1R	54
FJ 1100	1985-1986	BLM2003-5F		BLM2003-1R	55
XS 1100	1978-1980	BLM2099-3F		BLM2099-1R	56

FRONT

REAR

BRAKE LINES



Line #

YAMAHA

1	XS 1100 S	1978-1984
2	XVS 1100/A Dragstar	1998-2006
3	XVS 1100/A Dragstar Classic	1998-2006
4	FJ 1200	1986-1987
5	FJ 1200	1988-1996
6	FJ 1200 ABS	1991-1996
7	XJR 1200	1995-1998
8	V-MAX	1991-2004
9	FJR 1300	2000-2002
10	FJR 1300	2003-2004
11	XJR 1300	1999-2001
12	XJR 1300	2002-2003
13	XJR 1300	2004-2013
14	XVZ 1300 A/AT Royal Star/Tour Classic	1996-1999
15	XVZ 1300 TF Venture Star	2000-2002
16	XV 1600 Wild Star	1998-2003
17	XV 1900 Midnight Star	2005-2009

YAMAHA OFF ROAD

20	YZ 80	1993-2003
21	YZ 80	1993-2003
22	YZ 85	2001-2004
23	YZ 85	2001-2011
24	WR 125 X	2012
25	YZ 125/250	1999-2001
26	YZ 125/250	2006-2007
27	YZ 125/250	2008-2011
28	YZ 125/250/250 F	2003-2005
29	WR 250 F	2007-2011
30	WR 250 R	2008-2009
31	WR 250 X	2008-2009
32	YZ 250 F	2001-2002
33	YZ 250 F	2006-2008
34	YZ 250 F/YZ 450 F	2010-2011
35	WR 450 F	2004-2006
36	WR 450 F	2007-2011
37	YZ 450 F	2003-2005
38	YZ 450 F	2007
39	YZ 450 F	2008-2009

FRONT

OE Replacement
Brake Lines (Front)

Race Standard
Brake Lines (Front)

OE Replacement
Brake Lines (Rear)

BLM2100-3F

BLMR2005-2F

BLM2099-1R

BLM2135-3F

BLM2135-1R

BLM2136-3F

BLM2135-1R

BLM2004-5F

BLM2004-1R

BLM2005-3F

BLM2005-1R

BLM2006-6F

BLM2006-2R

BLM2095-2F

BLM2095-1R

BLM2081-3F

BLM2081-1R

BLM2007-3F

BLM2007-1R

BLM2008-3F

BLM2007-1R

BLM2096-3F

BLM2096-1R

BLMR2096-2F

BLM2097-1R

BLMR2097-2F

BLM2098-1R

BLMR2098-2F

BLM2139-1R

BLM2139-3F

BLMR2139-2F

BLM2129-1R

BLM2129-3F

BLM2129-1R

BLM2129-3F

BLM2129-1R

BLM2130-3F

BLMR2130-2F

BLM2130-1R

REAR

BLM6101-1F

BLM6101-1R

BLM6102-1F

BLM6093-1R

BLM6101-1F

BLM6101-1R

BLM6102-1F

BLM6093-1R

BLM6085-1F

BLM6085-1R

BLM6093-1F

BLM6093-1R

BLM6091-1F

BLM6091-1R

BLM6092-1F

BLM6092-1R

BLM6094-1F

BLM6094-1R

BLM6086-1F

BLM6086-1R

BLM6087-1F

BLM6087-1R

BLM6088-1F

BLM6088-1R

BLM6093-1F

BLM6093-1R

BLM6091-1F

BLM6091-1R

BLM6097-1F

BLM6087-1R

BLM6089-1F

BLM6089-1R

BLM6090-1F

BLM6090-1R

BLM6099-1F

BLM6099-1R

BLM6098-1F

BLM6098-1R

BLM6100-1F

BLM6100-1R

BRAKE
APPLICATIONS

EBC BRAKE PAD BUYERS GUIDE





NOTE:- Size identification is shown as follows

Dimension 1=Width or Diameter, Dimension 2=Height or Diameter, Dimension 3=Thickness (Material and backplate)

Brief Fitment (see application pages)

BUYERS GUIDE
BRAKE PADS

NOTE:- Size identification is shown as follows
Dimension 1=Width or Diameter, Dimension 2=Height or Diameter, Dimension 3=Thickness (Material and backplate)

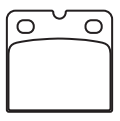
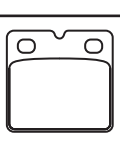
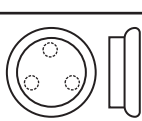
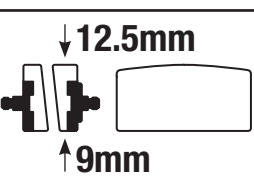
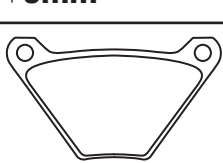
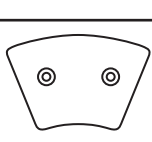
FA11 48 x 9mm		<table border="1"> <thead> <tr> <th colspan="12">MATERIAL AVAILABILITY</th> </tr> <tr> <th>FA</th><th>X</th><th>V</th><th>R</th><th>MXS</th><th>HH</th><th>EPFA</th><th>GPFAX</th><th>SFA</th><th>SFAHH</th><th>SV</th><th>SXR</th> </tr> </thead> <tbody> <tr> <td>✓</td><td></td><td></td><td></td><td></td><td></td><td></td><td></td><td></td><td></td><td></td><td></td> </tr> </tbody> </table> <p>ISR AFTERMARKET CALIPER, YAMAHA</p>	MATERIAL AVAILABILITY												FA	X	V	R	MXS	HH	EPFA	GPFAX	SFA	SFAHH	SV	SXR	✓											
MATERIAL AVAILABILITY																																						
FA	X	V	R	MXS	HH	EPFA	GPFAX	SFA	SFAHH	SV	SXR																											
✓																																						
FA12 50 x 13/20mm		<table border="1"> <thead> <tr> <th colspan="12">MATERIAL AVAILABILITY</th> </tr> <tr> <th>FA</th><th>X</th><th>V</th><th>R</th><th>MXS</th><th>HH</th><th>EPFA</th><th>GPFAX</th><th>SFA</th><th>SFAHH</th><th>SV</th><th>SXR</th> </tr> </thead> <tbody> <tr> <td>✓</td><td></td><td>✓</td><td></td><td></td><td></td><td></td><td></td><td></td><td></td><td></td><td></td> </tr> </tbody> </table> <p>HONDA</p>	MATERIAL AVAILABILITY												FA	X	V	R	MXS	HH	EPFA	GPFAX	SFA	SFAHH	SV	SXR	✓		✓									
MATERIAL AVAILABILITY																																						
FA	X	V	R	MXS	HH	EPFA	GPFAX	SFA	SFAHH	SV	SXR																											
✓		✓																																				
FA13 52 x 13.5/19.5mm		<table border="1"> <thead> <tr> <th colspan="12">MATERIAL AVAILABILITY</th> </tr> <tr> <th>FA</th><th>X</th><th>V</th><th>R</th><th>MXS</th><th>HH</th><th>EPFA</th><th>GPFAX</th><th>SFA</th><th>SFAHH</th><th>SV</th><th>SXR</th> </tr> </thead> <tbody> <tr> <td>✓</td><td></td><td>✓</td><td></td><td></td><td></td><td></td><td></td><td></td><td></td><td></td><td></td> </tr> </tbody> </table> <p>HONDA</p>	MATERIAL AVAILABILITY												FA	X	V	R	MXS	HH	EPFA	GPFAX	SFA	SFAHH	SV	SXR	✓		✓									
MATERIAL AVAILABILITY																																						
FA	X	V	R	MXS	HH	EPFA	GPFAX	SFA	SFAHH	SV	SXR																											
✓		✓																																				
FA16 59.5 x 52 x 10mm		<table border="1"> <thead> <tr> <th colspan="12">MATERIAL AVAILABILITY</th> </tr> <tr> <th>FA</th><th>X</th><th>V</th><th>R</th><th>MXS</th><th>HH</th><th>EPFA</th><th>GPFAX</th><th>SFA</th><th>SFAHH</th><th>SV</th><th>SXR</th> </tr> </thead> <tbody> <tr> <td>✓</td><td></td><td></td><td></td><td></td><td>✓</td><td>✓</td><td>✓</td><td></td><td></td><td></td><td></td> </tr> </tbody> </table> <p>AP/LOCKHEED AFTERMARKET CALIPER, ISR AFTERMARKET CALIPER, TRIUMPH Meriden Produced Models</p>	MATERIAL AVAILABILITY												FA	X	V	R	MXS	HH	EPFA	GPFAX	SFA	SFAHH	SV	SXR	✓					✓	✓	✓				
MATERIAL AVAILABILITY																																						
FA	X	V	R	MXS	HH	EPFA	GPFAX	SFA	SFAHH	SV	SXR																											
✓					✓	✓	✓																															
FA18 56 x 53.5 x 9mm		<table border="1"> <thead> <tr> <th colspan="12">MATERIAL AVAILABILITY</th> </tr> <tr> <th>FA</th><th>X</th><th>V</th><th>R</th><th>MXS</th><th>HH</th><th>EPFA</th><th>GPFAX</th><th>SFA</th><th>SFAHH</th><th>SV</th><th>SXR</th> </tr> </thead> <tbody> <tr> <td>✓</td><td></td><td>✓</td><td></td><td></td><td>✓</td><td></td><td></td><td></td><td></td><td></td><td></td> </tr> </tbody> </table> <p>AMERICAN SUSPENSION CALIPERS, BMW, DUCATI, LAVERDA, MOTO GUZZI, MUZ, TRIUMPH Meriden Produced Models</p>	MATERIAL AVAILABILITY												FA	X	V	R	MXS	HH	EPFA	GPFAX	SFA	SFAHH	SV	SXR	✓		✓			✓						
MATERIAL AVAILABILITY																																						
FA	X	V	R	MXS	HH	EPFA	GPFAX	SFA	SFAHH	SV	SXR																											
✓		✓			✓																																	
FA19 56 x 53.5 x 7mm		<table border="1"> <thead> <tr> <th colspan="12">MATERIAL AVAILABILITY</th> </tr> <tr> <th>FA</th><th>X</th><th>V</th><th>R</th><th>MXS</th><th>HH</th><th>EPFA</th><th>GPFAX</th><th>SFA</th><th>SFAHH</th><th>SV</th><th>SXR</th> </tr> </thead> <tbody> <tr> <td>✓</td><td></td><td></td><td></td><td></td><td></td><td></td><td></td><td></td><td></td><td></td><td></td> </tr> </tbody> </table> <p>DUCATI</p>	MATERIAL AVAILABILITY												FA	X	V	R	MXS	HH	EPFA	GPFAX	SFA	SFAHH	SV	SXR	✓											
MATERIAL AVAILABILITY																																						
FA	X	V	R	MXS	HH	EPFA	GPFAX	SFA	SFAHH	SV	SXR																											
✓																																						
FA21 47 x 16.2 x 7mm		<table border="1"> <thead> <tr> <th colspan="12">MATERIAL AVAILABILITY</th> </tr> <tr> <th>FA</th><th>X</th><th>V</th><th>R</th><th>MXS</th><th>HH</th><th>EPFA</th><th>GPFAX</th><th>SFA</th><th>SFAHH</th><th>SV</th><th>SXR</th> </tr> </thead> <tbody> <tr> <td></td><td>✓</td><td></td><td>✓</td><td></td><td></td><td></td><td></td><td></td><td></td><td>✓</td><td></td> </tr> </tbody> </table> <p>YAMAHA</p>	MATERIAL AVAILABILITY												FA	X	V	R	MXS	HH	EPFA	GPFAX	SFA	SFAHH	SV	SXR		✓		✓							✓	
MATERIAL AVAILABILITY																																						
FA	X	V	R	MXS	HH	EPFA	GPFAX	SFA	SFAHH	SV	SXR																											
	✓		✓							✓																												
FA22 70 x 35mm		<table border="1"> <thead> <tr> <th colspan="12">MATERIAL AVAILABILITY</th> </tr> <tr> <th>FA</th><th>X</th><th>V</th><th>R</th><th>MXS</th><th>HH</th><th>EPFA</th><th>GPFAX</th><th>SFA</th><th>SFAHH</th><th>SV</th><th>SXR</th> </tr> </thead> <tbody> <tr> <td>✓</td><td></td><td>✓</td><td></td><td></td><td></td><td></td><td></td><td></td><td></td><td></td><td></td> </tr> </tbody> </table> <p>BMW</p>	MATERIAL AVAILABILITY												FA	X	V	R	MXS	HH	EPFA	GPFAX	SFA	SFAHH	SV	SXR	✓		✓									
MATERIAL AVAILABILITY																																						
FA	X	V	R	MXS	HH	EPFA	GPFAX	SFA	SFAHH	SV	SXR																											
✓		✓																																				
FA24/2 113.5 x 64.5 x 7mm		<table border="1"> <thead> <tr> <th colspan="12">MATERIAL AVAILABILITY</th> </tr> <tr> <th>FA</th><th>X</th><th>V</th><th>R</th><th>MXS</th><th>HH</th><th>EPFA</th><th>GPFAX</th><th>SFA</th><th>SFAHH</th><th>SV</th><th>SXR</th> </tr> </thead> <tbody> <tr> <td>✓</td><td></td><td>✓</td><td></td><td></td><td></td><td></td><td></td><td></td><td></td><td></td><td></td> </tr> </tbody> </table> <p>HARLEY DAVIDSON</p>	MATERIAL AVAILABILITY												FA	X	V	R	MXS	HH	EPFA	GPFAX	SFA	SFAHH	SV	SXR	✓		✓									
MATERIAL AVAILABILITY																																						
FA	X	V	R	MXS	HH	EPFA	GPFAX	SFA	SFAHH	SV	SXR																											
✓		✓																																				
FA26 75.5 x 50 x 7mm		<table border="1"> <thead> <tr> <th colspan="12">MATERIAL AVAILABILITY</th> </tr> <tr> <th>FA</th><th>X</th><th>V</th><th>R</th><th>MXS</th><th>HH</th><th>EPFA</th><th>GPFAX</th><th>SFA</th><th>SFAHH</th><th>SV</th><th>SXR</th> </tr> </thead> <tbody> <tr> <td>✓</td><td></td><td></td><td></td><td></td><td></td><td></td><td></td><td></td><td></td><td></td><td></td> </tr> </tbody> </table> <p>HARLEY DAVIDSON</p>	MATERIAL AVAILABILITY												FA	X	V	R	MXS	HH	EPFA	GPFAX	SFA	SFAHH	SV	SXR	✓											
MATERIAL AVAILABILITY																																						
FA	X	V	R	MXS	HH	EPFA	GPFAX	SFA	SFAHH	SV	SXR																											
✓																																						

FA27 44 x 55 x 9.5mm		<table border="1"> <thead> <tr> <th colspan="12">MATERIAL AVAILABILITY</th> </tr> <tr> <th>FA</th><th>X</th><th>V</th><th>R</th><th>MXS</th><th>HH</th><th>EPFA</th><th>GPFAX</th><th>SFA</th><th>SFAHH</th><th>SV</th><th>SXR</th> </tr> </thead> <tbody> <tr> <td>✓</td><td></td><td></td><td></td><td></td><td></td><td></td><td></td><td></td><td></td><td></td><td></td> </tr> </tbody> </table>	MATERIAL AVAILABILITY												FA	X	V	R	MXS	HH	EPFA	GPFAX	SFA	SFAHH	SV	SXR	✓											
MATERIAL AVAILABILITY																																						
FA	X	V	R	MXS	HH	EPFA	GPFAX	SFA	SFAHH	SV	SXR																											
✓																																						
		NORTON																																				
FA29 66.5 x 48.5 x 11mm		<table border="1"> <thead> <tr> <th colspan="12">MATERIAL AVAILABILITY</th> </tr> <tr> <th>FA</th><th>X</th><th>V</th><th>R</th><th>MXS</th><th>HH</th><th>EPFA</th><th>GPFAX</th><th>SFA</th><th>SFAHH</th><th>SV</th><th>SXR</th> </tr> </thead> <tbody> <tr> <td>✓</td><td></td><td>✓</td><td></td><td></td><td></td><td></td><td></td><td></td><td></td><td></td><td></td> </tr> </tbody> </table>	MATERIAL AVAILABILITY												FA	X	V	R	MXS	HH	EPFA	GPFAX	SFA	SFAHH	SV	SXR	✓		✓									
MATERIAL AVAILABILITY																																						
FA	X	V	R	MXS	HH	EPFA	GPFAX	SFA	SFAHH	SV	SXR																											
✓		✓																																				
FA30 66.5 x 48.5 x 10mm		HONDA																																				
FA31 66.5 x 48.5 x 9mm																																						
FA32 58 x 65.5 x 10mm		<table border="1"> <thead> <tr> <th colspan="12">MATERIAL AVAILABILITY</th> </tr> <tr> <th>FA</th><th>X</th><th>V</th><th>R</th><th>MXS</th><th>HH</th><th>EPFA</th><th>GPFAX</th><th>SFA</th><th>SFAHH</th><th>SV</th><th>SXR</th> </tr> </thead> <tbody> <tr> <td>✓</td><td></td><td>✓</td><td></td><td></td><td></td><td></td><td></td><td></td><td></td><td></td><td></td> </tr> </tbody> </table>	MATERIAL AVAILABILITY												FA	X	V	R	MXS	HH	EPFA	GPFAX	SFA	SFAHH	SV	SXR	✓		✓									
MATERIAL AVAILABILITY																																						
FA	X	V	R	MXS	HH	EPFA	GPFAX	SFA	SFAHH	SV	SXR																											
✓		✓																																				
		HONDA, PERFORMANCE MACHINE AFTERMARKET CALIPER																																				
FA33 A. 51.5 x 12.5mm B. 50 x 11mm		<table border="1"> <thead> <tr> <th colspan="12">MATERIAL AVAILABILITY</th> </tr> <tr> <th>FA</th><th>X</th><th>V</th><th>R</th><th>MXS</th><th>HH</th><th>EPFA</th><th>GPFAX</th><th>SFA</th><th>SFAHH</th><th>SV</th><th>SXR</th> </tr> </thead> <tbody> <tr> <td>✓</td><td></td><td></td><td></td><td></td><td></td><td></td><td></td><td></td><td></td><td></td><td></td> </tr> </tbody> </table>	MATERIAL AVAILABILITY												FA	X	V	R	MXS	HH	EPFA	GPFAX	SFA	SFAHH	SV	SXR	✓											
MATERIAL AVAILABILITY																																						
FA	X	V	R	MXS	HH	EPFA	GPFAX	SFA	SFAHH	SV	SXR																											
✓																																						
		KAWASAKI																																				
FA34 67 x 49.5 x 11mm		<table border="1"> <thead> <tr> <th colspan="12">MATERIAL AVAILABILITY</th> </tr> <tr> <th>FA</th><th>X</th><th>V</th><th>R</th><th>MXS</th><th>HH</th><th>EPFA</th><th>GPFAX</th><th>SFA</th><th>SFAHH</th><th>SV</th><th>SXR</th> </tr> </thead> <tbody> <tr> <td>✓</td><td></td><td>✓</td><td></td><td></td><td></td><td></td><td></td><td></td><td></td><td></td><td></td> </tr> </tbody> </table>	MATERIAL AVAILABILITY												FA	X	V	R	MXS	HH	EPFA	GPFAX	SFA	SFAHH	SV	SXR	✓		✓									
MATERIAL AVAILABILITY																																						
FA	X	V	R	MXS	HH	EPFA	GPFAX	SFA	SFAHH	SV	SXR																											
✓		✓																																				
		YAMAHA																																				
FA35 A. 50 x 10.5mm B. 50 x 11mm		<table border="1"> <thead> <tr> <th colspan="12">MATERIAL AVAILABILITY</th> </tr> <tr> <th>FA</th><th>X</th><th>V</th><th>R</th><th>MXS</th><th>HH</th><th>EPFA</th><th>GPFAX</th><th>SFA</th><th>SFAHH</th><th>SV</th><th>SXR</th> </tr> </thead> <tbody> <tr> <td>✓</td><td></td><td></td><td></td><td></td><td></td><td></td><td></td><td></td><td></td><td></td><td></td> </tr> </tbody> </table>	MATERIAL AVAILABILITY												FA	X	V	R	MXS	HH	EPFA	GPFAX	SFA	SFAHH	SV	SXR	✓											
MATERIAL AVAILABILITY																																						
FA	X	V	R	MXS	HH	EPFA	GPFAX	SFA	SFAHH	SV	SXR																											
✓																																						
		SUZUKI																																				
FA36 58 x 54 x 9mm		<table border="1"> <thead> <tr> <th colspan="12">MATERIAL AVAILABILITY</th> </tr> <tr> <th>FA</th><th>X</th><th>V</th><th>R</th><th>MXS</th><th>HH</th><th>EPFA</th><th>GPFAX</th><th>SFA</th><th>SFAHH</th><th>SV</th><th>SXR</th> </tr> </thead> <tbody> <tr> <td>✓</td><td></td><td>✓</td><td></td><td></td><td></td><td></td><td></td><td></td><td></td><td></td><td></td> </tr> </tbody> </table>	MATERIAL AVAILABILITY												FA	X	V	R	MXS	HH	EPFA	GPFAX	SFA	SFAHH	SV	SXR	✓		✓									
MATERIAL AVAILABILITY																																						
FA	X	V	R	MXS	HH	EPFA	GPFAX	SFA	SFAHH	SV	SXR																											
✓		✓																																				
		GMA AFTERMARKET CALIPER, KAWASAKI, SUZUKI																																				
FA37 A. 51 x 12.5mm B. 50 x 12.5mm		<table border="1"> <thead> <tr> <th colspan="12">MATERIAL AVAILABILITY</th> </tr> <tr> <th>FA</th><th>X</th><th>V</th><th>R</th><th>MXS</th><th>HH</th><th>EPFA</th><th>GPFAX</th><th>SFA</th><th>SFAHH</th><th>SV</th><th>SXR</th> </tr> </thead> <tbody> <tr> <td>✓</td><td></td><td></td><td></td><td></td><td></td><td></td><td></td><td></td><td></td><td></td><td></td> </tr> </tbody> </table>	MATERIAL AVAILABILITY												FA	X	V	R	MXS	HH	EPFA	GPFAX	SFA	SFAHH	SV	SXR	✓											
MATERIAL AVAILABILITY																																						
FA	X	V	R	MXS	HH	EPFA	GPFAX	SFA	SFAHH	SV	SXR																											
✓																																						
		KAWASAKI																																				
FA38 50 x 10.5mm		<table border="1"> <thead> <tr> <th colspan="12">MATERIAL AVAILABILITY</th> </tr> <tr> <th>FA</th><th>X</th><th>V</th><th>R</th><th>MXS</th><th>HH</th><th>EPFA</th><th>GPFAX</th><th>SFA</th><th>SFAHH</th><th>SV</th><th>SXR</th> </tr> </thead> <tbody> <tr> <td>✓</td><td></td><td>✓</td><td></td><td></td><td></td><td></td><td></td><td></td><td></td><td></td><td></td> </tr> </tbody> </table>	MATERIAL AVAILABILITY												FA	X	V	R	MXS	HH	EPFA	GPFAX	SFA	SFAHH	SV	SXR	✓		✓									
MATERIAL AVAILABILITY																																						
FA	X	V	R	MXS	HH	EPFA	GPFAX	SFA	SFAHH	SV	SXR																											
✓		✓																																				
		SUZUKI																																				
FA40 A 40 x 20.5mm B 40 x 11mm		<table border="1"> <thead> <tr> <th colspan="12">MATERIAL AVAILABILITY</th> </tr> <tr> <th>FA</th><th>X</th><th>V</th><th>R</th><th>MXS</th><th>HH</th><th>EPFA</th><th>GPFAX</th><th>SFA</th><th>SFAHH</th><th>SV</th><th>SXR</th> </tr> </thead> <tbody> <tr> <td>✓</td><td></td><td></td><td></td><td></td><td></td><td></td><td></td><td></td><td></td><td></td><td></td> </tr> </tbody> </table>	MATERIAL AVAILABILITY												FA	X	V	R	MXS	HH	EPFA	GPFAX	SFA	SFAHH	SV	SXR	✓											
MATERIAL AVAILABILITY																																						
FA	X	V	R	MXS	HH	EPFA	GPFAX	SFA	SFAHH	SV	SXR																											
✓																																						
		HONDA																																				
FA41 94 x 56.5 x 20mm	<p>20mm</p>	<table border="1"> <thead> <tr> <th colspan="12">MATERIAL AVAILABILITY</th> </tr> <tr> <th>FA</th><th>X</th><th>V</th><th>R</th><th>MXS</th><th>HH</th><th>EPFA</th><th>GPFAX</th><th>SFA</th><th>SFAHH</th><th>SV</th><th>SXR</th> </tr> </thead> <tbody> <tr> <td>✓</td><td></td><td>✓</td><td></td><td></td><td></td><td></td><td></td><td></td><td></td><td></td><td></td> </tr> </tbody> </table>	MATERIAL AVAILABILITY												FA	X	V	R	MXS	HH	EPFA	GPFAX	SFA	SFAHH	SV	SXR	✓		✓									
MATERIAL AVAILABILITY																																						
FA	X	V	R	MXS	HH	EPFA	GPFAX	SFA	SFAHH	SV	SXR																											
✓		✓																																				
		YAMAHA																																				

FA45 52.5 x 53 x 11.5mm

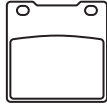

MATERIAL AVAILABILITY											
FA	X	V	R	MXS	HH	EPFA	GPFAX	SFA	SFAHH	SV	SXR
✓		✓									

HONDA

FA47 40 x 50.5 x 7mm



MATERIAL AVAILABILITY - FA47											
FA	X	V	R	MXS	HH	EPFA	GPFAX	SFA	SFAHH	SV	SXR
✓	✓				✓			✓	✓		

MATERIAL AVAILABILITY - FA47/2											
FA	X	V	R	MXS	HH	EPFA	GPFAX	SFA	SFAHH	SV	SXR
✓											

APRILIA, ARCH MOTORCYCLE, ATK, BERINGER AFTERMARKET CALIPER, BREMBO AFTERMARKET CALIPER, CAGIVA, DUCATI, HARRISON AFTERMARKET CALIPER, HUSQVARNA, ISR AFTERMARKET CALIPER, KTM, LAVERDA, MAICO/M-STAR, MONTESA, MOTO GUZZI, MZ, PRO ONE, TM DIRT, SFA47 ONLY - BETA, MALAGUTI, FA47/2- KTM

FA51 76 x 49.5 x 11.5mm



MATERIAL AVAILABILITY											
FA	X	V	R	MXS	HH	EPFA	GPFAX	SFA	SFAHH	SV	SXR
✓		✓									

SUZUKI

FA54 41 x 45 x 8mm



MATERIAL AVAILABILITY											
FA	X	V	R	MXS	HH	EPFA	GPFAX	SFA	SFAHH	SV	SXR
	✓		✓	✓	✓			✓	✓	✓	

HONDA, HYOSUNG, KAWASAKI, SUZUKI, YAMAHA, SYM, DAELIM, SACHS, U.M UNITED MOTORS

FA55 50 x 10/12.5mm

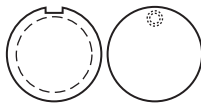

MATERIAL AVAILABILITY											
FA	X	V	R	MXS	HH	EPFA	GPFAX	SFA	SFAHH	SV	SXR
✓											

KAWASAKI, SUZUKI

FA56 44/45 x 10/8.5mm

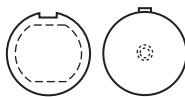

MATERIAL AVAILABILITY											
FA	X	V	R	MXS	HH	EPFA	GPFAX	SFA	SFAHH	SV	SXR
✓											

LIFAN, U.M. UNITED MOTORS

FA57 55 x 53 x 9mm

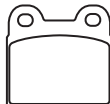

MATERIAL AVAILABILITY											
FA	X	V	R	MXS	HH	EPFA	GPFAX	SFA	SFAHH	SV	SXR
✓		✓									

BMW

FA60 36.5 x 52 x 6mm



MATERIAL AVAILABILITY											
FA	X	V	R	MXS	HH	EPFA	GPFAX	SFA	SFAHH	SV	SXR
✓											

APRILIA

FA61 94 x 56.5 x 20mm

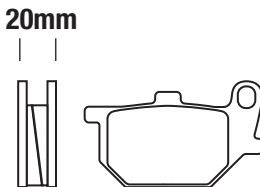

MATERIAL AVAILABILITY											
FA	X	V	R	MXS	HH	EPFA	GPFAX	SFA	SFAHH	SV	SXR
✓		✓									







YAMAHA

FA62 51 x 10.5mm



MATERIAL AVAILABILITY											
FA	X	V	R	MXS	HH	EPFA	GPFAX	SFA	SFAHH	SV	SXR
✓											

KAWASAKI

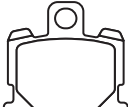
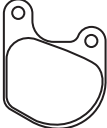
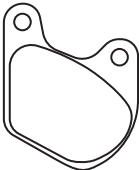
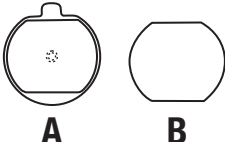
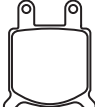
FA63 52.5 x 52.5 x 9mm		<table border="1"> <thead> <tr> <th colspan="12">MATERIAL AVAILABILITY</th> </tr> <tr> <th>FA</th><th>X</th><th>V</th><th>R</th><th>MXS</th><th>HH</th><th>EPFA</th><th>GPFAX</th><th>SFA</th><th>SFAHH</th><th>SV</th><th>SXR</th> </tr> </thead> <tbody> <tr> <td>✓</td><td></td><td>✓</td><td></td><td></td><td>✓</td><td></td><td></td><td></td><td></td><td></td><td></td> </tr> </tbody> </table>	MATERIAL AVAILABILITY												FA	X	V	R	MXS	HH	EPFA	GPFAX	SFA	SFAHH	SV	SXR	✓		✓			✓																																										
MATERIAL AVAILABILITY																																																																										
FA	X	V	R	MXS	HH	EPFA	GPFAX	SFA	SFAHH	SV	SXR																																																															
✓		✓			✓																																																																					
		SUZUKI																																																																								
FA65 72 x 45 x 11.5mm		<table border="1"> <thead> <tr> <th colspan="12">MATERIAL AVAILABILITY</th> </tr> <tr> <th>FA</th><th>X</th><th>V</th><th>R</th><th>MXS</th><th>HH</th><th>EPFA</th><th>GPFAX</th><th>SFA</th><th>SFAHH</th><th>SV</th><th>SXR</th> </tr> </thead> <tbody> <tr> <td>✓</td><td></td><td>✓</td><td></td><td></td><td></td><td></td><td></td><td></td><td></td><td></td><td></td> </tr> </tbody> </table>	MATERIAL AVAILABILITY												FA	X	V	R	MXS	HH	EPFA	GPFAX	SFA	SFAHH	SV	SXR	✓		✓																																													
MATERIAL AVAILABILITY																																																																										
FA	X	V	R	MXS	HH	EPFA	GPFAX	SFA	SFAHH	SV	SXR																																																															
✓		✓																																																																								
		SUZUKI																																																																								
FA67 A 55.5 x 37 x 10mm B 85 x 42.5 x 8mm		<table border="1"> <thead> <tr> <th colspan="12">MATERIAL AVAILABILITY - FA67</th> </tr> <tr> <th>FA</th><th>X</th><th>V</th><th>R</th><th>MXS</th><th>HH</th><th>EPFA</th><th>GPFAX</th><th>SFA</th><th>SFAHH</th><th>SV</th><th>SXR</th> </tr> </thead> <tbody> <tr> <td>✓</td><td>✓</td><td></td><td>✓</td><td></td><td>✓</td><td></td><td></td><td>✓</td><td>✓</td><td>✓</td><td></td> </tr> </tbody> </table>	MATERIAL AVAILABILITY - FA67												FA	X	V	R	MXS	HH	EPFA	GPFAX	SFA	SFAHH	SV	SXR	✓	✓		✓		✓			✓	✓	✓																																					
MATERIAL AVAILABILITY - FA67																																																																										
FA	X	V	R	MXS	HH	EPFA	GPFAX	SFA	SFAHH	SV	SXR																																																															
✓	✓		✓		✓			✓	✓	✓																																																																
FA67/3 A 55.5 x 37 x 10mm B 85 x 42.5 x 7mm		<table border="1"> <thead> <tr> <th colspan="12">MATERIAL AVAILABILITY - FA67/3</th> </tr> <tr> <th>FA</th><th>X</th><th>V</th><th>R</th><th>MXS</th><th>HH</th><th>EPFA</th><th>GPFAX</th><th>SFA</th><th>SFAHH</th><th>SV</th><th>SXR</th> </tr> </thead> <tbody> <tr> <td>✓</td><td></td><td></td><td></td><td></td><td></td><td></td><td></td><td></td><td></td><td></td><td></td> </tr> </tbody> </table> <p>CAGIVA, CF MOTO, GOGORO, KAWASAKI, KTM, MAICO/M-STAR, SUZUKI, YAMAHA, FA67/3 - KAWASAKI</p>	MATERIAL AVAILABILITY - FA67/3												FA	X	V	R	MXS	HH	EPFA	GPFAX	SFA	SFAHH	SV	SXR	✓																																															
MATERIAL AVAILABILITY - FA67/3																																																																										
FA	X	V	R	MXS	HH	EPFA	GPFAX	SFA	SFAHH	SV	SXR																																																															
✓																																																																										
FA68 68 x 40.5 x 9.5mm		<table border="1"> <thead> <tr> <th colspan="12">MATERIAL AVAILABILITY</th> </tr> <tr> <th>FA</th><th>X</th><th>V</th><th>R</th><th>MXS</th><th>HH</th><th>EPFA</th><th>GPFAX</th><th>SFA</th><th>SFAHH</th><th>SV</th><th>SXR</th> </tr> </thead> <tbody> <tr> <td>✓</td><td></td><td>✓</td><td></td><td></td><td>✓</td><td></td><td></td><td></td><td></td><td></td><td></td> </tr> </tbody> </table>	MATERIAL AVAILABILITY												FA	X	V	R	MXS	HH	EPFA	GPFAX	SFA	SFAHH	SV	SXR	✓		✓			✓																																										
MATERIAL AVAILABILITY																																																																										
FA	X	V	R	MXS	HH	EPFA	GPFAX	SFA	SFAHH	SV	SXR																																																															
✓		✓			✓																																																																					
		KAWASAKI																																																																								
FA69 89.5 x 48.5 x 10mm		<table border="1"> <thead> <tr> <th colspan="12">MATERIAL AVAILABILITY - FA69</th> </tr> <tr> <th>FA</th><th>X</th><th>V</th><th>R</th><th>MXS</th><th>HH</th><th>EPFA</th><th>GPFAX</th><th>SFA</th><th>SFAHH</th><th>SV</th><th>SXR</th> </tr> </thead> <tbody> <tr> <td>✓</td><td></td><td>✓</td><td></td><td></td><td>✓</td><td></td><td></td><td></td><td></td><td></td><td></td> </tr> </tbody> </table>	MATERIAL AVAILABILITY - FA69												FA	X	V	R	MXS	HH	EPFA	GPFAX	SFA	SFAHH	SV	SXR	✓		✓			✓																																										
MATERIAL AVAILABILITY - FA69																																																																										
FA	X	V	R	MXS	HH	EPFA	GPFAX	SFA	SFAHH	SV	SXR																																																															
✓		✓			✓																																																																					
FA69/2 89.5 x 48.5 x 9mm																																																																										
FA69/3 89.5 x 48.5 x 11.5mm																																																																										
		<table border="1"> <thead> <tr> <th colspan="12">MATERIAL AVAILABILITY - FA69/2</th> </tr> <tr> <th>FA</th><th>X</th><th>V</th><th>R</th><th>MXS</th><th>HH</th><th>EPFA</th><th>GPFAX</th><th>SFA</th><th>SFAHH</th><th>SV</th><th>SXR</th> </tr> </thead> <tbody> <tr> <td>✓</td><td></td><td>✓</td><td></td><td></td><td></td><td></td><td></td><td></td><td></td><td></td><td></td> </tr> </tbody> </table> <table border="1"> <thead> <tr> <th colspan="12">MATERIAL AVAILABILITY - FA69/3</th> </tr> <tr> <th>FA</th><th>X</th><th>V</th><th>R</th><th>MXS</th><th>HH</th><th>EPFA</th><th>GPFAX</th><th>SFA</th><th>SFAHH</th><th>SV</th><th>SXR</th> </tr> </thead> <tbody> <tr> <td>✓</td><td></td><td>✓</td><td></td><td></td><td>✓</td><td></td><td></td><td></td><td></td><td></td><td></td> </tr> </tbody> </table>	MATERIAL AVAILABILITY - FA69/2												FA	X	V	R	MXS	HH	EPFA	GPFAX	SFA	SFAHH	SV	SXR	✓		✓										MATERIAL AVAILABILITY - FA69/3												FA	X	V	R	MXS	HH	EPFA	GPFAX	SFA	SFAHH	SV	SXR	✓		✓			✓						
MATERIAL AVAILABILITY - FA69/2																																																																										
FA	X	V	R	MXS	HH	EPFA	GPFAX	SFA	SFAHH	SV	SXR																																																															
✓		✓																																																																								
MATERIAL AVAILABILITY - FA69/3																																																																										
FA	X	V	R	MXS	HH	EPFA	GPFAX	SFA	SFAHH	SV	SXR																																																															
✓		✓			✓																																																																					
		HONDA																																																																								
FA70 65.5 x 59 x 10mm		<table border="1"> <thead> <tr> <th colspan="12">MATERIAL AVAILABILITY</th> </tr> <tr> <th>FA</th><th>X</th><th>V</th><th>R</th><th>MXS</th><th>HH</th><th>EPFA</th><th>GPFAX</th><th>SFA</th><th>SFAHH</th><th>SV</th><th>SXR</th> </tr> </thead> <tbody> <tr> <td>✓</td><td></td><td>✓</td><td></td><td></td><td></td><td></td><td></td><td></td><td></td><td></td><td></td> </tr> </tbody> </table>	MATERIAL AVAILABILITY												FA	X	V	R	MXS	HH	EPFA	GPFAX	SFA	SFAHH	SV	SXR	✓		✓																																													
MATERIAL AVAILABILITY																																																																										
FA	X	V	R	MXS	HH	EPFA	GPFAX	SFA	SFAHH	SV	SXR																																																															
✓		✓																																																																								
		YAMAHA																																																																								
FA71 53.5 x 68.5 x 6.5mm		<table border="1"> <thead> <tr> <th colspan="12">MATERIAL AVAILABILITY</th> </tr> <tr> <th>FA</th><th>X</th><th>V</th><th>R</th><th>MXS</th><th>HH</th><th>EPFA</th><th>GPFAX</th><th>SFA</th><th>SFAHH</th><th>SV</th><th>SXR</th> </tr> </thead> <tbody> <tr> <td>✓</td><td></td><td>✓</td><td></td><td></td><td></td><td></td><td></td><td></td><td></td><td></td><td></td> </tr> </tbody> </table>	MATERIAL AVAILABILITY												FA	X	V	R	MXS	HH	EPFA	GPFAX	SFA	SFAHH	SV	SXR	✓		✓																																													
MATERIAL AVAILABILITY																																																																										
FA	X	V	R	MXS	HH	EPFA	GPFAX	SFA	SFAHH	SV	SXR																																																															
✓		✓																																																																								
		HARLEY DAVIDSON																																																																								
FA72 71 x 89 x 6.5mm		<table border="1"> <thead> <tr> <th colspan="12">MATERIAL AVAILABILITY</th> </tr> <tr> <th>FA</th><th>X</th><th>V</th><th>R</th><th>MXS</th><th>HH</th><th>EPFA</th><th>GPFAX</th><th>SFA</th><th>SFAHH</th><th>SV</th><th>SXR</th> </tr> </thead> <tbody> <tr> <td>✓</td><td></td><td>✓</td><td></td><td></td><td></td><td></td><td></td><td></td><td></td><td></td><td></td> </tr> </tbody> </table>	MATERIAL AVAILABILITY												FA	X	V	R	MXS	HH	EPFA	GPFAX	SFA	SFAHH	SV	SXR	✓		✓																																													
MATERIAL AVAILABILITY																																																																										
FA	X	V	R	MXS	HH	EPFA	GPFAX	SFA	SFAHH	SV	SXR																																																															
✓		✓																																																																								
		HARLEY DAVIDSON																																																																								
FA73 A 51 x 12mm B 50 x 11mm		<table border="1"> <thead> <tr> <th colspan="12">MATERIAL AVAILABILITY</th> </tr> <tr> <th>FA</th><th>X</th><th>V</th><th>R</th><th>MXS</th><th>HH</th><th>EPFA</th><th>GPFAX</th><th>SFA</th><th>SFAHH</th><th>SV</th><th>SXR</th> </tr> </thead> <tbody> <tr> <td>✓</td><td></td><td></td><td></td><td></td><td></td><td></td><td></td><td></td><td></td><td></td><td></td> </tr> </tbody> </table>	MATERIAL AVAILABILITY												FA	X	V	R	MXS	HH	EPFA	GPFAX	SFA	SFAHH	SV	SXR	✓																																															
MATERIAL AVAILABILITY																																																																										
FA	X	V	R	MXS	HH	EPFA	GPFAX	SFA	SFAHH	SV	SXR																																																															
✓																																																																										
		KAWASAKI																																																																								
FA76 43.5 x 58 x 7mm		<table border="1"> <thead> <tr> <th colspan="12">MATERIAL AVAILABILITY</th> </tr> <tr> <th>FA</th><th>X</th><th>V</th><th>R</th><th>MXS</th><th>HH</th><th>EPFA</th><th>GPFAX</th><th>SFA</th><th>SFAHH</th><th>SV</th><th>SXR</th> </tr> </thead> <tbody> <tr> <td>✓</td><td></td><td></td><td></td><td></td><td></td><td></td><td></td><td></td><td></td><td></td><td></td> </tr> </tbody> </table>	MATERIAL AVAILABILITY												FA	X	V	R	MXS	HH	EPFA	GPFAX	SFA	SFAHH	SV	SXR	✓																																															
MATERIAL AVAILABILITY																																																																										
FA	X	V	R	MXS	HH	EPFA	GPFAX	SFA	SFAHH	SV	SXR																																																															
✓																																																																										
		GMA AFTERMARKET CALIPER																																																																								

FA77 60 x 59 x 9mm

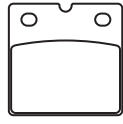

MATERIAL AVAILABILITY											
FA	X	V	R	MXS	HH	EPFA	GPFAX	SFA	SFAHH	SV	SXR
✓		✓									

BMW

FA78 74.5 x 49 x 12mm

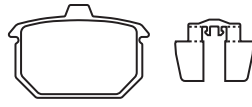

MATERIAL AVAILABILITY											
FA	X	V	R	MXS	HH	EPFA	GPFAX	SFA	SFAHH	SV	SXR
✓		✓			✓						

HARLEY DAVIDSON

FA79
174.5 x 72.5 x 10mm

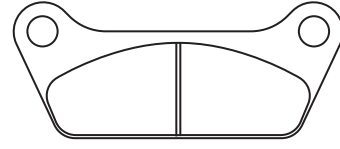

MATERIAL AVAILABILITY											
FA	X	V	R	MXS	HH	EPFA	GPFAX	SFA	SFAHH	SV	SXR
✓		✓									

HARLEY DAVIDSON

FA80/2 92 x 53.5 x 9.5mm

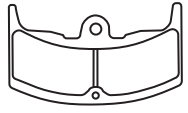

MATERIAL AVAILABILITY											
FA	X	V	R	MXS	HH	EPFA	GPFAX	SFA	SFAHH	SV	SXR
✓											

HONDA

FA81 68 x 58.5 x 10.5mm

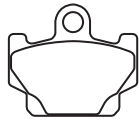

MATERIAL AVAILABILITY											
FA	X	V	R	MXS	HH	EPFA	GPFAX	SFA	SFAHH	SV	SXR
✓			✓								

YAMAHA

FA83 A 47.5 x 37 x 9mm
B 85.5 x 42.5 x 7mm



MATERIAL AVAILABILITY - FA83											
FA	X	V	R	MXS	HH	EPFA	GPFAX	SFA	SFAHH	SV	SXR
✓	✓		✓		✓			✓	✓		

FA83/2 A 47.5 x 37 x 10mm
B 85.5 x 42.5 x 8mm



MATERIAL AVAILABILITY - FA83/2											
FA	X	V	R	MXS	HH	EPFA	GPFAX	SFA	SFAHH	SV	SXR
✓								✓	✓		

FA83 - ADLY, BOMBARDIER/BRP, CAN-AM, DINLI, E-TON, HISUN, KAWASAKI, SUZUKI, POLARIS, SHERCO, UM UNITED MOTORS, UNISON, YAMAHA, ADLY, E-TON, HYOSUNG, MZ, TGB SCOOTER, ZERO, FA83/2 - PIAGGIO

FA84 46 x 45 x 8mm



MATERIAL AVAILABILITY - FA84											
FA	X	V	R	MXS	HH	EPFA	GPFAX	SFA	SFAHH	SV	SXR
	✓		✓	✓						✓	

FA84/2 46 x 45 x 6.5/8mm

FA84/3 46 x 45 x 6.5mm

MATERIAL AVAILABILITY - FA84/2											
FA	X	V	R	MXS	HH	EPFA	GPFAX	SFA	SFAHH	SV	SXR
			✓								

MATERIAL AVAILABILITY - FA84/3											
FA	X	V	R	MXS	HH	EPFA	GPFAX	SFA	SFAHH	SV	SXR
	✓		✓	✓							

FA84 - ARCTIC CAT, BENNCHE, HONDA, HUSQVARNA, KAWASAKI, SUZUKI, YAMAHA, FA84/2 - HONDA, FA84/3 - SUZUKI, YAMAHA

FA85 A 111 x 50 x 9.5mm
B 69 x 43 x 9.5mm

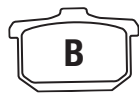

MATERIAL AVAILABILITY											
FA	X	V	R	MXS	HH	EPFA	GPFAX	SFA	SFAHH	SV	SXR
✓		✓			✓						

KAWASAKI

FA86 77 x 42 x 7.5mm



MATERIAL AVAILABILITY											
FA	X	V	R	MXS	HH	EPFA	GPFAX	SFA	SFAHH	SV	SXR
✓					✓			✓	✓		

BENELLI, CSC, HONDA, HYOSUNG, U.M., HYOSUNG, SACHS

FA88 63.5 x 55 x 9mm		<table border="1"> <thead> <tr><th colspan="12">MATERIAL AVAILABILITY</th></tr> <tr><th>FA</th><th>X</th><th>V</th><th>R</th><th>MXS</th><th>HH</th><th>EPFA</th><th>GPFAX</th><th>SFA</th><th>SFAHH</th><th>SV</th><th>SXR</th></tr> </thead> <tbody> <tr><td>✓</td><td></td><td>✓</td><td></td><td></td><td>✓</td><td>✓</td><td></td><td></td><td></td><td></td><td></td></tr> </tbody> </table>	MATERIAL AVAILABILITY												FA	X	V	R	MXS	HH	EPFA	GPFAX	SFA	SFAHH	SV	SXR	✓		✓			✓	✓					
MATERIAL AVAILABILITY																																						
FA	X	V	R	MXS	HH	EPFA	GPFAX	SFA	SFAHH	SV	SXR																											
✓		✓			✓	✓																																
		YAMAHA																																				
FA90 91 x 51.5 x 10mm		<table border="1"> <thead> <tr><th colspan="12">MATERIAL AVAILABILITY</th></tr> <tr><th>FA</th><th>X</th><th>V</th><th>R</th><th>MXS</th><th>HH</th><th>EPFA</th><th>GPFAX</th><th>SFA</th><th>SFAHH</th><th>SV</th><th>SXR</th></tr> </thead> <tbody> <tr><td>✓</td><td></td><td>✓</td><td></td><td></td><td></td><td></td><td></td><td></td><td></td><td></td><td></td></tr> </tbody> </table>	MATERIAL AVAILABILITY												FA	X	V	R	MXS	HH	EPFA	GPFAX	SFA	SFAHH	SV	SXR	✓		✓									
MATERIAL AVAILABILITY																																						
FA	X	V	R	MXS	HH	EPFA	GPFAX	SFA	SFAHH	SV	SXR																											
✓		✓																																				
		HONDA																																				
FA92 81 x 42 x 7.5mm		<table border="1"> <thead> <tr><th colspan="12">MATERIAL AVAILABILITY</th></tr> <tr><th>FA</th><th>X</th><th>V</th><th>R</th><th>MXS</th><th>HH</th><th>EPFA</th><th>GPFAX</th><th>SFA</th><th>SFAHH</th><th>SV</th><th>SXR</th></tr> </thead> <tbody> <tr><td></td><td>✓</td><td></td><td>✓</td><td></td><td></td><td></td><td></td><td></td><td></td><td></td><td></td></tr> </tbody> </table>	MATERIAL AVAILABILITY												FA	X	V	R	MXS	HH	EPFA	GPFAX	SFA	SFAHH	SV	SXR		✓		✓								
MATERIAL AVAILABILITY																																						
FA	X	V	R	MXS	HH	EPFA	GPFAX	SFA	SFAHH	SV	SXR																											
	✓		✓																																			
		HONDA																																				
SFA93 A 87.5 x 49 x 8mm B 56.5 x 36.5 x 10mm	 	<table border="1"> <thead> <tr><th colspan="12">MATERIAL AVAILABILITY</th></tr> <tr><th>FA</th><th>X</th><th>V</th><th>R</th><th>MXS</th><th>HH</th><th>EPFA</th><th>GPFAX</th><th>SFA</th><th>SFAHH</th><th>SV</th><th>SXR</th></tr> </thead> <tbody> <tr><td></td><td></td><td></td><td></td><td></td><td></td><td></td><td></td><td>✓</td><td></td><td></td><td></td></tr> </tbody> </table>	MATERIAL AVAILABILITY												FA	X	V	R	MXS	HH	EPFA	GPFAX	SFA	SFAHH	SV	SXR									✓			
MATERIAL AVAILABILITY																																						
FA	X	V	R	MXS	HH	EPFA	GPFAX	SFA	SFAHH	SV	SXR																											
								✓																														
		TGB SCOOTER																																				
FA94 56 x 60 x 13mm		<table border="1"> <thead> <tr><th colspan="12">MATERIAL AVAILABILITY</th></tr> <tr><th>FA</th><th>X</th><th>V</th><th>R</th><th>MXS</th><th>HH</th><th>EPFA</th><th>GPFAX</th><th>SFA</th><th>SFAHH</th><th>SV</th><th>SXR</th></tr> </thead> <tbody> <tr><td>✓</td><td></td><td>✓</td><td></td><td></td><td>✓</td><td>✓</td><td></td><td></td><td></td><td></td><td></td></tr> </tbody> </table>	MATERIAL AVAILABILITY												FA	X	V	R	MXS	HH	EPFA	GPFAX	SFA	SFAHH	SV	SXR	✓		✓			✓	✓					
MATERIAL AVAILABILITY																																						
FA	X	V	R	MXS	HH	EPFA	GPFAX	SFA	SFAHH	SV	SXR																											
✓		✓			✓	✓																																
		HARLEY DAVIDSON, LYNDALL BRAKES																																				
FA95 69.5 x 51 x 8mm		<table border="1"> <thead> <tr><th colspan="12">MATERIAL AVAILABILITY</th></tr> <tr><th>FA</th><th>X</th><th>V</th><th>R</th><th>MXS</th><th>HH</th><th>EPFA</th><th>GPFAX</th><th>SFA</th><th>SFAHH</th><th>SV</th><th>SXR</th></tr> </thead> <tbody> <tr><td>✓</td><td></td><td>✓</td><td></td><td></td><td>✓</td><td>✓</td><td></td><td></td><td></td><td></td><td></td></tr> </tbody> </table>	MATERIAL AVAILABILITY												FA	X	V	R	MXS	HH	EPFA	GPFAX	SFA	SFAHH	SV	SXR	✓		✓			✓	✓					
MATERIAL AVAILABILITY																																						
FA	X	V	R	MXS	HH	EPFA	GPFAX	SFA	SFAHH	SV	SXR																											
✓		✓			✓	✓																																
		BREMBO AFTERMARKET CALIPER, CAGIVA, DUCATI, GAS-GAS, HUSQVARNA, INDIAN, KTM, LAVERDA, LYNDALL BRAKES, MOTO GUZZI, OMP AFTERMARKET CALIPER, REVTECH AFTERMARKET CALIPER, TM DIRT, VOR DIRT,																																				
FA101 70.5 x 36 x 9mm		<table border="1"> <thead> <tr><th colspan="12">MATERIAL AVAILABILITY</th></tr> <tr><th>FA</th><th>X</th><th>V</th><th>R</th><th>MXS</th><th>HH</th><th>EPFA</th><th>GPFAX</th><th>SFA</th><th>SFAHH</th><th>SV</th><th>SXR</th></tr> </thead> <tbody> <tr><td>✓</td><td>✓</td><td></td><td>✓</td><td>✓</td><td></td><td></td><td></td><td>✓</td><td>✓</td><td></td><td></td></tr> </tbody> </table>	MATERIAL AVAILABILITY												FA	X	V	R	MXS	HH	EPFA	GPFAX	SFA	SFAHH	SV	SXR	✓	✓		✓	✓				✓	✓		
MATERIAL AVAILABILITY																																						
FA	X	V	R	MXS	HH	EPFA	GPFAX	SFA	SFAHH	SV	SXR																											
✓	✓		✓	✓				✓	✓																													
		YAMAHA																																				
FA103 58 x 54 x 9mm		<table border="1"> <thead> <tr><th colspan="12">MATERIAL AVAILABILITY</th></tr> <tr><th>FA</th><th>X</th><th>V</th><th>R</th><th>MXS</th><th>HH</th><th>EPFA</th><th>GPFAX</th><th>SFA</th><th>SFAHH</th><th>SV</th><th>SXR</th></tr> </thead> <tbody> <tr><td>✓</td><td></td><td>✓</td><td></td><td></td><td>✓</td><td></td><td></td><td></td><td></td><td></td><td></td></tr> </tbody> </table>	MATERIAL AVAILABILITY												FA	X	V	R	MXS	HH	EPFA	GPFAX	SFA	SFAHH	SV	SXR	✓		✓			✓						
MATERIAL AVAILABILITY																																						
FA	X	V	R	MXS	HH	EPFA	GPFAX	SFA	SFAHH	SV	SXR																											
✓		✓			✓																																	
		SUZUKI																																				
FA104 68 x 56 x 9mm		<table border="1"> <thead> <tr><th colspan="12">MATERIAL AVAILABILITY</th></tr> <tr><th>FA</th><th>X</th><th>V</th><th>R</th><th>MXS</th><th>HH</th><th>EPFA</th><th>GPFAX</th><th>SFA</th><th>SFAHH</th><th>SV</th><th>SXR</th></tr> </thead> <tbody> <tr><td>✓</td><td></td><td>✓</td><td></td><td></td><td>✓</td><td></td><td></td><td></td><td></td><td></td><td></td></tr> </tbody> </table>	MATERIAL AVAILABILITY												FA	X	V	R	MXS	HH	EPFA	GPFAX	SFA	SFAHH	SV	SXR	✓		✓			✓						
MATERIAL AVAILABILITY																																						
FA	X	V	R	MXS	HH	EPFA	GPFAX	SFA	SFAHH	SV	SXR																											
✓		✓			✓																																	
		YAMAHA																																				
FA105 91 x 30 x 8mm		<table border="1"> <thead> <tr><th colspan="12">MATERIAL AVAILABILITY</th></tr> <tr><th>FA</th><th>X</th><th>V</th><th>R</th><th>MXS</th><th>HH</th><th>EPFA</th><th>GPFAX</th><th>SFA</th><th>SFAHH</th><th>SV</th><th>SXR</th></tr> </thead> <tbody> <tr><td></td><td>✓</td><td></td><td>✓</td><td></td><td></td><td></td><td></td><td></td><td></td><td></td><td></td></tr> </tbody> </table>	MATERIAL AVAILABILITY												FA	X	V	R	MXS	HH	EPFA	GPFAX	SFA	SFAHH	SV	SXR		✓		✓								
MATERIAL AVAILABILITY																																						
FA	X	V	R	MXS	HH	EPFA	GPFAX	SFA	SFAHH	SV	SXR																											
	✓		✓																																			
		YAMAHA																																				

FA106 77 x 54 x 8mm

FA106/2 77 x 54 x 9.5mm

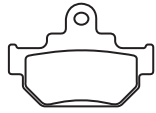

MATERIAL AVAILABILITY - FA106											
FA	X	V	R	MXS	HH	EPFA	GPFAX	SFA	SFAHH	SV	SXR
	✓		✓								

MATERIAL AVAILABILITY - FA106/2											
FA	X	V	R	MXS	HH	EPFA	GPFAX	SFA	SFAHH	SV	SXR
	✓		✓								

FA106 - SUZUKI, FA106/2 - MAICO/M-STAR, SUZUKI

FA109 50 x 55.5 x 11.5mm



MATERIAL AVAILABILITY											
FA	X	V	R	MXS	HH	EPFA	GPFAX	SFA	SFAHH	SV	SXR
✓											

HONDA

FA111 65 x 57 x 9mm

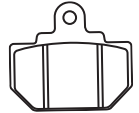

MATERIAL AVAILABILITY											
FA	X	V	R	MXS	HH	EPFA	GPFAX	SFA	SFAHH	SV	SXR
✓											

HONDA

FA115 36 x 45 x 6mm



MATERIAL AVAILABILITY											
FA	X	V	R	MXS	HH	EPFA	GPFAX	SFA	SFAHH	SV	SXR
✓	✓		✓	✓	✓			✓	✓		

BETA, CPI, DERBI, DUCATI, GAS-GAS, HUSQVARNA, IRON PEGASUS AFTERMARKET CALIPER, JAYBRAKE AFTERMARKET CALIPER, KTM, LYNDALL BRAKES, MA, ICO/M-STAR, MONTESA, PEUGEOT, SCORPA, SHERCO DIRT, UM UNITED MOTORS, BETA, DERBI, HUSQVARNA, ITALJET, PEUGEOT

FA116 31.5 x 57 x 5.5mm

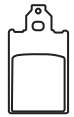

MATERIAL AVAILABILITY											
FA	X	V	R	MXS	HH	EPFA	GPFAX	SFA	SFAHH	SV	SXR
✓								✓			

BETA, OMP AFTERMARKET CALIPERS, MALAGUTI, TOMOS

FA119 82.5 x 21.5 x 7mm



MATERIAL AVAILABILITY											
FA	X	V	R	MXS	HH	EPFA	GPFAX	SFA	SFAHH	SV	SXR
	✓		✓								

YAMAHA

FA121 81 x 42 x 9mm



MATERIAL AVAILABILITY											
FA	X	V	R	MXS	HH	EPFA	GPFAX	SFA	SFAHH	SV	SXR
✓					✓						

HONDA

FA122 55 x 52.5 x 9.5mm

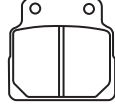

MATERIAL AVAILABILITY											
FA	X	V	R	MXS	HH	EPFA	GPFAX	SFA	SFAHH	SV	SXR
✓											

HONDA

FA123 75 x 54 x 10mm

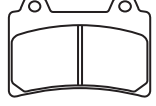

MATERIAL AVAILABILITY											
FA	X	V	R	MXS	HH	EPFA	GPFAX	SFA	SFAHH	SV	SXR
✓		✓			✓						

YAMAHA

FA124 88 x 46.5 x 8.5mm

FA124/2 88 x 46.5 x 10mm

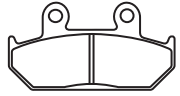

MATERIAL AVAILABILITY - FA124											
FA	X	V	R	MXS	HH	EPFA	GPFAX	SFA	SFAHH	SV	SXR
✓					✓						

MATERIAL AVAILABILITY - FA124/2											
FA	X	V	R	MXS	HH	EPFA	GPFAX	SFA	SFAHH	SV	SXR
✓		✓			✓						

FA124 - HONDA, FA124/2 - HONDA

FA125 94 x 32 x 7.5mm		<table border="1"> <thead> <tr> <th colspan="12">MATERIAL AVAILABILITY</th> </tr> <tr> <th>FA</th><th>X</th><th>V</th><th>R</th><th>MXS</th><th>HH</th><th>EPFA</th><th>GPFAX</th><th>SFA</th><th>SFAHH</th><th>SV</th><th>SXR</th> </tr> </thead> <tbody> <tr> <td></td><td>✓</td><td></td><td></td><td></td><td></td><td></td><td></td><td></td><td></td><td></td><td></td> </tr> </tbody> </table>	MATERIAL AVAILABILITY												FA	X	V	R	MXS	HH	EPFA	GPFAX	SFA	SFAHH	SV	SXR		✓										
MATERIAL AVAILABILITY																																						
FA	X	V	R	MXS	HH	EPFA	GPFAX	SFA	SFAHH	SV	SXR																											
	✓																																					
HONDA																																						
FA126 67.5 x 51 x 7mm		<table border="1"> <thead> <tr> <th colspan="12">MATERIAL AVAILABILITY</th> </tr> <tr> <th>FA</th><th>X</th><th>V</th><th>R</th><th>MXS</th><th>HH</th><th>EPFA</th><th>GPFAX</th><th>SFA</th><th>SFAHH</th><th>SV</th><th>SXR</th> </tr> </thead> <tbody> <tr> <td></td><td>✓</td><td></td><td></td><td></td><td>✓</td><td></td><td></td><td></td><td></td><td></td><td></td> </tr> </tbody> </table>	MATERIAL AVAILABILITY												FA	X	V	R	MXS	HH	EPFA	GPFAX	SFA	SFAHH	SV	SXR		✓				✓						
MATERIAL AVAILABILITY																																						
FA	X	V	R	MXS	HH	EPFA	GPFAX	SFA	SFAHH	SV	SXR																											
	✓				✓																																	
KTM, MOTO GUZZI, MZ																																						
FA128 A 85 x 37 x 8mm B 55.5 x 37 x 10mm	 	<table border="1"> <thead> <tr> <th colspan="12">MATERIAL AVAILABILITY</th> </tr> <tr> <th>FA</th><th>X</th><th>V</th><th>R</th><th>MXS</th><th>HH</th><th>EPFA</th><th>GPFAX</th><th>SFA</th><th>SFAHH</th><th>SV</th><th>SXR</th> </tr> </thead> <tbody> <tr> <td></td><td>✓</td><td></td><td>✓</td><td></td><td></td><td></td><td></td><td></td><td></td><td>✓</td><td></td> </tr> </tbody> </table>	MATERIAL AVAILABILITY												FA	X	V	R	MXS	HH	EPFA	GPFAX	SFA	SFAHH	SV	SXR		✓		✓							✓	
MATERIAL AVAILABILITY																																						
FA	X	V	R	MXS	HH	EPFA	GPFAX	SFA	SFAHH	SV	SXR																											
	✓		✓							✓																												
KAWASAKI, SUZUKI																																						
FA129 A 141.5 x 41 x 10mm B 95 x 35 x 9.5mm	 	<table border="1"> <thead> <tr> <th colspan="12">MATERIAL AVAILABILITY</th> </tr> <tr> <th>FA</th><th>X</th><th>V</th><th>R</th><th>MXS</th><th>HH</th><th>EPFA</th><th>GPFAX</th><th>SFA</th><th>SFAHH</th><th>SV</th><th>SXR</th> </tr> </thead> <tbody> <tr> <td>✓</td><td></td><td>✓</td><td>✓</td><td></td><td>✓</td><td>✓</td><td></td><td></td><td></td><td></td><td></td> </tr> </tbody> </table>	MATERIAL AVAILABILITY												FA	X	V	R	MXS	HH	EPFA	GPFAX	SFA	SFAHH	SV	SXR	✓		✓	✓		✓	✓					
MATERIAL AVAILABILITY																																						
FA	X	V	R	MXS	HH	EPFA	GPFAX	SFA	SFAHH	SV	SXR																											
✓		✓	✓		✓	✓																																
KAWASAKI, SUZUKI																																						
FA130 A 74 x 49 x 6.5mm B 61 x 62.5 x 9mm	 	<table border="1"> <thead> <tr> <th colspan="12">MATERIAL AVAILABILITY</th> </tr> <tr> <th>FA</th><th>X</th><th>V</th><th>R</th><th>MXS</th><th>HH</th><th>EPFA</th><th>GPFAX</th><th>SFA</th><th>SFAHH</th><th>SV</th><th>SXR</th> </tr> </thead> <tbody> <tr> <td></td><td>✓</td><td></td><td>✓</td><td></td><td></td><td></td><td></td><td></td><td></td><td></td><td></td> </tr> </tbody> </table>	MATERIAL AVAILABILITY												FA	X	V	R	MXS	HH	EPFA	GPFAX	SFA	SFAHH	SV	SXR		✓		✓								
MATERIAL AVAILABILITY																																						
FA	X	V	R	MXS	HH	EPFA	GPFAX	SFA	SFAHH	SV	SXR																											
	✓		✓																																			
KAWASAKI																																						
FA131 75 x 36 x 10.5mm FA131R 75 x 36 x 9mm		<table border="1"> <thead> <tr> <th colspan="12">MATERIAL AVAILABILITY</th> </tr> <tr> <th>FA</th><th>X</th><th>V</th><th>R</th><th>MXS</th><th>HH</th><th>EPFA</th><th>GPFAX</th><th>SFA</th><th>SFAHH</th><th>SV</th><th>SXR</th> </tr> </thead> <tbody> <tr> <td></td><td>✓</td><td></td><td>✓</td><td>✓</td><td></td><td>✓</td><td></td><td></td><td></td><td></td><td></td> </tr> </tbody> </table>	MATERIAL AVAILABILITY												FA	X	V	R	MXS	HH	EPFA	GPFAX	SFA	SFAHH	SV	SXR		✓		✓	✓		✓					
MATERIAL AVAILABILITY																																						
FA	X	V	R	MXS	HH	EPFA	GPFAX	SFA	SFAHH	SV	SXR																											
	✓		✓	✓		✓																																
AJP, GAS-GAS, HONDA, HUSQVARNA, KAWASAKI, SUZUKI, T.M., YAMAHA																																						
FA132 79.5 x 46 x 9mm		<table border="1"> <thead> <tr> <th colspan="12">MATERIAL AVAILABILITY</th> </tr> <tr> <th>FA</th><th>X</th><th>V</th><th>R</th><th>MXS</th><th>HH</th><th>EPFA</th><th>GPFAX</th><th>SFA</th><th>SFAHH</th><th>SV</th><th>SXR</th> </tr> </thead> <tbody> <tr> <td></td><td>✓</td><td></td><td>✓</td><td></td><td></td><td></td><td></td><td></td><td></td><td></td><td></td> </tr> </tbody> </table>	MATERIAL AVAILABILITY												FA	X	V	R	MXS	HH	EPFA	GPFAX	SFA	SFAHH	SV	SXR		✓		✓								
MATERIAL AVAILABILITY																																						
FA	X	V	R	MXS	HH	EPFA	GPFAX	SFA	SFAHH	SV	SXR																											
	✓		✓																																			
KTM																																						
FA134 100 x 46.5 x 9mm		<table border="1"> <thead> <tr> <th colspan="12">MATERIAL AVAILABILITY</th> </tr> <tr> <th>FA</th><th>X</th><th>V</th><th>R</th><th>MXS</th><th>HH</th><th>EPFA</th><th>GPFAX</th><th>SFA</th><th>SFAHH</th><th>SV</th><th>SXR</th> </tr> </thead> <tbody> <tr> <td></td><td>✓</td><td></td><td>✓</td><td></td><td></td><td></td><td></td><td></td><td></td><td></td><td></td> </tr> </tbody> </table>	MATERIAL AVAILABILITY												FA	X	V	R	MXS	HH	EPFA	GPFAX	SFA	SFAHH	SV	SXR		✓		✓								
MATERIAL AVAILABILITY																																						
FA	X	V	R	MXS	HH	EPFA	GPFAX	SFA	SFAHH	SV	SXR																											
	✓		✓																																			
CAGIVA, CAGIVA																																						
FA135 A 97 x 42 x 7.5mm B 77 x 42 x 7.5mm	 	<table border="1"> <thead> <tr> <th colspan="12">MATERIAL AVAILABILITY</th> </tr> <tr> <th>FA</th><th>X</th><th>V</th><th>R</th><th>MXS</th><th>HH</th><th>EPFA</th><th>GPFAX</th><th>SFA</th><th>SFAHH</th><th>SV</th><th>SXR</th> </tr> </thead> <tbody> <tr> <td></td><td>✓</td><td>✓</td><td>✓</td><td>✓</td><td></td><td></td><td></td><td></td><td></td><td></td><td>✓</td> </tr> </tbody> </table>	MATERIAL AVAILABILITY												FA	X	V	R	MXS	HH	EPFA	GPFAX	SFA	SFAHH	SV	SXR		✓	✓	✓	✓							✓
MATERIAL AVAILABILITY																																						
FA	X	V	R	MXS	HH	EPFA	GPFAX	SFA	SFAHH	SV	SXR																											
	✓	✓	✓	✓							✓																											
BENCH, CAN-AM SIDE X SIDE, CF MOTO, HISUN, HUSQVARNA, KAWASAKI, MASSIMO, MZ, UM UNITED MOTORS, YAMAHA																																						
FA136 80 x 42.5 x 9.5mm		<table border="1"> <thead> <tr> <th colspan="12">MATERIAL AVAILABILITY</th> </tr> <tr> <th>FA</th><th>X</th><th>V</th><th>R</th><th>MXS</th><th>HH</th><th>EPFA</th><th>GPFAX</th><th>SFA</th><th>SFAHH</th><th>SV</th><th>SXR</th> </tr> </thead> <tbody> <tr> <td>✓</td><td></td><td></td><td></td><td></td><td></td><td></td><td></td><td></td><td></td><td></td><td></td> </tr> </tbody> </table>	MATERIAL AVAILABILITY												FA	X	V	R	MXS	HH	EPFA	GPFAX	SFA	SFAHH	SV	SXR	✓											
MATERIAL AVAILABILITY																																						
FA	X	V	R	MXS	HH	EPFA	GPFAX	SFA	SFAHH	SV	SXR																											
✓																																						
YAMAHA																																						
FA137 47 x 45 x 7.5mm		<table border="1"> <thead> <tr> <th colspan="12">MATERIAL AVAILABILITY</th> </tr> <tr> <th>FA</th><th>X</th><th>V</th><th>R</th><th>MXS</th><th>HH</th><th>EPFA</th><th>GPFAX</th><th>SFA</th><th>SFAHH</th><th>SV</th><th>SXR</th> </tr> </thead> <tbody> <tr> <td></td><td>✓</td><td></td><td>✓</td><td></td><td></td><td></td><td></td><td></td><td></td><td>✓</td><td></td> </tr> </tbody> </table>	MATERIAL AVAILABILITY												FA	X	V	R	MXS	HH	EPFA	GPFAX	SFA	SFAHH	SV	SXR		✓		✓							✓	
MATERIAL AVAILABILITY																																						
FA	X	V	R	MXS	HH	EPFA	GPFAX	SFA	SFAHH	SV	SXR																											
	✓		✓							✓																												
ARCTIC CAT, HYOSUNG, KAWASAKI, SUZUKI																																						

FA140 86.5 x 39.5 x 10mm



MATERIAL AVAILABILITY											
FA	X	V	R	MXS	HH	EPFA	GPFAX	SFA	SFAHH	SV	SXR
✓		✓			✓						

BUELL, CF MOTO, CSC, HONDA, KAWASAKI, TRIUMPH, YAMAHA

FA141 A 106 x 38.5 x 9mm
B 76 x 27 x 10.5mm

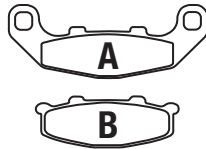

MATERIAL AVAILABILITY											
FA	X	V	R	MXS	HH	EPFA	GPFAX	SFA	SFAHH	SV	SXR
✓											

KAWASAKI

FA142 102 x 39 x 9mm

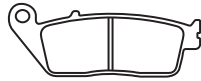

MATERIAL AVAILABILITY											
FA	X	V	R	MXS	HH	EPFA	GPFAX	SFA	SFAHH	SV	SXR
✓		✓			✓			✓	✓		

BENELLI, CAGIVA, HONDA, KAWASAKI, SUZUKI, TRIUMPH, YAMAHA, BMW, DAELIM, HONDA, KYMCO, SUZUKI

FA143 94 x 32 x 10mm



MATERIAL AVAILABILITY											
FA	X	V	R	MXS	HH	EPFA	GPFAX	SFA	SFAHH	SV	SXR
✓											

HONDA

FA145 70 x 55 x 8mm

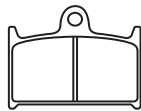

MATERIAL AVAILABILITY											
FA	X	V	R	MXS	HH	EPFA	GPFAX	SFA	SFAHH	SV	SXR
✓					✓	✓					

MZ, SUZUKI, YAMAHA

FA146 59 x 57.5 x 9mm

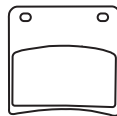

MATERIAL AVAILABILITY											
FA	X	V	R	MXS	HH	EPFA	GPFAX	SFA	SFAHH	SV	SXR
✓		✓			✓						

SUZUKI

FA147 A 118 x 48 x 8.5mm
B 97.5 x 58.5 x 11mm

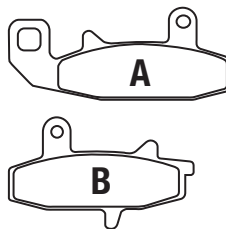

MATERIAL AVAILABILITY											
FA	X	V	R	MXS	HH	EPFA	GPFAX	SFA	SFAHH	SV	SXR
	✓		✓								

SUZUKI

FA150 59 x 57.5 x 9mm

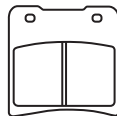

MATERIAL AVAILABILITY											
FA	X	V	R	MXS	HH	EPFA	GPFAX	SFA	SFAHH	SV	SXR
✓		✓			✓						

SUZUKI

FA151 52 x 37 x 8.5mm



MATERIAL AVAILABILITY											
FA	X	V	R	MXS	HH	EPFA	GPFAX	SFA	SFAHH	SV	SXR
✓								✓			

HONDA, MORIWAKI/HONDA, SYM

FA152 62 x 41 x 8.5mm
FA152/2 62 x 41 x 11mm



MATERIAL AVAILABILITY - FA152											
FA	X	V	R	MXS	HH	EPFA	GPFAX	SFA	SFAHH	SV	SXR
	✓		✓	✓							

MATERIAL AVAILABILITY - FA152/2											
FA	X	V	R	MXS	HH	EPFA	GPFAX	SFA	SFAHH	SV	SXR
	✓		✓	✓							

FA152 - KAWASAKI, SUZUKI, YAMAHA, FA152/2 - SUZUKI, YAMAHA

FA155 A 37 x 8mm B 39 x 23mm		<table border="1"> <thead> <tr> <th colspan="12">MATERIAL AVAILABILITY</th> </tr> <tr> <th>FA</th> <th>X</th> <th>V</th> <th>R</th> <th>MXS</th> <th>HH</th> <th>EPFA</th> <th>GPFAX</th> <th>SFA</th> <th>SFAHH</th> <th>SV</th> <th>SXR</th> </tr> </thead> <tbody> <tr> <td></td> <td>✓</td> <td></td> <td>✓</td> <td></td> <td></td> <td></td> <td></td> <td></td> <td></td> <td></td> <td></td> </tr> </tbody> </table> <p>YAMAHA</p>	MATERIAL AVAILABILITY												FA	X	V	R	MXS	HH	EPFA	GPFAX	SFA	SFAHH	SV	SXR		✓		✓								
MATERIAL AVAILABILITY																																						
FA	X	V	R	MXS	HH	EPFA	GPFAX	SFA	SFAHH	SV	SXR																											
	✓		✓																																			
FA156 56 x 45.5 x 6mm		<table border="1"> <thead> <tr> <th colspan="12">MATERIAL AVAILABILITY</th> </tr> <tr> <th>FA</th> <th>X</th> <th>V</th> <th>R</th> <th>MXS</th> <th>HH</th> <th>EPFA</th> <th>GPFAX</th> <th>SFA</th> <th>SFAHH</th> <th>SV</th> <th>SXR</th> </tr> </thead> <tbody> <tr> <td></td> <td>✓</td> <td></td> <td></td> <td></td> <td></td> <td></td> <td></td> <td></td> <td></td> <td></td> <td></td> </tr> </tbody> </table> <p>BETA</p>	MATERIAL AVAILABILITY												FA	X	V	R	MXS	HH	EPFA	GPFAX	SFA	SFAHH	SV	SXR		✓										
MATERIAL AVAILABILITY																																						
FA	X	V	R	MXS	HH	EPFA	GPFAX	SFA	SFAHH	SV	SXR																											
	✓																																					
FA157 A 99.5 x 43.5 x 7.5mm B 83 x 47 x 9.5mm		<table border="1"> <thead> <tr> <th colspan="12">MATERIAL AVAILABILITY</th> </tr> <tr> <th>FA</th> <th>X</th> <th>V</th> <th>R</th> <th>MXS</th> <th>HH</th> <th>EPFA</th> <th>GPFAX</th> <th>SFA</th> <th>SFAHH</th> <th>SV</th> <th>SXR</th> </tr> </thead> <tbody> <tr> <td></td> <td>✓</td> <td></td> <td>✓</td> <td></td> <td></td> <td></td> <td></td> <td></td> <td></td> <td></td> <td></td> </tr> </tbody> </table> <p>SUZUKI</p>	MATERIAL AVAILABILITY												FA	X	V	R	MXS	HH	EPFA	GPFAX	SFA	SFAHH	SV	SXR		✓		✓								
MATERIAL AVAILABILITY																																						
FA	X	V	R	MXS	HH	EPFA	GPFAX	SFA	SFAHH	SV	SXR																											
	✓		✓																																			
FA158 70 x 46.5 x 8mm		<table border="1"> <thead> <tr> <th colspan="12">MATERIAL AVAILABILITY</th> </tr> <tr> <th>FA</th> <th>X</th> <th>V</th> <th>R</th> <th>MXS</th> <th>HH</th> <th>EPFA</th> <th>GPFAX</th> <th>SFA</th> <th>SFAHH</th> <th>SV</th> <th>SXR</th> </tr> </thead> <tbody> <tr> <td>✓</td> <td></td> <td></td> <td></td> <td></td> <td>✓</td> <td>✓</td> <td></td> <td></td> <td></td> <td></td> <td></td> </tr> </tbody> </table> <p>KAWASAKI, SUZUKI, HUSABERG, VERTEMATI, AP/LOCKHEED AFTERMARKET CALIPERS, MOTOMASTER AFTERMARKET CALIPERS, PRE TECH AFTERMARKET CALIPERS, PRO-ONE AFTERMARKET CALIPERS</p>	MATERIAL AVAILABILITY												FA	X	V	R	MXS	HH	EPFA	GPFAX	SFA	SFAHH	SV	SXR	✓					✓	✓					
MATERIAL AVAILABILITY																																						
FA	X	V	R	MXS	HH	EPFA	GPFAX	SFA	SFAHH	SV	SXR																											
✓					✓	✓																																
FA159 97.5 x 39.5 x 8mm		<table border="1"> <thead> <tr> <th colspan="12">MATERIAL AVAILABILITY</th> </tr> <tr> <th>FA</th> <th>X</th> <th>V</th> <th>R</th> <th>MXS</th> <th>HH</th> <th>EPFA</th> <th>GPFAX</th> <th>SFA</th> <th>SFAHH</th> <th>SV</th> <th>SXR</th> </tr> </thead> <tbody> <tr> <td></td> <td>✓</td> <td>✓</td> <td>✓</td> <td></td> <td>✓</td> <td></td> <td></td> <td></td> <td></td> <td></td> <td></td> </tr> </tbody> </table> <p>POLARIS, ALL DISC FRONT BRAKE MODELS - CHECK APPLICATION PAGES FOR MAIN FITMENTS.</p>	MATERIAL AVAILABILITY												FA	X	V	R	MXS	HH	EPFA	GPFAX	SFA	SFAHH	SV	SXR		✓	✓	✓		✓						
MATERIAL AVAILABILITY																																						
FA	X	V	R	MXS	HH	EPFA	GPFAX	SFA	SFAHH	SV	SXR																											
	✓	✓	✓		✓																																	
FA160 75 x 54 x 10mm		<table border="1"> <thead> <tr> <th colspan="12">MATERIAL AVAILABILITY</th> </tr> <tr> <th>FA</th> <th>X</th> <th>V</th> <th>R</th> <th>MXS</th> <th>HH</th> <th>EPFA</th> <th>GPFAX</th> <th>SFA</th> <th>SFAHH</th> <th>SV</th> <th>SXR</th> </tr> </thead> <tbody> <tr> <td>✓</td> <td></td> <td></td> <td></td> <td></td> <td>✓</td> <td></td> <td></td> <td></td> <td></td> <td></td> <td></td> </tr> </tbody> </table> <p>YAMAHA</p>	MATERIAL AVAILABILITY												FA	X	V	R	MXS	HH	EPFA	GPFAX	SFA	SFAHH	SV	SXR	✓					✓						
MATERIAL AVAILABILITY																																						
FA	X	V	R	MXS	HH	EPFA	GPFAX	SFA	SFAHH	SV	SXR																											
✓					✓																																	
FA161 52.5 x 52.5 x 8mm		<table border="1"> <thead> <tr> <th colspan="12">MATERIAL AVAILABILITY</th> </tr> <tr> <th>FA</th> <th>X</th> <th>V</th> <th>R</th> <th>MXS</th> <th>HH</th> <th>EPFA</th> <th>GPFAX</th> <th>SFA</th> <th>SFAHH</th> <th>SV</th> <th>SXR</th> </tr> </thead> <tbody> <tr> <td>✓</td> <td></td> <td>✓</td> <td></td> <td></td> <td>✓</td> <td></td> <td></td> <td></td> <td></td> <td></td> <td></td> </tr> </tbody> </table> <p>KAWASAKI</p>	MATERIAL AVAILABILITY												FA	X	V	R	MXS	HH	EPFA	GPFAX	SFA	SFAHH	SV	SXR	✓		✓			✓						
MATERIAL AVAILABILITY																																						
FA	X	V	R	MXS	HH	EPFA	GPFAX	SFA	SFAHH	SV	SXR																											
✓		✓			✓																																	
FA162 48 x 44.5 x 7.5mm		<table border="1"> <thead> <tr> <th colspan="12">MATERIAL AVAILABILITY</th> </tr> <tr> <th>FA</th> <th>X</th> <th>V</th> <th>R</th> <th>MXS</th> <th>HH</th> <th>EPFA</th> <th>GPFAX</th> <th>SFA</th> <th>SFAHH</th> <th>SV</th> <th>SXR</th> </tr> </thead> <tbody> <tr> <td>✓</td> <td></td> <td></td> <td></td> <td></td> <td></td> <td></td> <td></td> <td></td> <td></td> <td></td> <td></td> </tr> </tbody> </table> <p>YAMAHA</p>	MATERIAL AVAILABILITY												FA	X	V	R	MXS	HH	EPFA	GPFAX	SFA	SFAHH	SV	SXR	✓											
MATERIAL AVAILABILITY																																						
FA	X	V	R	MXS	HH	EPFA	GPFAX	SFA	SFAHH	SV	SXR																											
✓																																						
FA163 100 x 52 x 8mm		<table border="1"> <thead> <tr> <th colspan="12">MATERIAL AVAILABILITY</th> </tr> <tr> <th>FA</th> <th>X</th> <th>V</th> <th>R</th> <th>MXS</th> <th>HH</th> <th>EPFA</th> <th>GPFAX</th> <th>SFA</th> <th>SFAHH</th> <th>SV</th> <th>SXR</th> </tr> </thead> <tbody> <tr> <td>✓</td> <td></td> <td></td> <td></td> <td></td> <td></td> <td></td> <td></td> <td></td> <td></td> <td></td> <td></td> </tr> </tbody> </table> <p>CAGIVA, MOTO GUZZI</p>	MATERIAL AVAILABILITY												FA	X	V	R	MXS	HH	EPFA	GPFAX	SFA	SFAHH	SV	SXR	✓											
MATERIAL AVAILABILITY																																						
FA	X	V	R	MXS	HH	EPFA	GPFAX	SFA	SFAHH	SV	SXR																											
✓																																						
FA164 74.5 x 40.5 x 6.5mm		<table border="1"> <thead> <tr> <th colspan="12">MATERIAL AVAILABILITY</th> </tr> <tr> <th>FA</th> <th>X</th> <th>V</th> <th>R</th> <th>MXS</th> <th>HH</th> <th>EPFA</th> <th>GPFAX</th> <th>SFA</th> <th>SFAHH</th> <th>SV</th> <th>SXR</th> </tr> </thead> <tbody> <tr> <td></td> <td>✓</td> <td></td> <td>✓</td> <td></td> <td></td> <td></td> <td></td> <td></td> <td></td> <td></td> <td></td> </tr> </tbody> </table> <p>BETA</p>	MATERIAL AVAILABILITY												FA	X	V	R	MXS	HH	EPFA	GPFAX	SFA	SFAHH	SV	SXR		✓		✓								
MATERIAL AVAILABILITY																																						
FA	X	V	R	MXS	HH	EPFA	GPFAX	SFA	SFAHH	SV	SXR																											
	✓		✓																																			

FA165 A 97 x 42 x 7.5mm
B 77 x 42 x 7.5mm



MATERIAL AVAILABILITY - FA165											
FA	X	V	R	MXS	HH	EPFA	GPFAX	SFA	SFAHH	SV	SXR
✓	✓		✓	✓						✓	

MATERIAL AVAILABILITY - FA165/2											
FA	X	V	R	MXS	HH	EPFA	GPFAX	SFA	SFAHH	SV	SXR
	✓		✓								✓

FA165 - BENNCHE, CAN-AM, CF MOTO, E-TON QUADS, HISUN, KAWASAKI, MASSIMO, SUZUKI, YAMAHA, FA165/2 - CAGIVA, MZ, LIFAN, CAN-AM

FA167 77.5 x 42 x 7.5mm



MATERIAL AVAILABILITY											
FA	X	V	R	MXS	HH	EPFA	GPFAX	SFA	SFAHH	SV	SXR
✓					✓						

BETA, DERBI, GAS-GAS, HUSQVARNA

SFA169 61 x 27 x 7.5mm



MATERIAL AVAILABILITY											
FA	X	V	R	MXS	HH	EPFA	GPFAX	SFA	SFAHH	SV	SXR
								✓	✓		

ADLY, E-TON, THUMPSTAR, UM UNITED MOTORS, YAMAHA

FA171 58 x 53.5 x 9mm

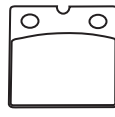

MATERIAL AVAILABILITY											
FA	X	V	R	MXS	HH	EPFA	GPFAX	SFA	SFAHH	SV	SXR
✓		✓			✓						

BMW

FA172 A 104 x 46.5 x 10mm
B 88 x 46 x 10mm

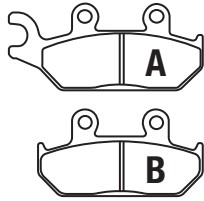

MATERIAL AVAILABILITY											
FA	X	V	R	MXS	HH	EPFA	GPFAX	SFA	SFAHH	SV	SXR
	✓		✓								

YAMAHA

FA173 A 85.5 x 42.5 x 7.5mm
B 56 x 34 x 9mm

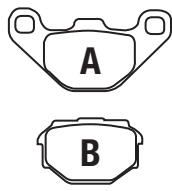

MATERIAL AVAILABILITY											
FA	X	V	R	MXS	HH	EPFA	GPFAX	SFA	SFAHH	SV	SXR
✓											

APRILIA, MZ

FA174 86 x 40 x 10mm

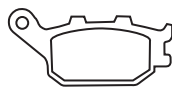

MATERIAL AVAILABILITY											
FA	X	V	R	MXS	HH	EPFA	GPFAX	SFA	SFAHH	SV	SXR
✓		✓			✓						

HONDA, KAWASAKI, SUZUKI, YAMAHA

FA175 33.5 x 51 x 7mm



MATERIAL AVAILABILITY											
FA	X	V	R	MXS	HH	EPFA	GPFAX	SFA	SFAHH	SV	SXR
✓					✓	✓					

ARCH MOTORCYCLE, HARRISON BILLET AFTERMARKET CALIPER, ISR AFTERMARKET CALIPER

FA177 87 x 52 x 7.5mm



MATERIAL AVAILABILITY											
FA	X	V	R	MXS	HH	EPFA	GPFAX	SFA	SFAHH	SV	SXR
✓											

MZ

FA179 102 x 41 x 10mm

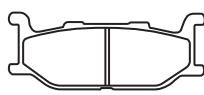

MATERIAL AVAILABILITY											
FA	X	V	R	MXS	HH	EPFA	GPFAX	SFA	SFAHH	SV	SXR
✓		✓			✓			✓	✓		

YAMAHA

FA180 59 x 43.5 x 8mm		<table border="1"> <thead> <tr> <th colspan="12">MATERIAL AVAILABILITY</th> </tr> <tr> <th>FA</th><th>X</th><th>V</th><th>R</th><th>MXS</th><th>HH</th><th>EPFA</th><th>GPFAX</th><th>SFA</th><th>SFAHH</th><th>SV</th><th>SXR</th> </tr> </thead> <tbody> <tr> <td>✓</td><td></td><td>✓</td><td></td><td></td><td>✓</td><td></td><td></td><td>✓</td><td>✓</td><td></td><td></td> </tr> </tbody> </table> <p>PRE TECH AFTERMARKET CALIPER</p>	MATERIAL AVAILABILITY												FA	X	V	R	MXS	HH	EPFA	GPFAX	SFA	SFAHH	SV	SXR	✓		✓			✓			✓	✓		
MATERIAL AVAILABILITY																																						
FA	X	V	R	MXS	HH	EPFA	GPFAX	SFA	SFAHH	SV	SXR																											
✓		✓			✓			✓	✓																													
FA181 94 x 36.5 x 7.5mm		<table border="1"> <thead> <tr> <th colspan="12">MATERIAL AVAILABILITY</th> </tr> <tr> <th>FA</th><th>X</th><th>V</th><th>R</th><th>MXS</th><th>HH</th><th>EPFA</th><th>GPFAX</th><th>SFA</th><th>SFAHH</th><th>SV</th><th>SXR</th> </tr> </thead> <tbody> <tr> <td></td><td>✓</td><td>✓</td><td>✓</td><td>✓</td><td>✓</td><td>✓</td><td></td><td>✓</td><td>✓</td><td></td><td></td> </tr> </tbody> </table> <p>ALTA MOTORS ELECTRIC, APRILIA, BMW, DUCATI, GAS-GAS, GAS-GAS PIERER, HARLEY DAVIDSON, HUSABERG, HUSQVARNA, KTM, MAICO/M-STAR, ROYAL ENFIELD, SHERCO, TM RACING, TRIUMPH, VERTEMATI, VOR, YAMAHA, ZERO ELECTRIC BIKES, PIAGGIO</p>	MATERIAL AVAILABILITY												FA	X	V	R	MXS	HH	EPFA	GPFAX	SFA	SFAHH	SV	SXR		✓	✓	✓	✓	✓	✓		✓	✓		
MATERIAL AVAILABILITY																																						
FA	X	V	R	MXS	HH	EPFA	GPFAX	SFA	SFAHH	SV	SXR																											
	✓	✓	✓	✓	✓	✓		✓	✓																													
FA182 75 x 54 x 10mm		<table border="1"> <thead> <tr> <th colspan="12">MATERIAL AVAILABILITY</th> </tr> <tr> <th>FA</th><th>X</th><th>V</th><th>R</th><th>MXS</th><th>HH</th><th>EPFA</th><th>GPFAX</th><th>SFA</th><th>SFAHH</th><th>SV</th><th>SXR</th> </tr> </thead> <tbody> <tr> <td>✓</td><td></td><td></td><td></td><td></td><td>✓</td><td></td><td></td><td></td><td></td><td></td><td></td> </tr> </tbody> </table> <p>YAMAHA</p>	MATERIAL AVAILABILITY												FA	X	V	R	MXS	HH	EPFA	GPFAX	SFA	SFAHH	SV	SXR	✓					✓						
MATERIAL AVAILABILITY																																						
FA	X	V	R	MXS	HH	EPFA	GPFAX	SFA	SFAHH	SV	SXR																											
✓					✓																																	
FA184 30.5 x 46.5 x 7mm		<table border="1"> <thead> <tr> <th colspan="12">MATERIAL AVAILABILITY</th> </tr> <tr> <th>FA</th><th>X</th><th>V</th><th>R</th><th>MXS</th><th>HH</th><th>EPFA</th><th>GPFAX</th><th>SFA</th><th>SFAHH</th><th>SV</th><th>SXR</th> </tr> </thead> <tbody> <tr> <td>✓</td><td></td><td></td><td></td><td></td><td></td><td></td><td></td><td></td><td></td><td></td><td></td> </tr> </tbody> </table> <p>ISR AFTERMARKET CALIPER</p>	MATERIAL AVAILABILITY												FA	X	V	R	MXS	HH	EPFA	GPFAX	SFA	SFAHH	SV	SXR	✓											
MATERIAL AVAILABILITY																																						
FA	X	V	R	MXS	HH	EPFA	GPFAX	SFA	SFAHH	SV	SXR																											
✓																																						
FA185 94 x 33.5 x 7mm		<table border="1"> <thead> <tr> <th colspan="12">MATERIAL AVAILABILITY</th> </tr> <tr> <th>FA</th><th>X</th><th>V</th><th>R</th><th>MXS</th><th>HH</th><th>EPFA</th><th>GPFAX</th><th>SFA</th><th>SFAHH</th><th>SV</th><th>SXR</th> </tr> </thead> <tbody> <tr> <td></td><td>✓</td><td></td><td>✓</td><td>✓</td><td></td><td>✓</td><td></td><td></td><td></td><td></td><td></td> </tr> </tbody> </table> <p>APRILIA, BETA, GAS-GAS, HONDA, KAWASAKI, SUZUKI, YAMAHA, ZERO ELECTRIC BIKE</p>	MATERIAL AVAILABILITY												FA	X	V	R	MXS	HH	EPFA	GPFAX	SFA	SFAHH	SV	SXR		✓		✓	✓		✓					
MATERIAL AVAILABILITY																																						
FA	X	V	R	MXS	HH	EPFA	GPFAX	SFA	SFAHH	SV	SXR																											
	✓		✓	✓		✓																																
SFA186 31.5 x 51 x 5.5mm		<table border="1"> <thead> <tr> <th colspan="12">MATERIAL AVAILABILITY</th> </tr> <tr> <th>FA</th><th>X</th><th>V</th><th>R</th><th>MXS</th><th>HH</th><th>EPFA</th><th>GPFAX</th><th>SFA</th><th>SFAHH</th><th>SV</th><th>SXR</th> </tr> </thead> <tbody> <tr> <td></td><td></td><td></td><td></td><td></td><td></td><td></td><td></td><td>✓</td><td></td><td></td><td></td> </tr> </tbody> </table> <p>VESPA</p>	MATERIAL AVAILABILITY												FA	X	V	R	MXS	HH	EPFA	GPFAX	SFA	SFAHH	SV	SXR									✓			
MATERIAL AVAILABILITY																																						
FA	X	V	R	MXS	HH	EPFA	GPFAX	SFA	SFAHH	SV	SXR																											
								✓																														
FA187 68 x 54 x 8mm		<table border="1"> <thead> <tr> <th colspan="12">MATERIAL AVAILABILITY</th> </tr> <tr> <th>FA</th><th>X</th><th>V</th><th>R</th><th>MXS</th><th>HH</th><th>EPFA</th><th>GPFAX</th><th>SFA</th><th>SFAHH</th><th>SV</th><th>SXR</th> </tr> </thead> <tbody> <tr> <td>✓</td><td></td><td></td><td></td><td></td><td>✓</td><td>✓</td><td></td><td></td><td></td><td></td><td></td> </tr> </tbody> </table> <p>HONDA</p>	MATERIAL AVAILABILITY												FA	X	V	R	MXS	HH	EPFA	GPFAX	SFA	SFAHH	SV	SXR	✓					✓	✓					
MATERIAL AVAILABILITY																																						
FA	X	V	R	MXS	HH	EPFA	GPFAX	SFA	SFAHH	SV	SXR																											
✓					✓	✓																																
FA188 89.5 x 53 x 9mm		<table border="1"> <thead> <tr> <th colspan="12">MATERIAL AVAILABILITY</th> </tr> <tr> <th>FA</th><th>X</th><th>V</th><th>R</th><th>MXS</th><th>HH</th><th>EPFA</th><th>GPFAX</th><th>SFA</th><th>SFAHH</th><th>SV</th><th>SXR</th> </tr> </thead> <tbody> <tr> <td>✓</td><td></td><td></td><td></td><td></td><td>✓</td><td>✓</td><td></td><td></td><td></td><td></td><td></td> </tr> </tbody> </table> <p>KAWASAKI, SUZUKI</p>	MATERIAL AVAILABILITY												FA	X	V	R	MXS	HH	EPFA	GPFAX	SFA	SFAHH	SV	SXR	✓					✓	✓					
MATERIAL AVAILABILITY																																						
FA	X	V	R	MXS	HH	EPFA	GPFAX	SFA	SFAHH	SV	SXR																											
✓					✓	✓																																
FA189 125.5 x 44 x 9mm		<table border="1"> <thead> <tr> <th colspan="12">MATERIAL AVAILABILITY</th> </tr> <tr> <th>FA</th><th>X</th><th>V</th><th>R</th><th>MXS</th><th>HH</th><th>EPFA</th><th>GPFAX</th><th>SFA</th><th>SFAHH</th><th>SV</th><th>SXR</th> </tr> </thead> <tbody> <tr> <td>✓</td><td></td><td></td><td></td><td></td><td>✓</td><td></td><td></td><td></td><td></td><td></td><td></td> </tr> </tbody> </table> <p>HONDA</p>	MATERIAL AVAILABILITY												FA	X	V	R	MXS	HH	EPFA	GPFAX	SFA	SFAHH	SV	SXR	✓					✓						
MATERIAL AVAILABILITY																																						
FA	X	V	R	MXS	HH	EPFA	GPFAX	SFA	SFAHH	SV	SXR																											
✓					✓																																	
FA190 99 x 49.5 x 10mm		<table border="1"> <thead> <tr> <th colspan="12">MATERIAL AVAILABILITY</th> </tr> <tr> <th>FA</th><th>X</th><th>V</th><th>R</th><th>MXS</th><th>HH</th><th>EPFA</th><th>GPFAX</th><th>SFA</th><th>SFAHH</th><th>SV</th><th>SXR</th> </tr> </thead> <tbody> <tr> <td>✓</td><td></td><td></td><td></td><td></td><td>✓</td><td>✓</td><td></td><td></td><td></td><td></td><td></td> </tr> </tbody> </table> <p>PERFORMANCE MACHINE AFTERMARKET CALIPER, PRE TECH AFTERMARKET CALIPER, YAMAHA, TRIUMPH</p>	MATERIAL AVAILABILITY												FA	X	V	R	MXS	HH	EPFA	GPFAX	SFA	SFAHH	SV	SXR	✓					✓	✓					
MATERIAL AVAILABILITY																																						
FA	X	V	R	MXS	HH	EPFA	GPFAX	SFA	SFAHH	SV	SXR																											
✓					✓	✓																																
FA191 131.5 x 81 x 9.5mm		<table border="1"> <thead> <tr> <th colspan="12">MATERIAL AVAILABILITY</th> </tr> <tr> <th>FA</th><th>X</th><th>V</th><th>R</th><th>MXS</th><th>HH</th><th>EPFA</th><th>GPFAX</th><th>SFA</th><th>SFAHH</th><th>SV</th><th>SXR</th> </tr> </thead> <tbody> <tr> <td>✓</td><td></td><td></td><td></td><td></td><td></td><td></td><td></td><td></td><td></td><td></td><td></td> </tr> </tbody> </table> <p>YAMAHA</p>	MATERIAL AVAILABILITY												FA	X	V	R	MXS	HH	EPFA	GPFAX	SFA	SFAHH	SV	SXR	✓											
MATERIAL AVAILABILITY																																						
FA	X	V	R	MXS	HH	EPFA	GPFAX	SFA	SFAHH	SV	SXR																											
✓																																						

NOTE:- Size identification is shown as follows
Dimension 1=Width or Diameter, Dimension 2=Height or Diameter, Dimension 3=Thickness (Material and backplate)

FA192 A 89.5 x 51 x 8.5mm
B 68 x 52 x 9.5mm

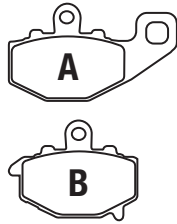

MATERIAL AVAILABILITY											
FA	X	V	R	MXS	HH	EPFA	GPFAX	SFA	SFAHH	SV	SXR
✓		✓			✓						

KAWASAKI, CF MOTO

SFA193 39.5 x 49.5 x 7mm



MATERIAL AVAILABILITY											
FA	X	V	R	MXS	HH	EPFA	GPFAX	SFA	SFAHH	SV	SXR
								✓	✓		

APRILIA, MALAGUTI, PIAGGIO, YAMAHA

FA194 A 94.5 x 42 x 7.5mm
B 77 x 42 x 7.5mm

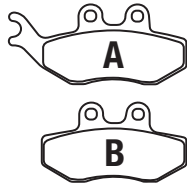

MATERIAL AVAILABILITY											
FA	X	V	R	MXS	HH	EPFA	GPFAX	SFA	SFAHH	SV	SXR
✓					✓			✓	✓		

AJP, APRILIA, BETA, GAS-GAS, SCORPA, VESPA, CPI, PEUGEOT, PIAGGIO

FA196 102 x 39 x 10mm

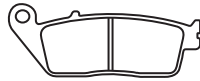

MATERIAL AVAILABILITY											
FA	X	V	R	MXS	HH	EPFA	GPFAX	SFA	SFAHH	SV	SXR
✓		✓			✓			✓	✓		

BMW, DAELIM, HONDA, INDIAN, KAWASAKI, KYMCO, LYNDALL BRAKES, TRIUMPH, VICTORY, YAMAHA

FA197 A 97 x 42 x 9mm
B 77.5 x 42 x 9mm

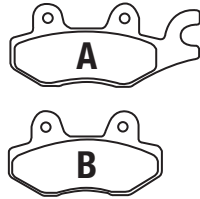

MATERIAL AVAILABILITY											
FA	X	V	R	MXS	HH	EPFA	GPFAX	SFA	SFAHH	SV	SXR
✓					✓	✓	✓	✓	✓		

DAELIM, HONDA, KAWASAKI, MZ, YAMAHA, YAMAHA, DAELIM, KYMCO, SUZUKI STREET, UM UNITED MOTORS

FA199 94 x 40.5 x 10mm



MATERIAL AVAILABILITY											
FA	X	V	R	MXS	HH	EPFA	GPFAX	SFA	SFAHH	SV	SXR
✓		✓			✓			✓	✓		

YAMAHA

FA200 103 x 62 x 11.5mm

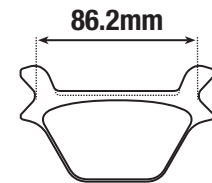

MATERIAL AVAILABILITY											
FA	X	V	R	MXS	HH	EPFA	GPFAX	SFA	SFAHH	SV	SXR
✓		✓			✓	✓					

HARLEY DAVIDSON, LYNDALL BRAKES

FA201 103 x 62 x 11.5mm

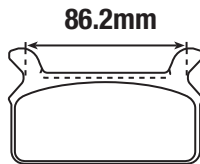

MATERIAL AVAILABILITY											
FA	X	V	R	MXS	HH	EPFA	GPFAX	SFA	SFAHH	SV	SXR
✓		✓									

HARLEY DAVIDSON, LYNDALL BRAKES

FA203 81 x 42 x 9.5mm



MATERIAL AVAILABILITY											
FA	X	V	R	MXS	HH	EPFA	GPFAX	SFA	SFAHH	SV	SXR
✓					✓						

HONDA

FA208 78 x 41 x 9mm



MATERIAL AVAILABILITY											
FA	X	V	R	MXS	HH	EPFA	GPFAX	SFA	SFAHH	SV	SXR
	✓		✓	✓		✓					

APRILIA, AJP, ATK, GAS-GAS, HUSABERG, HUSQVARNA, KTM, MAICO/M-STAR, ROYAL ENFIELD, T.M., YAMAHA, VERTEMATI, VOR, ZERO

FA209/2 108.5 x 40.5 x 7.5mm



MATERIAL AVAILABILITY

FA	X	V	R	MXS	HH	EPFA	GPFAX	SFA	SFAHH	SV	SXR
✓		✓			✓	✓		✓	✓		

APRILIA, BENELLI, BMW, DUCATI, HARLEY DAVIDSON, HARLEY DAVIDSON, HUSQVARNA, GAS GAS, INDIAN, KTM, LYNDALL BRAKES, MOTO GUZZI, ROYAL ENFIELD, TRIUMPH - USE FA209/2HH & FA209/2V ONLY, VICTORY, ZERO ELECTRIC

FA210 112 x 56.5 x 10mm



MATERIAL AVAILABILITY

FA	X	V	R	MXS	HH	EPFA	GPFAX	SFA	SFAHH	SV	SXR
✓											

BUELL, PERFORMANCE MACHINE CALIPERS

FA213 78 x 41.5 x 9mm



MATERIAL AVAILABILITY

FA	X	V	R	MXS	HH	EPFA	GPFAX	SFA	SFAHH	SV	SXR
✓		✓			✓	✓		✓	✓		

APRILIA, BMW, DUCATI, HARLEY DAVIDSON, HUSQVARNA, INDIAN, KTM, ROYAL ENFIELD, TRIUMPH, SFA213 - BMW, YAMAHA, ZERO ELECTRIC

FA214 A 96.5 x 43.5 x 7.5mm
B 77 x 43.5 x 8mm



MATERIAL AVAILABILITY - FA214

FA	X	V	R	MXS	HH	EPFA	GPFAX	SFA	SFAHH	SV	SXR
✓		✓			✓						

FA214/2 A 96.5 x 43.5 x 9.5mm
B 77 x 43.5 x 8mm



MATERIAL AVAILABILITY - FA214/2

FA	X	V	R	MXS	HH	EPFA	GPFAX	SFA	SFAHH	SV	SXR
✓		✓			✓						

FA214 - TRIUMPH, FA214/2- TRIUMPH

FA215 A 96.5 x 43.5 x 7.5mm
B 77 x 43.5 x 8mm



MATERIAL AVAILABILITY - FA215

FA	X	V	R	MXS	HH	EPFA	GPFAX	SFA	SFAHH	SV	SXR
✓		✓			✓						

FA215/2 A 96.5 x 43.5 x 9.5mm
B 77 x 43.5 x 8mm



MATERIAL AVAILABILITY - FA215/2

FA	X	V	R	MXS	HH	EPFA	GPFAX	SFA	SFAHH	SV	SXR
✓		✓			✓						

FA215 - TRIUMPH, FA215/2- TRIUMPH

FA216/2 69 x 50.5 x 10.5mm

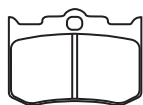

MATERIAL AVAILABILITY - FA216/2

FA	X	V	R	MXS	HH	EPFA	GPFAX	SFA	SFAHH	SV	SXR
✓					✓						

FA216/3 69 x 50.5 x 8mm

MATERIAL AVAILABILITY - FA216/3

FA	X	V	R	MXS	HH	EPFA	GPFAX	SFA	SFAHH	SV	SXR
✓		✓			✓						

FA216/2 - EBC AFTERMARKET CALIPER, PERFORMANCE MACHINE CALIPERS, FA216/3 - HHI - HAWG HALTERS AFTERMARKET CALIPERS, INDIAN, LYNDALL BRAKES, NOVA/LEGENDS AFTERMARKET CALIPER, PERFORMANCE MACHINE AFTERMARKET CALIPER, REVTECH AFTERMARKET CALIPER, THUNDERHEART AFTERMARKET CALIPER

FA218 77.5 x 40.5 x 9.5mm

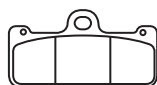

MATERIAL AVAILABILITY

FA	X	V	R	MXS	HH	EPFA	GPFAX	SFA	SFAHH	SV	SXR
					✓	✓					

BREMBO AFTERMARKET CALIPER

FA222 52.5 x 56.5 x 9mm

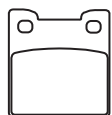

MATERIAL AVAILABILITY

FA	X	V	R	MXS	HH	EPFA	GPFAX	SFA	SFAHH	SV	SXR
✓											

SUZUKI,

FA226 102 x 39 x 9mm



MATERIAL AVAILABILITY

FA	X	V	R	MXS	HH	EPFA	GPFAX	SFA	SFAHH	SV	SXR
✓					✓	✓					

HONDA, KAWASAKI, TRIUMPH,

FA228 A 96.5 x 43.5 x 9mm
B 77.5 x 43.5 x 9mm

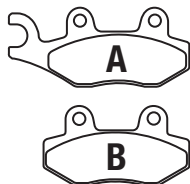

MATERIAL AVAILABILITY											
FA	X	V	R	MXS	HH	EPFA	GPFAX	SFA	SFAHH	SV	SXR
✓					✓			✓	✓		

MODEL, KAWASAKI, CF MOTO, KYMCO, SUZUKI, ROYAL ENFIELD, U.M.

FA229 A 133.5 x 37.5 x 8.5mm
B 110 x 44.5 x 8.5mm



MATERIAL AVAILABILITY											
FA	X	V	R	MXS	HH	EPFA	GPFAX	SFA	SFAHH	SV	SXR
✓		✓			✓	✓					

KAWASAKI

FA230 A 99 x 39.5 x 7.5mm
B 75 x 40.5 x 8mm

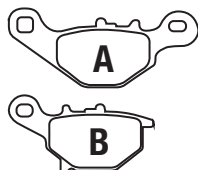

MATERIAL AVAILABILITY											
FA	X	V	R	MXS	HH	EPFA	GPFAX	SFA	SFAHH	SV	SXR
✓											

SUZUKI, KAWASAKI

FA231 A 133.5 x 37.5 x 8.5mm
B 110 x 44.5 x 8.5mm



FA231/2 A 133.5 x 37.5 x 10.5mm
B 110 x 44.5 x 10.5mm



FA231/3 A 133.5 x 37.5 x 11.5mm
B 110 x 44.5 x 11.5mm

MATERIAL AVAILABILITY - FA231											
FA	X	V	R	MXS	HH	EPFA	GPFAX	SFA	SFAHH	SV	SXR
✓		✓			✓	✓					

MATERIAL AVAILABILITY - FA231/2											
FA	X	V	R	MXS	HH	EPFA	GPFAX	SFA	SFAHH	SV	SXR
		✓									

MATERIAL AVAILABILITY - FA231/3											
FA	X	V	R	MXS	HH	EPFA	GPFAX	SFA	SFAHH	SV	SXR
		✓									

KAWASAKI, SUZUKI

★ = REAR FA231/2V @10.7mm (HH USE FA231HH)

▲ = REAR FA231/3V @ 11.4mm (HH USE FA231HH)

FA232 72.5 x 43.5 x 7mm

POLARIS All disc rear brake models - check application pages for main fitsments.
This pad has increased friction area. Can be fitted in place of FA178 to improve wear life on Polaris ATV's



MATERIAL AVAILABILITY											
FA	X	V	R	MXS	HH	EPFA	GPFAX	SFA	SFAHH	SV	SXR
		✓	✓	✓							

CF MOTO, E-TON QUADS, POLARIS

SFA233 75 x 37 x 9.5mm



MATERIAL AVAILABILITY											
FA	X	V	R	MXS	HH	EPFA	GPFAX	SFA	SFAHH	SV	SXR
								✓			

KYMCO

SFA235 60 x 44 x 9mm



MATERIAL AVAILABILITY											
FA	X	V	R	MXS	HH	EPFA	GPFAX	SFA	SFAHH	SV	SXR
								✓			

CPI, UM UNITED MOTORS

FA236 70 x 55 x 8.5mm



MATERIAL AVAILABILITY											
FA	X	V	R	MXS	HH	EPFA	GPFAX	SFA	SFAHH	SV	SXR
✓					✓						

TRIUMPH

FA239 69.5 x 52 x 8mm

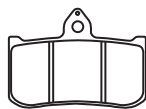

MATERIAL AVAILABILITY											
FA	X	V	R	MXS	HH	EPFA	GPFAX	SFA	SFAHH	SV	SXR
✓						✓					

HONDA RACE BIKES

FA243 98.5 x 49.5 x 8.5mm

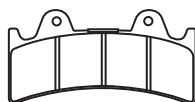

MATERIAL AVAILABILITY											
FA	X	V	R	MXS	HH	EPFA	GPFAX	SFA	SFAHH	SV	SXR
✓					✓						

JAYBRAKE CALIPERS

FA244 75 x 55 x 8.5mm		<table border="1"> <thead> <tr> <th colspan="12">MATERIAL AVAILABILITY</th> </tr> <tr> <th>FA</th><th>X</th><th>V</th><th>R</th><th>MXS</th><th>HH</th><th>EPFA</th><th>GPFAX</th><th>SFA</th><th>SFAHH</th><th>SV</th><th>SXR</th> </tr> </thead> <tbody> <tr> <td>✓</td><td></td><td>✓</td><td></td><td></td><td>✓</td><td>✓</td><td>✓</td><td></td><td></td><td></td><td></td> </tr> </tbody> </table> <p>ALTA MOTORS ELECTRIC, APRILIA, BREMBO AFTERMARKET CALIPER, BMW, CF MOTO, DUCATI, HUSQVARNA, KTM, LYNDALL BRAKES, MOTO GUZZI, MOTUS, MV AUGUSTA, VICTORY, ZERO ELECTRIC</p>	MATERIAL AVAILABILITY												FA	X	V	R	MXS	HH	EPFA	GPFAX	SFA	SFAHH	SV	SXR	✓		✓			✓	✓	✓				
MATERIAL AVAILABILITY																																						
FA	X	V	R	MXS	HH	EPFA	GPFAX	SFA	SFAHH	SV	SXR																											
✓		✓			✓	✓	✓																															
FA249 91.5 x 51.5 x 10mm		<table border="1"> <thead> <tr> <th colspan="12">MATERIAL AVAILABILITY</th> </tr> <tr> <th>FA</th><th>X</th><th>V</th><th>R</th><th>MXS</th><th>HH</th><th>EPFA</th><th>GPFAX</th><th>SFA</th><th>SFAHH</th><th>SV</th><th>SXR</th> </tr> </thead> <tbody> <tr> <td>✓</td><td></td><td></td><td></td><td></td><td>✓</td><td></td><td></td><td></td><td></td><td></td><td></td> </tr> </tbody> </table> <p>PRE TECH AFTERMARKET CALIPER, THUNDERHEART AFTERMARKET CALIPER</p>	MATERIAL AVAILABILITY												FA	X	V	R	MXS	HH	EPFA	GPFAX	SFA	SFAHH	SV	SXR	✓					✓						
MATERIAL AVAILABILITY																																						
FA	X	V	R	MXS	HH	EPFA	GPFAX	SFA	SFAHH	SV	SXR																											
✓					✓																																	
FA251 A 85 x 42.5 x 8mm B 55.5 x 37 x 10mm		<table border="1"> <thead> <tr> <th colspan="12">MATERIAL AVAILABILITY</th> </tr> <tr> <th>FA</th><th>X</th><th>V</th><th>R</th><th>MXS</th><th>HH</th><th>EPFA</th><th>GPFAX</th><th>SFA</th><th>SFAHH</th><th>SV</th><th>SXR</th> </tr> </thead> <tbody> <tr> <td>✓</td><td></td><td></td><td></td><td></td><td></td><td></td><td></td><td></td><td></td><td></td><td></td> </tr> </tbody> </table> <p>BUELL, HISUN, HUSQVARNA</p>	MATERIAL AVAILABILITY												FA	X	V	R	MXS	HH	EPFA	GPFAX	SFA	SFAHH	SV	SXR	✓											
MATERIAL AVAILABILITY																																						
FA	X	V	R	MXS	HH	EPFA	GPFAX	SFA	SFAHH	SV	SXR																											
✓																																						
FA252 69.5 x 51.5 x 8.5mm		<table border="1"> <thead> <tr> <th colspan="12">MATERIAL AVAILABILITY</th> </tr> <tr> <th>FA</th><th>X</th><th>V</th><th>R</th><th>MXS</th><th>HH</th><th>EPFA</th><th>GPFAX</th><th>SFA</th><th>SFAHH</th><th>SV</th><th>SXR</th> </tr> </thead> <tbody> <tr> <td>✓</td><td></td><td></td><td></td><td></td><td>✓</td><td>✓</td><td></td><td>✓</td><td>✓</td><td></td><td></td> </tr> </tbody> </table> <p>YAMAHA,</p>	MATERIAL AVAILABILITY												FA	X	V	R	MXS	HH	EPFA	GPFAX	SFA	SFAHH	SV	SXR	✓					✓	✓		✓	✓		
MATERIAL AVAILABILITY																																						
FA	X	V	R	MXS	HH	EPFA	GPFAX	SFA	SFAHH	SV	SXR																											
✓					✓	✓		✓	✓																													
FA254 60 x 57 x 8mm		<table border="1"> <thead> <tr> <th colspan="12">MATERIAL AVAILABILITY</th> </tr> <tr> <th>FA</th><th>X</th><th>V</th><th>R</th><th>MXS</th><th>HH</th><th>EPFA</th><th>GPFAX</th><th>SFA</th><th>SFAHH</th><th>SV</th><th>SXR</th> </tr> </thead> <tbody> <tr> <td>✓</td><td></td><td>✓</td><td></td><td></td><td>✓</td><td>✓</td><td></td><td></td><td></td><td></td><td></td> </tr> </tbody> </table> <p>BMW, HONDA, KAWASAKI, SUZUKI, MZ/MUZ</p>	MATERIAL AVAILABILITY												FA	X	V	R	MXS	HH	EPFA	GPFAX	SFA	SFAHH	SV	SXR	✓		✓			✓	✓					
MATERIAL AVAILABILITY																																						
FA	X	V	R	MXS	HH	EPFA	GPFAX	SFA	SFAHH	SV	SXR																											
✓		✓			✓	✓																																
FA256 78.5 x 47.5 x 7.5mm		<table border="1"> <thead> <tr> <th colspan="12">MATERIAL AVAILABILITY</th> </tr> <tr> <th>FA</th><th>X</th><th>V</th><th>R</th><th>MXS</th><th>HH</th><th>EPFA</th><th>GPFAX</th><th>SFA</th><th>SFAHH</th><th>SV</th><th>SXR</th> </tr> </thead> <tbody> <tr> <td>✓</td><td></td><td></td><td></td><td></td><td>✓</td><td></td><td></td><td>✓</td><td>✓</td><td></td><td></td> </tr> </tbody> </table> <p>APRILIA, MOTO GUZZI, APRILIA</p>	MATERIAL AVAILABILITY												FA	X	V	R	MXS	HH	EPFA	GPFAX	SFA	SFAHH	SV	SXR	✓					✓			✓	✓		
MATERIAL AVAILABILITY																																						
FA	X	V	R	MXS	HH	EPFA	GPFAX	SFA	SFAHH	SV	SXR																											
✓					✓			✓	✓																													
SFA257 41 x 43 x 7.5mm		<table border="1"> <thead> <tr> <th colspan="12">MATERIAL AVAILABILITY</th> </tr> <tr> <th>FA</th><th>X</th><th>V</th><th>R</th><th>MXS</th><th>HH</th><th>EPFA</th><th>GPFAX</th><th>SFA</th><th>SFAHH</th><th>SV</th><th>SXR</th> </tr> </thead> <tbody> <tr> <td></td><td></td><td></td><td></td><td></td><td></td><td></td><td></td><td>✓</td><td></td><td></td><td></td> </tr> </tbody> </table> <p>DAELIM</p>	MATERIAL AVAILABILITY												FA	X	V	R	MXS	HH	EPFA	GPFAX	SFA	SFAHH	SV	SXR									✓			
MATERIAL AVAILABILITY																																						
FA	X	V	R	MXS	HH	EPFA	GPFAX	SFA	SFAHH	SV	SXR																											
								✓																														
SFA257/2 41 x 43 x 5.5mm		<table border="1"> <thead> <tr> <th colspan="12">MATERIAL AVAILABILITY</th> </tr> <tr> <th>FA</th><th>X</th><th>V</th><th>R</th><th>MXS</th><th>HH</th><th>EPFA</th><th>GPFAX</th><th>SFA</th><th>SFAHH</th><th>SV</th><th>SXR</th> </tr> </thead> <tbody> <tr> <td></td><td></td><td></td><td></td><td></td><td></td><td></td><td></td><td>✓</td><td></td><td></td><td></td> </tr> </tbody> </table> <p>APRILIA, BMW, HONDA, KYMCO, PIAGGIO</p>	MATERIAL AVAILABILITY												FA	X	V	R	MXS	HH	EPFA	GPFAX	SFA	SFAHH	SV	SXR									✓			
MATERIAL AVAILABILITY																																						
FA	X	V	R	MXS	HH	EPFA	GPFAX	SFA	SFAHH	SV	SXR																											
								✓																														
FA258 A 119.5 x 26.5 x 7mm B 94.5 x 36 x 8mm		<table border="1"> <thead> <tr> <th colspan="12">MATERIAL AVAILABILITY</th> </tr> <tr> <th>FA</th><th>X</th><th>V</th><th>R</th><th>MXS</th><th>HH</th><th>EPFA</th><th>GPFAX</th><th>SFA</th><th>SFAHH</th><th>SV</th><th>SXR</th> </tr> </thead> <tbody> <tr> <td></td><td>✓</td><td></td><td>✓</td><td></td><td></td><td></td><td></td><td></td><td></td><td></td><td></td> </tr> </tbody> </table> <p>KAWASAKI, SUZUKI</p>	MATERIAL AVAILABILITY												FA	X	V	R	MXS	HH	EPFA	GPFAX	SFA	SFAHH	SV	SXR		✓		✓								
MATERIAL AVAILABILITY																																						
FA	X	V	R	MXS	HH	EPFA	GPFAX	SFA	SFAHH	SV	SXR																											
	✓		✓																																			
SFA260 35.5 x 49 x 6.5mm		<table border="1"> <thead> <tr> <th colspan="12">MATERIAL AVAILABILITY</th> </tr> <tr> <th>FA</th><th>X</th><th>V</th><th>R</th><th>MXS</th><th>HH</th><th>EPFA</th><th>GPFAX</th><th>SFA</th><th>SFAHH</th><th>SV</th><th>SXR</th> </tr> </thead> <tbody> <tr> <td></td><td></td><td></td><td></td><td></td><td></td><td></td><td></td><td>✓</td><td>✓</td><td></td><td></td> </tr> </tbody> </table> <p>CPI, PIAGGIO, VESPA</p>	MATERIAL AVAILABILITY												FA	X	V	R	MXS	HH	EPFA	GPFAX	SFA	SFAHH	SV	SXR									✓	✓		
MATERIAL AVAILABILITY																																						
FA	X	V	R	MXS	HH	EPFA	GPFAX	SFA	SFAHH	SV	SXR																											
								✓	✓																													
FA261 A 115 x 40.5 x 8.5mm B 115 x 40.5 x 8.5mm		<table border="1"> <thead> <tr> <th colspan="12">MATERIAL AVAILABILITY - FA261</th> </tr> <tr> <th>FA</th><th>X</th><th>V</th><th>R</th><th>MXS</th><th>HH</th><th>EPFA</th><th>GPFAX</th><th>SFA</th><th>SFAHH</th><th>SV</th><th>SXR</th> </tr> </thead> <tbody> <tr> <td></td><td></td><td>✓</td><td></td><td></td><td>✓</td><td>✓</td><td></td><td></td><td></td><td></td><td></td> </tr> </tbody> </table>	MATERIAL AVAILABILITY - FA261												FA	X	V	R	MXS	HH	EPFA	GPFAX	SFA	SFAHH	SV	SXR			✓			✓	✓					
MATERIAL AVAILABILITY - FA261																																						
FA	X	V	R	MXS	HH	EPFA	GPFAX	SFA	SFAHH	SV	SXR																											
		✓			✓	✓																																
FA261/2 A 115 x 40.5 x 10mm B 115 x 40.5 x 10mm		<table border="1"> <thead> <tr> <th colspan="12">MATERIAL AVAILABILITY - FA261/2</th> </tr> <tr> <th>FA</th><th>X</th><th>V</th><th>R</th><th>MXS</th><th>HH</th><th>EPFA</th><th>GPFAX</th><th>SFA</th><th>SFAHH</th><th>SV</th><th>SXR</th> </tr> </thead> <tbody> <tr> <td></td><td></td><td>✓</td><td></td><td></td><td>✓</td><td>✓</td><td></td><td></td><td></td><td></td><td></td> </tr> </tbody> </table> <p>FA261 - HONDA, VICTORY, FA261/2- HONDA</p>	MATERIAL AVAILABILITY - FA261/2												FA	X	V	R	MXS	HH	EPFA	GPFAX	SFA	SFAHH	SV	SXR			✓			✓	✓					
MATERIAL AVAILABILITY - FA261/2																																						
FA	X	V	R	MXS	HH	EPFA	GPFAX	SFA	SFAHH	SV	SXR																											
		✓			✓	✓																																

FA263 101 x 34.5 x 8.5mm

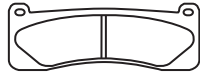

MATERIAL AVAILABILITY											
FA	X	V	R	MXS	HH	EPFA	GPFAX	SFA	SFAHH	SV	SXR
						✓					

AP/LOCKHEED AFTERMARKET CALIPER, PFM AFTERMARKET CALIPER

FA264 A 84.5 x 43.5 x 8mm
B 70 x 41 x 8mm

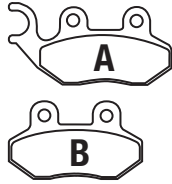

MATERIAL AVAILABILITY											
FA	X	V	R	MXS	HH	EPFA	GPFAX	SFA	SFAHH	SV	SXR
✓					✓			✓	✓		

DAELIM, E-TON, SYM, TGB SCOOTER, U.M.

FA265 75 x 55 x 8.5mm

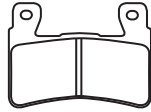

MATERIAL AVAILABILITY											
FA	X	V	R	MXS	HH	EPFA	GPFAX	SFA	SFAHH	SV	SXR
					✓	✓					

HONDA

FA266 51.5 x 54.5 x 7.5mm



MATERIAL AVAILABILITY											
FA	X	V	R	MXS	HH	EPFA	GPFAX	SFA	SFAHH	SV	SXR
✓		✓	✓		✓	✓		✓	✓		

APRILIA, BENELLI, BOMBARDIER, BREMBO AFTERMARKET CALIPER, CAGIVA, DERBI, DUCATI, ENERGIKA ELECTRIC, GOGORO, HARLEY DAVIDSON, HONDA, INDIAN, KAWASAKI, KTM, MOTO GUZZI, MOTUS, MV, PIAGGIO

FA267 52 x 60 x 9mm



MATERIAL AVAILABILITY											
FA	X	V	R	MXS	HH	EPFA	GPFAX	SFA	SFAHH	SV	SXR
✓					✓						

YAMAHA

SFA268 46 x 53 x 6.5mm



MATERIAL AVAILABILITY											
FA	X	V	R	MXS	HH	EPFA	GPFAX	SFA	SFAHH	SV	SXR
								✓	✓		

YAMAHA

FA270 73 x 52.5 x 7mm

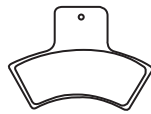

MATERIAL AVAILABILITY											
FA	X	V	R	MXS	HH	EPFA	GPFAX	SFA	SFAHH	SV	SXR
	✓		✓							✓	

POLARIS

FA271 68 x 45 x 8mm



MATERIAL AVAILABILITY											
FA	X	V	R	MXS	HH	EPFA	GPFAX	SFA	SFAHH	SV	SXR
	✓		✓							✓	

ARCTIC CAT

FA272 40 x 44.5 x 7mm



MATERIAL AVAILABILITY											
FA	X	V	R	MXS	HH	EPFA	GPFAX	SFA	SFAHH	SV	SXR
✓											

AP LOCKHEED CALIPERS

FA273 50.5 x 60.5 x 12.5mm



MATERIAL AVAILABILITY											
FA	X	V	R	MXS	HH	EPFA	GPFAX	SFA	SFAHH	SV	SXR
✓			✓								









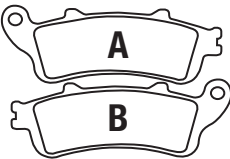

POLARIS

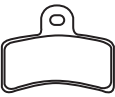
FA275 100 x 31 x 9mm

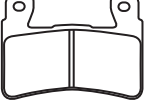

MATERIAL AVAILABILITY											
FA	X	V	R	MXS	HH	EPFA	GPFAX	SFA	SFAHH	SV	SXR
✓	✓				✓			✓			

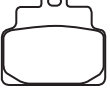
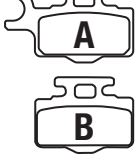
YAMAHA

FA281 115 x 40.5 x 9.5mm		<table border="1"> <thead> <tr> <th colspan="12">MATERIAL AVAILABILITY</th> </tr> <tr> <th>FA</th><th>X</th><th>V</th><th>R</th><th>MXS</th><th>HH</th><th>EPFA</th><th>GPFAX</th><th>SFA</th><th>SFAHH</th><th>SV</th><th>SXR</th> </tr> </thead> <tbody> <tr> <td></td><td></td><td></td><td></td><td></td><td>✓</td><td></td><td></td><td>✓</td><td>✓</td><td></td><td></td> </tr> </tbody> </table>	MATERIAL AVAILABILITY												FA	X	V	R	MXS	HH	EPFA	GPFAX	SFA	SFAHH	SV	SXR						✓			✓	✓		
MATERIAL AVAILABILITY																																						
FA	X	V	R	MXS	HH	EPFA	GPFAX	SFA	SFAHH	SV	SXR																											
					✓			✓	✓																													
		KAWASAKI, HONDA																																				
SFA283/4 44.5 x 53.5 x 8.5mm		<table border="1"> <thead> <tr> <th colspan="12">MATERIAL AVAILABILITY</th> </tr> <tr> <th>FA</th><th>X</th><th>V</th><th>R</th><th>MXS</th><th>HH</th><th>EPFA</th><th>GPFAX</th><th>SFA</th><th>SFAHH</th><th>SV</th><th>SXR</th> </tr> </thead> <tbody> <tr> <td></td><td></td><td></td><td></td><td></td><td></td><td></td><td></td><td>✓</td><td>✓</td><td></td><td></td> </tr> </tbody> </table>	MATERIAL AVAILABILITY												FA	X	V	R	MXS	HH	EPFA	GPFAX	SFA	SFAHH	SV	SXR									✓	✓		
MATERIAL AVAILABILITY																																						
FA	X	V	R	MXS	HH	EPFA	GPFAX	SFA	SFAHH	SV	SXR																											
								✓	✓																													
		SUZUKI																																				
FA291 57 x 43.5 x 6.5mm		<table border="1"> <thead> <tr> <th colspan="12">MATERIAL AVAILABILITY</th> </tr> <tr> <th>FA</th><th>X</th><th>V</th><th>R</th><th>MXS</th><th>HH</th><th>EPFA</th><th>GPFAX</th><th>SFA</th><th>SFAHH</th><th>SV</th><th>SXR</th> </tr> </thead> <tbody> <tr> <td></td><td>✓</td><td></td><td></td><td></td><td></td><td></td><td></td><td></td><td></td><td></td><td></td> </tr> </tbody> </table>	MATERIAL AVAILABILITY												FA	X	V	R	MXS	HH	EPFA	GPFAX	SFA	SFAHH	SV	SXR		✓										
MATERIAL AVAILABILITY																																						
FA	X	V	R	MXS	HH	EPFA	GPFAX	SFA	SFAHH	SV	SXR																											
	✓																																					
		GAS-GAS																																				
FA293 22 x 6mm		<table border="1"> <thead> <tr> <th colspan="12">MATERIAL AVAILABILITY</th> </tr> <tr> <th>FA</th><th>X</th><th>V</th><th>R</th><th>MXS</th><th>HH</th><th>EPFA</th><th>GPFAX</th><th>SFA</th><th>SFAHH</th><th>SV</th><th>SXR</th> </tr> </thead> <tbody> <tr> <td>✓</td><td></td><td></td><td></td><td></td><td></td><td></td><td></td><td></td><td></td><td></td><td></td> </tr> </tbody> </table>	MATERIAL AVAILABILITY												FA	X	V	R	MXS	HH	EPFA	GPFAX	SFA	SFAHH	SV	SXR	✓											
MATERIAL AVAILABILITY																																						
FA	X	V	R	MXS	HH	EPFA	GPFAX	SFA	SFAHH	SV	SXR																											
✓																																						
		POLINI CALIPERS																																				
FA294 81 x 46 x 7.5mm		<table border="1"> <thead> <tr> <th colspan="12">MATERIAL AVAILABILITY</th> </tr> <tr> <th>FA</th><th>X</th><th>V</th><th>R</th><th>MXS</th><th>HH</th><th>EPFA</th><th>GPFAX</th><th>SFA</th><th>SFAHH</th><th>SV</th><th>SXR</th> </tr> </thead> <tbody> <tr> <td></td><td></td><td></td><td></td><td></td><td>✓</td><td>✓</td><td></td><td></td><td></td><td></td><td></td> </tr> </tbody> </table>	MATERIAL AVAILABILITY												FA	X	V	R	MXS	HH	EPFA	GPFAX	SFA	SFAHH	SV	SXR						✓	✓					
MATERIAL AVAILABILITY																																						
FA	X	V	R	MXS	HH	EPFA	GPFAX	SFA	SFAHH	SV	SXR																											
					✓	✓																																
		BMW																																				
EPFA295HH 77.5 x 42.5 x 8.5mm		<table border="1"> <thead> <tr> <th colspan="12">MATERIAL AVAILABILITY</th> </tr> <tr> <th>FA</th><th>X</th><th>V</th><th>R</th><th>MXS</th><th>HH</th><th>EPFA</th><th>GPFAX</th><th>SFA</th><th>SFAHH</th><th>SV</th><th>SXR</th> </tr> </thead> <tbody> <tr> <td></td><td></td><td></td><td></td><td></td><td></td><td>✓</td><td>✓</td><td></td><td></td><td></td><td></td> </tr> </tbody> </table>	MATERIAL AVAILABILITY												FA	X	V	R	MXS	HH	EPFA	GPFAX	SFA	SFAHH	SV	SXR							✓	✓				
MATERIAL AVAILABILITY																																						
FA	X	V	R	MXS	HH	EPFA	GPFAX	SFA	SFAHH	SV	SXR																											
						✓	✓																															
		BREMBO																																				
FA296 75 x 55 x 7.5mm		<table border="1"> <thead> <tr> <th colspan="12">MATERIAL AVAILABILITY</th> </tr> <tr> <th>FA</th><th>X</th><th>V</th><th>R</th><th>MXS</th><th>HH</th><th>EPFA</th><th>GPFAX</th><th>SFA</th><th>SFAHH</th><th>SV</th><th>SXR</th> </tr> </thead> <tbody> <tr> <td></td><td></td><td></td><td></td><td></td><td>✓</td><td>✓</td><td>✓</td><td></td><td></td><td></td><td></td> </tr> </tbody> </table>	MATERIAL AVAILABILITY												FA	X	V	R	MXS	HH	EPFA	GPFAX	SFA	SFAHH	SV	SXR						✓	✓	✓				
MATERIAL AVAILABILITY																																						
FA	X	V	R	MXS	HH	EPFA	GPFAX	SFA	SFAHH	SV	SXR																											
					✓	✓	✓																															
		HARLEY DAVIDSON, HONDA, HYOSUNG, KAWASAKI																																				
FA298 51 x 54 x 9.5mm		<table border="1"> <thead> <tr> <th colspan="12">MATERIAL AVAILABILITY</th> </tr> <tr> <th>FA</th><th>X</th><th>V</th><th>R</th><th>MXS</th><th>HH</th><th>EPFA</th><th>GPFAX</th><th>SFA</th><th>SFAHH</th><th>SV</th><th>SXR</th> </tr> </thead> <tbody> <tr> <td>✓</td><td></td><td></td><td></td><td></td><td></td><td></td><td></td><td>✓</td><td>✓</td><td></td><td></td> </tr> </tbody> </table>	MATERIAL AVAILABILITY												FA	X	V	R	MXS	HH	EPFA	GPFAX	SFA	SFAHH	SV	SXR	✓								✓	✓		
MATERIAL AVAILABILITY																																						
FA	X	V	R	MXS	HH	EPFA	GPFAX	SFA	SFAHH	SV	SXR																											
✓								✓	✓																													
		APRILIA, BETA, MALAGUTI																																				
SFA301 54 x 51 x 8mm		<table border="1"> <thead> <tr> <th colspan="12">MATERIAL AVAILABILITY</th> </tr> <tr> <th>FA</th><th>X</th><th>V</th><th>R</th><th>MXS</th><th>HH</th><th>EPFA</th><th>GPFAX</th><th>SFA</th><th>SFAHH</th><th>SV</th><th>SXR</th> </tr> </thead> <tbody> <tr> <td></td><td></td><td></td><td></td><td></td><td></td><td></td><td></td><td>✓</td><td>✓</td><td></td><td></td> </tr> </tbody> </table>	MATERIAL AVAILABILITY												FA	X	V	R	MXS	HH	EPFA	GPFAX	SFA	SFAHH	SV	SXR									✓	✓		
MATERIAL AVAILABILITY																																						
FA	X	V	R	MXS	HH	EPFA	GPFAX	SFA	SFAHH	SV	SXR																											
								✓	✓																													
		APRILIA																																				
FA302 A 67.5 x 40 x 7.5mm B 52 x 40 x 7.5mm		<table border="1"> <thead> <tr> <th colspan="12">MATERIAL AVAILABILITY</th> </tr> <tr> <th>FA</th><th>X</th><th>V</th><th>R</th><th>MXS</th><th>HH</th><th>EPFA</th><th>GPFAX</th><th>SFA</th><th>SFAHH</th><th>SV</th><th>SXR</th> </tr> </thead> <tbody> <tr> <td></td><td>✓</td><td></td><td>✓</td><td>✓</td><td></td><td></td><td></td><td></td><td></td><td></td><td></td> </tr> </tbody> </table>	MATERIAL AVAILABILITY												FA	X	V	R	MXS	HH	EPFA	GPFAX	SFA	SFAHH	SV	SXR		✓		✓	✓							
MATERIAL AVAILABILITY																																						
FA	X	V	R	MXS	HH	EPFA	GPFAX	SFA	SFAHH	SV	SXR																											
	✓		✓	✓																																		
		KAWASAKI, SUZUKI																																				
FA303 50 x 44 x 6mm		<table border="1"> <thead> <tr> <th colspan="12">MATERIAL AVAILABILITY</th> </tr> <tr> <th>FA</th><th>X</th><th>V</th><th>R</th><th>MXS</th><th>HH</th><th>EPFA</th><th>GPFAX</th><th>SFA</th><th>SFAHH</th><th>SV</th><th>SXR</th> </tr> </thead> <tbody> <tr> <td></td><td>✓</td><td></td><td></td><td></td><td></td><td></td><td></td><td></td><td></td><td></td><td></td> </tr> </tbody> </table>	MATERIAL AVAILABILITY												FA	X	V	R	MXS	HH	EPFA	GPFAX	SFA	SFAHH	SV	SXR		✓										
MATERIAL AVAILABILITY																																						
FA	X	V	R	MXS	HH	EPFA	GPFAX	SFA	SFAHH	SV	SXR																											
	✓																																					
		BETA, GAS-GAS, MONTESSA, SCORPA, SHERCO																																				

FA304 75 x 53.5 x 9mm

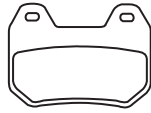

MATERIAL AVAILABILITY											
FA	X	V	R	MXS	HH	EPFA	GPFAX	SFA	SFAHH	SV	SXR
✓					✓						

BMW

FA305 A 85 x 43 x 8.5mm
B 64 x 37 x 10mm

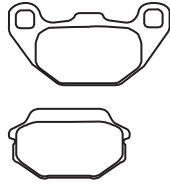

MATERIAL AVAILABILITY											
FA	X	V	R	MXS	HH	EPFA	GPFAX	SFA	SFAHH	SV	SXR
✓			✓					✓	✓		

ARCTIC CAT, KAWASAKI, KYMCO, SYM

SFA306 70 x 42 x 8mm



MATERIAL AVAILABILITY											
FA	X	V	R	MXS	HH	EPFA	GPFAX	SFA	SFAHH	SV	SXR
								✓			

SYM

FA307 A 82 x 41 x 9.5mm
B 62 x 41 x 9.5mm

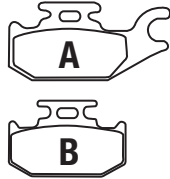

MATERIAL AVAILABILITY											
FA	X	V	R	MXS	HH	EPFA	GPFAX	SFA	SFAHH	SV	SXR
	✓		✓							✓	✓

BOMBARDIER/BRP, CAN-AM, JOHN DEERE ATV, YAMAHA

FA313 124 x 55 x 9.5mm



MATERIAL AVAILABILITY											
FA	X	V	R	MXS	HH	EPFA	GPFAX	SFA	SFAHH	SV	SXR
			✓							✓	

POLARIS

FA314 90.5 x 41.5 x 8mm



MATERIAL AVAILABILITY											
FA	X	V	R	MXS	HH	EPFA	GPFAX	SFA	SFAHH	SV	SXR
			✓							✓	

POLARIS

FA317 A 82 x 41 x 9.5mm
B 62 x 41 x 9.5mm

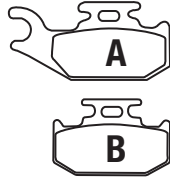

MATERIAL AVAILABILITY											
FA	X	V	R	MXS	HH	EPFA	GPFAX	SFA	SFAHH	SV	SXR
	✓		✓							✓	✓

BOMBARDIER/BRP, CAN-AM, CF MOTO, JOHN DEERE, SUZUKI

SFA319 100 x 38.5 x 12mm
FA319/2 100 x 38.5 x 9.5mm



MATERIAL AVAILABILITY - SFA319											
FA	X	V	R	MXS	HH	EPFA	GPFAX	SFA	SFAHH	SV	SXR
								✓	✓		
MATERIAL AVAILABILITY - FA319/2											
FA	X	V	R	MXS	HH	EPFA	GPFAX	SFA	SFAHH	SV	SXR
✓		✓			✓			✓			

SFA319 - YAMAHA, FA319/2 - YAMAHA

FA320 70 x 43 x 7.5mm



MATERIAL AVAILABILITY											
FA	X	V	R	MXS	HH	EPFA	GPFAX	SFA	SFAHH	SV	SXR
					✓						

MV

SFA321 55.5 x 49 x 7.5mm



MATERIAL AVAILABILITY											
FA	X	V	R	MXS	HH	EPFA	GPFAX	SFA	SFAHH	SV	SXR
✓								✓	✓		

PIAGGIO, VESPA

FA322/4 35 x 40.5 x 7.5mm



MATERIAL AVAILABILITY

FA	X	V	R	MXS	HH	EPFA	GPFAX	SFA	SFAHH	SV	SXR
					✓	✓					

APRILIA, BENELLI, BREMBO AFTERMARKET CALIPER, DUCATI, HUSQVARNA, KTM, MOTO GUZZI, MOTUS, MV, SHERCO, TM, TRIUMPH

FA323 81.5 x 42 x 9mm



MATERIAL AVAILABILITY

FA	X	V	R	MXS	HH	EPFA	GPFAX	SFA	SFAHH	SV	SXR
	✓		✓					✓	✓		

YAMAHA, SFA323 - HONDA, U.M.

SFA324 117.5 x 41.5 x 8.5mm



MATERIAL AVAILABILITY

FA	X	V	R	MXS	HH	EPFA	GPFAX	SFA	SFAHH	SV	SXR
								✓	✓		

APRILIA, KYMCO

FA325 43.5 x 25 x 5mm



MATERIAL AVAILABILITY

FA	X	V	R	MXS	HH	EPFA	GPFAX	SFA	SFAHH	SV	SXR
	✓		✓								

COBRA, GAS-GAS PIERER, KTM, LEM

CFA327 30.5 x 35 x 4mm



MATERIAL AVAILABILITY

FA	X	V	R	MXS	HH	EPFA	GPFAX	SFA	SFAHH	SV	SXR
✓			✓		✓						

BETA, PIAGGIO

FA335 77.5 x 51.5 x 8.5mm

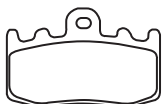

MATERIAL AVAILABILITY

FA	X	V	R	MXS	HH	EPFA	GPFAX	SFA	SFAHH	SV	SXR
					✓	✓					

BMW

FA337 36 x 52 x 6mm



MATERIAL AVAILABILITY

FA	X	V	R	MXS	HH	EPFA	GPFAX	SFA	SFAHH	SV	SXR
	✓		✓								

KTM

FA342 A 119.5 x 26.5 x 7mm
B 94.5 x 36 x 8mm

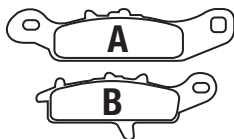

MATERIAL AVAILABILITY

FA	X	V	R	MXS	HH	EPFA	GPFAX	SFA	SFAHH	SV	SXR
			✓								

KAWASAKI, SUZUKI

FA343 A 107 x 42.5 x 10mm
B 91.5 x 40 x 10mm

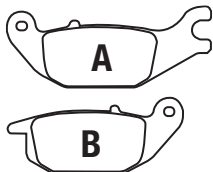

MATERIAL AVAILABILITY

FA	X	V	R	MXS	HH	EPFA	GPFAX	SFA	SFAHH	SV	SXR
✓					✓						

HONDA, YAMAHA, CF MOTO

FA344 65.5 x 44.5 x 11.5mm



MATERIAL AVAILABILITY

FA	X	V	R	MXS	HH	EPFA	GPFAX	SFA	SFAHH	SV	SXR
	✓		✓							✓	

BENNCHE, CF MOTO, UNISON, YAMAHA

FA345 91.5 x 49.5 x 8mm



MATERIAL AVAILABILITY

FA	X	V	R	MXS	HH	EPFA	GPFAX	SFA	SFAHH	SV	SXR
					✓	✓					

BUELL

FA346 60 x 44 x 11mm

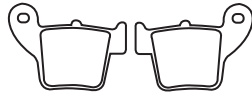

MATERIAL AVAILABILITY											
FA	X	V	R	MXS	HH	EPFA	GPFAX	SFA	SFAHH	SV	SXR
	✓		✓	✓		✓					

HONDA, KAYO

FA347 69.5 x 49.5 x 7mm

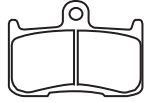

MATERIAL AVAILABILITY											
FA	X	V	R	MXS	HH	EPFA	GPFAX	SFA	SFAHH	SV	SXR
					✓	✓	✓				

HONDA, INDIAN, KAWASAKI, MORIWAKI/HONDA, SUZUKI, TRIUMPH, VICTORY, YAMAHA RACING

FA348 64 x 60.5 x 9mm



MATERIAL AVAILABILITY											
FA	X	V	R	MXS	HH	EPFA	GPFAX	SFA	SFAHH	SV	SXR
✓					✓						

YAMAHA

FA349 A 119.5 x 26.5 x 7mm
B 94.5 x 36 x 8mm

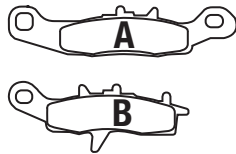

MATERIAL AVAILABILITY											
FA	X	V	R	MXS	HH	EPFA	GPFAX	SFA	SFAHH	SV	SXR
			✓							✓	

KAWASAKI, SUZUKI

FA350 50 x 47.5 x 7mm



MATERIAL AVAILABILITY											
FA	X	V	R	MXS	HH	EPFA	GPFAX	SFA	SFAHH	SV	SXR
	✓							✓	✓		

SCORPA, ITALJET, PEUGEOT

FA351 36 x 39.5 x 6mm



MATERIAL AVAILABILITY											
FA	X	V	R	MXS	HH	EPFA	GPFAX	SFA	SFAHH	SV	SXR
	✓										

BETA DIRT BIKES, GAS-GAS, HUSQVARNA, MONTESSA, SCORPA, SHERCO

SFA353 A 97 x 41.5 x 9.5mm
B 77 x 41.5 x 9.5mm

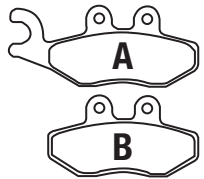

MATERIAL AVAILABILITY											
FA	X	V	R	MXS	HH	EPFA	GPFAX	SFA	SFAHH	SV	SXR
								✓	✓		

APRILIA, PIAGGIO, VESPA

FA354 97 x 51 x 7mm

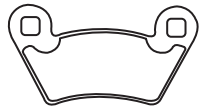

MATERIAL AVAILABILITY											
FA	X	V	R	MXS	HH	EPFA	GPFAX	SFA	SFAHH	SV	SXR
			✓							✓	✓

POLARIS

FA355/4 44.5 x 51 x 7mm



MATERIAL AVAILABILITY											
FA	X	V	R	MXS	HH	EPFA	GPFAX	SFA	SFAHH	SV	SXR
	✓		✓					✓	✓		

ARCTIC CAT, KYMCO, SYM

SFA356 55.5 x 46 x 7mm



MATERIAL AVAILABILITY											
FA	X	V	R	MXS	HH	EPFA	GPFAX	SFA	SFAHH	SV	SXR
								✓	✓		













KYMCO

FA357 A 62 x 31.5 x 6.5mm



MATERIAL AVAILABILITY											
FA	X	V	R	MXS	HH	EPFA	GPFAX	SFA	SFAHH	SV	SXR
	✓		✓								

HUSQVARNA, KTM

SFA358 86 x 40 x 9mm		<table border="1"> <thead> <tr> <th colspan="12">MATERIAL AVAILABILITY</th> </tr> <tr> <th>FA</th><th>X</th><th>V</th><th>R</th><th>MXS</th><th>HH</th><th>EPFA</th><th>GPFAX</th><th>SFA</th><th>SFAHH</th><th>SV</th><th>SXR</th> </tr> </thead> <tbody> <tr> <td></td><td></td><td></td><td></td><td></td><td></td><td></td><td></td><td>✓</td><td>✓</td><td></td><td></td> </tr> </tbody> </table>	MATERIAL AVAILABILITY												FA	X	V	R	MXS	HH	EPFA	GPFAX	SFA	SFAHH	SV	SXR									✓	✓																																						
MATERIAL AVAILABILITY																																																																										
FA	X	V	R	MXS	HH	EPFA	GPFAX	SFA	SFAHH	SV	SXR																																																															
								✓	✓																																																																	
		HONDA																																																																								
FA363 A 94 x 36.5 x 8.5mm B 94 x 36.5 x 10mm		<table border="1"> <thead> <tr> <th colspan="12">MATERIAL AVAILABILITY</th> </tr> <tr> <th>FA</th><th>X</th><th>V</th><th>R</th><th>MXS</th><th>HH</th><th>EPFA</th><th>GPFAX</th><th>SFA</th><th>SFAHH</th><th>SV</th><th>SXR</th> </tr> </thead> <tbody> <tr> <td>✓</td><td></td><td>✓</td><td></td><td></td><td>✓</td><td></td><td></td><td></td><td></td><td></td><td></td> </tr> </tbody> </table>	MATERIAL AVAILABILITY												FA	X	V	R	MXS	HH	EPFA	GPFAX	SFA	SFAHH	SV	SXR	✓		✓			✓																																										
MATERIAL AVAILABILITY																																																																										
FA	X	V	R	MXS	HH	EPFA	GPFAX	SFA	SFAHH	SV	SXR																																																															
✓		✓			✓																																																																					
		BMW																																																																								
FA366 70 x 46 x 13mm		<table border="1"> <thead> <tr> <th colspan="12">MATERIAL AVAILABILITY</th> </tr> <tr> <th>FA</th><th>X</th><th>V</th><th>R</th><th>MXS</th><th>HH</th><th>EPFA</th><th>GPFAX</th><th>SFA</th><th>SFAHH</th><th>SV</th><th>SXR</th> </tr> </thead> <tbody> <tr> <td>✓</td><td></td><td>✓</td><td></td><td></td><td>✓</td><td></td><td></td><td></td><td></td><td></td><td></td> </tr> </tbody> </table>	MATERIAL AVAILABILITY												FA	X	V	R	MXS	HH	EPFA	GPFAX	SFA	SFAHH	SV	SXR	✓		✓			✓																																										
MATERIAL AVAILABILITY																																																																										
FA	X	V	R	MXS	HH	EPFA	GPFAX	SFA	SFAHH	SV	SXR																																																															
✓		✓			✓																																																																					
		SUZUKI																																																																								
FA367 67 x 36 x 11mm FA367/2 67 x 36 x 8.5mm		<table border="1"> <thead> <tr> <th colspan="12">MATERIAL AVAILABILITY - FA367</th> </tr> <tr> <th>FA</th><th>X</th><th>V</th><th>R</th><th>MXS</th><th>HH</th><th>EPFA</th><th>GPFAX</th><th>SFA</th><th>SFAHH</th><th>SV</th><th>SXR</th> </tr> </thead> <tbody> <tr> <td></td><td>✓</td><td></td><td>✓</td><td>✓</td><td></td><td>✓</td><td></td><td></td><td></td><td></td><td></td> </tr> </tbody> </table> <table border="1"> <thead> <tr> <th colspan="12">MATERIAL AVAILABILITY - FA367/2</th> </tr> <tr> <th>FA</th><th>X</th><th>V</th><th>R</th><th>MXS</th><th>HH</th><th>EPFA</th><th>GPFAX</th><th>SFA</th><th>SFAHH</th><th>SV</th><th>SXR</th> </tr> </thead> <tbody> <tr> <td></td><td>✓</td><td></td><td>✓</td><td></td><td></td><td></td><td></td><td></td><td></td><td></td><td></td> </tr> </tbody> </table> <p data-bbox="878 768 1490 810">FA367 - AJP, APRILIA, BETA, GAS-GAS, KAWASAKI, SHERCO, SUZUKI, TM, YAMAHA, FA367/2 - BETA,</p>	MATERIAL AVAILABILITY - FA367												FA	X	V	R	MXS	HH	EPFA	GPFAX	SFA	SFAHH	SV	SXR		✓		✓	✓		✓						MATERIAL AVAILABILITY - FA367/2												FA	X	V	R	MXS	HH	EPFA	GPFAX	SFA	SFAHH	SV	SXR		✓		✓								
MATERIAL AVAILABILITY - FA367																																																																										
FA	X	V	R	MXS	HH	EPFA	GPFAX	SFA	SFAHH	SV	SXR																																																															
	✓		✓	✓		✓																																																																				
MATERIAL AVAILABILITY - FA367/2																																																																										
FA	X	V	R	MXS	HH	EPFA	GPFAX	SFA	SFAHH	SV	SXR																																																															
	✓		✓																																																																							
FA368 A 64 x 42 x 9mm		<table border="1"> <thead> <tr> <th colspan="12">MATERIAL AVAILABILITY</th> </tr> <tr> <th>FA</th><th>X</th><th>V</th><th>R</th><th>MXS</th><th>HH</th><th>EPFA</th><th>GPFAX</th><th>SFA</th><th>SFAHH</th><th>SV</th><th>SXR</th> </tr> </thead> <tbody> <tr> <td></td><td>✓</td><td></td><td>✓</td><td>✓</td><td></td><td>✓</td><td></td><td></td><td></td><td></td><td></td> </tr> </tbody> </table> <p data-bbox="878 947 1490 999">ALTA MOTORS ELECTIC, BMW, GAS-GAS PIERER, HUSABERG, HUSQVARNA, KTM, SHERCO, STARK ELECTRIC</p>	MATERIAL AVAILABILITY												FA	X	V	R	MXS	HH	EPFA	GPFAX	SFA	SFAHH	SV	SXR		✓		✓	✓		✓																																									
MATERIAL AVAILABILITY																																																																										
FA	X	V	R	MXS	HH	EPFA	GPFAX	SFA	SFAHH	SV	SXR																																																															
	✓		✓	✓		✓																																																																				
FA369/4 38.5 x 49.5 x 8mm		<table border="1"> <thead> <tr> <th colspan="12">MATERIAL AVAILABILITY</th> </tr> <tr> <th>FA</th><th>X</th><th>V</th><th>R</th><th>MXS</th><th>HH</th><th>EPFA</th><th>GPFAX</th><th>SFA</th><th>SFAHH</th><th>SV</th><th>SXR</th> </tr> </thead> <tbody> <tr> <td></td><td></td><td></td><td></td><td></td><td>✓</td><td>✓</td><td></td><td></td><td></td><td></td><td></td> </tr> </tbody> </table>	MATERIAL AVAILABILITY												FA	X	V	R	MXS	HH	EPFA	GPFAX	SFA	SFAHH	SV	SXR						✓	✓																																									
MATERIAL AVAILABILITY																																																																										
FA	X	V	R	MXS	HH	EPFA	GPFAX	SFA	SFAHH	SV	SXR																																																															
					✓	✓																																																																				
		KAWASAKI, SUZUKI																																																																								
FA372 A 85 x 42.5 x 8.5mm B 55.5 x 37 x 11mm	 	<table border="1"> <thead> <tr> <th colspan="12">MATERIAL AVAILABILITY</th> </tr> <tr> <th>FA</th><th>X</th><th>V</th><th>R</th><th>MXS</th><th>HH</th><th>EPFA</th><th>GPFAX</th><th>SFA</th><th>SFAHH</th><th>SV</th><th>SXR</th> </tr> </thead> <tbody> <tr> <td></td><td>✓</td><td></td><td>✓</td><td></td><td></td><td></td><td></td><td></td><td></td><td></td><td></td> </tr> </tbody> </table>	MATERIAL AVAILABILITY												FA	X	V	R	MXS	HH	EPFA	GPFAX	SFA	SFAHH	SV	SXR		✓		✓																																												
MATERIAL AVAILABILITY																																																																										
FA	X	V	R	MXS	HH	EPFA	GPFAX	SFA	SFAHH	SV	SXR																																																															
	✓		✓																																																																							
		SUZUKI																																																																								
FA373 75 x 39.5 x 11.5mm		<table border="1"> <thead> <tr> <th colspan="12">MATERIAL AVAILABILITY</th> </tr> <tr> <th>FA</th><th>X</th><th>V</th><th>R</th><th>MXS</th><th>HH</th><th>EPFA</th><th>GPFAX</th><th>SFA</th><th>SFAHH</th><th>SV</th><th>SXR</th> </tr> </thead> <tbody> <tr> <td></td><td>✓</td><td></td><td>✓</td><td></td><td></td><td></td><td></td><td></td><td></td><td>✓</td><td></td> </tr> </tbody> </table>	MATERIAL AVAILABILITY												FA	X	V	R	MXS	HH	EPFA	GPFAX	SFA	SFAHH	SV	SXR		✓		✓							✓																																					
MATERIAL AVAILABILITY																																																																										
FA	X	V	R	MXS	HH	EPFA	GPFAX	SFA	SFAHH	SV	SXR																																																															
	✓		✓							✓																																																																
		HONDA																																																																								
FA375 A 111 x 36 x 7.5mm B 98.5 x 33 x 7.5mm	 	<table border="1"> <thead> <tr> <th colspan="12">MATERIAL AVAILABILITY</th> </tr> <tr> <th>FA</th><th>X</th><th>V</th><th>R</th><th>MXS</th><th>HH</th><th>EPFA</th><th>GPFAX</th><th>SFA</th><th>SFAHH</th><th>SV</th><th>SXR</th> </tr> </thead> <tbody> <tr> <td>✓</td><td></td><td></td><td></td><td></td><td>✓</td><td></td><td></td><td>✓</td><td></td><td></td><td></td> </tr> </tbody> </table>	MATERIAL AVAILABILITY												FA	X	V	R	MXS	HH	EPFA	GPFAX	SFA	SFAHH	SV	SXR	✓					✓			✓																																							
MATERIAL AVAILABILITY																																																																										
FA	X	V	R	MXS	HH	EPFA	GPFAX	SFA	SFAHH	SV	SXR																																																															
✓					✓			✓																																																																		
		HONDA																																																																								
FA377 A 94 x 47 x 8.5mm B 73 x 47 x 11mm	 	<table border="1"> <thead> <tr> <th colspan="12">MATERIAL AVAILABILITY</th> </tr> <tr> <th>FA</th><th>X</th><th>V</th><th>R</th><th>MXS</th><th>HH</th><th>EPFA</th><th>GPFAX</th><th>SFA</th><th>SFAHH</th><th>SV</th><th>SXR</th> </tr> </thead> <tbody> <tr> <td>✓</td><td>✓</td><td>✓</td><td>✓</td><td></td><td>✓</td><td></td><td></td><td></td><td></td><td></td><td></td> </tr> </tbody> </table> <p data-bbox="878 1839 1490 1881">ARCTIC CAT, BOMBARDIER, CAN-AM, KAWASAKI, KYMCO, MASSIMO, SYM, TGB</p>	MATERIAL AVAILABILITY												FA	X	V	R	MXS	HH	EPFA	GPFAX	SFA	SFAHH	SV	SXR	✓	✓	✓	✓		✓																																										
MATERIAL AVAILABILITY																																																																										
FA	X	V	R	MXS	HH	EPFA	GPFAX	SFA	SFAHH	SV	SXR																																																															
✓	✓	✓	✓		✓																																																																					

FA379 71.5 x 50.5 x 8mm

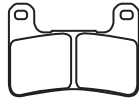

MATERIAL AVAILABILITY											
FA	X	V	R	MXS	HH	EPFA	GPFAX	SFA	SFAHH	SV	SXR
					✓	✓	✓				

KAWASAKI, SUZUKI

FA380 69.5 x 51.5 x 8.5mm



MATERIAL AVAILABILITY											
FA	X	V	R	MXS	HH	EPFA	GPFAX	SFA	SFAHH	SV	SXR
					✓	✓	✓				

KAWASAKI, YAMAHA

FA381 102 x 45.5 x 11mm

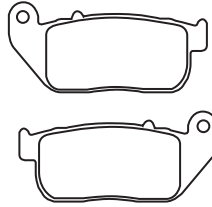

MATERIAL AVAILABILITY											
FA	X	V	R	MXS	HH	EPFA	GPFAX	SFA	SFAHH	SV	SXR
✓		✓			✓	✓					

HARLEY DAVIDSON

SFA384 A 99 x 41 x 8mm
B 77 x 41 x 8mm

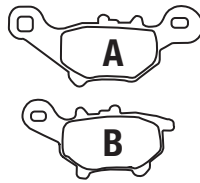

MATERIAL AVAILABILITY											
FA	X	V	R	MXS	HH	EPFA	GPFAX	SFA	SFAHH	SV	SXR
✓					✓			✓			

YAMAHA TWIN HEADLIGHTS, YAMAHA SINGLE HEADLIGHTS

FA387 86.5 x 44.5 x 10.5mm

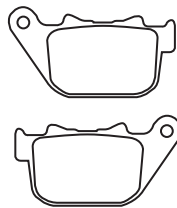

MATERIAL AVAILABILITY											
FA	X	V	R	MXS	HH	EPFA	GPFAX	SFA	SFAHH	SV	SXR
✓		✓			✓	✓					

HARLEY DAVIDSON, LYNDALL BRAKES

FA388 118 x 45 x 8.5mm
FA388/2 118 x 45 x 10.5mm

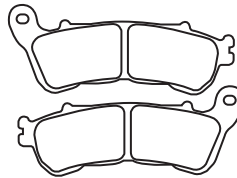

MATERIAL AVAILABILITY - FA388											
FA	X	V	R	MXS	HH	EPFA	GPFAX	SFA	SFAHH	SV	SXR
✓					✓	✓		✓	✓		

MATERIAL AVAILABILITY - FA388/2											
FA	X	V	R	MXS	HH	EPFA	GPFAX	SFA	SFAHH	SV	SXR
		✓			✓						

HONDA, SUZUKI, FA388/2 - HONDA

FA390 74.5 x 47 x 8mm

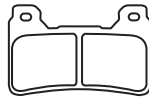

MATERIAL AVAILABILITY											
FA	X	V	R	MXS	HH	EPFA	GPFAX	SFA	SFAHH	SV	SXR
					✓	✓	✓				

HONDA

FA395 94.5 x 45.5 x 7mm



MATERIAL AVAILABILITY											
FA	X	V	R	MXS	HH	EPFA	GPFAX	SFA	SFAHH	SV	SXR
	✓		✓							✓	✓

ARCTIC CAT, KYMCO, POLARIS

FA398 95.5 x 40 x 7mm



MATERIAL AVAILABILITY											
FA	X	V	R	MXS	HH	EPFA	GPFAX	SFA	SFAHH	SV	SXR
			✓							✓	





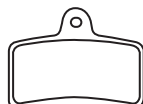

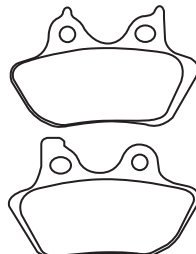
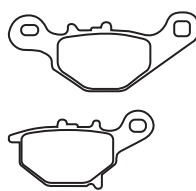

CAN-AM, JOHN DEERE

FA399 69.5 x 51.5 x 7mm

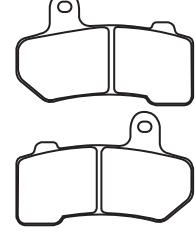

MATERIAL AVAILABILITY											
FA	X	V	R	MXS	HH	EPFA	GPFAX	SFA	SFAHH	SV	SXR
✓											

DERBI

<p>FA400 98 x 64 x 8mm HH = 7.5mm thickness</p>		<table border="1"> <thead> <tr> <th colspan="12">MATERIAL AVAILABILITY</th> </tr> <tr> <th>FA</th><th>X</th><th>V</th><th>R</th><th>MXS</th><th>HH</th><th>EPFA</th><th>GPFAX</th><th>SFA</th><th>SFAHH</th><th>SV</th><th>SXR</th> </tr> </thead> <tbody> <tr> <td>✓</td><td></td><td>✓</td><td></td><td></td><td>✓</td><td>✓</td><td></td><td></td><td></td><td></td><td></td> </tr> </tbody> </table> <p>HARLEY DAVIDSON</p>	MATERIAL AVAILABILITY												FA	X	V	R	MXS	HH	EPFA	GPFAX	SFA	SFAHH	SV	SXR	✓		✓			✓	✓					
MATERIAL AVAILABILITY																																						
FA	X	V	R	MXS	HH	EPFA	GPFAX	SFA	SFAHH	SV	SXR																											
✓		✓			✓	✓																																
<p>FA401 A 99 x 40 x 7.5mm B 75.5 x 40.5 x 8mm</p>		<table border="1"> <thead> <tr> <th colspan="12">MATERIAL AVAILABILITY</th> </tr> <tr> <th>FA</th><th>X</th><th>V</th><th>R</th><th>MXS</th><th>HH</th><th>EPFA</th><th>GPFAX</th><th>SFA</th><th>SFAHH</th><th>SV</th><th>SXR</th> </tr> </thead> <tbody> <tr> <td></td><td>✓</td><td></td><td>✓</td><td></td><td></td><td></td><td></td><td></td><td></td><td></td><td></td> </tr> </tbody> </table> <p>SUZUKI</p>	MATERIAL AVAILABILITY												FA	X	V	R	MXS	HH	EPFA	GPFAX	SFA	SFAHH	SV	SXR		✓		✓								
MATERIAL AVAILABILITY																																						
FA	X	V	R	MXS	HH	EPFA	GPFAX	SFA	SFAHH	SV	SXR																											
	✓		✓																																			
<p>FA403 41 x 44.5 x 6.5mm</p>		<table border="1"> <thead> <tr> <th colspan="12">MATERIAL AVAILABILITY</th> </tr> <tr> <th>FA</th><th>X</th><th>V</th><th>R</th><th>MXS</th><th>HH</th><th>EPFA</th><th>GPFAX</th><th>SFA</th><th>SFAHH</th><th>SV</th><th>SXR</th> </tr> </thead> <tbody> <tr> <td></td><td>✓</td><td></td><td></td><td></td><td></td><td></td><td></td><td></td><td></td><td></td><td></td> </tr> </tbody> </table> <p>BETA</p>	MATERIAL AVAILABILITY												FA	X	V	R	MXS	HH	EPFA	GPFAX	SFA	SFAHH	SV	SXR		✓										
MATERIAL AVAILABILITY																																						
FA	X	V	R	MXS	HH	EPFA	GPFAX	SFA	SFAHH	SV	SXR																											
	✓																																					
<p>FA405 76.5 x 49.5 x 8mm</p>		<table border="1"> <thead> <tr> <th colspan="12">MATERIAL AVAILABILITY</th> </tr> <tr> <th>FA</th><th>X</th><th>V</th><th>R</th><th>MXS</th><th>HH</th><th>EPFA</th><th>GPFAX</th><th>SFA</th><th>SFAHH</th><th>SV</th><th>SXR</th> </tr> </thead> <tbody> <tr> <td></td><td></td><td></td><td></td><td>✓</td><td></td><td>✓</td><td></td><td></td><td></td><td></td><td></td> </tr> </tbody> </table> <p>APRILIA, FTE AFTERMARKET CALIPER, HUSABERG, KTM</p>	MATERIAL AVAILABILITY												FA	X	V	R	MXS	HH	EPFA	GPFAX	SFA	SFAHH	SV	SXR					✓		✓					
MATERIAL AVAILABILITY																																						
FA	X	V	R	MXS	HH	EPFA	GPFAX	SFA	SFAHH	SV	SXR																											
				✓		✓																																
<p>FA406 102 x 49.5 x 8mm</p>		<table border="1"> <thead> <tr> <th colspan="12">MATERIAL AVAILABILITY</th> </tr> <tr> <th>FA</th><th>X</th><th>V</th><th>R</th><th>MXS</th><th>HH</th><th>EPFA</th><th>GPFAX</th><th>SFA</th><th>SFAHH</th><th>SV</th><th>SXR</th> </tr> </thead> <tbody> <tr> <td>✓</td><td></td><td></td><td></td><td>✓</td><td></td><td>✓</td><td></td><td></td><td></td><td></td><td></td> </tr> </tbody> </table> <p>HUSABERG, FTE AFTERMARKET CALIPER</p>	MATERIAL AVAILABILITY												FA	X	V	R	MXS	HH	EPFA	GPFAX	SFA	SFAHH	SV	SXR	✓				✓		✓					
MATERIAL AVAILABILITY																																						
FA	X	V	R	MXS	HH	EPFA	GPFAX	SFA	SFAHH	SV	SXR																											
✓				✓		✓																																
<p>FA407 100 x 56.5 x 8.5mm</p>		<table border="1"> <thead> <tr> <th colspan="12">MATERIAL AVAILABILITY</th> </tr> <tr> <th>FA</th><th>X</th><th>V</th><th>R</th><th>MXS</th><th>HH</th><th>EPFA</th><th>GPFAX</th><th>SFA</th><th>SFAHH</th><th>SV</th><th>SXR</th> </tr> </thead> <tbody> <tr> <td>✓</td><td></td><td></td><td></td><td></td><td>✓</td><td>✓</td><td></td><td></td><td></td><td></td><td></td> </tr> </tbody> </table> <p>BMW</p>	MATERIAL AVAILABILITY												FA	X	V	R	MXS	HH	EPFA	GPFAX	SFA	SFAHH	SV	SXR	✓					✓	✓					
MATERIAL AVAILABILITY																																						
FA	X	V	R	MXS	HH	EPFA	GPFAX	SFA	SFAHH	SV	SXR																											
✓					✓	✓																																
<p>SFA408 100 x 38.5 x 16mm</p>		<table border="1"> <thead> <tr> <th colspan="12">MATERIAL AVAILABILITY</th> </tr> <tr> <th>FA</th><th>X</th><th>V</th><th>R</th><th>MXS</th><th>HH</th><th>EPFA</th><th>GPFAX</th><th>SFA</th><th>SFAHH</th><th>SV</th><th>SXR</th> </tr> </thead> <tbody> <tr> <td></td><td></td><td></td><td></td><td></td><td></td><td></td><td></td><td>✓</td><td>✓</td><td></td><td></td> </tr> </tbody> </table> <p>YAMAHA</p>	MATERIAL AVAILABILITY												FA	X	V	R	MXS	HH	EPFA	GPFAX	SFA	SFAHH	SV	SXR									✓	✓		
MATERIAL AVAILABILITY																																						
FA	X	V	R	MXS	HH	EPFA	GPFAX	SFA	SFAHH	SV	SXR																											
								✓	✓																													
<p>FA409 92 x 58.5 x 7mm</p>		<table border="1"> <thead> <tr> <th colspan="12">MATERIAL AVAILABILITY</th> </tr> <tr> <th>FA</th><th>X</th><th>V</th><th>R</th><th>MXS</th><th>HH</th><th>EPFA</th><th>GPFAX</th><th>SFA</th><th>SFAHH</th><th>SV</th><th>SXR</th> </tr> </thead> <tbody> <tr> <td>✓</td><td></td><td>✓</td><td></td><td></td><td>✓</td><td>✓</td><td></td><td></td><td></td><td></td><td></td> </tr> </tbody> </table> <p>HARLEY DAVIDSON, LYNDALL BRAKES</p>	MATERIAL AVAILABILITY												FA	X	V	R	MXS	HH	EPFA	GPFAX	SFA	SFAHH	SV	SXR	✓		✓			✓	✓					
MATERIAL AVAILABILITY																																						
FA	X	V	R	MXS	HH	EPFA	GPFAX	SFA	SFAHH	SV	SXR																											
✓		✓			✓	✓																																
<p>FA410 82 x 38.5 x 10mm</p>		<table border="1"> <thead> <tr> <th colspan="12">MATERIAL AVAILABILITY</th> </tr> <tr> <th>FA</th><th>X</th><th>V</th><th>R</th><th>MXS</th><th>HH</th><th>EPFA</th><th>GPFAX</th><th>SFA</th><th>SFAHH</th><th>SV</th><th>SXR</th> </tr> </thead> <tbody> <tr> <td></td><td>✓</td><td></td><td>✓</td><td></td><td></td><td></td><td></td><td></td><td></td><td>✓</td><td></td> </tr> </tbody> </table> <p>HONDA</p>	MATERIAL AVAILABILITY												FA	X	V	R	MXS	HH	EPFA	GPFAX	SFA	SFAHH	SV	SXR		✓		✓							✓	
MATERIAL AVAILABILITY																																						
FA	X	V	R	MXS	HH	EPFA	GPFAX	SFA	SFAHH	SV	SXR																											
	✓		✓							✓																												
<p>SFA411 81 x 42 x 8.5mm</p>		<table border="1"> <thead> <tr> <th colspan="12">MATERIAL AVAILABILITY</th> </tr> <tr> <th>FA</th><th>X</th><th>V</th><th>R</th><th>MXS</th><th>HH</th><th>EPFA</th><th>GPFAX</th><th>SFA</th><th>SFAHH</th><th>SV</th><th>SXR</th> </tr> </thead> <tbody> <tr> <td></td><td></td><td></td><td></td><td></td><td></td><td></td><td></td><td>✓</td><td>✓</td><td></td><td></td> </tr> </tbody> </table> <p>SUZUKI</p>	MATERIAL AVAILABILITY												FA	X	V	R	MXS	HH	EPFA	GPFAX	SFA	SFAHH	SV	SXR									✓	✓		
MATERIAL AVAILABILITY																																						
FA	X	V	R	MXS	HH	EPFA	GPFAX	SFA	SFAHH	SV	SXR																											
								✓	✓																													

SFA412 88 x 46.5 x 8.5mm

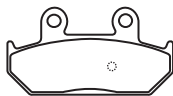

MATERIAL AVAILABILITY											
FA	X	V	R	MXS	HH	EPFA	GPFAX	SFA	SFAHH	SV	SXR
								✓	✓		

SUZUKI

FA413 A 82.5 x 41 x 8.5mm
B 62 x 41 x 8.5mm

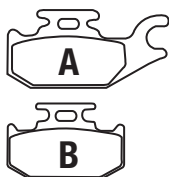

MATERIAL AVAILABILITY											
FA	X	V	R	MXS	HH	EPFA	GPFAX	SFA	SFAHH	SV	SXR
	✓		✓					✓	✓	✓	

SUZUKI

FA414 A 82.5 x 41 x 8.5mm
B 62 x 41 x 8.5mm

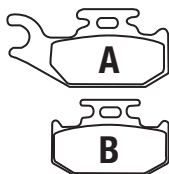

MATERIAL AVAILABILITY											
FA	X	V	R	MXS	HH	EPFA	GPFAX	SFA	SFAHH	SV	SXR
	✓		✓							✓	

SUZUKI

SFA415 81.5 x 37.5 x 9mm



MATERIAL AVAILABILITY											
FA	X	V	R	MXS	HH	EPFA	GPFAX	SFA	SFAHH	SV	SXR
								✓	✓		

HONDA

FA417/4 38 x 50 x 8mm



MATERIAL AVAILABILITY											
FA	X	V	R	MXS	HH	EPFA	GPFAX	SFA	SFAHH	SV	SXR
					✓	✓	✓				

KAWASAKI

SFA418 A 97 x 41.5 x 9.5mm
B 77 x 41.5 x 9.5mm

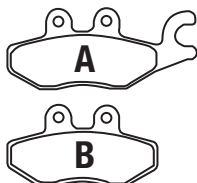

MATERIAL AVAILABILITY											
FA	X	V	R	MXS	HH	EPFA	GPFAX	SFA	SFAHH	SV	SXR
								✓	✓		

PIAGGIO

FA419 A 89 x 40.5 x 9.5mm
B 89 x 40.5 x 9.5mm

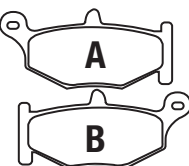

MATERIAL AVAILABILITY											
FA	X	V	R	MXS	HH	EPFA	GPFAX	SFA	SFAHH	SV	SXR
✓		✓			✓						

SUZUKI

FA420 69.5 x 54.5 x 8mm

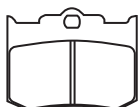

MATERIAL AVAILABILITY											
FA	X	V	R	MXS	HH	EPFA	GPFAX	SFA	SFAHH	SV	SXR
					✓						

PERFORMANCE MACHINE CALIPERS

FA423/4 45.5 x 53.5 x 8.5mm

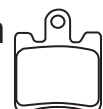

MATERIAL AVAILABILITY											
FA	X	V	R	MXS	HH	EPFA	GPFAX	SFA	SFAHH	SV	SXR
					✓						

TRIUMPH, YAMAHA

FA424 91.5 x 51.5 x 8mm

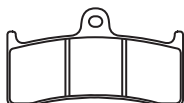

MATERIAL AVAILABILITY											
FA	X	V	R	MXS	HH	EPFA	GPFAX	SFA	SFAHH	SV	SXR
✓					✓						

KAWASAKI, LYNDALL BRAKES, MV, YAMAHA

SFA425 55.5 x 54.5 x 8mm



MATERIAL AVAILABILITY											
FA	X	V	R	MXS	HH	EPFA	GPFAX	SFA	SFAHH	SV	SXR
								✓	✓		

PIAGGIO

SFA427 94 x 36 x 10mm		<table border="1"> <thead> <tr> <th colspan="12">MATERIAL AVAILABILITY</th> </tr> <tr> <th>FA</th><th>X</th><th>V</th><th>R</th><th>MXS</th><th>HH</th><th>EPFA</th><th>GPFAX</th><th>SFA</th><th>SFAHH</th><th>SV</th><th>SXR</th> </tr> </thead> <tbody> <tr> <td></td><td></td><td></td><td></td><td></td><td></td><td></td><td></td><td>✓</td><td>✓</td><td></td><td></td> </tr> </tbody> </table>	MATERIAL AVAILABILITY												FA	X	V	R	MXS	HH	EPFA	GPFAX	SFA	SFAHH	SV	SXR									✓	✓		
MATERIAL AVAILABILITY																																						
FA	X	V	R	MXS	HH	EPFA	GPFAX	SFA	SFAHH	SV	SXR																											
								✓	✓																													
		SYM																																				
SFA428 A 82 x 41 x 9.5mm B 62 x 41 x 9.5mm		<table border="1"> <thead> <tr> <th colspan="12">MATERIAL AVAILABILITY</th> </tr> <tr> <th>FA</th><th>X</th><th>V</th><th>R</th><th>MXS</th><th>HH</th><th>EPFA</th><th>GPFAX</th><th>SFA</th><th>SFAHH</th><th>SV</th><th>SXR</th> </tr> </thead> <tbody> <tr> <td></td><td>✓</td><td></td><td></td><td>✓</td><td></td><td></td><td></td><td></td><td></td><td>✓</td><td></td> </tr> </tbody> </table>	MATERIAL AVAILABILITY												FA	X	V	R	MXS	HH	EPFA	GPFAX	SFA	SFAHH	SV	SXR		✓			✓						✓	
MATERIAL AVAILABILITY																																						
FA	X	V	R	MXS	HH	EPFA	GPFAX	SFA	SFAHH	SV	SXR																											
	✓			✓						✓																												
		BENNCHE, HISUN, MASSIMO, YAMAHA																																				
FA432 68.5 x 55.5 x 9mm		<table border="1"> <thead> <tr> <th colspan="12">MATERIAL AVAILABILITY</th> </tr> <tr> <th>FA</th><th>X</th><th>V</th><th>R</th><th>MXS</th><th>HH</th><th>EPFA</th><th>GPFAX</th><th>SFA</th><th>SFAHH</th><th>SV</th><th>SXR</th> </tr> </thead> <tbody> <tr> <td>✓</td><td></td><td></td><td></td><td></td><td>✓</td><td></td><td></td><td>✓</td><td>✓</td><td></td><td></td> </tr> </tbody> </table>	MATERIAL AVAILABILITY												FA	X	V	R	MXS	HH	EPFA	GPFAX	SFA	SFAHH	SV	SXR	✓					✓			✓	✓		
MATERIAL AVAILABILITY																																						
FA	X	V	R	MXS	HH	EPFA	GPFAX	SFA	SFAHH	SV	SXR																											
✓					✓			✓	✓																													
		APRILIA, SFA432 - KYMCO																																				
FA433/4 35 x 46 x 7.5mm		<table border="1"> <thead> <tr> <th colspan="12">MATERIAL AVAILABILITY</th> </tr> <tr> <th>FA</th><th>X</th><th>V</th><th>R</th><th>MXS</th><th>HH</th><th>EPFA</th><th>GPFAX</th><th>SFA</th><th>SFAHH</th><th>SV</th><th>SXR</th> </tr> </thead> <tbody> <tr> <td>✓</td><td></td><td></td><td></td><td></td><td>✓</td><td>✓</td><td></td><td></td><td></td><td></td><td></td> </tr> </tbody> </table>	MATERIAL AVAILABILITY												FA	X	V	R	MXS	HH	EPFA	GPFAX	SFA	SFAHH	SV	SXR	✓					✓	✓					
MATERIAL AVAILABILITY																																						
FA	X	V	R	MXS	HH	EPFA	GPFAX	SFA	SFAHH	SV	SXR																											
✓					✓	✓																																
		HUSABERG, KTM, MAGURA AFTERMARKET CALIPER																																				
FA434 A 98 x 64 x 8mm B 98 x 64 x 8mm		<table border="1"> <thead> <tr> <th colspan="12">MATERIAL AVAILABILITY</th> </tr> <tr> <th>FA</th><th>X</th><th>V</th><th>R</th><th>MXS</th><th>HH</th><th>EPFA</th><th>GPFAX</th><th>SFA</th><th>SFAHH</th><th>SV</th><th>SXR</th> </tr> </thead> <tbody> <tr> <td>✓</td><td></td><td>✓</td><td></td><td></td><td>✓</td><td></td><td></td><td></td><td></td><td></td><td></td> </tr> </tbody> </table>	MATERIAL AVAILABILITY												FA	X	V	R	MXS	HH	EPFA	GPFAX	SFA	SFAHH	SV	SXR	✓		✓			✓						
MATERIAL AVAILABILITY																																						
FA	X	V	R	MXS	HH	EPFA	GPFAX	SFA	SFAHH	SV	SXR																											
✓		✓			✓																																	
		HARLEY DAVIDSON, LYNDALL BRAKES																																				
FA435/4 43.5 x 49 x 9.5mm		<table border="1"> <thead> <tr> <th colspan="12">MATERIAL AVAILABILITY</th> </tr> <tr> <th>FA</th><th>X</th><th>V</th><th>R</th><th>MXS</th><th>HH</th><th>EPFA</th><th>GPFAX</th><th>SFA</th><th>SFAHH</th><th>SV</th><th>SXR</th> </tr> </thead> <tbody> <tr> <td></td><td></td><td></td><td></td><td></td><td>✓</td><td>✓</td><td>✓</td><td></td><td></td><td></td><td></td> </tr> </tbody> </table>	MATERIAL AVAILABILITY												FA	X	V	R	MXS	HH	EPFA	GPFAX	SFA	SFAHH	SV	SXR						✓	✓	✓				
MATERIAL AVAILABILITY																																						
FA	X	V	R	MXS	HH	EPFA	GPFAX	SFA	SFAHH	SV	SXR																											
					✓	✓	✓																															
		AP/LOCKHEED AFTERMARKET CALIPER, BREMBO AFTERMARKET CALIPER, MV, PVM AFTERMARKET CALIPER																																				
FA436 77.5 x 42 x 9mm		<table border="1"> <thead> <tr> <th colspan="12">MATERIAL AVAILABILITY</th> </tr> <tr> <th>FA</th><th>X</th><th>V</th><th>R</th><th>MXS</th><th>HH</th><th>EPFA</th><th>GPFAX</th><th>SFA</th><th>SFAHH</th><th>SV</th><th>SXR</th> </tr> </thead> <tbody> <tr> <td>✓</td><td></td><td>✓</td><td></td><td></td><td>✓</td><td></td><td></td><td></td><td></td><td></td><td></td> </tr> </tbody> </table>	MATERIAL AVAILABILITY												FA	X	V	R	MXS	HH	EPFA	GPFAX	SFA	SFAHH	SV	SXR	✓		✓			✓						
MATERIAL AVAILABILITY																																						
FA	X	V	R	MXS	HH	EPFA	GPFAX	SFA	SFAHH	SV	SXR																											
✓		✓			✓																																	
		HONDA, KAWASAKI, SUZUKI, YAMAHA																																				
FA438 A 103 x 36.5 x 8.5mm B 94 x 36.5 x 8.5mm		<table border="1"> <thead> <tr> <th colspan="12">MATERIAL AVAILABILITY</th> </tr> <tr> <th>FA</th><th>X</th><th>V</th><th>R</th><th>MXS</th><th>HH</th><th>EPFA</th><th>GPFAX</th><th>SFA</th><th>SFAHH</th><th>SV</th><th>SXR</th> </tr> </thead> <tbody> <tr> <td></td><td></td><td></td><td></td><td></td><td>✓</td><td></td><td></td><td></td><td></td><td></td><td></td> </tr> </tbody> </table>	MATERIAL AVAILABILITY												FA	X	V	R	MXS	HH	EPFA	GPFAX	SFA	SFAHH	SV	SXR						✓						
MATERIAL AVAILABILITY																																						
FA	X	V	R	MXS	HH	EPFA	GPFAX	SFA	SFAHH	SV	SXR																											
					✓																																	
		BMW																																				
FA441 77 x 51.5 x 8.5mm		<table border="1"> <thead> <tr> <th colspan="12">MATERIAL AVAILABILITY</th> </tr> <tr> <th>FA</th><th>X</th><th>V</th><th>R</th><th>MXS</th><th>HH</th><th>EPFA</th><th>GPFAX</th><th>SFA</th><th>SFAHH</th><th>SV</th><th>SXR</th> </tr> </thead> <tbody> <tr> <td></td><td></td><td></td><td></td><td></td><td>✓</td><td></td><td></td><td></td><td></td><td></td><td></td> </tr> </tbody> </table>	MATERIAL AVAILABILITY												FA	X	V	R	MXS	HH	EPFA	GPFAX	SFA	SFAHH	SV	SXR						✓						
MATERIAL AVAILABILITY																																						
FA	X	V	R	MXS	HH	EPFA	GPFAX	SFA	SFAHH	SV	SXR																											
					✓																																	
		BMW																																				
FA442/4 A 62 x 44.5 x 8mm B 31 x 48 x 8mm		<table border="1"> <thead> <tr> <th colspan="12">MATERIAL AVAILABILITY</th> </tr> <tr> <th>FA</th><th>X</th><th>V</th><th>R</th><th>MXS</th><th>HH</th><th>EPFA</th><th>GPFAX</th><th>SFA</th><th>SFAHH</th><th>SV</th><th>SXR</th> </tr> </thead> <tbody> <tr> <td>✓</td><td></td><td></td><td></td><td></td><td>✓</td><td>✓</td><td>✓</td><td></td><td></td><td></td><td></td> </tr> </tbody> </table>	MATERIAL AVAILABILITY												FA	X	V	R	MXS	HH	EPFA	GPFAX	SFA	SFAHH	SV	SXR	✓					✓	✓	✓				
MATERIAL AVAILABILITY																																						
FA	X	V	R	MXS	HH	EPFA	GPFAX	SFA	SFAHH	SV	SXR																											
✓					✓	✓	✓																															
		YAMAHA																																				

FA443 A 107 x 36.5 x 8mm
B 91.5 x 36.5 x 7.5mm

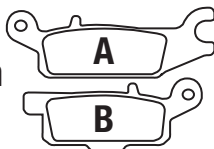

MATERIAL AVAILABILITY											
FA	X	V	R	MXS	HH	EPFA	GPFAX	SFA	SFAHH	SV	SXR
	✓		✓							✓	

YAMAHA

FA444 A 107 x 36.5 x 8mm
B 91.5 x 36.5 x 8mm

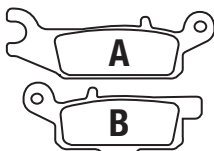

MATERIAL AVAILABILITY											
FA	X	V	R	MXS	HH	EPFA	GPFAX	SFA	SFAHH	SV	SXR
	✓		✓							✓	

YAMAHA

FA445 A 107 x 36.5 x 8mm
B 91.5 x 36.5 x 8mm

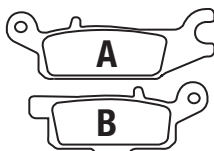

MATERIAL AVAILABILITY											
FA	X	V	R	MXS	HH	EPFA	GPFAX	SFA	SFAHH	SV	SXR
	✓		✓							✓	

YAMAHA

FA446 A 107 x 36.5 x 9mm
B 91.5 x 36.5 x 9mm

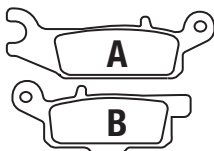

MATERIAL AVAILABILITY											
FA	X	V	R	MXS	HH	EPFA	GPFAX	SFA	SFAHH	SV	SXR
	✓		✓							✓	

YAMAHA

FA447 102 x 42 x 7.5mm

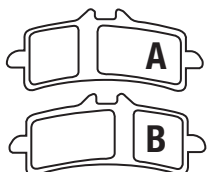

MATERIAL AVAILABILITY											
FA	X	V	R	MXS	HH	EPFA	GPFAX	SFA	SFAHH	SV	SXR
					✓	✓	✓				

APRILIA, BMW, BREMBO AFTERMARKET CALIPER, DUCATI, ENERGICA ELECTRIC, HONDA, HUSQVARNA, KAWASAKI, KTM, MV AUGUSTA, SUZUKI, TM RACING, TRIUMPH

FA450 A 94 x 31.5 x 7mm
B 94 x 31.5 x 7mm

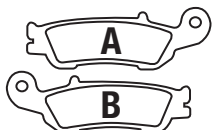

MATERIAL AVAILABILITY											
FA	X	V	R	MXS	HH	EPFA	GPFAX	SFA	SFAHH	SV	SXR
	✓		✓	✓		✓					

YAMAHA

FA452 120.5 x 57 x 7mm



MATERIAL AVAILABILITY											
FA	X	V	R	MXS	HH	EPFA	GPFAX	SFA	SFAHH	SV	SXR
	✓		✓							✓	✓

POLARIS

FA453 97 x 39.5 x 7.5mm



MATERIAL AVAILABILITY											
FA	X	V	R	MXS	HH	EPFA	GPFAX	SFA	SFAHH	SV	SXR
	✓		✓								

CF MOTO, UNISON

FA454/4 61.5 x 46.5 x 7.5mm



MATERIAL AVAILABILITY											
FA	X	V	R	MXS	HH	EPFA	GPFAX	SFA	SFAHH	SV	SXR
					✓	✓					

BUELL, EBR

FA455 99 x 54.5 x 9mm



MATERIAL AVAILABILITY											
FA	X	V	R	MXS	HH	EPFA	GPFAX	SFA	SFAHH	SV	SXR
					✓						

JAYBRAKE CALIPERS

FA456 97.5 x 47 x 7mm



MATERIAL AVAILABILITY											
FA	X	V	R	MXS	HH	EPFA	GPFAX	SFA	SFAHH	SV	SXR
	✓		✓							✓	✓

POLARIS

FA457 A 90.5 x 62 x 8mm

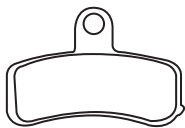

MATERIAL AVAILABILITY											
FA	X	V	R	MXS	HH	EPFA	GPFAX	SFA	SFAHH	SV	SXR
		✓			✓	✓					

HARLEY DAVIDSON, LYNDALL BRAKES

FA458 A 127.5 x 52.5 x 8mm
HH thickness = 7.5mm



MATERIAL AVAILABILITY											
FA	X	V	R	MXS	HH	EPFA	GPFAX	SFA	SFAHH	SV	SXR
		✓			✓	✓					

HARLEY DAVIDSON, LYNDALL BRAKES

FA460 46.5 x 49.5 x 7mm



MATERIAL AVAILABILITY											
FA	X	V	R	MXS	HH	EPFA	GPFAX	SFA	SFAHH	SV	SXR
					✓						

BUELL, EBR

FA462 76.5 x 38 x 7mm



MATERIAL AVAILABILITY											
FA	X	V	R	MXS	HH	EPFA	GPFAX	SFA	SFAHH	SV	SXR
			✓								

KTM

FA463 58.5 x 35.5 x 8.5mm



MATERIAL AVAILABILITY											
FA	X	V	R	MXS	HH	EPFA	GPFAX	SFA	SFAHH	SV	SXR
			✓								

KTM

FA464 A 94.5 x 37 x 8.5mm
B 109.5 x 51 x 8.5mm

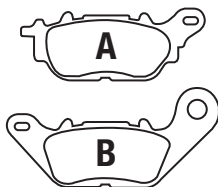

MATERIAL AVAILABILITY											
FA	X	V	R	MXS	HH	EPFA	GPFAX	SFA	SFAHH	SV	SXR
✓								✓			

YAMAHA, SFA646 - YAMAHA

FA465 A 111 x 36 x 7.5mm
B 98.5 x 33 x 7.5mm

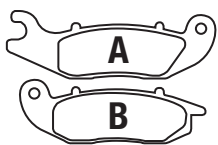

MATERIAL AVAILABILITY											
FA	X	V	R	MXS	HH	EPFA	GPFAX	SFA	SFAHH	SV	SXR
	✓		✓	✓							

AJP, HONDA, SCORPA, YAMAHA

FA468 67.5 x 52 x 7.5mm



MATERIAL AVAILABILITY											
FA	X	V	R	MXS	HH	EPFA	GPFAX	SFA	SFAHH	SV	SXR
			✓								

CAN-AM

FA473 110.5 x 53.5 x 8mm



MATERIAL AVAILABILITY											
FA	X	V	R	MXS	HH	EPFA	GPFAX	SFA	SFAHH	SV	SXR
✓		✓									

CAN-AM

FA474 75.5 x 33 x 8mm



MATERIAL AVAILABILITY											
FA	X	V	R	MXS	HH	EPFA	GPFAX	SFA	SFAHH	SV	SXR
✓		✓									

CAN-AM

FA475 97 x 43 x 7mm



MATERIAL AVAILABILITY											
FA	X	V	R	MXS	HH	EPFA	GPFAX	SFA	SFAHH	SV	SXR
	✓		✓							✓	

POLARIS

FA476 104 x 43.5 x 13mm

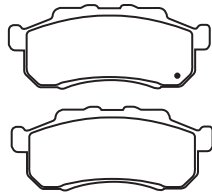

MATERIAL AVAILABILITY											
FA	X	V	R	MXS	HH	EPFA	GPFAX	SFA	SFAHH	SV	SXR
	✓										

HONDA

FA477 104 x 43.5 x 13mm

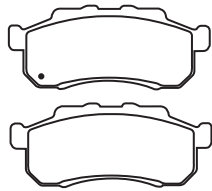

MATERIAL AVAILABILITY											
FA	X	V	R	MXS	HH	EPFA	GPFAX	SFA	SFAHH	SV	SXR
	✓										

HONDA

FA478 A 89 x 36.5 x 14mm
B 89 x 36.5 x 13.5mm

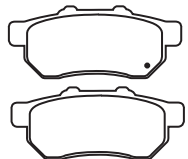

MATERIAL AVAILABILITY											
FA	X	V	R	MXS	HH	EPFA	GPFAX	SFA	SFAHH	SV	SXR
	✓										

HONDA

FA479 A 89 x 36.5 x 14mm
B 89 x 36.5 x 13.5mm

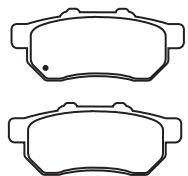

MATERIAL AVAILABILITY											
FA	X	V	R	MXS	HH	EPFA	GPFAX	SFA	SFAHH	SV	SXR
	✓										

HONDA

FA480 A. 74 x 37 x 7mm
B. 38 x 27 x 9mm



MATERIAL AVAILABILITY											
FA	X	V	R	MXS	HH	EPFA	GPFAX	SFA	SFAHH	SV	SXR
	✓										

COBRA

FA488 99.5 x 38 x 9mm

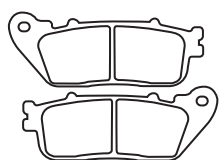

MATERIAL AVAILABILITY											
FA	X	V	R	MXS	HH	EPFA	GPFAX	SFA	SFAHH	SV	SXR
					✓						

HONDA

FA489 88.5 x 47 x 7mm



MATERIAL AVAILABILITY											
FA	X	V	R	MXS	HH	EPFA	GPFAX	SFA	SFAHH	SV	SXR
			✓								

POLARIS

FA490 87 x 42.5 x 7.5mm



MATERIAL AVAILABILITY											
FA	X	V	R	MXS	HH	EPFA	GPFAX	SFA	SFAHH	SV	SXR
			✓								

POLARIS

FA491 78.5 x 46.5 x 7.5mm



MATERIAL AVAILABILITY											
FA	X	V	R	MXS	HH	EPFA	GPFAX	SFA	SFAHH	SV	SXR
					✓	✓	✓				

TRIUMPH HINCKLEY PRODUCED MODELS

SFA492 A 109.5 x 51 x 9.5mm
B 114 x 41.5 x 9mm

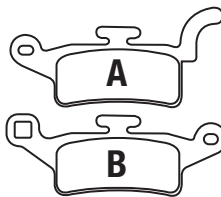

MATERIAL AVAILABILITY											
FA	X	V	R	MXS	HH	EPFA	GPFAX	SFA	SFAHH	SV	SXR
								✓			

YAMAHA

FA495 35.5 x 42 x 5.5mm



MATERIAL AVAILABILITY											
FA	X	V	R	MXS	HH	EPFA	GPFAX	SFA	SFAHH	SV	SXR
	✓										

BETA

FA496 86.5 x 40 x 9mm



MATERIAL AVAILABILITY											
FA	X	V	R	MXS	HH	EPFA	GPFAX	SFA	SFAHH	SV	SXR
✓		✓			✓						

HONDA, KAWASAKI, SUZUKI

FA497 62 x 41 x 7mm



MATERIAL AVAILABILITY											
FA	X	V	R	MXS	HH	EPFA	GPFAX	SFA	SFAHH	SV	SXR
	✓										

YAMAHA

SFA498 90 x 33 x 10mm



MATERIAL AVAILABILITY											
FA	X	V	R	MXS	HH	EPFA	GPFAX	SFA	SFAHH	SV	SXR
								✓	✓		

KYMCO

FA499/4 A 69 x 51.5 x 9mm
B 31.5 x 51.5 x 9mm

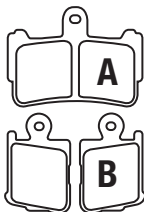

MATERIAL AVAILABILITY											
FA	X	V	R	MXS	HH	EPFA	GPFAX	SFA	SFAHH	SV	SXR
					✓						

HONDA

FA600 102.5 x 42.5 x 8mm



MATERIAL AVAILABILITY											
FA	X	V	R	MXS	HH	EPFA	GPFAX	SFA	SFAHH	SV	SXR
	✓		✓								

KYMCO

FA600/2 102.5 x 42.5 x 7mm



MATERIAL AVAILABILITY											
FA	X	V	R	MXS	HH	EPFA	GPFAX	SFA	SFAHH	SV	SXR
	✓		✓								

KYMCO

FA602 41 x 42.5 x 7.5mm



MATERIAL AVAILABILITY											
FA	X	V	R	MXS	HH	EPFA	GPFAX	SFA	SFAHH	SV	SXR
	✓		✓								

HUSQVARNA, KTM

SFA603 A 111 x 44.5 x 8mm
B 109.5 x 41.5 x 8mm

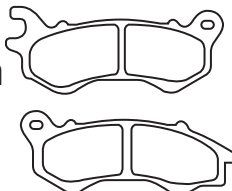

MATERIAL AVAILABILITY											
FA	X	V	R	MXS	HH	EPFA	GPFAX	SFA	SFAHH	SV	SXR
								✓	✓		

HONDA, KYMCO

FA604/4 35 x 40.5 x 8mm



MATERIAL AVAILABILITY											
FA	X	V	R	MXS	HH	EPFA	GPFAX	SFA	SFAHH	SV	SXR
						✓	✓	✓			

BMW, TRIUMPH

FA605/4 97.5 x 46.5 x 7mm



MATERIAL AVAILABILITY											
FA	X	V	R	MXS	HH	EPFA	GPFAX	SFA	SFAHH	SV	SXR
		✓			✓						

HARLEY DAVIDSON, LYNDALL BRAKES

FA606 69.5 x 45.5 x 8.5mm



MATERIAL AVAILABILITY											
FA	X	V	R	MXS	HH	EPFA	GPFAX	SFA	SFAHH	SV	SXR
✓					✓	✓					

BMW, HUSQVARNA, KTM

SFA607 94 x 36 x 10mm

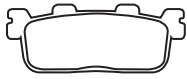

MATERIAL AVAILABILITY											
FA	X	V	R	MXS	HH	EPFA	GPFAX	SFA	SFAHH	SV	SXR
								✓	✓		

KYMCO

SFA608 101.5 x 39 x 10.5mm

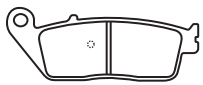

MATERIAL AVAILABILITY											
FA	X	V	R	MXS	HH	EPFA	GPFAX	SFA	SFAHH	SV	SXR
								✓	✓		

KYMCO

FA609 98 x 42 x 7mm



MATERIAL AVAILABILITY											
FA	X	V	R	MXS	HH	EPFA	GPFAX	SFA	SFAHH	SV	SXR
			✓								

JOHN DEERE

FA610 135.5 x 55 x 8mm

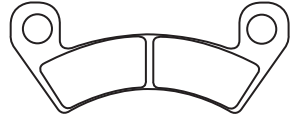

MATERIAL AVAILABILITY											
FA	X	V	R	MXS	HH	EPFA	GPFAX	SFA	SFAHH	SV	SXR
			✓							✓	✓

JOHN DEERE, ARCTIC CAT

GPFAX611HH 82 x 29 x 8.5mm



MATERIAL AVAILABILITY											
FA	X	V	R	MXS	HH	EPFA	GPFAX	SFA	SFAHH	SV	SXR
							✓				

BMW, BREMBO AFTERMARKET RACE CALIPER

FA612 59 x 40 x 7.5mm

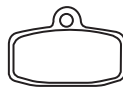

MATERIAL AVAILABILITY											
FA	X	V	R	MXS	HH	EPFA	GPFAX	SFA	SFAHH	SV	SXR
	✓		✓								

HUSQVARNA, KTM, OHVALE, SHERCO

FA613 81 x 46 x 9.5mm



MATERIAL AVAILABILITY											
FA	X	V	R	MXS	HH	EPFA	GPFAX	SFA	SFAHH	SV	SXR
					✓						





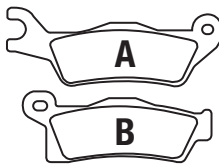

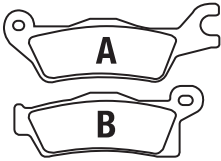

BMW

FA617 A 109.5 x 40 x 7.5mm
B 95.5 x 36.5 x 7.5mm

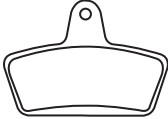
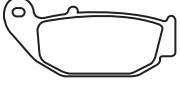
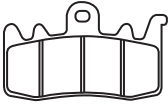

MATERIAL AVAILABILITY											
FA	X	V	R	MXS	HH	EPFA	GPFAX	SFA	SFAHH	SV	SXR
	✓		✓							✓	

CAN-AM

FA618 A 109.5 x 40 x 7.5mm B 95.5 x 36.5 x 7.5mm		MATERIAL AVAILABILITY											
		FA	X	V	R	MXS	HH	EPFA	GPFAX	SFA	SFAHH	SV	SXR
			✓		✓							✓	
		CAN-AM											
CFA619 30 x 33.5 x 4mm		MATERIAL AVAILABILITY											
		CFA	X	V	R	MXS	HH	EPFA	GPFAX	SFA	SFAHH	SV	SXR
		✓											
		BULTACO											
SFA621 27.8mm Ø		MATERIAL AVAILABILITY											
		FA	X	V	R	MXS	HH	EPFA	GPFAX	SFA	SFAHH	SV	SXR
				✓									
		YAMAHA											
FA622 77.5 x 42 x 7mm		MATERIAL AVAILABILITY											
		FA	X	V	R	MXS	HH	EPFA	GPFAX	SFA	SFAHH	SV	SXR
			✓		✓							✓	
		KAYO, KOTI/MECHRON											
FA623 84.5 x 59.5 x 10mm		MATERIAL AVAILABILITY											
		FA	X	V	R	MXS	HH	EPFA	GPFAX	SFA	SFAHH	SV	SXR
		✓					✓						
		HHI HAWG HALTERS AFTERMARKET CALIPERS											
FA629 88 x 40 x 10mm		MATERIAL AVAILABILITY											
		FA	X	V	R	MXS	HH	EPFA	GPFAX	SFA	SFAHH	SV	SXR
		✓	✓	✓	✓		✓						
		BENELLI, SUZUKI											
FA630 85 x 50.5 x 8mm		MATERIAL AVAILABILITY											
		FA	X	V	R	MXS	HH	EPFA	GPFAX	SFA	SFAHH	SV	SXR
				✓			✓	✓	✓				
		APRILIA, BMW, BREMBO, CAN-AM, DUCATI, HARLEY DAVIDSON, INDIAN, KAWASAKI, KTM, KYMCO, MOTO GUZZI, MV, SWM, TRIUMPH											
FA631 96.5 x 43.5 x 8mm		MATERIAL AVAILABILITY											
		FA	X	V	R	MXS	HH	EPFA	GPFAX	SFA	SFAHH	SV	SXR
							✓						
		CAN-AM, HARLEY DAVIDSON											
SFA632 90 x 39 x 10.5mm		MATERIAL AVAILABILITY											
		FA	X	V	R	MXS	HH	EPFA	GPFAX	SFA	SFAHH	SV	SXR
									✓				
		YAMAHA											
FA636 102 x 40 x 9.5mm		MATERIAL AVAILABILITY											
		FA	X	V	R	MXS	HH	EPFA	GPFAX	SFA	SFAHH	SV	SXR
							✓						
		HONDA											

FA638 173.5 x 48.5 x 7mm

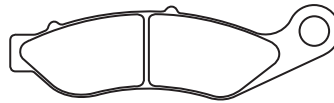

MATERIAL AVAILABILITY											
FA	X	V	R	MXS	HH	EPFA	GPFAX	SFA	SFAHH	SV	SXR
		✓			✓	✓					

HARLEY DAVIDSON

FA640 118 x 48.5 x 9.5mm



MATERIAL AVAILABILITY											
FA	X	V	R	MXS	HH	EPFA	GPFAX	SFA	SFAHH	SV	SXR
✓		✓			✓	✓					

HARLEY DAVIDSON

FA641/4 88 x 43 x 8mm



MATERIAL AVAILABILITY											
FA	X	V	R	MXS	HH	EPFA	GPFAX	SFA	SFAHH	SV	SXR
		✓			✓						

HARLEY DAVIDSON

FA642 A 104 x 46.5 x 8mm
B 88 x 46 x 8mm

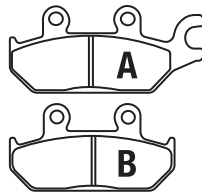

MATERIAL AVAILABILITY											
FA	X	V	R	MXS	HH	EPFA	GPFAX	SFA	SFAHH	SV	SXR
	✓		✓							✓	✓

CAN-AM, YAMAHA

FA643 94 x 36.5 x 9mm



MATERIAL AVAILABILITY											
FA	X	V	R	MXS	HH	EPFA	GPFAX	SFA	SFAHH	SV	SXR
		✓			✓						

HARLEY DAVIDSON

FA644 56 x 32 x 5mm



MATERIAL AVAILABILITY											
FA	X	V	R	MXS	HH	EPFA	GPFAX	SFA	SFAHH	SV	SXR
	✓										

GAS-GAS, MONTESA

FA645 A 104 x 46.5 x 8.5mm
B 88 x 46 x 8.5mm

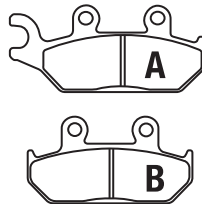

MATERIAL AVAILABILITY											
FA	X	V	R	MXS	HH	EPFA	GPFAX	SFA	SFAHH	SV	SXR
	✓		✓							✓	✓

CAN-AM, YAMAHA

GPFAX646HH 94 x 34 x 11.5mm

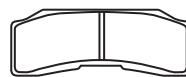

MATERIAL AVAILABILITY											
FA	X	V	R	MXS	HH	EPFA	GPFAX	SFA	SFAHH	SV	SXR
							✓				

BREMBO AFTERMARKET CALIPER

FA649 99 x 55 x 8.5mm



MATERIAL AVAILABILITY											
FA	X	V	R	MXS	HH	EPFA	GPFAX	SFA	SFAHH	SV	SXR
					✓						

JAYBRAKE CALIPERS

FA651 72.5 x 30 x 10mm



MATERIAL AVAILABILITY											
FA	X	V	R	MXS	HH	EPFA	GPFAX	SFA	SFAHH	SV	SXR
	✓		✓							✓	✓

CF MOTO

FA656 120.5 x 57 x 7mm		<table border="1"> <thead> <tr> <th colspan="12">MATERIAL AVAILABILITY</th> </tr> <tr> <th>FA</th><th>X</th><th>V</th><th>R</th><th>MXS</th><th>HH</th><th>EPFA</th><th>GPFAX</th><th>SFA</th><th>SFAHH</th><th>SV</th><th>SXR</th> </tr> </thead> <tbody> <tr> <td></td><td>✓</td><td></td><td>✓</td><td></td><td></td><td></td><td></td><td></td><td></td><td>✓</td><td>✓</td> </tr> </tbody> </table>	MATERIAL AVAILABILITY												FA	X	V	R	MXS	HH	EPFA	GPFAX	SFA	SFAHH	SV	SXR		✓		✓							✓	✓
MATERIAL AVAILABILITY																																						
FA	X	V	R	MXS	HH	EPFA	GPFAX	SFA	SFAHH	SV	SXR																											
	✓		✓							✓	✓																											
		POLARIS																																				
FA657 97 x 52 x 7mm		<table border="1"> <thead> <tr> <th colspan="12">MATERIAL AVAILABILITY</th> </tr> <tr> <th>FA</th><th>X</th><th>V</th><th>R</th><th>MXS</th><th>HH</th><th>EPFA</th><th>GPFAX</th><th>SFA</th><th>SFAHH</th><th>SV</th><th>SXR</th> </tr> </thead> <tbody> <tr> <td></td><td>✓</td><td></td><td>✓</td><td></td><td></td><td></td><td></td><td></td><td></td><td>✓</td><td>✓</td> </tr> </tbody> </table>	MATERIAL AVAILABILITY												FA	X	V	R	MXS	HH	EPFA	GPFAX	SFA	SFAHH	SV	SXR		✓		✓							✓	✓
MATERIAL AVAILABILITY																																						
FA	X	V	R	MXS	HH	EPFA	GPFAX	SFA	SFAHH	SV	SXR																											
	✓		✓							✓	✓																											
		POLARIS																																				
FA658 67.5 x 48.5 x 7mm		<table border="1"> <thead> <tr> <th colspan="12">MATERIAL AVAILABILITY</th> </tr> <tr> <th>FA</th><th>X</th><th>V</th><th>R</th><th>MXS</th><th>HH</th><th>EPFA</th><th>GPFAX</th><th>SFA</th><th>SFAHH</th><th>SV</th><th>SXR</th> </tr> </thead> <tbody> <tr> <td>✓</td><td></td><td></td><td></td><td></td><td>✓</td><td></td><td></td><td></td><td></td><td></td><td></td> </tr> </tbody> </table>	MATERIAL AVAILABILITY												FA	X	V	R	MXS	HH	EPFA	GPFAX	SFA	SFAHH	SV	SXR	✓					✓						
MATERIAL AVAILABILITY																																						
FA	X	V	R	MXS	HH	EPFA	GPFAX	SFA	SFAHH	SV	SXR																											
✓					✓																																	
		BENELLI																																				
FA659 A 134.5 x 44.5 x 7.5mm 4 x 13.5mm holes B 134.5 x 44.5 x 9.5mm 2 x 10.5mm holes		<table border="1"> <thead> <tr> <th colspan="12">MATERIAL AVAILABILITY</th> </tr> <tr> <th>FA</th><th>X</th><th>V</th><th>R</th><th>MXS</th><th>HH</th><th>EPFA</th><th>GPFAX</th><th>SFA</th><th>SFAHH</th><th>SV</th><th>SXR</th> </tr> </thead> <tbody> <tr> <td></td><td>✓</td><td></td><td></td><td></td><td></td><td></td><td></td><td></td><td></td><td></td><td></td> </tr> </tbody> </table>	MATERIAL AVAILABILITY												FA	X	V	R	MXS	HH	EPFA	GPFAX	SFA	SFAHH	SV	SXR		✓										
MATERIAL AVAILABILITY																																						
FA	X	V	R	MXS	HH	EPFA	GPFAX	SFA	SFAHH	SV	SXR																											
	✓																																					
		POLARIS																																				
SFA661/4 44.5 x 53.5 x 7.5mm (4 pad set)		<table border="1"> <thead> <tr> <th colspan="12">MATERIAL AVAILABILITY</th> </tr> <tr> <th>FA</th><th>X</th><th>V</th><th>R</th><th>MXS</th><th>HH</th><th>EPFA</th><th>GPFAX</th><th>SFA</th><th>SFAHH</th><th>SV</th><th>SXR</th> </tr> </thead> <tbody> <tr> <td></td><td></td><td></td><td></td><td></td><td></td><td></td><td></td><td>✓</td><td></td><td></td><td></td> </tr> </tbody> </table>	MATERIAL AVAILABILITY												FA	X	V	R	MXS	HH	EPFA	GPFAX	SFA	SFAHH	SV	SXR									✓			
MATERIAL AVAILABILITY																																						
FA	X	V	R	MXS	HH	EPFA	GPFAX	SFA	SFAHH	SV	SXR																											
								✓																														
		DAELIM																																				
FA662 A 113.5 x 52 x 10.5mm B 97.5 x 39.5 x 10.5mm		<table border="1"> <thead> <tr> <th colspan="12">MATERIAL AVAILABILITY</th> </tr> <tr> <th>FA</th><th>X</th><th>V</th><th>R</th><th>MXS</th><th>HH</th><th>EPFA</th><th>GPFAX</th><th>SFA</th><th>SFAHH</th><th>SV</th><th>SXR</th> </tr> </thead> <tbody> <tr> <td>✓</td><td></td><td></td><td></td><td></td><td>✓</td><td></td><td>✓</td><td></td><td></td><td></td><td></td> </tr> </tbody> </table>	MATERIAL AVAILABILITY												FA	X	V	R	MXS	HH	EPFA	GPFAX	SFA	SFAHH	SV	SXR	✓					✓		✓				
MATERIAL AVAILABILITY																																						
FA	X	V	R	MXS	HH	EPFA	GPFAX	SFA	SFAHH	SV	SXR																											
✓					✓		✓																															
		YAMAHA																																				
FA663 A 113.5 x 55 x 8.5mm B 98.5 x 44.5 x 8.5mm		<table border="1"> <thead> <tr> <th colspan="12">MATERIAL AVAILABILITY</th> </tr> <tr> <th>FA</th><th>X</th><th>V</th><th>R</th><th>MXS</th><th>HH</th><th>EPFA</th><th>GPFAX</th><th>SFA</th><th>SFAHH</th><th>SV</th><th>SXR</th> </tr> </thead> <tbody> <tr> <td>✓</td><td></td><td></td><td></td><td></td><td>✓</td><td>✓</td><td>✓</td><td></td><td></td><td></td><td></td> </tr> </tbody> </table>	MATERIAL AVAILABILITY												FA	X	V	R	MXS	HH	EPFA	GPFAX	SFA	SFAHH	SV	SXR	✓					✓	✓	✓				
MATERIAL AVAILABILITY																																						
FA	X	V	R	MXS	HH	EPFA	GPFAX	SFA	SFAHH	SV	SXR																											
✓					✓	✓	✓																															
		YAMAHA																																				
FA664 A 94 x 33 x 8mm		<table border="1"> <thead> <tr> <th colspan="12">MATERIAL AVAILABILITY</th> </tr> <tr> <th>FA</th><th>X</th><th>V</th><th>R</th><th>MXS</th><th>HH</th><th>EPFA</th><th>GPFAX</th><th>SFA</th><th>SFAHH</th><th>SV</th><th>SXR</th> </tr> </thead> <tbody> <tr> <td>✓</td><td></td><td></td><td></td><td></td><td></td><td></td><td></td><td></td><td></td><td></td><td></td> </tr> </tbody> </table>	MATERIAL AVAILABILITY												FA	X	V	R	MXS	HH	EPFA	GPFAX	SFA	SFAHH	SV	SXR	✓											
MATERIAL AVAILABILITY																																						
FA	X	V	R	MXS	HH	EPFA	GPFAX	SFA	SFAHH	SV	SXR																											
✓																																						
		CSC																																				
FA669/4 137.5 x 49.5 x 15mm (4 pad set)		<table border="1"> <thead> <tr> <th colspan="12">MATERIAL AVAILABILITY</th> </tr> <tr> <th>FA</th><th>X</th><th>V</th><th>R</th><th>MXS</th><th>HH</th><th>EPFA</th><th>GPFAX</th><th>SFA</th><th>SFAHH</th><th>SV</th><th>SXR</th> </tr> </thead> <tbody> <tr> <td>✓</td><td></td><td></td><td></td><td></td><td></td><td></td><td></td><td></td><td></td><td></td><td></td> </tr> </tbody> </table>	MATERIAL AVAILABILITY												FA	X	V	R	MXS	HH	EPFA	GPFAX	SFA	SFAHH	SV	SXR	✓											
MATERIAL AVAILABILITY																																						
FA	X	V	R	MXS	HH	EPFA	GPFAX	SFA	SFAHH	SV	SXR																											
✓																																						
		POLARIS																																				
FA670 137.5 x 49.5 x 6mm (2 pad set)		<table border="1"> <thead> <tr> <th colspan="12">MATERIAL AVAILABILITY</th> </tr> <tr> <th>FA</th><th>X</th><th>V</th><th>R</th><th>MXS</th><th>HH</th><th>EPFA</th><th>GPFAX</th><th>SFA</th><th>SFAHH</th><th>SV</th><th>SXR</th> </tr> </thead> <tbody> <tr> <td>✓</td><td></td><td></td><td></td><td></td><td></td><td></td><td></td><td></td><td></td><td></td><td></td> </tr> </tbody> </table>	MATERIAL AVAILABILITY												FA	X	V	R	MXS	HH	EPFA	GPFAX	SFA	SFAHH	SV	SXR	✓											
MATERIAL AVAILABILITY																																						
FA	X	V	R	MXS	HH	EPFA	GPFAX	SFA	SFAHH	SV	SXR																											
✓																																						
		POLARIS																																				

FA671 A 94 x 36.5 x 10mm
B 94 x 36.5 x 8.5mm



MATERIAL AVAILABILITY											
FA	X	V	R	MXS	HH	EPFA	GPFAX	SFA	SFAHH	SV	SXR
✓		✓			✓						

BMW

FA672 114.5 x 38.5 x 9.5mm



MATERIAL AVAILABILITY											
FA	X	V	R	MXS	HH	EPFA	GPFAX	SFA	SFAHH	SV	SXR
✓		✓			✓	✓					

INDIAN TOSO CALIPER/CAST WHEELS

GFAX673HH 93.5 x 34 x 9.5mm

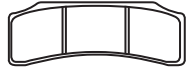

MATERIAL AVAILABILITY											
FA	X	V	R	MXS	HH	EPFA	GPFAX	SFA	SFAHH	SV	SXR
							✓				

BREMBO CALIPER

FA674 A 97 x 42 x 7.5mm
B 77 x 42 x 8mm

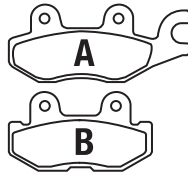

MATERIAL AVAILABILITY											
FA	X	V	R	MXS	HH	EPFA	GPFAX	SFA	SFAHH	SV	SXR
	✓		✓							✓	

YAMAHA

FA675 A 97 x 42 x 7.5mm
B 77 x 42 x 8mm

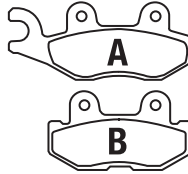

MATERIAL AVAILABILITY											
FA	X	V	R	MXS	HH	EPFA	GPFAX	SFA	SFAHH	SV	SXR
	✓		✓							✓	

YAMAHA

FA676 114 x 37 x 9mm



MATERIAL AVAILABILITY											
FA	X	V	R	MXS	HH	EPFA	GPFAX	SFA	SFAHH	SV	SXR
	✓		✓							✓	✓

YAMAHA

FA677 104 x 34.5 x 9mm



MATERIAL AVAILABILITY											
FA	X	V	R	MXS	HH	EPFA	GPFAX	SFA	SFAHH	SV	SXR
	✓		✓							✓	✓

YAMAHA

FA679 83 x 39.5 x 8mm



MATERIAL AVAILABILITY											
FA	X	V	R	MXS	HH	EPFA	GPFAX	SFA	SFAHH	SV	SXR
					✓						

HONDA

FA680 155 x 53 x 7mm

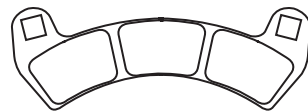

MATERIAL AVAILABILITY											
FA	X	V	R	MXS	HH	EPFA	GPFAX	SFA	SFAHH	SV	SXR
			✓							✓	✓

POLARIS

SFA681 55.5 x 49.5 x 7.5mm

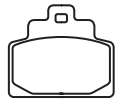

MATERIAL AVAILABILITY											
FA	X	V	R	MXS	HH	EPFA	GPFAX	SFA	SFAHH	SV	SXR
								✓	✓		

PIAGGIO

FA682 A 117.5 x 50.5 x 8mm
B 95 x 50.5 x 8mm

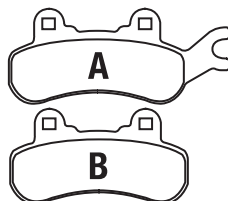

MATERIAL AVAILABILITY											
FA	X	V	R	MXS	HH	EPFA	GPFAX	SFA	SFAHH	SV	SXR
	✓		✓							✓	✓

CAN-AM SIDE X SIDE

FA683 A 117.5 x 50.5 x 8mm
B 95 x 50.5 x 8mm

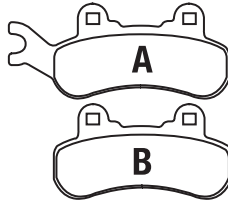

MATERIAL AVAILABILITY											
FA	X	V	R	MXS	HH	EPFA	GPFAX	SFA	SFAHH	SV	SXR
	✓		✓							✓	✓

CAN-AM SIDE X SIDE

FA684 A 101.5 x 43 x 8mm
B 83 x 43 x 8mm

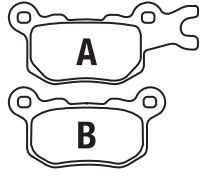

MATERIAL AVAILABILITY											
FA	X	V	R	MXS	HH	EPFA	GPFAX	SFA	SFAHH	SV	SXR
	✓		✓							✓	✓

CAN-AM SIDE X SIDE

FA685 A 101.5 x 43 x 8mm
B 83 x 43 x 8mm

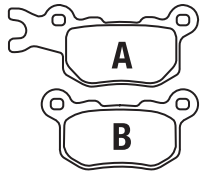

MATERIAL AVAILABILITY											
FA	X	V	R	MXS	HH	EPFA	GPFAX	SFA	SFAHH	SV	SXR
	✓		✓							✓	✓

CAN-AM SIDE X SIDE

FA686 A 94 x 44.5 x 8.5mm
B 73 x 46 x 10mm

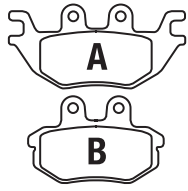

MATERIAL AVAILABILITY											
FA	X	V	R	MXS	HH	EPFA	GPFAX	SFA	SFAHH	SV	SXR
	✓		✓								

KAWASAKI

CFA689 43.5 x 29 x 3.5mm



MATERIAL AVAILABILITY											
FA	X	V	R	MXS	HH	EPFA	GPFAX	SFA	SFAHH	SV	SXR
✓											

BULTACO

FA690 A 82 x 41 x 9mm
B 62 x 41 x 9mm

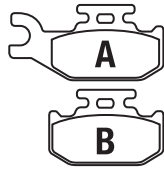

MATERIAL AVAILABILITY											
FA	X	V	R	MXS	HH	EPFA	GPFAX	SFA	SFAHH	SV	SXR
	✓		✓					✓	✓		

CF MOTO, COLEMAN POWERSPORTS, QLINK

FA691 A 85 x 44.5 x 7mm
B 74 x 41.5 x 7mm

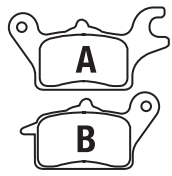

MATERIAL AVAILABILITY											
FA	X	V	R	MXS	HH	EPFA	GPFAX	SFA	SFAHH	SV	SXR
✓					✓						

KAWASAKI

SFA693 A 111 x 36 x 7.5mm
B 98.5 x 33 x 7.5mm

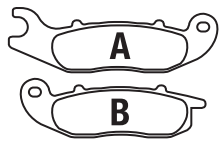

MATERIAL AVAILABILITY											
FA	X	V	R	MXS	HH	EPFA	GPFAX	SFA	SFAHH	SV	SXR
								✓	✓		

HONDA

FA696 55 x 53.5 x 9mm



MATERIAL AVAILABILITY											
FA	X	V	R	MXS	HH	EPFA	GPFAX	SFA	SFAHH	SV	SXR
✓		✓			✓						

INDIAN

FA698 81.5 x 37.5 x 9mm



MATERIAL AVAILABILITY											
FA	X	V	R	MXS	HH	EPFA	GPFAX	SFA	SFAHH	SV	SXR
✓					✓						

BENELLI

FA700 78 x 42.5 x 8mm

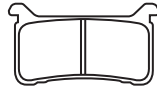

MATERIAL AVAILABILITY											
FA	X	V	R	MXS	HH	EPFA	GPFAX	SFA	SFAHH	SV	SXR
						✓	✓	✓			

HONDA

FA701 115 x 41 x 11mm



MATERIAL AVAILABILITY											
FA	X	V	R	MXS	HH	EPFA	GPFAX	SFA	SFAHH	SV	SXR
	✓		✓							✓	✓

HONDA

FA702 115 x 41 x 11mm



MATERIAL AVAILABILITY											
FA	X	V	R	MXS	HH	EPFA	GPFAX	SFA	SFAHH	SV	SXR
	✓		✓							✓	✓

HONDA

FA703 82 x 38.5 x 10.5mm

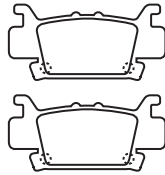

MATERIAL AVAILABILITY											
FA	X	V	R	MXS	HH	EPFA	GPFAX	SFA	SFAHH	SV	SXR
	✓		✓							✓	✓

HONDA

FA704 82 x 38.5 x 10.5mm

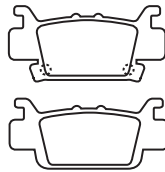

MATERIAL AVAILABILITY											
FA	X	V	R	MXS	HH	EPFA	GPFAX	SFA	SFAHH	SV	SXR
	✓		✓							✓	✓

HONDA

FA705 A. 113.5 x 55 x 8.5mm
B. 98.5 x 44.5 x 8.5mm

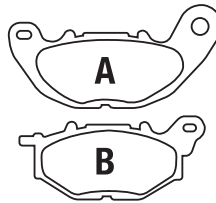

MATERIAL AVAILABILITY											
FA	X	V	R	MXS	HH	EPFA	GPFAX	SFA	SFAHH	SV	SXR
								✓	✓		

YAMAHA

FA706 A. 113.5 x 52 x 10.5mm
B. 97.5 x 39.5 x 10.5mm

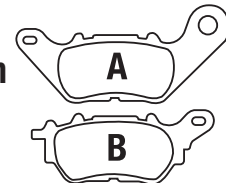

MATERIAL AVAILABILITY											
FA	X	V	R	MXS	HH	EPFA	GPFAX	SFA	SFAHH	SV	SXR
								✓	✓		

YAMAHA

FA710 82 x 42 x 10mm



MATERIAL AVAILABILITY											
FA	X	V	R	MXS	HH	EPFA	GPFAX	SFA	SFAHH	SV	SXR
					✓	✓					

HARLEY DAVIDSON

FA711 A 124 x 43 x 9mm
B 115.5 x 43 x 9mm

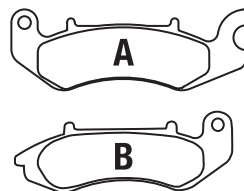

MATERIAL AVAILABILITY											
FA	X	V	R	MXS	HH	EPFA	GPFAX	SFA	SFAHH	SV	SXR
✓											





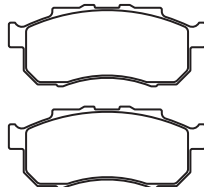

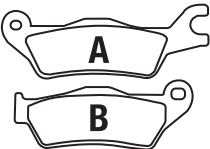

BENELLI

FA712 103.5 x 43 x 14.5mm

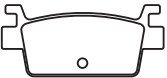
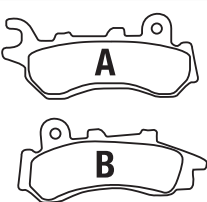
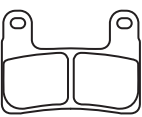

MATERIAL AVAILABILITY											
FA	X	V	R	MXS	HH	EPFA	GPFAX	SFA	SFAHH	SV	SXR
	✓		✓							✓	

HONDA

FA714 75.5 x 39.5 x 12mm		<table border="1"> <thead> <tr> <th colspan="12">MATERIAL AVAILABILITY</th> </tr> <tr> <th>FA</th><th>X</th><th>V</th><th>R</th><th>MXS</th><th>HH</th><th>EPFA</th><th>GPFAX</th><th>SFA</th><th>SFAHH</th><th>SV</th><th>SXR</th> </tr> </thead> <tbody> <tr> <td></td><td>✓</td><td></td><td>✓</td><td></td><td></td><td></td><td></td><td></td><td></td><td>✓</td><td></td> </tr> </tbody> </table>	MATERIAL AVAILABILITY												FA	X	V	R	MXS	HH	EPFA	GPFAX	SFA	SFAHH	SV	SXR		✓		✓							✓			
MATERIAL AVAILABILITY																																								
FA	X	V	R	MXS	HH	EPFA	GPFAX	SFA	SFAHH	SV	SXR																													
	✓		✓							✓																														
HONDA		FA715 A 109.5 x 40 x 7.5mm B 94 x 36.5 x 7.5 mm		<table border="1"> <thead> <tr> <th colspan="12">MATERIAL AVAILABILITY</th> </tr> <tr> <th>FA</th><th>X</th><th>V</th><th>R</th><th>MXS</th><th>HH</th><th>EPFA</th><th>GPFAX</th><th>SFA</th><th>SFAHH</th><th>SV</th><th>SXR</th> </tr> </thead> <tbody> <tr> <td>✓</td><td></td><td></td><td></td><td></td><td>✓</td><td></td><td></td><td></td><td></td><td></td><td></td> </tr> </tbody> </table>	MATERIAL AVAILABILITY												FA	X	V	R	MXS	HH	EPFA	GPFAX	SFA	SFAHH	SV	SXR	✓					✓						
MATERIAL AVAILABILITY																																								
FA	X	V	R	MXS	HH	EPFA	GPFAX	SFA	SFAHH	SV	SXR																													
✓					✓																																			
SUZUKI		FA717 129.5 x 40 x 9mm		<table border="1"> <thead> <tr> <th colspan="12">MATERIAL AVAILABILITY</th> </tr> <tr> <th>FA</th><th>X</th><th>V</th><th>R</th><th>MXS</th><th>HH</th><th>EPFA</th><th>GPFAX</th><th>SFA</th><th>SFAHH</th><th>SV</th><th>SXR</th> </tr> </thead> <tbody> <tr> <td></td><td></td><td></td><td></td><td></td><td>✓</td><td></td><td></td><td></td><td></td><td></td><td></td> </tr> </tbody> </table>	MATERIAL AVAILABILITY												FA	X	V	R	MXS	HH	EPFA	GPFAX	SFA	SFAHH	SV	SXR						✓						
MATERIAL AVAILABILITY																																								
FA	X	V	R	MXS	HH	EPFA	GPFAX	SFA	SFAHH	SV	SXR																													
					✓																																			
HONDA		SFA719 85.5 x 38 x 9mm		<table border="1"> <thead> <tr> <th colspan="12">MATERIAL AVAILABILITY</th> </tr> <tr> <th>FA</th><th>X</th><th>V</th><th>R</th><th>MXS</th><th>HH</th><th>EPFA</th><th>GPFAX</th><th>SFA</th><th>SFAHH</th><th>SV</th><th>SXR</th> </tr> </thead> <tbody> <tr> <td></td><td></td><td></td><td></td><td></td><td></td><td></td><td></td><td>✓</td><td>✓</td><td></td><td></td> </tr> </tbody> </table>	MATERIAL AVAILABILITY												FA	X	V	R	MXS	HH	EPFA	GPFAX	SFA	SFAHH	SV	SXR									✓	✓		
MATERIAL AVAILABILITY																																								
FA	X	V	R	MXS	HH	EPFA	GPFAX	SFA	SFAHH	SV	SXR																													
								✓	✓																															
KYMCO		FA723 A 101.5 x 43.5 x 7.5mm B 98.5 x 43.5 x 7.5mm		<table border="1"> <thead> <tr> <th colspan="12">MATERIAL AVAILABILITY</th> </tr> <tr> <th>FA</th><th>X</th><th>V</th><th>R</th><th>MXS</th><th>HH</th><th>EPFA</th><th>GPFAX</th><th>SFA</th><th>SFAHH</th><th>SV</th><th>SXR</th> </tr> </thead> <tbody> <tr> <td></td><td></td><td></td><td></td><td></td><td></td><td></td><td></td><td>✓</td><td></td><td></td><td></td> </tr> </tbody> </table>	MATERIAL AVAILABILITY												FA	X	V	R	MXS	HH	EPFA	GPFAX	SFA	SFAHH	SV	SXR									✓			
MATERIAL AVAILABILITY																																								
FA	X	V	R	MXS	HH	EPFA	GPFAX	SFA	SFAHH	SV	SXR																													
								✓																																
HONDA		FA724 73 x 54.5 x 8.5mm		<table border="1"> <thead> <tr> <th colspan="12">MATERIAL AVAILABILITY</th> </tr> <tr> <th>FA</th><th>X</th><th>V</th><th>R</th><th>MXS</th><th>HH</th><th>EPFA</th><th>GPFAX</th><th>SFA</th><th>SFAHH</th><th>SV</th><th>SXR</th> </tr> </thead> <tbody> <tr> <td></td><td></td><td></td><td></td><td></td><td>✓</td><td>✓</td><td>✓</td><td></td><td></td><td></td><td></td> </tr> </tbody> </table>	MATERIAL AVAILABILITY												FA	X	V	R	MXS	HH	EPFA	GPFAX	SFA	SFAHH	SV	SXR						✓	✓	✓				
MATERIAL AVAILABILITY																																								
FA	X	V	R	MXS	HH	EPFA	GPFAX	SFA	SFAHH	SV	SXR																													
					✓	✓	✓																																	
BMW		FA725 A 114.5 x 40 x 8.5mm		<table border="1"> <thead> <tr> <th colspan="12">MATERIAL AVAILABILITY</th> </tr> <tr> <th>FA</th><th>X</th><th>V</th><th>R</th><th>MXS</th><th>HH</th><th>EPFA</th><th>GPFAX</th><th>SFA</th><th>SFAHH</th><th>SV</th><th>SXR</th> </tr> </thead> <tbody> <tr> <td></td><td></td><td></td><td></td><td></td><td>✓</td><td></td><td></td><td></td><td></td><td></td><td></td> </tr> </tbody> </table>	MATERIAL AVAILABILITY												FA	X	V	R	MXS	HH	EPFA	GPFAX	SFA	SFAHH	SV	SXR						✓						
MATERIAL AVAILABILITY																																								
FA	X	V	R	MXS	HH	EPFA	GPFAX	SFA	SFAHH	SV	SXR																													
					✓																																			
YAMAHA		FA726 101.5 x 36.5 x 11mm		<table border="1"> <thead> <tr> <th colspan="12">MATERIAL AVAILABILITY</th> </tr> <tr> <th>FA</th><th>X</th><th>V</th><th>R</th><th>MXS</th><th>HH</th><th>EPFA</th><th>GPFAX</th><th>SFA</th><th>SFAHH</th><th>SV</th><th>SXR</th> </tr> </thead> <tbody> <tr> <td></td><td>✓</td><td></td><td>✓</td><td></td><td></td><td></td><td></td><td></td><td></td><td>✓</td><td>✓</td> </tr> </tbody> </table>	MATERIAL AVAILABILITY												FA	X	V	R	MXS	HH	EPFA	GPFAX	SFA	SFAHH	SV	SXR		✓		✓							✓	✓
MATERIAL AVAILABILITY																																								
FA	X	V	R	MXS	HH	EPFA	GPFAX	SFA	SFAHH	SV	SXR																													
	✓		✓							✓	✓																													
CF MOTO		FA728 163.5 x 50 x 9.5mm		<table border="1"> <thead> <tr> <th colspan="12">MATERIAL AVAILABILITY</th> </tr> <tr> <th>FA</th><th>X</th><th>V</th><th>R</th><th>MXS</th><th>HH</th><th>EPFA</th><th>GPFAX</th><th>SFA</th><th>SFAHH</th><th>SV</th><th>SXR</th> </tr> </thead> <tbody> <tr> <td></td><td></td><td></td><td>✓</td><td></td><td></td><td></td><td></td><td></td><td></td><td>✓</td><td>✓</td> </tr> </tbody> </table>	MATERIAL AVAILABILITY												FA	X	V	R	MXS	HH	EPFA	GPFAX	SFA	SFAHH	SV	SXR				✓							✓	✓
MATERIAL AVAILABILITY																																								
FA	X	V	R	MXS	HH	EPFA	GPFAX	SFA	SFAHH	SV	SXR																													
			✓							✓	✓																													
POLARIS		FA730 49.5 x 36 x 8mm		<table border="1"> <thead> <tr> <th colspan="12">MATERIAL AVAILABILITY</th> </tr> <tr> <th>FA</th><th>X</th><th>V</th><th>R</th><th>MXS</th><th>HH</th><th>EPFA</th><th>GPFAX</th><th>SFA</th><th>SFAHH</th><th>SV</th><th>SXR</th> </tr> </thead> <tbody> <tr> <td></td><td></td><td></td><td></td><td></td><td>✓</td><td>✓</td><td></td><td></td><td></td><td></td><td></td> </tr> </tbody> </table>	MATERIAL AVAILABILITY												FA	X	V	R	MXS	HH	EPFA	GPFAX	SFA	SFAHH	SV	SXR						✓	✓					
MATERIAL AVAILABILITY																																								
FA	X	V	R	MXS	HH	EPFA	GPFAX	SFA	SFAHH	SV	SXR																													
					✓	✓																																		
BMW, BREMBO		FA737 106.5 x 41 x 8mm		<table border="1"> <thead> <tr> <th colspan="12">MATERIAL AVAILABILITY</th> </tr> <tr> <th>FA</th><th>X</th><th>V</th><th>R</th><th>MXS</th><th>HH</th><th>EPFA</th><th>GPFAX</th><th>SFA</th><th>SFAHH</th><th>SV</th><th>SXR</th> </tr> </thead> <tbody> <tr> <td></td><td>✓</td><td></td><td>✓</td><td></td><td></td><td></td><td></td><td></td><td></td><td></td><td></td> </tr> </tbody> </table>	MATERIAL AVAILABILITY												FA	X	V	R	MXS	HH	EPFA	GPFAX	SFA	SFAHH	SV	SXR		✓		✓								
MATERIAL AVAILABILITY																																								
FA	X	V	R	MXS	HH	EPFA	GPFAX	SFA	SFAHH	SV	SXR																													
	✓		✓																																					
ARTIC CAT																																								

FA738 114 x 39 x 9mm



MATERIAL AVAILABILITY											
FA	X	V	R	MXS	HH	EPFA	GPFAX	SFA	SFAHH	SV	SXR
			✓		✓					✓	

KAWASAKI

FA739 85.5 x 38 x 9mm



MATERIAL AVAILABILITY											
FA	X	V	R	MXS	HH	EPFA	GPFAX	SFA	SFAHH	SV	SXR
			✓		✓					✓	

KAWASAKI

FA740 122 x 54.5 x 8mm



MATERIAL AVAILABILITY											
FA	X	V	R	MXS	HH	EPFA	GPFAX	SFA	SFAHH	SV	SXR
	✓		✓							✓	✓

ARTIC CAT

FA741 122 x 51.5 x 8mm



MATERIAL AVAILABILITY											
FA	X	V	R	MXS	HH	EPFA	GPFAX	SFA	SFAHH	SV	SXR
	✓		✓							✓	✓

ARTIC CAT

FA742 122 x 48 x 8mm



MATERIAL AVAILABILITY											
FA	X	V	R	MXS	HH	EPFA	GPFAX	SFA	SFAHH	SV	SXR
	✓		✓							✓	✓

ARTIC CAT

FA743 50 O/D x 9mm



MATERIAL AVAILABILITY											
FA	X	V	R	MXS	HH	EPFA	GPFAX	SFA	SFAHH	SV	SXR
							✓				

YAMAHA

FA747 88.5 x 37 x 11mm



MATERIAL AVAILABILITY											
FA	X	V	R	MXS	HH	EPFA	GPFAX	SFA	SFAHH	SV	SXR
			✓							✓	✓

CF MOTO

FA748 90.5 x 54.5 x 8mm

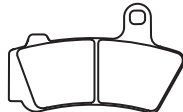

MATERIAL AVAILABILITY											
FA	X	V	R	MXS	HH	EPFA	GPFAX	SFA	SFAHH	SV	SXR
					✓						

BMW

FA749 90.5 x 54.5 x 8mm

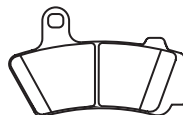
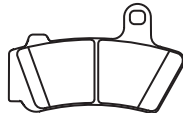

MATERIAL AVAILABILITY											
FA	X	V	R	MXS	HH	EPFA	GPFAX	SFA	SFAHH	SV	SXR
					✓						







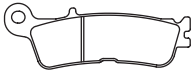
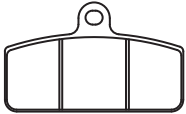
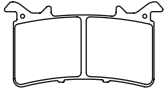
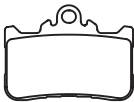
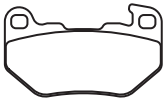

BMW

FA752 58 x 31 x 5mm



MATERIAL AVAILABILITY											
FA	X	V	R	MXS	HH	EPFA	GPFAX	SFA	SFAHH	SV	SXR
			✓								

COBRA

FA755 94 x 33.5 x 7.5mm		<table border="1"> <thead> <tr> <th colspan="12">MATERIAL AVAILABILITY</th> </tr> <tr> <th>FA</th> <th>X</th> <th>V</th> <th>R</th> <th>MXS</th> <th>HH</th> <th>EPFA</th> <th>GPFAX</th> <th>SFA</th> <th>SFAHH</th> <th>SV</th> <th>SXR</th> </tr> </thead> <tbody> <tr> <td></td> <td>✓</td> <td></td> <td></td> <td>✓</td> <td>✓</td> <td></td> <td></td> <td></td> <td></td> <td></td> <td></td> </tr> </tbody> </table> <p>YAMAHA</p>	MATERIAL AVAILABILITY												FA	X	V	R	MXS	HH	EPFA	GPFAX	SFA	SFAHH	SV	SXR		✓			✓	✓						
MATERIAL AVAILABILITY																																						
FA	X	V	R	MXS	HH	EPFA	GPFAX	SFA	SFAHH	SV	SXR																											
	✓			✓	✓																																	
FA756 91 x 55.5 x 9.5		<table border="1"> <thead> <tr> <th colspan="12">MATERIAL AVAILABILITY</th> </tr> <tr> <th>FA</th> <th>X</th> <th>V</th> <th>R</th> <th>MXS</th> <th>HH</th> <th>EPFA</th> <th>GPFAX</th> <th>SFA</th> <th>SFAHH</th> <th>SV</th> <th>SXR</th> </tr> </thead> <tbody> <tr> <td></td> <td></td> <td></td> <td></td> <td></td> <td></td> <td></td> <td></td> <td></td> <td></td> <td>✓</td> <td>✓</td> </tr> </tbody> </table> <p>CAN-AM MAVERICK X3</p>	MATERIAL AVAILABILITY												FA	X	V	R	MXS	HH	EPFA	GPFAX	SFA	SFAHH	SV	SXR											✓	✓
MATERIAL AVAILABILITY																																						
FA	X	V	R	MXS	HH	EPFA	GPFAX	SFA	SFAHH	SV	SXR																											
										✓	✓																											
FA757 80.5 x 43 x 8mm		<table border="1"> <thead> <tr> <th colspan="12">MATERIAL AVAILABILITY</th> </tr> <tr> <th>FA</th> <th>X</th> <th>V</th> <th>R</th> <th>MXS</th> <th>HH</th> <th>EPFA</th> <th>GPFAX</th> <th>SFA</th> <th>SFAHH</th> <th>SV</th> <th>SXR</th> </tr> </thead> <tbody> <tr> <td></td> <td></td> <td></td> <td></td> <td></td> <td>✓</td> <td>✓</td> <td>✓</td> <td></td> <td></td> <td></td> <td></td> </tr> </tbody> </table> <p>BMW, HONDA</p>	MATERIAL AVAILABILITY												FA	X	V	R	MXS	HH	EPFA	GPFAX	SFA	SFAHH	SV	SXR						✓	✓	✓				
MATERIAL AVAILABILITY																																						
FA	X	V	R	MXS	HH	EPFA	GPFAX	SFA	SFAHH	SV	SXR																											
					✓	✓	✓																															
FA759 68 x 50 x 7mm		<table border="1"> <thead> <tr> <th colspan="12">MATERIAL AVAILABILITY</th> </tr> <tr> <th>FA</th> <th>X</th> <th>V</th> <th>R</th> <th>MXS</th> <th>HH</th> <th>EPFA</th> <th>GPFAX</th> <th>SFA</th> <th>SFAHH</th> <th>SV</th> <th>SXR</th> </tr> </thead> <tbody> <tr> <td></td> <td></td> <td></td> <td></td> <td></td> <td>✓</td> <td></td> <td></td> <td></td> <td></td> <td></td> <td></td> </tr> </tbody> </table> <p>HONDA</p>	MATERIAL AVAILABILITY												FA	X	V	R	MXS	HH	EPFA	GPFAX	SFA	SFAHH	SV	SXR						✓						
MATERIAL AVAILABILITY																																						
FA	X	V	R	MXS	HH	EPFA	GPFAX	SFA	SFAHH	SV	SXR																											
					✓																																	
FA760 83 x 49 x 8mm		<table border="1"> <thead> <tr> <th colspan="12">MATERIAL AVAILABILITY</th> </tr> <tr> <th>FA</th> <th>X</th> <th>V</th> <th>R</th> <th>MXS</th> <th>HH</th> <th>EPFA</th> <th>GPFAX</th> <th>SFA</th> <th>SFAHH</th> <th>SV</th> <th>SXR</th> </tr> </thead> <tbody> <tr> <td>✓</td> <td></td> <td>✓</td> <td></td> <td></td> <td>✓</td> <td></td> <td></td> <td></td> <td></td> <td></td> <td></td> </tr> </tbody> </table> <p>HARLEY DAVIDSON, NIGHTSTER</p>	MATERIAL AVAILABILITY												FA	X	V	R	MXS	HH	EPFA	GPFAX	SFA	SFAHH	SV	SXR	✓		✓			✓						
MATERIAL AVAILABILITY																																						
FA	X	V	R	MXS	HH	EPFA	GPFAX	SFA	SFAHH	SV	SXR																											
✓		✓			✓																																	
FA763 111.5 x 38.5 x 9mm		<table border="1"> <thead> <tr> <th colspan="12">MATERIAL AVAILABILITY</th> </tr> <tr> <th>FA</th> <th>X</th> <th>V</th> <th>R</th> <th>MXS</th> <th>HH</th> <th>EPFA</th> <th>GPFAX</th> <th>SFA</th> <th>SFAHH</th> <th>SV</th> <th>SXR</th> </tr> </thead> <tbody> <tr> <td>✓</td> <td></td> <td></td> <td></td> <td></td> <td></td> <td></td> <td></td> <td></td> <td></td> <td></td> <td></td> </tr> </tbody> </table> <p>SEGWAY</p>	MATERIAL AVAILABILITY												FA	X	V	R	MXS	HH	EPFA	GPFAX	SFA	SFAHH	SV	SXR	✓											
MATERIAL AVAILABILITY																																						
FA	X	V	R	MXS	HH	EPFA	GPFAX	SFA	SFAHH	SV	SXR																											
✓																																						
FA764 88.5 36.5 x 9mm		<table border="1"> <thead> <tr> <th colspan="12">MATERIAL AVAILABILITY</th> </tr> <tr> <th>FA</th> <th>X</th> <th>V</th> <th>R</th> <th>MXS</th> <th>HH</th> <th>EPFA</th> <th>GPFAX</th> <th>SFA</th> <th>SFAHH</th> <th>SV</th> <th>SXR</th> </tr> </thead> <tbody> <tr> <td>✓</td> <td></td> <td></td> <td></td> <td></td> <td></td> <td></td> <td></td> <td></td> <td></td> <td></td> <td></td> </tr> </tbody> </table> <p>SEGWAY</p>	MATERIAL AVAILABILITY												FA	X	V	R	MXS	HH	EPFA	GPFAX	SFA	SFAHH	SV	SXR	✓											
MATERIAL AVAILABILITY																																						
FA	X	V	R	MXS	HH	EPFA	GPFAX	SFA	SFAHH	SV	SXR																											
✓																																						
FA768 155.5 x 44 x 9mm		<table border="1"> <thead> <tr> <th colspan="12">MATERIAL AVAILABILITY</th> </tr> <tr> <th>FA</th> <th>X</th> <th>V</th> <th>R</th> <th>MXS</th> <th>HH</th> <th>EPFA</th> <th>GPFAX</th> <th>SFA</th> <th>SFAHH</th> <th>SV</th> <th>SXR</th> </tr> </thead> <tbody> <tr> <td>✓</td> <td></td> <td></td> <td>✓</td> <td></td> <td></td> <td></td> <td></td> <td></td> <td></td> <td>✓</td> <td>✓</td> </tr> </tbody> </table> <p>CAN-AM</p>	MATERIAL AVAILABILITY												FA	X	V	R	MXS	HH	EPFA	GPFAX	SFA	SFAHH	SV	SXR	✓			✓							✓	✓
MATERIAL AVAILABILITY																																						
FA	X	V	R	MXS	HH	EPFA	GPFAX	SFA	SFAHH	SV	SXR																											
✓			✓							✓	✓																											
FA769 135.5 x 37.5 x 9mm		<table border="1"> <thead> <tr> <th colspan="12">MATERIAL AVAILABILITY</th> </tr> <tr> <th>FA</th> <th>X</th> <th>V</th> <th>R</th> <th>MXS</th> <th>HH</th> <th>EPFA</th> <th>GPFAX</th> <th>SFA</th> <th>SFAHH</th> <th>SV</th> <th>SXR</th> </tr> </thead> <tbody> <tr> <td>✓</td> <td></td> <td></td> <td>✓</td> <td></td> <td></td> <td></td> <td></td> <td></td> <td></td> <td>✓</td> <td>✓</td> </tr> </tbody> </table> <p>CAN-AM</p>	MATERIAL AVAILABILITY												FA	X	V	R	MXS	HH	EPFA	GPFAX	SFA	SFAHH	SV	SXR	✓			✓							✓	✓
MATERIAL AVAILABILITY																																						
FA	X	V	R	MXS	HH	EPFA	GPFAX	SFA	SFAHH	SV	SXR																											
✓			✓							✓	✓																											
FA777 108.5 x 41 x 9mm		<table border="1"> <thead> <tr> <th colspan="12">MATERIAL AVAILABILITY</th> </tr> <tr> <th>FA</th> <th>X</th> <th>V</th> <th>R</th> <th>MXS</th> <th>HH</th> <th>EPFA</th> <th>GPFAX</th> <th>SFA</th> <th>SFAHH</th> <th>SV</th> <th>SXR</th> </tr> </thead> <tbody> <tr> <td>✓</td> <td></td> <td></td> <td></td> <td></td> <td></td> <td></td> <td></td> <td></td> <td></td> <td></td> <td></td> </tr> </tbody> </table> <p>BENELLI</p>	MATERIAL AVAILABILITY												FA	X	V	R	MXS	HH	EPFA	GPFAX	SFA	SFAHH	SV	SXR	✓											
MATERIAL AVAILABILITY																																						
FA	X	V	R	MXS	HH	EPFA	GPFAX	SFA	SFAHH	SV	SXR																											
✓																																						
FA778 78.5 x 47 x 8mm		<table border="1"> <thead> <tr> <th colspan="12">MATERIAL AVAILABILITY</th> </tr> <tr> <th>FA</th> <th>X</th> <th>V</th> <th>R</th> <th>MXS</th> <th>HH</th> <th>EPFA</th> <th>GPFAX</th> <th>SFA</th> <th>SFAHH</th> <th>SV</th> <th>SXR</th> </tr> </thead> <tbody> <tr> <td>✓</td> <td></td> <td></td> <td></td> <td></td> <td></td> <td></td> <td></td> <td></td> <td></td> <td></td> <td></td> </tr> </tbody> </table> <p>MOTO GUZZI</p>	MATERIAL AVAILABILITY												FA	X	V	R	MXS	HH	EPFA	GPFAX	SFA	SFAHH	SV	SXR	✓											
MATERIAL AVAILABILITY																																						
FA	X	V	R	MXS	HH	EPFA	GPFAX	SFA	SFAHH	SV	SXR																											
✓																																						
FA779 85 x 49 x 8mm		<table border="1"> <thead> <tr> <th colspan="12">MATERIAL AVAILABILITY</th> </tr> <tr> <th>FA</th> <th>X</th> <th>V</th> <th>R</th> <th>MXS</th> <th>HH</th> <th>EPFA</th> <th>GPFAX</th> <th>SFA</th> <th>SFAHH</th> <th>SV</th> <th>SXR</th> </tr> </thead> <tbody> <tr> <td></td> <td></td> <td></td> <td></td> <td></td> <td>✓</td> <td></td> <td></td> <td></td> <td></td> <td></td> <td></td> </tr> </tbody> </table> <p>BMW</p>	MATERIAL AVAILABILITY												FA	X	V	R	MXS	HH	EPFA	GPFAX	SFA	SFAHH	SV	SXR						✓						
MATERIAL AVAILABILITY																																						
FA	X	V	R	MXS	HH	EPFA	GPFAX	SFA	SFAHH	SV	SXR																											
					✓																																	

EBC FULL SIZE BRAKE PAD ILLUSTRATION – FA11-FA26

BUYERS GUIDE
BRAKE PADS

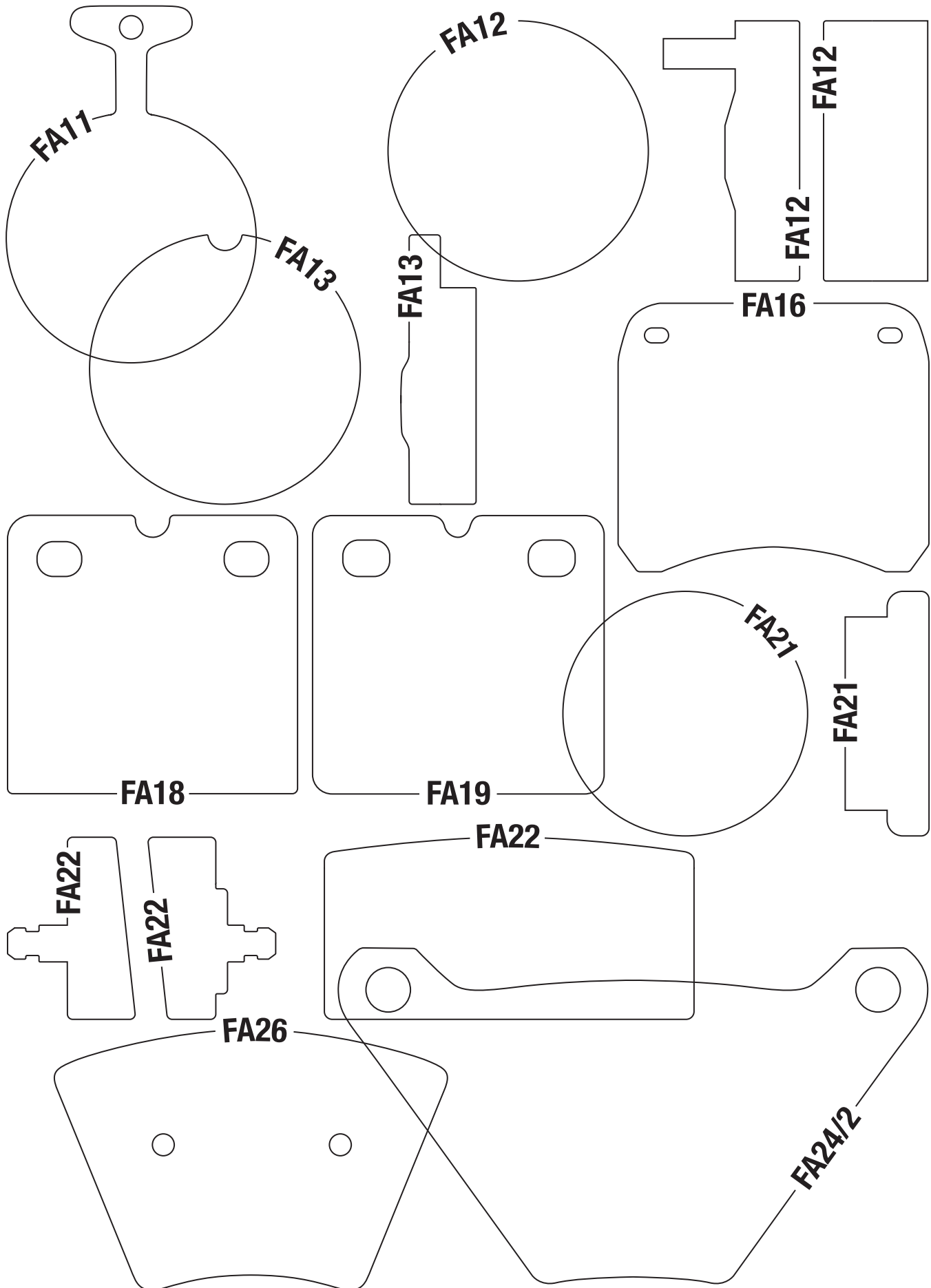

EBC FULL SIZE BRAKE PAD ILLUSTRATION – FA27-FA40

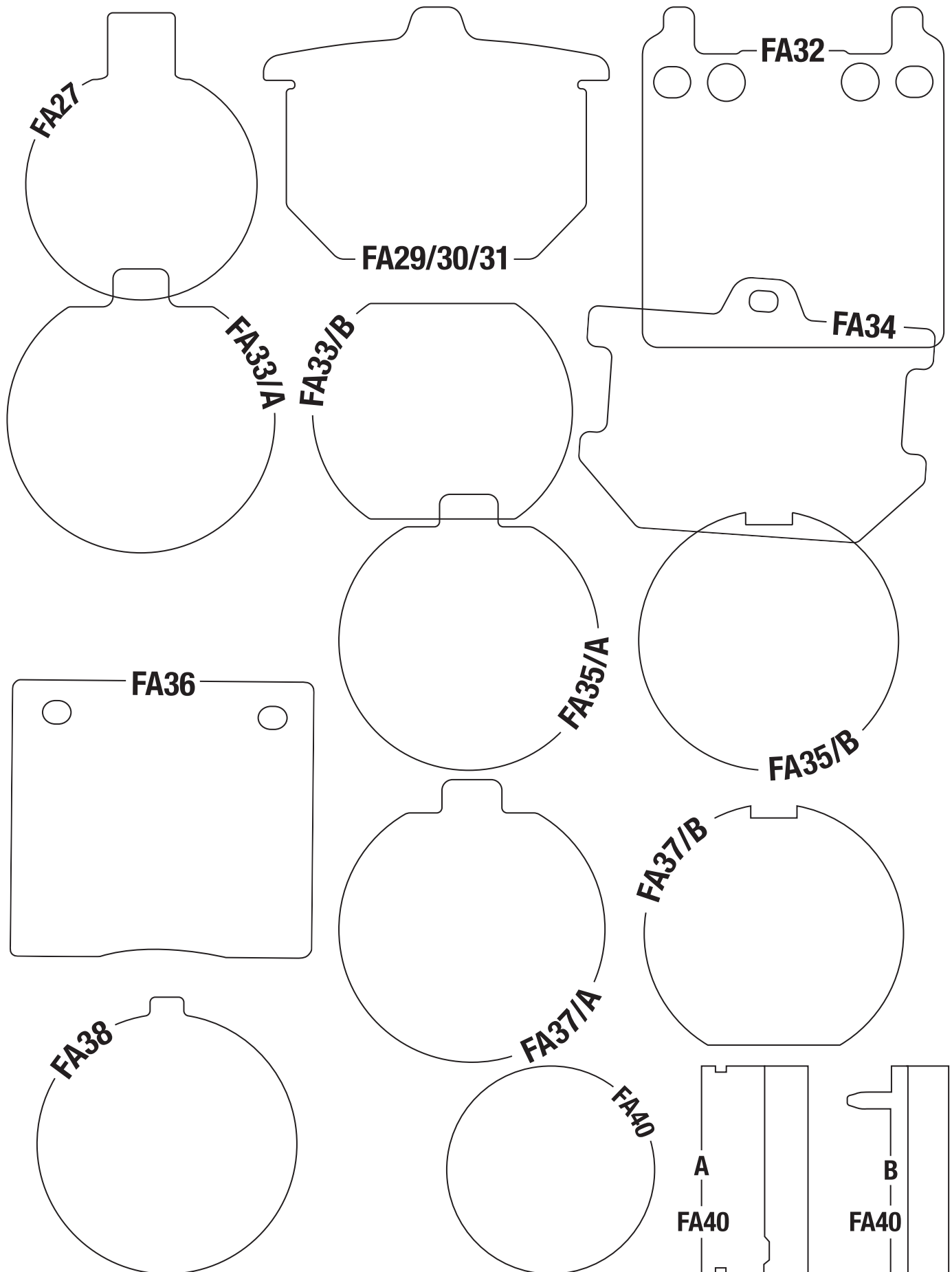

BUYERS GUIDE
BRAKE PADS

EBC FULL SIZE BRAKE PAD ILLUSTRATION – FA41-FA61

BUYERS GUIDE
BRAKE PADS

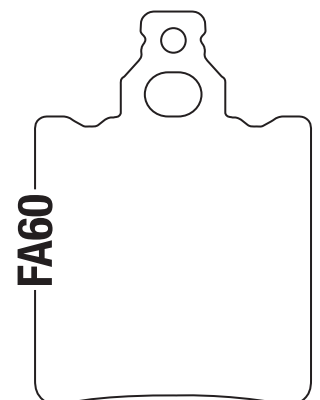
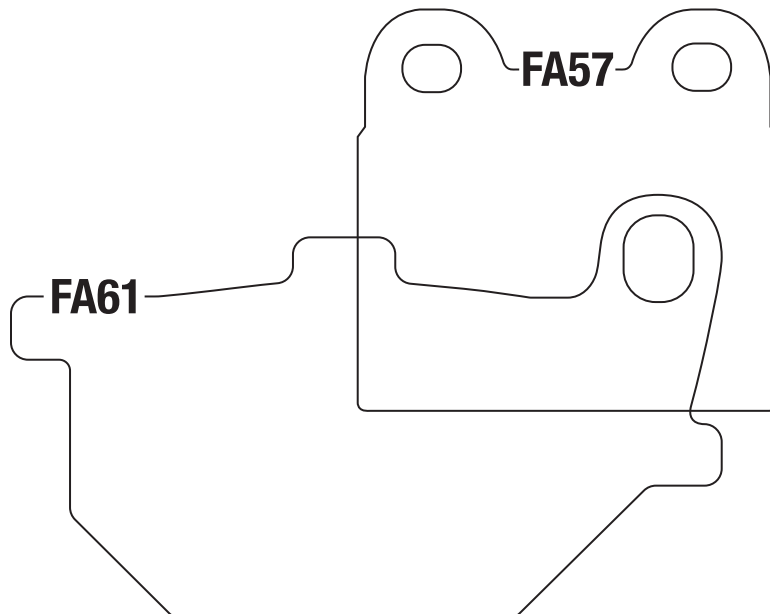
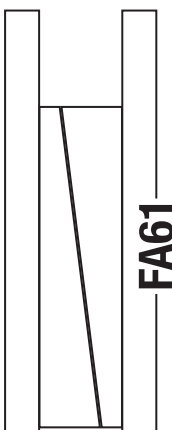
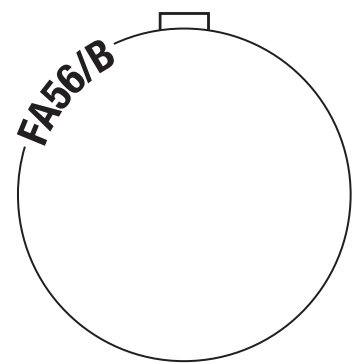
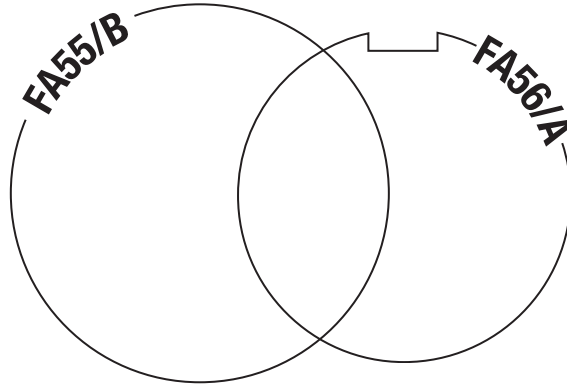
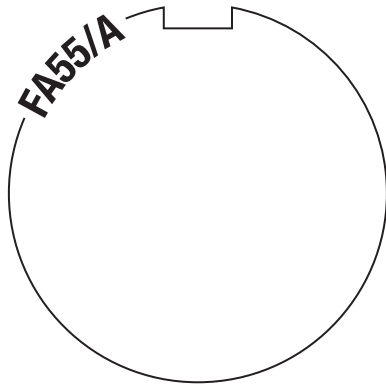
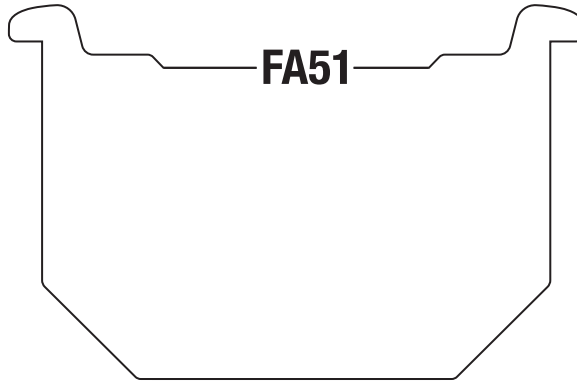
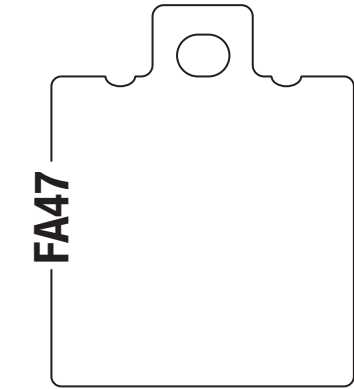
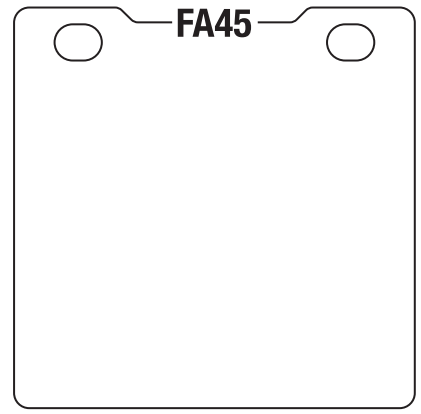
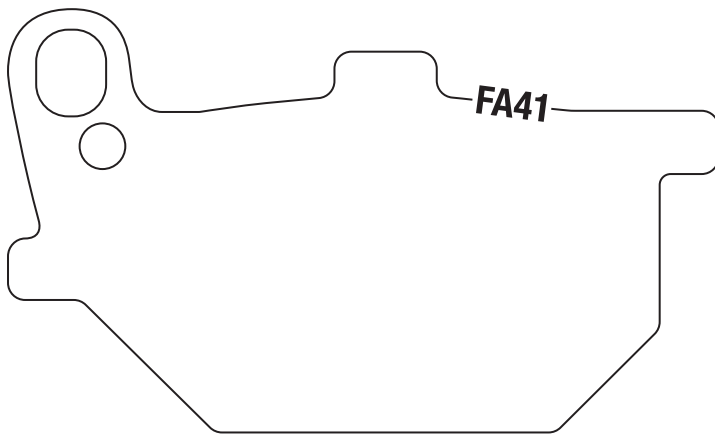
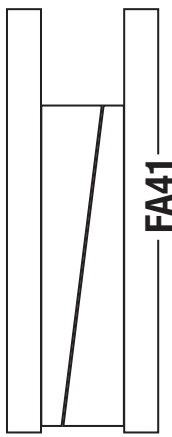

EBC FULL SIZE BRAKE PAD ILLUSTRATION – FA62-FA73

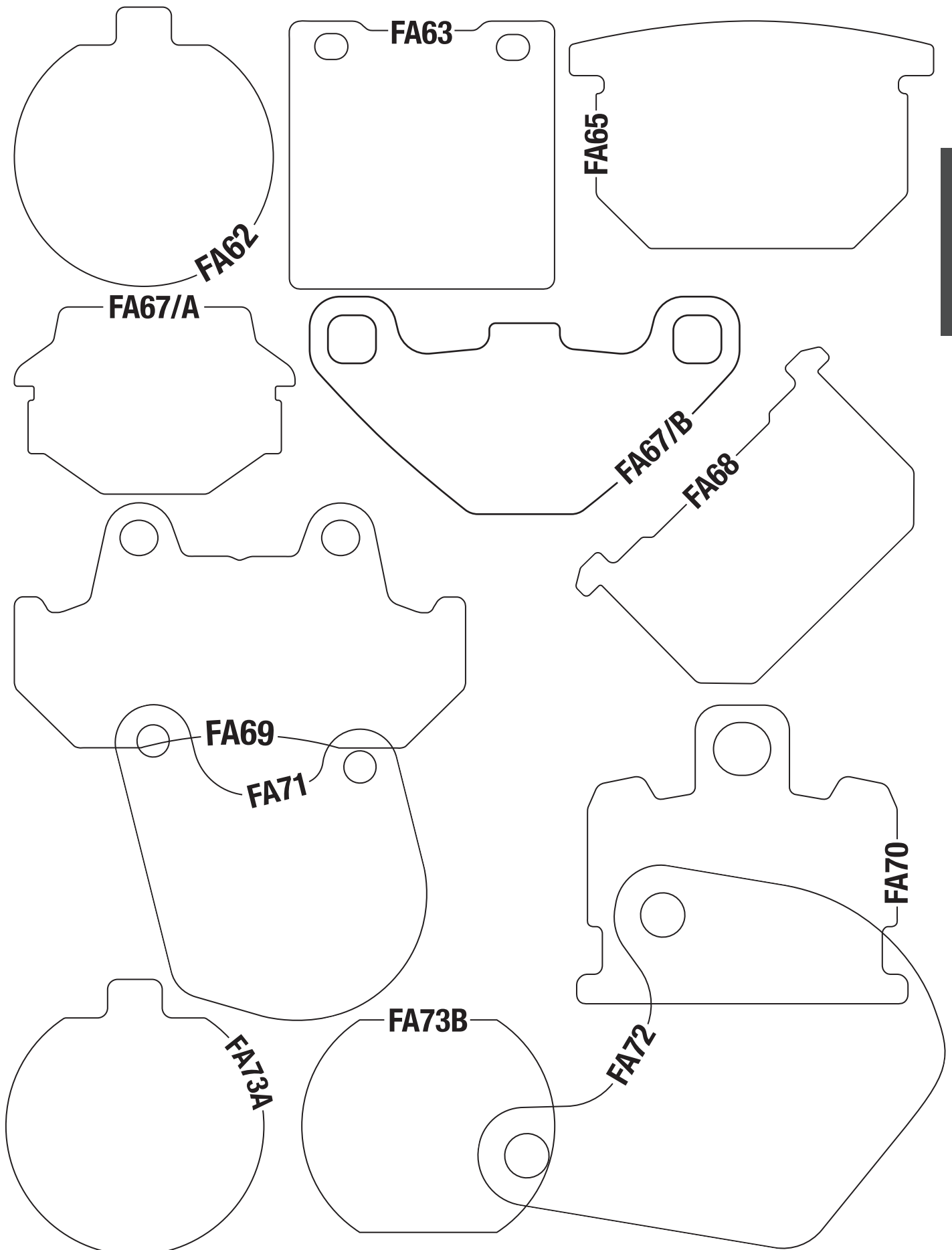

BUYERS GUIDE
BRAKE PADS

EBC FULL SIZE BRAKE PAD ILLUSTRATION – FA76-FA86

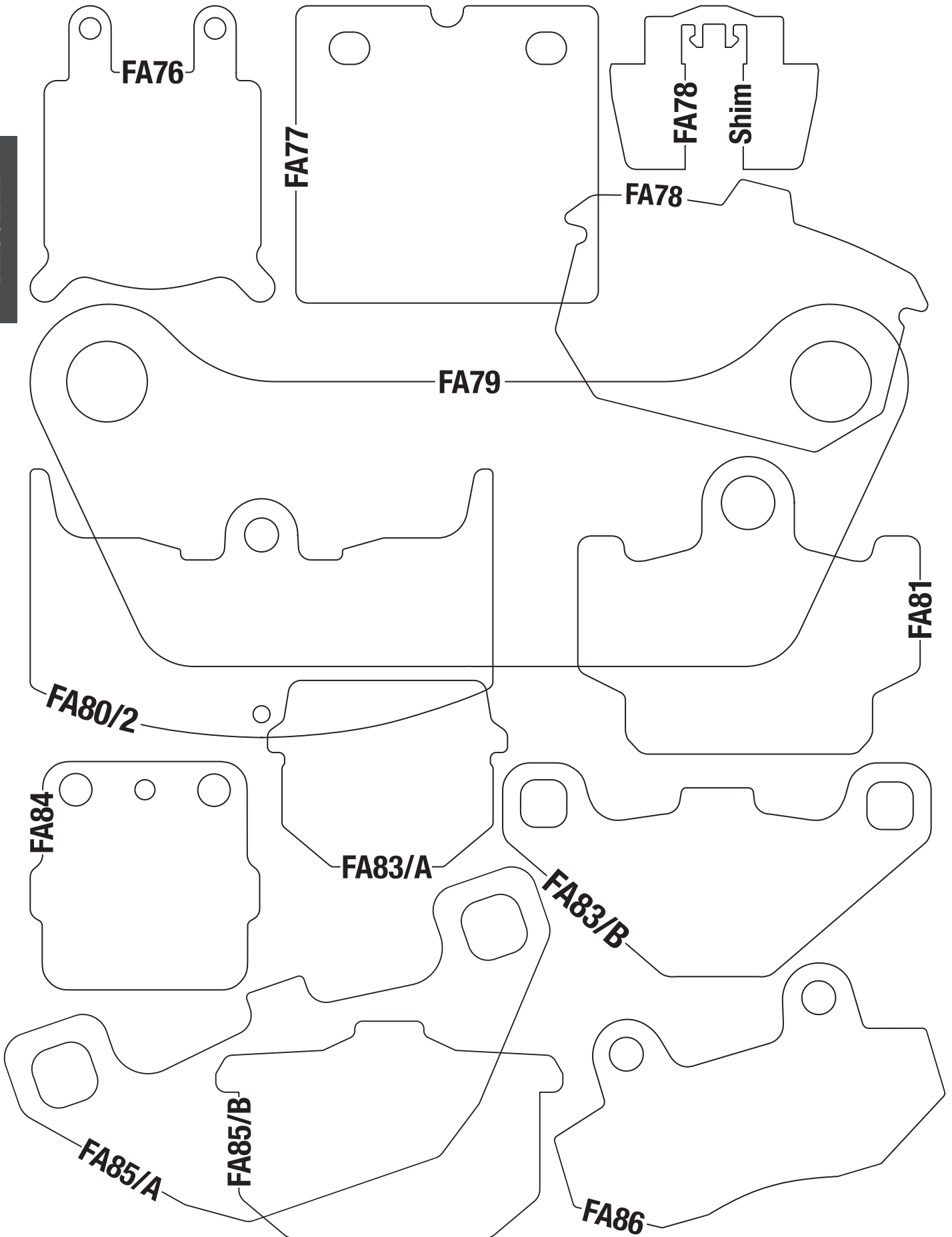

EBC FULL SIZE BRAKE PAD ILLUSTRATION – FA88-FA105

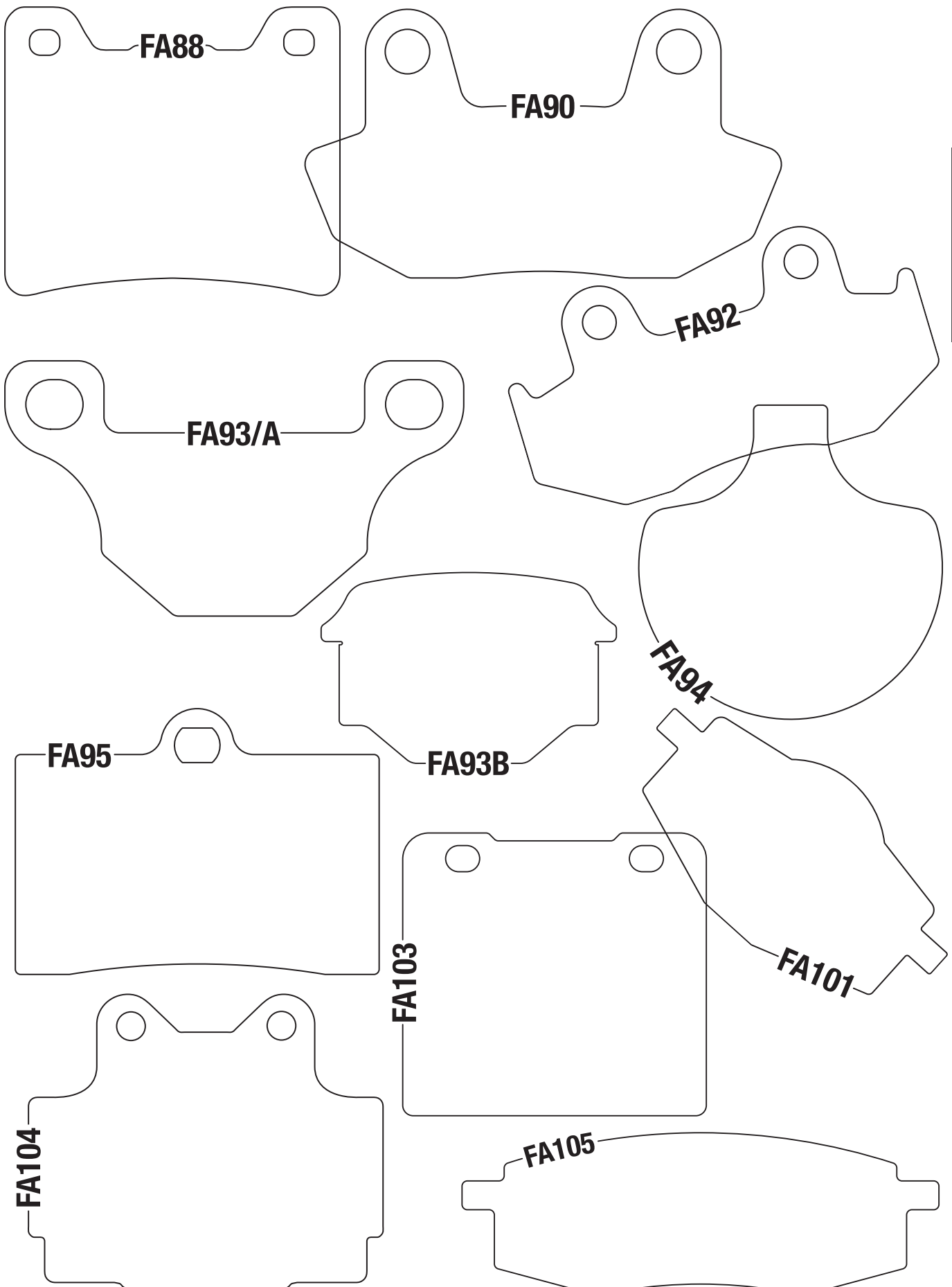

EBC FULL SIZE BRAKE PAD ILLUSTRATION – FA106-FA124

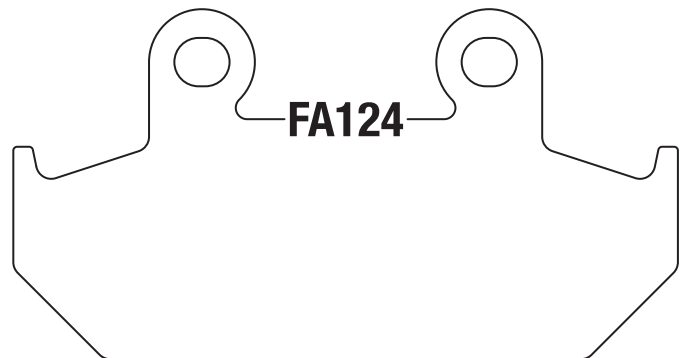
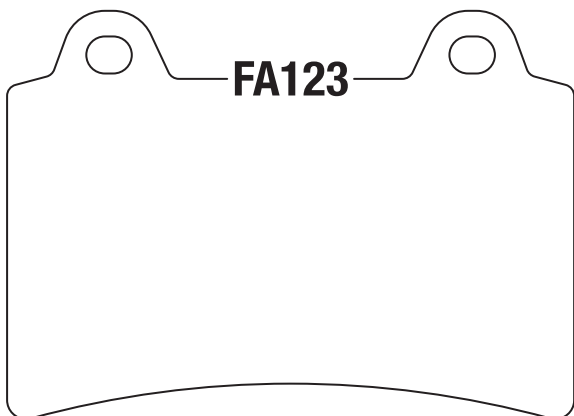
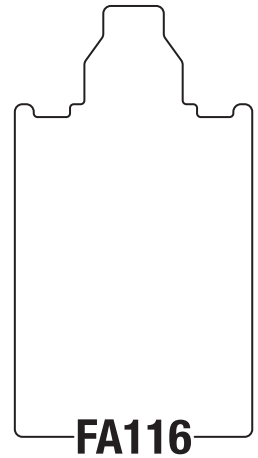
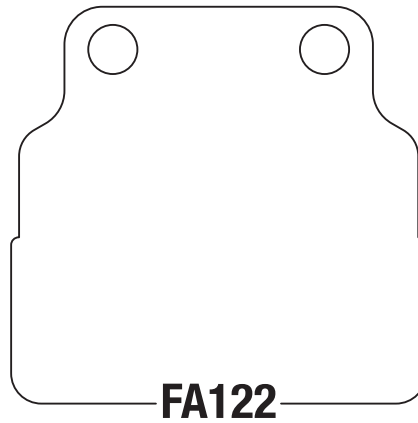
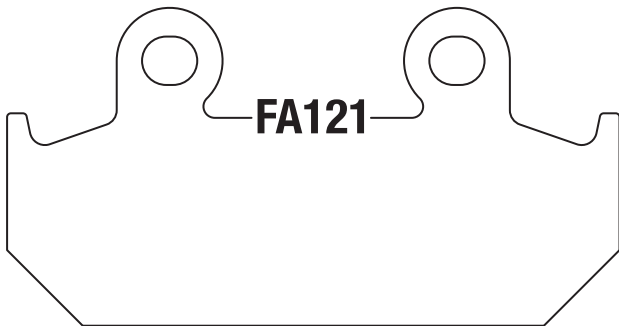
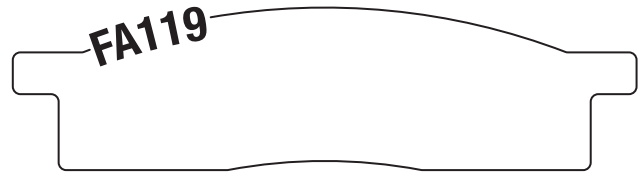
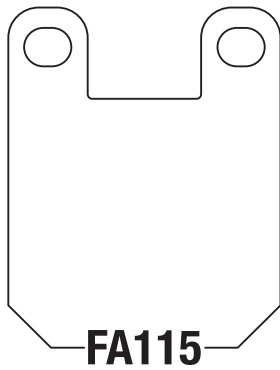
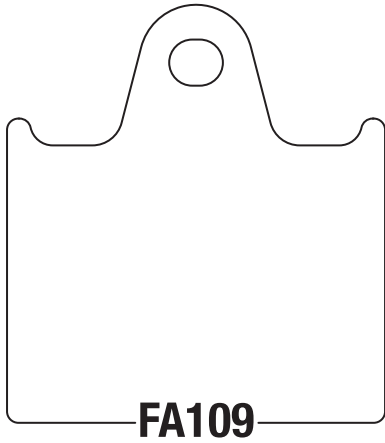
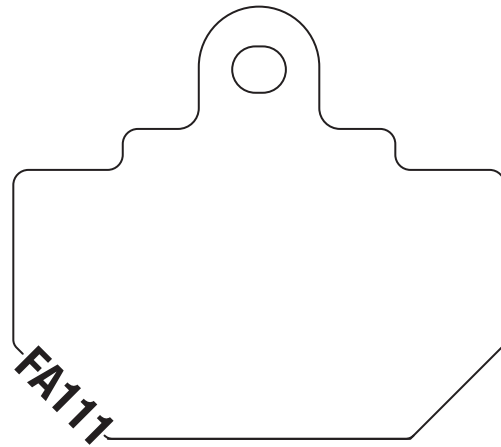
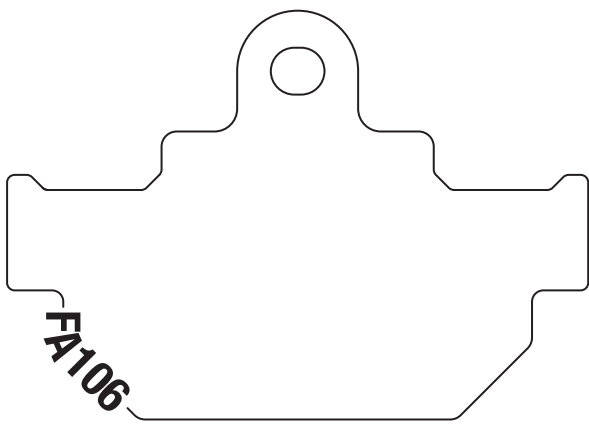

EBC FULL SIZE BRAKE PAD ILLUSTRATION – FA125-FA136

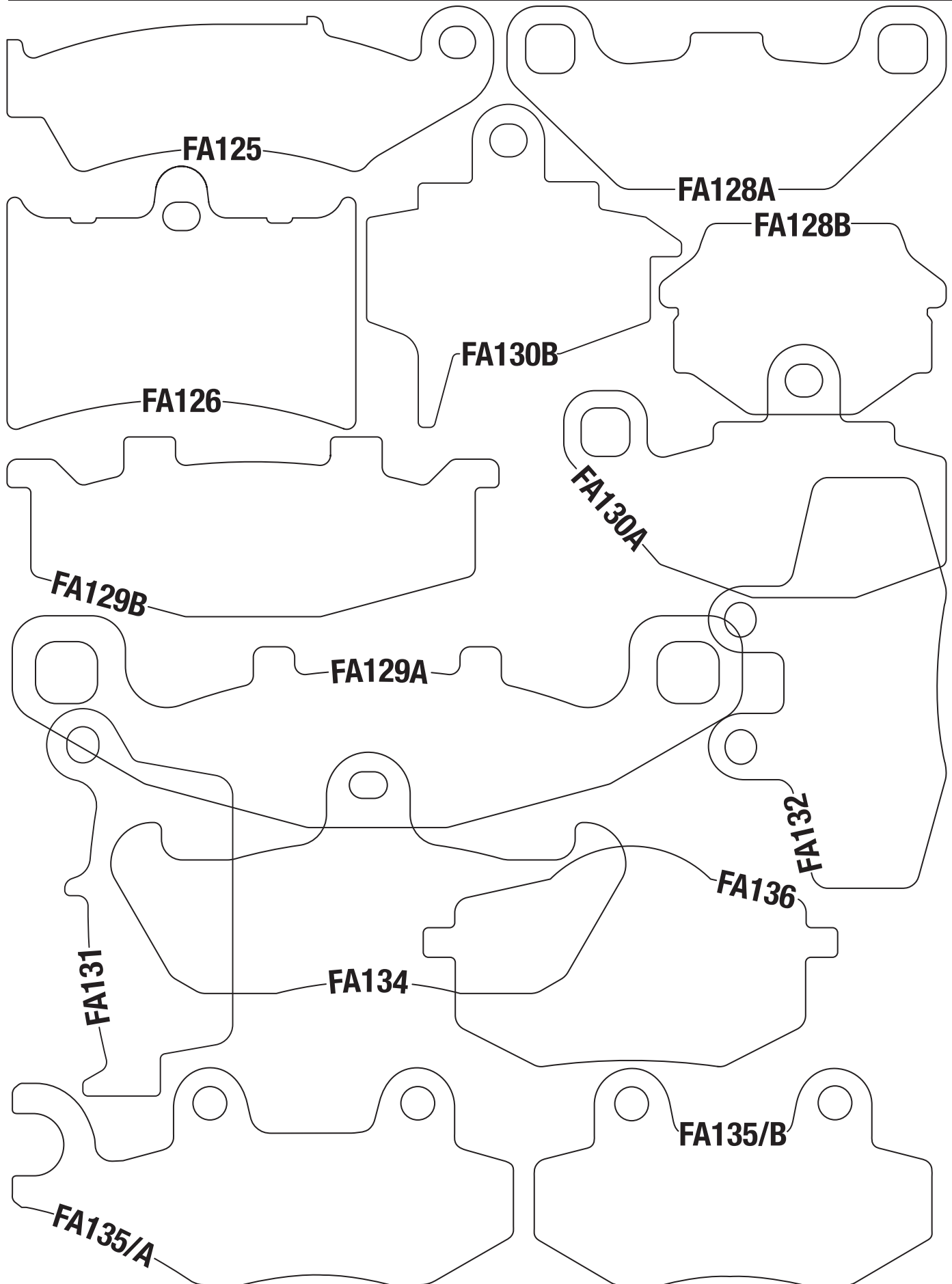

BUYERS GUIDE
BRAKE PADS

EBC FULL SIZE BRAKE PAD ILLUSTRATION – FA137-FA151

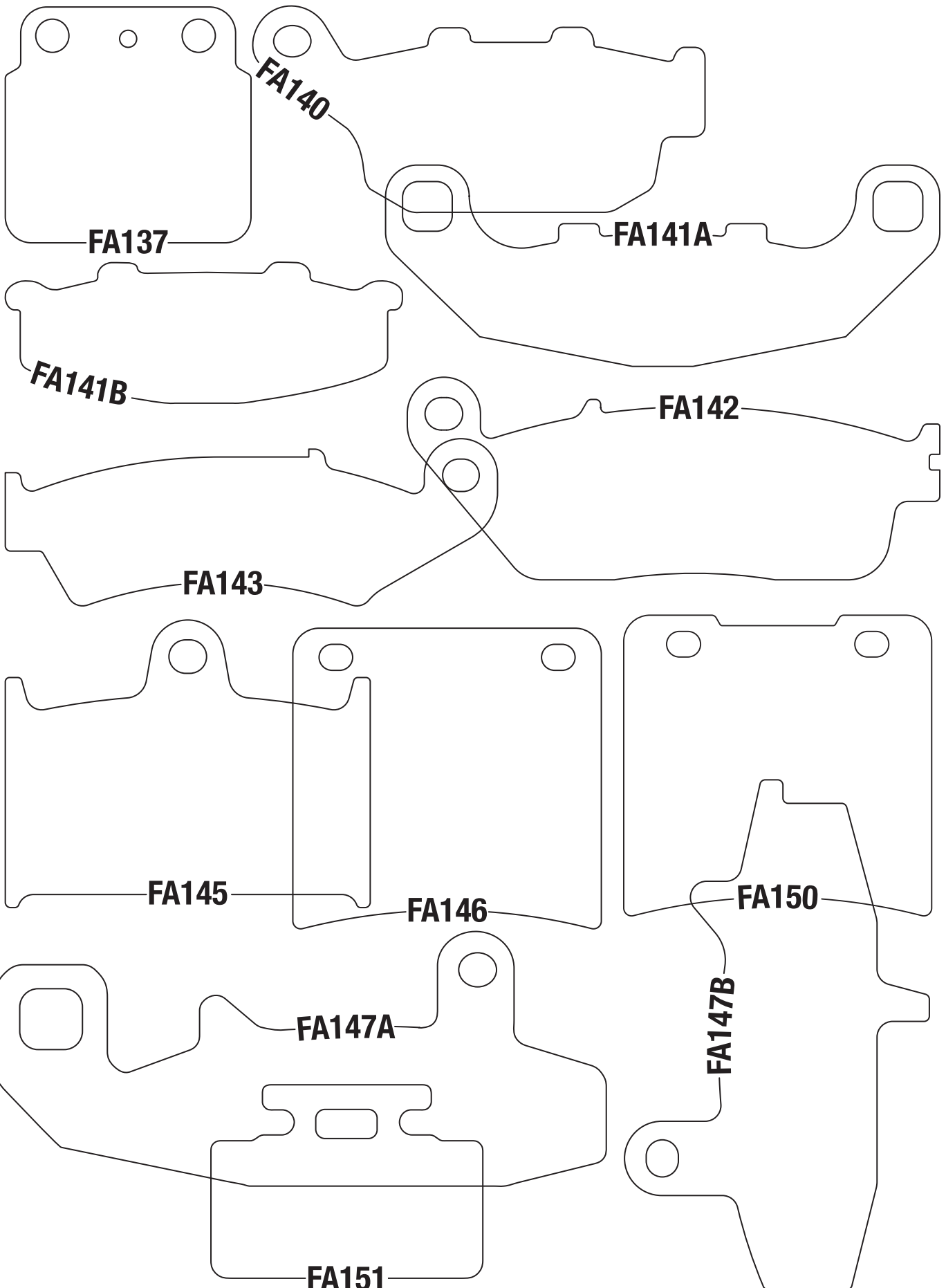

EBC FULL SIZE BRAKE PAD ILLUSTRATION – FA152-FA163

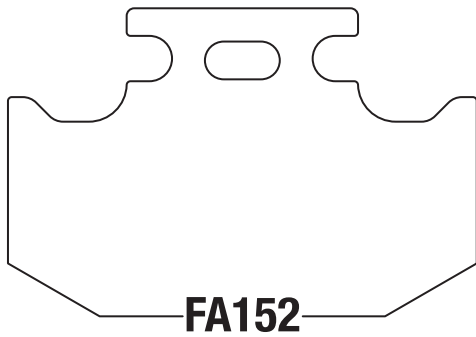

FA152

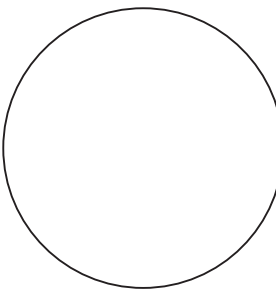

FA155

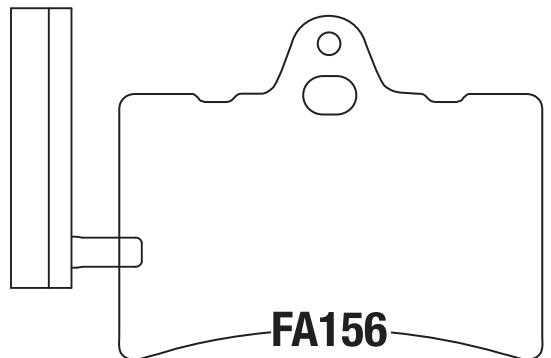

FA156

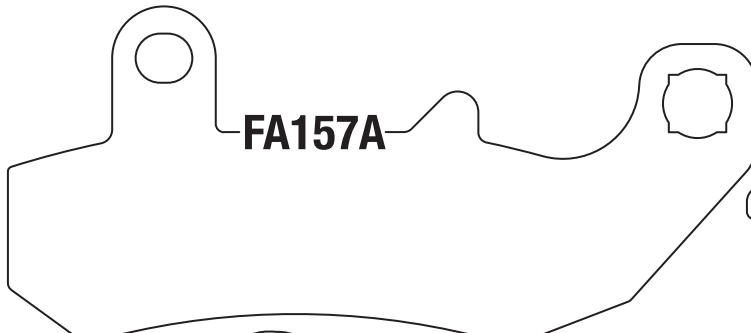

FA157A

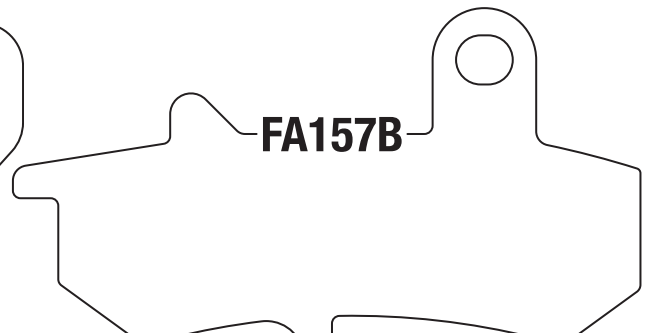

FA157B

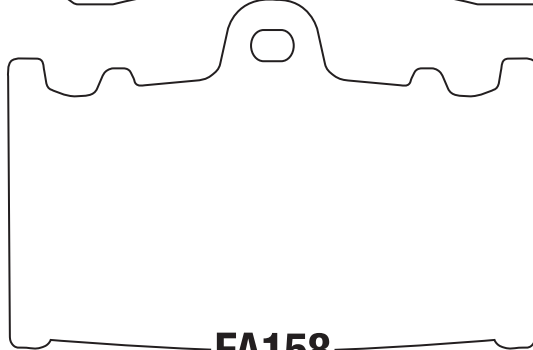

FA158



FA159

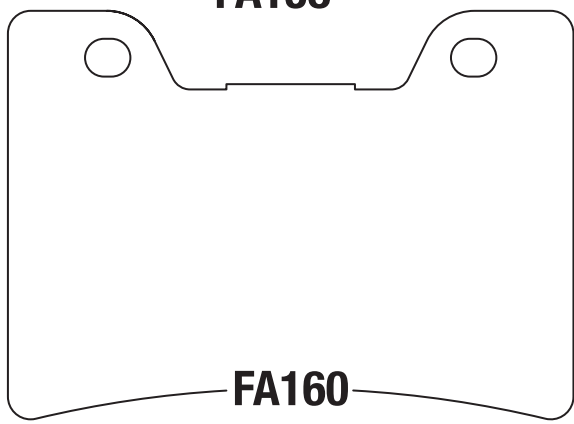

FA160

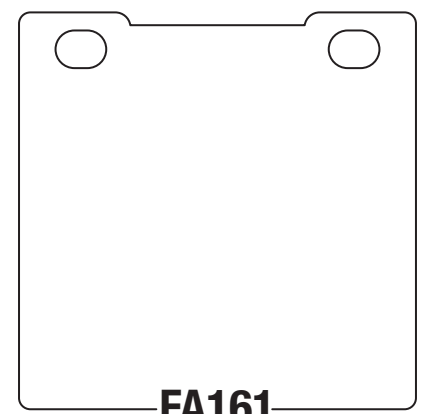

FA161

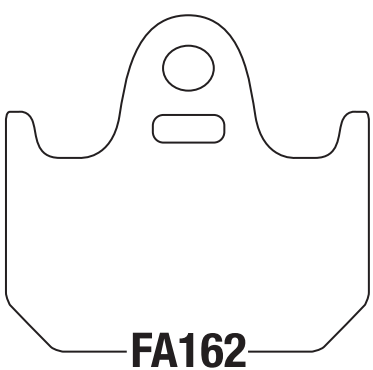

FA162

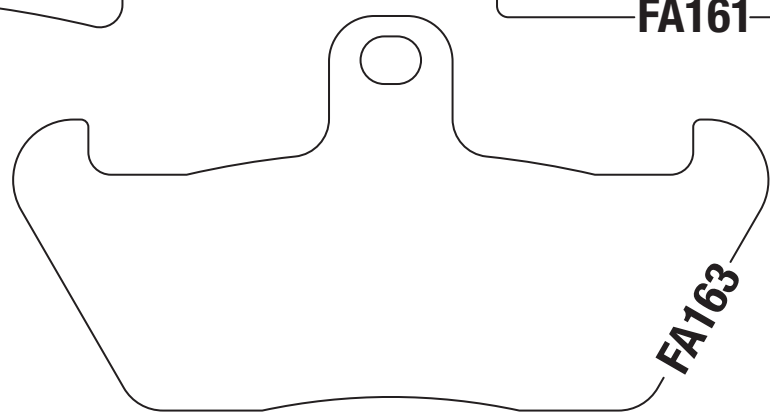

FA163

EBC FULL SIZE BRAKE PAD ILLUSTRATION – FA164-FA177

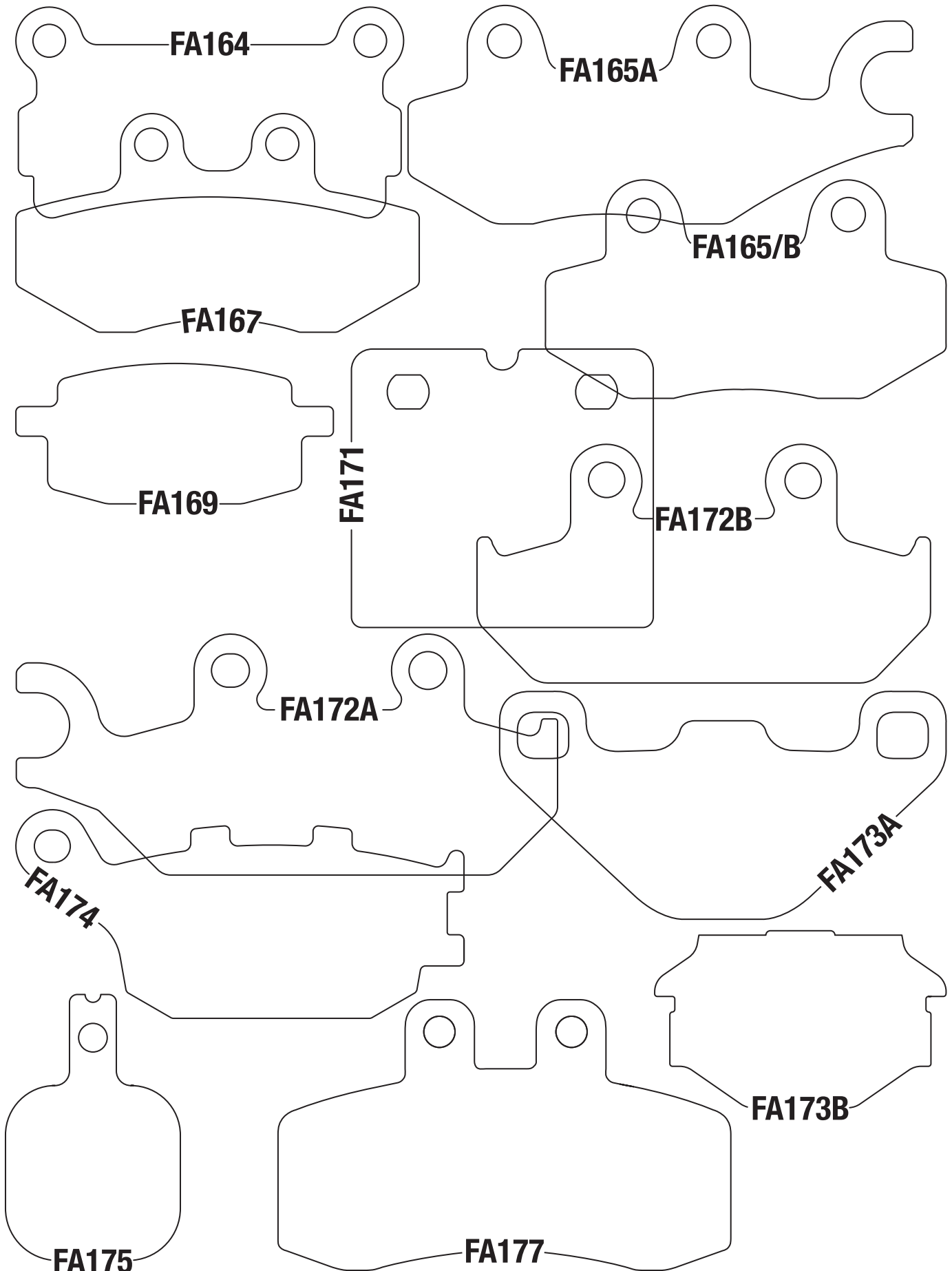

EBC FULL SIZE BRAKE PAD ILLUSTRATION – FA179-FA189

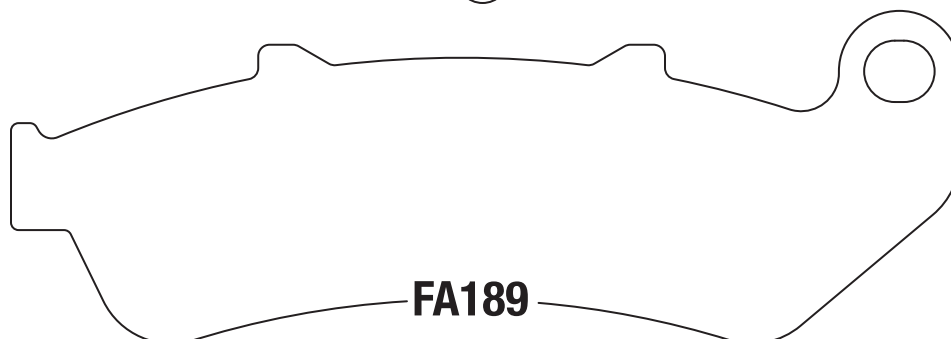
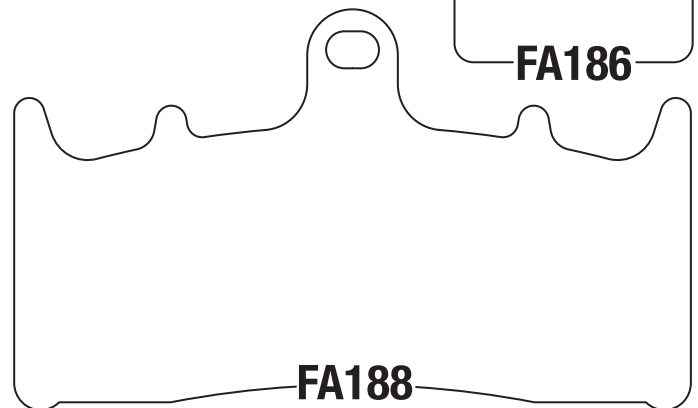
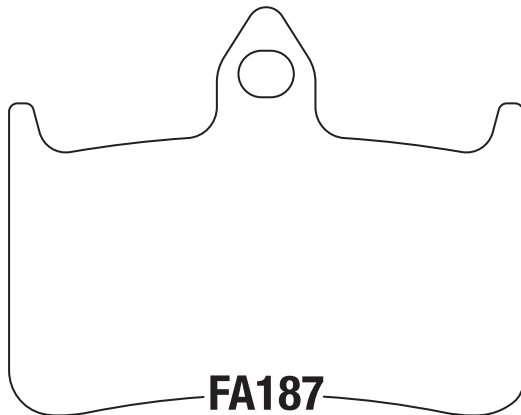
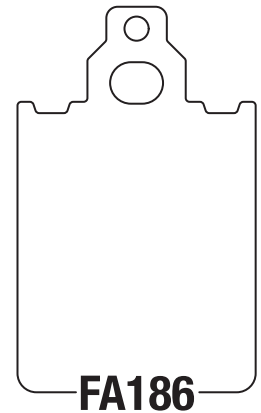
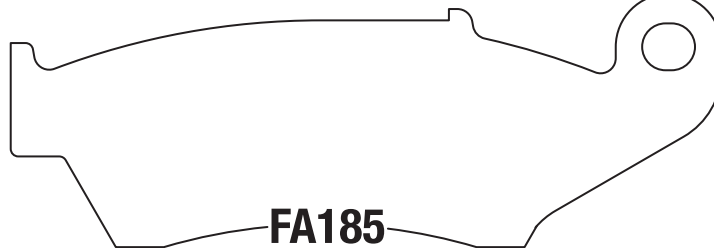
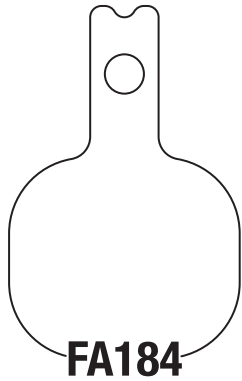
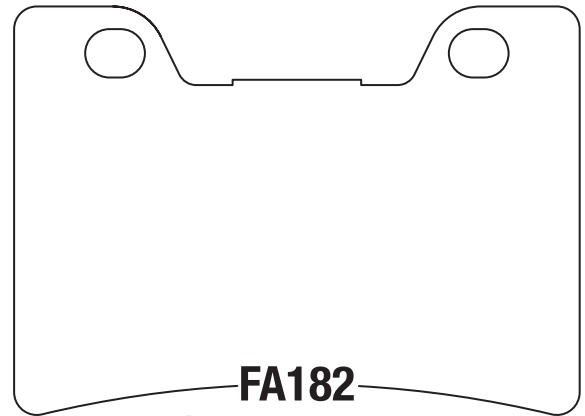
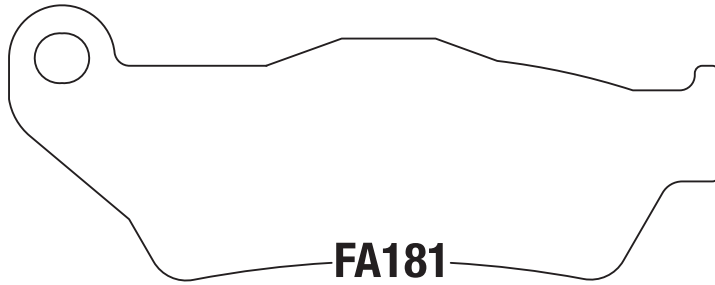
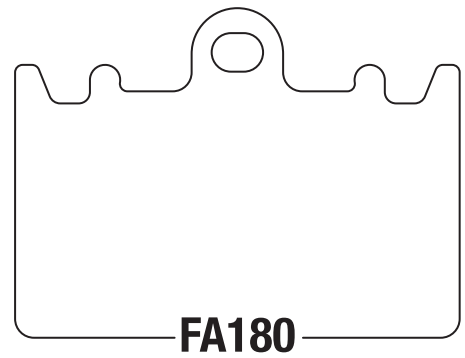
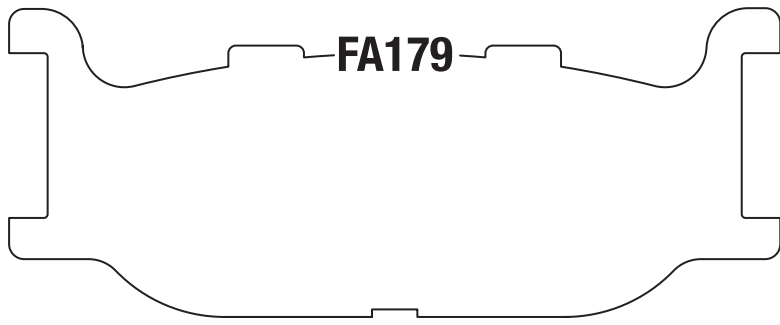

EBC FULL SIZE BRAKE PAD ILLUSTRATION – FA190-FA201

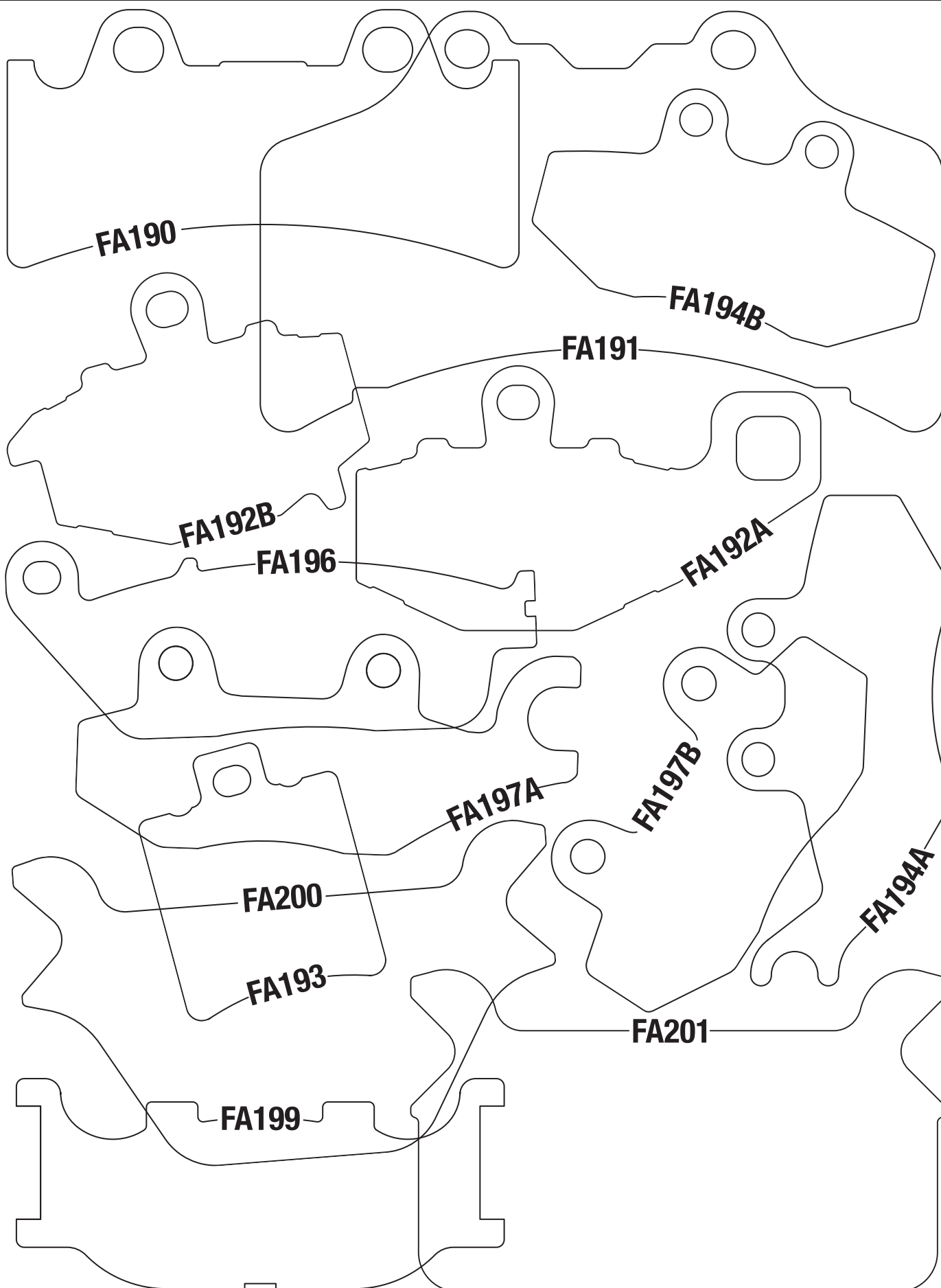

EBC FULL SIZE BRAKE PAD ILLUSTRATION – FA203-FA222

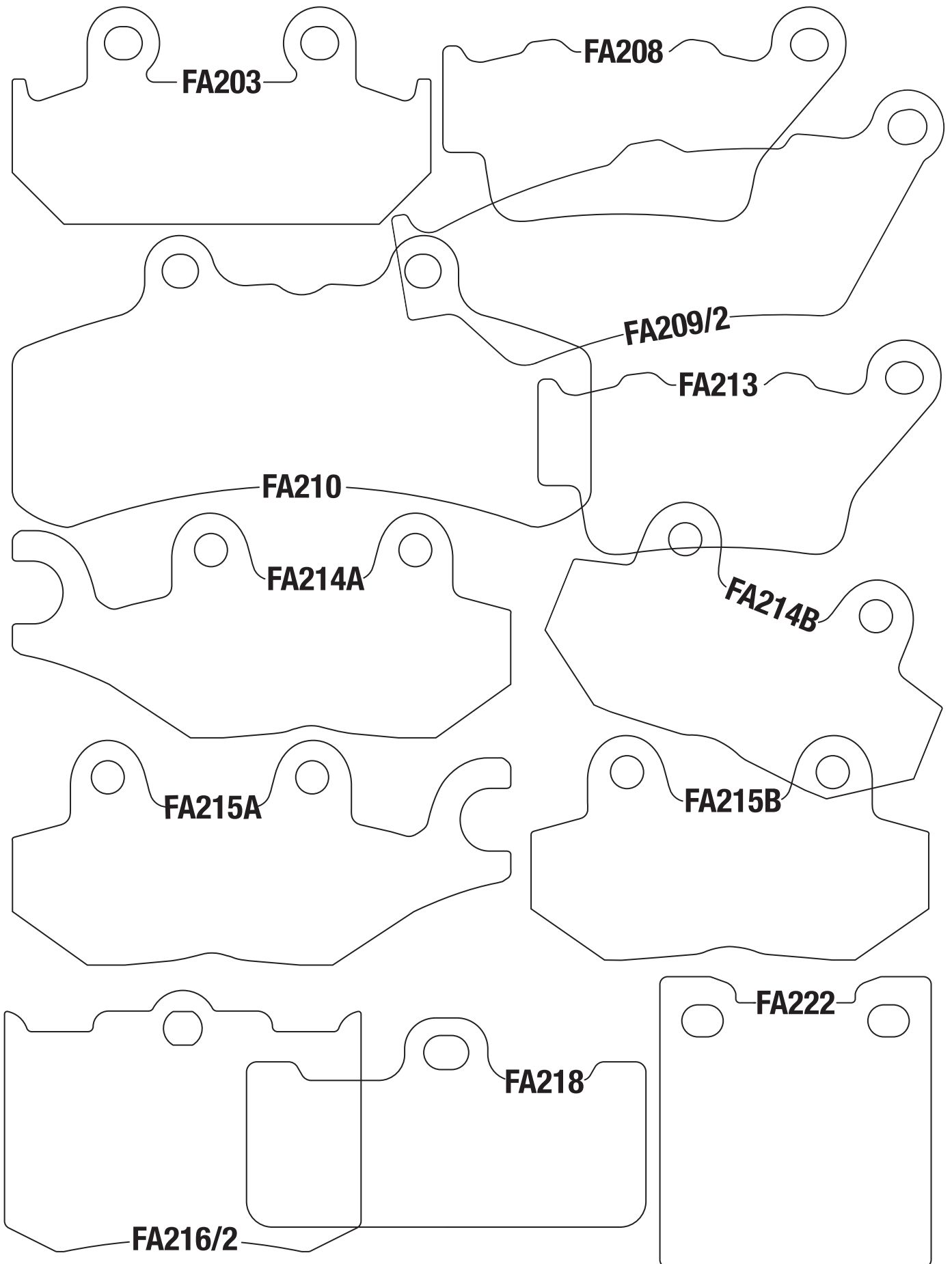

BUYERS GUIDE
BRAKE PADS

EBC FULL SIZE BRAKE PAD ILLUSTRATION – FA226-FA239

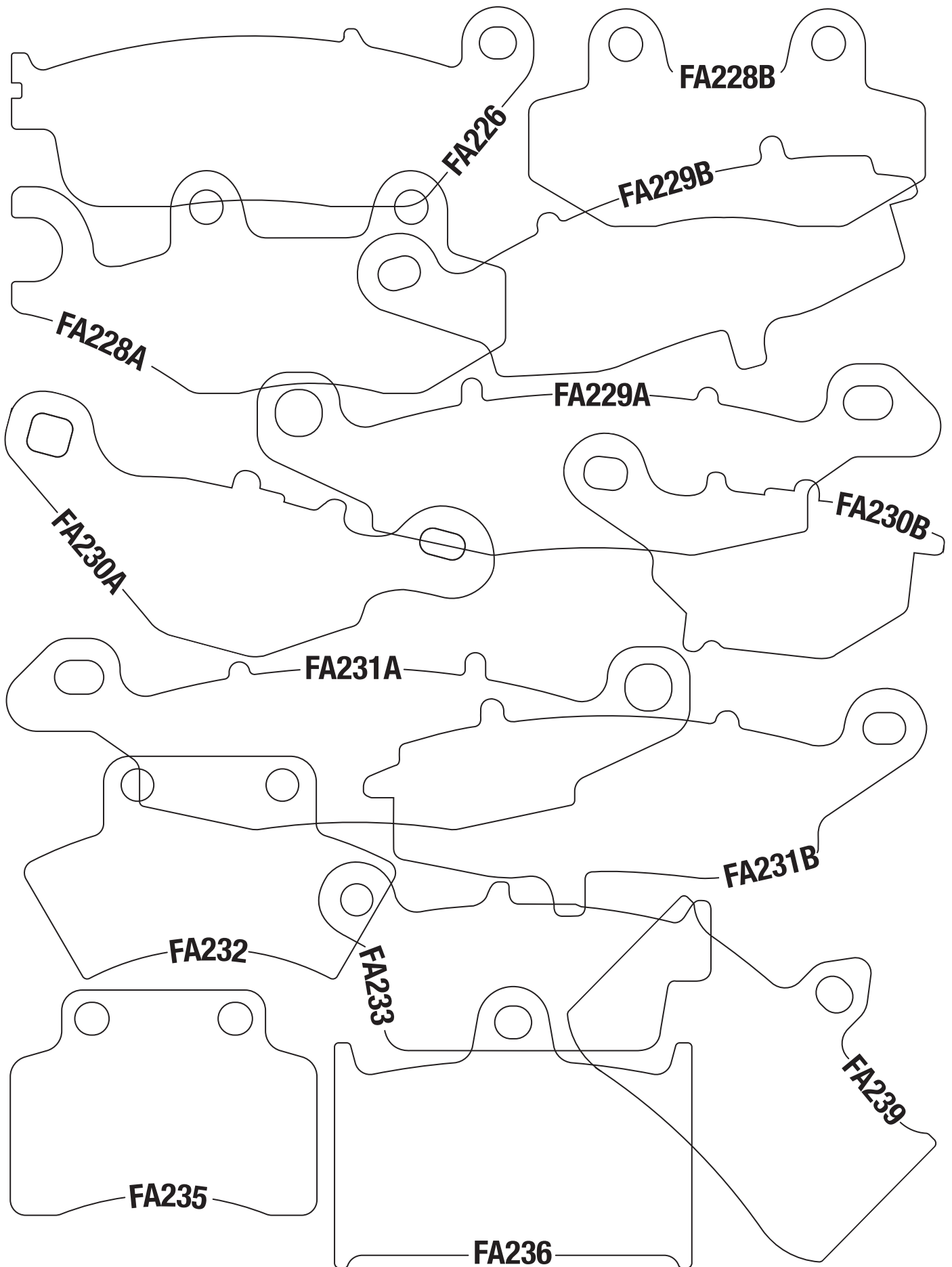

Part numbers, prefixes, suffixes, photos and illustrations shown in this catalog are trademarks and/or copyrights of EBC Brakes or the trademark owner A C Freeman Investments Ltd and use without express written permission of the owners is punishable by law.

EBC FULL SIZE BRAKE PAD ILLUSTRATION – FA243-FA258

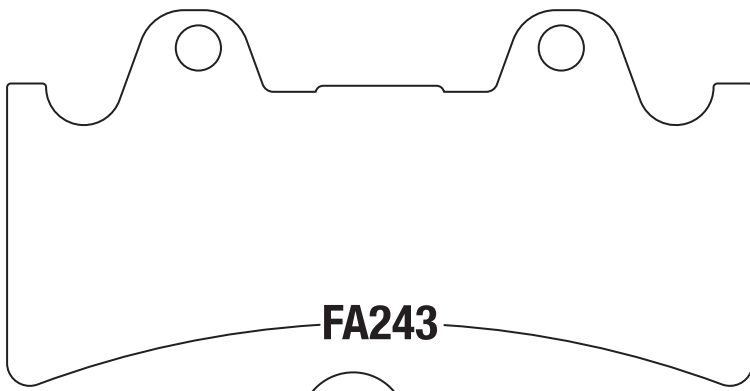

FA243

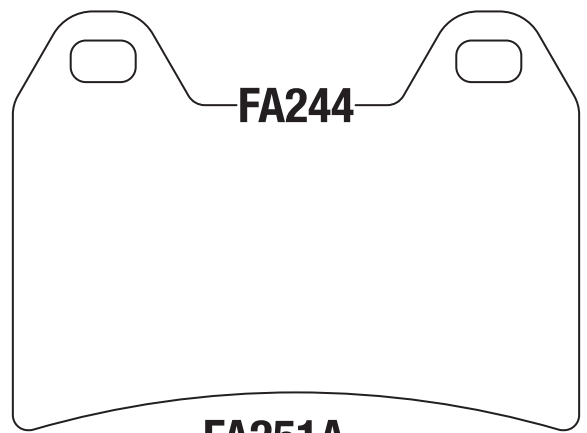

FA244

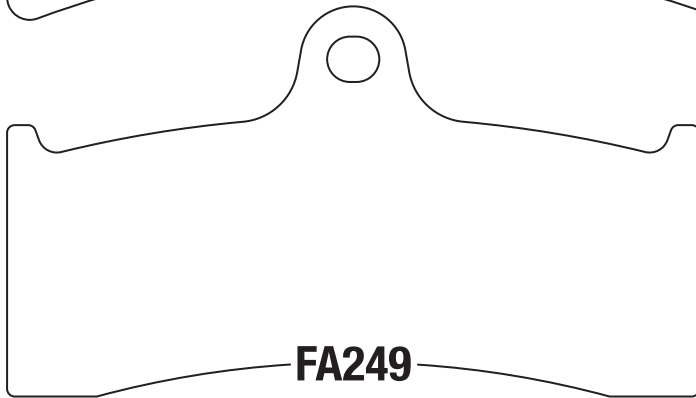

FA249

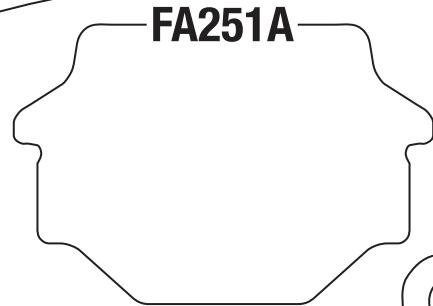

FA251A

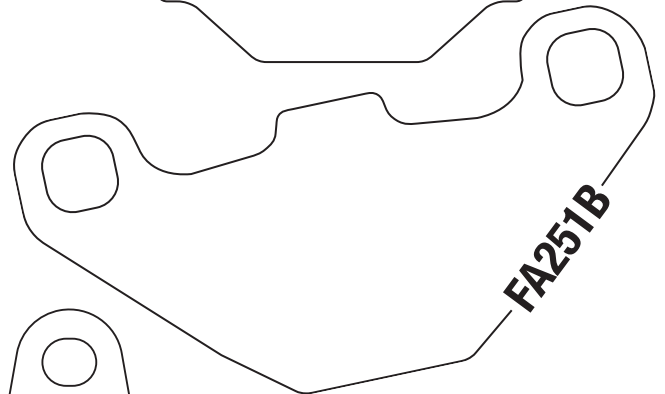

FA251B

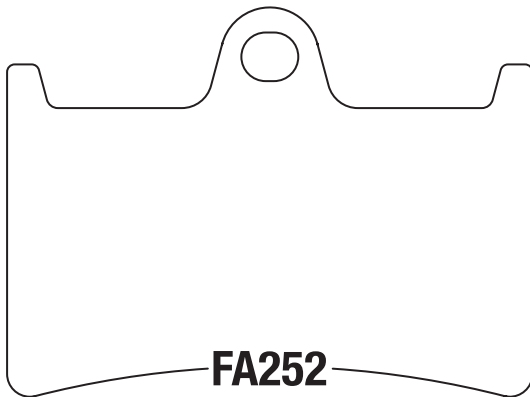

FA252

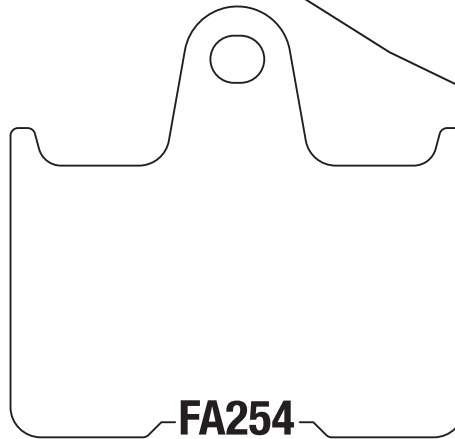

FA254



FA257

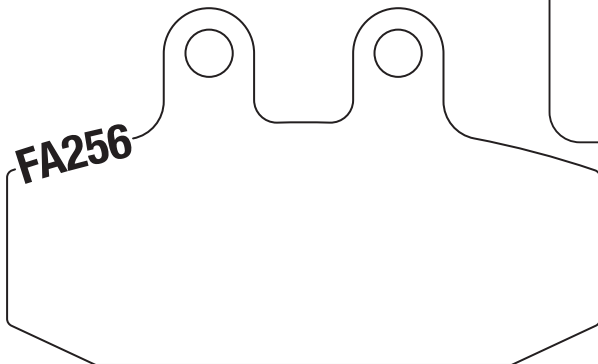

FA256

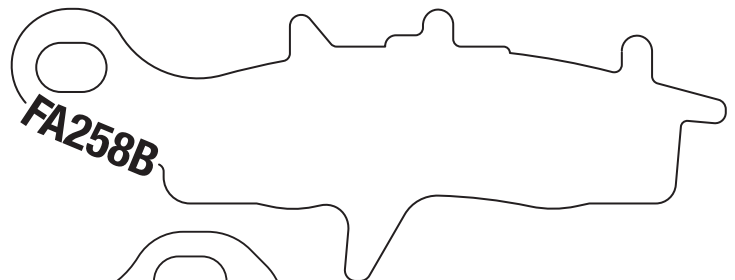

FA258B

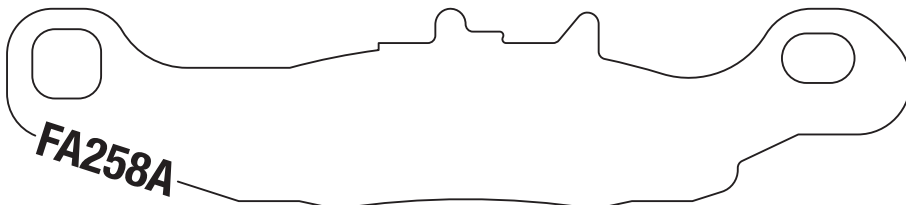

FA258A

EBC FULL SIZE BRAKE PAD ILLUSTRATION – FA260-FA271

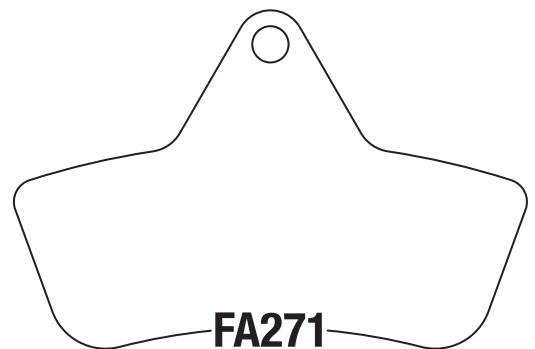
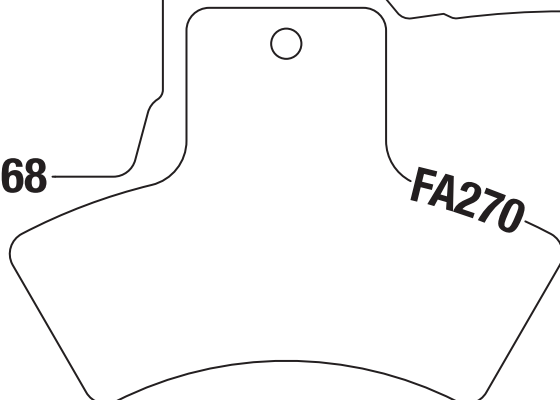
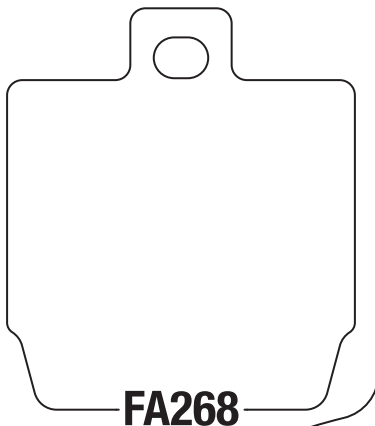
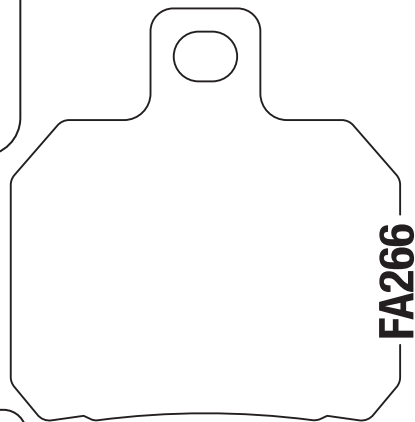
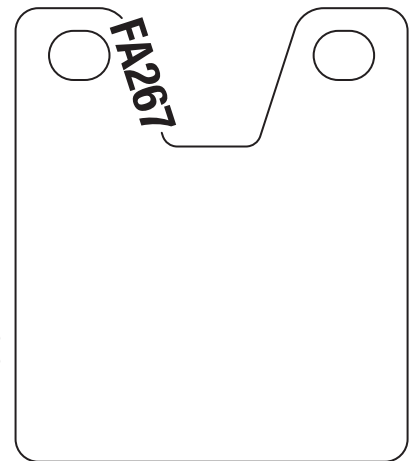
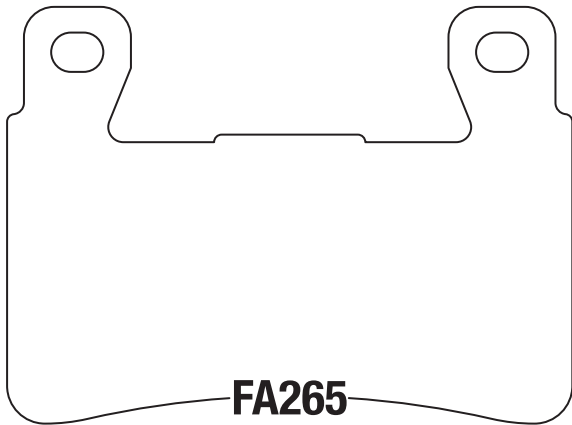
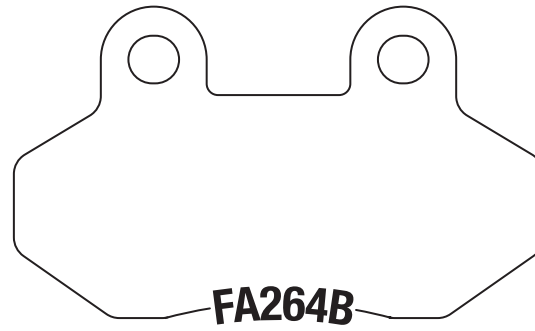
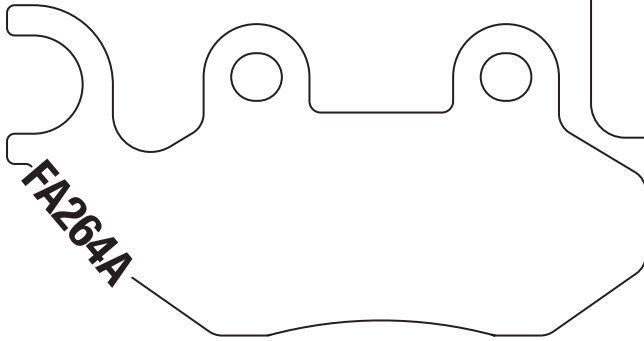
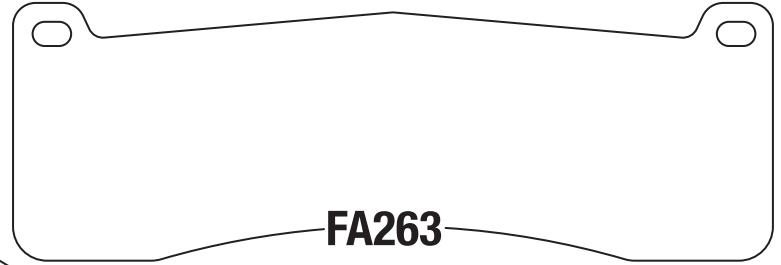
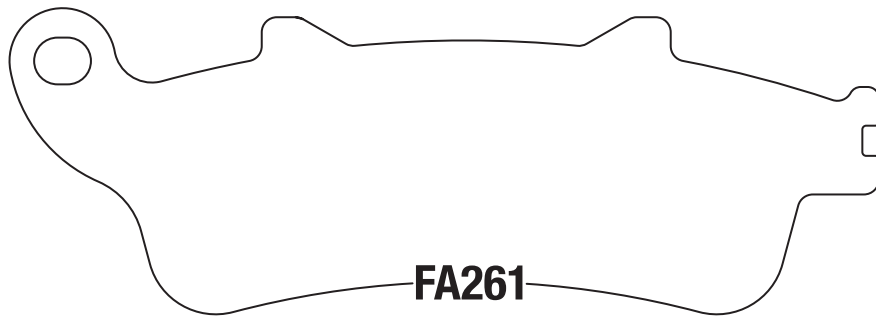
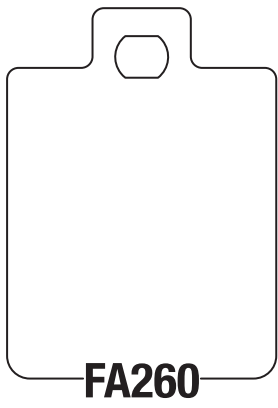

EBC FULL SIZE BRAKE PAD ILLUSTRATION – FA272-FA296

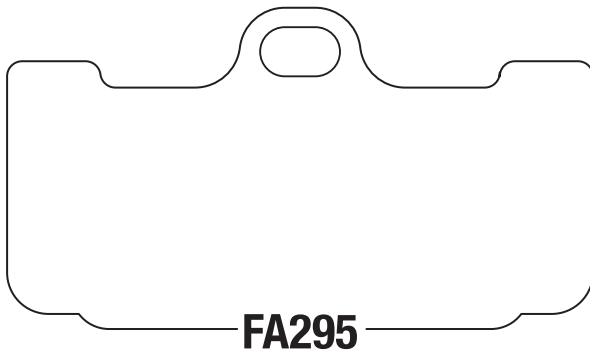
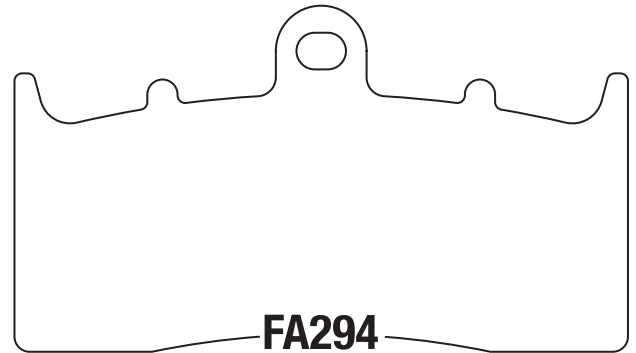
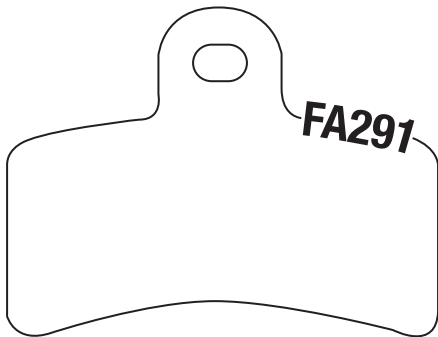
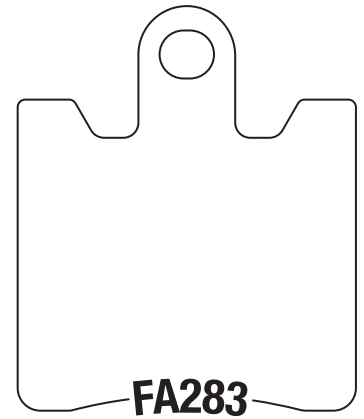
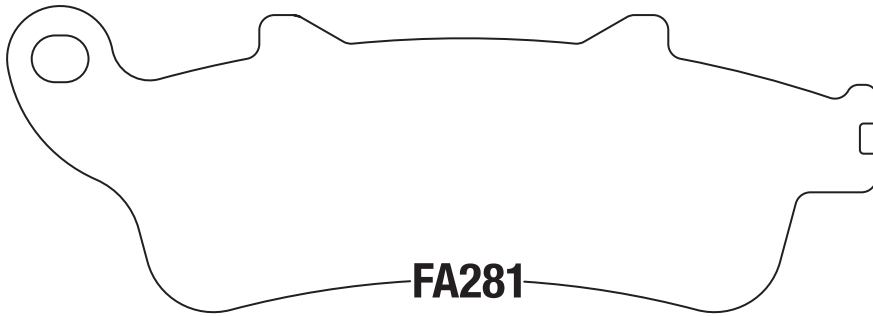
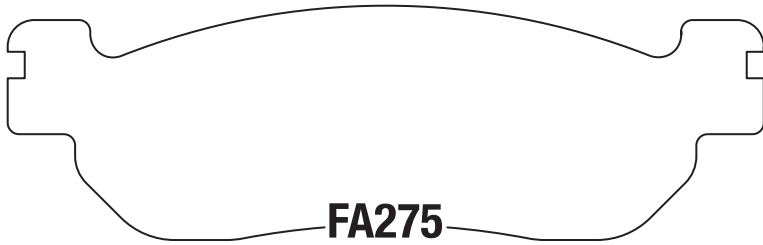
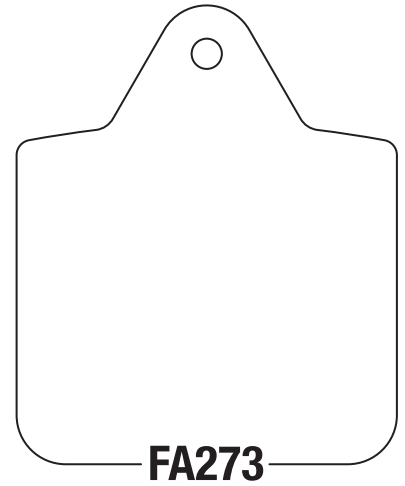

EBC FULL SIZE BRAKE PAD ILLUSTRATION – FA298-FA314

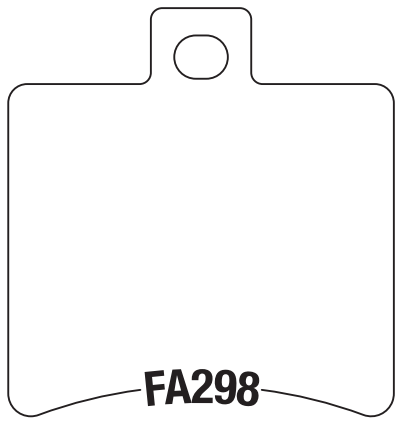

FA298



FA301

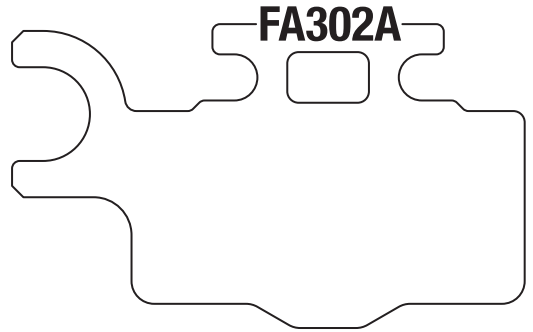

FA302A



FA304



FA303

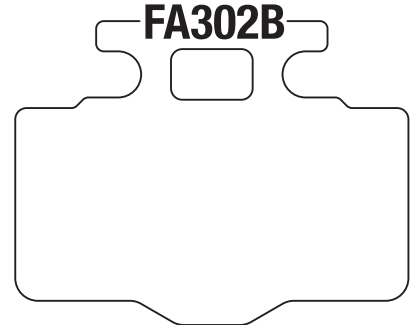

FA302B

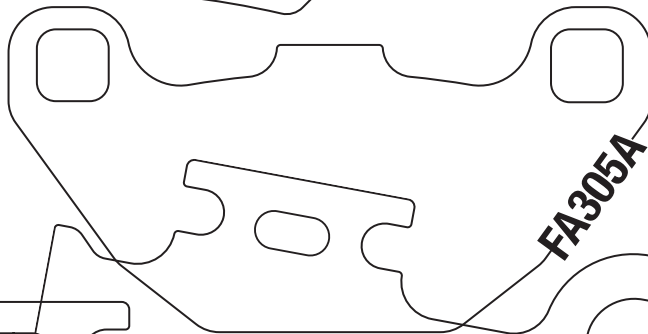

FA305A

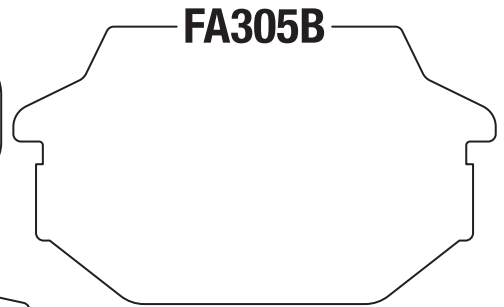

FA305B

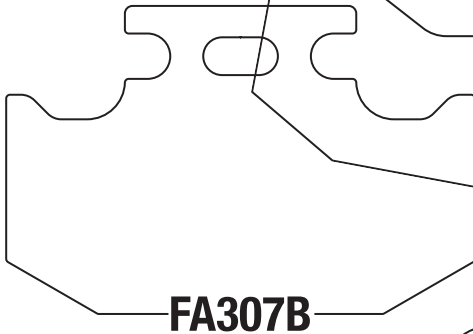

FA307B

FA307A

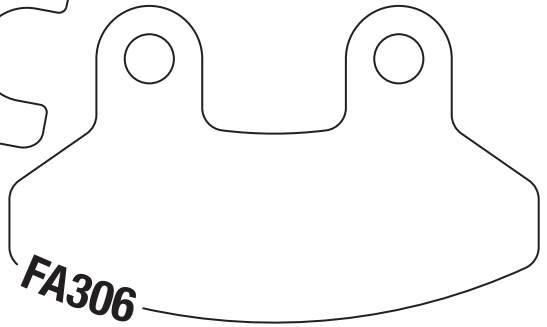

FA306

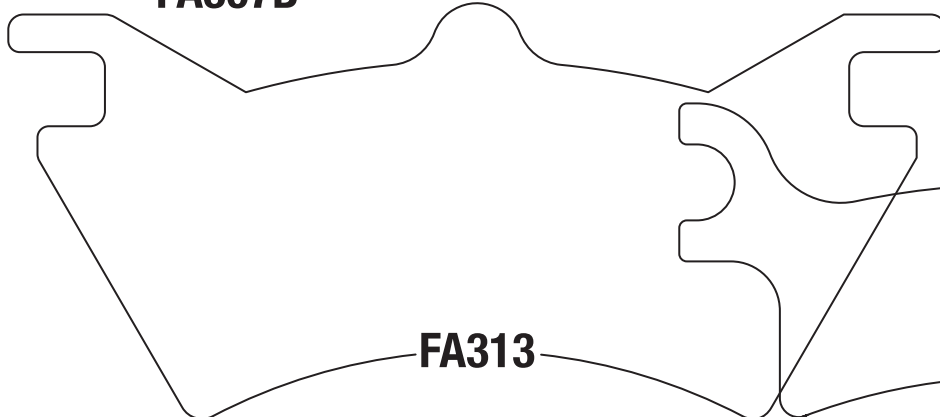

FA313

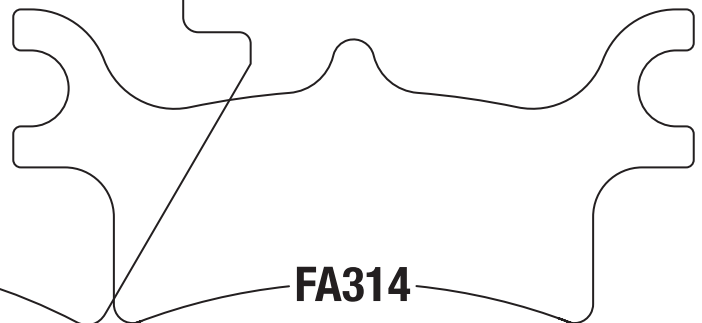

FA314

EBC FULL SIZE BRAKE PAD ILLUSTRATION – FA317-FA335

BUYERS GUIDE
BRAKE PADS

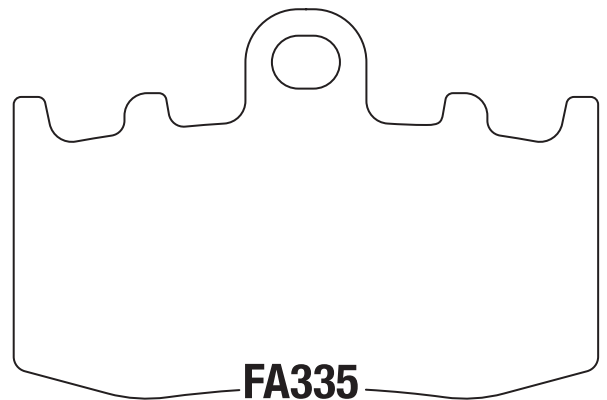
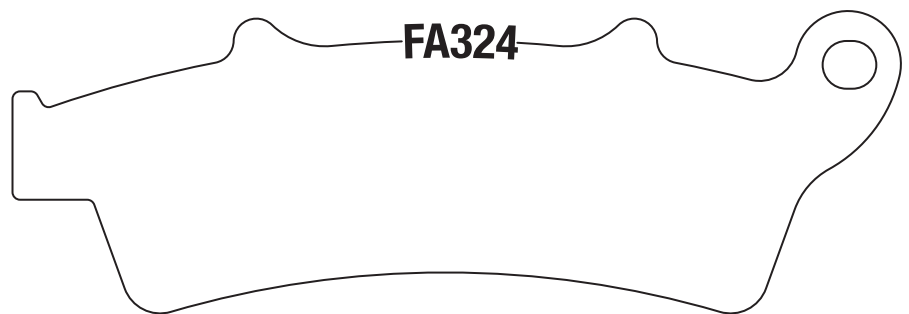
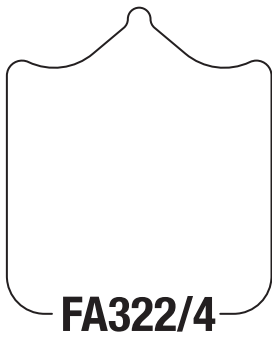
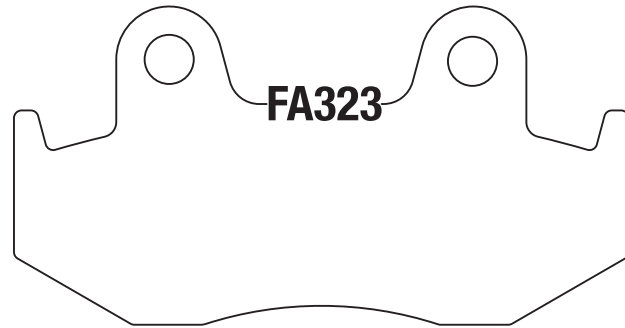
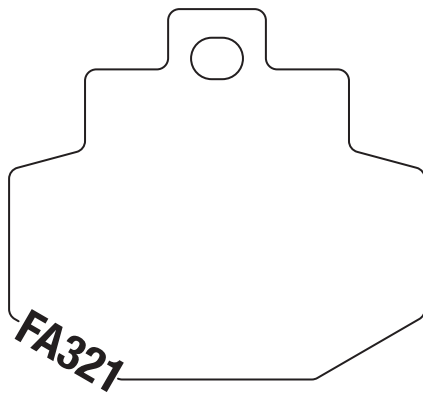
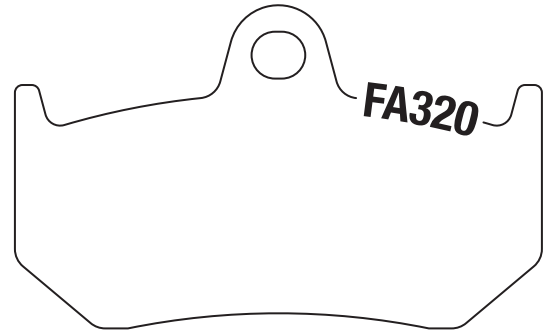
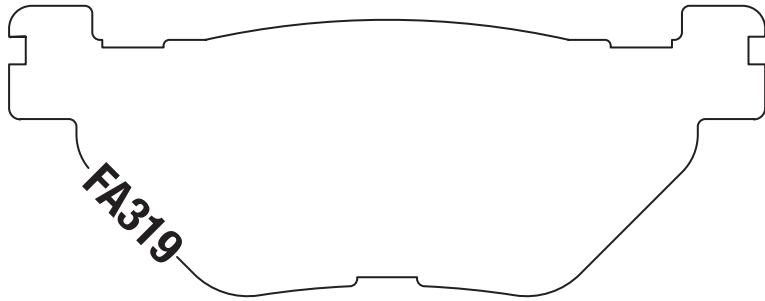
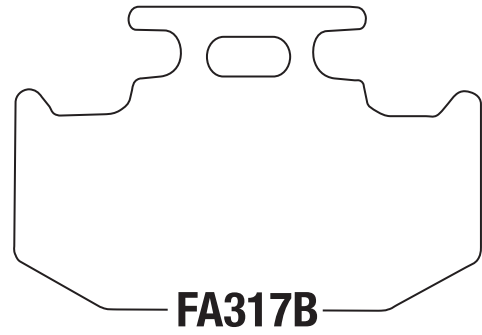
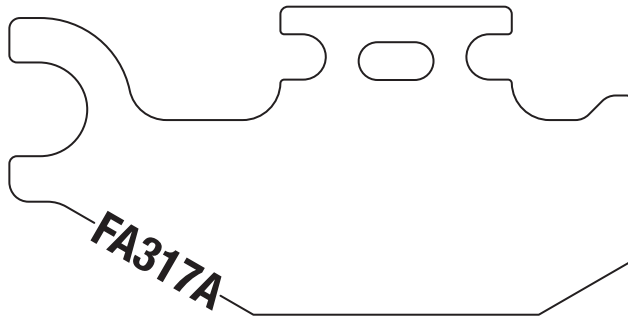

EBC FULL SIZE BRAKE PAD ILLUSTRATION – FA337-FA350

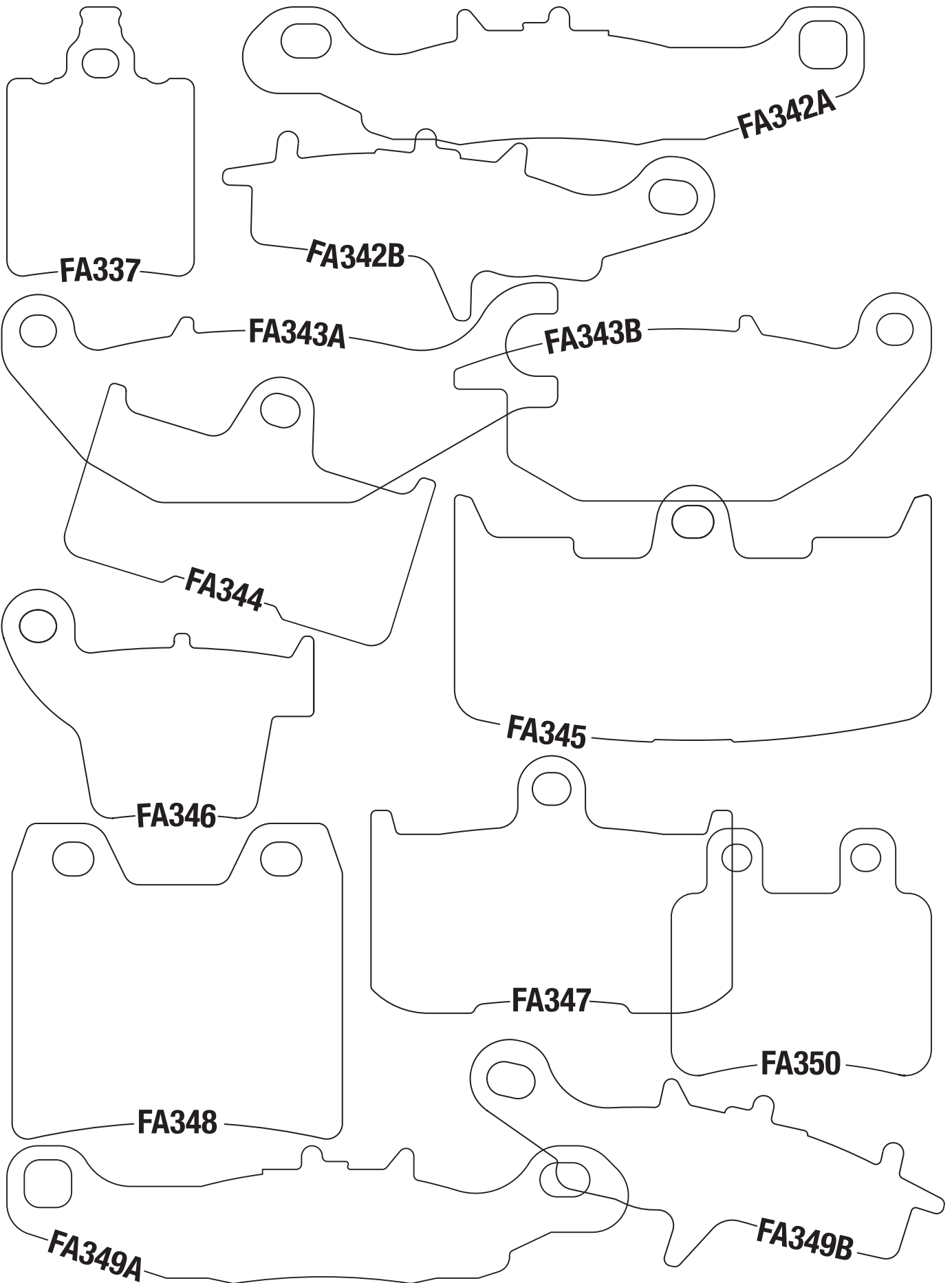

Part numbers, prefixes, suffixes, photos and illustrations shown in this catalog are trademarks and/or copyrights of EBC Brakes or the trademark owner A C Freeman Investments Ltd and use without express written permission of the owners is punishable by law.

EBC FULL SIZE BRAKE PAD ILLUSTRATION – FA351-FA367

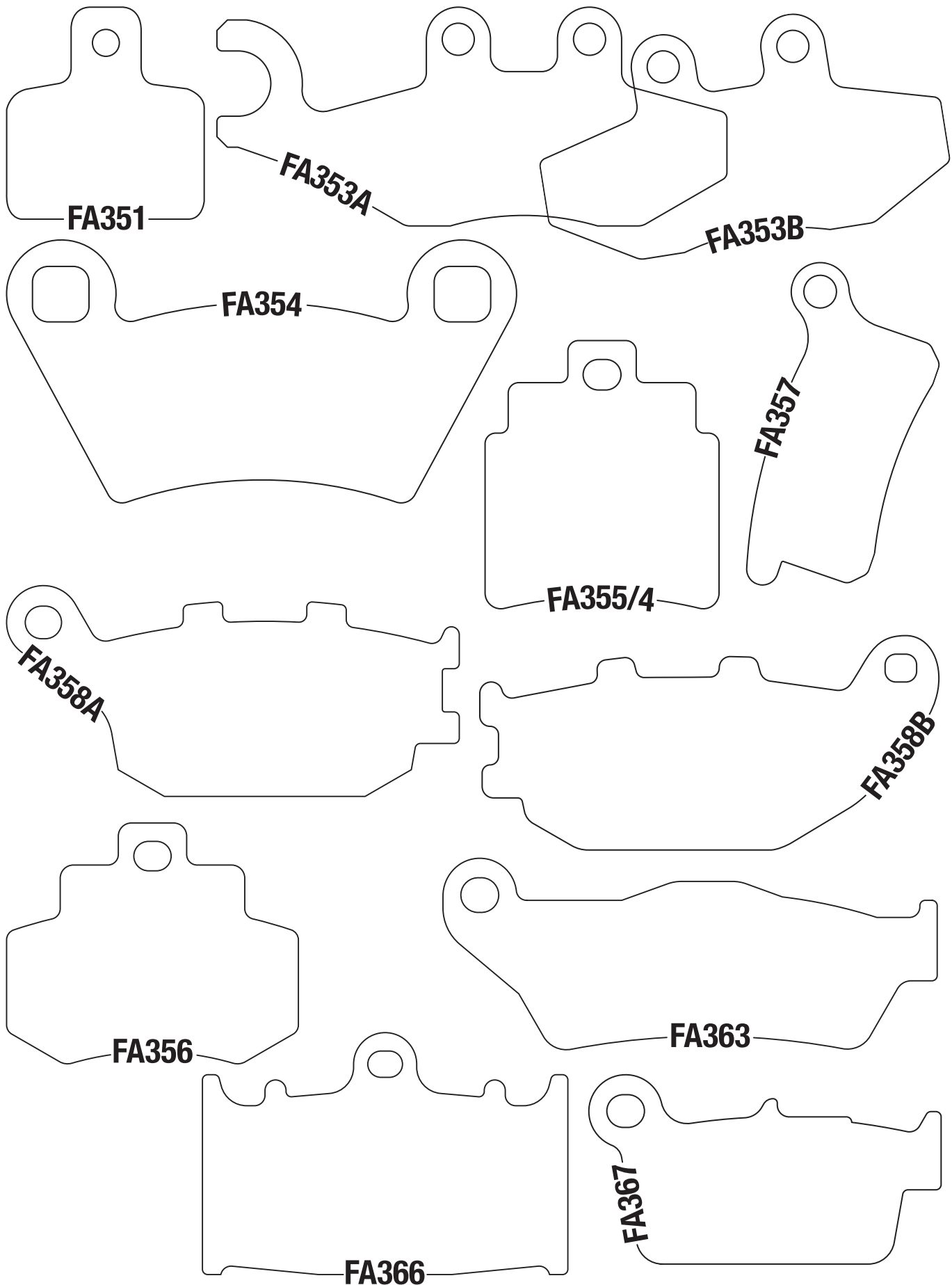

EBC FULL SIZE BRAKE PAD ILLUSTRATION – FA368-FA384

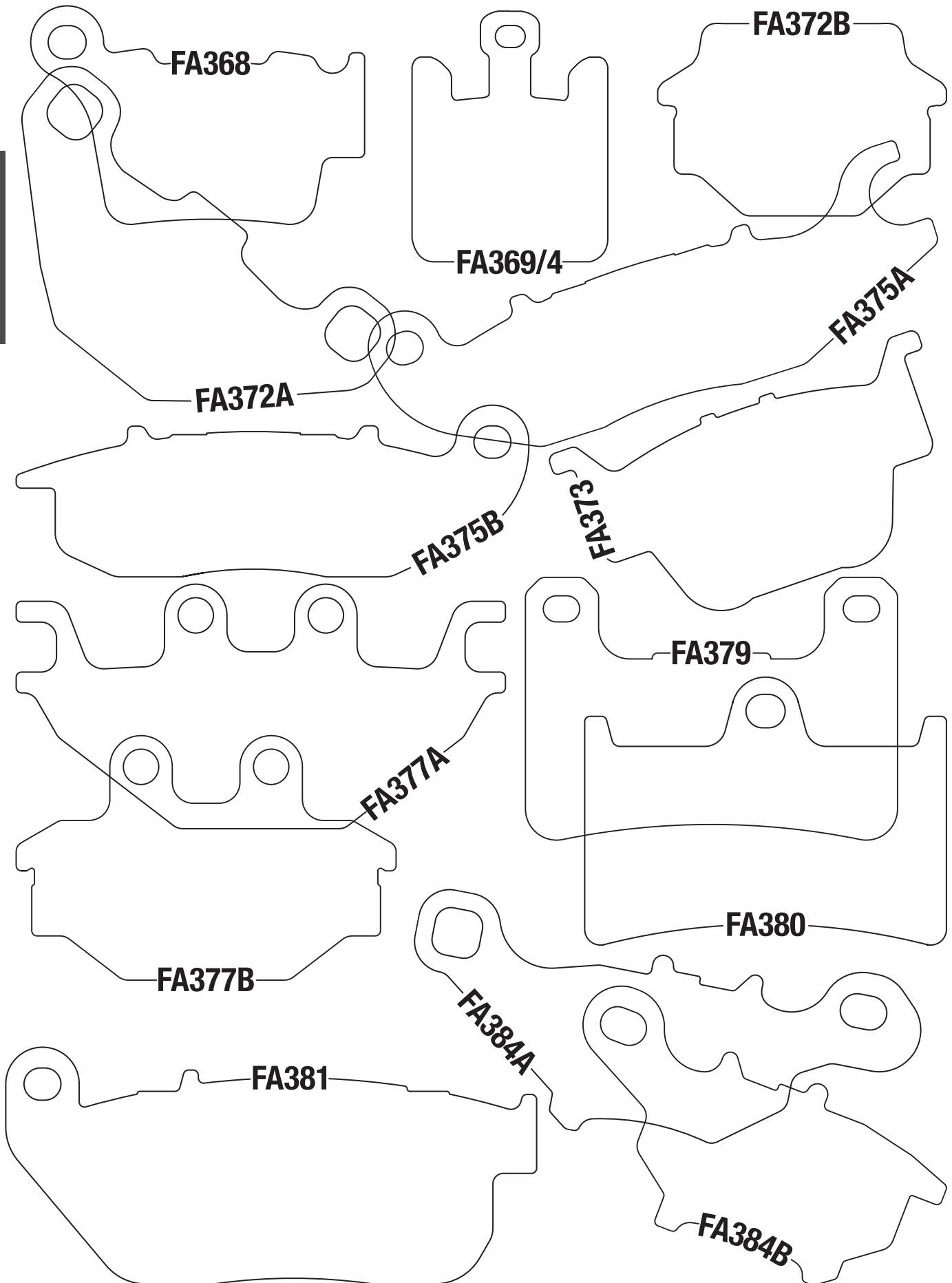

EBC FULL SIZE BRAKE PAD ILLUSTRATION – FA387-FA405

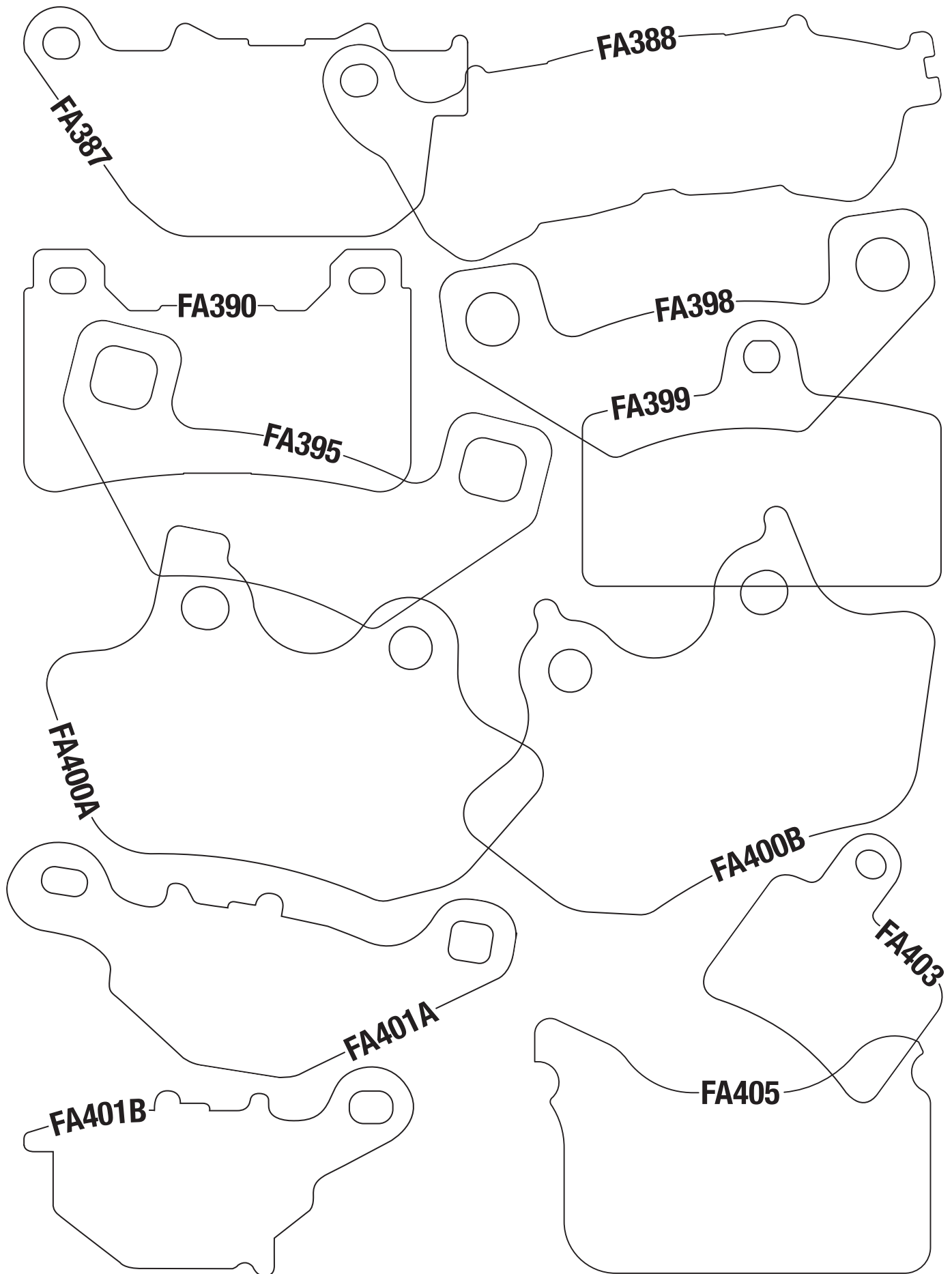

BUYERS GUIDE
BRAKE PADS

EBC FULL SIZE BRAKE PAD ILLUSTRATION – FA406-FA415

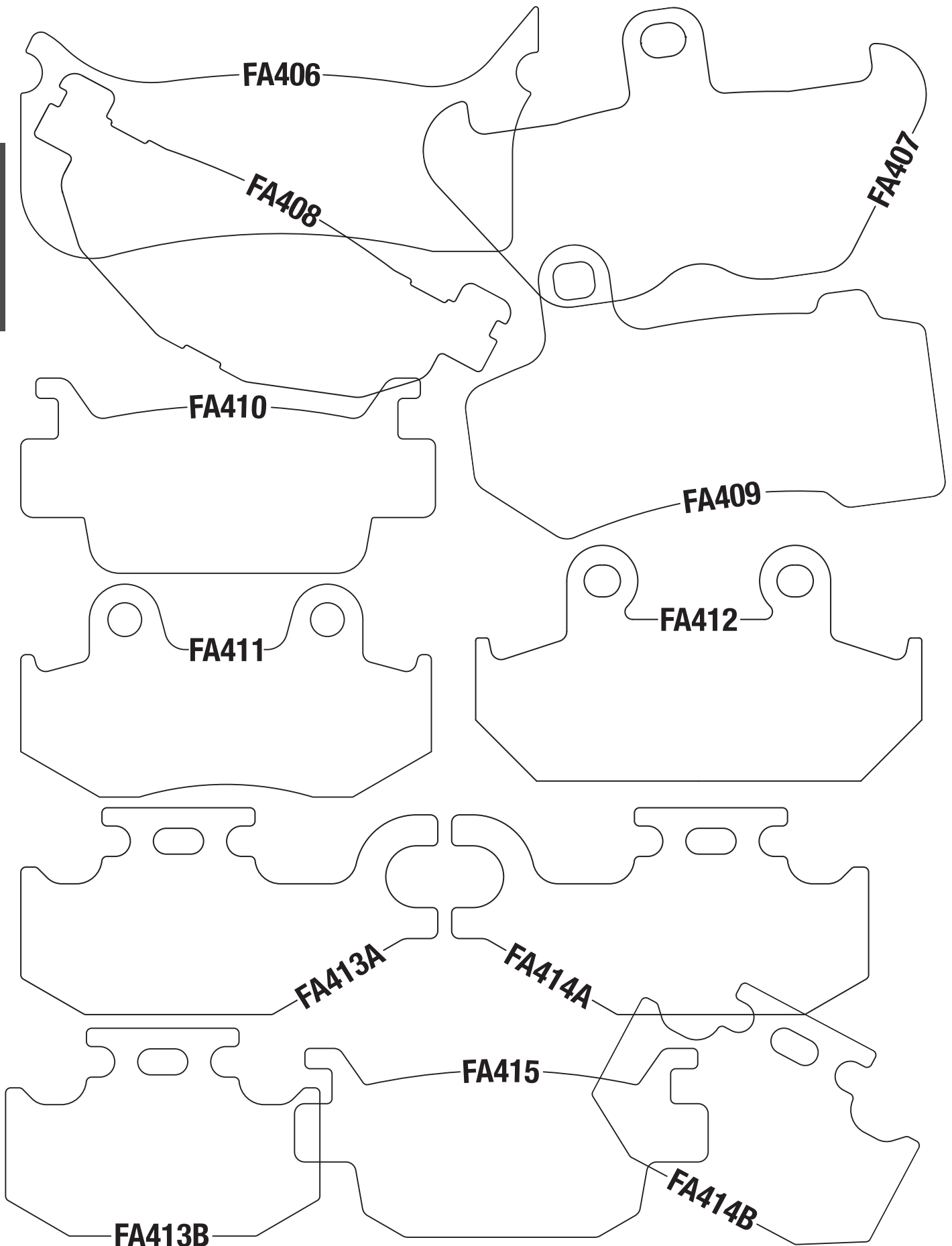

EBC FULL SIZE BRAKE PAD ILLUSTRATION – FA417-FA432

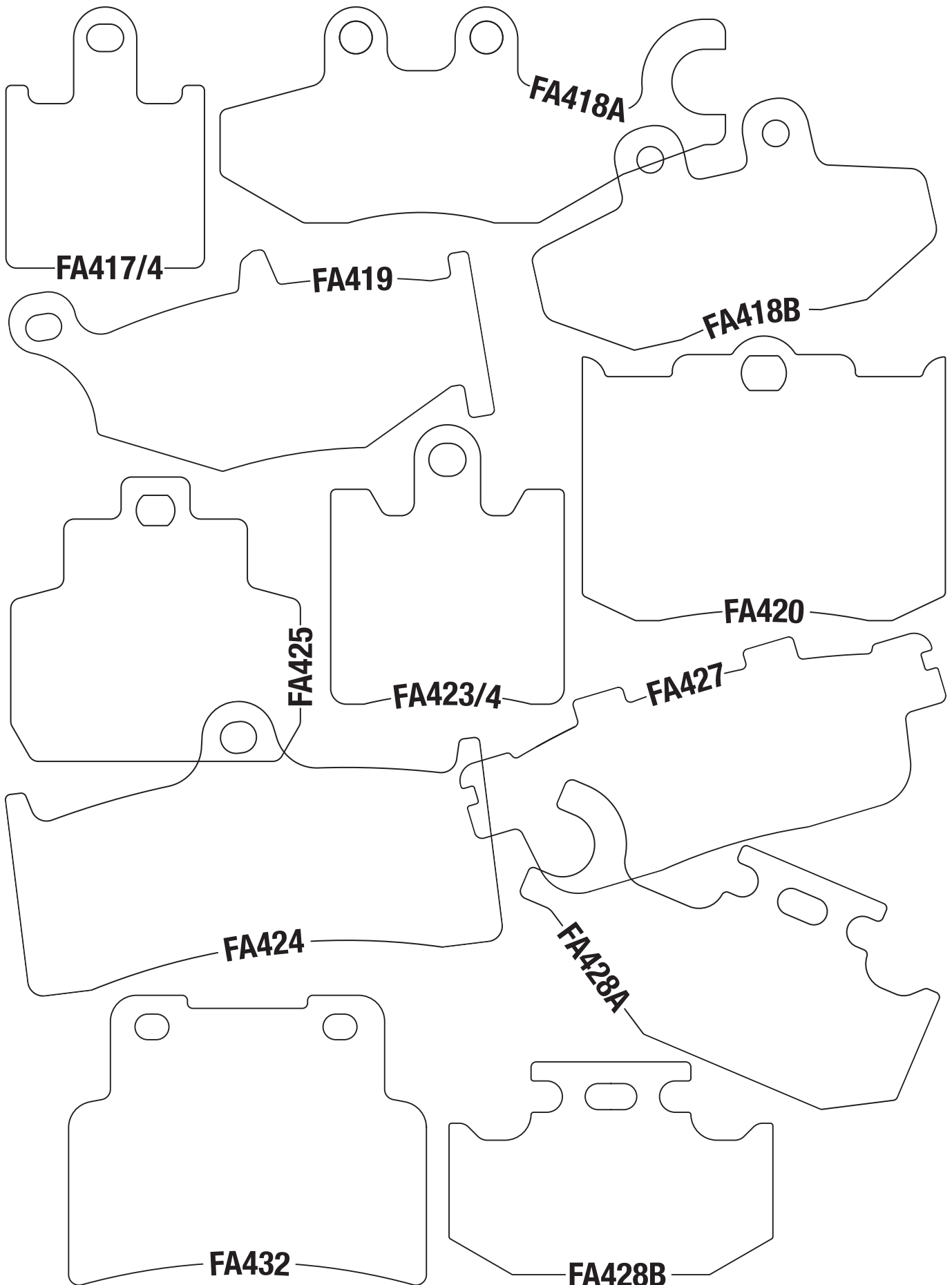

BUYERS GUIDE
BRAKE PADS

EBC FULL SIZE BRAKE PAD ILLUSTRATION – FA433-FA445

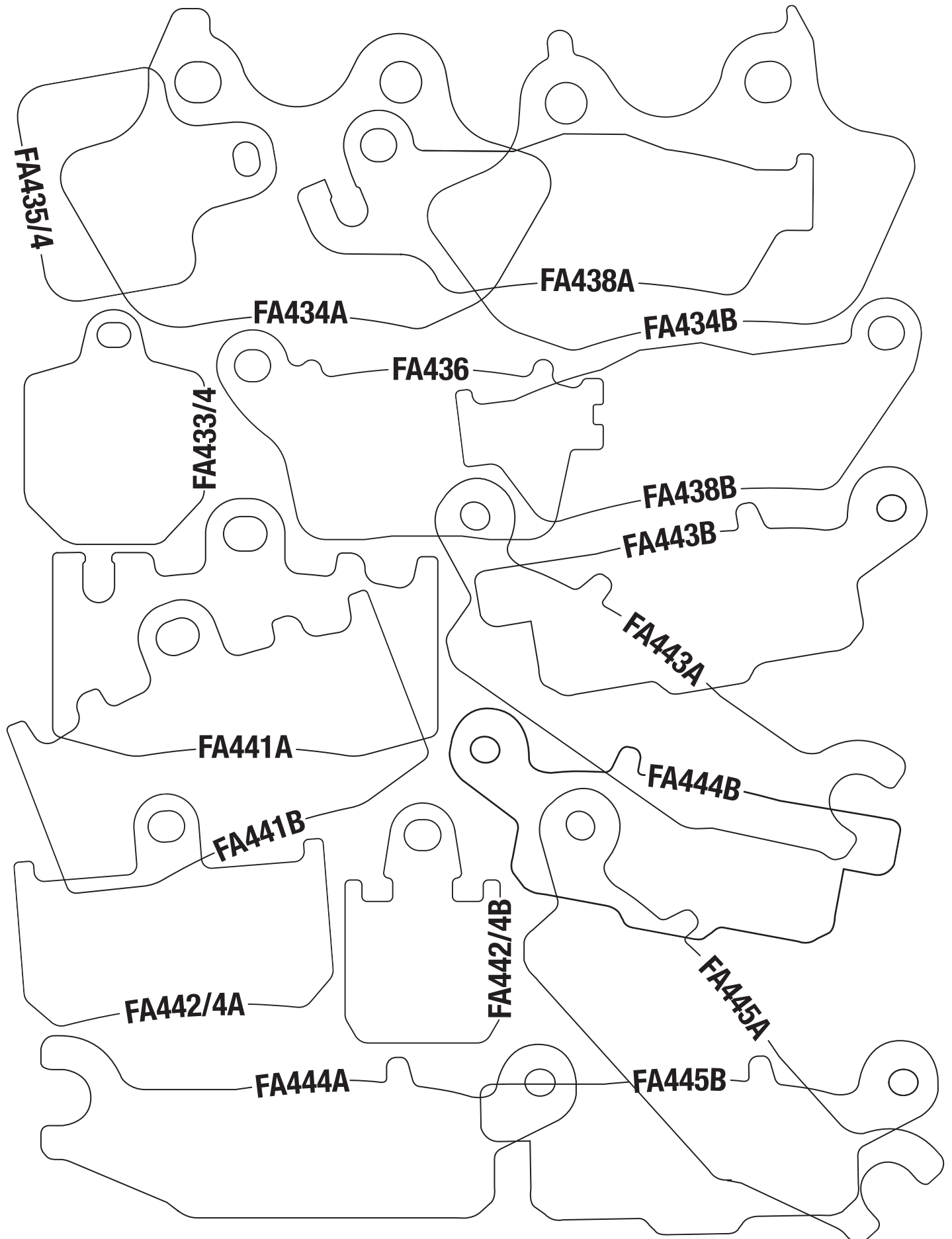

EBC FULL SIZE BRAKE PAD ILLUSTRATION – FA446-FA458

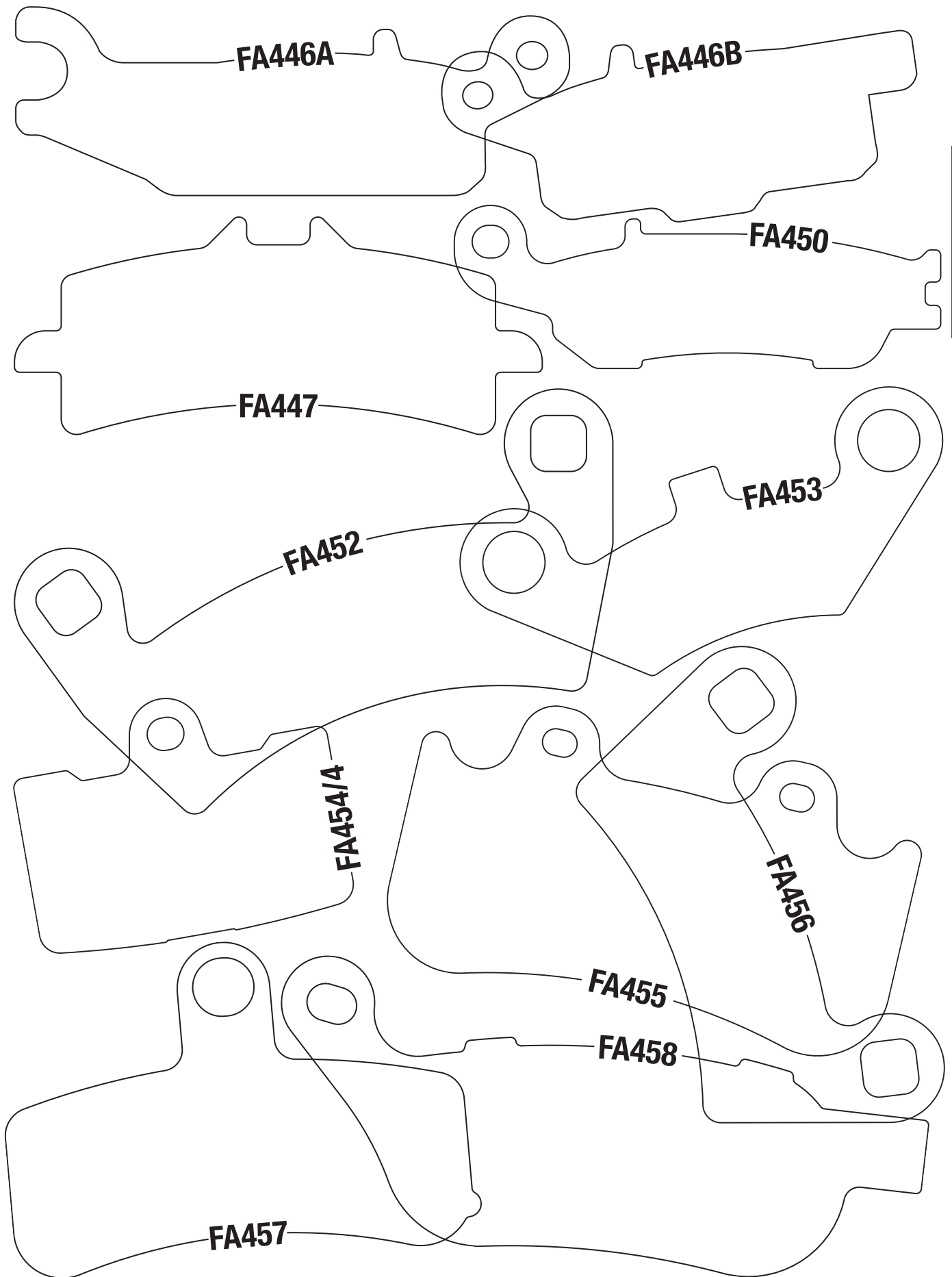

EBC FULL SIZE BRAKE PAD ILLUSTRATION – FA460-FA476

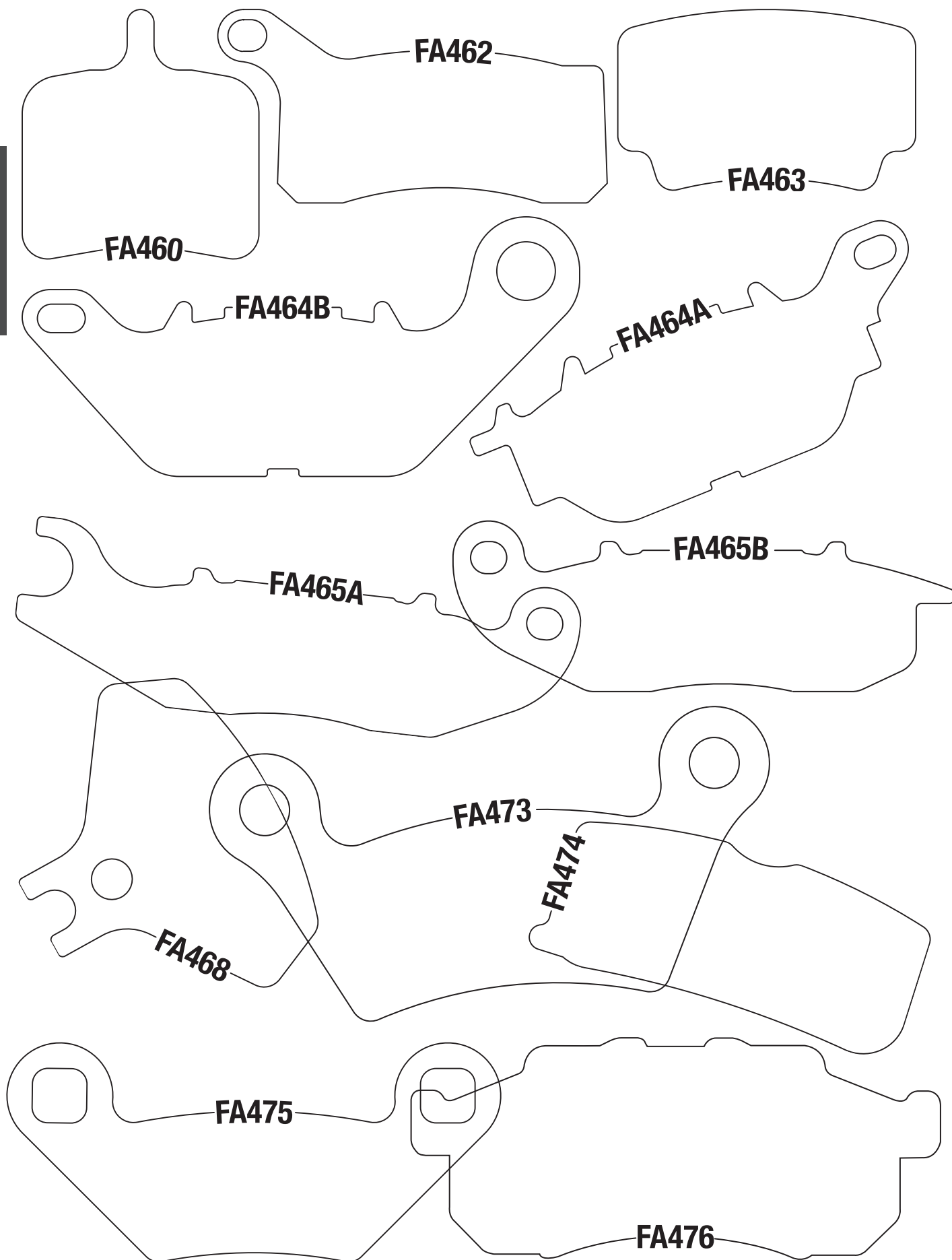

EBC FULL SIZE BRAKE PAD ILLUSTRATION – FA477-FA495

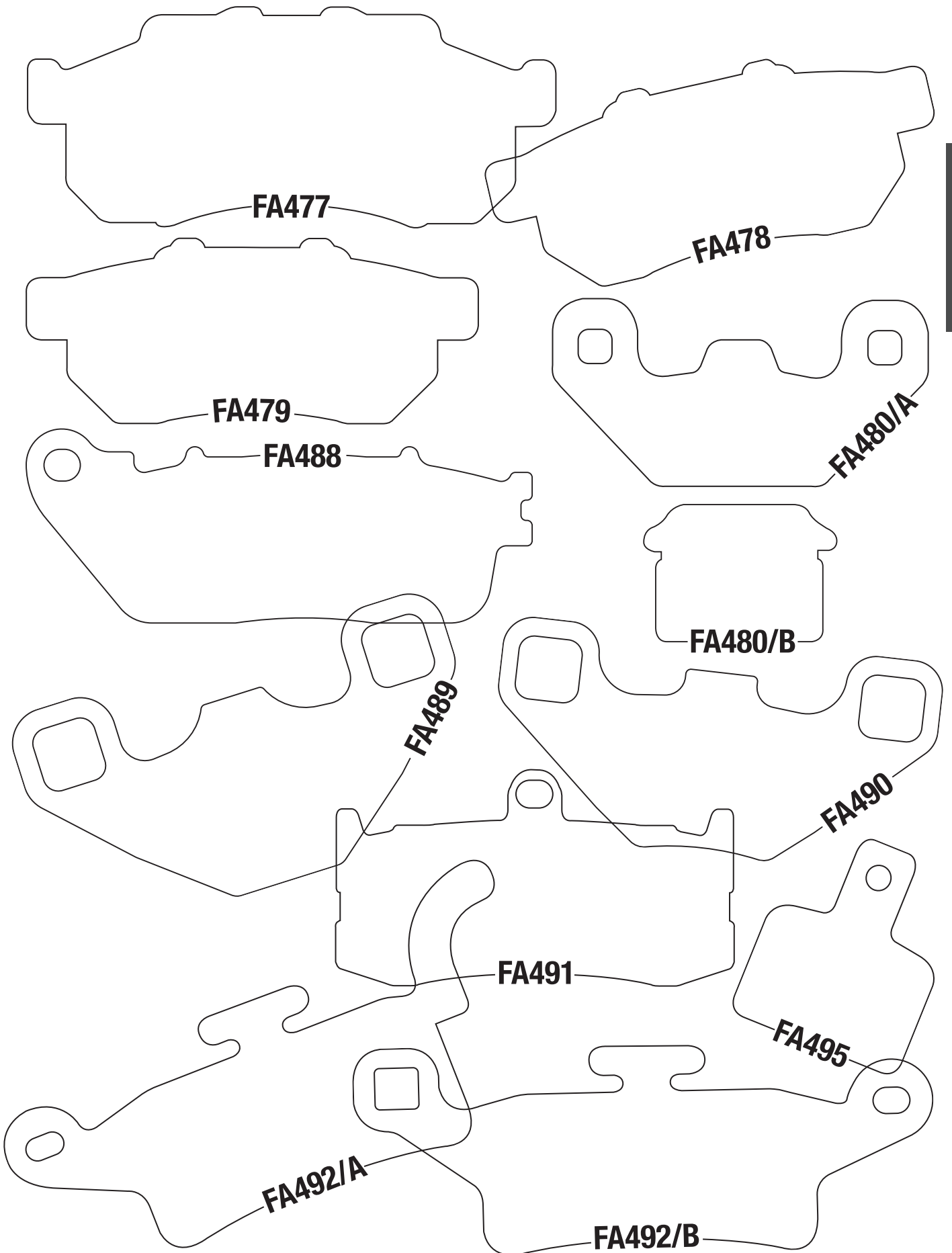

EBC FULL SIZE BRAKE PAD ILLUSTRATION – FA496-FA605/4

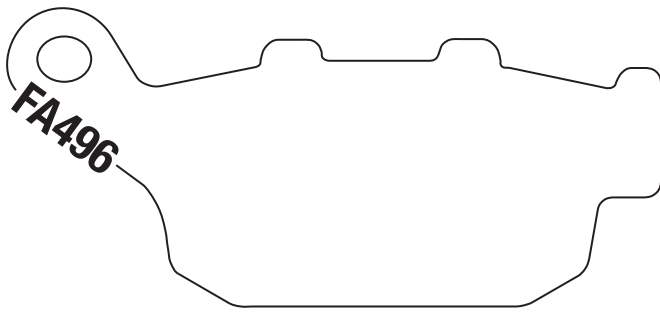

FA496



FA497



FA498

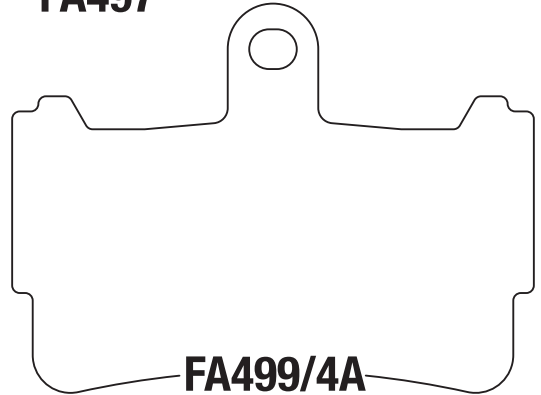

FA499/4A



FA600



FA600/2

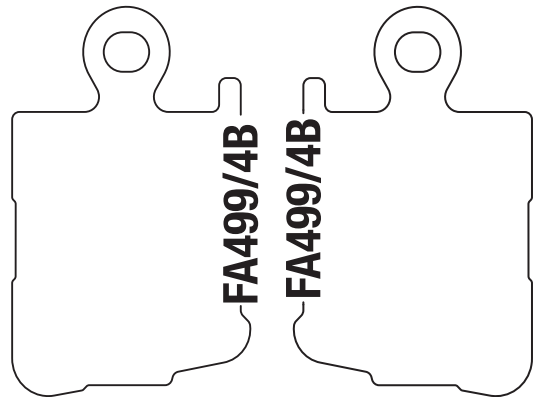

FA499/4B

FA499/4B



FA603/A

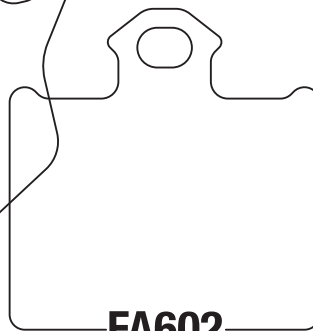

FA602

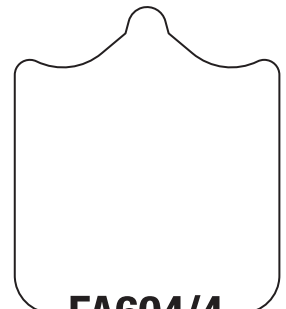

FA604/4

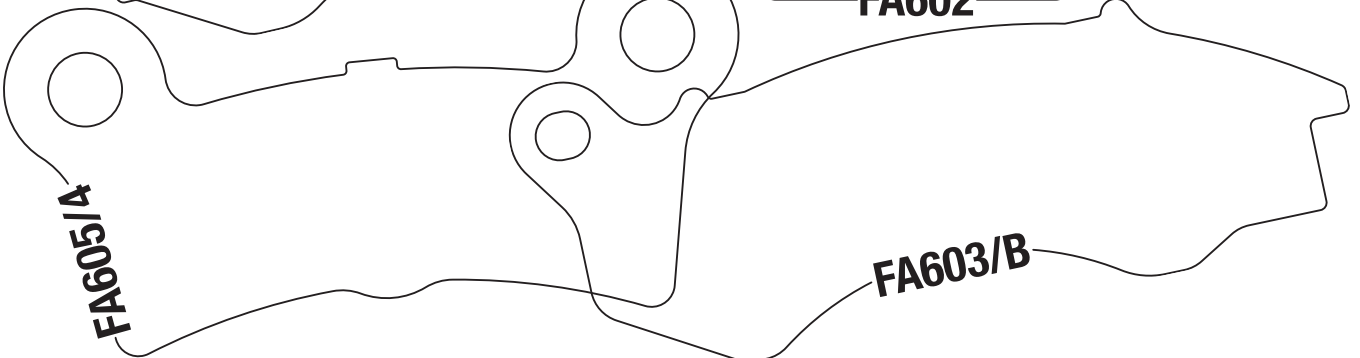

FA603/B

FA605/4

EBC FULL SIZE BRAKE PAD ILLUSTRATION – FA606-FA618

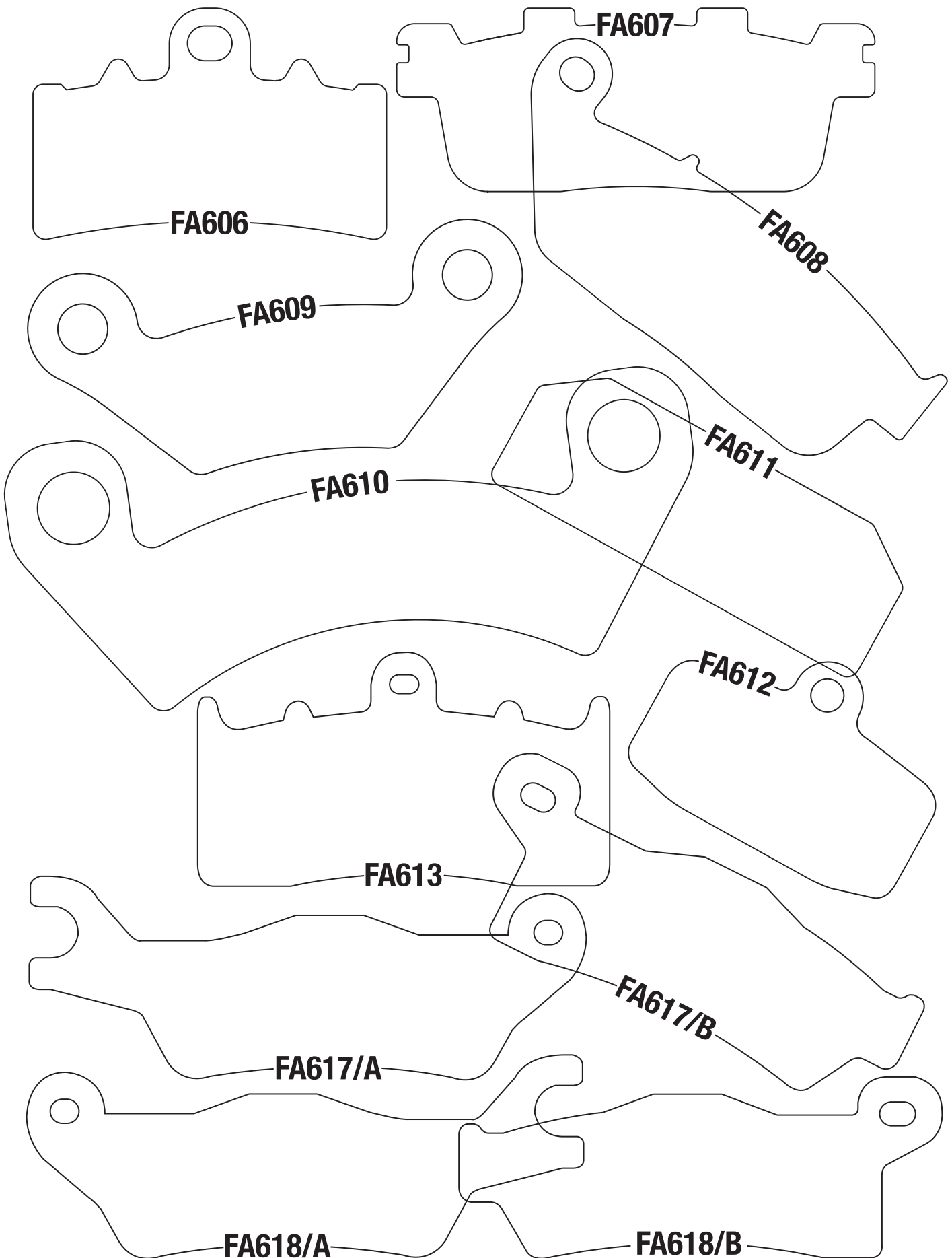

EBC FULL SIZE BRAKE PAD ILLUSTRATION – FA619-FA638

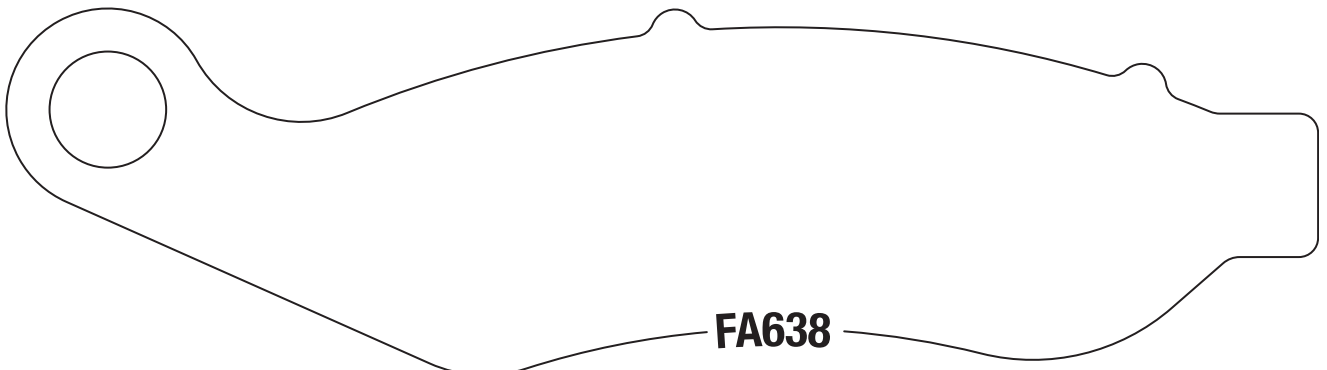
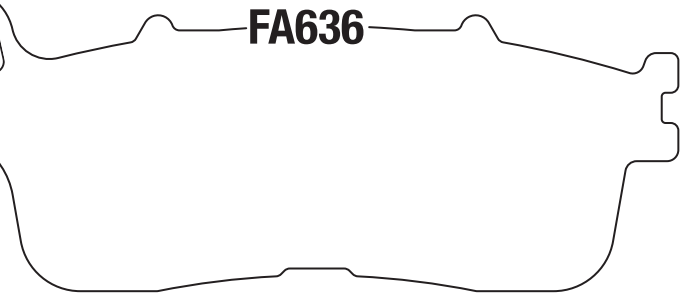
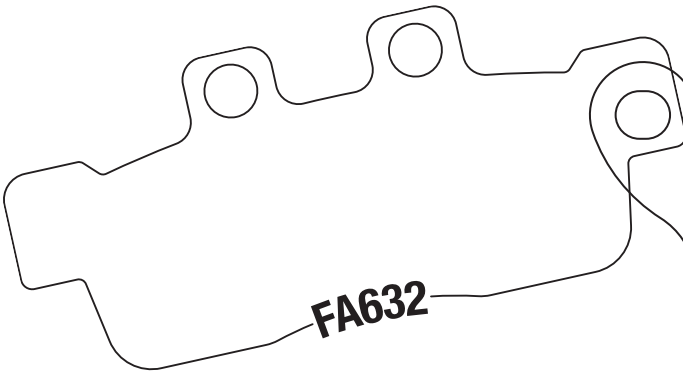
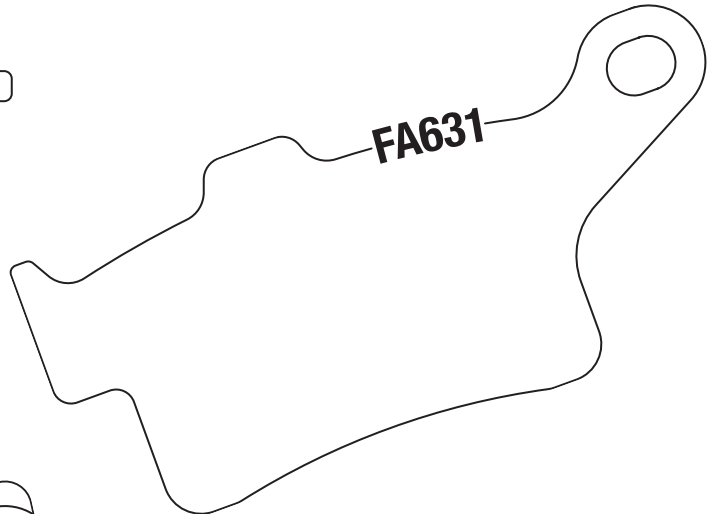
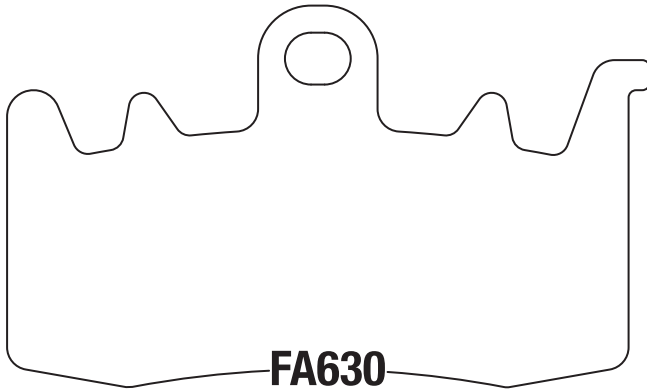
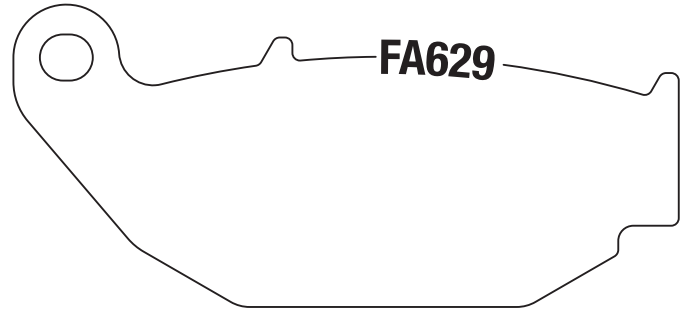
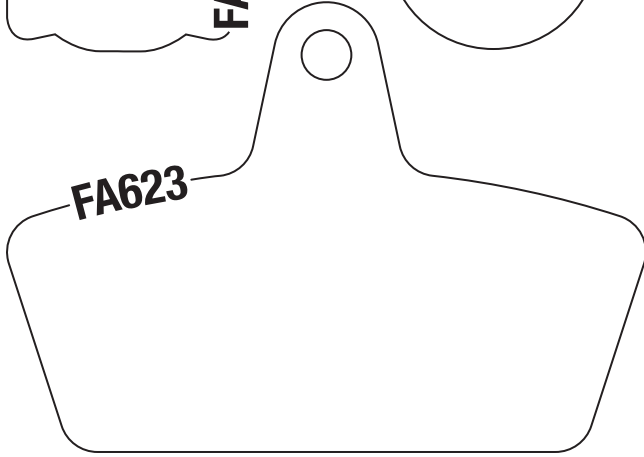
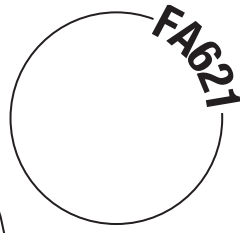

EBC FULL SIZE BRAKE PAD ILLUSTRATION – FA640-FA656

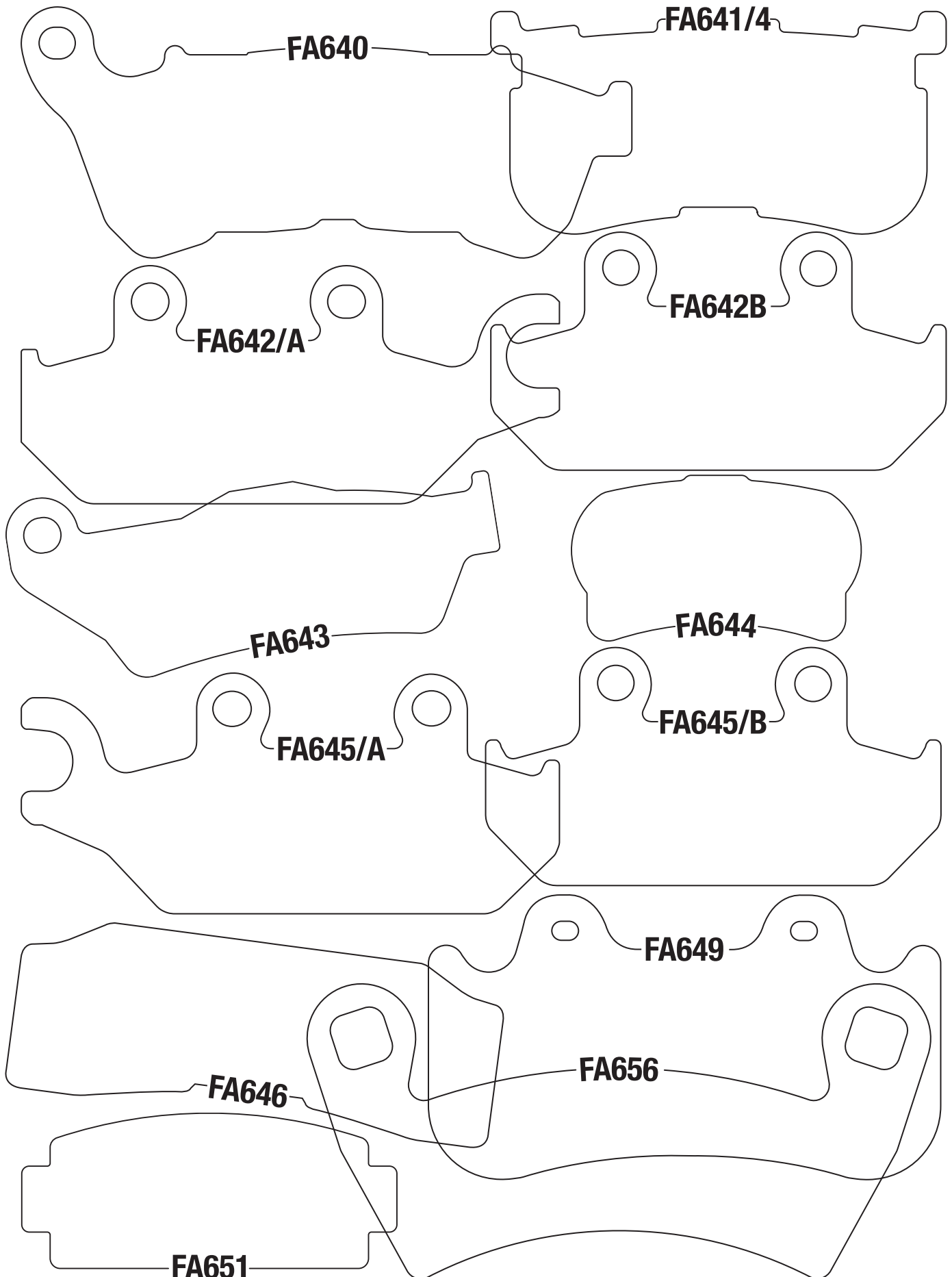

EBC FULL SIZE BRAKE PAD ILLUSTRATION – FA657-FA671

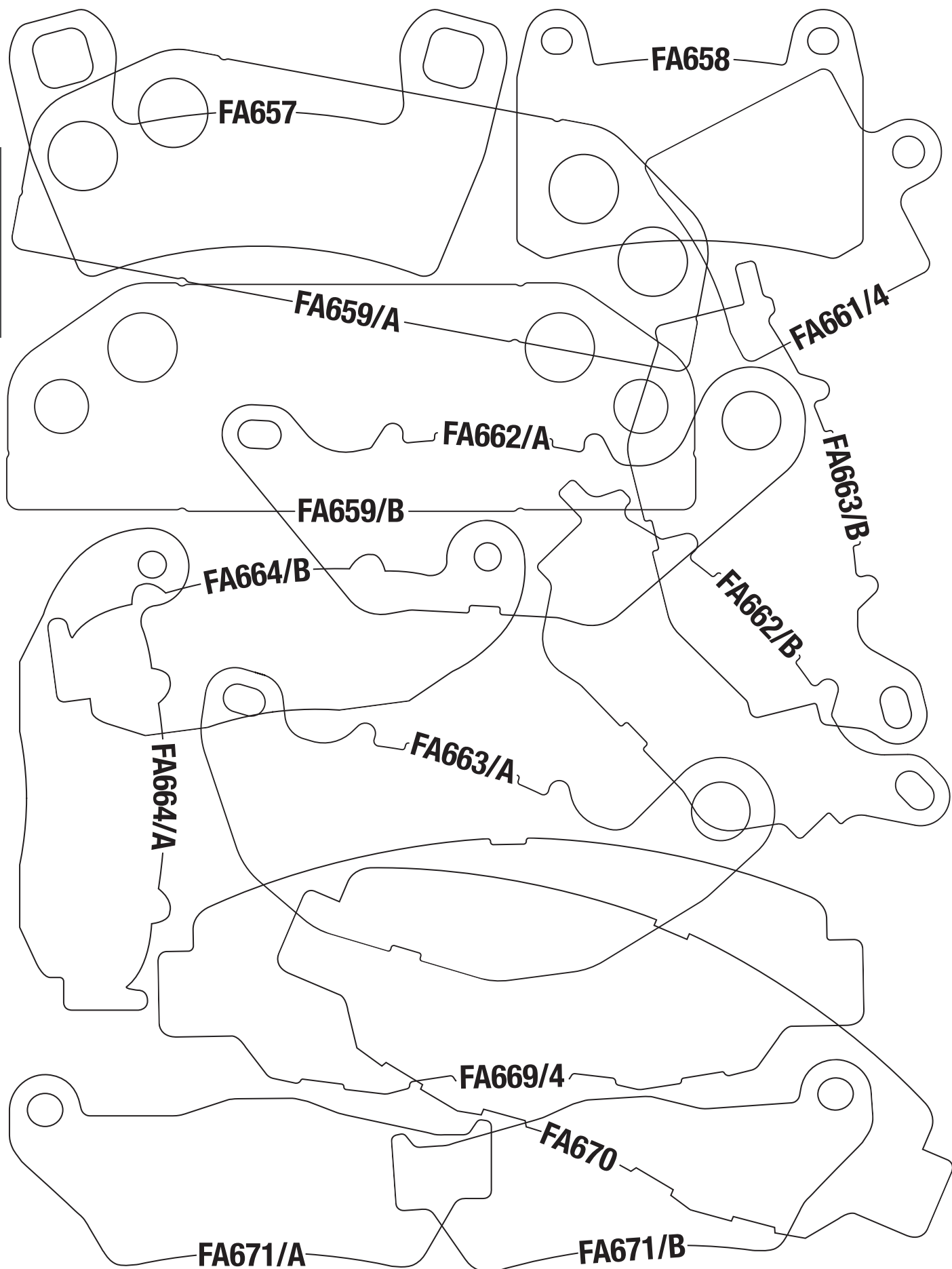

EBC FULL SIZE BRAKE PAD ILLUSTRATION – FA672-FA682

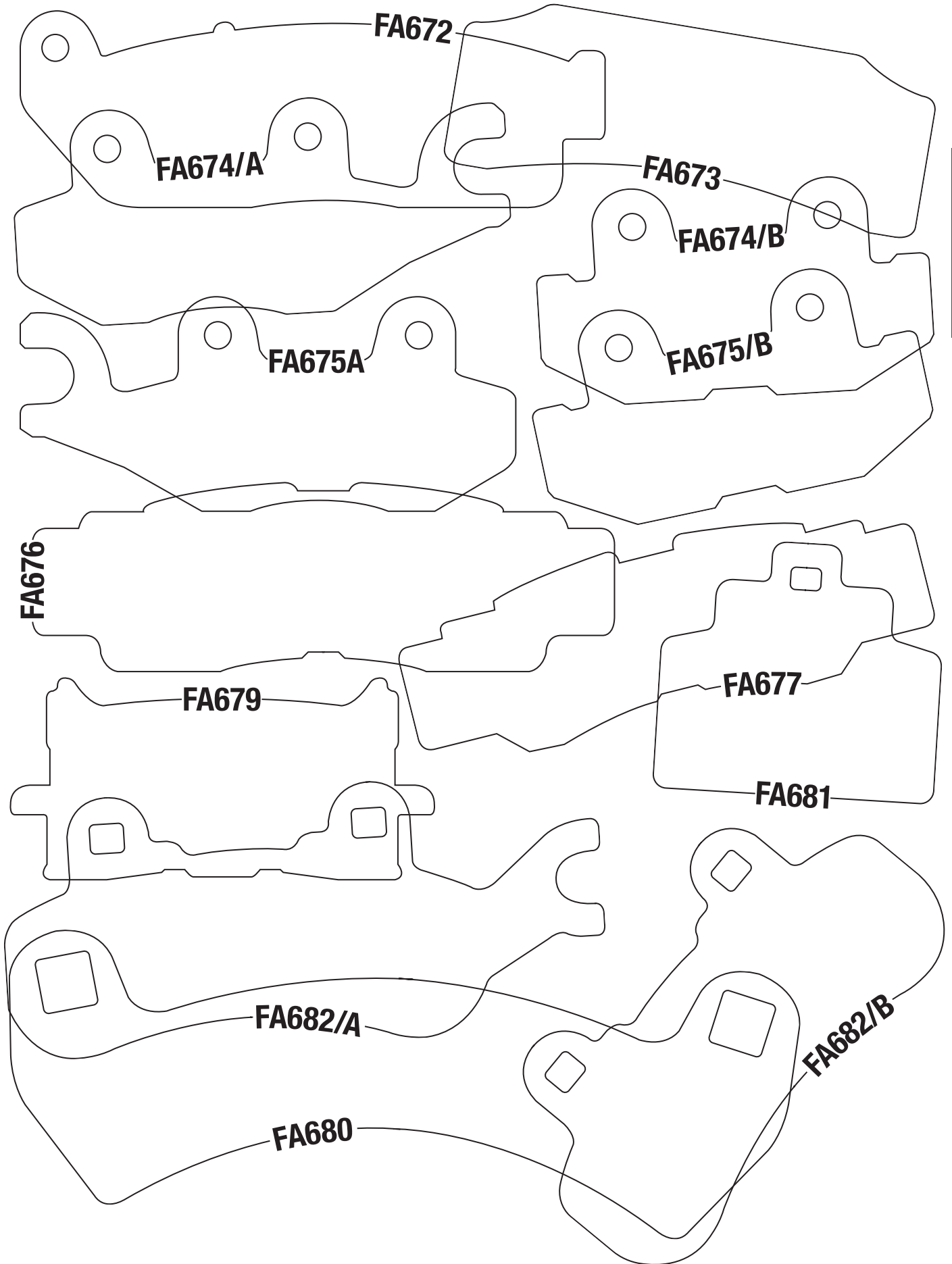

EBC FULL SIZE BRAKE PAD ILLUSTRATION – FA683-FA698

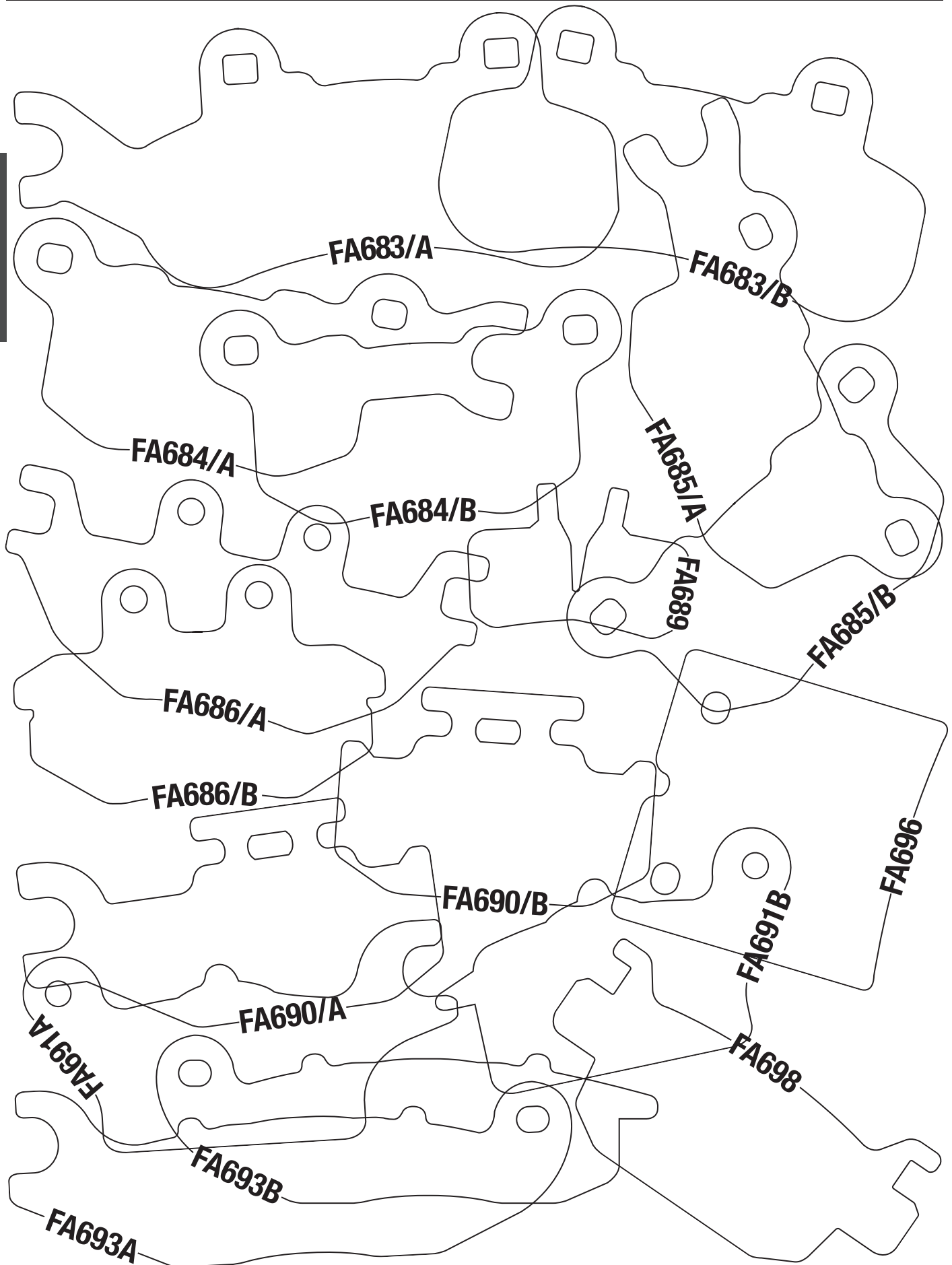

Part numbers, prefixes, suffixes, photos and illustrations shown in this catalog are trademarks and/or copyrights of EBC Brakes or the trademark owner A C Freeman Investments Ltd and use without express written permission of the owners is punishable by law.

EBC FULL SIZE BRAKE PAD ILLUSTRATION – FA700-FA712

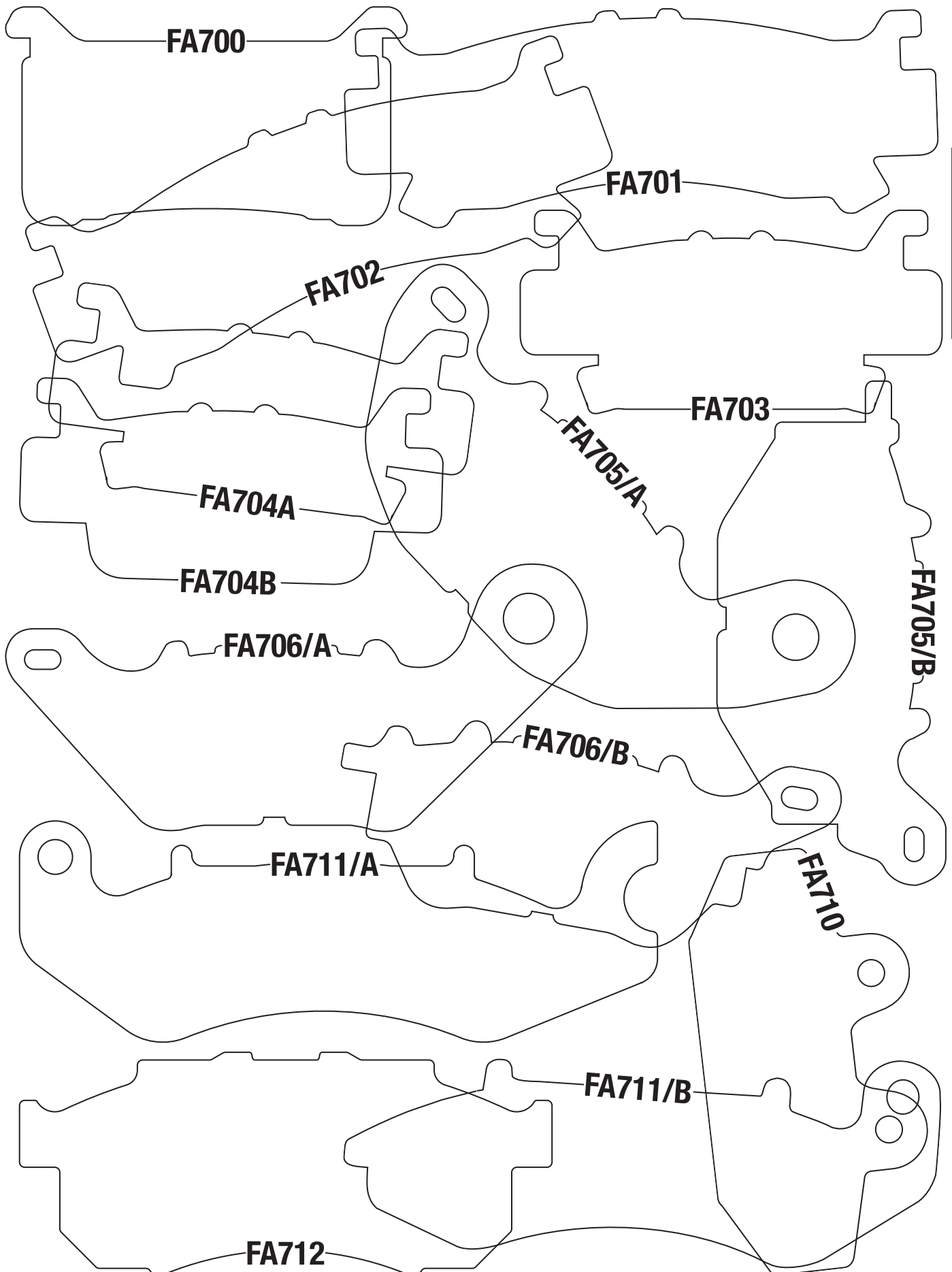

BUYERS GUIDE
BRAKE PADS

EBC FULL SIZE BRAKE PAD ILLUSTRATION – FA714-FA737

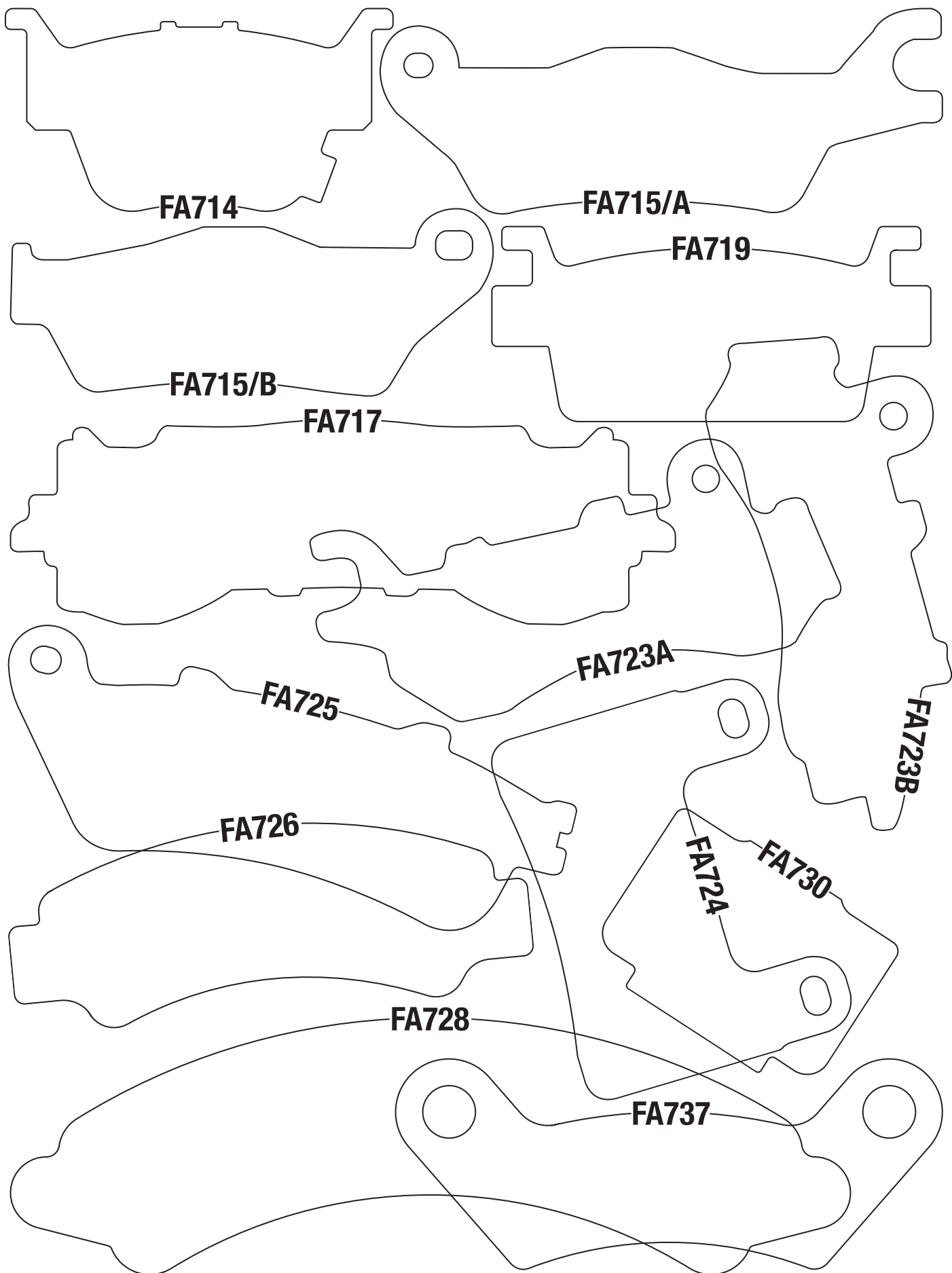

EBC FULL SIZE BRAKE PAD ILLUSTRATION – FA738-FA752

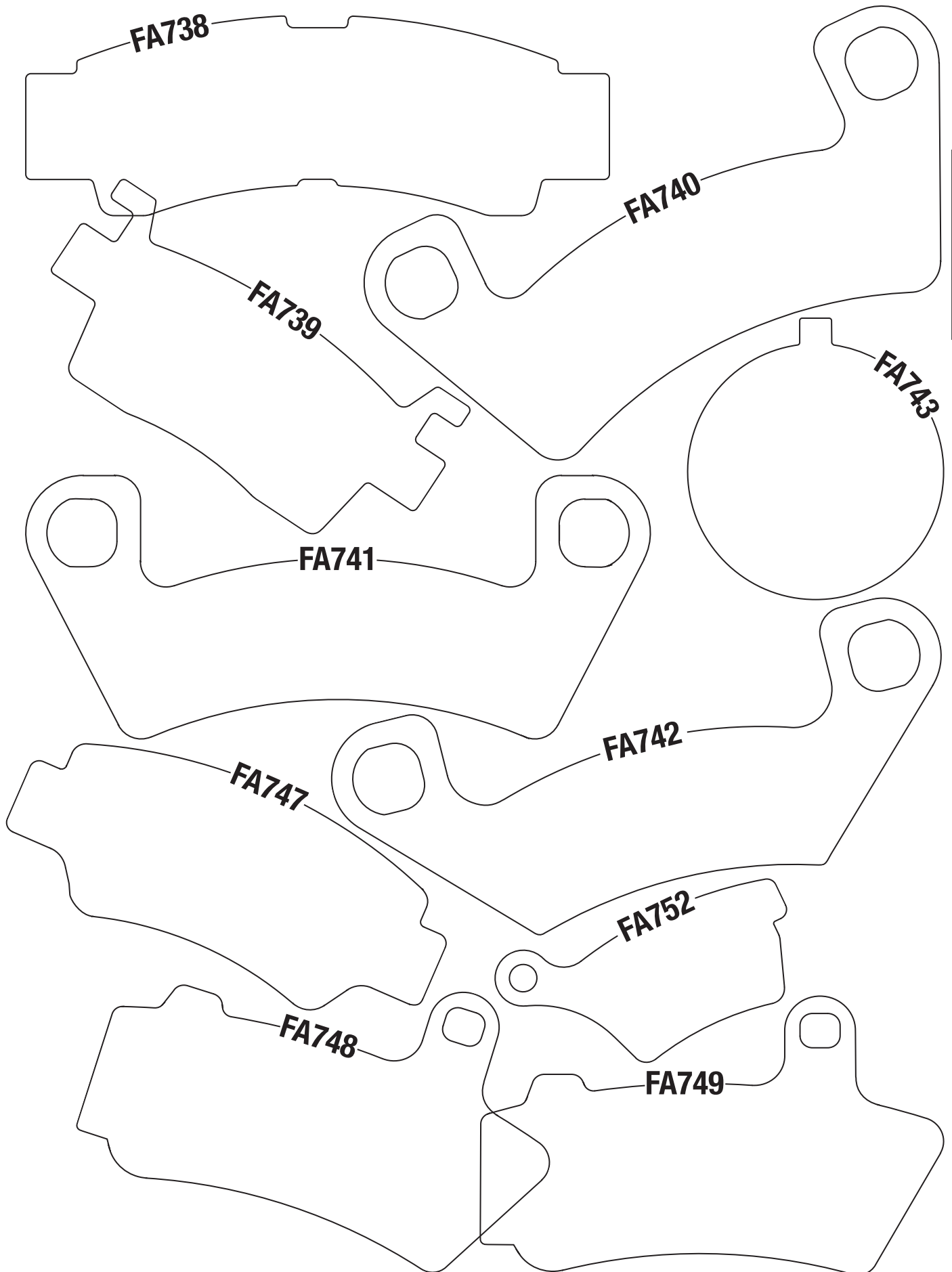

BUYERS GUIDE
BRAKE PADS

EBC FULL SIZE BRAKE PAD ILLUSTRATION – FA755-FA778

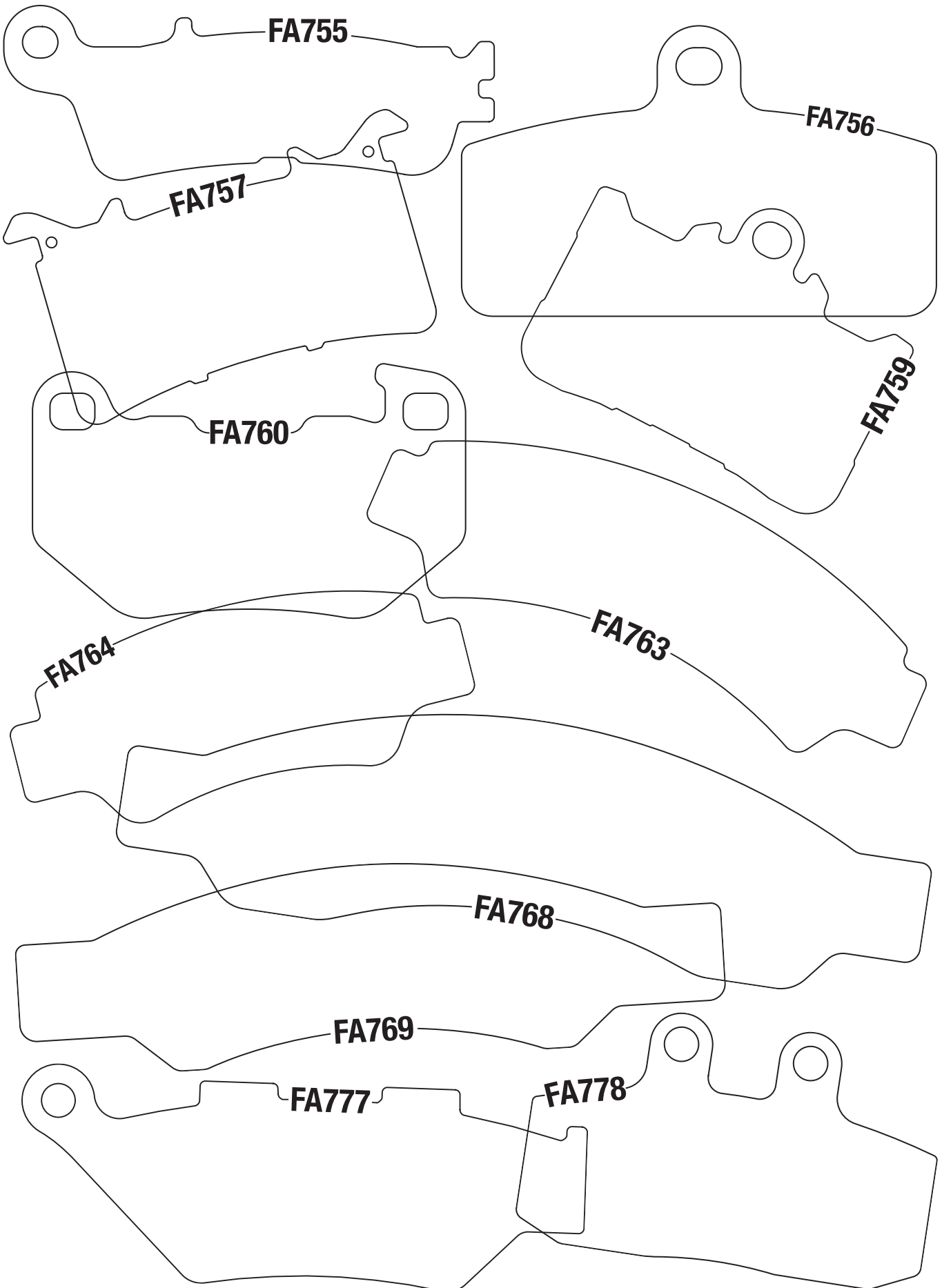

BRAKE SHOE BUYERS GUIDE

Part No.	Make/Model	Year	F/R	Part No.	Make/Model	Year	F/R
301	HONDA		F & R	303/303G Contd.	Agility 125 (4T/12 Inch Wheels)	2019-2020	R
	CRF 50 F	2004-2024	F & R		Yup 50	2002-2006	R
	MR 50 K0/K1 Elsinore	1974-1975	F		ZX 50	2002-2005	R
	NA 50 Express II	1979-1981	F		Filly 50	2002-2005	R
	NB 50/NB M Aero	1983-1987	F & R		MXer 150	2003-2005	F
	NC 50 Express	1977-1983	F & R		MXU 150	2005-2011	F
	NN 50 MD Gyro	1984	F & R		MXU 150 X	2020	F
	NQ 50 Spree/Spree Special	1984-1987	F		PEUGEOT		
	NX 50 M Express SR	1981-1982	F		Speedfight 2 X/Team A/C	2002-2005	R
	PA 50	1978-1983	F & R		Vivacity X-Race 50/Pulsa 50	2002-2005	R
	SA 50 Elite LX/SR	1988-1993	F & R		Metal-X	2002-2005	R
	SB 50/SB P Elite/Elite ES	1988-1990	F		Trekker 50	2002-2005	R
	SE 50/SE P Elite/Elite 50 S	1987-1988	F & R		Looxor 50	2002-2005	R
	TG 50/TG M Gyro S	1985-1986	F & R		Elyseo 50	2002-2005	R
	XR 50 R	2000-2003	F & R		Scoot Elec	2004-2005	F & R
	Z 50	1980-1999	F & R		Ludix 50 Trend/One/Snake/Bullet	2004-2005	R
	SUZUKI				Ludix 50 Elegance/Ambition	2004-2005	R
	DR-Z 50	2018-2024	F & R		Ludix 125	2004-2005	R
	DR-Z 70	2008-2018	F & R		SYM		
	YAMAHA				Fiddle 50	1999-2012	F
	TT-R 50 E	2006-2024	F & R		Jet 50 Evo	2014	R
302/302G	HONDA			Fiddle 50 Front drum model	2009-2012	F	
	NA 50 Express II	1979-1981	R	Fiddle 50 Front disc model	2008-2011	R	
	NB 50 M Aero	1983-1987	R	MiO 50	2005-2012	R	
	NC 50 Express	1981-1983	R	Simply 50	2007-2012	R	
	NH 80 MD Aero	1983-1984	R	Symba 110	2009-2012	R	
	NU 50 M Urban Express	1982-1983	R				
	NX 50 M Express SR	1981-1982	R	304/304G			
	SA 50 Elite	1988-1993	R	HONDA			
	SE 50 Elite	1987-1988	R	CB 125 S	1979-1982	F & R	
	KYMGCO STREET			CL 125 S1	1967-1974	F & R	
	Campagno 110i	2013-2015	R	CR 125 M/M1 Elsinore	1973-1978	F	
Campagno 50i	2014	R	CR 80 R	1980-1982	F & R		
SYM			CRF 150 F	2003-2020	R		
Fiddle 50	1999-2012	R	CRF 230 F AC	2003-2020	R		
Mio 50	2005-2014	R	CT 125	1977	F & R		
303/303G	ARCTIC CAT ATV			MB5	1982	R	
	150 2 x 4 Utility	2009-2018	F	MR 175 Elsinore	1975-1977	F & R	
	E-TON			MT 125 K1 Elsinore	1974-1977	F & R	
	CXL 150 Yukon II/Challenger	2002-2009	F	NCH 50 Metropolitan	2013-2024	R	
	RXL 150 Viper	2005-2006	F	NS 50 F	1990	R	
	RXL 150 Viper R	2005-2009	F	NX 125	1988-1990	R	
	YXL 150 Yukon	2000-2002	F	NXR 125	2003-2008	R	
	HONDA			NXR 150	2003-2008	R	
	*ATC 125 M	1984-1987	F	SL 125	1971-1973	R	
	*ATC 185 S	1980-1983	F	TL 125	1971-1975	F & R	
	*ATC 200	1981-1983	F	TL 125 S	1976	F & R	
	*ATC 200 E Big Red	1982-1984	F	TL 250	1975-1976	F & R	
	*ATC 200 M	1984-1985	F	TLR 200 Reflex	1986-1987	F	
	*ATC 200 S	1984-1986	F	TR 200 Fatcat	1986-1987	F & R	
	* - ATC is a Registered Trademark of Honda Motor Corporation			XL 100 All Models	1974-1985	F & R	
	CL 125 S	1967-1974	F & R	XL 125	1974-1976	F & R	
	CL 125 S1	1967-1974	F & R	XL 125 S	1979-1985	F & R	
	CT 110 Trail	1980-1986	F & R	XL 185 S	1979-1983	F & R	
	CT 70 Trail	1977-1994	F & R	XL 200 R	1983-1984	F & R	
	EZ 90 Cub	1991-1996	F & R	XL 75	1977-1979	F & R	
	SL 100 K	1970-1974	F & R	XL 80 S	1980-1985	F & R	
	SL 125	1971-1973	F	XR 80	1979-1984	F & R	
	SL 70 K1	1970-1973	F & R	XR 100	1981-1984	F & R	
	TRX 125 Fourtrax	1985-1988	F	XR 150 3 LA	2016-2023	R	
	TRX 90 Fourtrax/Sportrax	1993-2022	F	XR 185	1979	F & R	
	XL 100	1974-1978	F & R	XR 200 R	1980-1984	F & R	
	XL 125	1977-1978	F & R	XR 200 R	1984-2002	F & R	
	XL 75	1978	F & R	XR 200 R Pro Link	1981-1983	F & R	
	ZB 50	1988	F & R	XR 250 R Pro Link	1984-1989	R	
	KYMGCO ATV			XR 350 R	1983-1985	R	
	Agility 50 (4T)	2005-2012	R	XR 500 R Pro Link	1983-1984	R	
	Agility 50 (4T)	2020	R	XR 600 R	1985-1990	R	
	Cobra Racer 50 (SF 10 AG)	2000-2004	R	306/306G			
	Cobra Cross/Racer 50 (SF 10 AF)	2005-2006	R	HONDA			
	Like 50 (2T)	2009-2012	R	ATC* 125 M	1984-1987	R	
	Like 50 LX (2T)	2012-2014	R	ATC* 185 S	1980-1983	R	
	Like 50 i (4T)	2020	R	ATC* 200	1981-1983	R	
	Like M 50 (4T)	2020	R	ATC* 200 E Big Red	1982-1984	R	
	Sento 50cc (4T)	2009-2012	R	ATC* 200 M	1984-1985	R	
	Sting 50 (2T)	2005-2011	R	ATC* 200 S	1984-1986	R	
	Vitality 50 (4T)	2005-2008	R	ATC* 250 ES Big Red	1985-1987	F	
	Agility 125	2006-2011	R	ATC* 250 R	1981	R	
				ATC* 250 SX	1985-1987	F	
				CL 125 A	1965	F	
				TRX 125 Fourtrax	1985-1988	R	
				TRX 200 D Type II Fourtrax	1991-1997	R	

BRAKE SHOE BUYERS GUIDE

Part No.	Make/Model	Year	F/R	Part No.	Make/Model	Year	F/R
306/306G Contd.	TRX 200 Fourtrax	1984-1991	R	313 Contd.	CB 450 T Hawk	1982	R
	TRX 90 EX	2007-2008	R		CB 550 SC Nighthawk	1983	R
	TRX 90 Fourtrax/Sportrax	1993-2006	R		CM 400 A/T	1979-1981	R
	TRX 90 X	2009-2022	R		CM 400 C Custom	1981	R
	POLARIS				CM 400 E	1980-1981	R
	Phoenix 200	2005	R		CM 450 A Hondamatic	1982-1983	R
	Phoenix 200	2006-2009	R		CM 450 C Custom	1982	R
Phoenix 200	2010-2014	R	CM 450 E	1982-1983	R		
Sawtooth 200	2006-2007	R	CMX 450 C Rebel	1986-1987	R		
				VT 500 C Shadow	1983-1986	R	
				VT 500 FT Ascot	1983-1984	R	
307/307G	ARCTIC CAT ATV			314	HONDA		
	90 2 x 4 Youth	2002-2004	R		CB 400 T MKI Hawk	1978-1979	F
	90 2 x 4 Youth	2004-2005	R		CJ 360	1976-1977	F
	CAN AM			CM 400 E	1980-1983	F	
	DS 70 2 x 4 Mini	2008-2021	R	SL 350	1969-1970	F	
	DS 90 2 x 4	2006-2021	R				
	Renegade 110	2023	R	315/315G	HONDA		
	HONDA				*ATC 250 ES Big Red	1985-1987	R
	CD 175	1967-1968	R		*ATC 250 SX	1985-1987	R
	CD 175 K3	1969-1971	R		CB 360	1974-1976	R
	CL 125 A	1965	R		CB 400 F	1975-1977	R
	SS 125 A Supersport 125	1965	R		CJ 360	1976-1977	R
	KYMCO ATV				SL 350	1969-1970	R
	Mxer Mongoose 50	2004-2008	R		TRX 250 Fourtrax	1985-1987	R
	POLARIS				TRX 300 Fourtrax 2WD	1988-2000	R
	Outlaw 110	2016-2022	R		TRX 300 Fourtrax 4WD	1988-2000	R
	Outlaw 50	2008-2018	R	*ATC 250 ES Big Red	1985-1987	R	
	Outlaw 90	2007-2016	R	*ATC 250 SX	1985-1987	R	
	Predator 50	2004-2007	R	TRX 250 Fourtrax	1985-1987	R	
	Predator 90	2003-2006	R	TRX 300 Fourtrax 2WD	1988-2000	R	
Scrambler 50	2001-2003	R	TRX 300 Fourtrax 4WD	1988-2000	R		
Scrambler 90 X	2001-2003	R					
Sportsman 90	2001-2016	R	316	HONDA			
UNISON				CB 450 K3-K4	1970-1971	R	
Desert Cat 90	2004	R		CB 450 K5-K7	1972-1974	R	
YAMAHA				CB 500 T	1975-1977	R	
YFM 90 Raptor 90	2016-2017	R		CB 550 F	1975-1977	R	
YFZ 50 Y	2017-2020	R	CB 550 K1/76	1974-1978	R		
308	HONDA			318/318G	HONDA		
	CL 175/175 K3	1968-1972	F		CMX 250 C Rebel	1996-2014	R
SL 350	1969-1973	F	CMX 250 C2		1999-2000	R	
309	HONDA				CMX 250 X	2015	R
	CL 175/175 K3	1968-1972	R		NX 650 Dominator	1988-1989	R
	SL 175 K1	1972-1973	F & R		XL 250 S	1981	R
	SL 350	1969-1973	R		XL 500 R Pro Link	1982	R
VTR 250 Interceptor	1988-1990	R	XL 500 S		1979-1981	R	
310/310G	HONDA				XL 600 R	1983-1987	R
	CB 125 TT	1990	R		XL 600 V Transalp	1989-1990	R
	CB 250 Nighthawk	1991-2008	R	XR 500	1979-1980	R	
	CM 200 T Twinstar	1980-1982	R	XR 500 R Pro Link	1981-1982	R	
	CM 250 C Custom	1982-1983	R				
	CM 250 C Custom	1982-1983	R	319/319G	HONDA		
CMX 250 C/CD Rebel	1985-1987	R	CR 250 RB		1981	R	
XL 175	1973-1978	R	CR 450 R	1981	R		
311	HONDA			320	HONDA		
	MR 250 Elsinore	1976	F		CB 650	1979-1982	R
	MT 250	1974-1976	F		CB 650 C Custom	1980-1981	R
	XL 250 K	1972-1976	F		CB 650 SC Nighthawk	1982	R
312/312G	HONDA				CB 750	1970-1975	R
	CB 250 Nighthawk	1991-2008	F		CB 750 76	1970-1976	R
	CM 200 T Twinstar	1980-1982	F		CB 750 A Hondamatic	1976-1978	R
	CM 250 C Custom	1982-1983	F		CB 750 C	1982	R
	CR 250 M1/M/M76 Elsinore	1973-1976	F & R		CB 750 C Custom	1980-1982	R
	MR 250 Elsinore	1976	R		CB 750 K	1979-1982	R
	MT 250	1974-1976	R	CB 750 K7	1977-1978	R	
	XL 175	1973-1978	F	CB 750 L Limited Edition	1979	R	
	XL 250 K	1972-1976	R	CB 750 SC Nighthawk	1982-1983	R	
	XL 250 S	1978-1981	F	321	HONDA		
	XL 500 S	1979-1981	F		CB 650 SC Nighthawk	1983-1985	R
XR 250	1979-1980	F	CB 750 Nighthawk		1991-2003	R	
313	HONDA				CX 500	1978-1979	R
	CB 250 N/T	1978-1982	R		CX 500 C Custom	1979-1982	R
	CB 400 A Hondamatic	1978	R		CX 500 D Deluxe	1979-1981	R
	CB 400 T Hawk	1980-1981	R	CX 650 C Custom	1983	R	
	CB 400 T MK II Hawk	1978-1979	R	GL 500 I Silverwing Interstate	1981-1982	R	
	CB 450 SC Nighthawk	1982-1986	R	GL 500 Silverwing	1981-1982	R	

BRAKE SHOE BUYERS GUIDE

Part No.	Make/Model	Year	F/R	Part No.	Make/Model	Year	F/R
321 Contd.	GL 650 Silverwing Interstate	1983	R	331/331G Contd.	CR 250 RD	1983	R
	VF 500 C V30 Magna	1984-1985	R		CR 250 RE	1984-1985	R
	VF 700 C Magna	1984	R		CR 480 RD	1983	R
	VF 700 S Sabre	1984-1985	R		CR 500 RE	1984-1985	R
	VF 750 C V45 Magna	1982-1983	R		XR 350 R	1983	F
	VF 750 S Sabre	1982-1983	R	332/332G	HONDA		
	V LX 600 Shadow	1988-1993	R		XL 500 R Pro Link	1982	F
	VT 600 Shadow	1994-2007	R	333/333G	HONDA		
	VT 700 C Shadow	1984-1985	R		CH 80 Elite	1985-2007	R
	VT 750 C Shadow	1983	R		CHF 50/50 P/S Metropolitan	2002-2011	F & R
	KYMCO STREET				CR 60 R	1983-1984	F & R
Venox 250	2003-2008	R	CR 80 R		1982-1985	F & R	
322	HONDA				CRF 100 F	2004-2014	F & R
	PA 50	1978-1981	R		CRF 110 R	2013-2024	F & R
	KTM				CRF 125 F	2014-2024	R
	50 SX/SXR Pro Junior/Senior/Adventure	96-07	F & R		CRF 125 FB	2014-2024	R
	50 SX Mini Adventure	04-05	F & R		CRF 70 F	2004-2014	F & R
	50 SX Pro Senior LC	02-03	R		CRF 80 F	2004-2014	F & R
50 SX Pro Senior LC/Mini Senior Adventure	02-07	R	NCH 50 Metropolitan	2013-2024	F		
SX 50 Junior LC	07-09	R	NH 80 Aero	1985	R		
323/323G	HONDA			NPS 50 Ruckus/NPS S	2003-2024	F & R	
	NX 250	1988-1990	R	NU 50 M Urban Express	1982-1983	F	
	XL 250 R Pro Link	1982-1987	R	SA 50 P Elite S	1994-2001	F & R	
	XL 250 S	1978-1980	R	TLR 200 Reflex	1986-1987	R	
	XL 350 R	1984-1985	R	XR 100 R	1985-2004	F & R	
	XR 250	1979-1980	R	XR 70 R	1997-2003	F & R	
	XR 250 R Pro Link	1981-1982	R	XR 80 R	1985-2004	F & R	
	NX 250	1988-1990	R	SYM			
	XL 250 R Pro Link	1982-1987	R	DD 50	2002-2012	R	
	XL 250 S	1978-1980	R	338/338G	ARCTIC CAT ATV		
	XL 350 R	1984-1985	R		50 2 x 4 Youth	2004-2006	F
XR 250	1979-1980	R	50 4 x 4 Auto Youth		2006-2008	F	
XR 250 R Pro Link	1981-1982	R	50 DVX Sport		2006-2008	F	
NX 250	1988-1990	R	90 2 x 4 Youth		2002-2006	F	
XL 250 R Pro Link	1982-1987	R	90 Alterra		2018-2023	F	
XL 250 S	1978-1980	R	90 DVX		2006-2018	F	
XL 350 R	1984-1985	R	90 Reverse Gear Model		2010-2013	F	
XR 250	1979-1980	R	E-TON				
XR 250 R Pro Link	1981-1982	R	AXL 90 Thunder		1999-2000	F	
324/324G	HONDA				BXL 100 Draco	2005-2006	F
	CR 125 R Elsinore	1979-1981	F		BXL 50 Draco	2005-2006	F
	CR 250 R Elsinore	1978-1980	F		NXL 90 Thunder	2001-2002	F
XR 500	1979-1980	F	RXL 90 R Viper 90 R Reverse		2003-2009	F	
325/325G	HONDA				RXL 90 Viper 90	2003-2006	F
	CR 250 R Elsinore	1978-1980	R	Viper 50 Mini RXL 50 M	2003-2008	F	
Navi 110	2022-2023	F & R	Viper 50 RXL 50	2003-2006	F		
327	HONDA			Viper 70 RXL 70/70M	2005-2009	F	
	CR 250 RB	1981	F	HONDA			
	CR 450 R	1981	F	CR 80 R	1985-1991	R	
	CR 480 RC	1982	F	KAWASAKI			
	XR 250 R Pro Link	1981-1982	F	KFX 50	2013-2024	F	
	XR 500 R Pro Link	1981-1982	F	KFX 90	2001-2024	F	
328/328G	HONDA			KSF 50 KFX	2007-2009	F	
	CR 250 R	1982-1983	F	POLARIS			
CR 480 RD	1983	F	Outlaw 110	2016-2022	F		
330/330G	BOMBARDIER/BRP			Outlaw 50	2008-2018	F	
	DS 50	2002-2006	R	Outlaw 90	2007-2016	F	
	DS 90	2002-2006	R	Predator 50	2004-2007	F	
	Quest 50	2003-2004	R	Predator 90	2003-2006	F	
	Quest 90	2003-2004	R	Scrambler 50	2001-2003	F	
	E-TON			Scrambler 90 X	2001-2003	F	
	AXL 90 Thunder	1999-2000	R	Sportsman 90	2001-2016	F	
	DXL 90 Sierra	1999-2003	R	339/339G	HONDA		
	ELX 150 Yukon	2005-2006	R		FL 350 R Odyssey	1985-1987	F
	EXL 150 Yukon ST	2005-2006	R		FL 400 R Pilot	1989-1990	F
	NXL 90 Thunder	2001-2002	R		TRX 200 Fourtrax	1984	F
Viper EXL 150 ST Quad	2005-2006	R	TRX 250 Fourtrax		1985-1987	F	
YXL 150 Yukon	2000-2002	R	340-340G	HONDA			
HONDA				GB 500	1989-1990	R	
CR 125 R Elsinore	1979-1981	R		TRX 250 EX Sportrax	2001-2008	R	
CR 125 RC	1982	F & R		TRX 250 TE Recon ES	1997-2021	R	
CR 250 RC	1982	R		TRX 250 TM Recon	1997-2021	R	
CR 480 RC	1982	R		TRX 250 X	2009-2014	R	
TRX 70 Fourtrax	1986-1987	R		KYMCO			
XL 125 S	1985	F		K-Pipe 125	20	R	
XL 250 R Pro Link	1982-1987	F		Spade 150i	20	R	
331/331G	HONDA						
	CR 125 RD	1983		F & R			
CR 125 RE	1984-1985	R					

BUYERS GUIDE
BRAKE SHOES

BRAKE SHOE BUYERS GUIDE

Part No.	Make/Model	Year	F/R	Part No.	Make/Model	Year	F/R			
341	HONDA CH 250 Elite	1985-1986	R	351/351G Contd.	TRX 400 F Fourtrax Rancher All Models	2004-2007	R			
342/342G	HONDA TRX 350 Fourtrax Foreman	1986-1989	F		TRX 400 F Fourtrax Foreman All Models	1995-2003	R			
343/343G	HONDA TRX 350 Fourtrax Foreman TRX 500 FA Fourtrax Rubicon CB 700 SC/S 'Nighthawk' VF 700 C 'Magna' VT 700 C 'Shadow' VF 750 C Magna/Magna Deluxe CD/C2 VF 750 C V45 Magna VT 750 Shadow All Models VT 750 C Shadow Spirit PC 800 Pacific Coast VT 800 C Shadow VT 1100 C Shadow/Shadow Spirit	1986-1989	R		TRX 420 Fourtrax Rancher All Models	2006-2024	R			
		2001-2014	R	TRX 450 Fourtrax Foreman All Models	1998-2004	R				
		84-86	R	TRX 500 Foreman All Models	2014-2019	R				
		85-87	R	TRX 500 Fourtrax All Models	2007-2019	R				
		86-87	R	TRX 520 Foreman All Models	2020-2022	R				
		94-03	R	352	HONDA					
		88	R		ADV 160 A AC	2024	R			
		01-24	R		C 125 Super Cub	2018-2023	R			
		08-14	R		CG 125	2001-2006	R			
		89-90/94-99	R		NHX 110 Elite	2010-2011	R			
88	R	NXR 125	2003-2008		F					
85-07	R	NXR 150	2003-2008		F					
344/344G	HONDA CR 125 RG CR 250 RG CR 500 RG	1986	R		PCX 125	2011	R			
		1986	R		PCX 125 S - WW AK	2018-2021	R			
		1986	R		PCX 150	2018-2021	R			
345/345G	HONDA TRX 200 D Type II Fourtrax TRX 200 Fourtrax TRX 200 SX Fourtrax TRX 250 TE Recon ES TRX 250 TM Recon TRX 300 Fourtrax 2WD	1991-1997	F	PCX 150 WW150	2009-2015	R				
		1990-1991	F	PCX 160 A AC	2023-2024	R				
		1986-1988	F	SH 150i	2010-2011	R				
		1997-2021	F	501	YAMAHA					
		1997-2021	F		CA 50 Riva	1983-1986	F			
		1988-2000	F		CE 50	1986-1987	F			
346/346G	BOMBARDIER/BRP DS 50 DS 90 Quest 50 Quest 90 CAN AM DS 70 2 x 4 Mini DS 90 2 x 4 Renegade 110 Renegade 70 HONDA TRX 70 Fourtrax KYMCO ATV Mongoose 50 Mxer Mongoose 50 Mongoose 70 Mongoose 90 UNISON Desert Cat Desert Cat 90 YAMAHA YFM 90 Raptor 90 YFZ 50 Y	2002-2006	F		CG 50	1988-1991	F			
		2002-2006	F		MJ 50 J Towny	1982	F & R			
		2003-2004	F		PW 50	1981-2024	F & R			
		2003-2004	F	QT 50 Yamahopper	1980-1987	F & R				
		2008-2021	F	SH 50 Razz	1987-1999	F				
		2006-2021	F	502/502G	SUZUKI					
		2023	F		RM 80	1982-1989	R			
		2023	F		YAMAHA					
		1986-1987	F		BW 80	1986-1990	F			
		2008-2009	F		PW 80	1983-2008	F			
2004-2008	F	TT-R 110 E	2008-2024		F					
2007-2021	F	TT-R 90	2000-2007	F						
2002-2021	F	YZ 50 G	1980	F & R						
2004	F	YZ 60	1981-1983	F & R						
2016-2017	F	YZ 80	1980-1992	F & R						
2017-2020	F	503/503G	ADLY							
347/347G	HONDA TRX 300 Fourtrax 4WD TRX 350 Rancher 4x4 All Models TRX 400 F Fourtrax Rancher All Models TRX 400 F Fourtrax Foreman All Models TRX 450 FE Fourtrax Foreman ES TRX 450 FM Fourtrax Foreman S TRX 500 FA Fourtrax Rubicon TRX 500 FGA Fourtrax Foreman Rubicon Gpscape TRX 650 FA Rincon		1988-2000	F	Noble 50/Thunderbike	07-09	R			
			2000-2006	F	Panther 50	07-08	R			
			2004-2007	F	Jet 50	07-09	R			
			1995-2003	F	Fox 50	07-09	R			
			2002-2004	F	CPI					
			2002-2004	F	Oliver City 50	05-09	R			
			2002-2004	F	MZ/MUZ					
			2001-2004	F	Moskito/SX 50/RX 50	97-05	R			
			2004	F	POLARIS					
		2003-2005	F	Trail Boss 2x4	85-87	F				
347S/347SG	HONDA TRX 450 Fourtrax Foreman	1998-2001	F	Scrambler 3 wheeler	85-86	F				
				Cyclone 250 X	87	F				
350	HONDA CH 250 Elite CN 250 Helix NX 125 ITALJET Velocifero 50	1987-1990	R	UM UNITED MOTORS						
		1986-2007	R	X-Peed 50/Special Edition	00-05	R				
		1988-1990	F	YAMAHA						
351/351G	HONDA PS 250 Big Ruckus TRX 350 Rancher 4x4 All Models	2005-2006	R	Breeze 125 YFA1	1989-2004	F				
		2000-2006	R	BW 200	1985-1987	F & R				
		347S/347SG	HONDA TRX 450 Fourtrax Foreman	1987-1990	R	DT 100 K	1983	F & R		
				1986-2007	R	DT 80 K	1983	F & R		
				1988-1990	F	MX 100 K	1983	F & R		
				1998-2003	F	PW 80	1992-2008	R		
				347S/347SG	HONDA TRX 450 Fourtrax Foreman	2005-2006	R	RT 100	1991-2000	F & R
						2000-2006	R	TT 225	1986-1987	R
						1987-1990	R	TT-R 110 E	2008-2024	R
						1988-1990	F	TT-R 125	2000-2009	F & R
1998-2003	F					TT-R 125 LE	2010-2024	R		
1998-2003	F					TT-R 90	2000-2007	R		
1998-2003	F	TW 200	1987-2024			R				
1998-2003	F	XT 125	1982-1983			R				
1998-2003	F	XT 200	1982-1983			R				
1998-2003	F	XT 225 Serrrow	1992-2000			R				
1998-2003	F	YFB 250 Timberwolf	1992-1994	F						
1998-2003	F	YFM 100 Champ	1989-1991	F						
1998-2003	F	YFM 125 Grizzly	2004-2013	F						
1998-2003	F	YFM 200	1985-1989	F						
1998-2003	F	YFM 225	1986-1988	F						
1998-2003	F	YFM 350 Big Bear	1987-1988	F						
1998-2003	F	YFM 50 Raptor	2004-2007	F						

BUYERS GUIDE
BRAKE SHOES

Part numbers, prefixes, suffixes, photos and illustrations shown in this catalog are trademarks and/or copyrights of EBC Brakes or the trademark owner A C Freeman Investments Ltd and use without express written permission of the owners is punishable by law.

BRAKE SHOE BUYERS GUIDE

Part No.	Make/Model	Year	F/R	Part No.	Make/Model	Year	F/R	
503/503G Contd.	YFM 80 Badger	1992-2001	F	510/510G	YZ 490	1982-1989	R	
	YFM 80 Grizzly	2005-2008	F		512	YAMAHA		
	YFM 80 Raptor	2002-2008	F			XJ 550 Maxim	1981-1983	R
	YFS 200 Blaster	1988-2002	F			XJ 650 LH Midnight	1981	R
	YT 175	1982-1983	F			XJ 650 Maxim	1980-1983	R
	YTM 200	1983-1985	F			XS 500 B	1975	R
	YTM 200 ERN	1985	F			XV 500 K Virago	1983	R
	YTM 225	1983-1986	F			XV 750 Virago	1981-1983	R
	YZ 100	1982-1983	F			XZ 550 RJ	1982	R
				XZ 550 RK		1983	R	
				YX 600 Radian	1986-1990	R		
504/504G	U.M. United Motors	2004-2005	R	513	YAMAHA			
	Zyclone 50				R5/5A/5B 350cc	1970-1972	F	
	YAMAHA				XS 400	1980-1981	F	
	BW 350	1987-1988	R	XS 400 SJ	1982	F		
	DT 100	1980-1982	F & R	514	YAMAHA			
	DT 80	1981-1982	F & R		R5/5A/5B 350cc	1970-1972	R	
	IT 125	1980-1981	F		RD 350	1973-1975	R	
	LB 50 Chappy	1980-1982	F & R		TX 650	1974-1976	R	
	MX 100	1980-1982	F & R		XS 650	1977-1979	R	
	MX 175	1980-1981	F		XS 650	1980-1981	R	
	RX 50 MK/K/L	1983-1984	R		XS 650 Heritage Special	1982-1983	R	
	RX-Z 135	1987-1989	R		XS2/TX 650	1972-1973	R	
	TY 350	1985-1986	R		515	YAMAHA		
	YZ 100	1980-1981	F			TX 750/TX 750 A	1973-1974	R
			XJ 650 LJ Seca Turbo			1982	R	
			XJ 650 LK Seca	1983		R		
			XJ 650 RJ Seca	1982		R		
			XJ 700	1985-1986		R		
			XJ 750 Maxim	1982		R		
			XJ 750 Seca	1981-1983		R		
			XV 1000	1984-1985		R		
			XV 1100 All models	1986-1997		R		
			XV 535 Virago	1987-1994		R		
			XV 535 Virago	1995-1999	R			
			XV 700	1984-1987	R			
			XV 750 Virago	1988-1994	R			
			XV 750 Virago	1994-1997	R			
			XV 920 J Virago	1982	R			
			XV 920 K	1983	R			
			XV 920 MK Virago	1983	R			
			XV 920 RH/RJ	1981-1982	R			
			XVS 650 V Star Classic	1998-2010	R			
			XVS 650 V Star Custom	1997-2011	R			
			XVS 650 V Star Custom	2013-2020	R			
			XVS 650 V-Star Silverado	2003-2010	R			
506/506G	YAMAHA			516/516G	YAMAHA			
	Breeze 125 YFA1	1989-1991	R		XJ 550 Seca	1981-1983	R	
	DT 125	1980-1981	F & R		XS 400	1980-1981	R	
	DT 175	1980-1981	F & R		XS 400 J/K Maxim	1982-1983	R	
	IT 125	1980-1981	R		XS 400 RJ/RK	1982-1983	R	
	IT 175	1980-1983	R		XS 400 SJ	1982	R	
	MX 175	1980-1981	R		YFM 350	1996-1998	R	
	RT 180	1990-1992	R		YFM 350	1999	R	
TT 250 R	1980-1982	R	YFM 350 Big Bear	1996-1998	R			
TT 350 A 3GJ	1986-1987	R	YFM 350 Big Bear	1999	R			
TT 600	1983-1986	R	YFM 400 2x4 Big Bear	2003-2004	R			
TW 200	1987-1991	F	YFM 400 Big Bear	2000-2001	R			
XT 125	1982-1983	F	YFM 400 Big Bear	2000-2002	R			
XT 200	1982-1983	F	YFM 400 Big Bear Buckmaster	2001	R			
XT 250	1980-1984	F & R	YFM 400 Big Bear Real Tree-tra	2000-2004	R			
XT 350	1985-1990	R	YFM 400 FAR Kodiak Auto	2003	R			
YFM 100 Champ	1987-1991	R	YFM 400 Kodiak	1993-1998	R			
YFM 80	1987-1988	R	YFM 400 S Big Bear	2004	R			
YZ 100	1980-1983	R	YFM 600 Grizzly	1998-2000	R			
YZ 125	1980-1982	R	YFM 600 Grizzly/Hunter Edition	2001	R			
YZ 125	1986-1987	R	YP 250 Majesty	1997	R			
YZ 250	1980-1987	R	517G	YAMAHA				
YZ 490 K	1983	R		BW 350	1987-1988	F		
				IT 200	1984-1985	F & R		
				IT 200	1986	R		
				TY 350	1985-1986	F		
				YZ 125	1983-1986	R		
507/507G	YAMAHA							
	IT 175	1980-1983	F					
	IT 250	1977-1982	F					
	IT 425 G	1980	F					
	TT 250 R	1980-1982	F					
	TT 500	1980-1981	F					
	YZ 125	1980-1983	F					
YZ 250 G	1980-1981	F						
508/508G	YAMAHA							
	IT 250 K	1983	F					
	IT 465 H	1981-1982	F					
	IT 490 L	1983-1984	F					
	TT 600	1983-1984	F					
	YZ 125 L	1984	F					
	YZ 250	1982-1984	F					
	YZ 465 G	1980	F					
	YZ 465 H	1981	F					
	YZ 490	1982-1984	F					
510/510G	YAMAHA							
	DT 250	1975-1979	R					
	DT 250 A	1974	F & R					
	IT 250	1981-1982	R					
	IT 250 K	1983	R					
	IT 465 H	1981-1982	R					
	IT 490 L	1983-1984	R					
	XT 500	1980-1981	R					
	XT 550	1982-1983	F & R					
	XT 600	1984-1989	R					
	YZ 250 H	1981	R					
	YZ 465 H	1981	R					

BUYERS GUIDE
BRAKE SHOES

BRAKE SHOE BUYERS GUIDE

Part No.	Make/Model	Year	F/R	Part No.	Make/Model	Year	F/R			
518/518G	YAMAHA			528/528G Contd.	YFM 350	1989-1992	F			
	CW 50 Riva Zuma	89-90	F & R		YFM 350	1993-1995	F			
	DT 50 LC	88-90	F & R		YFM 400 FWBL Kodiak	1999	R			
	YT 60 Tri-Zinger	84-85	R		YFP 350 U Terrapro	1988	F			
	YF 60 S Moto 4	86	R		YZ 465 G	1980	R			
	PW 80	83-85/91	R							
	YFM 80	87-88	F		530	YAMAHA				
	YA 90 Axis	91-95	R			T 105 SE Crypton	2010	R		
	YFM 100 Champ	87-88	F			T 110	2011-2013	R		
	T 105 SE Crypton	99-02	R			T 110 C	2011-2013	R		
RXS 115 3HB6/7	94-99	R	XA 125 Cygnus	2012		R				
			XC 100 Jog	2005-2006		F & R				
			XC 50 Vino Classic	2001-2017		F & R				
			XF 50 50cc Scooter	2007-2011		F & R				
			YJ 125 Vino	2004-2009		R				
			YJ 50 Vino 50	2001-2004		F & R				
			YJ 50 Vino Classic	2002-2005	F & R					
			Zuma 50 F	2012-2016	R					
			Zuma 50 FX	2014-2021	R					
519	YAMAHA			531	YAMAHA					
	LC 50 G/H Champ	80-81	F & R		AF 115 S Fino	2012	R			
	CA 50 K/L/N/S 'Riva'	83-86	R		AT 115	2007	R			
	CE 50 ES/ET	86-87	R		AT 115 C Nuvo	2005-2006	R			
	CG 50 EU/W/A/B	88-91	R		FZ 150	2007-2008	R			
	SH 50 Razz	87-94/98-99	R		YBR 125	2006-2013	F & R			
	SH 50 Ed-Mint 3PR1/4CK1/3/4	89-94	F & R		Zuma 50	2002-2005	R			
	CY 50 D/E/F/K/L Jog	92-94/98-99	F		Zuma 50	2008-2011	R			
	YJ 50 Vino/Vino Classic	-02	F							
	BW 80 S/T/U/A	86/88-90	R							
520/520G	YAMAHA			532/532G	YAMAHA					
	YFM 350 Big Bear	1987-1988	F		YFM 250 Big Bear	2007-2009	R			
521	YAMAHA				YFM 250 Bruin	2005-2006	R			
	XC 125 Riva	1985-1992	F		YFM 350 Bruin 2x4 Auto	2004-2006	R			
	XC 125 Riva	1993-1994	F		YFM 350 Bruin 4x4 Auto	2004-2006	R			
	XC 125 Riva	1998	F		YFM 350 Grizzly 2x4	2007-2011	R			
	XC 180 Riva	1983-1985	F		YFM 350 Grizzly Auto 4x4	2006-2013	R			
XC 200 Riva	1987-1991	F	YFM 350 Wolverine		2006-2009	R				
522	YAMAHA				YFM 400 Big Bear	2004-2006	R			
	SR 250	1993-2008	F		YFM 400 Kodiak	2003-2004	R			
523/523G	YAMAHA			533	YAMAHA					
	Pro Hauler Pro 4 YFU1TW	1989	R		YW 125 X	2010-2013	R			
YFP 350 U Terrapro	1988	R	YW 125 Zuma		2009-2015	R				
524G	YAMAHA				534/534G	YAMAHA				
	YFM 350	1996-1998	F			YXP 700 Pro Hauler	2004-2006	R		
	YFM 350 Big Bear	1989-1998	F			YXP 1000 Pro Hauler 1000	2004-2005	F & R		
	YFM 400 Kodiak	1993-1998	F							
	527/527G	YAMAHA					535	YAMAHA		
		Breeze 125 YFA1	1992-2004			R		FZ 16 160cc	2010-2013	R
		RT 180	1993-1997			R		FZ 16 S 160cc	2012-2013	R
		RX-Z 135	1993-1997	R		FZ 16 ST 160cc		2011-2013	R	
		RX-Z 135	2000-2005	R		XV 250 V-Star		2013-2022	R	
		SR 250	1993-2008	R		YBA 125 Enticer		2007-2012	R	
TT-R 225		1999-2003	R	YBR 250	2010-2012	R				
TT-R 230		2005-2024	R	YS 250 Fazer	2006-2010	R				
TW 200		1992-2000	F							
XC 125 Riva		1993-1998	R	536/536G	YAMAHA					
XT 350		1991-2000	R		YFM 90 Raptor	2010-2013	F			
XV 250 Virago		1995-2007	R		YFM 90 RY Raptor	2009	F			
XV 250 V-Star		2008-2012	R		YFM 90 Raptor	2010-2013	F			
YA 100 W Grand Axis		2001-2003	R		YFM 90 RY Raptor	2009	F			
YBA 125 Vision		2001	R							
YBR 125		2001-2013	F & R		537	YAMAHA				
YFM 125 Grizzly		2004-2013	R			XC 180 Riva	83-85	R		
YFM 50 Raptor		2004-2007	R			XC 200 Riva	87-91	R		
YFM 80 Badger		1992-2001	R			SRX 250 T/TC	87	R		
YFM 80 Grizzly		2005-2008	R							
YFM 80 Raptor	2002-2008	R								
YW 100 BW's	1997-2008	R								
528/528G	YAMAHA			601		SUZUKI				
	DT 250	1975-1979	F			FZ 50	1979-1983	F & R		
	IT 250	1977-1980	R							
	IT 425 G	1980	R		602/602G	HYOSUNG				
	Pro Hauler Pro 4 YFU1TW	1989	F			RX 125	2006-2008	R		
	TT 500	1980-1981	R	KAWASAKI						
	XT 500	1980-1981	F	BN 125 Eliminator		2001-2009	R			
	YFB 250 Timberwolf	1992-1994	R	KD 125		1975-1979	R			
	YFB 250 Timberwolf	1994-2000	F & R	KDX 175 A		1980-1982	R			
	YFB 250 Timberwolf	1995-1998	F & R	KDX 250 B		1983-1984	R			
	YFM 250 Bear Tracker	1999-2000	F & R	KE 125 A		1976-1983	R			
	YFM 250 Beartracker	2001-2004	R	KL 600 A		1984	R			
	YFM 250 W/A/B	1989-1991	F							

BUYERS GUIDE
BRAKE SHOES

Part numbers, prefixes, suffixes, photos and illustrations shown in this catalog are trademarks and/or copyrights of EBC Brakes or the trademark owner A C Freeman Investments Ltd and use without express written permission of the owners is punishable by law.

BRAKE SHOE BUYERS GUIDE

Part No.	Make/Model	Year	F/R	Part No.	Make/Model	Year	F/R		
602/602G Contd.	KLR 600 B	1985-1986	R	603/603G Contd.	DR-Z 110	2003-2005	R		
	KLF 110 Mojave	1987-1988	R		RM 100	1976-1978	F & R		
	KLT 110 A	1984-1986	R		RM 50 C/N/T	1978-1980	F & R		
	KLT 160 A1	1985	R		RM 60 N/T	1979-1980	F & R		
	KLT 185 A	1986-1987	R		RV 125 Tracker	1973	F		
	KLX 250 A	1979-1980	R		TC 100 Blazer	1973-1975	F		
	KX 125 A	1974-1981	R		TC 125 Prospector	1972-1973	F		
	KX 125 B1	1982	R		TC 90 Blazer	1971-1972	F		
	KX 250	1982-1985	R		TM 125 Challenger	1973-1975	F		
	KX 500 A	1983-1985	R		TS 100 Honcho	1973-1975	F		
	KZ 250 LTD	1980-1983	R		TS 90 Honcho	1971-1972	F		
	SUZUKI					604/604G	KAWASAKI KLX 125 A KLX 125 L KSF 50 KFX SUZUKI DR 100 DR-Z 125 DR-Z 125 L DS 80 GSXR 50 JR 80 LT-A 50 QuadSport LTZ 50 QuadSport LT-Z 90 QuadSport OR 50 T RM 50 X RM 60 X/Z/D RM 80 SP 100 D		
	A 100 A/B Gofer	1976-1977	F		2003-2006			F & R	
	B 100 P Magnum	1965-1966	F & R		2003-2006			R	
	B 105 P Bearcat	1967-1968	F & R		2003-2005			R	
	B 120	1971-1977	F & R						
	DR 125	1982-1996	F & R		1983-1990			F & R	
	DR 200	1986-2021	R		2003-2016			F & R	
	DR 250	1982-1983	F & R		2003-2024			R	
	DR 250 F	1985	R		1980-2000			F & R	
	DR 370	1978-1979	F		1987			R	
	DR 400 T	1980	F		2001-2004			F & R	
	DR 500	1981-1983	F		2002-2005			R	
	DS 100	1978-1981	F & R		2006-2014	R			
	DS 125	1979-1981	F & R		2007-2018	F			
	DS 185 T	1980	F & R		1980	F & R			
	GN 125	1982-1983	F & R		1981	F & R			
	GN 125	1991-1996	R		1981-1983	F & R			
	GN 250 J	1988	R		1980-1981	F & R			
	GT 185 Adventurer	1974-1976	R		1983	R			
	GZ 250 Marauder	1999-2010	R						
	KT 120 Trail	1968-1970	F & R	605/605G	KAWASAKI KDX 250 A/B KDX 400 A KDX 420 B1 KDX 450 A1 KL 250 A KX 250 A KX 420 A KZ 250 LTD SUZUKI DR 370 DR 400 T DR 500 DS 250 T LT 160 LT 160 QuadSport LT 230 GEF/GEG LT-F 160 LT-F 230 G/H PE 250 B/C/N PE 400 RM 250 RM 250 N RM 370 RM 400 S32 150cc SP 370 SP 400 T SP 500 TM 400 Cyclone TS 250 TS 400				
	PE 175	1980-1981	F				1980-1982	R	
	RM 125	1976-1980	F & R				1979-1980	R	
	RM 250	1976-1978	F				1981	R	
	RM 370	1976-1977	F				1982	R	
	RM 400 C	1978	F				1978-1980	R	
	RM 465	1981-1982	R				1980-1981	R	
	RS 175	1980-1982	F				1980-1981	R	
	RV 125 Tracker	1973-1977	F & R				1980-1981	R	
	SP 125	1982-1988	F & R				1980-1983	F	
	SP 200	1986-1988	R						
	SP 250	1982-1985	R				1978-1979	R	
	SP 600 F	1985-1987	R		1980	R			
	T 125 R Stinger	1969-1971	F & R		1981-1983	R			
	TC 100 Blazer	1973-1975	R		1980	F & R			
	TC 100 Blazer	1976-1977	F & R		1989-1992	R			
	TC 120 Trailcat	1968-1971	F & R		2003-2004	R			
	TC 125 Prospector	1972-1973	R		1985-1986	R			
	TC 125 Prospector	1974-1977	F & R		1991-2003	R			
	TC 90 Blazer	1970	F & R		1986-1987	R			
	TC 90 Blazer	1971-1972	R		1977-1981	F & R			
	TM 125 Challenger	1973-1975	R		1980-1981	F & R			
	TM 400 Cyclone	1971-1975	F		1976-1978	R			
	TS 100	1976-1981	F & R		1979	F			
	TS 100 Honcho	1973-1975	R		1976-1977	R			
	TS 100 Honcho	1976-1977	F & R		1978-1979	R			
	TS 125	1980-1981	F & R		1965	F & R			
	TS 185	1980-1981	F & R		1978-1979	F & R			
	TS 90 Honcho	1970	F & R		1980	F & R			
	TS 90 Honcho	1971-1972	R		1981-1983	F & R			
	TU 250	2009-2016	R		1971-1975	R			
	U.M. United Motors				1971-1981	F & R			
	V2C 250 T	2006-2008	R		1972-1977	F & R			
	603/603G	KAWASAKI KD 80 M KD 80 N KE 100 KLF 110 Mojave KLT 110 A1/A2/A3 KLT 160 A1 KLT 185 A KLT 200 A KLT 250 A1/A2 KLT 250 P1 Police KLT 250 Prairie KLX 110 L KLX 110 R KM 100 SUZUKI	1980-1987	F & R	606/606G	ATK GV 250 V-Twin Cruiser HYOSUNG GV 250 SUZUKI GN 400 TT GR 650 Tempter GS 250 GS 300 LF GS 425 GS 450 GS 550 LS 650 Boulevard S40 LS 650 Savage LT-A 400 Eiger LT-A 400 King Quad	2011	R	
			1988-1990	R				2006-2012	R
			1976-2001	F & R					
			1987-1988	F				1980-1982	R
			1984-1986	F				1983	R
			1985	F				1980-1981	R
			1986-1987	F				1985	R
			1981-1984	F				1979	R
1982-1983			F				1980-1988	R	
1984			F				1983-1986	R	
1983-1985			F				2005-2015	R	
2010-2021			R				1986-2004	R	
2002-2024			R				2002-2018	R	
1976-1981			F & R				2008-2022	R	

BRAKE SHOE BUYERS GUIDE

Part No.	Make/Model	Year	F/R	Part No.	Make/Model	Year	F/R		
606/606G Contd.	LT-F 250 4WD V/W Quadrunner	1997-1998	R	619/619G	SUZUKI PE 175	1980-1984	R		
	LT-F 400	2002-2007	R		620	SUZUKI RM 250 RM 400 SP 250	1979-1980	R	
	LT-F 400	2003-2008	R	1979-1980			R		
	LT-F 400 K2 Eiger	2002	R	1982-1983			F		
	LT-F 400 K8	2008	R	621	SUZUKI RM 250 X RM 465	1981-1982	F		
LT-F 400 King Quad 400	2008-2016	R	1981-1982			F			
608	SUZUKI			622	SUZUKI RM 125 E RM 250 RM 500	1984	F		
	GT 380 J Sebring	1972	F			1983-1984	F		
	T 250 11/R/J Hustler	1969-1972	F	624/624G	DERBI Atlantis 50 All models GP1 50 HUSQVARNA WRS 50 Scooter ITALJET Formula 50 Air Cooled Torpedo 50 Velocifero 50 SUZUKI LT 160 LT 160 QuadSport LT-F 160	99-01	R		
	T 305 Raider	1968-1969	F			02-06	R		
	T 350 Rebel	1969-1972	F			98-00	R		
	T10 250	1966-1967	F			99-03	R		
	T20 250 X6	1965-1969	F			98-04	R		
TC 250 X6 Scrambler	1967-1969	F	98-03	R					
609	SUZUKI			625/625G	SUZUKI LT 230 GEF/GEG LT 250 EFF/EFG LT 300 J/K LT-F 230 G/H	1985-1986	F		
	GS 400	1977-1978	R			1985-1986	F		
	GS 425 N	1979	R			1987-1989	F		
	GS 450	1982	R			1986-1987	F		
	GT 250 Hustler	1973-1977	R			626	SUZUKI GV 700 VL 800 Boulevard Tourer VL 800 BTL4 VL 800 C50 Boulevard VL 800 CL3 VL 800 Intruder Volusia VS 700 VS 750 Intruder VS 800 Boulevard VS 800 Intruder VZ 800 Boulevard VZ 800 Marauder	1985	R
	GT 380 Sebring	1972-1977	R					2005-2022	R
	GT 500 Titan	1976-1977	R					2014	R
	GT 550 Indy	1973-1975	R					2005-2022	R
	T 250 11 Hustler	1969-1972	R					2013	R
	T 305 Raider	1968-1969	R					2001-2004	R
	T 350 Rebel	1969-1972	R					1986-1987	R
	T 500 1 Cobra	1968	R					1988-1991	R
	T 500 Titan	1969-1975	R					2005-2009	R
	T10 250	1966-1967	R	1992-2004	R				
T20 250 X6	1965-1969	R	2005-2010	R					
TC 250 X6 Scrambler	1967-1969	R	1997-2004	R					
611	SUZUKI			628/628G	KAWASAKI KAF 300 Mule 500 KAF 300 Mule 550 SUZUKI LTF 250 Quadrunner 4WD LT-F 250 Quadrunner			1992-1995	F
	GS 550	1977	R					1997-2003	F
	GS 550 LZ	1982	R			1987-1998	F		
	GT 550 Indy	1976-1977	R			1988-2002	F		
612	SUZUKI			629/629G	SUZUKI LTF 250 Quadrunner 4WD LT-F 250 Quadrunner	1987-1998	R		
	GS 300 LF	1985	F			1988-2002	R		
	GS 400	1977-1978	F	633/633G	SUZUKI LT-F 300 King Quad	1991-2001	F		
	GS 450	1983	F			634/634G	SUZUKI LT 250 E LT 300 J/K LT-A 500 F Quadmaster LT-F 300 King Quad LT-F 500 Quadrunner	1985-1986	R
	T 500 1 Cobra	1968	F					1987-1989	R
T 500 Titan	1969-1975	F	2000-2001	R					
			1991-2002	R					
613/613G	KAWASAKI			636/636G	SUZUKI LT-F 250 Ozark LT-Z 250 QuadSport	2002-2014	R		
	KDX 50 A1-A6F	2003-2006	F & R			2004-2011	R		
614/614G	SUZUKI			701/701G	KAWASAKI KDX 80 A KX 80 C	1980-1983	F & R		
	DXL 90 Sierra	1999-2003	F			1981-1982	F & R		
	KAWASAKI								
	KSF 50 KFX	2003-2005	F						
	KSF 80	2003-2006	F						
615	SUZUKI								
	FA 50	80-91	F & R						
	FS 50 T/X	80-81	F & R						
	LT 80	1987-2006	F						
	LT-A 50 QuadSport	2002-2005	F						
	LTZ 50 QuadSport	2006-2024	F						
	SUZUKI								
RM 80	1982-1985	F							
616/616G	SUZUKI								
	RM 125	1981-1987	R						
	RM 250 D	1983	R						
618/618G	SUZUKI								
	RM 250 X	1981-1982	R						
	KAWASAKI								
	KSF 80	2003-2006	R						
	SUZUKI								
	LT 80	1987-2006	R						
	LT-Z 90 QuadSport	2007-2018	R						
	PE 175	1982-1984	F						
RM 125	1981-1983	F							

BUYERS GUIDE
BRAKE SHOES

BRAKE SHOE BUYERS GUIDE

Part No.	Make/Model	Year	F/R	Part No.	Make/Model	Year	F/R
702/702G	KAWASAKI KDX 200 KX 125	1983-1988 1983-1985	R R	710/710G	KAWASAKI H1 500 KH 500 A8 KLF 300 Bayou 4x4 KLF 400 Bayou KVF 300 Prairie 2 x 4 KVF 300 Prairie 4 x 4 KVF 400 Prairie	1973-1975 1976 1989-2005 1993-1999 1999-2002 1999-2002 1997-2002	R R R R R R
703/703G	KAWASAKI KDX 200 A KE 175 D KL 250 KL 250 KLR	1983-1985 1980-1983 1980-1984 1985-2005	F R R R			711	KAWASAKI KH 250 A5 KZ 440 B KZ 400 S S1 A/B/C S2
704/704G	KAWASAKI KD 125 KDX 175 A KX 125 A KE 125 A KE 175 D KL 250 KLX 250 A	1975-1979 1980-1982 1974-1981 1976-1983 1980-1983 1980-1984 1979-1980	F F F F F F F	713	KAWASAKI H2 A Mach IV 750-2T H2 B/H-C Mach IV 750-2T KZ 900 A4/A5 Z 900 Z1A/B		
705/705G	KAWASAKI KDX 250 A/B KDX 250 B KDX 400 A KDX 420 B1 KDX 450 A1 KL 250 A KLF 185 Bayou KLF 220 Bayou KLF 250 Bayou KLT 200 KLT 250 A1/A2 KLT 250 P1 Police KLT 250 Prairie KX 250 A KX 420 A KXT 250 A1 Tecate	1980-1982 1983-1984 1979-1980 1981 1982 1978-1980 1986-1988 1988-2002 2003-2011 1981-1984 1982-1983 1984 1983-1985 1980-1981 1980-1981 1984	F F F F F F F F F F R R R F F F			714/714G	KAWASAKI KDX 80 KX 80 E1
706/706G	KAWASAKI EL 250 Eliminator EL 250 F EL252 EL 250 HS EX 305 GPz EX 500 A KLF 185 Bayou KLF 250 Bayou KLF 300 Bayou KZ 305 CSR KZ 305 LTD KZ 440 KZ 440 LTD W 650 EJ 650	1988-1989 1997-1999 1991-1995 1983 1987-1993 1986-1988 1988-2011 1986-2004 1981-1982 1987-1988 1980-1983 1980-1983 2000-2002	R R R R R R R R R R R R R	715/715G	KAWASAKI KX 60 KX 60 A1/A2 KX 80 KX 80 E1 KDX 80 KLX 110 L KLX 110 R KLF 300 Bayou SUZUKI RM 60 K3 DR-Z 110		
708	KAWASAKI KH 250 A5 KH 400 A S1 A/B/C S2 S2 A S3/S3-A A 400cc	1976 1976-1978 1973-1975 1972-1973 1972-1973 1974-1975	R R R R R R			717/717G	KAWASAKI KLF 300 A1/A2 'Bayou'
709	KAWASAKI EN 450 454 LTD EN 500 A/B EN 500 Vulcan KZ 550 A KZ 550 LTD KZ 550 Spectre F2 LTD KZ 650 KZ 650 H CSR KZ 650 LTD KZ 750 G1 LTD KZ 750 K LTD KZ 750 M1 CSR VN 700 Vulcan VN 750 Vulcan VN 800 Vulcan VN 800 Vulcan Classic ZL 600 A ZL 600 B Eliminator	1985-1990 1990-1995 1996-2009 1980-1983 1980-1983 1983-1984 1977-1980 1981-1983 1980 1980 1983-1984 1982 1985 1986-2006 1995-2005 1996-2005 1986-1987 1996-1997	R R R R R R R R R R R R R R R R R R	718	KAWASAKI KAF 300 Mule 500 KAF 300 Mule 550 KAF 400 Mule 600 KAF 400 Mule 610 4x4 KAF 400 Mule 610 4x4 KAF 400 Mule SX 4x4		
						709	KAWASAKI EN 450 454 LTD EN 500 A/B EN 500 Vulcan KZ 550 A KZ 550 LTD KZ 550 Spectre F2 LTD KZ 650 KZ 650 H CSR KZ 650 LTD KZ 750 G1 LTD KZ 750 K LTD KZ 750 M1 CSR VN 700 Vulcan VN 750 Vulcan VN 800 Vulcan VN 800 Vulcan Classic ZL 600 A ZL 600 B Eliminator
709	KAWASAKI EN 450 454 LTD EN 500 A/B EN 500 Vulcan KZ 550 A KZ 550 LTD KZ 550 Spectre F2 LTD KZ 650 KZ 650 H CSR KZ 650 LTD KZ 750 G1 LTD KZ 750 K LTD KZ 750 M1 CSR VN 700 Vulcan VN 750 Vulcan VN 800 Vulcan VN 800 Vulcan Classic ZL 600 A ZL 600 B Eliminator	1985-1990 1990-1995 1996-2009 1980-1983 1980-1983 1983-1984 1977-1980 1981-1983 1980 1980 1983-1984 1982 1985 1986-2006 1995-2005 1996-2005 1986-1987 1996-1997	R R R R R R R R R R R R R R R R	720	KAWASAKI KAF 620 H 4x4 KAF 620 Trans 4x4 KAF 620 Mule 4000 KAF 620 Mule 4010 4x4 All Models KAF 620 N9F KAF 620 S KAF 620 T KAF 620 V KAF 950 Mule 3010 Diesel All Models KAF 950 Mule 4010 Diesel 4x4 All Models SUZUKI QUV 620 FK5 Side x Side		

BUYERS GUIDE
BRAKE SHOES

BRAKE SHOE BUYERS GUIDE

Part No.	Make/Model	Year	F/R	Part No.	Make/Model	Year	F/R		
801G	HUSQVARNA			814G	ATK				
	ACC 390	1980-1981	F & R		560		84-85	R	
	ACCE 390	1980-1981	F & R		KTM				
	CR 125	1979-1981	F & R		80 MX		86-92	R	
	CR 125	1982-1984	R		GSXC/GS 125		85	R	
	CR 240	1980-1981	R		MX 125		84	F & R	
	CR 240	1982-1984	R		MX/MXC 125		85	R	
	CR 250	1975-1979	F & R		GSXC/GS 250		85	R	
	CR 250	1980-1981	R		MX/MXC/GS 250		84	F & R	
	CR 250	1982-1984	R		MX/MXC 250		85	R	
	CR 360	1975-1978	F & R		GSXC/GS 300		85	R	
	CR 390	1975-1979	F & R		MX/MXC 300		85	R	
	CR 390	1980-1981	F & R		MX/MXC/XC-GS 500		85	R	
	CR 390 Automatic	1978	F & R						
	CR 400	1971-1974	F & R		816	APRILIA			
	CR 430	1980-1981	R			Mojito 150 Custom		2005-2009	R
	CR 450	1971-1974	F & R			Scarabeo 100		2004-2014	R
	CR 500	1982-1984	R			Sport City 125		2008-2014	R
	TC 510	1989-2019	R	Sport City 50			2008-2012	R	
	TE 510	1989	R	SR 50 Motard			2012-2015	R	
	WMX 510	1989	R	DERBI					
	WR 125	1979	F & R	Atlantis Bullet/City			2002-2005	R	
	WR 240	1978	F & R	Boulevard 150			2003-2005	R	
	WR 250	1975-1978	F & R	ITALJET					
	WR 360	1975-1978	F & R	Jet Set 125/150			2003	R	
	WR 390	1978	F & R	Torpedo 125			1999-2004	R	
	WR 400	1975-1978	F & R	Torpedo 150			2003	R	
	WR 450	1971-1972	F & R	PIAGGIO					
	WXE 510	1989	R	Fly 150		2006-2012	R		
				Fly 50		2005-2015	R		
				Liberty 150		2017-2020	R		
			Liberty 150 S		2017-2020	R			
			Liberty 50		2017-2020	R			
			Liberty 50 S		2017-2020	R			
			LT 150		1998-2005	R			
			LT 50		1997-2005	R			
			Typhoon 125		2010-2020	R			
			Typhoon 50		2012-2015	R			
			VESPA						
			Electrica		2019-2020	R			
			Primavera 125		2013-2021	R			
			Primavera 125 Sean Wotherspoon		2021	R			
			Primavera 125 Touring		2020-2021	R			
			Primavera 150		2013-2020	R			
			Primavera 50		2013-2021	R			
			Sprint 150		2014-2020	R			
			Sprint 50		2014-2015	R			
			Sprint S 125		2021	R			
			817	APRILIA					
				Mojito Custom 50		2004-2006	R		
				Mojito Retro 50		2004-2005	R		
				Scarabeo 100 4T		04-05	R		
			818	KYMGCO STREET					
				People 150		2007-2012	R		
				People 50		2002-2012	R		
				People S 125		2005-2009	R		
				People S 200		2005-2010	R		
				People S50		2005-2009	R		
				Super 8		2007-2014	R		
				Super 8 150 X		2019-2021	R		
				MALAGUTI					
				Ciak 150		2002-2003	R		
			820	KYMGCO STREET					
				Super 8 50		2007-2014	R		
				Super 8 50X		2020-2023	R		
				SYM					
				Fiddle II 125		2008-2014	R		
				HD 125		2008-2012	R		
				HD 200		2008-2012	R		
				HS 125/200		2004-2008	R		
				Symba 100		2009-2014	F		
				Wolf 150 Classic		2011-2014	R		
				TGB/PEIRSPPEED					
				Delivery 151		2004-2011	R		
				Laser R9/I		2008-2011	R		
				Sunset 151		2006-2008	R		
802G	HUSQVARNA								
	430 Automatic	1987-1988	R						
	AE 500	1982-1984	R						
	CR 240	1980-1981	F						
	CR 240	1987-1988	R						
	CR 250	1980-1981	F						
	CR 250	1987-1988	R						
	CR 430	1980-1981	F						
	CR 430	1987-1988	R						
	CR 500	1987-1988	R						
	WR 125	1980-1981	F & R						
	WR 125	1982-1984	R						
	WR 125	1987-1988	R						
	WR 240	1980-1981	F & R						
	WR 240	1982-1984	R						
WR 240	1987-1988	R							
WR 250	1980-1981	F & R							
WR 250	1982-1984	R							
WR 250	1987-1988	R							
WR 400	1987-1988	R							
WR 430	1980-1981	F & R							
WR 430	1987-1988	R							
WR-E 430	1980-1981	F & R							
WR-E 430	1982-1984	R							
WRU 430	1982-1984	R							
XC 125	1982-1984	R							
XC 250	1980-1981	F & R							
XC 250	1982-1984	R							
XC 250	1987-1988	R							
XC 430	1980-1981	F & R							
XC 430	1987-1988	R							
XC 500	1982-1984	R							
XC 500	1987-1988	R							
803G	HUSQVARNA								
	AE 500	1982-1984	F						
	CR 125	1982-1984	F						
	CR 240	1982-1984	F						
	CR 250	1982-1984	F						
	CR 500	1982-1984	F						
	WR 125	1982-1984	F						
	WR 240	1982-1984	F						
	WR 250	1982-1984	F						
	WR-E 430	1982-1984	F						
	WRU 430	1982-1984	F						
	XC 125	1982-1984	F						
	XC 250	1982-1984	F						
XC 500	1982-1984	F							
812G	KTM								
	MX 125	1983	R						

BRAKE SHOE BUYERS GUIDE

Part No.	Make/Model	Year	F/R	Part No.	Make/Model	Year	F/R
821G	MAICO/M-STAR All Models	1984-1985	F	863	BMW K 75 75-S	1984-1988	R
822G	MAICO/M-STAR All Front Rotor Models	1984-1985	R	864	BMW R 50/5/60/5/60/6/75/5	1969-1976	F
841G	BETA 125 TR 32/33 240 TR 33 CAGIVA WMX 125/250 MAICO/M-STAR All Rotor Models	86-87	R	873	KTM SX 60 SX 65	1998-2000	R
		86-88	R			1998-1999	R
853	TRIUMPH MERIDEN PRODUCED MACHINES T 120 650cc/Twin Leading Shoe T 150 Trident 3 cycl	-85	R	893	APRILIA Rally 50 Scarabeo 50 Street MALAGUTI Ciak 50 F10 Jet Line F15 Firefox Yesterday 50 PIAGGIO Typhoon 50 Typhoon 50	2004-2005	R
		86	F & R			1999-2005	R
854	TRIUMPH MERIDEN PRODUCED MACHINES T 120 650cc/Twin Leading Shoe T 150 Trident 3 cycl	66-70 69-72	F F	897	TGB/PEIRSPEED 101S 50 Key West Delivery 50 Delivery 50 Laser R5/l Sunset 50	2002-2004	R
858	TRIUMPH MERIDEN PRODUCED MACHINES Cub 500	66-70 69-72	R R			2002-2004	R
859	BMW R 100 GS R 100 Mystic R 100 PD R 100 R R 100 RS R 100 RT R 80 GS R 80 Mystic R 80 PD/CH R 80 R R 80 RT R 850 GS	1968	F & R	899	PIAGGIO Typhoon 50/SE VESPA ET 250 ET4 150 LX 150 ie LX 50 LXV 150 ie S150 ie S50 PX 150 All models	2007-2009	R
860	BMW R 100 GS R 100 Mystic R 100 PD R 100 R R 100 RS R 100 RT R 80 GS R 80 Mystic R 80 PD/CH R 80 R R 80 RT R 850 GS	1986-1994	R			2006	R
		1993-1996	R	903	VESPA PX 150 (All models)	2005-2011	R
861	BMW K 75 75-2 K 75 C R 100 7T R 100 RS R 100 RT R 45 R 50/5/60/5/60/6/75/5 R 60 TIC R 60 TIC R 60/7 R 60/7 R 75/6 75/7 R 75/6 75/7 R 80 R 80 TIC R 90 S R 90/6	1989-1996	R			2004-2005	R
		1991-1995	R	2006-2011	R		
862	BMW R 65 LS	1991-1995	R	2008-2011	R		
		1996	R	2008-2011	R		
863	BMW R 100 GS R 100 Mystic R 100 PD R 100 R R 100 RS R 100 RT R 80 GS R 80 Mystic R 80 PD/CH R 80 R R 80 RT R 850 GS	1976-1977	R	921	DUCATI 250/350/450 Desmo/Single	2006-2008	R
		1977-1980	R			2005-2006	R
864	BMW R 100 GS R 100 Mystic R 100 PD R 100 R R 100 RS R 100 RT R 80 GS R 80 Mystic R 80 PD/CH R 80 R R 80 RT R 850 GS	1976-1980	R	928	DUCATI 250/350/450 Desmo/Single	1974-1977	R
		1976-1980	R			1976	F
865	BMW R 100 GS R 100 Mystic R 100 PD R 100 R R 100 RS R 100 RT R 80 GS R 80 Mystic R 80 PD/CH R 80 R R 80 RT R 850 GS	1978-1980	R	929	DUCATI 250/350/450 Desmo/Single	1976	F
		1978-1982	R			1976	R
866	BMW R 100 GS R 100 Mystic R 100 PD R 100 R R 100 RS R 100 RT R 80 GS R 80 Mystic R 80 PD/CH R 80 R R 80 RT R 850 GS	1978-1982	R	944G	CAGIVA WMX 125	1985	F
		1976-1980	R			950	CZ/JAWA Jawa Cross 250/400 Scrambler Cross 125-380
867	BMW R 100 GS R 100 Mystic R 100 PD R 100 R R 100 RS R 100 RT R 80 GS R 80 Mystic R 80 PD/CH R 80 R R 80 RT R 850 GS	1976-1980	R	978	MZ/MUZ Country 500		
		1976-1980	R			1993-1998	R
868	BMW R 100 GS R 100 Mystic R 100 PD R 100 R R 100 RS R 100 RT R 80 GS R 80 Mystic R 80 PD/CH R 80 R R 80 RT R 850 GS	1976-1980	R	982G	CAGIVA WMX 500	84-86	R
		1976-1980	R			984	HUSQVARNA Husky Boy Husky Boy J Husky Boy R Husky Boy S
869	BMW R 100 GS R 100 Mystic R 100 PD R 100 R R 100 RS R 100 RT R 80 GS R 80 Mystic R 80 PD/CH R 80 R R 80 RT R 850 GS	1976-1980	R	984	HUSQVARNA Husky Boy Husky Boy J Husky Boy R Husky Boy S		
		1976-1980	R			2001	R
870	BMW R 100 GS R 100 Mystic R 100 PD R 100 R R 100 RS R 100 RT R 80 GS R 80 Mystic R 80 PD/CH R 80 R R 80 RT R 850 GS	1976-1980	R	984	HUSQVARNA Husky Boy Husky Boy J Husky Boy R Husky Boy S	2001-2002	R
		1976-1980	R			2001-2002	R
871	BMW R 100 GS R 100 Mystic R 100 PD R 100 R R 100 RS R 100 RT R 80 GS R 80 Mystic R 80 PD/CH R 80 R R 80 RT R 850 GS	1976-1980	R	984	HUSQVARNA Husky Boy Husky Boy J Husky Boy R Husky Boy S	2001-2002	R
		1976-1980	R			2001-2002	R
872	BMW R 100 GS R 100 Mystic R 100 PD R 100 R R 100 RS R 100 RT R 80 GS R 80 Mystic R 80 PD/CH R 80 R R 80 RT R 850 GS	1976-1980	R	984	HUSQVARNA Husky Boy Husky Boy J Husky Boy R Husky Boy S	2001-2002	R
		1976-1980	R			2001-2002	R

BRAKE SHOE ILLUSTRATIONS

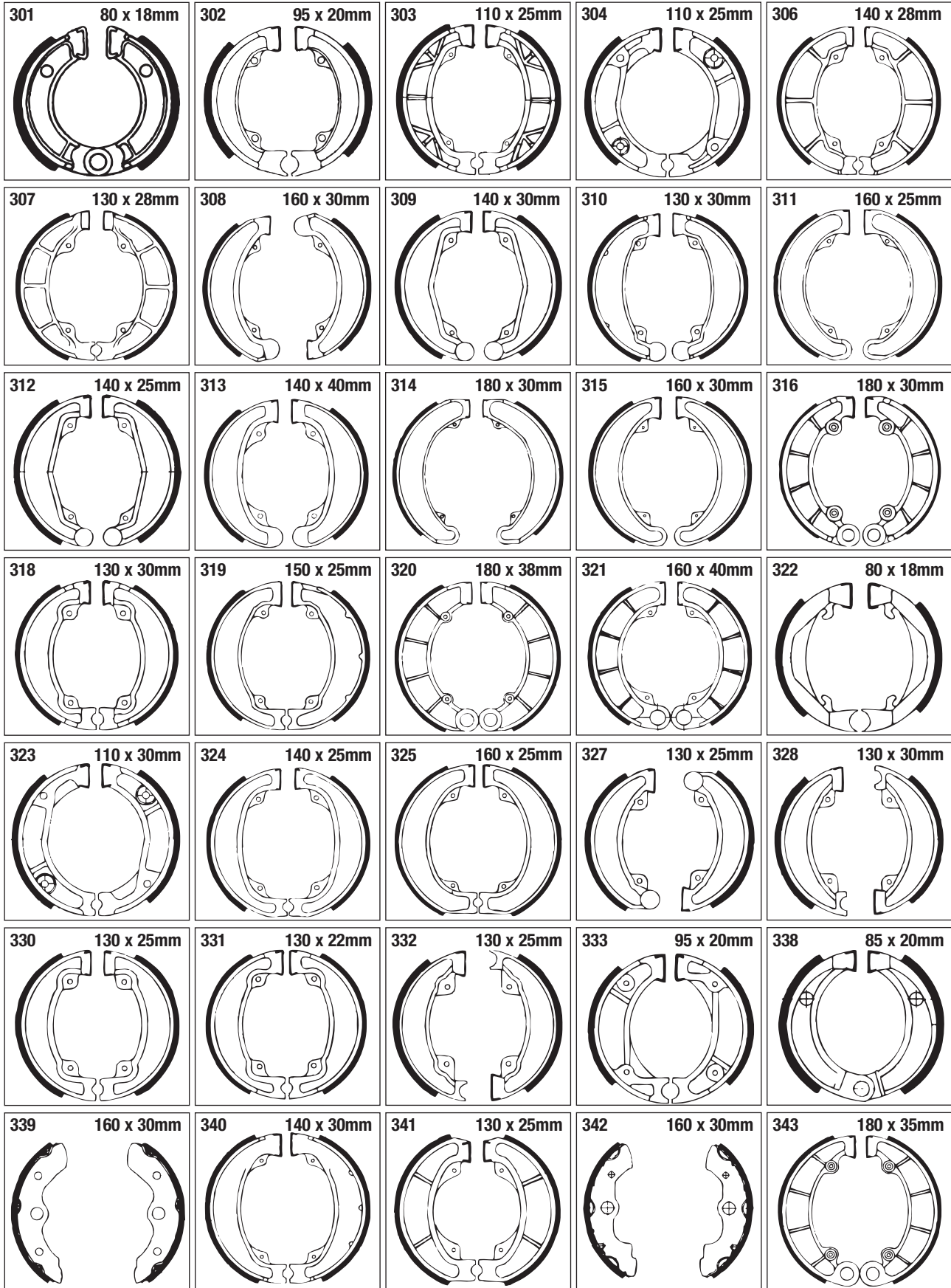

BRAKE SHOE ILLUSTRATIONS

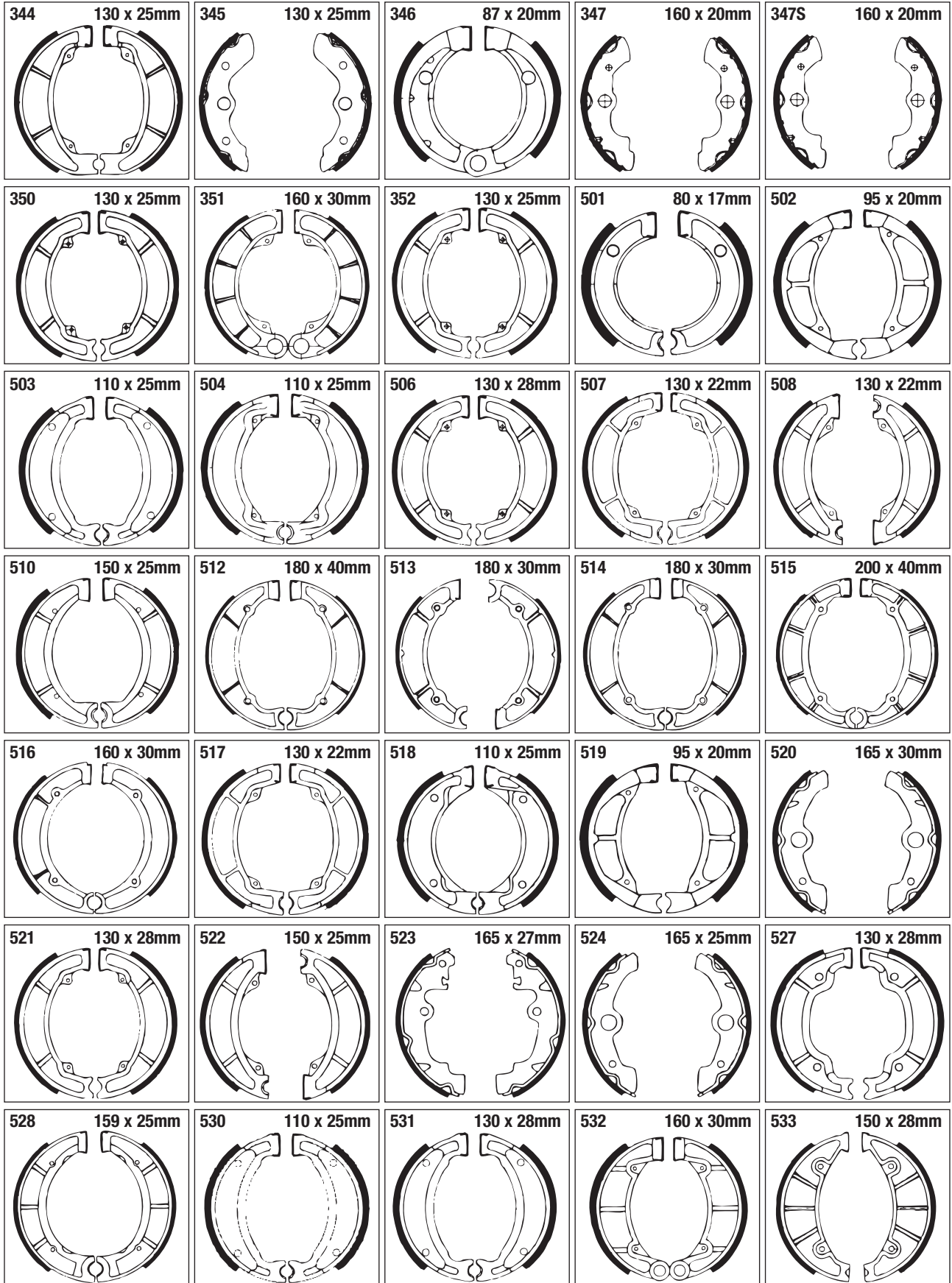

BRAKE SHOE ILLUSTRATIONS

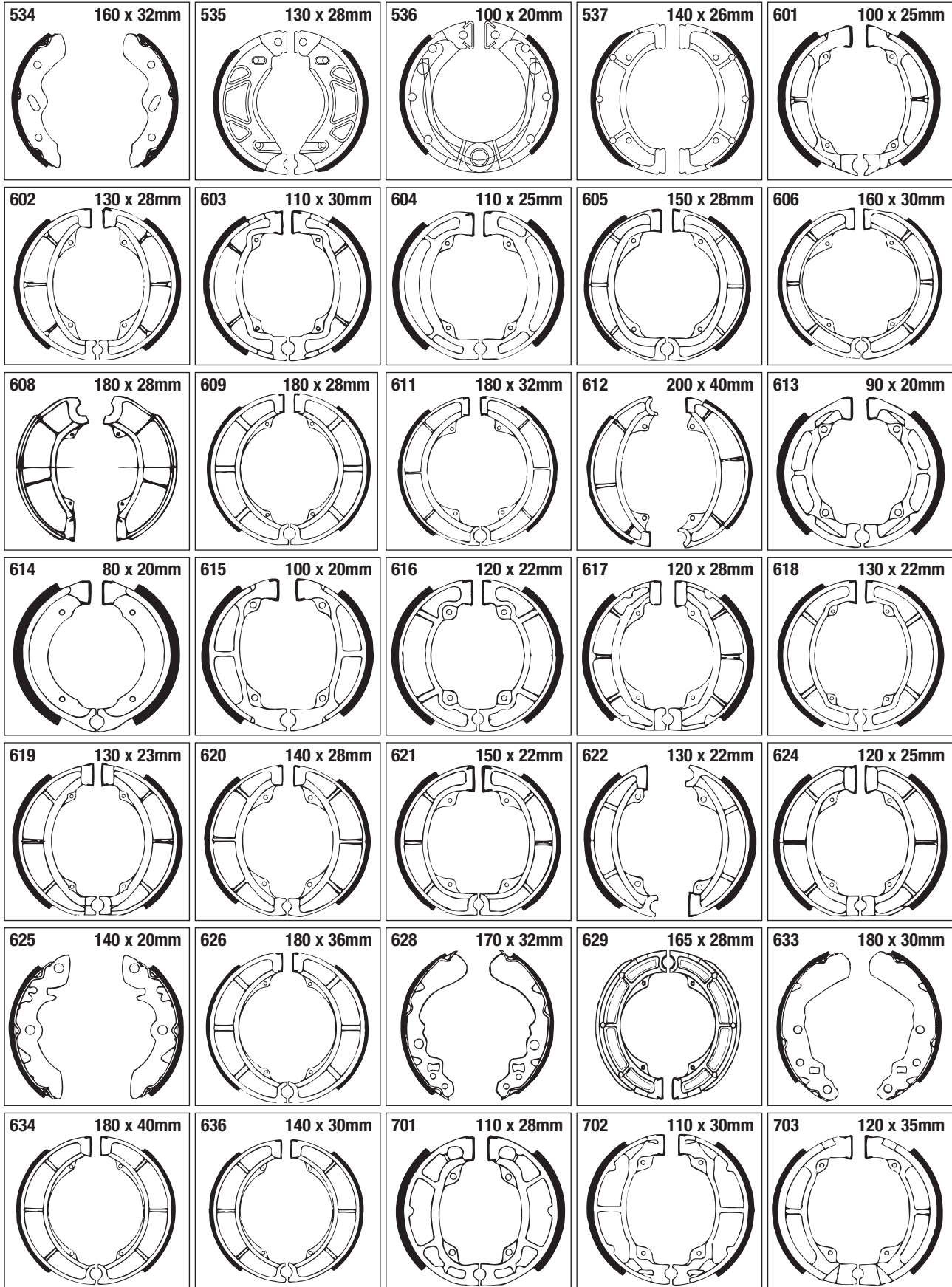

BRAKE SHOE ILLUSTRATIONS

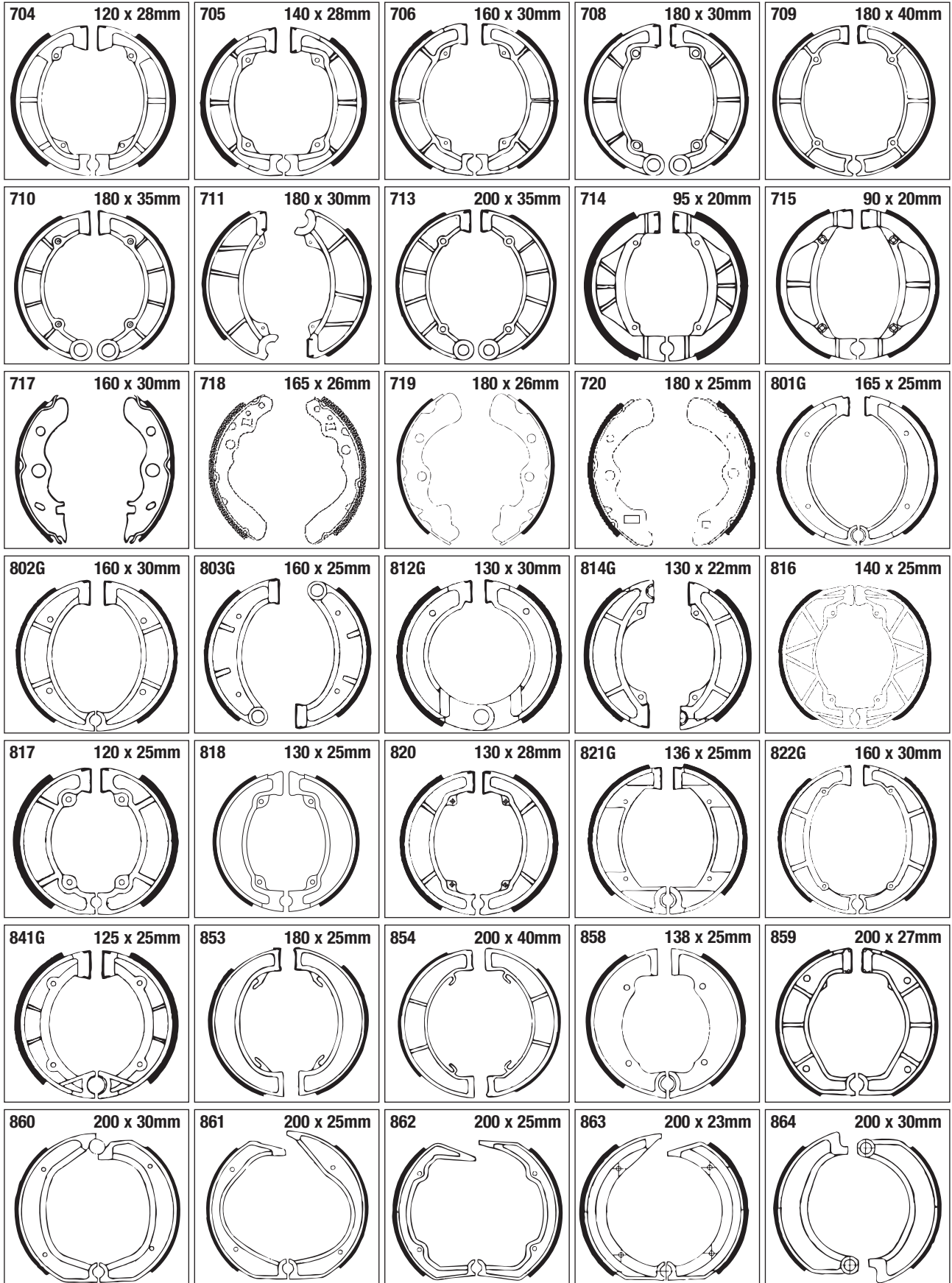

BRAKE SHOE ILLUSTRATIONS

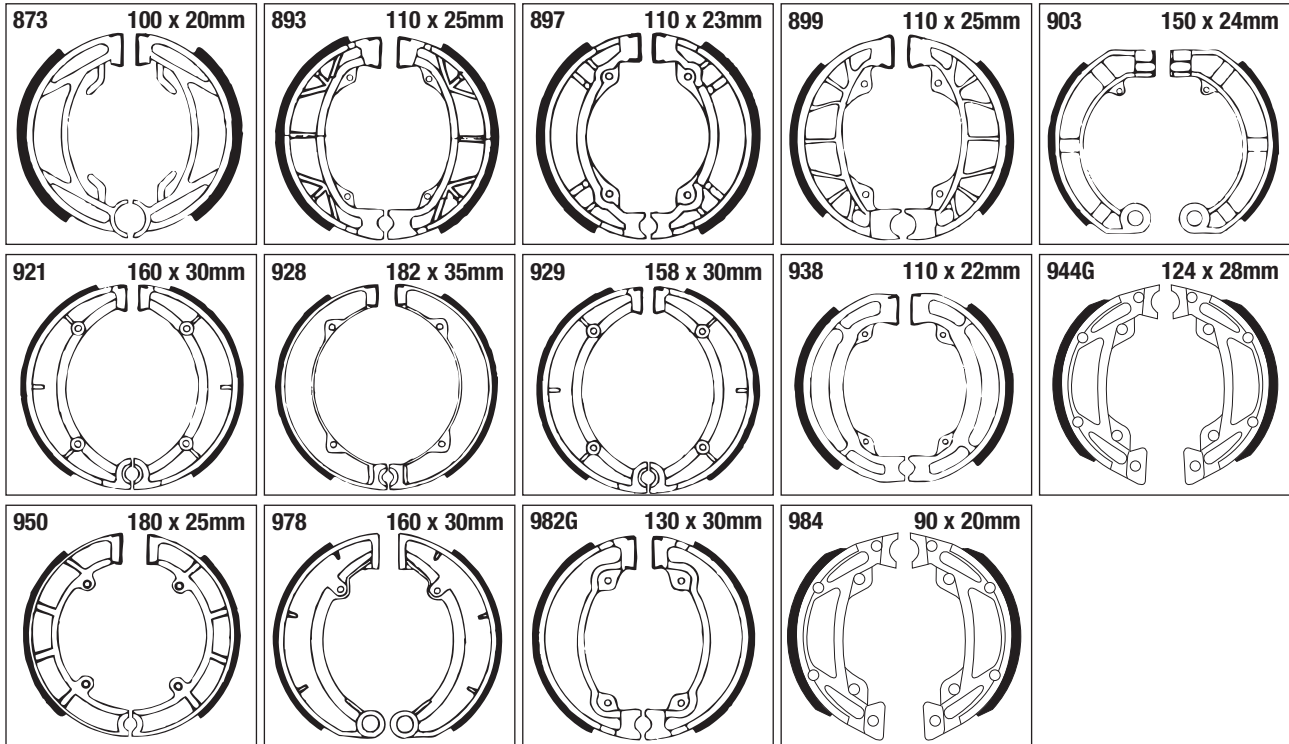

BUYERS GUIDE
BRAKE SHOES

BRAKE SHOE DIAMETER CHART
(in mm)

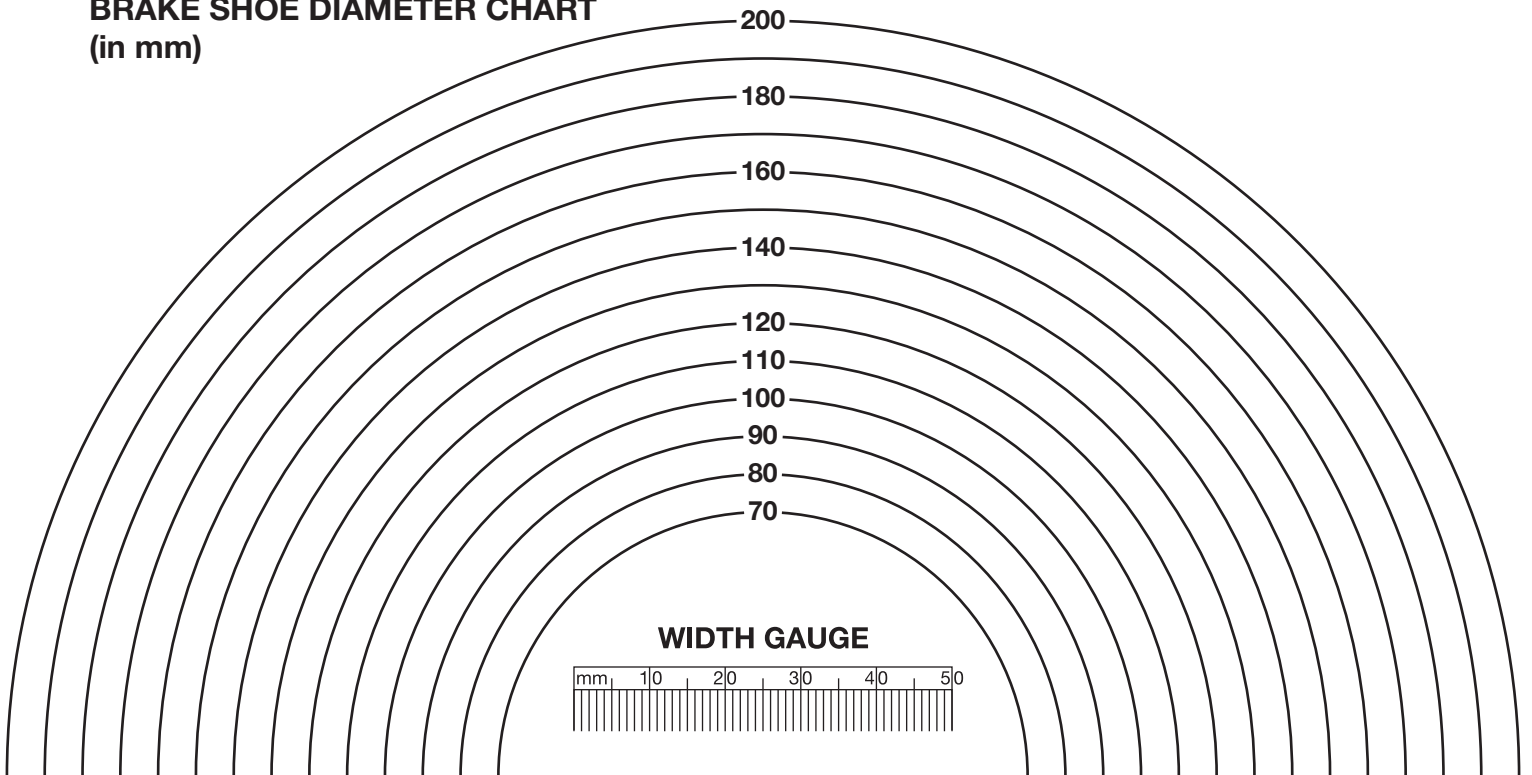

BRAKE ROTOR BUYERS GUIDE - STREET

Rotor No.	F/R	Type	Dia. (mm)	Hub Color	Profile	Bobbins	Left Bracket	Right Bracket	Model	Year
Disc Group 001 MD523 FSD523 FSD008 FSD010 FSD010BLK FSD012C FSD012CBLK FSD023 FSD023BLK FSD027C FSD027CBLK VR010BLK VR023BLK OSMD004-14BLK OSMD004-15BLK	F F F F F F F F F F F F F F F F F	Solid Floating Solid Floating Floating Floating Floating Floating Floating Floating Floating Floating Floating Floating Floating Floating Floating	290 290 290 290 290 290 290 290 290 290 290 290 290 290 355 381	N/A Polished N/A Polished Black Polished Black Polished Black Polished Black Black Black Black Black Black	Plain Plain Plain Plain Plain Contour Contour Plain Plain Contour Contour Vee Vee Plain Plain	N/A 5 N/A 5 5 5 10 10 10 10 10 5 5			HARLEY DAVIDSON® All models, 00 onwards check main catalogue for model fitments.	
Disc Group 002 FSD007 FSD009 FSD009BLK FSD011C FSD011CBLK FSD022 FSD022BLK FSD026C FSD026CBLK VR011BLK	F F F F F F F F F F	Solid Floating Floating Floating Floating Floating Floating Floating Floating Floating	290 290 290 290 290 290 290 290 290 290	N/A Chrome Black Chrome Black Chrome Black Chrome Black Black	Plain Plain Plain Contour Contour Plain Plain Contour Contour Vee	N/A 5 5 5 5 10 10 10 10 10 5			HARLEY DAVIDSON® Sportsters & Big Twins with speedo notch. See main catalogue listing for full fitment info. 11 1/2" F Floating Disc Conversion.	
Disc Group 003 MD528 RSD008 RSD017CBLK RSD018C RSD018CBLK RSD019 RSD019BLK RSD020 RSD020BLK VR020BLK	R R R R R R R R R R	Floating Solid Floating Floating Floating Floating Floating Floating Floating Floating	290 290 290 290 290 290 290 290 290 290	Polished N/A Black Chrome Black Chrome Black Chrome Black Black	Plain Plain Contour Contour Contour Plain Plain Plain Plain Vee	10 N/A 10 10 10 10 10 10 10 10			HARLEY DAVIDSON® All models, 00 onwards Check main catalogue for model fitments	
Disc Group 004 Billet RSD007 RSD019 RSD019C VR019BLK RSD019BLK RSD007A	R R R R R R	Solid Floating Floating Floating Floating Solid	290 290 290 290 290 290	N/A Chrome Chrome Black Black N/A	Plain Plain Contour Vee Plain Plain	N/A 10 10 10 10 N/A			HARLEY DAVIDSON® 11 1/2" F Floating Disc Conversion. Sportsters & Big Twins with speedo notch See main catalogue listing for full fitment info. INDIAN Chief/Deluxe/Springfield/Road Master/Vintage/Scout/Spirit	02-08
MD509SR Billet Steel ⚙	R	Solid	290	N/A	Plain	N/A			HARLEY DAVIDSON® FLT, FLHT, FLHTCI FLHR, FLHRCI	86-99 94-99
MD511	R	Solid	240	N/A	Plain	N/A			BUELL All Model	94-02
Disc Group 006 MD514LS/RS VR514	F F	Solid Solid	292 292	N/A N/A	Plain Vee	N/A N/A			HARLEY DAVIDSON® V-Rod	06-07 08-10
MD515	R	Solid	292	N/A	Plain	N/A			HARLEY DAVIDSON® VRSCA V-Rod	02-05
Disc Group 007 MD516 MD516X OSMD516-14BLK OSMD516-15BLK	F F F F	Solid Floating Floating Floating	300 300 355 381	N/A Chrome Black Black	Plain Plain Plain Plain	N/A 5 5 5			HARLEY DAVIDSON® V-Rod Models	06-17

BRAKE ROTOR BUYERS GUIDE - STREET

Rotor No.	F/R	Type	Dia. (mm)	Hub Color	Profile	Bobbins	Left Bracket	Right Bracket	Model	Year
Disc Group 008 MD517 MD525	R R	Solid Floating	300 300	N/A Polished	Plain Plain	N/A 9			HARLEY DAVIDSON® V-Rod Models	06-17
Disc Group 009 MD542 MD521 MD521BLK VR521BLK	R R R R	Solid Floating Floating Floating	300 300 300 300	N/A Polished Black Black	Plain Plain Plain Vee	N/A 10 10 10			HARLEY DAVIDSON® Touring Models 2008 onwards. See main catalogue listings for full fitment info.	
Disc Group 010 MD518 MD518BLK MD518CBLK MD520 MD520/10BLK VR520BLK MD526 MD526X MD530 MD530BLK MD541 OSMD518-14 OSMD518-14BLK	F F F F F F F F F F F F F	Floating Floating Floating Floating Solid Solid Floating Floating Floating Floating Solid Floating Floating	300 300 300 300 300 300 300 300 300 300 300 355 355	Polished Black Black Polished Black N/A Polished Polished Black N/A Polished Black	Plain Plain Contour Plain Vee Plain Plain Plain Plain Plain Plain Plain	10 10 10 5 N/A N/A 5 5 5 5 N/A 5 5			HARLEY DAVIDSON® Sportster, Dyna, Softail, Touring, Trike and V-Rod 2006 onwards. See main catalogue listings for full fitment info.	
MD522	R	Solid	240	N/A	Plain	N/A			BUELL XB12R Firebolt XB12 SS Lightning Firebolt XB9R XB9S Lightning XB12S Lightning XB9SX Lightning City/X XB12X Ulysses XB12XT Ulysses XB12SCG Lightning XB12SS Lightning Long XB12STT Lightning XB12STT Lightning XB12SCG Lightning XB9 SX Lightning	04-10 09-10 02-07 03-04 04-08 05-09 06-10 08-10 06-08 06-08 06-08 08 09-10 08-10
Disc Group 011 MD524 RSD524	R R	Solid Floating	260 260	N/A Polished	Plain Plain	N/A 10			HARLEY DAVIDSON® Sportster Range 2007 onwards. See main catalogue listings for full fitment info.	
Disc Group 017 MD529 VR529	F F	Solid Solid	300 300	N/A N/A	Plain Vee	N/A N/A			HARLEY DAVIDSON® Touring Models 2014 onwards.	
MD531	F	Solid	292	N/A	Plain	N/A			HARLEY DAVIDSON® XG 500 Street XG 750 Street	14-15 14-15
MD532	R	Solid	260	N/A	Plain	N/A			HARLEY DAVIDSON® XG 500 Street XG 750 Street	14-15 14-15
Disc Group 019 MD533 MD533BSDF	F & R F	Solid Solid	299 299	Black Black	Plain Plain	N/A N/A			POLARIS Slingshot Slingshot S Slingshot SL Slingshot SL SE POLARIS Slingshot Slingshot S Slingshot SL Slingshot SL SE	15-17 18 15-18 15-18 15-17 18 15-18 15-18

BRAKE ROTOR BUYERS GUIDE - STREET

Rotor No.	F/R	Type	Dia. (mm)	Hub Color	Profile	Bobbins	Left Bracket	Right Bracket	Model	Year
Disc Group 019 Contd. MD533BSDR	R	Solid	299	Black	Plain	N/A			POLARIS Slingshot Slingshot S Slingshot SL Slingshot SL SE	15-17 18 15-18 15-18
Disc Group 020 MD534 MD534X MD534XBLK	F & R F & R F & R	Solid Floating Floating	298 298 298	N/A Gold Black	Plain Plain Vee	N/A 5 10			INDIAN Scout Cast Wheel/Toso Calipers Scout Sixty Cast Wheel/Toso Calipers Scout Scout Bobber Scout Sixty VICTORY Octane 1200cc	15-16 16 17-21 18-21 17-21 17
Disc Group 021 MD535 MD535BLK	F & R F & R	Floating Floating	292 292	Polished Black	Plain Plain	5 5			INDIAN Chief Blackhawk Brembo calipers Chief Blackhawk Dark Brembo calipers Chief Classic Brembo calipers Chief Standard Brembo calipers Chief Deluxe Brembo calipers Chief Roadmaster Brembo calipers Chief Vintage Brembo calipers Bomber Brembo Calipers Dark Horse Brembo calipers	11 11 11-13 09-11 9 09-11 Sep-13 10-11 10-13
Disc Group 022 MD536 MD536X MD536XBLK	F F F	Solid Floating Floating	300 300 300	N/A Polished Black	Plain Plain Plain	N/A 5 5			HARLEY DAVIDSON® XG 500 Street 300mm Discs XG 750 Street 300mm Discs XG 750 Street Rod	16-21 16-21 17-21
MD537	R	Solid	300	N/A	Plain	N/A			HARLEY DAVIDSON® XG 500 Street XG 750 Street	16-20 16-20
MD538	R	Solid	270.5	N/A	N/A	N/A			HARLEY DAVIDSON® FLRT Freewheeler Trike FLHTCUTG Tri Glide Ultra Trike	15-20 14-20
MD540	R	Solid	233	N/A	N/A	N/A			HARLEY DAVIDSON® FLHTCUTGSE CVO Tri Glide FLHXXX Street Glide Trike	09-13 10-11
Disc Group 024 MD678 MD678BLK VR678BLK	F F F	Floating Floating Floating	300 300 300	Natural Black Black	Plain Plain Vee	9 9 9			VICTORY Cory Ness Victory Cross Country Cross Roads Arlen Ness Victory Vision Cory Ness Jackpot Victory Vegas/ Victory King Pin King Pin King Pin Tour King Pin - 8 Ball King Pin Low Vegas Vegas - 8 Ball Ness Signature Series Vegas Jackpot Hammer Hammer 8 Ball Hammer S Jackpot Zach Ness Vegas Vegas Low Vision 8 Ball Vision Street Vision Tour Hard Ball Spoke Wheel Judge	11-12 10-13 10-12 08-10 03-07 04-12 04-09 08-11 9 03-12 05-12 05-07 06-09 05-11 10-16 07-16 10-16 11-12 08-09 10-11 08-09 08-14 12-13 12-16

BRAKE ROTOR BUYERS GUIDE - STREET

Rotor No.	F/R	Type	Dia. (mm)	Hub Color	Profile	Bobbins	Left Bracket	Right Bracket	Model	Year
Disc Group 025 MD887BLK VR887BLK	R R	Floating Floating	299 299	Black Black	Plain Vee	9 9			INDIAN Chief Dark Horse Nissin calipers Chief Vintage Nissin calipers Chieftain Nissin Calipers/Cast Wheels Chieftain Dark Horse Nissin Calipers/Cast Wheels Chieftain Limited Nissin Calipers/Cast Wheels Chieftain Elite Nissin Calipers/Cast Wheels Roadmaster Nissin Calipers/Cast Wheels Roadmaster Dark Horse Nissin Calipers/Cast Wheels Roadmaster Limited Nissin Calipers/Cast Wheels Roadmaster Dark Horse Jack Daniel's Edition Nissin Calipers/Cast Wheels Roadmaster Elite Nissin Calipers/Cast Wheels Springfield Springfield Dark Horse	16-21 14-21 14-21 14-21 14-21 14-21 15-21 15-21 15-21 21 15-21 16-21 19-21
Disc Group 026 MD727 VR727BLK	F & R F & R	Floating Floating	300 300	Gold Black	Plain Vee	9 9			VICTORY V92/SC	98-03
Disc Group 027 MD801 VR801	F F	Solid Solid	260 260	N/A N/A	Plain Vee	N/A N/A			CAN-AM Spyder RS SES/SMS 990cc Spyder RS Phantom Black Spyder RT-S/RT Spyder RS-S/RS Spyder RT Ltd	08-09 9 10-12 10-12 11-12
Disc Group 028 MD802 VR802	R R	Solid Solid	260 260	N/A N/A	Plain Vee	N/A N/A			CAN-AM Spyder RS SES/SMS 990cc Spyder RS Phantom Black Spyder RT-S/RT Spyder RS-S/RS Spyder RT Ltd	08-09 09 10-12 10-12 11-12
Disc Group 029 MD853 VR853	F F	Solid Solid	270 270	N/A N/A	Plain Vee	N/A N/A			CAN AM Spyder F3 Spyder F3 LTD Spyder F3-S SE6/SM6 Spyder F3-S Special Series Spyder F3-S Daytona 500 Spyder F3-T Spyder RT 3 Cyl Eng/6 Speed Spyder RT-S 3 Cyl Eng/6 Speed Spyder RT-S Special Series Spyder RT Ltd 3 Cyl Eng/6 Speed Spyder ST Brembo Calipers Spyder ST-S Brembo Calipers Spyder ST LTD Brembo Calipers Spyder RS Brembo Calipers Spyder RS-S Brembo Calipers	15-22 16-22 15-22 16-21 17 16-21 13-21 13-15 16-17 13-21 13-16 13-16 13-15 13-16 13-16
Disc Group 030 MD854 VR854 Disc Group 029 MD853 VR853 Contd.	R R	Solid Solid	270 270	N/A N/A	Plain Vee	N/A N/A			CAN AM Spyder F3 Spyder F3 LTD Spyder F3-S SE6/SM6 Spyder F3-S Special Series Spyder F3-S Daytona 500 Spyder F3-T Spyder RT 3 Cyl Eng/ 6 Speed Spyder RT-S 3 Cyl Eng/ 6 Speed Spyder RT Ltd 3 Cyl Eng/ 6 Speed Spyder ST Brembo Calipers Spyder ST-S Brembo Calipers Spyder ST LTD Brembo Calipers Spyder RS Brembo Calipers Spyder RS-S Brembo Calipers	15-22 16-22 15-22 16-21 17 16-21 13-21 13-15 16-17 13-21 13-16 13-16 13-15 13-16 13-16
Disc Group 031 MD737 VR737	F F	Solid Solid	320 320	N/A N/A	Plain Vee	N/A N/A			BUELL Blast	00-07

BUYERS GUIDE
BRAKE ROTORS

BRAKE ROTOR BUYERS GUIDE - STREET

Rotor No.	F/R	Type	Dia. (mm)	Hub Color	Profile	Bobbins	Left Bracket	Right Bracket	Model	Year
Disc Group 032 MD738 VR738	F F	Solid Solid	220 220	N/A N/A	Plain Vee	N/A N/A			BUELL Blast	00-07
MD601LS MD601RS	F F	Floating Floating	310 310	Silver Silver	Plain Plain	9 9			HONDA CBR 600 F2 TRIUMPH Floating conversion for Triumph models using MD649 solid disc.	91-94
MD602LS MD602RS	F F	Floating Floating	260 260	Silver Silver	Plain Plain	9 9			BMW R 60/7 R 60 TIC R 65 LS R 75/6 R 80 R 80 RT	76-80 78-82 81-85 73-79 77-84 82-84
MD602LS MD602RS	F & R F & R	Floating Floating	260 260	Silver Silver	Plain Plain	9 9			BMW R 80 TIC R 90 S R 90/6 R 100 R 100/7T R 100 S R 100 RS R 100 RT R 100 S R 100 RS R 100 RT	78-85 73-76 73-76 76-77 77-84 76-80 76-84 78-84 09/80-80 10/80-84 10/80-84
MD603LS MD603RS (ABS)	F F	Floating Floating	285 285	Silver Silver	Plain Plain	9 9			BMW K 75/75-2 K 75 RT K 75 S K 100/2 K 100 LT K 100 RS K 100 RT	84-96 89-96 85-95 87-90 86-91 83-89 83-89
MD604LS MD604RS (Non ABS)	F F	Floating Floating	285 285	Silver Silver	Plain Plain	9 9			BMW K 75/75-2 K 75 C K 75 RT K 75 S K 100 K 100/2 K 100 LT K 100 RS K 100 RT	84-96 85-12/88 89-96 85-95 82-09/88 87-90 86-91 83-89 83-89
MD605LS MD605RS	F F	Floating Floating	285 285	Silver Silver	Plain Plain	9 9			BMW R 65 R 65 RT R 80/R 80 RT R 100 RS R 100 RT R 80 Mystic R 80 R R 100 GS R 100 PD R 100 Mystic R 100 R R 850 GS	07/88-08/89 85-88 84-95 86-92 87-95 94-95 91-94 86-94 89-96 93-96 91-95 96
MD606LS MD606RS	F F	Floating Floating	260 260	Silver Silver	Plain Plain	9 9			BMW R 45/45N/45T R 65 GS/T/LS R 80 GS/PD/CH R 80 ST R 100/7T	78-85 80-92 80-95 82-84 09/80-84

BUYERS GUIDE
BRAKE ROTORS

BRAKE ROTOR BUYERS GUIDE - STREET

Rotor No.	F/R	Type	Dia. (mm)	Hub Color	Profile	Bobbins	Left Bracket	Right Bracket	Model	Year
MD607LS MD607RS	F F	Floating Floating	305 305	Silver Silver	Plain Plain	12 12			BMW K 100 RS K1 K 1100 LT K 1100 RS R 850 R R 850 RT R 1100 R R 1100 RS R 1100 RT	89-92 88-93 89-99 92-96 94-02 96-01 93-01 92-01 94-01
MD609LS MD609RS	F F	Floating Floating	280 280	Gold Gold	Plain Plain	9 9			DUCATI 900 SS Darmah 900 Hailwood Replica 1000 R1 Hailwood Replica	78 79 84
MD609LS	R	Floating	280	Gold	Plain	9			LAVERDA Jota 1000 Mirage 1200 900 Hailwood Replica 1000 R1 Hailwood Replica 1000 SFC	76 76 79 84 85-86
MD609ALS MD609ARS	F F	Floating Floating	280 280	Gold Gold	Plain Plain	9 9			LAVERDA RGS 1000	83
MD611 Non ABS Models	R R	Floating Floating	285 285	Silver Silver	Plain Plain	9 9			BMW K 75/75-2 K 75 RT K 75 S K 100 K 100/2 K 100 LT K 100 RS K 100 RT BMW K 100 RS Non ABS K1 16 valve - Non ABS	08/90-96 89-96 85-95 82-09/88 87-90 86-91 83-89 83-09/88 89-92 88-93
MD613 MD613C VR613	R R R	Solid Solid Solid	220 220 220	N/A N/A N/A	Plain Contour Vee	N/A N/A N/A			APRILIA Shiver 900 Dorsoduro 900 RSV4 R/RSV4 Factory RSV4 Factory APRC SBK RSV4 R APRC RSV4 Factory APRC ABS RSV Mille All models RSV 1000 Tuono/Tuono R/Factory R SL 1000 Falco RSV 1000 R Factory/R Tuono V4 R STD Tuono V4R APRC Tuono V4R APRC/ABS	18-22 18-22 09-12 11-14 11-14 13-15 98-03 02-10 00-05 04-12 11-12 11-12 13-15
MD614X MD614XC VR614BLK VR614BLU VR614RED VR614GLD VR614ORG	F F F F F F F	Floating Floating Floating Floating Floating Floating Floating	320 320 320 320 320 320 320	Gold Gold Black Blue Red Gold Orange	Plain Contour Vee Vee Vee Vee Vee	6 6 6 6 6 6 6			CAGIVA Mito 125 DUCATI Monster 400 Single disc Monster 400 Twin disc 400 Monster Japan Monster Dark ie 400 Japan Monster Dark ie 400 Single disc 600 Monster City/City Dark 600 Monster 620 IE Monster 620 ie Monster Series 1 - Twin Pin Pad Fixing Caliper 620 Sport 696 Monster M 696 Monster 20th Anniversary Model 748 Biposto	92-02 00-02 03-Apr 00-04 05-06 05 99 00-01 02-04 05 03 08-14 13-14 99-02

BUYERS GUIDE
BRAKE ROTORS

BRAKE ROTOR BUYERS GUIDE - STREET

Rotor No.	F/R	Type	Dia. (mm)	Hub Color	Profile	Bobbins	Left Bracket	Right Bracket	Model	Year
MD614X	F	Floating	320	Gold	Plain	6			748 SP/Monoposto	99-02
MD614XC	F	Floating	320	Gold	Contour	6			748 Testa Bassa Mono/Biposto	01
VR614BLK	F	Floating	320	Black	Vee	6			750 Supersport IE	00-02
VR614BLU	F	Floating	320	Blue	Vee	6			750 Sport	01-02
VR614RED	F	Floating	320	Red	Vee	6			750 Monster	00-01
VR614GLD	F	Floating	320	Gold	Vee	6			Monster ie 750	02
VR614ORG	F	Floating	320	Orange	Vee	6			Monster 800	03-04
Contd.									800 Sport	03
									800 Supersport	03-05
									900 Supersport IE	00-01
									900 Sport	02
									900 IE Monster	00-01
									900 MH Evoluzione	00-01
									ST4 916cc	01-02
									ST2 944cc	00-03
									GT 1000 992cc	07-10
									GT 1000 Touring - Sport Classic	09
									Monster 1000 Dark	03
									Monster 1000 ie 992cc	04-05
									Monster 1000 S ie 992cc	03-05
									Monster S2R 1000 992cc	06-08
									Paul Smart 1000 LE 992cc	06
									Sport 1000 S	07-09
									Sport Classic 1000 992cc Monoposto - Japan/Biposto - Europe	06-08
									Supersport 1000 DS 992cc	03-06
									KTM	
									690 Duke	08-11
									MOTO GUZZI	
									750 Nevada Base/Club	02-03
									Nevada Classic 750 ie	04-09
									V 750 ie Breva	03-08
									V 7 Classic	08-12
									V 7 Cafe Classic	11-12
									V 7 Racer	10-14
									V 7 Special	12-14
									V 7 Stone	02-14
									V10 Centauro	97-99
									California EVII	97-01
									Sport 1100	94-99
									California Jackel 1100	99-01
									California Special 1100	99-01
									V11 Sport/Scura/Naked	99-00
									V11 Le-Mans Series	01-06
									California Stone Series	02-06
									California EV Series	02-06
									California Vintage 750	06-10
MD615	R	Floating	285	Natural	Plain	9			BMW	
									K 1200 LT	97-09
									R 1200 CL	02-04
MD616 Loose bobbin type	F	Solid	320	N/A	Plain	N/A			BMW	
									R 850 R	03-06
									R 1100 S	12/00-06
									R 1150 R	01-06
									R 1150 Rockster	03-06
									R 1150 RS	01-05
									R 1150 GS	03-06
									K 1200 R-Urban K43	05-08
									K 1200 LT	11/00-07
									R 1200 R	07-08
									K 1300 R	09
MD617	R	Solid	220	N/A	Plain	N/A			CAGIVA	
									Raptor 650/V-Raptor 650	00-02
									Raptor 1000/V-Raptor 1000	00-02

BRAKE ROTOR BUYERS GUIDE - STREET

Rotor No.	F/R	Type	Dia. (mm)	Hub Color	Profile	Bobbins	Left Bracket	Right Bracket	Model	Year
MD618	R	Solid	240	N/A	Plain	N/A			DUCATI 749/749 S/749 R 999/999 S/999 R Desmosedici 1000	
MD618C	R	Solid	240	N/A	Contour	N/A				03-06
VR618	R	Solid	240	N/A	Vee	N/A				03-06 08
MD619RS	F	Floating	315	Natural	Plain	9			MZ/MUZ Skorpion Tour/Traveller	95-02
MD620 Loose bobbin type	F	Solid	320	N/A	Plain	N/A			BMW R 850 RT K 1200 RS R 1100 S R 1150 RT K 1200 GT K41 K 1200 R K 1200 S R 1200 S	06 01-05 12/00-05 00-06 03-06 05-08 03-08 06-08
MD621X	F	Floating	320	Gold	Plain	6			APRILIA RS 125 Shiver 750 Mana 850 RSV Mille/Mille R All models RSV Tuono/Tuono R/Factory R BMW G 650 Xmoto MOTO GUZZI MGS-01 1100 Griso 1064cc Standard mount calipers Griso 1200 8V 1200 Griso SE 8V Radial caliper 1151cc	
MD621XC	F	Floating	320	Gold	Contour	6				06-12
VR621BLK	F	Floating	320	Black	Vee	6				07-14
VR621BLU	F	Floating	320	Blue	Vee	6				08-12
VR621RED	F	Floating	320	Red	Vee	6				01-03
VR621GLD	F	Floating	320	Gold	Vee	6				02-10
MD622X	F	Floating	320	Gold	Plain	6			DUCATI 749 Dark Monoposto/Biposto 749 R Radial caliper 749 S Monoposto/Biposto 749 Monoposto/Biposto 999 S Std Caliper Mount Monoposto/Biposto 999 Std mount caliper 999 R Radial mount caliper 999 R Fila Radial mount caliper 999 R Xerox 999 S Radial mount caliper Monoposto/Biposto	
MD622XC	F	Floating	320	Gold	Contour	6				04-06
VR622BLK	F	Floating	320	Black	Vee	6				04-06
VR622BLU	F	Floating	320	Blue	Vee	6				03-06
VR622RED	F	Floating	320	Red	Vee	6				03-06
VR622GLD	F	Floating	320	Gold	Vee	6				03-04 03-06 03-06 03-06 03-06 06 05-06
MD623RS	F	Solid	280	N/A	Plain	N/A			MUZ 500 Country	93-98
MD624	F	Floating	320	Gold	Plain	6			DUCATI Monster S4 Foggy 916cc Monster S4 916cc ST3 S ABS Model 992cc Monster S4R 996cc 2 pad caliper 996 SPS 996cc 996 996cc Monoposto/Biposto 996 S Monster S4R 996 ST4S Non ABS/996cc ST4S ABS Model/996cc Monster S4 Foggy916cc Monster S4 916cc ST3 S ABS Model 992cc Monster S4R 996cc 2 pad caliper 996 SPS 996cc 996 996cc Monoposto/Biposto 996 S MOTO-GUZZI 1100 Brevia Norge 1200 GT/2V/8V ABS Model Stelvio 1200 NTX 8V ABS	
VR624BLK	F	Floating	320	Black	Vee	6				02
VR624BLU	F	Floating	320	Blue	Vee	6				01-02
VR624RED	F	Floating	320	Red	Vee	6				06-07
VR624GLD	F	Floating	320	Gold	Vee	6				05-06 99 99-01 01 03-06 01-05 03-05 02 01-02 06-07 05-06 99 99-01 01
										05-12
										06-19
										09-19

BUYERS GUIDE
BRAKE ROTORS

BRAKE ROTOR BUYERS GUIDE - STREET

Rotor No.	F/R	Type	Dia. (mm)	Hub Color	Profile	Bobbins	Left Bracket	Right Bracket	Model	Year
MD626X MD626XC VR626BLK VR626BLU VR626RED VR626GLD	F F F F F F	Floating Floating Floating Floating Floating Floating	300 300 300 300 300 300	Gold Gold Black Blue Red Gold	Plain Contour Vee Vee Vee Vee	6 6 6 6 6 6			DUCATI Monster 400 ie Japan 620 Multistrada Twin Disc/Single Pin Pad Fixing 695 Monster Monster S2R 803cc Monster S2R Dark 803cc 620 ie Monster Series 2 - Single Pin Pad Fixing Caliper ROYAL ENFIELD Continental GT Non ABS Continental GT ABS	 07-08 06 06-09 05-07 05-07 05-07 13-16 17-18
MD627 MD627C VR627	R R R	Solid Solid Solid	245 245 245	N/A N/A N/A	Plain Contour Vee	N/A N/A N/A			DUCATI Hypermotard 796 796 Monster Non ABS Monster S2R 803cc Monster S2R Dark 803cc Hypermotard 821cc/Hypermotard SP 821cc Hyperstrada 821cc 848 Radial 2 pad caliper 848 Evo Monobloc F Calipers 848 Streetfighter Monster S4R 996cc 2 pad caliper Monster S4R 996cc S4RS Monster 998cc Radial 4 pad caliper S4R Testastretta Monster 998cc Radial 4 pad caliper S4RS Testastretta Monster 998cc Radial 4 pad caliper S4RS Tricolore/Monster Testrastretta 998cc# Radial 4 pad caliper Monster S2R 1000 992cc Multistrada 1000 DS 992cc Multistrada S 1000 DS 992cc 1100 Monster Evo Hypermotard 1100/Hypermotard 1100 S Hypermotard 1100 Evo/Hypermotard 1100 Evo SP Monster 1100 Non-ABS/Monster 1100 S Non-ABS Multistrada 1100 1078cc Multistrada 1100 S 1078cc 1199 Panigale R 1200 Monster/1200 S Monster	 10-12 10-13 05-07 05-06 13-14 13-14 08-09 10-12 12-14 05-06 03-06 06 07-08 07 08 06-08 03-05 05-06 11-12 07-09 10-12 09-10 07-09 07-09 13-14 14-21
MD629X MD629XC VR629BLK VR629BLU VR629RED VR629GLD	F F F F F F	Floating Floating Floating Floating Floating Floating	320 320 320 320 320 320	Silver Silver Black Blue Red Gold	Plain Contour Vee Vee Vee Vee	6 6 6 6 6 6			TRIUMPH Thrupton SE 865cc Thrupton 900 Thrupton 900 Ace Cafe SE	 12 04-15 14-20
MD630LS MD630RS	F F	Solid Solid	280 280	N/A N/A	Plain Plain	N/A N/A			DUCATI 750 Paso 750 Sport	 88-90 88-90
MD631	R	Solid	270	N/A	Plain	N/A			DUCATI 906 Paso 750 Paso/Sport	 88-89 87-90
MD632 MD632C VR632	R R R	Solid Solid Solid	220 220 220	N.A N.A N.A	Plain Contour Vee	N/A N/A N/A			DUCATI 748 R 2 pad caliper 748 R 4 pad caliper 748 Biposto 748 SP 748 Biposto/Monoposto 748 SPS 748 Testa Bassa Mono/Biposto 900 MH Evoluzione 916 Biposto 916 Sienna 916 SPS 996cc 996 SPS 996cc 996 996cc Monoposto/Biposto 996 R/S	 00 01-12 95-02 95-98 00-02 98-99 01 00-01 94-96 94-98 97-98 99 99-01 01

BRAKE ROTOR BUYERS GUIDE - STREET

Rotor No.	F/R	Type	Dia. (mm)	Hub Color	Profile	Bobbins	Left Bracket	Right Bracket	Model	Year
MD632 MD632C VR632 Contd.	R R R	Solid Solid Solid	220 220 220	N.A N.A N.A	Plain Contour Vee	N/A N/A N/A			998 Matrix 998cc 998 R 998cc 998 S Bayliss/Bostrom 998 S 998cc 4 pad caliper 998 998cc 2 pad caliper Monoposto/Biposto	04 02 02 02-04 02-03
MD633X MD633XC VR633GLD NOTE: Disc type with Counterbored holes. Check correct type before fitting.	F F F	Floating Floating Floating	320 320 320	Gold Gold Gold	Plain Contour Vee	6 6 6			DUCATI 998 Matrix 998cc 998 S Bayliss/Bostrom 998 S 998cc 4 pad caliper 998 998cc 2 pad caliper Monoposto/Biposto ST4 916cc KTM 990 Superduke 990 Superduke R 1190 RC8 1190 RC8 R	04 02 02-04 02-03 99 05-11 07-11 08-12 09-14
MD634LS MD634RS	F F	Floating Floating	280 280	Silver Silver	Plain Plain	9 9			DUCATI 250/350/450 Desmo 750 Sport 750 SS 860 GT/GTS 900 GTS 900 SS Darmah	74-77 74 75-76 75-76 75-76 76-77
MD634LS	R	Floating	280	Silver	Plain	9			DUCATI 860 GT/GTS 900 GTS 900 SS Darmah	75-76 75-76 76-78
MD636X MD636XC	F F	Floating Floating	320 320	Gold Gold	Plain Contour	6 6			DUCATI 748 R 996 R	00-02 01
MD640 VR640BLK VR640BLU VR640RED VR640GLD (Will not fit early models with dished-solid rotor)	F F F F F	Floating Floating Floating Floating Floating	310 310 310 310 310	Silver Black Blue Red Gold	Plain Vee Vee Vee Vee	6 6 6 6 6			TRIUMPH Daytona 750 3cyl Daytona 1000 4cyl Daytona 900 3cyl Daytona Super III 3cyl Daytona 1200 4cyl Speed Triple Carb Models Sprint All carb models Trophy 900 3cyl Trophy 1200 4cyl	92 92 93-96 94-97 93-98 94-96 94-98 94-01 94-01
MD641 VR641	R R	Solid Solid	255 255	N/A N/A	Plain Vee	N/A N/A			TRIUMPH Daytona 750 3cyl/Daytona 1000 4cyl Daytona 900 3cyl Daytona Super III 3cyl Daytona 1200 4cyl Speed Triple Carb Models Sprint All carb models Tiger 885cc Trident 900 Trophy 900 3cyl Trophy 1200 4cyl	92 93-96 94-97 93-98 94-97 93-98 92-96 92-98 92 93-01
MD642LS Note: Floating conversion kit available see MD629	F	Solid	320	N/A	Plain	N/A			TRIUMPH Adventurer Legend TT Thunderbird	96-01 98-01 95-03
MD643 VR643	R R	Solid Solid	285 285	N/A N/A	Plain Vee	N/A N/A			TRIUMPH Legend TT Adventurer Bonneville America America Cast Wheel 865cc America 865cc/cast wheel	98-01 96-01 02-06 06-09 10-20

BRAKE ROTOR BUYERS GUIDE - STREET

Rotor No.	F/R	Type	Dia. (mm)	Hub Color	Profile	Bobbins	Left Bracket	Right Bracket	Model	Year
MD643 VR643 Contd.									America LT 865cc Speedmaster 800 Scrambler 865cc/EFI Speedmaster 865cc/Carbs Speedmaster 865cc EFI Cast Wheel Eng # 392060 to 460949/6 bolt fr disc Speedmaster 865cc EFI 5 Spoke Wheel Eng # 4609050 onwards/5 bolt fr disc Thunderbird Thunderbird Sport Tiger 885i Tiger 885i/955cc Spoke wheel	14-20 03-04 10-15 05-09 09-10 11-20 95-03 98-03 98-99 99-04
MD644 (6 Bolt)	F	Solid	276	N/A	Plain	N/A			HONDA CBR 125 R Canada TRIUMPH Tiger	04-10 92-98
MD645	R	Solid	255	N/A	Plain	N/A			TRIUMPH Tiger	92-98
MD646LS MD646RS VR646BLK VR646BLU VR646RED VR646GLD	F F F F F F	Floating Floating Floating Floating Floating Floating	296 296 296 296 296 296	Gold Gold Black Blue Red Gold	Plain Plain Vee Vee Vee Vee	6 6 6 6 6 6			TRIUMPH Trident 750 Trophy 900/1200 Sprint All carb models Trident 900 Trophy 900 3cyl/Trophy 1200 4cyl	92 92 93 92-98 92-93
MD647X MD647XC VR647BLK VR647BLU VR647RED VR647GLD	F F F F F F	Floating Floating Floating Floating Floating Floating	320 320 320 320 320 320	Gold Gold Black Blue Red Gold	Plain Contour Vee Vee Vee Vee	6 6 6 6 6 6			TRIUMPH T595 Daytona Daytona 955i Speed Triple EFI T509 Sprint RS Sprint ST	97 98-00 97-01 99-04 99-04
MD648 MD648C VR648	R R R R R R	Solid Solid Solid Solid Solid Solid	220 220 220 220 220 220	N/A N/A N/A N/A N/A N/A	Plain Contour Vee Plain Contour Vee	N/A N/A N/A N/A N/A N/A			TRIUMPH T595 Daytona Daytona 600 Daytona 650 Daytona 675 Daytona 675 SE 675 Daytona Black Monobloc Radial Caliper Daytona 955i Speed Triple EFI Speed Triple 955cc Speed Triple Radial caliper 1050cc Speed Four 600 TT 600 Street Triple 675 Speed Triple R 675 675 R Brembo calipers Tiger 1050 Radial caliper	97 03-04 05 06-08 12 09-12 98-06 97-01 02-04 05-11 02-05 00-03 07-12 09-12 11 07-09
MD649 Note: Floating conversion kit available MD601LS/RS	F F	Solid Solid	310 310	N/A N/A	Plain Contour	N/A N/A			TRIUMPH Speedmaster 765cc/Carbs Bonnevill America Bonnevill 800 Bonnevill T-100 Thunderbird Sport Scrambler 865cc Speedmaster 865cc/Carbs Tiger 885cc Tiger 885i Tiger 955cc America Cast Wheel 865cc Bonnevill/Bonneville Black 865cc	03-04 02-06 01-05 02-09 98-03 06-11 05-08 97-99 98-99 99-04 06-09 06-08
MD650	F	Solid	300	N/A	Plain	N/A			BMW F 650 E169/0161 F 650 E169/0162 Funduro F 650 ST E169/163/168 Strada	09/93-96 97-00 97-00

BUYERS GUIDE
BRAKE ROTORS

BRAKE ROTOR BUYERS GUIDE - STREET

Rotor No.	F/R	Type	Dia. (mm)	Hub Color	Profile	Bobbins	Left Bracket	Right Bracket	Model	Year
MD651	R	Solid	240	N/A	Plain	N/A			BMW F 650 E169/0161 F 650 E169/0162 Funduro F 650 ST E169/163/168 Strada F 650 GS R13/0172/0182 F 650 GS Dakar R13/0173/0183 F 650 GS R13/0175/0185 F 650 GS Dakar R13/0176/0186 F 650 CS Scarver K14 F 650 CS Scarver K14 F 650 GS Sertao G 650 GS R131 HUSQVARNA TR 650 Terra/Strada ROYAL ENFIELD Continental GT 535 ABS Bullet 500 EFI Brembo caliper F & R Classic 500 Brembo caliper F & R	09/93-96 97-00 97-00 99-03 99-03 04-07 04-07 00-03 04-07 10-14 09-15 13 13-19 16-17 16-20
MD652 MD652C (Rotor ring only)	F F	Solid Solid	305 305	N/A N/A	Plain Contour	N/A N/A			BMW K 1200 RS K 1200 LT R 850 GS R 850 C R 850 R R 850 RT R 1100 GS R 1100 R R 1100 RT R 1150 GS Evo-R21/0415/0495 R 1150 GS R21/0415/0495 R 1150 GS Adventure R 1200 R 1200 C R 1200 CL R 1200 C Montauk	96-00 97-10/00 96-00 97-00 94-02 96-01 93-99 93-06/96 94-01 11/01/03 98-10/01 07/01/06 00-02 96-03 02-04 04-05
MD653 MD653C	R R	Solid Solid	276 276	N/A N/A	Plain Contour	N/A N/A			BMW R 850 GS R 850 R R 850 RT R 1100 GS R 1100 R R 1100 S R 1100 RT R 1150 GS Evo-R21/0415/0495 R 1150 GS R21/0415/0495 R 1150 GS Adventure R 1150 R R 1150 Rockster R 1150 RS R 1150 RT	96-00 94-06 96-01/06 93-99 93-01 96-06 94-01 11/01-03 98-10/01 07/01-06 01-06 03-06 01-05 00-06
MD656 VMD656 4 bolt fixing	F & R F & R	Floating Floating	250 250	Gold Black	Plain Plain	9 9			TRIUMPH T 140 V Bonneville T 140 Silver Jubilee Bonneville T 140 E Bonneville T 140 D Bonneville T 140 ES 750cc T 140 E/ES 750cc TSS 750 8 valve TSX 750	73-78 77 78-83 79-81 80-81 81-83 83 83
MD657LS MD657RS	F F	Floating Floating	260 260	Gold Gold	Plain Plain	9 9			DUCATI 500/600 Pantah	79-81 79-81
MD657LS	R	Floating	260	Gold	Plain	9			DUCATI 500 Pantah	79

BUYERS GUIDE
BRAKE ROTORS

BRAKE ROTOR BUYERS GUIDE - STREET

Rotor No.	F/R	Type	Dia. (mm)	Hub Color	Profile	Bobbins	Left Bracket	Right Bracket	Model	Year
MD660LS MD660RS	F F	Floating Floating	298 298	Silver Silver	Plain Plain	9 9			APRILIA RS 250	99-03
MD661 ABS Models	R	Floating	285	Silver	Plain	9			BMW K 75 'S' K 75 TY ABS K 100/2 K 100 LT K 100 RS K 100 RT K 1 K 1200 RS K 1200 GT K 1100 RS KL 1100 LT R 1100 RS	85-95 89-96 87-90 86-91 83-92 83-89 88-93 96-05 03-06 92-96 89-99 92-01
MD662X MD662XC VR662BLK VR662BLU VR662RED VR662GLD	F F F F F F	Floating Floating Floating Floating Floating Floating	310 310 310 310 310 310	Gold Gold Black Blue Red Gold	Plain Contour Vee Vee Vee Vee	6 6 6 6 6 6			TRIUMPH Speedfour 600 TT 600 Daytona 650	02-05 00-03 05
MD663 VR663	R R	Solid Solid	255 255	N/A N/A	Plain Vee	N/A N/A			TRIUMPH Bonneville 800 Bonneville T-100 Scrambler 865cc/Carbs Scrambler 865cc/EFI Sprint RS Tiger 800 Tiger 800 XC Thrupton SE 865cc Thrupton 900 Thrupton 900 Ace Cafe SE Bonneville/Bonneville Black 865cc Bonneville 865cc/cast wheel Bonneville SE 865cc/cast wheel Bonneville T100 865cc Bonneville T100 865cc Steve McQueen Bonneville T100 Black 865cc/Spoke Wheels Bonneville T100 Spirit SE Spoke wheels Bonneville T100 Newchurch SE Cast wheels Bonneville T214 Black/Spoke Wheels Speed Triple 1050cc Brembo radial calipers Speed Triple R 1050cc 5 Spoke Cast Wheel Brembo Monobloc Radial Calipers Speed Triple 1050cc Non ABS/Brembo calipers From VIN 461332 Sprint 1050 ST VIN 208167- 5 Spoke Wheel/Non ABS Sprint 1050 ST Non ABS/Zero offset disc Tiger 1050 Twin Side S/Arm	01-05 02-12 06-09 10-16 99-04 11-14 11-14 12 04-15 14-20 06-08 09-20 09-12 10-20 12 14-15 15 15 15 08-11 12 11-12 05-10 11-12 07-20
MD664 MD664C	R R	Solid Solid	220 220	N/A N/A	Plain Contour	N/A N/A			APRILIA RS 50 Replica RS 125	99-05 06-10
MD666X MD666XC	F F	Floating Floating	320 320	Gold Gold	Plain Contour	6 6			APRILIA RSV 1000 Mille inc. SP Model SL 1000 Falco	98-01 00-05
MD667	F	Floating	300	Silver	Plain	9			MOTO GUZZI Daytona 1000	92-95
MD668LS MD668RS	F F	Floating Floating	299 299	Gold Gold	Plain Plain	9 9			LAVERDA 1000 SFC	85-86

BRAKE ROTOR BUYERS GUIDE - STREET

Rotor No.	F/R	Type	Dia. (mm)	Hub Color	Profile	Bobbins	Left Bracket	Right Bracket	Model	Year
MD669X MD669XC VR669BLK VR669BLU VR669RED VR669GLD	F F F F F F	Floating Floating Floating Floating Floating Floating	320 320 320 320 320 320	Gold Gold Black Blue Red Gold	Plain Contour Vee Vee Vee Vee	6 6 6 6 6 6			TRIUMPH Daytona 955i Speedtriple 955cc Sprint 1050 ST VIN 208167- 5 Spoke Wheel Rocket III 2300cc Rocket III Classic Rocket III Roadstar ZERO SR/F ZF 14.4 kWh SR/S ZF 14.4 kWh	 01-06 02-04 05-10 04-08 07-08 11-19 19-21 19-21
MD671	F/R	Solid	265	N/A	Plain	N/A			BMW C 400 X CE 04 Electric F 650 GS K72/0218/0228 798cc twin cylinder/cast wheel F 650 GS 30 Years GS Twin cylinder 798cc/cast wheel F 700 GS Twin cylinder model/798cc/Spoke wheel F 750 GS F 750 GS Edition 40 F 800 GS Twin cylinder model/798cc/Spoke wheel F 800 GS Adventure Twin cylinder model/798cc/Spoke wheel F 800 R F 800 S/ST F 800 GT F 850 GS Edition 40 F 850 GS Adventure F 850 GS Adventure Edition 40 K 1200 S/R-Urban K43 K 1200 R K 1200 R-Sport K43 HP2 Enduro HP2 Megamoto HP2 Sport R NineT K21/1170cc R NineT R NineT Pure R NineT Racer R NineT Scrambler R NineT Urban G/S R 1200 RT R 1200 ST R 1200 GS R 1200 S R 1200 R K27 R 1200 R Disc has fixed bobbins K 1300 R/S S 1000 XR HUSQVARNA 900 Nuda / Nuda R	 18-23 21-22 07-13 11 11-18 18-23 20-21 08-18 12-18 09-15 06-12 13-15 20-22 18-23 20-22 05-08 05-09 07-08 05-09 07-09 08-11 14-18 18-23 18-23 18-22 18-23 18-23 18-23 05-15 03-08 02-12 06-10 06-07 08-13 09-15 14-22 12-13
MD675	F	Floating	310	Silver	Plain	9			MV AUGUSTA F4 750 All models Nissin Calipers Brutale 750 All models Nissin calipers Brutale 910 S Nissin calipers Brutale 989 R Brutale 990 R F4 1000 All models Nissin Calipers	 99-03 03-05 05-07 08-09 10 04-06
MD676	F	Floating	310	Gold	Plain	6			TRIUMPH Tiger 955 Cast wheel From VIN 198875	 04-06
MD677	R	Solid	285	N/A	Plain	N/A			TRIUMPH Tiger 955 Cast wheel From VIN 198875	 04-06

BUYERS GUIDE
BRAKE ROTORS

BRAKE ROTOR BUYERS GUIDE - STREET

Rotor No.	F/R	Type	Dia. (mm)	Hub Color	Profile	Bobbins	Left Bracket	Right Bracket	Model	Year
MD679X MD679XC VR679BLK VR679BLU VR679RED VR679GLD	F F F F F F	Floating Floating Floating Floating Floating Floating	320 320 320 320 320 320	Gold Gold Black Blue Red Gold	Plain Contour Vee Vee Vee Vee	6 6 6 6 6 6			TRIUMPH Tiger 1050 Radial Caliper Tiger 1050 SE Tiger 1050 Sport Radial Caliper/ABS Speed Triple R 1050cc ABS Model Speed Triple S 1050cc ABS Model	 07-15 11-12 13-21 13-20 13-20
MD680 MD680C	F F	Floating Floating	305 305	Gold Gold	Plain Contour	9 9			KTM 950 Superenduro 950 Supermoto R 990 SM-R 990 SM-T	 05-08 07-08 09-11 10-14
MD681 MD681C VR681	R R R	Solid Solid Solid	240 240 240	N/A N/A N/A	Plain Contour Vee	N/A N/A N/A			KTM 690 Duke 690 Supermoto 790 Duke 950 SM 950 SMR Superduke 990 990 Superduke R 990 SM-R 990 SM-T	 08-11 02-08 20-21 05-07 07-08 05-11 07-11 09-11 10-14
MD682	F	Solid	320	N/A	Plain	N/A			DUCATI Multistrada 1000 DS/S 1000 DS 992cc Multistrada 1100 1078cc Multistrada 1100 S 1078cc	 03-06 07-09 07-09
MD687 Original OEM rotor comes with fixed bobbins - this rotor requires a fitting kit - not supplied by EBC Brakes	F	Solid	305	N/A	Plain	N/A			BMW F 750 GS F 750 GS Edition 40 F 850 GS F 850 GS Edition 40 F 850 GS Adventure BMW F 850 GS Adventure Edition 40 HP2 Enduro R 1200 GS R 1200 GS/M R 1200 GS Adventure R 1200 GS Adventure/M R 1200 GS R 1200 GS Adventure R 1250 GS R 1250 GS Edition 40 R 1250 GS Adventure R 1250 GS Adventure Edition 40 R 1250 GS TE R 1250 GS Exclusive TE R 1250 GS Rallye R 1250 GS Rallye TE	 18-23 20-21 18-23 20-21 18-23 20-21 05-08 02-07 06-12 05-07 06-13 13-18 14-18 18-23 20-21 18-23 20-21 18-23 18-23 18-23 18-23 18-23
MD688	R	Solid	294	N/A	Plain	N/A			BMW K 1200 GT K44 K 1300 GT Touring	 06-08 09-11
MD689 MD689C	R R	Solid Solid	220 220	N/A N/A	Plain Contour	N/A N/A			ATK GT 250 R V-Twin Sport GT 650 R V-Twin Sport HYOSUNG GT 250 R GT 250 GT 650 R GT 650 S GT 650 UM V2S-650	 11 11 06-12 06-12 06-12 06-12 06-12 06-07

BRAKE ROTOR BUYERS GUIDE - STREET

Rotor No.	F/R	Type	Dia. (mm)	Hub Color	Profile	Bobbins	Left Bracket	Right Bracket	Model	Year
MD690 MD690C	F F	Floating Floating	300 300	Gold Gold	Plain Contour	9 9			ATK GT 250 R V-Twin Sport GT 650 R V-Twin Sport HYOSUNG GT 250 R GT 250 GT 650 R GT 650 S GT 650 UM V2S-650	11 11 06-12 06-12 06-12 06-12 06-12 06-07
MD691	F	Floating	300	Gold	Plain	6			HYOSUNG GV 650 UM V2C-650	06-12 06-08
MD692 MD692C	R R	Solid Solid	282 282	N/A N/A	Plain Contour	N/A N/A			MOTO GUZZI V11 Sport/Scuro/Naked V11 Le Mans Series California Stone Series California EV/Special Series California Vintage 750 Norge 1200/GT/GV	99-00 01-06 02-06 02-06 06-10 06-12
MD693LS MD693RS	F F	Floating Floating	272 272	Gold Gold	Plain Plain	6 6			MOTO GUZZI 1000 Lemans	84-93
MD694X MD694XC VR694BLK VR694BLU VR694RED VR694GLD	F F F F F F	Floating Floating Floating Floating Floating Floating	330 330 330 330 330 330	Gold Gold Black Blue Red Gold	Plain Contour Vee Vee Vee Vee	6 6 6 6 6 6			DUCATI 1098 1098 S 1098 S Tricolore 1099cc	07-08 07-09 07 07
MD695 MD695C VR695	R R R	Solid Solid Solid	245 245 245	N/A N/A N/A	Plain Contour Vee	N/A N/A N/A			DUCATI 848 Evo Corse Special Edition 1098 1098 S 1098 S Tricolore 1099cc 1098 R Streetfighter 1099cc Streetfighter S 1099cc Streetfighter V4 1103 Streetfighter V4 S 1103 1198 1198 S 1198 SP 1198 R Corse Special Edition	12 07-08 07-08 07 08-09 09-11 09-11 20-21 20-21 09-12 09-10 11-12 11
MD696	R	Solid	210	N/A	Plain	N/A			MV AUGUSTA F3 675 F4 750 All models Nissin Calipers Brutale 750 All models Nissin calipers Brutale 910 S Nissin calipers Brutale 910 R Brembo calipers Brutale 989 R Brutale 990 R F4/F4 RR/F4 R 998cc F4 1000 All models Nissin Calipers F4R 1000 Brembo calipers F4RR 312R 1000 Brembo calipers F4 1000cc 1078cc Brutale 1078 RR F4 RR 312 1078cc Brutale 1090 R Brutale 1090 RR Brutale 1090	12 99-03 03-05 05-07 05-07 08-09 10 10-12 04-06 06-07 7 7 08-09 08-09 12 10 13-14

BRAKE ROTOR BUYERS GUIDE - STREET

Rotor No.	F/R	Type	Dia. (mm)	Hub Color	Profile	Bobbins	Left Bracket	Right Bracket	Model	Year
MD699	R	Solid	316	N/A	Plain	N/A			TRIUMPH Rocket III Rocket III Classic 2300cc Rocket III Roadster Rocket III Touring 2300cc	04-09 07-09 11-17 09-17
MD711LD MD711RD	F F	Floating Floating	282 282	Gold Gold	Plain Plain	10 10			YAMAHA TZ 250	89-96
MD713	R	Solid	185	N/A	Plain	N/A			MORIWAKI/HONDA MD 250 H MD 250 S	08-11
MD714X MD714XC	F F	Floating Floating	280 280	Gold Gold	Plain Contour	6 6			KAWASAKI EX 500 A EX 500 D	87-93 94-99
MD719RS Countersunk screw fixing	F	Floating	340	Natural	Plain	9			BUELL All twin models	98-00
MD727	R	Floating	300	Gold	Plain	9			VICTORY V92/SC	98-03
MD730	F	Floating	298	Blue	Plain	10			YAMAHA TZ 250 TZ 250 Radial Calipers	97-01 02-10
MD732	R	Solid	185	N/A	Plain	N/A			YAMAHA TZ 250 TZ 250 Radial Calipers	89-90/92-01 02-10
MD734RS	F	Floating	340	Silver	Plain	9			BUELL All models counterbored fixing	00-05
MD735RS	F	Solid	375	N/A	Plain	N/A			BUELL All models with 375mm rotor EBR 1190 RX Sport 1190 SX Naked 1190 RS Sport	02-10 14-15 14-15 14-15
MD737	F	Solid	320	N/A	Plain	N/A			BUELL Blast	00-07
MD738	F	Solid	220	N/A	Plain	N/A			BUELL Blast	00-07
MD800X MD800XC VR800BLK VR800BLU VR800GLD	F F F F F	Floating Floating Floating Floating Floating	308 308 308 308 308	Gold Gold Black Blue Gold	Plain Contour Vee Vee Vee	6 6 6 6 6			TRIUMPH Daytona 675 Daytona 675 SE Daytona 675 Daytona 675 R Street Triple 675 Street Triple 675 Brembo R Caliper Street Triple R 675 Radial Caliper Street Triple R 675 Nissin From Vin # 560477	06-12 12 13-17 13-19 07-12 13-18 09-12 13-17
MD803 Loose bobbin type	F	Solid	320	N/A	Plain	N/A			BMW F 800 S/ST R 1100 S Non ABS R 1200 RT R 1200 ST R 1200 S HP2 Megamoto Loose bobbins INDIAN FTR 1200 FTR 1200 S FTR 1200 S Race Replica FTR 1200 Rally	06-08 12/00-06 05-10 03-08 06-11/07 11-07 18-23 19-23 19-23 20-23

BRAKE ROTOR BUYERS GUIDE - STREET

Rotor No.	F/R	Type	Dia. (mm)	Hub Color	Profile	Bobbins	Left Bracket	Right Bracket	Model	Year
MD804 Original OEM rotor comes with fixed bobbins - this rotor requires a fitting kit - not supplied by EBC Brakes	F	Solid	320	N/A	Plain	N/A			BMW F 800 GT F 800 R F 800 R F 800 ST F 900 R F 900 XR S 1000 R S 1000 R S 1000 XR HP2 Megamoto HP2 Sport R nineT K21/1170cc RnineT R Nine T R Nine T Pure R Nine T Racer R Nine T Scrambler R Nine T Urban G/S R 1200 ST R 1200 R R 1200 R R 1200 S R 1200 R K53 R 1200 RS K54 R 1200 RT K52 R 1200 RT K52 R 1250 R R 1250 RS R 1250 RT R 1250 RT SE R 1250 RT LE K 1200 LT K 1200 GT K44 K 1200 R K 1200 R K 1200 S K 1300 S K 1300 R K 1300 GT	13-18 09-14 15-18 09-13 20-23 20-23 14-23 14-23 19-23 07-09 08-11 14-18 18-23 18-23 18-20 18-23 18-23 07-08 06-07 08-14 07-10 15-18 15-18 10-13 14-18 19-23 19-23 18-23 18-22 18-22 07-09 06-08 05-07 07-10 07-08 09-15 09-15 09-11
MD809 MD809C	F F	Solid Solid	300 300	N/A N/A	Plain Contour	N/A N/A			BMW G 650 X-challenge/G 650 X-country	07-09
MD810 MD810C	R R	Solid Solid	240 240	N/A N/A	Plain Contour	N/A N/A			BMW G 650 X-challenge/G 650 X-country	07-09
MD812	R	Solid	220	N/A	Plain	N/A			KTM 1190 RC8 1190 RC8 R	08-12 09-14
MD814	R	Solid	220	N/A	Plain	N/A			DAELIM Roadwin 125	04-09
MD817X MD817XC VR817BLK VR817BLU VR817RED VR817GLD	F F F F F	Floating Floating Floating Floating Floating	320 320 320 320 320	Gold Gold Black Blue Red Gold	Plain Contour Vee Vee Vee Vee	6 6 6 6 6			TRIUMPH Sprint GT 1050cc/ABS Sprint GT SE1050cc/ABS Speed Triple 1050cc From VIN 333179 Speed Triple 1050cc From VIN 461332 Speed Triple 1050cc VIN 461332 Speed Triple R 1050cc Sprint 1050 ST Trophy SE 1215cc	10-12 13-20 07-11 07-11 11-16 12 11-12 13-17
MD820 MD820C VR820	R R R	Solid Solid Solid	255 255 255	N/A N/A N/A	Plain Contour Vee	N/A N/A N/A			TRIUMPH Tiger 800 with ABS Tiger 800 XC With ABS Tiger 800 XC SE Spoke wheel Tiger 800 XCX ABS/Spoke Wheels Tiger 800 XCa ABS/Spoke Wheels	11-14 11-17 14 15-23 15-23

BRAKE ROTOR BUYERS GUIDE - STREET

Rotor No.	F/R	Type	Dia. (mm)	Hub Color	Profile	Bobbins	Left Bracket	Right Bracket	Model	Year
MD820	R	Solid	255	N/A	Plain	N/A			Tiger 800 XCx With ABS/Spoke Wheels/STD & Low	15-23
MD820C	R	Solid	255	N/A	Contour	N/A			Tiger 800 XR ABS/Cast Wheel	15-23
VR820	R	Solid	255	N/A	Vee	N/A			Tiger 800 XR Touring ABS/Cast Wheel	15-23
Contd.									Tiger 800 XRt With ABS/Cast Wheels	15-23
									Tiger 800 XRx With ABS/Cast Wheels/STD & Low	15-23
									Tiger 1050 Single Sided S/Arm	13-15
									Speed Triple 1050cc ABS from VIN 461332 Brembo Calipers	11-15
									Sprint GT 1050cc/ABS	10-12
									Sprint GT SE1050cc/ABS	13-20
									Sprint 1050 ST VIN 208167- 5 Spoke Wheel/ABS Model	05-10
									Sprint 1050 ST ABS/Zero Offset Disc	11-12
MD821	F	Solid	310	N/A	Plain	N/A			TRIUMPH	
MD821X	F	Floating	310	Gold	Plain	6			Bonneville 865cc/cast wheel	09-15
MD821XC	F	Floating	310	Gold	Contour	6			Bonneville SE 865cc/cast wheel	09-12
Floating Conversion									Bonneville T100 Newchurch SE Cast Wheels	15
									Speedmaster 865cc/EFI	11-12
									Speedmaster 865cc EFI 5 Spoke Wheel Eng # 4609050 onwards /5 bolt fr disc	11-20
MD822	F	Solid	310	N/A	Plain	N/A			TRIUMPH	
MD822X	F	Floating	310	Gold	Plain	6			Bonneville T100 865cc	10-15
MD822XC	F	Floating	310	Gold	Contour	6			Bonneville T100 865cc Steve McQueen	12
Floating Conversion									Bonneville T100 Black 865cc/Spoke Wheels	14-15
									Bonneville T100 Spirit SE Spoke Wheels	15
									Bonneville T214 Black/Spoke Wheels	15
									America 865cc/cast wheel	10-20
									America 865cc Cast wheel America LT 865cc Cast wheel/Wind Shield	14-20
									Speedmaster 865cc EFI Cast Wheel Eng # 392060 to 46049/6 bolt fr disc	09-10
									Scrambler 865cc/EFI	10-16
									Scrambler 900cc/EFI	17
MD825	F	Floating	310	Gold	Plain	6			TRIUMPH	
									Thunderbird 1600cc/Cast Wheel	09-20
									Thunderbird 1600cc/Windscreen	12
									Thunderbird Commander 1700cc/Cast wheel	14-20
									Thunderbird LT Windscreen 1700cc/Cast wheel	14-20
									Thunderbird Storm 1700cc/Cast wheel	09-20
									Thunderbird NightStorm 1700cc/Cast wheel	09-20
MD831	R	Solid	310	N/A	Plain	N/A			TRIUMPH	
									Thunderbird 1600cc/Cast Wheel	09-20
									Thunderbird 1600cc/Windscreen	12
									Thunderbird Commander 1700cc/Cast wheel	14-20
									Thunderbird LT Windscreen 1700cc/Cast wheel	14-20
									Thunderbird Storm 1700cc/Cast wheel	09-20
									Thunderbird Night Storm 1700cc/Cast wheel	09-20
MD832	R	Solid	220	N/A	Plain	N/A			BMW	
									M 1000 R	21-24
									S 1000 RR	10-17
									S 1000 RR Models fitted with Forged race wheels 7 spoke type	15-17
									S 1000 R Naked	14-15
									S 1000 R	18-24
									S 1000 RR/RR Sport/RR M Sport	18-24
									HP4 1000cc	13-14
MD834	F	Solid	300	N/A	Plain	N/A			BMW	
MD834X	F	Floating	300	Gold	Plain	6			F 650 GS R13/0172/0182	99-03
									F 650 GS Dakar R13/0173/0183 21" F wheel	99-03
									F 650 GS R13/0175/0185 Single Cylinder 19" F wheel	04-07
									F 650 GS Dakar R13/0176/0186 21" F wheel	04-07
									F 650 CS Scarver K14/0174/0184 Belt drive/17" cast wheel	00-03
									F 650 CS Scarver K14/0177/087 Belt Drive 17" cast wheel	04-07
									F 650 GS 30 Years GS Twin cylinder 198cc /cast wheel	11
									F 650 GS K72/0218/0228 798cc twin cylinder/cast wheel	06-17
									F 650 GS "Sertao" Spoke wheel/single cylinder/Chain drive	10-14
									G 650 GS R131 Single cylinder/chain drive/cast wheel	09-15
									F 700 GS Twin cylinder model/798cc/Spoke wheel	11-18

BRAKE ROTOR BUYERS GUIDE - STREET

Rotor No.	F/R	Type	Dia. (mm)	Hub Color	Profile	Bobbins	Left Bracket	Right Bracket	Model	Year
MD834 MD834X Contd.	F F	Solid Floating	300 300	N/A Gold	Plain Plain	N/A 6			F 800 GS Twin cylinder model/798cc/Spoke wheel F 800 GS Adventure Twin cylinder model/798cc/Spoke wheel HUSQVARNA TR 650 Terra/Strada	08-18 12-18 13
MD835	F	Floating	300	Gold	Plain	6			MOTO GUZZI California II/III California 1100	83-93 94-97
MD838 6 bolt fixing	F & R	Floating	250	Gold	Plain	6			TRIUMPH T140 D Bonneville Lester Alloy Wheels T140 D Bonneville Lester Alloy Wheels	79-81 79-81
MD840 MD840C	R R	Solid Solid	282 282	N/A N/A	Plain Contour	N/A N/A			MOTO GUZZI 1100 Griso 1064cc Standard mount calipers 1100 Brevia Norge 1200/GT/GV Norge 1200 GT 8V Griso 1200 8V 1200 Griso SE 8V Radial caliper 1151cc Stelvio 1200 8V NTX/ABS MGX-21 California 1400 Custom/Touring	05-12 05-12 06-12 10-19 09-12 09-19 09-19 18-21 13-19
MD841X MD841XC VR841BLK VR841BLU VR841RED VR841GLD	F F F F F	Floating Floating Floating Floating Floating	320 320 320 320 320	Gold Gold Black Blue Red Gold	Plain Contour Vee Vee Vee Vee	6 6 6 6 6 6			DUCATI 796 Monster ABS/Non ABS M796 Monster 20th Anniversary Model 797 Monster Monster 821 Monster Dark 821 Monster Stripe 821 848 Streetfighter 939 Hypermotard 939 Hypermotard SP 950 Multistrada 950 Supersport 950 Supersport S Scrambler 1100 Sport Scrambler 1100 Special Scrambler 1100 Pro Scrambler 1100 Sport Pro Multistrada 1200 Multistrada 1200 Enduro Multistrada 1200 Enduro Pro Multistrada 1200 S Sport Multistrada 1200 S Multistrada 1200 S Pikes Peak Multistrada 1200 Pikes Peak 1200 S Multistrada Grandtourismo 1200 S Touring 1200 Monster 1200 S Monster Diavel 1260/Diavel 1260 S 1200 R Monster Diavel ABS Diavel Carbon ABS Diavel AMG Diavel Cromo Diavel Dark ABS Diavel Dark Diavel Strada 1262 X Diavel Dark 1262 X Diavel Black Star 1262 X Diavel 1262 X Diavel S	10-14 13-14 17-24 15-23 15-20 15-17 12-14 16-24 16-24 17-24 17-24 17-24 17-24 18-21 18-21 18-24 18-21 10-17 16-19 18-19 10 16-17 11-14 16-17 13-14 10-14 14-19 14-19 20 16-17 11-17 16-19 12 12-14 13-14 13-14 13-14 20-24 20-22 16-24 16-24
MD842X MD842XC VR842BLK	F F F	Floating Floating Floating	305 305 305	Gold Gold Black	Plain Contour Vee	6 6 6			TRIUMPH Tiger 800 Inc ABS Tiger 800 XC Inc ABS	11-14 11-20

BRAKE ROTOR BUYERS GUIDE - STREET

Rotor No.	F/R	Type	Dia. (mm)	Hub Color	Profile	Bobbins	Left Bracket	Right Bracket	Model	Year
VR842BLU	F	Floating	305	Blue	Vee	6			Tiger 800 XC SE Spoke wheel	14
VR842RED	F	Floating	305	Red	Vee	6			Tiger 800 XCx ABS/Spoke Wheels	15
VR842GLD	F	Floating	305	Gold	Vee	6			Tiger 800 XCa With ABS/Spoke Wheels	15
									Tiger 800 XCx With ABS/Spoke Wheels/STD & Low	15-20
									Tiger 800 XR ABS/Cast Wheel	15-20
									Tiger 800 XR Touring ABS/Cast Wheel	15
									Tiger 800 XRt With ABS/Cast Wheels	16-20
									Tiger 800 XRx With ABS/Cast Wheels/STD & Low	15-20
									Tiger 1200 Explorer 1215cc	12-15
									Tiger Explorer XC 1200 Up to Vin # 740276/1215cc/Cast & Spoke Wheels	13-15
									Tiger Explorer XC 1200 Vin # 740277 onwards/1215cc/Spoke Wheels	16-17
									Tiger Explorer XCa 1200 1215cc/Spoke Wheels	16-23
									Tiger Explorer XCx 1200 1215cc/Spoke Wheels/STD & Low	16-23
									Tiger Explorer XR 1200 1215cc/Cast Wheels	16-23
									Tiger Explorer XRx 1200 1215cc/Cast Wheels/STD & Low	16-23
									Tiger Explorer XRt 1200 1215cc/Cast Wheels	16-23
									Tiger 1200 Alpine Edition 1215cc/Cast Wheels/STD & Low	20-23
									Tiger 1200 Desert Edition 1215cc/Spoke Wheels	20-23
MD843X	F	Floating	320	Gold	Plain	6			DUCATI	
MD843XC	F	Floating	320	Gold	Contour	6			848 Radial 2 pad caliper	08-09
VR843BLK	F	Floating	320	Black	Vee	6			848 Evo Monobloc F Calipers	10-12
VR843BLU	F	Floating	320	Blue	Vee	6			899 Panigale	14-23
VR843RED	F	Floating	320	Red	Vee	6			955 Panigale V2	19-24
VR843GLD	F	Floating	320	Gold	Vee	6			959 Panigale ABS	16-19
									959 Panigale S Corse	18-19
									Monster 1100 Non ABS	09-10
									Monster 1100 ABS	09-10
									Monster 1100 S Non ABS	09-10
									Monster 1100 S ABS	09-10
									Monster 1100 EV ABS	11-12
									1100 Monster Diesel	13-14
									M 1100 Evo Monster 20th Anniversary Model	13-14
									S4RS Monster 998cc Radial 4 pad caliper	06
									S4R Testastretta Monster 998cc Radial 4 pad caliper	07-08
									S4RS Testastretta Monster 998cc Radial 4 pad caliper	07
									S4RS Tricolore/Monster Testastretta 998cc# Radial 4 pad caliper	08
MD844X	F	Floating	300	Gold	Plain	6			KTM	
MD844XC	F	Floating	300	Gold	Contour	6			690 Enduro R ABS	09-17
									990 Adventure ABS Model For left side	07-12
MD845	R	Solid	240	N/A	Plain	N/A			BMW	
									G 650 X Moto	07-09
MD847	F	Solid	280	N/A	Plain	N/A			ROYAL ENFIELD	
									Bullet 500 EFI Pricol caliper/Drum R	10-15
									Bullet 500 EFI Brembo caliper F & R	16-24
									Classic 500 Pricol caliper/Drum R	10-15
									Classic 500 Brembo caliper F & R	16-17
									Classic 500 Battle Green Pricol caliper/Drum R	10-15
									Classic 500 Chrome Pricol caliper/Drum R	10-15
									Classic 500 Chrome Brembo caliper F & R	16-17
									Classic 500 Desert Storm Pricol caliper/Drum R	10-15
MD848X	F	Floating	300	Gold	Plain	6			KTM	
MD848XC	F	Floating	300	Gold	Contour	6			990 Adventure ABS Model For right side	07-12
									990 Adventure Baja Edition	13-14
MD850	R	Solid	230	N/A	Plain	6			KTM	
									Duke 390	15-23
									RC 390	15-23
									390 Adventure	21
MD851	R	Solid	220	N/A	Plain	N/A			TRIUMPH	
MD851C	R	Solid	220	N/A	Contour	N/A			Daytona 675	13-17
									Daytona 675 R	13-19
									Street Triple 675	13-19
									Street Triple R 675	13-19

BRAKE ROTOR BUYERS GUIDE - STREET

Rotor No.	F/R	Type	Dia. (mm)	Hub Color	Profile	Bobbins	Left Bracket	Right Bracket	Model	Year
MD851 MD851C Contd.	R R	Solid Solid	220 220	N/A N/A	Plain Contour	N/A N/A			Street Triple 675 RXSE ABS Street Triple S 675 Street Triple R/LRH 765 ABS Street Triple RS 765 ABS Thruxton R 1200cc Thruxton TFC 1200cc	15 18-21 18-21 18-21 16-21 19-21
MD852X MD852XC	F F	Floating Floating	310 310	Gold Gold	Plain Contour	6 6			TRIUMPH Street Triple 675 Street Triple R 675 Street Triple R 765 Street Triple RS 765 Thruxton 1200cc Floating disc conversion Thruxton R 1200cc Thruxton TFC 1200cc	13-19 13-19 18-22 18-21 16-21 16-21 19-21
MD856X MD856XC	F F	Floating Floating	320 320	Gold Gold	Plain Contour	6 6			KTM 690 Duke 2 pad caliper 890 Duke R	12-21 21-24
MD857 MD857C	R R	Solid Solid	240 240	N/A N/A	Plain Contour	N/A N/A			KTM 690 Duke 2 pad caliper	12-19
MD858 MD858C VR858	R R R	Solid Solid Solid	260 260 260	N/A N/A N/A	Plain Contour Vee	N/A N/A N/A			APRILIA Mana 850	08-12
MD859	F	Floating	320	Gold	Plain	5			MOTO GUZZI V9 Bobber/Sport V9 Roamer	18-21 18-21
MD862X	F	Floating	320	Gold	Plain	6			BMW HP4 K42 S 1000 RR Models fitted with Forged race wheels 7 spoke type S 1000 R K47 S 1000 XR K69	13-14 15-17 13-20 18-19
MD863	R	Solid	282	N/A	Plain	N/A			TRIUMPH Tiger Explorer 1200 Tiger 1200 XC Vin # 740277 onwards/1215cc/Spoke Wheels Tiger 1200 XCa 1215cc/Spoke Wheels Tiger 1200 XCx/XRx 1215cc/Spoke Wheels/STD & Low Tiger 1200 XR 1215cc/Cast Wheels Tiger 1200 XRt 1200 1215cc/Cast Wheels Tiger 1200 Alpine Edition 1215cc/Cast Wheels/STD & Low Tiger 1200 Desert Edition 1215cc/Spoke Wheels	12-15 16-23 16-23 16-23 16-23 16-23 20-23 20-23
MD864 MD864X MD864XC	F F F	Solid Floating Floating	300 300 300	N/A Gold Gold	Plain Plain Contour	N/A 6 6			KTM Duke 390 RC 390	15-23 15-23
MD865X MD865XC	F F	Floating Floating	305 305	Gold Gold	Plain Contour	6 6			DUCATI 796 Hypermotard 1100 Hypermotard 1100 Hypermotard GVO 1100 Hypermotard GVOSP 1100 Hypermotard 1100S	10-12 07-09 10-12 10-13 07-09
MD868X MD868XC	F F	Floating Floating	330 330	Gold Gold	Plain Contour	6 6			DUCATI Scrambler Café Racer Cast wheels/803cc Scrambler Icon Cast wheels/803cc Scrambler Icon Dark Cast wheels/803cc Desert Sled Spoke wheels/803cc Scrambler Full Throttle Cast wheels/803cc	17-23 15-23 20-23 18-23 15-23
MD871	R	Solid	260	N/A	Plain	N/A			MOTO GUZZI 750 Nevada Club From LK112434 750 Nevada Base/Club Nevada Classic 750ie	98-01 02-03 04-09

BUYERS GUIDE
BRAKE ROTORS

BRAKE ROTOR BUYERS GUIDE - STREET

Rotor No.	F/R	Type	Dia. (mm)	Hub Color	Profile	Bobbins	Left Bracket	Right Bracket	Model	Year
MD871 Contd.	R	Solid	260	N/A	Plain	N/A			V 750 ie Brevia V7 Classic V7 Cafe Classic V7 Racer V 750 ie Brevia V9 Bobber/Sport V9 Roamer	03-08 08-12 11-12 10-11 03-08 18-21 18-21
MD872 MD872C VR872	R R R	Solid Solid Solid	256 256 256	N/A N/A N/A	Plain Contour Vee	N/A N/A N/A			APRILIA Mana 850 GT ABS	09-16
MD873 MD873X	F F	Solid Floating	310 310	N/A Gold	Plain Plain	N/A 6			TRIUMPH Bonneville T100 900cc Bonneville T100 Black 900cc Bonneville T120 1200cc Bonneville T120 Black 1200cc Street Twin 900cc Bonneville Speedmaster 1200	17 17 16-23 16-23 16-23 18-23
MD874	R R	Solid Solid	255 255	N/A N/A	Plain Plain	N/A N/A			TRIUMPH Bonneville Bobber 1200cc Bonneville Bobber Black 1200cc Bonneville T100 900cc Bonneville T100 Black 900cc Street Cup 900cc Street Twin 900cc New Street 900cc Bonneville Speedmaster 1200 Scrambler 1200 XC Scrambler 1200 XE Speed Twin 1200	17-23 18-21 17-23 17-21 17-20 16-23 18-20 18-23 19-21 19-21 19-23
MD877	R	Solid	240	N/A	Plain	N/A			ROYAL ENFIELD Continental GT ABS	17-23
MD878 MD878C VR878	R R R	Solid Solid Solid	245 245 245	N/A N/A N/A	Plain Contour Vee	N/A N/A N/A			DUCATI 796 Monster ABS 950 Hypermotard 950 Hypermotard SP 950 Hypermotard RVE	10-15 16-21 16-21 21
MD879	R	Solid	265	N/A	Plain	N/A			DUCATI 950 Multistrada 950 Multistrada S Multistrada 1200 Multistrada 1200 Pikes Peak Multistrada 1200 S Multistrada 1200 Enduro Pro Diavel ABS Diavel Carbon ABS Diavel 1260 Diavel 1260 S 1262 X Diavel 1262 X Diavel S 1260 Multistrada/Multistrada Enduro 1260 Multistrada Pikes Peak 1260 Multistrada S 1260 Multistrada S Grand Tour	17-22 20-22 16-17 16-17 16-17 18-19 11-17 11-19 20-23 20-23 16-23 16-23 18-23 18-23 18-23 18-23
MD880 MD880C VR880	R R R	Solid Solid Solid	245 245 245	N/A N/A N/A	Plain Contour Vee	N/A N/A N/A			DUCATI Supersport 936cc Supersport S 936cc 955 Panigale V2 955 Panigale V2 S Corse 959 Panigale S Corse 998 Panigale V4 Superleggera 1103 Panigale V4 1103 Panigale V4 S	17-22 17-22 19-23 19-21 18-19 21-23 18-23 18-23

BRAKE ROTOR BUYERS GUIDE - STREET

Rotor No.	F/R	Type	Dia. (mm)	Hub Color	Profile	Bobbins	Left Bracket	Right Bracket	Model	Year
MD880	R	Solid	245	N/A	Plain	N/A			1103 Panigale V4 R	21-23
MD880C	R	Solid	245	N/A	Contour	N/A			1103 Panigale V4 SP	21-23
VR880	R	Solid	245	N/A	Vee	N/A			1199 Panigale	12-15
Contd.									1199 Panigale S	12-15
									1199 Panigale S Tricolore	12-14
									1199 Panigale R	13-15
									1199 Panigale Superleggera	14
									1200 Monster	14-23
									1200 Monster S	14-23
									1200 Monster R	16-17
									1200 Monster Stripe	15
									1200 Multistrada	10-15
									1200 Multistrada S Sport	10
									1200 Multistrada S Pikes Peak	11-14
									1299 Panigale V4	15-23
									1299 Panigale V4 S	15-23
									1299 Panigale V4 S Corse	18-21
									1299 Panigale V4 Speciale	18-21
									1299 Panigale V4 R	15-23
									1299 Panigale R FE	18-23
MD881	F	Solid	300	N/A	Plain	N/A			BMW G 310 R	17-24
									G 310 GS	17-24
									G 310 GS Edition 40	20-21
MD882	R	Solid	240	N/A	Plain	N/A			BMW G 310 R	17-24
									G 310 GS	17-24
									G 310 GS Edition 40	20-21
MD883X	F	Floating	310	Gold	Plain	6			TRIUMPH	
MD883XC	F	Floating	310	Gold	Contour	6			Thrupton R 1200 Liquid Cooled	16-21
MD884X	F	Floating	320	Gold	Plain	6			MV	
MD884XC	F	Floating	320	Gold	Contour	6			675 Brutale	12-17
									675 F3	12-18
									675 F3 Serie Oro	12-13
									675 F3 RC	15-18
									800 Brutale	12-21
									800 Brutale Dragster	14-15
									800 Dragster RC	17-21
									800 Dragster RR	15-21
									800 F3	13-18
									800 F3 Ago	14-15
									800 F3 RC	15-18
									800 Stradale	15
									800 Turismo Veloce	14-21
									800 Turismo Veloce Lusso	15-21
									800 Turismo Veloce RC	17-18
									Rivale 800	14-18
MD885	R	Solid	220	N/A	Plain	N/A			MV	
MD885C	R	Solid	220	N/A	Contour	N/A			675 Brutale	12-17
									675 F3	12-18
									675 F3 Serie Oro	12-13
									675 F3 RC	15-18
									800 Brutale	12-21
									800 Brutale Dragster	14-15
									800 Dragster RC	17-21
									800 Dragster RR	15-21
									800 F3	13-18
									800 F3 Ago	14-15
									800 F3 RC	15-18
									800 Stradale	15
									800 Turismo Veloce	14-21
									800 Turismo Veloce Lusso	15-21
									800 Turismo Veloce RC	17-18
									Rivale 800	14-18

BRAKE ROTOR BUYERS GUIDE - STREET

Rotor No.	F/R	Type	Dia. (mm)	Hub Color	Profile	Bobbins	Left Bracket	Right Bracket	Model	Year
MD886X	F	Floating	310	Gold	Plain	6			TRIUMPH Bonneville T100 900cc Bonneville T100 Black 900cc Street Cup 900cc	16-23 16-21 16-21
MD890BLK VR890BLK	F F	Floating Floating	299 299	Black Black	Plain Vee	9 9			INDIAN Chief Dark Horse Chief Vintage Chieftain Chieftain Dark Horse Chieftain Limited Chieftain Elite Roadmaster Roadmaster Dark Horse Roadmaster Limited Roadmaster Dark Horse Jack Daniel's Edition Roadmaster Elite Springfield Springfield Dark Horse VICTORY Cross Country 8 Ball Cross Country Touring Cross Country Cory Ness Victory Cross Roads Cross Roads Classic Cross Roads 8 Ball Empulse TT Gunner Hammer Hammer 8 Ball Hammer S High Ball Jackpot Judge King Pin King Pin Tour King Pin Low Magnum Magnum X-1 Ness Signature Series Octane 1200cc Vegas Low Vision Tour all models Arlen Ness Victory Vision	16-22 14-23 14-23 14-23 14-23 14-23 15-23 15-23 15-23 21 15-23 16-23 19-23 15-16 13-17 11-12 10-12 13-14 14-15 16 15-17 08-11 16 07-17 12-17 07-16 13-17 04-12 08-09 09 15-17 15-17 05-07 17 08-09 08-15 10-12
MD891	F	Floating	300	Silver	Plain	9			MOTO GUZZI G5 V1000	78-83
MD893	F	Solid	300	N/A	Plain	N/A			ROYAL ENFIELD Himalayan Continental GT 650cc ABS Interceptor 650	16-23 17-23 18-23
MD894 MD894C	R R	Solid Solid	240 240	N/A N/A	Plain Contour	N/A N/A			ROYAL ENFIELD Himalayan Continental GT 650cc ABS Interceptor 650	16-23 17-23 18-23
MD896X	F	Floating	320	Black	Plain	6			KTM 1090 Adventure R 1190 Adventure Inc R model 1290 Super Adventure R, S and T models	17-19 14-16 15-23
MD898X MD898XC	F F	Floating Floating	320 320	Gold Gold	Plain Contour	6 6			ROYAL ENFIELD Continental GT 650cc ABS Interceptor 650	17-23 18-23

BRAKE ROTOR BUYERS GUIDE - STREET

Rotor No.	F/R	Type	Dia. (mm)	Hub Color	Profile	Bobbins	Left Bracket	Right Bracket	Model	Year
MD899	R	Solid	245	N/A	Plain	N/A			DUCATI Scrambler Icon Cast Wheels/803cc Scrambler Full Throttle Cast Wheels/803cc Scrambler Desert Sled Spoke Wheels/803cc Scrambler Café Racer Spoke Wheels/803cc Scrambler Sixty 2 Monster 797 / 797+ Monster Dark 821 GT 1000 992cc GT 1000 Touring - Sport Classic	15-23 15-23 18-23 18-23 16-23 17-23 15-20 07-10 09
MD8001	R	Solid	275	N/A	Plain	N/A			BMW R 1200 GS Liquid Cooled/Radial Mount Caliper R 1200 GS Adventure Liquid Cooled/Radial Mount Caliper R 1200 R R 1200 RS R 1200 RT Radial Caliper Disc Has Fixed Bobbins R 1250 GS R 1250 GS Exclusive TE R 1250 GS Rallye R 1250 R R 1250 RT R 1250 RT LE	13-18 14-18 15-18 15-18 14-18 18-24 18-24 18-24 19-24 18-24 18-24
MD8002	F	Solid	300	N/A	Plain	N/A			APRILIA RX 50 Racing	03-06
MD8003X ABS sensor disc	F	Floating	305	Gold	Plain	6			KTM 990 Supermoto T SM-T 990 Supermoto R SM-R 990 Supermoto R SM-R	09-13 08-09 10-13
MD8004X	F	Floating	330	Gold	Plain	6			APRILIA RSV4 RF 1100 RSV4 RR 1100 Tuono 1100 V4 Factory Tuono 1100 V4R Tuono 1100 V4 RR	17-23 17-23 17-23 17-23 17-23
MD8005	F	Solid	230	N/A	Plain	N/A			BOOM TRIKE Various Models	10-18
MD8006 MD8006C	R R	Solid Solid	265 265	N/A N/A	Plain Contour	N/A N/A			DUCATI 1200 Multistrada Enduro 1200 Multistrada Enduro 1200 Multistrada Enduro Pro	16 17-18 18-19
MD8007	R	Solid	260	N/A	Plain	N/A			INDIAN FTR 1200 FTR 1200 S FTR 1200 S Race Rep FTR 1200 Rally	19-23 19-23 19-23 19-23
MD8009	F	Solid	300	N/A	Plain	N/A			KTM 125 Duke 200 Duke	17-21 17-21
MD8010	F	Solid	300	N/A	Plain	N/A			KTM RC 390	17-23
MD8011	F	Floating	330	Gold	Plain	6			DUCATI Multistrada 1200 S Sport Multistrada 1200 S Multistrada 1200 S Pikes Peak Multistrada 1200 Pikes Peak 1200 S Multistrada Grandtourismo 1200 S Touring 1260 Multistrada 1260 Multistrada Touring	10 16-17 11-14 16-17 13-14 10-14 18-20 18

BUYERS GUIDE
BRAKE ROTORS

BRAKE ROTOR BUYERS GUIDE - STREET

Rotor No.	F/R	Type	Dia. (mm)	Hub Color	Profile	Bobbins	Left Bracket	Right Bracket	Model	Year
MD8011 Contd.	F	Floating	330	Gold	Plain	6			1260 S Multistrada 1260 S Multistrada D Air 1260 S Multistrada Pikes Peak 1260 Multistrada Enduro 1260 Multistrada S Grand Tour Multistrada V4 Multistrada V4 S Multistrada V4 Sport	18-20 18-20 18-20 18-20 19-20 21 21 21
MD8014X MD8014XC	Front Front	Floating Floating	320 320	Gold Gold	Plain Contour	6 6			TRIUMPH Speed Twin 1200cc Scrambler XC 1200 Twin Scrambler XE 1200 Twin Rocket 3 R Rocket 3 GT Speed Triple R 1050cc Speed Triple RS 1050cc Speed Triple RR 1200cc Speed Triple RS 1200cc Tiger 850 Sport Tiger 900 Tiger 900 GT Low Tiger 900 GT Pro Tiger 900 Rally Tiger 900 Rally Pro Tiger 1200 GT Tiger 1200 GT Pro Tiger 1200 GT Explorer Tiger 1200 Rally Pro Tiger 1200 Rally Pro Explorer	21-23 19-21 19-21 19-23 19-23 17-21 18-21 21-23 21-23 21-23 21-23 20-23 20-23 20-23 20-23 20-23 21-23 21-23 21-23 21-23 21-23 21-23
MD8015X	Rear	Floating	320	N/A	Plain	6			TRIUMPH Rocket III Touring	2012
MD8016X	Front	Floating	310	Black	Plain	6			TRIUMPH Street Triple 765R	22-23
MD8017X	Front	Floating	330	Black	Plain	6			BMW S 1000 RR Sport Inc M-Sport M 1000 RR M 1000 R	19-23 21-23 2023
MD8018XBLK	Front	Floating	320	Gold	Plain	6			HARLEY DAVIDSON Pan America Adventure Special	20-23
MD8019	Rear	Solid	280	N/A	Plain	N/A			HARLEY DAVIDSON Pan America Adventure Pan America Adventure Special	20-23 20-23
MD8020	Front	Solid	320	N/A	Plain	N/A			HARLEY DAVIDSON Pan America Adventure	20-23
MD8022	Rear	Solid							BMW XR 1000 R	20-23
MD901D V901	F & R	Solid	190	N/A	Plain	N/A			BETA Eikon 50 Team MALAGUTI F15 Firefox F12 Phantom F15 Firefox L/C PEUGEOT Vivacity X-Race 50/Pulsa 50 Metal-X Trekker 50 Elyseo 50 Jet Force 50 Ludix 50 14" wheels Elegance/Ambition Ludix 125	02-03 02-03 98-03 04 02-05 02-05 02-05 03-05 03-05 04-05 04-05

BRAKE ROTOR BUYERS GUIDE - STREET

Rotor No.	F/R	Type	Dia. (mm)	Hub Color	Profile	Bobbins	Left Bracket	Right Bracket	Model	Year
MD903D VR903	F	Solid	245	N/A	Plain	N/A			YAMAHA YP 250 Majesty 5CV1 YP 250 Majesty 5GM2/9-5SJ2/5/9	97 00-03
MD904D	F	Solid	155	N/A	Plain	N/A			PEUGEOT Ludix 50 Trend/One/Snake/Bullet Fox 50 CW 50 L/TL Zuma/Zuma II JYM 90 T Axis 4RT6 YA 90 Axis 4CY1/5/7 - 4EN5/6/7 YA 100 W Grand Axis 5TC2/4/5 YW 100 BW Zuma 125 XC155 F/G S-Max	04 07-08 99 01 91-96 01-03 97-08 21-22 15-16
MD908D	F	Solid	186	N/A	Plain	N/A			HONDA CN 250 Helix CN 250 Helix	86-87 92-07
MD910D	F	Solid	200	N/A	Plain	N/A			PIAGGIO Fly 50 Fly 50 4T/2V Typhoon 50 4T/4V/12" Wheels Fly 150 Fly 150 VESPA ET2 50cc LX 50 Primavera 50 4T/4V S 50 4T/4V Sprint 50 4T/4V ET4 150cc Primavera 150 4T/3V/ie PX 150 All models LX 150 ie LXV 150 ie S 150 ie	05-12 07-14 10-11 05-12 97-05 05-15 13-15 08-15 14-15 99-05 13-15 05-06 05-15 10-15 08-15
MD915D	F	Solid	155	N/A	Plain	N/A			MALAGUTI Yesterday 50 F10 Fast Time	98-03 02-03
MD922D	F	Solid	240	N/A	Plain	N/A			HONDA NSS 250/250 A/A5 Reflex PS 250 Big Ruckus	01-07 05-06
MD923D VR923	F	Solid	190	N/A	Plain	N/A			YAMAHA CW 50 M/N Zuma II Delivery 50 From F. No 609100 EW 50 Stunt 5LH2/5YN1 X-peed 50/Special Edition Zyclone 50 Thunderbike 150	00-01 06-08 01-03 00-05 04-05 07-08
MD924D	F	Solid	220	N/A	Plain	N/A			DERBI Boulevard 150 Sport City 50 4T SR 50 Motard 4T	03-05 08-14 12-15
MD925D	F & R	Solid	180	N/A	Plain	N/A			PEUGEOT Speedfight 2 X-Team A/C Elyseo 50 Elyseo 100 Speedfight X-Race 50 LNDP/100 NP	02-05 03-05 03-05 03-05
VR927	R	Solid	230	N/A	Vee	N/A			YAMAHA Zuma 125 YW 125 MB	21-22
MD931D	F	Solid	190	N/A	Plain	N/A			HONDA NHX 110 Elite	10-11

BRAKE ROTOR BUYERS GUIDE - STREET

Rotor No.	F/R	Type	Dia. (mm)	Hub Color	Profile	Bobbins	Left Bracket	Right Bracket	Model	Year
MD933D	F	Solid	160	N/A	Plain	N/A			SYM Mio 50 DD 50	05-12 02-12
MD941D	F	Solid	175	N/A	Plain	N/A			ITALJET Dragster 50 Formula 50 Air Cooled Formula 50 Liquid Cooled Formula 125 LC	98-03 99-03 96-03 96-03
MD942D	R	Solid	220	N/A	Plain	N/A			APRILIA Scarabeo 150 Scarabeo 125/200 GT Scarabeo 250 Sport City 250 Sport City Cube 250	99-06 4 06-08 07-14 08-09
MD943D	F & R	Solid	190	N/A	Plain	N/A			DERBI Atlantis 50 GP1 50 APRILIA Rally 50 Air Cooled Mojito Retro 50 Scarabeo 50 Ditech R disc model SR 50 Factory Mojito Custom 50 Mojito Custom 150	02-06 02-06 04-05 04-05 02-08 99-15 04-06 05-08
MD945D	F	Solid	220	N/A	Plain	N/A			APRILIA Scarabeo 50 Ditech R disc model Scarabeo Street 50 Scarabeo 100 4T	02-08 99-05 04-14
MD946D	F	Solid	200	N/A	Plain	N/A			MALAGUTI Phantom F12 F12 Phantom A/C F15 Firefox L/C	98-03 98-03 04
MD947D	F	Solid	226	N/A	Plain	N/A			PEUGEOT Elyseo 100 Elystar 50 P	03-05 03-05
MD948D	R	Solid	190	N/A	Plain	N/A			ITALJET Dragster 50 LC	96-03
MD950D	F	Solid	175	N/A	Plain	N/A			ITALJET Formula 50 Liquid Cooled Formula 125 LC	96-03 96-03
MD951D	F	Solid	220	N/A	Plain	N/A			ITALJET Torpedo 50 Torpedo 125 4T Torpedo 150	98-03 99-03 03
MD952D	F	Solid	260	N/A	Plain	N/A			APRILIA Scarabeo 150 Scarabeo 125/250 GT Sport City 125 4T Scarabeo 200 Sport City 250 Sport City Cube 250 Scarabeo 250 Atlantic 500 Scarabeo 500/ie	99-06 04-05 08-14 08-14 07-14 08-09 06-08 03-08 03-14
MD953D MD953C	R R	Solid Solid	230 230	N/A N/A	Plain Contour	N/A N/A			YAMAHA YP 250 Majesty 5GM2/9-5SJ2/5/9	00-03

BRAKE ROTOR BUYERS GUIDE - STREET

Rotor No.	F/R	Type	Dia. (mm)	Hub Color	Profile	Bobbins	Left Bracket	Right Bracket	Model	Year
MD954D	F	Solid	226	N/A	Plain	N/A			PEUGEOT Looxor 50	02-05
MD955D	F	Solid	230	N/A	Plain	N/A			MALAGUTI Ciak 50/150	02-03
MD956D	F & R	Solid	220	N/A	Plain	N/A			PIAGGIO LT 50 Fly 150 4T/3V LT 150 GT 200 L Granturismo VESPA GT 60 250cc Ltd Edition GTS 250 GTV 250/LXV 250 GTS 300 ie GTS 300 Super/GTV 300 ie GTS 300 4V ABS/Super Sport/Touring Inc HPE GTS Super 300 HPE-Tech 4T/4V	97-05 13-15 98-05 05-08 06-08 05-08 07-08 08-15 10-15 18-23 18-23
MD959D VR959	F	Solid	240	N/A	Plain Vee	N/A N/A			PIAGGIO Liberty 50 4T Liberty 50 S 4T Liberty 150 4T Liberty S 150 4T	17-20 17-20 17-20 17-20
MD960D	R	Solid	240	N/A	Plain	N/A			PIAGGIO BV 300 Tourer MP3 250cc/MP3 400ie MP3 500 Three wheeler - 12" F/14" R Wheel MP3 500 Three wheeler - 13" F/14" R Wheel X9 500 Evolution BV 500	10-12 07-15 07-14 15-16 05-09 06-12
MD961D	F & R	Solid	260	N/A	Plain	N/A			PIAGGIO BV 200 BV 250 BV 500	02-06 06-11 06-12
MD963D	F	Solid	220	N/A	Plain	N/A			YAMAHA T 105 SE Crypton 5AM4/1D81/1D82	99-09
MD964D	F & R	Solid	190	N/A	Plain	N/A			DERBI Predator Atlantis Bullet/City HUSQVARNA WRS 50 Scooter	99-01 02-05 98-00
MD968D	F & R	Solid	220	N/A	Plain	N/A			BMW C1 125 C1 200	99-03 01-03
MD970D	F	Solid	220	N/A	Plain	N/A			HONDA SH 150i	10-11
MD971D	F & R	Solid	180	N/A	Plain	N/A			KYMCO Agility 50 4T Cobra Racer 50 SF10AG Cobra Cross/Racer 50 SF10AF Sting 50 2T Vitality 50 4T Yup 50 Super 9 LC/AC ZX 50 Super Fever Agility 125	05-23 00-04 05-06 07-11 05-08 02-09 02-09 02-04 06-15
MD973D	F	Solid	220	N/A	Plain	N/A			KYMCO 150/250 Bet & Win Grand Vista 250	02-08 04-10

BUYERS GUIDE
BRAKE ROTORS

BRAKE ROTOR BUYERS GUIDE - STREET

Rotor No.	F/R	Type	Dia. (mm)	Hub Color	Profile	Bobbins	Left Bracket	Right Bracket	Model	Year
MD974D	R	Solid	200	N/A	Plain	N/A			KYMCO 150/250 Bet & Win Yager GT 200 i Grand Vista 250	02-08 09-10 04-10
MD977D	F	Solid	226	N/A	Plain	N/A			PEUGEOT Elyseo 125/150	03-05
MD978D	R	Solid	210	N/A	Plain	N/A			PEUGEOT Elystar 50 P Elyseo 125/150 Elystar 125/150 P Jet Force 125 EFI/Compressor	03-05 03-05 03-05 03-05
MD980D	F	Solid	226	N/A	Plain	N/A			PEUGEOT Elystar 125/150 P	03-05
MD981D	F	Solid	180	N/A	Plain	N/A			KYMCO Super 9 AC	02-09
MD982D	R	Solid	165	N/A	Plain	N/A			ADLY Thunderbike 150	07-08
MD983D	F	Solid	260	N/A	Plain	N/A			PIAGGIO BV 300 Tourer X9 500 Evolution	10-12 05-09
MD986D	F	Solid	220	N/A	Plain	N/A			YAMAHA YW125 Zuma R Drum Model	09-15
MD987D VR987	F F	Solid Solid	260 260	N/A N/A	Plain Vee	N/A N/A			SUZUKI AN 650 K3 Burgman	03
MD988D VR988 4 Bolt type	R R	Solid Solid	250 250	N/A N/A	Plain Vee	N/A N/A			SUZUKI AN 650 K3 Burgman	03
MD989D	F	Solid	225	N/A	Plain	N/A			KYMCO People 50 2T People S 50/125 People 150 People S 200	02-12 05-09 07-12 05-10
MD990D	R	Solid	220	N/A	Plain	N/A			APRILIA Atlantic 500 Scarabeo 500/ie	03-05 03-14
MD994D VR994	F F	Solid Solid	260 260	N/A N/A	Plain Vee	N/A N/A			SUZUKI AN 400 Burgman AN 400 Z Burgman ABS AN 650 Burgman	03-16 14-21 04-12
MD996D	R	Solid	190	N/A	Plain	N/A			APRILIA SR 50 Factory Atlantic 200	04-15 04-06
MD998D VR998 5 Bolt type	R R	Solid Solid	250 250	N/A N/A	Plain Vee	N/A N/A			SUZUKI AN 650 Burgman AN 650 Burgman ABS AN 650 Burgman Executive ABS	04-12 13-16 13-21
MD9100D	F	Solid	260	N/A	Plain	N/A			KYMCO People S 150 People 250	21-23 03-08
MD9102D	F	Solid	267	N/A	Plain	N/A			YAMAHA YP 400	05-10/12-14

BRAKE ROTOR BUYERS GUIDE - STREET

Rotor No.	F/R	Type	Dia. (mm)	Hub Color	Profile	Bobbins	Left Bracket	Right Bracket	Model	Year
MD9103D	R	Solid	267	N/A	Plain	N/A			YAMAHA YP 400	05-10/12-14
MD9104D	R	Solid	240	N/A	Plain	N/A			YAMAHA XMAX 300	18-21
MD9107D	F	Solid	245	N/A	Plain	N/A			YAMAHA CP 250 V/W/X Morphus	06-08
MD9108D	R	Solid	245	N/A	Plain	N/A			YAMAHA CP 250 V/W/X Morphus	06-08
MD9109D	R	Solid	210	N/A	Plain	N/A			SUZUKI AN 400 Burgman AN 400 Z Burgman ABS	07-16 14-21
MD9112D	F	Solid	240	N/A	Plain	N/A			PIAGGIO MP3 250cc MP3 400ie Three wheeler MP3500 Three wheeler - 12" F/14" R Wheel	07-15 07-15 07-14
MD9115D	F	Solid	220	N/A	Plain	N/A			TGB/PEIRSPEED R 50 X Delivery 151 Laser R9/i 151cc	06-11 04-11 08-11
MD9115D	R	Solid	220	N/A	Plain	N/A			TGB/PEIRSPEED R 50 X	06-11
MD9116D	F	Solid	190	N/A	Plain	N/A			SYM Jet Euro X 50 Jet 50 Evo	99-11 14
MD9117D VR9117	F & R F & R	Solid Solid	240 240	N/A N/A	Plain Vee	N/A N/A			SUZUKI UH 200 Burgman ABS	14-16
MD9119D	F	Solid	256	N/A	Plain	N/A			HONDA NSS 300 Forza NSS 300 Forza ABS	14-16 18-21
MD9126D	F	Solid	190	N/A	Plain	N/A			PIAGGIO Typhoon 50/SE Typhoon 50 Typhoon 50 2T 10" wheels	06 07-08 07-09
VR9128	F	Floating	260	Black	Vee	5			KYMCO Downtown 200i Downtown 300i	11-12 10-15
MD9129D	R	Solid	240	N/A	Plain	N/A			KYMCO Downtown 200i Downtown 300i	11-12 10-15
VR9133	F	Solid	245	N/A	Vee	N/A			YAMAHA YW125 G Zuma Rear Disc Model Zuma 125 XC155 F/G S-Max	16-21 21-22 15-16
MD9134D	F	Solid	190	N/A	Plain	N/A			HONDA PCX 125 PCX 150 WW	11 13-23
MD9139D	R	Solid	240	N/A	Plain	N/A			HONDA NSS 300 Forza NSS 300 Forza ABS	14-16 14-16
MD9143D MD9143C	R R	Solid Solid	282 282	N/A N/A	Plain Contour	N/A N/A			YAMAHA XP500 F/G T-Max 530cc	15-16

BRAKE ROTOR BUYERS GUIDE - STREET

Rotor No.	F/R	Type	Dia. (mm)	Hub Color	Profile	Bobbins	Left Bracket	Right Bracket	Model	Year
MD9144D VR9144BLK	F F	Floating Floating	260 260	Black Black	Plain Vee	5 5			SUZUKI AN 650 Burgman ABS AN 650 Burgman Executive ABS	13-16 13-21
VR9145	F	Solid	267	N/A	Plain	N/A			YAMAHA XC155 F/G S-Max	15-16
MD9150D VR9150	R R	Solid Solid	200 200	N/A N/A	Plain Vee	N/A N/A			YAMAHA YW125 G Zuma R Disc Model	16-21
MD9155D VR9155	R R	Solid Solid	240 240	N/A N/A	Plain Vee	N/A N/A			PIAGGIO BV 300 Tourer	10-12
MD9158D	F	Solid	258	N/A	Plain	N/A			PIAGGIO MP3 500 Three wheeler - 13" F/14" R Wheel	15-16
VR9159	F	Solid	180	N/A	Vee	N/A			YAMAHA Zuma 50 F Twin Headlights F 4T YW Zuma 50 FX Single Headlight 4T YW	12-16 14-21
MD9162D VR9162	F F	Solid Solid	205 205	N/A N/A	Plain Vee	N/A N/A			GOGORO SmartScooter	15-17
MD9163D VR9163	R R	Solid Solid	162 162	N/A N/A	Plain Vee	N/A N/A			GOGORO SmartScooter	15-17
MD9164D VR9164	R R	Solid Solid	240 240	N/A N/A	Plain Vee	N/A N/A			PIAGGIO BV 350 4T/4V/330cc	12-14
MD9168D	R	Solid	245	N/A	Plain	N/A			YAMAHA XMAX 300 CZD300	18-21
MD9169D	F	Solid	267	N/A	Plain	N/A			YAMAHA XMAX 300 CZD300	18-21
MD9174D									KYMCO AK 550	17-21
MD9172D VR9172	F F	Solid Solid	300 300	N/A N/A	Plain Vee	N/A N/A			PIAGGIO BV 300 Tourer BV 350 4T/4V/330cc	10-12 12-14
MD9176D	F & R	Solid	240	N/A	Plain	N/A			SUZUKI UH 200 AL4/AL5/AL6 Burgman ABS	14-22
MD9177D	F	Solid	220	N/A	Plain	N/A			HONDA PCX 125 ABS Model PCX 150 ABS Model	18-21 18-21
MD9182D	F & R	Solid	270	N/A	Plain	N/A			BMW C 600 Sport Scooter K18C C 650 GT Scooter K19C C 650 GT Special Edition Scooter C 650 Sport Scooter	12-15 12-21 15 16-21
MD9183D	F	Solid	180	N/A	Plain	N/A			OHVALE GP-O 110 160	19-20
MD1001	F & R	Solid	276	N/A	Plain	N/A			HONDA CBR 1000 F Hurricane GB 500 CBR 600 F Hurricane CBR 600 F2 CB 650 SC Nighthawk CB 700 SC/S Nighthawk VF 700 F Interceptor VFR 700 F/F2 Interceptor VF 700 S Sabre VF 750 V45 Interceptor	87-88 89-90 87-90 91-94 83-85 84-86 84-85 86-87 84-85 83-84

BRAKE ROTOR BUYERS GUIDE - STREET

Rotor No.	F/R	Type	Dia. (mm)	Hub Color	Profile	Bobbins	Left Bracket	Right Bracket	Model	Year
MD1001 Contd.	F & R	Solid	276	N/A	Plain	N/A			VFR 750 F Interceptor VF 750 S Sabre PC 800 Pacific Coast VF 1000 F Interceptor VF 1100 S V65 Sabre CB 1100 F Supersport	86 82-83 89-90/94-98 84 84-85 83
MD1002	R	Solid	220	N/A	Plain	N/A			HONDA CBR 600 F Hurricane	87-90
MD1003X MD1003XC VR1003BLK VR1003BLU VR1003RED (Check bolt PCD with 1014LS/RS)	F F F F F	Floating Floating Floating Floating Floating	296 296 296 296 296	Gold Gold Black Blue Red	Plain Contour Vee Vee Vee	6 6 6 6 6			HONDA CBR 600 F3/SJR/SE VFR 750 F VFR 800 Fi-W CBR 900 RR Fireblade Hub bolt PCD 74mm VTR 1000 F Superhawk MORIWAKI/HONDA MD 250 H MD 250 S	95-98 94-97 98-99 95-97 98-05 08-13 08-11
MD1004 MD1004C VR1004	R R R	Solid Solid Solid	220 220 220	N/A N/A N/A	Plain Contour Vee	N/A N/A N/A			HONDA CBR 250 R Non ABS Models NSS 250/250 A/A5 Reflex 599 CB 600 F CBR 600 F2 CBR 600 F3/SJR/SE CBR 600 F4 CBR 600 F4i Sport CBR 600 RR CBR 900 RR Fireblade CBR 929 RR 929cc model CBR 954 RR CBR 1000 RR CBR 1000 RR SP Brembo F calipers CBR 1000 RA/RAA VTR 1000 F Super Hawk RVT 1000 R RC5I	11-14 01-07 04-07 91-94 95-98 99-03 01-06 03-23 93-00 00-01 02-03 04-14 14-20 09-20 98-05 00-06
MD1006 MD1006C VR1006	R R R	Solid Solid Solid	256 256 256	N/A N/A N/A	Plain Contour Vee	N/A N/A N/A			HONDA VF 500 F Interceptor FSC 600/D Silverwing VFR 700 F/F2 Interceptor VFR 750 F Interceptor CBR 1000 F XL 1000 VA8 Varadero Canada CBR 1100 XX Blackbird	84-86 02-06 86-87 86 93-99 8 97-03
MD1007 MD1007C	R R	Solid Solid	256 256	N/A N/A	Plain Contour	N/A N/A			HONDA VFR 750 F	90-98
MD1008	F	Solid	296	N/A	Plain	N/A			HONDA NT 700 V/VA ABS VFR 750 F CBR 1000 F Hurricane CBR 1000 F ST 1100 A	10-13 90-93 87-88 90-91/93-99 96-02
MD1010LS MD1010RS	F F	Floating Floating	310 310	Silver Silver	Plain Plain	6 6			HONDA VFR 750 R RC 30	90
MD1011	R	Solid	220	N/A	Plain	N/A			HONDA VFR 750 R RC 30	90
MD1012LS MD1012RS	F F	Floating Floating	310 310	Silver Silver	Plain Plain	6 6			HONDA RVF 750 R RC45	94-95
MD1013	R	Solid	220	N/A	Plain	N/A			HONDA RVF 750 R RC45	94-95

BRAKE ROTOR BUYERS GUIDE - STREET

Rotor No.	F/R	Type	Dia. (mm)	Hub Color	Profile	Bobbins	Left Bracket	Right Bracket	Model	Year
MD1014X MD1014XC VR1014BLK VR1014BLU VR1014RED (Check bolt PCD with MD1003LS/RS)	F F F F F	Floating Floating Floating Floating Floating	296 296 296 296 296	Gold Gold Black Blue Red	Plain Contour Vee Vee Vee	6 6 6 6 6			HONDA CBR 600 F4 CBR 900 RR Fireblade Hub bolt PCD 78mm VFR 800 Fi/Interceptor XL 1000 VA8 Varadero Canada GL 1500 Valkyrie All models GL1800/1800 A ABS Goldwing All models	99-00 93-94 98-05 8 97-03 01-17
MD1016	R	Solid	276	N/A	Plain	N/A			HONDA NT 700 V/VA ABS CB 1000 CBR 1000 F VT 1100 C2 American Classic Edition/C2-2/C3 VT 1100 C2 Shadow American Classic Tourer VT 1100 C2 Shadow Sabre	10-13 94-95 90-91 95-02 98-02 00-07
MD1020 MD1020C VR1020	R R R	Solid Solid Solid	240 240 240	N/A N/A N/A	Plain Contour Vee	N/A N/A N/A			HONDA CB-1 CB 400 F CB 900 F 919	89-90 02-07
MD1021LS MD1021RS (Original Disc is solid)	F F	Floating Floating	316 316	Silver Silver	Plain Plain	6 6			HONDA NT 650 Hawk GT CB 750 Nighthawk VF 750 C Magna/Magna Delux CD/C2 ST 1100 ST 1100 A	88-91 91-03 94-03 91-02 95
MD1022	R	Solid	240	N/A	Plain	N/A			HONDA NT 650 Hawk GT	88-91
MD1030	F	Solid	240	N/A	Plain	N/A			HONDA CMX 250 C Rebel CMX 250 C/CD Rebel CMX 250 C2 CMX 250 X Rebel	96/97/99-14 85-87 99-00 15
MD1036LS MD1036RS VMD1036	F F F	Floater Floater Floater	276 276 276	Silver Silver Black	Plain Plain Plain	6 6 6			HONDA CB 250 N/T CM 250 T CB 400 T Hawk CM 400 A/T CM 400 C Custom CB 450 T Hawk CB 450 SC Nighthawk CM 450 C Custom CM 450 A Hondamatic CB 650 CB 650 C Custom CB 650 SC Nighthawk CB 750 C Custom CB 750 F Supersport CB 750 SC Nighthawk CB 900 C Custom CB 900 F Supersport CBX GL 1000 Goldwing GL 1100/1100 I Goldwing GL 1100/1100 I Goldwing/Interstate	80-81 79-81 81 82 82 82 82 79-81 80-81 82 81-82 79-82 82-83 80-82 81-82 79-80 79 80 81-83
MD1038RS	F	Floating	310	Gold	Plain	6			HONDA CB-1 CB 400F	89-90
MD1040LS MD1040RS	F F	Solid Solid	276 276	N/A N/A	Plain Plain	N/A N/A			HONDA CB 450 SC Nighthawk CM 450 A Hondamatic GL 650 Silverwing/GL 650 Silverwing Interstate VF 700 C Magna VT 700 C Shadow VF 750 C V45 Magna	83-86 83 83 84-86 84-85 82-83

BRAKE ROTOR BUYERS GUIDE - STREET

Rotor No.	F/R	Type	Dia. (mm)	Hub Color	Profile	Bobbins	Left Bracket	Right Bracket	Model	Year
MD1040LS MD1040RS Contd.	F F	Solid Solid	276 276	N/A N/A	Plain Plain	N/A N/A			VT 750 C Shadow CB 1000 C Custom VF 1100 C V65 Magna VT 1100 C Shadow	83 83 83-86 85-86
MD1041LS	F	Solid	276	N/A	Plain	N/A			HONDA CMX 450 C Rebel	86-87
MD1047LS	F	Solid	296	N/A	Plain	N/A			HONDA VT 500 FT Ascot VT 500 C Shadow VF 500 C V30 Magna CB 550 SC 'Nighthawk' VLX 600 Shadow VT 600 C/CD VT 600 C/CD/C2D Shadow VLX/Deluxe CX 650 C Custom VT 700 C Shadow VT 800 C Shadow	83-84 83-86 84-85 83 88-93 94-07 83 86-87 88
MD1048	R	Floating	276	Silver	Plain	9			HONDA FT 500 Ascot	82-83
MD1052LS MD1052RS VMD1052	F F F	Floating Floating Floating	296 296 296	Gold Gold Black	Plain Plain Plain	9 9 9			HONDA CB 750 C Custom CB 750 L "Ltd Edition" CB 750 K	80 79 79-82
MD1056	F	Floating	310	Silver	Plain	9			HONDA CB 1000	94-95
MD1059LS	F	Solid	316	N/A	Plain	N/A			HONDA VF 700 C Magna VF 750 C V45 Magna	87 88
MD1062LS VMD1062	F F	Floating Floating	296 296	Silver Black	Plain Plain	9 9			HONDA CB 750 F 'Supersport' CB 750 76/K7	75-76 76-78
MD1064	R	Floating	296	Silver	Plain	9			HONDA CB 750 F 'Supersport' GL 1000 Goldwing All models	75-78 75-79
MD1068	R	Solid	296	N/A	Plain	N/A			HONDA VF 700 F Interceptor VF 750 V 45 Interceptor CB 1100 F Supersport	84 83-84 83
MD1071	R	Floating	296	Natural	Plain	9			HONDA CB 750 F Supersport CB 900 C Custom CBX GL 1100/1100 I Goldwing GL 1100/1100 I Goldwing/Interstate	79-80 80-81 79-80 80 81
MD1074LS MD1074RS	F F	Floating Floating	276 276	Gold Gold	Plain Plain	9 9			HONDA GL 1000 K/76/L Goldwing	75-77
MD1077	R	Solid	316	N/A	Plain	N/A			HONDA ST 1100 ST 1100 A GL 1500 'Valkyrie'/CT Tourer GL 1500/1500SE/A/I Goldwing	91-02 95 97-99 90-00
MD1078	R	Solid	296	N/A	Plain	N/A			HONDA CB 1000 C Custom VF 1100 C V65 Magna	83 83-86
MD1079	R	Solid	276	N/A	Plain	N/A			HONDA VF 700 F Interceptor	85

BUYERS GUIDE
BRAKE ROTORS

BRAKE ROTOR BUYERS GUIDE - STREET

Rotor No.	F/R	Type	Dia. (mm)	Hub Color	Profile	Bobbins	Left Bracket	Right Bracket	Model	Year
MD1079 Contd.	R	Solid	276	N/A	Plain	N/A			VF 1000 Interceptor VF 1100 S V65 Sabre	84 84-85
MD1080RS	F	Floating	336	Silver	Plain	9			HONDA VT 1100 C Shadow/Shadow Spirit	87-94
MD1082	R	Floating	296	Silver	Plain	9			HONDA CB 750 F Supersport CB 900 C Custom CB 900 F Supersport CBX GL 1100/1100 I Goldwing/Interstate GL 1100 A Goldwing Aspencade GL 1200 All models	81-82 82 81-82 81-82 82-83 82-83 84-87
MD1083LS MD1083RS	F F	Floating Floating	276 276	Silver Silver	Plain Plain	9 9			HONDA GL 1200/1200I/1200 A Goldwing 5mm rotor	84-85
MD1101	F	Solid	316	N/A	Plain	N/A			HONDA Venox 250	00-07
MD1120X MD1120XC VR1120BLK VR1120BLU VR1120RED	F F F F F	Floating Floating Floating Floating Floating	310 310 310 310 310	Gold Gold Black Blue Red	Plain Contour Vee Vee Vee	6 6 6 6 6			HONDA CBR 1100 XX Blackbird	97-98
MD1125 Billet	F	Floating	276	Silver	Plain	9			HONDA GL 1200 L/1200 I/1200 A/GL 12SE-i Goldwing 10mm rotor	85-87
MD1126 Billet	F	Solid	296	N/A	Plain	N/A			HONDA GL 1500 Goldwing All models GL 1500 SE/A/I/Goldwing	88-89 90-00
MD1127 Billet	R	Solid	296	N/A	Plain	N/A			HONDA GL 1500 Goldwing All models	88-89
MD1131LS	F	Floating	296	Silver	Plain	9			HONDA FT 500 Ascot	82-83
MD1133 Billet	F	Floating	296	Gold	Plain	9			HONDA GL 1100 A Goldwing Aspencade	82-83
MD1134X MD1134XC VR1134BLK VR1134BLU VR1134RED	F F F F F	Floating Floating Floating Floating Floating	310 310 310 310 310	Gold Gold Black Blue Red	Plain Contour Vee Vee Vee	6 6 6 6 6			HONDA CBR 900 RR Fireblade	98-99
MD1135	R	Solid	296	N/A	Plain	N/A			HONDA ST 1100 A	96-02
MD1136X MD1136XC VR1136BLK VR1136BLU VR1136RED	F F F F F	Floating Floating Floating Floating Floating	310 310 310 310 310	Gold Gold Black Blue Red	Plain Contour Vee Vee Vee	6 6 6 6 6			HONDA CBR 1100 XX Blackbird	99-03
MD1137X MD1137XC VR1137BLK VR1137BLU VR1137RED	F F F F F	Floating Floating Floating Floating Floating	330 330 330 330 330	Gold Gold Black Blue Red	Plain Contour Vee Vee Vee	6 6 6 6 6			HONDA CBR 929 RR 929cc model CBR 954 RR 954cc	00-01 02-03
MD1139 MD1139C	F F	Floating Floating	296 296	Gold Gold	Plain Contour	9 9			HONDA 599 CB 600 F	04-06

BRAKE ROTOR BUYERS GUIDE - STREET

Rotor No.	F/R	Type	Dia. (mm)	Hub Color	Profile	Bobbins	Left Bracket	Right Bracket	Model	Year
MD1141X MD1141XC VR1141BLK VR1141BLU VR1141RED	F F F F F	Floating Floating Floating Floating Floating	296 296 296 296 296	Gold Gold Black Blue Red	Plain Contour Vee Vee Vee	6 6 6 6 6			HONDA CBR 600 Sport F4i 919 CB 900 F VTX 1800 R VTX 1800 S VTX 1800 C/C1/C2/C3 VTX 1800 F1/F2/F3 VTX 1800 N1/N2/N3 VTX 1800 T1/T2	01-06 02-07 02-08 02-07 02-08 05-11 04-11 07-11
MD1146	F	Solid	276	N/A	Plain	N/A			HONDA VF 1000 R	85-86
MD1148	R	Solid	316	N/A	Plain	N/A			HONDA GL 1500 CF/CD Valkyrie All models VTX 1800 C/C1/C2/C3 VTX 1800 R VTX 1800 S VTX 1800 F1/F2/F3 VTX 1800 N1/N2/N3 VTX 1800 T1/T2	00-02 02-08 02-08 02-07 05-11 04-11 07-11
MD1149 MD1149C	R R	Solid Solid	240 240	N/A N/A	Plain Contour	N/A N/A			HONDA NSS 300 Forza FSC 600 Silverwing All models	18-21 02-14
MD1151	R	Solid	220	N/A	Plain	N/A			HONDA CBR 125 R	04-16
MD1152X MD1152XC VR1152BLK VR1152BLU VR1152RED	F F F F F	Floating Floating Floating Floating Floating	310 310 310 310 310	Gold Gold Black Blue Red	Plain Contour Vee Vee Vee	6 6 6 6 6			HONDA CBR 600 RR CBR 600 RRA CB 1000 R	03-22 09-21 10-16
MD1153X MD1153XC VR1153BLK VR1153BLU VR1153RED	F F F F F	Floating Floating Floating Floating Floating	310 310 310 310 310	Gold Gold Black Blue Red	Plain Contour Vee Vee Vee	6 6 6 6 6			HONDA CBR 1000 RR	04-05
MD1154X MD1154XC	F F	Floating Floating	310 310	Gold Gold	Plain Contour	6 6			HONDA ST 1300/1300 A	02-13
MD1156	R	Solid	240	N/A	Plain	N/A			HONDA CB 500 F CB 500 FA CB 500 X CB 500 XA CBR 500 R CBR 500 RA CB 650 F CB 650 FA CB 650 R CB 650 R ABS CBR 650 F CBR 650 FA CBR 650 R CBR 650 RA CBF 1000 A8	13-20 13-22 13-20 13-23 13-20 13-23 14-16 14-18 19-24 19-24 14-16 14-18 19-24 19-24 19-24 08-11
MD1157X MD1157XC	F F	Floating Floating	296 296	Gold Gold	Plain Contour	6 6			HONDA VFR 800 A/Interceptor ABS GL 1800/1800 ABS All models	02-11 01-17
MD1158RS	F	Floating	336	Gold	Plain	9			HONDA VTX 1300 S	03-07

BRAKE ROTOR BUYERS GUIDE - STREET

Rotor No.	F/R	Type	Dia. (mm)	Hub Color	Profile	Bobbins	Left Bracket	Right Bracket	Model	Year
MD1159	F & R	Solid	296	N/A	Plain	N/A			HONDA VT 750 C2/C2F Shadow Spirit VT 750 RS Shadow VT 750 Shadow Phantom VT 750 Shadow Aero VT 750 C/CD/CD2 Shadow/Shadow Deluxe VT 750 CDA/CDB/CDC/CDD Shadow American Classic Edition 750 Deluxe VT 1300 CXA Fury Non ABS Model VT 1300 CXAA Fury ABS Model VT 1300 Sabre/Sabre ABS VT 1300 Stateline/Stateline ABS VT 1300 Interstate VTX 1300 S VTX 1300 C VTX 1300 R VTX 1300 T	07-12 10-13 10-12 08-12 98-02 02-05 10-21 10-22 10-13 10-13 10-13 03-07 04-11 05-11 08-11
MD1160	F	Floating	296	Silver	Plain	9			HONDA CBF 1000 A8 Canada	08
MD1161X MD1161XC VR1161BLK VR1161BLU VR1161RED	F F F F F	Floating Floating Floating Floating Floating	320 320 320 320 320	Gold Gold Black Blue Red	Plain Contour Vee Vee Vee	6 6 6 6 6			HONDA CBR 1000 RR RVT 1000 R RC5I	06-08 00-06
MD1163 (MILD STEEL ROTOR USE ORGANIC PADS ONLY)	R	Solid	316	N/A	Plain	N/A			HONDA ST 1300/1300 A	02-13
MD1164 MD1164C	R R	Solid Solid	256 256	N/A N/A	Plain Contour	N/A N/A			HONDA VFR 800 Interceptor VFR 800 A Interceptor ABS	00-10 02-10
MD1165 MD1165C	R R	Solid Solid	256 256	N/A N/A	Plain Contour	N/A N/A			HONDA VFR 800 Fi Interceptor	98-99
MD1166RS	F	Solid	276	N/A	Plain	N/A			HONDA CBR 125 R 5 Bolt F Disc / Canada	11-13
MD1167RS	F	Solid	330	N/A	Plain	N/A			HONDA VT 1100 C	95-07
MD1169C MD1169CF	F F	Solid Floating	220 220	N/A Gold	Contour Contour	N/A 6			HONDA NSF 100 R	06
MD1170C	R	Solid	160	N/A	Contour	N/A			HONDA NSF 100 R	06
MD1171X MD1171XC VR1171BLK VR1171BLU VR1171RED	F F F F F	Floating Floating Floating Floating Floating	320 320 320 320 320	Gold Gold Black Blue Red	Plain Contour Vee Vee Vee	5 5 5 5 5			HONDA CBR 1000 RR CBR 1000 RR SP Brembo F calipers CBR 1000 RA	08-14 14-20 09-20
MD1172LS	F	Solid	276	N/A	Plain	N/A			HONDA FSC 600 Silverwing All models	03-14
MD1173 MD1173C VR1173	R R R	Solid Solid Solid	220 220 220	N/A N/A N/A	Plain Contour Vee	N/A N/A N/A			HONDA CBR 600 RA ABS	09-16
MD1175	R	Solid	276	N/A	Plain	N/A			HONDA VFR 1200 FD Automatic Transmission Model VFR 1200 F Manual Gearbox Model	10-14 10-14
MD1176X	F	Floating	320	Gold	Plain	6			HONDA CBR 1000 RR Fireblade SP2 VFR 1200 FD Automatic Transmission Model VFR 1200 F Manual Gearbox Model	17-18 10-14 10-14

BRAKE ROTOR BUYERS GUIDE - STREET

Rotor No.	F/R	Type	Dia. (mm)	Hub Color	Profile	Bobbins	Left Bracket	Right Bracket	Model	Year
MD1177 MD1177C	R R	Solid Solid	256 256	N/A N/A	Plain Contour	N/A N/A			HONDA CB 1000 R	10-21
MD1179	F	Solid	316	N/A	Plain	N/A			HONDA VT 1100	95-07
MD1180X MD1180XC	F F	Floating Floating	296 296	Gold Gold	Plain Contour	6 6			HONDA CBR 250 R CBR 250 RA ABS CB 300 F CB 300 R ABS CBR 300 R CBR 300 RA ABS NSA DN-01	11-14 11-14 15-23 18-23 15 15-24 09-11
MD1181 MD1181C	R R	Solid Solid	220 220	N/A N/A	Plain Contour	N/A N/A			HONDA CBR 250 RA ABS Model CBR 300 RA ABS Model	11-14 15-24
MD1182RS	F	Solid	330	N/A	Plain	N/A			HONDA VTX 1300 C VTX 1300 R VTX 1300 T	04-11 05-11 08-11
MD1183 MD1183C VR1183 OSX1183	F F F F	Solid Solid Solid Floating	220 220 220 250	N/A N/A N/A Black	Plain Contour Vee Contour	N/A N/A N/A 6		BRK037	HONDA MSX 125 Grom Non ABS	14-20
MD1184 VR1184 MD1185C	R R R	Solid Solid Solid	190 190 240	N/A N/A N/A	Plain Vee Contour	N/A N/A N/A			HONDA MSX 125 Grom Non ABS MSX 125 AH Grom ABS HONDA NC 700 NM4	14-23 18-23 15-20
MD1186C	F	Solid	320	N/A	Contour	N/A			HONDA CTX 700 CTX 700 D CTX 700 N CTX 700 ND NC 700 X NC 700 XD PVT 1000 PVT 1000 RS Pursuer	14-17 14-19 14-16 14-19 12-17 12-17 17-18
MD1187C	F	Solid	320	N/A	Contour	N/A			HONDA CB 650 F ABS CBR 650 F ABS NC 700 NM4 ZERO DS ZF13.0 DS ZF6.0/ZF9.0 DS II ZF14.4 DS II ZF7.2 DSR ZF13.0 DSR ZF14.4.0 DSR Black Forest Edition - ZF14.4.0 FXS ZF3.3/ZF6.5 S ZF14.4 S ZF6.0 S ZF7.2 S ZF8.5/ZF11.4 S ZF9.4/ZF12.5 S ZF9.8/ZF13.0 SR ZF11.4 SR ZF12.5 SR ZF13.0 SR/F ZF13.0 SR/S ZF13.0 SR/S Deus X ZF13.0	18-20 14-20 15-20 16-19 10-12 19-21 19-22 17-19 19-22 19-21 17-21 19-21 10-12 19-22 13 15 16-19 14 15 16-21 19-21 19-21 21

BRAKE ROTOR BUYERS GUIDE - STREET

Rotor No.	F/R	Type	Dia. (mm)	Hub Color	Profile	Bobbins	Left Bracket	Right Bracket	Model	Year
MD1188X	F	Floating	310	Gold	Plain	6			HONDA VFR 800 F Interceptor VFR 800 FD Interceptor DLX ABS Model VFR 800 X Crossrunner ABS	14-21 14-21 17-21
MD1190	R	Solid	256	N/A	Plain	N/A			HONDA VFR 800 F Interceptor VFR 800 FD Interceptor DLX ABS Model VFR 800 X Crossrunner ABS	14-21 14-21 17-21
MD1191 MD1191C VR1191 OSX1191	F F F F	Solid Solid Solid Floating	220 220 220 250	N/A N/A N/A Floating	Plain Contour Vee Contour	N/A N/A N/A 5		BRK048	HONDA MSX 125 AH Grom ABS	18-24
MD1193X	F	Floating	310	Gold	Plain	6			HONDA CB 1000 R ABS	17-20
MD1194X	F	Floating	310	Gold	Plain	6			HONDA CB 650 R CB 650 RA ABS CBR 650 R CBR 650 RA ABS	19-21 19-24 19-21 19-24
MD1195	R	Solid	190	N/A	Plain	N/A			HONDA TRX 420 All Models TRX 500 All Models	14-19 14-19
MD1196	R	Solid	256	N/A	Plain	N/A			HONDA CRF 1000 Africa Twin CRF 1100 L Africa Twin Adventure Sport CRF 1100 L Africa Twin Adventure Sport Plus	16-19 20-24 20-24
MD1197 Fitting Kit Required	F	Solid	310	N/A	Plain	N/A			HONDA VFR 1200 X AC Crosstourer Manual G/Box VFR 1200 XD AC DCT Crosstourer VFR 1200 Crosstourer Highlander T/DCT	16-17 16-17 16-17
MD1198X	F	Floating	310	Gold	Plain	6			HONDA XL 750 Transalp CRF 1000 Africa Twin CRF 1000 Africa Twin DCT CRF 1000 Africa Twin Adventure Sport ES CRF 1000 Africa Twin Adventure Sport ES DCT	22-24 16-20 16-20 18-20 18-20
MD1199X	F	Floating	320	Gold	Plain	6			HONDA CBR 1000 RRA ABS Model Nissin Front Caliper CBR 1000 RR	17-20 18-21
MD1200C	F	Solid	320	N/A	Contour	N/A			HONDA CB 650 FA ABS CBR 650 FA ABS CB 500 FA ABS CB 500 XA ABS CBR 500 RA ABS	14-18 14-18 13-22 13-22 13-22
MD1201C	F	Solid	320	N/A	Contour	N/A			HONDA CB 650 FA ABS CBR 650 FA ABS	14-18 14-18
MD1202X	F	Floating	320	Gold	Plain	6			HONDA CBR 1000 RR SP	18-24
MD1203	Rear	Solid	256	N/A	Plain	N/A			HONDA CB 1100 AD CB 1100 AE CB 1100 EX	13 14 14-21

BRAKE ROTOR BUYERS GUIDE - STREET

Rotor No.	F/R	Type	Dia. (mm)	Hub Color	Profile	Bobbins	Left Bracket	Right Bracket	Model	Year
MD1205	REAR								HONDA CBR 1000 RR SP	19-24
MD1206X MD1206XC	Front	Floating	310						HONDA CRF 1100 Africa Twin Inc DCT CRF 1100 Africa Twin Adventure Sports Inc DCT	20-24 20-24
MD1207D									HONDA Four Trax 460 Four Trax 680	22-24 22-24
MD1208D	Front								HONDA PCX 125	22-24
MD1209D	Front								HONDA SH 125i Mode FSH125M	21-24
MD1210	Front								HONDA CB 125R CB 300R CB 500F CB 750 Hornet CBR 500R	18-24 18-24 22-24 22-24 22-24
MD2001X MD2001XC VR2001BLK VR2001BLU VR2001RED	F F F F F	Floating Floating Floating Floating Floating	299 299 299 299 299	Gold Gold Black Blue Red	Plain Contour Vee Vee Vee	6 6 6 6 6			APRILIA RST 1000 Futura DUCATI 900 Supersport 907 IE YAMAHA FZR 400 RRSP/RR FZR 600 W/WC FZR 600 YZF 600 TDM 850 D/DC/E/EC FJ 1200	01-05 89-90 90-91 91-92 89 90-00 95-96 92-93 89-92
MD2002 MD2002C VR2002	R R R	Solid Solid Solid	245 245 245	Gold Gold Gold	Plain Contour Vee	N/A N/A N/A			DUCATI Scrambler Sixty 2 Cast wheels/399cc Supersport 400 Single disc Supersport 400 Twin disc 400 Monster Monster 400 Single disc Monster 400 Twin disc 400 Monster Japan Monster Dark ie 400 Japan Monster Dark ie 400 Single disc Monster 400 ie Japan Monster 600 Twin disc 600 Monster Single disc 600 Monster Dark 600 Monster City/City Dark 600 Monster 600 Supersport Single disc 620 IE Monster 620 ie Monster Series 1 - Twin Pin Pad Fixing Caliper 620 ie Monster Series 2 - Single Pin Pad Fixing Caliper 620 Sport Monster 620 Dark Monster 620 620 Multistrada Twin Disc/Single Pin Pad Fixing 620 Multistrada Dark Single Disc/Twin Pin Pad Fixing 695 Monster 696 Monster M 696 Monster 20th Anniversary Model 748 SP/Monoposto 750 Supersport Single disc Supersport 750 Twin disc 750 Supersport	16-19 93-97 93-97 95-97 00-02 03-04 00-04 05-06 05 07-08 93-97 93-99 98-99 99 00-01 91-97 02-04 05 05-06 03 03-04 05-06 06 06 06-09 08-14 13-14 99-02 91-98 91-98 99

BUYERS GUIDE
BRAKE ROTORS

BRAKE ROTOR BUYERS GUIDE - STREET

Rotor No.	F/R	Type	Dia. (mm)	Hub Color	Profile	Bobbins	Left Bracket	Right Bracket	Model	Year
MD2002	R	Solid	245	Gold	Plain	N/A			DUCATI	
MD2002C	R	Solid	245	Gold	Contour	N/A			750 Supersport IE	00-02
VR2002	R	Solid	245	Gold	Vee	N/A			750 Sport	01-02
Contd.									750 Monster Single disc	96-97
									750 Monster Twin disc	96-98
									750 Monster City/City Dark	99
									750 Monster/Monster Dark	99
									750 Monster	00-01
									Monster ie 750	02
									Monster 797 /+	17-21
									Monster 800	03-04
									800 Sport	03
									800 Supersport	03-05
									Scrambler Classic Spoke Wheels/803cc	15-19
									Scrambler Icon Cast Wheels/803cc	15-19
									Scrambler Urban Enduro Spoke Wheels/803cc	15-19
									Scrambler Full Throttle Cast Wheels/803cc	15-19
									Scrambler Flat Track Pro Cast wheels/803cc	16-17
									Scrambler Café Racer Cast wheels/803cc	17
									Monster 821	15-21
									Monster 821 Dark	15
									Monster 821 Stealth	20-21
									Monster 821 Stripe	15-19
									851 Superbike Biposto	89-92
									888 SP4/SP5	92-93
									888 Superbike Strada	94-95
									899 Panigale	14
									900 Supersport	89-90
									900 Supersport/Superlight	91-97
									900 Supersport	98-99
									900 Supersport CR USA	98
									900 Supersport FE	98
									900 Supersport IE	00-01
									900 Sport	02
									900 Monster	93-99
									900 Monster Cromo/Special	98
									900 Monster City/City Dark	99
									900 IE Monster	00-01
									907 IE	90-93
									Monster S4 Foggy916cc	02
									Monster S4 916cc	01-02
									ST4 916cc	99-02
									ST2 944cc	97-03
									ST3 S ABS Model 992cc	06-07
									ST4S Non ABS/996cc	01-05
									ST4S ABS Model/996cc	03-05
									959 Panigale ABS	16-19
									Monster 1000 Dark	03
									Monster 1000 ie 992cc	04-05
									Monster 1000 S ie 992cc	03-05
									Paul Smart 1000 LE 992cc	06
									Sport 1000 S	07-09
									Sport Classic 1000 992cc Monoposto - Japan/Biposto - Europe	06-08
									Supersport 1000 DS 992cc	03-06
									Scrambler 1100	18-21
									Scrambler 1100 Sport	18-21
									Scrambler 1100 Special	18-21
									Scrambler 1100 Pro/Sport Pro	18-21
									LAVERDA	
									All models	94-00
									YAMAHA	
									XJ 400 S Seca II	93
									FZ 600 S/SC/T/TC/U/UC	86-88
									FZR 600 W/WC	89
									FZR 600	90-00
									YZF 600	95-96
									YZF 600	97-07
									SRX 600 S/SC	86
									XJ 600 Seca	92-98

BRAKE ROTOR BUYERS GUIDE - STREET

Rotor No.	F/R	Type	Dia. (mm)	Hub Color	Profile	Bobbins	Left Bracket	Right Bracket	Model	Year
MD2002	R	Solid	245	Gold	Plain	N/A			YAMAHA	
MD2002C	R	Solid	245	Gold	Contour	N/A			YZF 750 R/SP	93-96
VR2002	R	Solid	245	Gold	Vee	N/A			YZF 750 R7 0W02 Road version	99
Contd.									TDM 850 D/DC/E/EC	92-93
									YZF 1000 R RJ	97
									YZF 1000 R1	98-00
MD2003X	F	Floating	320	Gold	Plain	6			APRILIA	
MD2003XC	F	Floating	320	Gold	Contour	6			RSV4 R	09-12
VR2003BLK	F	Floating	320	Black	Vee	6			RSV4 Factory	09-12
VR2003BLU	F	Floating	320	Blue	Vee	6			RSV4 Factory APRC ABS	13-15
VR2003RED	F	Floating	320	Red	Vee	6			RS 660 8V	20-24
									RS 660 8V Tuono	20-24
									Shiver 900	18-22
									Dorsoduro 900	18-22
									BENELLI	
									302 S	22-23
									TRK 502 X	22-23
									TRK 702 X	22-23
									DUCATI	
									Supersport 400 Single disc	93-97
									Supersport 400 Twin disc	93-97
									400 Monster	95-97
									Monster 600 Twin disc	93-97
									600 Monster Dark	98-99
									600 Monster Single disc	93-99
									600 Supersport Single disc	91-97
									Monster 620 Dark	03-04
									620 Multistrada Dark Single Disc/Twin Pin Pad Fixing	06
									748 Biposto	95-98
									748 SP	98
									750 Supersport Single disc	91-98
									Supersport 750 Twin disc	91-98
									750 Supersport	99
									750 Monster Single disc	96-97
									750 Monster Twin disc	96-98
									750 Monster City/City Dark	99
									750 Monster/Monster Dark	99
									851 Superbike Biposto	89-92
									888 Superbike Strada	94-95
									900 Supersport/Superlight	91-97
									900 Supersport	98-99
									900 Supersport CR USA	98
									900 Supersport FE	98
									900 Monster	93-99
									900 Monster Cromo/Special	98
									900 Monster City/City Dark	99
									907 IE	92-93
									916 Biposto	94-96
									ST2 944cc	97-99
									LAVERDA	
									650 Sport Formula	94-95
									668 Diamante/Ghost/Strike	96-98
									750 Strike Bifaro/Mono	98-00
									750 S Formula/Sport	98-00
									750 S Carenata	98-00
									MOTO GUZZI	
									Breva 1100	02-07
									Griso 1200 8V	09-12
									Griso SE 1200 8V	09-19
									Norge 1200 GT 8V	10-19
									Stelvio 1200 NTX	09-19
									California 1400 Custom	13-19
									California 1400 Touring	13-19
									YAMAHA	
									FZR 750 Genesis RU/RT	87-88
									YZF 750 R/SP	93-96
									FZR 1000 Genesis T/TC/U/UC/W/WC	87-89
									FZR 1000 EX UP A/AC/B/BC/D/DC/E/EC/F/FC/G/GC	90-96

BRAKE ROTOR BUYERS GUIDE - STREET

Rotor No.	F/R	Type	Dia. (mm)	Hub Color	Profile	Bobbins	Left Bracket	Right Bracket	Model	Year
MD2008	R	Solid	210	N/A	Plain	N/A			YAMAHA FZR 750 OW01	89-92
MD2009LS MD2009RS	F F	Floating Floating	320 320	Silver Silver	Plain Plain	9 9			YAMAHA FZR 750 OW01	89-92
MD2011 MD2011C VR2011	F F F	Solid Solid Solid	267 267 267	N/A N/A N/A	Plain Contour Vee	N/A N/A N/A			YAMAHA SRX 250 T/TC RX 350 L/N/NC11 XS 400 RJ/RK XZ 550 RK FJ 600 L/LC/N/NC FZ 600 S/SC/T/TC/U/UC YX 600 Radian SRX 600 S/SC XJ 650 LK Seca/LJ Seca Turbo FZ 700 T/TC Genesis FZX 700 S/SC/T/TC Fazer XJ 700 XV 700 XV 750 Virago XV 1100 All models	87 84-85 82-83 83 84-85 86-88 86-90 86 82-83 87 86-87 85-86 84-87 88-94 86-97
MD2011	R R								YAMAHA RX 350 L/N/NC11 XP 500 Y/Z/A T-Max FJ 600 L/LC/N/NC FZ 700 T/TC Genesis FZR 750 Genesis RU/RT FZR 1000 Genesis FZR 1000 EX UP FZS 1000 'FZ1'	84-85 09-11 84-85 87 87-88 87-89 90-96 01-05
MD2019LS MD2019RS	F F	Floating Floating	266 266	Silver Silver	Plain Plain	9 9			YAMAHA XV 250 U/UC/W/WC/A/AC XS 400 SG/SH XS 400 J/K Maxim XJ 650 RJ Seca XJ 750 J/K/MK Maxim XV 920 RH/RJ XV 920 J Virago	88-90 80-81 82-83 82 82 81-82 82
MD2020LS MD2020RS	F F	Floating Floating	282 282	Gold Gold	Plain Plain	9 9			YAMAHA FZR 400 U/SUC/W/SWC	88-89
MD2021 MD2021C VR2021	R R R	Solid Solid Solid	210 210 210	N/A N/A N/A	Plain Contour Vee	N/A N/A N/A			YAMAHA TZ 250 FZR 400 U/SUC/W/SWC FZR 400 A FZR 400 RRSP/RR	91 88-89 90 91-92
MD2022LS MD2022RS	F F	Floating Floating	282 282	Gold Gold	Plain Plain	9 9			YAMAHA FZR 400 A	90
MD2023LS MD2023RS VMD2023	F F F	Floating Floating Floating	299 299 299	Silver Silver Black	Plain Plain Plain	9 9 9			YAMAHA XV 500 K Virago SR 500 E/F/G/H XV 535 Virago XJ 550 H/J/K Maxim XJ 550 RH/RJ/RK Seca XJ 650 G/H/J/K Maxim XS 650 SE/SF/SG XS 650 G/H/SH XS 650 SJ/SK Heritage Special XJ 750 RH/RJ/RK Seca XV 750 H/J/K/MK Virago	83 78-81 87-94 81-83 81-83 80-83 78-80 80-81 82-83 81-83 81-83

BRAKE ROTOR BUYERS GUIDE - STREET

Rotor No.	F/R	Type	Dia. (mm)	Hub Color	Profile	Bobbins	Left Bracket	Right Bracket	Model	Year
MD2024 VMD2024	F F	Floating Floating	299 299	Silver Black	Plain Plain	9 9			YAMAHA XS 500 C/D/E XS 650 D/E/F/2F XJ 650 LH Midnight XV 920 MK 'Virago' XV 920 K XJ 1100 J	76-78 77-79 81 83 83 82
MD2024 VMD2024 MD2024 VMD2024	R R R R	Floating Floating Floating Floating	298 298 298 298	Gold Black Gold Black	Plain Plain Plain Plain	9 9 9 9			YAMAHA XS 1100 E/F/G/H YAMAHA XS 1100 SF/SG/SH XS 1100 LG/LH Midnight Special XJ 1100 J XS 1100 E/F/G/H XS 1100 SF/SG/SH XS 1100 LG Midnight Special XS 1100 LH Midnight Special	78-81 79-81 80-81 82 78-81 79-81 80 81
MD2025LS MD2025RS VMD2025	F F F	Floating Floating Floating	266 266 266	Silver Silver Black	Plain Plain Plain	9 9 9			YAMAHA XS 750 D/2D/E/F/SE/SF XS 850 G/H XS 850 LG/LH/SG/SH	77-79 80-81 80-81
MD2025 VMD2025	R R	Floating Floating	266 266	Silver Black	Plain Plain	9 9			YAMAHA RD 400 F Daytona XS 650 SE/SF XS 750 SE/SF XS 750 D/E2/2D/E/F XS 850 G/H XS 1100 LH Midnight Special XS 500 C/D/E XS 850 LG/LH/SG/SH XS 1100 E/F/G/H XS 1100 SF/SG/SH XS 1100 LG Midnight Special XJ 1100 J	79 78-79 78-79 77-79 80-81 81 76-78 80-81 78-81 79-81 80 82
MD2031LS	F	Solid	320	N/A	Plain	N/A			XJ 400 'S' Seca II XJ 600 Seca	93 92-98
MD2046	F	Floating	299	Silver	Plain	9			YAMAHA FJ 1200 AD/ADC/AEE/AEC	92-93
MD2049	R	Floating	320	Gold	Plain	9			YAMAHA XVZ 13 D Series Venture Royale XVZ 13 T/T/C/U/UC Venture	86-93 87-88
MD2067	F	Solid	282	N/A	Plain	N/A			YAMAHA XV 250 Virago All models XV 250 V-Star XV 750 F/FC/G/GC/H/HC/J/JC Virago	95-07 08-14 94-97
MD2068 MD2068	F R	Solid Solid	280 280	N/A N/A	Plain Plain	N/A N/A			YAMAHA V-Max All models FJ 1100 L/LC/N/NC FJ 1200 S/SC/T/TC VMX 12 R/RC V-Max YAMAHA XV 1100 FJ 1100 FJ 1200 V-Max 'All models'	85-92 84-85 86-87 03 84-85 84-85 86-93 85-07
MD2069	R	Solid	267	N/A	Plain	N/A			YAMAHA FZ 750 N/S/SC/U/UC FZX 700 S/SC/T/TC Fazer XJ 900 RK Seca	85-88 86-87 83

BUYERS GUIDE
BRAKE ROTORS

BRAKE ROTOR BUYERS GUIDE - STREET

Rotor No.	F/R	Type	Dia. (mm)	Hub Color	Profile	Bobbins	Left Bracket	Right Bracket	Model	Year
MD2069	F	Solid	267	N/A	Plain	N/A			YAMAHA RZ 500 FZ 750 N/S/SC/U/UC XJ 900 RK Seca	84-86 85-88 83
MD2070	R	Solid	245	N/A	Plain	N/A			YAMAHA RZ 500	84-86
MD2074X MD2074XC VR2074BLK VR2074BLU VR2074RED	F F F F F	Floating Floating Floating Floating Floating	299 299 299 299 299	Gold Gold Black Blue Red	Plain Contour Vee Vee Vee	6 6 6 6 6			YAMAHA YZF 600 R YZF 600 R R6 XVS 950 Bolt C Spec Remote Reservoir Rear Shocks XVS 950 Bolt R Spec Remote Reservoir Rear Shocks FZS 1000 FZ1 YZF R1 YZF 1000 R RJ FZS 1000 R/RC FZ1 XVS 1100 ATS V-Star Silverado XVS 1100 AS V-Star Classic FJR 1300 R/RC XVS 1300 V-Star 1300 Tourer XVS 1300 V-Star XVS 1300 V-Star Deluxe XV 1700 Road Star S XV 1700 Road Star Silverado XV 1700 Road Star Midnight XV17 XV 1700 Road Star Midnight Warrior XV17 XV 1700 Road Star XV17 XV 1700 Road Star XV17 XV 1700 Road Star Midnight XV17 XV 1700 Road Star Midnight Silverado XV17 XV 1700 Road Star Warrior XV17 XV 1900 Roadliner XV 1900 Roadliner Midnight XV 1900 Roadliner S XV 1900 Stratoliner XV 1900 Stratoliner Midnight XV 1900 Stratoliner S XV 1900 Stratoliner Deluxe	97-07 99-02 15-21 14-21 01-05 98-03 97 03 04-09 04-09 03 07-14 07-14 13-14 08-14 11-14 05-06 05 05-06 04-09 04-07 04-07 04-05 06-07 06-09 06-14 06-09 06-08 06-14 11-14
MD2075	R	Solid	280	N/A	Plain	N/A			YAMAHA GTS 1000	93-96
MD2076	F	Solid	298	N/A	Plain	N/A			YAMAHA SR 400 XZ 500 RJ XV 535 Virago XVS 650 V Star Custom XVS 650 V Star Classic XVS 650 V-Star Silverado XVS 1100 V Star Custom XVS 1100 V-Star Silverado XVS 1100 W-M V-Star Custom Midnight XVZ 1300 Royal Star XVZ 1300 Royal Star Tour Classic XVZ 1300 Royal Star Standard XVZ 1300 Royal Star Boulevard XVZ 1300 Royal Star Midnight Venture XVZ 1300 Royal Star Midnight Tour Deluxe XVZ 1300 Royal Star Venture XVZ 1300 Royal Star Venture S XVZ 1300 Royal Star Tour Deluxe XVZ 1300 LTK Venture XVZ 1300 Venture MM Limited Edition XV 1600 Road Star XV 1600 Road Star Silverado XV 1600 Road Star Midnight XV 1600 Midnight Star XV 1700 Road Star Spoke wheels	15-20 82 95-99 97-11/13-14 98-10 03-Oct 99-07 03- 07-09 96-97/00 96-00 98 99-01 02-07 06-07 99-07 08-12 97-01/05-07 96-98 1 99-05 99-09 3 02-03 6

BUYERS GUIDE
BRAKE ROTORS

BRAKE ROTOR BUYERS GUIDE - STREET

Rotor No.	F/R	Type	Dia. (mm)	Hub Color	Profile	Bobbins	Left Bracket	Right Bracket	Model	Year
MD2076 Contd.	F	Solid	298	N/A	Plain	N/A			XV 1700 Road Star Silverado XV 1700 Road Star Silverado XV 1700 Road Star XV 1700 Road Star	07 08-10 08 05-07
MD2078	R	Solid	320	N/A	Plain	N/A			YAMAHA XVZ 1300 Royal Star XVZ 1300 Royal Star Tour Classic XVZ 1300 Royal Star Standard XVZ 1300 Royal Star Boulevard XVZ 1300 Royal Star Midnight Venture XVZ 1300 Royal Star Midnight Tour Deluxe XVZ 1300 Royal Star Venture XVZ 1300 Royal Star Venture S XVZ 1300 Royal Star Tour Deluxe XVZ 1300 LTK Venture XVZ 1300 Venture MM Limited Edition	96-97/00 96-00 98 99-01 02-07 06-07 99-07 08-12 97-01/05-07 96-98 01
MD2081	F	Solid	298	N/A	Plain	N/A			YAMAHA XVZ 12 Venture	83-84
MD2081	R	Solid	298	N/A	Plain	N/A			XVZ 12 Venture Royale	83-84
MD2082X MD2082XC VR2082BLK VR2082BLU	F F F F	Floating Floating Floating Floating	299 299 299 299	Gold Gold Black Blue	Plain Contour Vee Vee	6 6 6 6			YAMAHA YZF 600 RRR/RRS R6 FZ6 FZ6 4 piston caliper FZ6R FZ6R Y/Z/A YZF R6S YZFR 6 XV 1700 Road Star Midnight Warrior 5 Spoke Cast Wheel XV17 XV 1700 Road Star Warrior 5 Spoke Cast Wheel XV17 XV 1900 Raider XV 1900 Raider S XV 1900 Raider SCL	03-04 04-06 07-09 09-17 09-11 06-09 06-09 06-08 08-14 08-14 12-14
MD2083	F	Floating	320	Gold	Plain	9			YAMAHA YZF 750 R7 OW02 Road version	99-00
MD2084 MD2084C VR2084	R R R	Solid Solid Solid	220 220 220	N/A N/A N/A	Plain Contour Vee	N/A N/A N/A			YAMAHA YZF 600 'R6' YZF R1	99-02 02-03
MD2086 MD2086C VR2086	R R R	Solid Solid Solid	245 245 245	N/A N/A N/A	Plain Contour Vee	N/A N/A N/A			YAMAHA YZF 750 R7 YZF R1	99 98-01
MD2088	R	Solid	320	N/A	Plain	N/A			YAMAHA XV 1600 Road Star XV 1600 Road Star Silverado XV 1600 Road Star Midnight XV 1600 Midnight Star XV 1700 Road Star Silverado XV17 XV 1700 Road Star S XV17 XV 1700 Road Star Silverado XV17 XV 1700 Road Star XV17 XV 1700 Road Star Midnight XV17 XV 1700 Road Star XV17 XV 1700 Road Star XV17 XV 1700 Road Star Midnight XV17 XV 1700 Road Star Midnight Silverado XV17	99-05 99-09 03 02-03 07 08-14 08-14 05-08 05-06 05-06 04-07/09 04/07 04-07
MD2089X MD2089XC VR2089BLK VR2089BLU VR2089RED	F F F F F	Floating Floating Floating Floating Floating	320 320 320 320 320	Gold Gold Black Blue Red	Plain Contour Vee Vee Vee	6 6 6 6 6			YAMAHA XVS 950 V-Star 950 Inc. Tourer FJR 1300 FJR 1300 FJR 1300 A FJR 1300 Electric Shift FJR 1300 ES	09-14 04-05 06-12 13-18 06-09 14-22

BRAKE ROTOR BUYERS GUIDE - STREET

Rotor No.	F/R	Type	Dia. (mm)	Hub Color	Profile	Bobbins	Left Bracket	Right Bracket	Model	Year
MD2091	R	Solid	220	N/A	Plain	N/A			YAMAHA	
MD2091C	R	Solid	220	N/A	Contour	N/A			YZF 600 R6	03-04
VR2091	R	Solid	220	N/A	Vee	N/A			YZF-R1 5VY	04-06
									YZF-R1 6 piston caliper	07-14
									YZF-R6 310mm rotor	05-07
									YZF R6S	06-08
									YZF-R6	08-16
									YZF-R6 H 320mm Front Rotor	17-24
									MT 10 MTN 1000	18-24
									MT 10 SP MTN 1000D	22-24
MD2092	R	Solid	282	N/A	Plain	N/A			YAMAHA	
MD2092C	R	Solid	282	N/A	Contour	N/A			XVS 1100 V-Star Custom/Classic	99-09
VR2092	R	Solid	282	N/A	Vee	N/A			XVS 1100 V-Star Silverado	03-09
									XVS 1100 W-M V-Star Custom Midnight	07-09
									FJR 1300	03-05
									XV 1700 Road Star Midnight Warrior XV17	06-09
									XV 1700 Road Star Warrior XV17	06-08
									XV 1700 Road Star Midnight Warrior XV17	05
									XV 1700 Road Star Warrior XV17	04-05
MD2093	R	Solid	245	N/A	Plain	N/A			YAMAHA	
MD2093C	R	Solid	245	N/A	Contour	N/A			FZ6	04-06
VR2093	R	Solid	245	N/A	Vee	N/A			FZS 1000 FZ1	06-14
									FZ6	07-09
MD2094X	F	Floating	320	Gold	Plain	6			YAMAHA	
MD2094XC	F	Floating	320	Gold	Contour	6			YZF R1	04-06
VR2094BLK	F	Floating	320	Black	Vee	6				
VR2094BLU	F	Floating	320	Blue	Vee	6				
VR2094RED	F	Floating	320	Red	Vee	6				
MD2095X	F	Floating	310	Gold	Plain	6			YAMAHA	
MD2095XC	F	Floating	310	Gold	Contour	6			YZF-R6	05-06
VR2095BLK	F	Floating	310	Black	Vee	6			YZF-R6	05-07
VR2095BLU	F	Floating	310	Blue	Vee	6			FZ8	11-13
VR2095RED	F	Floating	310	Red	Vee	6			XT 1200 Z Super Tenere	12-18
									XT 1200 Z Super Tenere ES	14-23
MD2096	F	Solid	282	N/A	Plain	N/A			YAMAHA	
									XVZ 13 D Series Venture Royale	86-93
									XVZ 13 Venture	87-88
MD2097RS	F	Solid	245	N/A	Plain	N/A			YAMAHA	
									YBR 125 4P26	07-13
									YBR 125 4P28	07-13
MD2098	F	Floating	267	Gold	Plain	5			YAMAHA	
									XP500 T-Max 530cc	15-16
MD2099	R	Solid	320	N/A	Plain	N/A			YAMAHA	
									XV 1700 Road Star Warrior	02-05
									XV 1900 Roadliner	06-07
									XV 1900 Roadliner Midnight	06-09
									XV 1900 Roadliner S	06-10/12-14
									XV 1900 Stratoliner	06-09
									XV 1900 Stratoliner Midnight	06-08
									XV 1900 Stratoliner S	06-14
									XV 1900 Stratoliner Deluxe	11-14
MD2100	R	Solid	282	N/A	Plain	N/A			YAMAHA	
MD2100C	R	Solid	282	N/A	Contour	N/A			FJR 1300	06-12
VR2100	R	Solid	282	N/A	Vee	N/A			FJR 1300 A	13-18
									FJR 1300 Electric Shift	06-09
									FJR 1300 ES	14-22
									XT 1200 Z Super Tenere ES	14-23

BRAKE ROTOR BUYERS GUIDE - STREET

Rotor No.	F/R	Type	Dia. (mm)	Hub Color	Profile	Bobbins	Left Bracket	Right Bracket	Model	Year
MD2101X MD2101XC VR2101BLK VR2101BLU VR2101RED	F F F F F	Floating Floating Floating Floating Floating	320 320 320 320 320	Gold Gold Black Blue Red	Plain Contour Vee Vee Vee	6 6 6 6 6			YAMAHA FZS 1000 FZ1 XVS 1300 Stryker	06-14 11-14
MD2102X MD2102XC VR2102BLK VR2102BLU VR2102RED VR2102RED	F F F F F F	Floating Floating Floating Floating Floating Floating	310 310 310 310 310 310	Gold Gold Black Blue Red Red	Plain Contour Vee Vee Vee Vee	6 6 6 6 6 6			YAMAHA YZF-1 6 piston caliper	07-14
MD2103 MD2103C VR2103	R R R	Solid Solid Solid	298 298 298	N/A N/A N/A	Plain Contour Vee	N/A N/A N/A			YAMAHA XVS 950 V-Star 950 XVS 950 V-Star 950 Tourer XVS 1300 V-Star 1300 Tourer XVS 1300 V-Star XVS 1300 V-Star Deluxe	10-14 10-14 07-14 07-14 13-14
MD2104RS	F	Solid	245	N/A	Plain	N/A			YAMAHA YBR 125 R 1PX1/X2 YBR 125 43B1	11-12 08-13
MD2105X MD2105XC VR2105BLK VR2105BLU VR2105RED	F F F F F	Floating Floating Floating Floating Floating	310 310 310 310 310	Gold Gold Gold Gold Gold	Plain Plain Plain Plain Plain	6 6 6 6 6			YAMAHA YZF-R6	08-16
MD2106RS	F	Solid	280	N/A	Plain	N/A			YAMAHA YS 250 Fazer 5D41	06-10
MD2107 MD2107C	F F	Floating Floating	267 267	Black Black	Plain Contour	6 6			YAMAHA XP 500 Y/Z/A T-Max	09-11
MD2108C	R	Floating	298	Gold	Contour	6			YAMAHA VMX 1700 V-Max 6 piston radial caliper	09-21
MD2109XC	F	Floating	320	Gold	Contour	6			YAMAHA VMX 1700 V-Max 6 piston radial caliper	09-21
MD2112XBLK	F	Floating	320	Black	Plain	6			KTM Super Duke R Super Duke R Evo Super Duke R SE Super Duke GT	14-22 21-23 16-17 19-23
MD2114 MD2114C MD2114	R R R	Solid Solid Solid	310 310 310	N/A N/A N/A	Plain Contour Vee	N/A N/A N/A			YAMAHA XVS 1300 Stryker XV 1900 Raider XV 1900 Raider S XV 1900 Raider SCL	11-14 08-14 08-14 12-14
MD2115C	R	Solid	280	N/A	Contour	N/A			YAMAHA XT 1200 Z Super Tenere XT 1200 Z Super Tenere ES	12-18 14-23
MD2116 MD2116C VR2116	R R R	Solid Solid Solid	267 267 267	N/A N/A N/A	Plain Contour Vee	N/A N/A N/A			YAMAHA FZ8	11-13
MD2117 VR2117	R R	Solid Solid	245 245	N/A N/A	Plain Vee	N/A N/A			YAMAHA FZ6R FZ6R Y/Z/A	09-17 09-11
MD2118	R	Solid	220	N/A	Plain	N/A			YAMAHA YZF-R1 LE	06

BRAKE ROTOR BUYERS GUIDE - STREET

Rotor No.	F/R	Type	Dia. (mm)	Hub Color	Profile	Bobbins	Left Bracket	Right Bracket	Model	Year
MD2119X MD2119XC VR2119BLK VR2119BLU VR2119RED	F F F F F	Floating Floating Floating Floating Floating	298 298 298 298 298	Gold Gold Black Blue Red	Plain Contour Vee Vee Vee	6 6 6 6 6			YAMAHA MT-03 YZF R3 321cc YZF R3 Monster Energy Yamaha Moto GP Edition 321cc MT 07 YZF-R7 FZ-09 847cc/3 cyl MT-09 Tracer 900 MTT9 Tracer 9 GT XSR 900 ABS MTM 850 Star Venture Star Venture Transcontinental Star Eluder Star Eluder GT	16-23 15-23 19-23 21-23 22-24 14-17 18-23 18-23 20-24 16-23 18-22 18-22 18-22 18-22
MD2120 MD2120C VR2120	R R R	Solid Solid Solid	245 245 245	N/A N/A N/A	Plain Contour Vee	N/A N/A N/A			YAMAHA FZ-07 689cc/2 cyl FZ-07 A 689cc/2 Cyl/ABS MT 07 XSR 700 MTM 690-U XSR 700 X Tribute T7 Tenere T7 Tenere World Raid YZF-R7 FZ-09 847cc/3 cyl MT 09 MTN 890 MT 09 SP MTN 890D Tracer 900 MTT9 Tracer 900 GT MTT9GT XSR 900 ABS MTM 850	15-17 17 18-23 18-23 20-21 19-24 20-24 22-24 14-17 18-23 21-23 18-23 20-23 16-23
MD2123 MD2123C VR2123	R R R	Solid Solid Solid	220 220 220	N/A N/A N/A	Plain Contour Vee	N/A N/A N/A			YAMAHA MT-03 YZF R3 321cc YZF R3 Monster Energy Yamaha Moto GP Edition 321cc	16-23 15-23 19-23
MD2124X MD2124XC VR2124BLK VR2124BLU VR2124RED	Front Front Front Front Front	Floating Floating Floating Floating Floating	320 320 320 320 320	Gold Gold Black Blue Red	Plain Contour Vee Vee Vee	6 6 6 6 6			YAMAHA YZF-R6 H 320mm Rotor MT-10 MTN 1000 MT-10 SP MTN 1000D YZF-R1 YZF-R1 M YZF-R1 S	2017-2022 18-23 22-23 15-23 15-23 16-20
MD2125 MD2125C VR2125	R R R	Solid Solid Solid	220 220 220	N/A N/A N/A	Plain Contour Vee	N/A N/A N/A			YAMAHA YZF-R1 YZF-R1 M YZF-R1 S	15-24 15-24 16-20
MD2127X MD2127XC VR2127BLK VR2127BLU VR2127RED	F F F F F	Floating Floating Floating Floating Floating	282 282 282 282 282	Gold Gold Black Blue Red	Plain Contour Vee Vee Vee	6 6 6 6 6			YAMAHA FZ-07 689cc FZ-07 A 689cc ABS MT-07 XSR 700 MTM 690-U XSR 700 X Tribute T7 Tenere T7 Tenere World Raid	15-17 17 18-20 18-23 20-21 19-24 20-24
MD2129X MD2129XC	F F	Floating Floating	298 298	Gold Gold	Plain Contour	6 6			YAMAHA VMX12 V-Max 1200 All models	93-07
MD2130C	R	Solid	298	N/A	Contour	N/A			YAMAHA SCR 950 SCR 950 H XVS 950 Bolt Standard R Shocks XVS 950 Bolt C Spec Remote Reservoir R Shocks XVS 950 Bolt R Spec Remote Reservoir R Shocks	17 14-16 15-21 14-21

BRAKE ROTOR BUYERS GUIDE - STREET

Rotor No.	F/R	Type	Dia. (mm)	Hub Color	Profile	Bobbins	Left Bracket	Right Bracket	Model	Year
MD2131	R	Solid	320	N/A	Plain	N/A			YAMAHA Star Venture Star Venture Transcontinental Star Eluder Star Eluder GT	18-22 18-22 18-22 18-22
MD3001	F	Solid	290	N/A	Plain	N/A			SUZUKI GSX 600 FJ	88
MD3002 MD3002C VR3002	R R R	Solid Solid Solid	250 250 250	N/A N/A N/A	Plain Contour Vee	N/A N/A N/A			SUZUKI GSF 400 M/N/P Bandit GS 500 E GS 500 FK GSX 600 F Katana GSX 750 F Katana	91-93 89-03 04-10 88-97 89-97
MD3003X MD3003XC VR3003BLK VR3003BLU VR3003RED	F F F F F	Floating Floating Floating Floating Floating	290 290 290 290 290	Gold Gold Black Blue Red	Plain Contour Vee Vee Vee	6 6 6 6 6			SUZUKI GSF 600 Bandit ST/SV/V GSX 600 F Katana GSF 600 SY/SK1/SK2/SK3 RF 600 RR/RS/RT/RV SV 650 GSX 750 F Katana	96-97 89-02 89-02 00-03 94-97 99-02
MD3004	F	Floating	310	Silver	Plain	6			SUZUKI GSX-R 1100 G/H/J	86-88
MD3005	F	Floating	300	Silver	Plain	6			SUZUKI GSX-R 750 RG/G/H	86-87
MD3006X MD3006XC VR3006BLK VR3006BLU VR3006RED	F F F F F	Floating Floating Floating Floating Floating	310 310 310 310 310	Gold Gold Black Blue Red	Plain Contour Vee Vee Vee	6 6 6 6 6			SUZUKI GSF 400 M/N/P Bandit GS 500 E GS 500 RF 900 R GSF 1200	91-93 89-03 04-10 94-98 96-05
MD3007X MD3007XC VR3007BLK VR3007BLU VR3007RED	F F F F F	Floating Floating Floating Floating Floating	310 310 310 310 310	Gold Gold Black Blue Red	Plain Contour Vee Vee Vee	6 6 6 6 6			SUZUKI GSX-R 600 W GSX-R 750 GSX-R 750 W GSX-R 1100 GSX-R 1100 W	92-93 89-93 94-95 89-92 93-98
MD3008 MD3008C VR3008	R R R	Solid Solid Solid	240 240 240	N/A N/A N/A	Plain Contour Vee	N/A N/A N/A			SUZUKI GSF 600 Bandit GSF 600 GSX-R 600 W GSX 600 F Katana RF 600 R SV 650 GSX 750 Inazuma GSX 750 F Katana GSK 750 F GSX-R 750 RF 900 R GSX-R 1100 K/L/M/N GSX-R 1100 W GSF 1200 GSX 1300 R Hayabusa	96-97 00-03 92-93 98-06 94-97 99-02 98-00 98-03 04-06 89-95 94-98 89-92 93-98 96-05 99-07
MD3009	R	Solid	220	N/A	Plain	N/A			SUZUKI GSX-R 750 RG/G/H GSX-R 1100 G/H/J	86-87 86-88
MD3010LS	F	Solid	162	N/A	Plain	N/A			SUZUKI GSXR 50 RB 50 H	87

BRAKE ROTOR BUYERS GUIDE - STREET

Rotor No.	F/R	Type	Dia. (mm)	Hub Color	Profile	Bobbins	Left Bracket	Right Bracket	Model	Year
MD3014LS	F	Floating	276	Silver	Plain	6			SUZUKI	
MD3014RS	F	Floating	276	Silver	Plain	6			GS 250 TT/TX	80-81
VMD3014	F	Floating	276	Black	Plain	9			GN 250 J	88
									GT 250 Hustler	73-77
									GT 380 Sebring	73-77
									GN 400	80-82
									GS 400 B/C Disc Brake	77-78
									GS 425 N	79
									GS 425 EN	79
									GS 425 LN	79
									GS 450 E	80-83
									GS 450 G	82-85
									GS 450 L	80-88
									GS 450 TX/TZ	81-82
									GS 450 TXZ	82
									GS 550 ET	80
									GS 550 MZ	82
									GS 550 LD/LF/LG	83-86
									GR 650 D/XD 'Tempter'	83
									GS 650 EX/EZ	81-82
									GS 650 GX/GZ/GD	81-83
									GS 650 MD	83
									GS 750 EC/EN/LN 8 valve	78-79
									GS 750 ET/EX/EZ 16 valve	80-82
									GS 750 LT/LX 16 valve	80-81
									GS 750 SD	83
									GS 850 G	79-83
									GS 1000 ET/ST/SZ	80-82
									GS 1000 EC/EN/SN/LN	78-79
									GS 1000 GT/GX	80-81
									GS 1000 GLT/GLX	80-81
									GS 1100 ET/EX/EZ/ED/ESD	80-83
									GS 1100 LT	80
									GS 1100 GZ/GD	82-83
									GS 1100 GLZ/GLD	82-83
									GS 1100 GKZ/GK2/GKD	82-83
									GS 1100 SD	83
MD3014RS	R	Floating	276	Silver	Plain	6			SUZUKI	
VMD3014	R	Floating	276	Black	Plain	9			XN 85 D 673cc	83
									GS 550 C/N/E/EN	77-79
									GS 550 ET/TX	80-81
									GS 550 MZ	82
									GS 550 LT/LX	80-81
									GS 750 ET/EX/EZ 16 valve	80-82
									GS 750 LT/LX 16 valve	80-81
									GS 750 SD	83
									GS 750 C/N/EC/EN/LN 8 valve	78-79
									GS 850 GN/GT/GX/GLT	79-81
									GS 1000 C/N	78-79
									GS 1000 EC/EN/SN/LN	78-79
									GS 1000 ET/ST/SZ	80-82
									GS 1000 GT/GX	80-81
									GS 1000 GLT/GLX	80-81
									GS 1100 ET/EX/EZ/ED/ESD	80-83
									GS 1100 LT	80
									GS 1100 SD	83
MD3017LS	F	Solid	260	N/A	Plain	N/A			SUZUKI	
									LS 650 Savage	86-88/95-04
									LS 650 Boulevard S40	05-15
MD3019LS	F	Floating	276	Silver	Plain	6			SUZUKI	
MD3019RS	F	Floating	276	Silver	Plain	6			GS 550 B	77
VMD3019	F	Floating	276	Black	Plain	9			GT 550 Indy	73-75
Billet									GT 550 A/B Indy Tokico Caliper	76-77
									GT 550 B Indy Asco Caliper	77
									GS 750 B 8 valve	77
									GT 750	73-77
									RE 5 M/A Rotary	75-76

BRAKE ROTOR BUYERS GUIDE - STREET

Rotor No.	F/R	Type	Dia. (mm)	Hub Color	Profile	Bobbins	Left Bracket	Right Bracket	Model	Year
MD3019RS VMD3019 Billet	R R	Floating Floating	276 276	Gold Black	Plain Plain	6 9			SUZUKI GS 750 8 valve	77
MD3020LS	F	Floating	296	Gold	Plain	6			SUZUKI GS 550 C/N/EC/EN GS 550 LT GS 750 C/N 8 Valve GS 1000 C/N	77-79 80 78-79 78-79
MD3022LS	F	Floating	295	Gold	Plain	6			SUZUKI GS 550 LX GS 550 LZ GS 550 TX GS 650 GLX/GLZ/GLD GS 750 TZ/TD 16 valve	81 82 81 81-83 82-83
MD3024LS MD3024RS	F F	Floating Floating	260 260	Silver Silver	Plain Plain	6 6			SUZUKI GS 550	83-86
MD3025	R	Solid	250	N/A	Plain	N/A			SUZUKI GS 550	83-86
MD3027	R	Solid	276	N/A	Plain	N/A			SUZUKI GS 650 E GS 650 G GS 650 M GS 850 G GS 1100 G	81-82 81-83 83 80-83 82-83
MD3028LS MD3028RS	F F	Floating Floating	260 260	Silver Silver	Plain Plain	6 6			SUZUKI XN 85 D 673cc GS 700 EF/ESF GS 750 ED/ESD	83 85 83
MD3029	R	Floating	260	Silver	Plain	6			SUZUKI GS 700 EF/ESF GS 750 ED/ESD	85 83
MD3030LS MD3030RS	F F	Solid Solid	276 276	N/A N/A	Plain Plain	N/A N/A			SUZUKI GV 700 GLF/GLF2 GV 1200 GLF/GLF2/GLG 'Madura'	85 85-86
MD3031LS	F	Solid	296	N/A	Plain	N/A			SUZUKI VS 700 GLFG/GLPG	86-87
MD3032LS MD3032RS	F F	Floating Floating	296 296	Gold Gold	Plain Plain	6 6			SUZUKI VS 700 GLFH/GLPH VS 750 Intruder VS 800 Intruder VS 800 Boulevard VS 1400 Intruder VS 1400 Boulevard S83	86-87 88-91 92-04 05-10 87-04 05-10
MD3033LS	F	Solid	310	N/A	Plain	N/A			SUZUKI VX 800 L/M/N/P	90-93
MD3036	R	Solid	275	N/A	Plain	N/A			SUZUKI GSX 1100 FK/FL/FM/FN/FP Katana	88-93
MD3037LS MD3037RS	F F	Solid Solid	310 310	N/A N/A	Plain Plain	N/A N/A			SUZUKI GSX 1100 GM/GN/GP	91-93
MD3038	R	Solid	295	N/A	Plain	N/A			SUZUKI GSX 1100 GM/GN/GP	91-93
MD3039	R	Floating	276	Gold	Plain	6			SUZUKI GSX 1150	83-86

BRAKE ROTOR BUYERS GUIDE - STREET

Rotor No.	F/R	Type	Dia. (mm)	Hub Color	Profile	Bobbins	Left Bracket	Right Bracket	Model	Year
MD3039LS MD3039RS	F F	Floating Floating	276 276	Gold Gold	Plain Plain	6 6			SUZUKI GSX 1100 F Katana GSX 1150 E	88-93 83-86
MD3041	R	Floating	275	Gold	Plain	6			SUZUKI GV 1200 Madura	85-86
MD3042	F	Solid	275	N/A	Plain	N/A			SUZUKI GV 1400 G	86-88
MD3043	R	Solid	296	N/A	Plain	N/A			SUZUKI GV 1400 G	86-88
MD3044	R	Solid	275	N/A	Plain	N/A			SUZUKI VS 1400 Intruder VS 1400 Boulevard S83 1400cc	87-04 05-10
MD3045	F	Floating	300	Gold	Plain	6			SUZUKI VZ 800 Marauder	97-04
MD3058X MD3058XC VR3058BLK VR3058BLU VR3058RED	Front Front Front Front Front	Floating Floating Floating Floating Floating	320 320 320 320 320	Gold Gold Black Blue Red	Plain Contour Vee Vee Vee	6 6 6 6 6			SUZUKI GSXR 600 GSXR 750 GSXR 1000 K1/K2 TL 1000 S and R GSX 1300 R Hayabusa	97-03 96-03 01-02 97-03 99-07
MD3060 MD3060C VR3060	R R R	Solid Solid Solid	220 220 220	N/A N/A N/A	Plain Contour Vee	N/A N/A N/A			SUZUKI GSXR 600 GSXR 600 GSXR 600 ABS GSX-R 600 100th Anniversary SV 650 GSXR 750 ABS GSX-R 750 100th Anniversary TL 1000 S&R GSXR 1000 SV 1000	97-03 04-10 11-20 21-22 03-10 96-20 21-24 97-03 01-16 03-07
MD3061	R	Solid	250	N/A	Plain	N/A			SUZUKI VX 800 L/M/N/P	90-93
MD3073LS	F	Floating	296	Gold	Plain	6			SUZUKI VS 700	86-87
MD3075LS MD3075RS	F F	Floating Floating	310 310	Gold Gold	Plain Plain	6 6			SUZUKI GSF 1200 S Bandit ABS	97
MD3076	R	Solid	276	N/A	Plain	N/A			SUZUKI GSF 1200 S Bandit ABS	97
MD3078LS MD3078RS	F F	Solid Solid	300 300	N/A N/A	Plain Plain	N/A N/A			SUZUKI VL 1500 Intruder Legendary Classic	98-01
MD3079	R	Floating	276	Gold	Plain	6			SUZUKI VL 1500 W/X Intruder Legendary Classic	98-99
MD3086	R	Floating	276	Gold	Plain	6			SUZUKI VL 1500 VL 1500 Boulevard C90/C90T VL 1500 C90 Boulevard VL 1500 C90T Boulevard V 1500 Boulevard C90 B.O.S.S. V 1500 Boulevard C90 B.O.S.S.	00-04 05-10 13 13-15 13-15 13-14
MD3087LS MD3087RS	F F	Solid Solid	290 290	N/A N/A	Plain Plain	N/A N/A			SUZUKI VL 1500	02-10

BRAKE ROTOR BUYERS GUIDE - STREET

Rotor No.	F/R	Type	Dia. (mm)	Hub Color	Profile	Bobbins	Left Bracket	Right Bracket	Model	Year
MD3088X	F	Floating	310	Gold	Plain	6			SUZUKI	
MD3088XC	F	Floating	310	Gold	Contour	6			DL 650 V-Strom	04-06
VR3088BLK	F	Floating	310	Black	Vee	6			DL 1000 V-Strom ABS	02-20
VR3088BLU	F	Floating	310	Blue	Vee	6			DI 1000 V-Strom Adventure	12-20
VR3088RED	F	Floating	310	Red	Vee	6			SV 1000	03-07
MD3089X	F	Floating	300	Gold	Plain	6			SUZUKI	
MD3089XC	F	Floating	300	Gold	Plain	6			GSXR 1000 K3	03
VR3089BLK	F	Floating	300	Gold	Plain	6				
VR3089BLU	F	Floating	300	Gold	Plain	6				
VR3089RED	F	Floating	300	Gold	Plain	6				
MD3090X	F	Floating	290	Gold	Plain	6			SUZUKI	
MD3090XC	F	Floating	290	Gold	Contour	6			SV 650	03-10
VR3090BLK	F	Floating	290	Black	Vee	6			GSX 600 F	03-06
VR3090BLU	F	Floating	290	Blue	Vee	6			GSX 750 F	03-06
VR3090RED	F	Floating	290	Red	Vee	6			VZ 1500 M90 Boulevard	09/13-15
									C 109 RT Boulevard 1783cc VLR 1800	08-09
									C 109 R VLR 1800	08-09
									VLR 1800 C109 RT Touring	08-10
MD3091X	F	Floating	310	Gold	Plain	6			SUZUKI	
MD3091XC	F	Floating	310	Gold	Contour	6			GSXR 600 K6/K7	06-07
VR3091BLK	F	Floating	310	Black	Vee	6			GSXR 750 K6/K7	06-07
VR3091BLU	F	Floating	310	Blue	Vee	6			GSXR 1000	05-08
VR3091RED	F	Floating	310	Red	Vee	6			VZR 1800 Boulevard M109R B.O.S.S.	14-21
									VZR 1800 M109R Boulevard	06-14
									VZR 1800 M109 R2 Limited	08-09
									VZR 1800 M109 RZ Limited	08-14
MD3092X	Front	Floating	310	Gold	Plain	6			SUZUKI	
MD3092XC	Front	Floating	310	Gold	Contour	6			DL 650 V-Strom	07-17
VR3092BLK	Front	Floating	310	Black	Vee	6			DL 650 V-Strom Adventure ABS	12-24
VR3092BLU	Front	Floating	310	Blue	Vee	6			DL 650 V-Strom XT ABS	15-24
VR3092RED	Front	Floating	310	Red	Vee	6			DL 650 V-Strom XT Touring	18-24
									GSX 650 FK8/FK9/FLO	08-10
									GSR 750 L5/L6	15-16
									GSR 750 AL5/AL6 ABS	15-16
									GSX-S 750 A AL8 ABS	18-21
									GSX-S 750 Y AZL8 ABS	18-21
									GSX-S 750Z	15-22
									GSX-S 750 Z	18-22
									GSX-S 750 ZL	18-21
									DL 800 DE V-Strom	24
									DL 1000 V-Strom Adventure ABS	14-20
									DL 1000 XT V-Strom ABS	18-20
									V-Strom 1050 A ABS	20-24
									V-Strom 1050 XT/XA ABS	20-24
									V-Strom 1050 XT Adventure ABS	20-24
									GSF 1250	07-10
									GSF 1250 Bandit	07-10
									GSX 1250 FAL	11-14
MD3093	Rear	Solid	240	N/A	Plain	N/A			SUZUKI	
MD3093C	Rear	Solid	240	N/A	Contour	N/A			GW 250 L3	13
VR3093	Rear	Solid	240	N/A	Vee	N/A			GW 250 FL5	15
									GSX 650 FK	08-10
									SV 650 SA ABS	07-10
									SFV 650 Gladius	09-10/13-14
									SV 650	16-24
									SV 650 A ABS	16-21
									SV 650 X ABS	16-24
									GSR 750	15-16
									GSX-S 750 A ABS	18-21
									GSX-S 750 Y ABS	18-21
									GSX-S 750 ABS	15-24
									GSX-S 750 Z ABS	18-24
									GSX-S 750 ZL ABS	18-21
									GSF 1250 ABS	07-10

BRAKE ROTOR BUYERS GUIDE - STREET

Rotor No.	F/R	Type	Dia. (mm)	Hub Color	Profile	Bobbins	Left Bracket	Right Bracket	Model	Year
MD3093 Contd.									GSF 1250 Bandit GSX 1250 FAL	07-10 11-12
MD3095RS	F	Solid	300	N/A	Plain	N/A			SUZUKI VL 800 VL 800 ZK3/ZK4 Volusia Ltd VL 800 BTL4 Boulevard C50 B.O.S.S. VL 800 CL3 Boulevard C50 Special Edition	05-17 03-04 14 13
MD3096RS	F	Solid	300	N/A	Plain	N/A			SUZUKI VZ 800 M50 Boulevard VZ 800 M50 Boulevard	05-10 10-15
MD3097	R	Floating	275	Silver	Plain	6			SUZUKI VZ 1500 M90 Boulevard VLR 1800 C109 RT Touring VLR 1800 C109 R VZR 1800 Boulevard M109R B.O.S.S. VZR 1800 M109R Boulevard VZR 1800 M109 R2 Limited VZR 1800 M109 RZ Limited	09/13-15 08-10 08-10 14-21 06-14 08-09 08-14
MD3098X MD3098XC VR3098BLK VR3098BLU VR3098RED	F F F F F	Floating Floating Floating Floating Floating	310 310 310 310 310	Gold Gold Black Blue Red	Plain Contour Vee Vee Vee	6 6 6 6 6			SUZUKI GSX 1300 R GSX 1300 BK B-King ABS GSX 1300 BKK B-King GSX 1300 R Hayabusa 50th Anniversary Edition GSX 1300 RA ABS Hayabusa	08-12 08-10 08-10 14 13-20
MD3099 MD3099C VR3099	R R R	Solid Solid Solid	260 260 260	N/A N/A N/A	Plain Contour Vee	N/A N/A N/A			SUZUKI GSX 1300 R GSX 1300 BK B-King ABS GSX 1300 BKK B-King GSX 1300 R Hayabusa 50th Anniversary Edition GSX 1300 ABS Hayabusa GSX 1300 Hayabusa ABS	08-12 08-10 08-10 14 13-20 21-23
MD3100X MD3100XC VR3100BLK VR3100BLU VR3100RED	F F F F F	Floating Floating Floating Floating Floating	310 310 310 310 310	Gold Gold Black Blue Red	Plain Contour Vee Vee Vee	6 6 6 6 6			SUZUKI GSXR 600 ABS GSX-R 600 100th Anniversary GSXR 750 ABS GSX-R 750 100th Anniversary	08-20 21-24 08-20 21-24
MD3102X MD3102XC VR3102BLK VR3102BLU VR3102RED	F F F F F	Floating Floating Floating Floating Floating	310 310 310 310 310	Gold Gold Black Blue Red	Plain Contour Vee Vee Vee	6 6 6 6 6			SUZUKI GSXR 1000 GSXR 1000 ABS	09-16 15-16
MD3103X MD3103XC	F F	Floating Floating	290 290	Gold Gold	Plain Contour	6 6			SUZUKI SFV 650 K9/L3/L4 SV 650 SA ABS SV 650 SV 650 A ABS SV 650 X ABS	09-10/13-14 07-10 16-21 16-24 16-24
MD3104X MD3104XC VR3104BLK VR3104BLU VR3104RED	F F F F F	Floating Floating Floating Floating Floating	300 300 300 300 300	Gold Gold Black Blue Red	Plain Contour Vee Vee Vee	6 6 6 6 6			SUZUKI GSXR 600 GSXR 750 K GSXR 1000 K/ZK	04-05 04-05 04
MD3105LS	F	Solid	290	N/A	Plain	N/A			SUZUKI GW 250 L4/L5 GW 250 FL5 Fairing	14-15 15

BRAKE ROTOR BUYERS GUIDE - STREET

Rotor No.	F/R	Type	Dia. (mm)	Hub Color	Profile	Bobbins	Left Bracket	Right Bracket	Model	Year
MD3106 MD3106C VR3106	R R R	Solid Solid Solid	220 220 220	N/A N/A N/A	Plain Contour Vee	N/A N/A N/A			SUZUKI GSX-R 1000 ABS GSX-R 1000R ABS GSX-R 1000 100th Anniversary GSX-R 1000 R 100th Anniversary	15-24 17-24 21 21
MD3107X MD3107XC VR3107BLK VR3107BLU VR3107RED	F F F F F	Floating Floating Floating Floating Floating	320 320 320 320 320	Gold Gold Black Blue Red	Plain Contour Vee Vee Vee	6 6 6 6 6			SUZUKI GSX-R 1000 ABS GSX-R 1000 R ABS GSX-R 1000 100th Anniversary GSX-R 1000 R 100th Anniversary	17-24 17-24 21 21
MD3108 MD3108C VR3108	R R R	Solid Solid Solid	250 250 250	N/A N/A N/A	Plain Contour Vee	N/A N/A N/A			SUZUKI GSX-S 1000 GSX-S 1000 ABS GSX-S 1000 F GSX-S 1000 F ABS	16-21 16-22 16-21 16-21
MD3109X MD3109XC VR3109BLK VR3109BLU VR3109RED	F F F F F	Floating Floating Floating Floating Floating	310 310 310 310 310	Gold Gold Black Blue Red	Plain Contour Vee Vee Vee	6 6 6 6 6			SUZUKI GSX-S 1000 GSX-S 1000 ABS GSX-S 1000 Naked ABS GSX-S 1000 F GSX-S 1000 F ABS GSX-S 1000 GT ABS	16-21 16-22 21-22 16-21 16-21 21-22
MD3110C	F	Solid	290	N/A	Contour	N/A			SUZUKI GSX-R 125 RLXL8/RLL8 GSX-S 125 MLXL8/MLL8	18-21 18-21
MD3111 MD3111C	R R	Solid Solid	190 190	N/A N/A	Plain Contour	N/A N/A			SUZUKI GSX-R 125 RLXL8/RLL8 GSX-S 125 MLXL8/MLL8	18-21 18-21
MD3112C	F	Solid	290	N/A	Contour	N/A			SUZUKI DL 250 V-Strom ABS SUZUKI GSX 250 R	18-20 17-23
MD3113C	R	Solid	240	N/A	Contour	N/A			SUZUKI DL 250 V-Strom ABS SUZUKI GSX 250 R	18-20 17-23
MD3115X	Front	Floating	320	Gold	Plain	6			SUZUKI GSX 1300 Hayabusa	21-24
MD4001	R	Solid	260	N/A	Plain	N/A			KAWASAKI ZX 550 A1-A3 GPZ	84-86
MD4002LS MD4002RS	F F	Solid Solid	260 260	N/A N/A	Plain Plain	N/A N/A			KAWASAKI EL 250 B2/B3 Eliminator EX 250 E1-E2 Ninja ZX 550 A1-A3 GPZ	88-89 86-87 84-86
MD4006LS MD4006RS (5mm thickness)	F F	Solid Solid	270 270	N/A N/A	Plain Plain	N/A N/A			KAWASAKI EN 450 A1-A6 454 LTD EN 500 A1-A6/B2 Vulcan KZ 550 F1 Spectre F2 Ltd KZ 550 M1 LTD KZ 550 A2/A3/A4/C1-C4 Ltd KZ 1000 Inc. LTD KZ 1100 A1-A3 KZ 1100 B1 GPZ KZ 1100 D1/D2 Spectre KZ 1100 L1 LTD	85-90 90-95 83-84 83 80-83 81-82 81-83 81 82-83 83
MD4007 MD4007C VR4007	R R R	Solid Solid Solid	230 230 230	N/A N/A N/A	Plain Contour Vee	N/A N/A N/A			KAWASAKI ZX 600 D1-D4 ZX6 ZX 750 F1-F4 Ninja ZR 750 C1-C3	90-93 87-90 91-93

BRAKE ROTOR BUYERS GUIDE - STREET

Rotor No.	F/R	Type	Dia. (mm)	Hub Color	Profile	Bobbins	Left Bracket	Right Bracket	Model	Year
MD4008X MD4008XC VR4008BLK VR4008GRN	Front Front Front Front	Floating Floating Floating Floating	300 300 300 300	Gold Gold Black Green	Plain Contour Vee Vee	6 6 6 6			KAWASAKI ZR 550 B1-B4 Zephyr ZL 600 B2/B3 Eliminator ZX 600 F1/F2/F3 ZX6R EJ 650 A2/A3/A4 W650 W 800 Café Cockpit Fairing W 800 Special Black Exhaust W 800 ABS W 800 ABS Special ZR 750 C1-C3 ZG 1000 A9-A20/A6F Con Cours GPZ 1100 ZX 1100 E1/E2/E3	90-93 96-97 95-97 00-02 11 12 13-16 13-16 91-93 94-06 95-97
MD4009 MD4009C VR4009	R R R	Solid Solid Solid	240 240 240	N/A N/A N/A	Plain Contour Vee	N/A N/A N/A			KAWASAKI ZR 550 B1-B4 Zephyr ZX 600 E1-E13 Ninja ZX6	90-93 93-05
MD4010LS MD4010RS 5mm thickness	F F	Solid Solid	260 260	N/A N/A	Plain Plain	N/A N/A			KAWASAKI KZ 440 D5 LTD KZ 440 G1 KZ 550 D1 GPZ KZ 700 A1 VN 700 A1 Vulcan KZ 750 E1-E3 KZ 750 F1 LTD KZ 750 H1-H4 LTD KZ 750 L3 KZ 750 N1/N2 Spectre KZ 750 R1 GPZ VN 750 A2-A21/A6F Vulcan	83 82 81 84 85 80-82 83 80-83 83 82-83 82 86-06
MD4012X MD4012XC VR4012BLK VR4012GRN	F F F F	Floating Floating Floating Floating	310 310 310 310	Gold Gold Black Green	Plain Contour Vee Vee	6 6 6 6			KAWASAKI ZX 750 H1/H2 ZX7 ZX 9R ZX 900 E1/E2 ZR 1100 A1-A4 Zephyr ZR 1100 B1 Zephyr ZX 1100 C1-C4 ZX11 Ninja ZR 1100 C3/C4 ZRX 1100 ZRX 1200 R ZR	89-90 00-01 92-95 96 90-93 99-00 01-05
MD4013 MD4013C VR4013	R R R	Solid Solid Solid	230 230 230	N/A N/A N/A	Plain Contour Vee	N/A N/A N/A			KAWASAKI ZX 750 ZX-7 ZX 750 ZX7R ZX 750 ZX7RR ZX 900 ZX9R	89-95 91-03 96-99 94-97
MD4014 MD4014C VR4014	R R R	Solid Solid Solid	250 250 250	N/A N/A N/A	Plain Contour Vee	N/A N/A N/A			KAWASAKI ZX 1100 D1-D9 Ninja ZX11	93-01
MD4015 MD4015C VR4015	R R R	Solid Solid Solid	250 250 250	N/A N/A N/A	Plain Contour Vee	N/A N/A N/A			KAWASAKI ZX 600 Ninja ZX 1000 Ninja ZX10 ZX 1100 ZX11 Ninja	85-87 88-90 90-93
MD4016 *Floating Disc kit available for these bikes See MD714LS/RS	F	Solid	280	N/A	Plain	N/A			KAWASAKI EX 500 A1-A7* EX 500 ZL 600 A1/A2 ZX 750 E1/E2 Turbo ZL 900 A1/A2 Eliminator ZX 900 A1-A3 Ninja ZL 1000 A1 ZX 1000 A1/A2 Ninja ZX 1100 A1/A2 GPZ	87-93 94-09 86-87 84-85 85-86 84-86 87 86-87 83-84

BRAKE ROTOR BUYERS GUIDE - STREET

Rotor No.	F/R	Type	Dia. (mm)	Hub Color	Profile	Bobbins	Left Bracket	Right Bracket	Model	Year
MD4017	R	Solid	270	N/A	Plain	N/A			KAWASAKI ZX 750 E1/E2 Turbo ZL 900 A1/A2 Eliminator ZX 900 A1/A2/A3 ZL 1000 A1 ZX 1100 A1/A2 GPZ	84-85 85-86 84-86 87 83-84
MD4019	R	Solid	260	N/A	Plain	N/A			KAWASAKI ZX 750 GPZ ZX 1000 Ninja	83-85 86-87
MD4021	F	Solid	300	N/A	Plain	N/A			KAWASAKI ZX 1000 Ninja ZX10	88-90
MD4022X MD4022XC VR4022BLK VR4022GRN	Front Front Front Front	Floating Floating Floating Floating	320 320 320 320	Gold Gold Black Green	Plain Contour Vee Vee	6 6 6 6			KAWASAKI Ninja ZX-750 ZX-7 Ninja ZX7R ZX750 Ninja ZX7R 750 Ninja ZX-7RR ZX750 ZX-9R Ninja ZX-9R Ninja ZX 1100 Ninja ZRX 1200 R ZR ZX 12 R 1200cc ZX 1200 ZZR VN 1500 Vulcan Mean Streak VZ 1600 VN 1600 B	91-95 91-95 96-03 96-99 94-97 02-03 93-01 01-04 00-03 02-05 02-03 04-05 04-08
MD4023 MD4023C VR4023	R R R	Solid Solid Solid	230 230 230	N/A N/A N/A	Plain Contour Vee	N/A N/A N/A			KAWASAKI ZX 6R ZX 600 F1-F3 ZX 12R ZX 1200	95-97 00-05
MD4024	R	Solid	260	N/A	Plain	N/A			KAWASAKI KZ 550 H1/H2 GPZ	82-83
MD4026LS MD4026RS	F F	Solid Solid	260 260	N/A N/A	Plain Plain	N/A N/A			KAWASAKI ZX 600 C1-C9 Ninja 600 R	88-96
MD4027 MD4027C VR4027	R R R	Solid Solid Solid	240 240 240	N/A N/A N/A	Plain Contour Vee	N/A N/A N/A			KAWASAKI ZX 600 C1-C9 Ninja 600 R ZR 1100 A1-A4/B1 Zephyr	88-96 92-96
MD4028	R	Solid	270	N/A	Plain	N/A			KAWASAKI ZX 600 A1-A3/B1 Ninja ZX 750 A1-A3 GPZ ZG 1000 A1-A8 Con Cours	85-87 83-85 86-93
MD4032	R	Solid	240	N/A	Plain	N/A			KAWASAKI EX 250 E1-E2 Ninja	86-87
MD4038	F	Solid	280	N/A	Plain	N/A			KAWASAKI KZ 1000 R1/R2 Replica KZ 1000 J3 KZ 1100 B2 GPz	82-83 83 82
MD4040LS	F	Solid	210	N/A	Plain	N/A			KAWASAKI AR 50 A1 AR 80 A1	82 82
MD4041RS	F	Solid	260	N/A	Plain	N/A			KAWASAKI EX 250 Ninja 250	88-07
MD4042	R	Solid	230	N/A	Plain	N/A			KAWASAKI EX 250 Ninja 250	88-07
MD4043LS	F	Floating	260	Gold	Plain	6			KAWASAKI KZ 305 CSR KZ 305 LTD	81-82 87-88

BRAKE ROTOR BUYERS GUIDE - STREET

Rotor No.	F/R	Type	Dia. (mm)	Hub Color	Profile	Bobbins	Left Bracket	Right Bracket	Model	Year
MD4047LS	F	Floating	278	Gold	Plain	6			KAWASAKI KZ 440 A KZ 440 LTD	80-83 80-82
MD4051 MD4051C	R R	Solid Solid	230 230	N/A N/A	Plain Contour	N/A N/A			KAWASAKI EX 500	94-09
MD4052LS MD4052RS VMD4052	F F F	Floating Floating Floating	295 295 295	Gold Gold Black	Plain Plain Plain	6 6 9			KAWASAKI KH 500 A8 KZ 650 B KZ 750 B KZ 900 A KZ 1000 A	76 77-79 76-79 76-77 77-78
MD4053LS	F	Solid	260	N/A	Plain	N/A			KAWASAKI KZ 550 A1	80
MD4054 (7mm thickness)	R	Solid	270	N/A	Plain	N/A			KAWASAKI KZ 1000 J KZ 1000 K LTD KZ 1000 M CSR KZ 1000 P Police KZ 1000 R Replica KZ 1100 A KZ 1100 B GPZ KZ 1100 D Spectre KZ 1100 L LTD VN 1500 A Vulcan VN 1500 B Vulcan 88 SE	81-83 81-82 81-82 82-03/05 82-83 81-83 81-82 82-83 83 87-99 87-90
MD4059LS MD4059RS VMD4059	F F F	Floating Floating Floating	278 278 278	Silver Silver Black	Plain Plain Plain	6 6 9			KAWASAKI KZ 650 C Custom KZ 650 D SR series	77-79 78-79
MD4062	R	Floating	276	Silver	Plain	6			KAWASAKI KZ 650 C3 Custom From F/No 023101	-79
MD4063 VMD4063	R R	Floating Floating	295 295	Silver Black	Plain Plain	6 9			KAWASAKI KZ 650 D2 'SR' series KZ 1000 B3/B4 LTD KZ 1000 G1 Classic	79 79-80 80
MD4064LS MD4064RS VMD4064	F F F	Floating Floating Floating	295 295 295	Silver Silver Black	Plain Plain Plain	6 6 9			KAWASAKI KZ 650 E1 LTD KZ 650 F1 KZ 1000 A KZ 1000 B LTD KZ 1000 C KZ 1000 G1 Classic	80 80 79-80 79-80 79-81 80
MD4065LS	F	Floating	280	Gold	Plain	6			KAWASAKI KZ 650 H1-H3 CSR	81-83
MD4066LS	F	Floating	280	Gold	Plain	6			KAWASAKI KZ 750 M1 CSR	82
MD4067LS MD4067RS	F F	Solid Solid	270 270	N/A N/A	Plain Plain	N/A N/A			KAWASAKI ZN 700 A1/A2 Ltd	84-85
MD4068	R	Solid	260	N/A	Plain	N/A			KAWASAKI ZN 700 A1/A2 Ltd	84-85
MD4069LS MD4069RS VMD4069	F F F	Floating Floating Floating	296 296 296	Silver Silver Black	Plain Plain Plain	6 6 9			KAWASAKI HI-D/HI-E/HI-F 500 H2/H2-A "Mach IV" H2-B/H2-C "Mach IV" Z1/A/B 900	73-75 72-73 74-75 73-75

BRAKE ROTOR BUYERS GUIDE - STREET

Rotor No.	F/R	Type	Dia. (mm)	Hub Color	Profile	Bobbins	Left Bracket	Right Bracket	Model	Year
MD4070LS	F	Floating	270	Gold	Plain	6			KAWASAKI KZ 750 K1/K2 LTD	83-84
MD4071LS MD4071RS	F F	Solid Solid	270 270	N/A N/A	Plain Plain	N/A N/A			KAWASAKI ZX 750 F1-F4 Ninja	87-90
MD4076LS MD4076RS VMD4076	F F F	Floating Floating Floating	296 296 296	Silver Silver Black	Plain Plain Plain	6 6 9			KAWASAKI KZ 900 B1 'LTD' KZ 1000 B1/B2 'LTD' KZ 1000 D1/D3 Z1-R series KZ 1000 C1/C1A Police Series	76 77-78 78-80 78
MD4077 VMD4077	R R	Floating Floating	290 290	Silver Black	Plain Plain	6 9			KAWASAKI KZ 1000 KZ 1000 C Police Series KZ 1000 C KZ 1000 D Z1-R series	77-80 78 79-81 78-80
MD4078LS MD4078RS VMD4078	F F F	Floating Floating Floating	286 286 286	Gold Gold Black	Plain Plain Plain	6 6 9			KAWASAKI KZ 1000 E1/E2 ST & Shaft	79-80
MD4080LS MD4080RS	F F	Floating Floating	270 270	Gold Gold	Plain Plain	6 6			KAWASAKI KZ 1000 M1/M2 CSR	81-82
MD4082	R	Solid	280	N/A	Plain	N/A			KAWASAKI ZG 1000 A1-A8 Con Cours ZG 1000 A9-A20/A6F Con Cours	86-93 94-06
MD4084	F	Solid	280	N/A	Plain	N/A			KAWASAKI ZN 1100 B1/B2 LTD	84-85
MD4085	R	Solid	270	N/A	Plain	N/A			KAWASAKI VN 900 Vulcan Custom Special Edition VN 900 Vulcan Classic LT VN 900 Vulcan Classic VN 900 Vulcan Custom ZN 1100 B1/B2 LTD	11-12 06-22 06-22 07-22 84-85
MD4087	F	Solid	280	N/A	Plain	N/A			KAWASAKI ZG 1200 A1/A2/B1-B17 Voyager XII	86-03
MD4088	R	Solid	290	N/A	Plain	N/A			KAWASAKI ZG 1200 A1/A2/B1-B17 Voyager XII	86-03
MD4089LS MD4089RS VMD4089	F F F	Floating Floating Floating	299 299 299	Silver Silver Black	Plain Plain Plain	6 6 9			KAWASAKI KZ 1300 A1-A4 KZ 1300 B2 Touring	79-82 80
MD4090	R	Solid	290	N/A	Plain	N/A			KAWASAKI KZ 1000 E1/E2 ST & Shaft KZ 1300 A1-A4 KZ 1300 B2 Touring	79-80 79-82 80
MD4091	F	Solid	300	N/A	Plain	N/A			KAWASAKI KZ 1000 P1-P22/P24 Police ZN 1300 A1-A6 Voyager	82-03/05 83-88
MD4092	R	Solid	330	N/A	Plain	N/A			KAWASAKI ZN 1300 A1-A6 Voyager	83-88
MD4094LS	F	Floating	300	Silver	Plain	6			KAWASAKI VN 1500 B1-B4 Vulcan 88 SE	87-90
MD4099	F	Solid	260	N/A	Plain	N/A			KAWASAKI EX 305 B1 GPZ KZ 550 H1/H2 GPZ	83 82-83

BRAKE ROTOR BUYERS GUIDE - STREET

Rotor No.	F/R	Type	Dia. (mm)	Hub Color	Profile	Bobbins	Left Bracket	Right Bracket	Model	Year		
VMD4123	F	Floating	278	Black	Plain	9			KAWASAKI KH 400 A3/A4/A5	76-78		
MD4124LS	F	Floating	300	Silver	Plain	6			KAWASAKI EN 500 Vulcan 500 Ltd VN 800 Vulcan Classic VN 1500 C3/C4 VN 1500 Vulcan	96-09 96-05 96-97 87-99		
MD4125LS	F	Solid	300	N/A	Plain	N/A			KAWASAKI VN 800 Vulcan Classic VN 800 VN 1500 Vulcan Classic VN 1500 VN 1500 Classic Fi VN 1500 Vulcan 1500 Classic	96-05 99-06 96-04 99-05 00-02 05-08		
MD4128	R	Solid	270	N/A	Plain	N/A			KAWASAKI VN 1500 C3/C4 VN 1500 Vulcan Classic	96-97 96-00		
MD4130	R	Solid	250	N/A	Plain	N/A			KAWASAKI GPZ 1100 ZX GPZ 1100 ZX	95-97 96-97		
MD4130C	R	Solid	250	N/A	Contour	N/A						
VR4130	R	Solid	250	N/A	Vee	N/A						
MD4132X	F	Floating	300	Gold	Plain	6			KAWASAKI GPZ 1100 F1 ABS Model	96-97		
MD4132XC	F	Floating	300	Gold	Contour	6						
VR4132BLK	F	Floating	300	Black	Vee	6						
VR4132GRN	F	Floating	300	Green	Vee	6						
MD4133	R	Solid	250	N/A	Plain	N/A			KAWASAKI ZR 1100 ZRX ZRX 1200 R ZR ZX 1200 ZZR	99-00 01-05 02-05		
MD4133C	R	Solid	250	N/A	Contour	N/A						
VR4133	R	Solid	250	N/A	Vee	N/A						
MD4136X	F	Floating	300	Gold	Plain	6			KAWASAKI ZX 6R 600cc ZX 6R 636cc ZZR 600 ZX ZX 9R ZX 900cc	98-02 02 05-08 98-99		
MD4136XC	F	Floating	300	Gold	Contour	6						
VR4136BLK	F	Floating	300	Black	Vee	6						
VR4136GRN	F	Floating	300	Green	Vee	6						
MD4137RS	F	Solid	260	N/A	Plain	N/A			KAWASAKI BN 125	01-09		
MD4138	R	Solid	250	N/A	Plain	N/A			KAWASAKI ZX 6R ZX 600cc ZX 6R ZX636cc ZX 6R ZX 636cc ZX 6RR ZX 600cc ZX 6R ZX 636cc ZX6R ZX 600cc ZZR 600 ZX ER 650 ER-6N EX 650 Ninja EX EX 650 R EX CBF KLE 650 Versys Ninja 650 R EX Z 650 ER ABS Z 750 S ZR ZX 9R ZX 900cc Z 1000 ZR Z 1000 ZR ZX 10R ZX 1000cc ZX 10R ZX 1000cc	98-02 02 05-06 03-05 03-04 07-12 05-08 09-10 12-15 11 07-14 06-10 17 05-06 98-03 03-05 06 04-07 08-10		
MD4138C	R	Solid	250	N/A	Contour	N/A						
VR4138	R	Solid	250	N/A	Vee	N/A						
MD4141X	F	Floating	300	Silver	Plain	6					KAWASAKI ZX 600 ZX6 ZR 750 ZR7S All Models	90-93 00-06
MD4141XC	F	Floating	300	Silver	Contour	6						
MD4141CC	F	Floating	300	Chrome	Contour	6						

BRAKE ROTOR BUYERS GUIDE - STREET

Rotor No.	F/R	Type	Dia. (mm)	Hub Color	Profile	Bobbins	Left Bracket	Right Bracket	Model	Year
MD4142 MD4142C	R R	Solid Solid	240 240	N/A N/A	Plain Contour	N/A N/A			KAWASAKI ZR 750 F2 ZR-7 ZR 750 H1/H2/H3/H4/H5 ZR7S	00-01 01-05
MD4146 MD4146C	R R	Solid Solid	300 300	N/A N/A	Plain Contour	N/A N/A			KAWASAKI VN 1500 P1/P2 VN 1600 Classic VN 1600 Mean Streak VN 1600 Nomad SUZUKI VZ 1600 K4 Marauder VZ 1600 K5 M95 Boulevard/Marauder	02-03 03-08 04-08 05-08 04 05
MD4147	R	Solid	320	N/A	Plain	N/A			KAWASAKI VN 1500 VN 2000 D1/D6F Vulcan Ltd VN 2000 Vulcan VN 2000 Vulcan Classic	99-05 05-06 04-09 06-09
MD4148	R	Solid	270	N/A	Plain	N/A			KAWASAKI VN 2000 Vulcan Classic LT VN 800 VN 1500 VN 1500 Vulcan 1500 Classic	06-09 99-06 00-05 05-08
MD4150	F	Solid	280	N/A	Plain	N/A			KAWASAKI VN 1500	99-05
MD4151X MD4151XC	F F	Floating Floating	280 280	Gold Gold	Plain Contour	6 6			KAWASAKI ZX 6RR ZX 600cc ZX 6R ZX 636cc	03-04 03-04
MD4152XC VR4152BLK VR4152GRN	F F F	Floating Floating Floating	300 300 300	Gold Black Green	Contour Vee Vee	6 6 6			KAWASAKI ZX6RR ZX 600cc ZX6R ZX 636cc ZX6R ZX 600cc ZX 1000cc ZX10R Z 1000 ZR	05-06 05-06 07-12 04-07 07-08
MD4153X MD4153XC VR4153BLK VR4153GRN	F F F F	Floating Floating Floating Floating	300 300 300 300	Gold Gold Black Green	Plain Contour Vee Vee	6 6 6 6			KAWASAKI ZX 600 ZZR	96-05
MD4154X MD4154XC VR4154BLK VR4154GRN	F F F F	Floating Floating Floating Floating	300 300 300 300	Gold Gold Black Green	Plain Contour Vee Vee	6 6 6 6			KAWASAKI Z 1000 ZR ZX 12 R EX 1200cc	03-06 04-05
MD4155X MD4155XC VR4155BLK VR4155GRN	F F F F	Floating Floating Floating Floating	310 310 310 310	Gold Gold Black Green	Plain Contour Vee Vee	6 6 6 6			KAWASAKI ZX-6R ZX-6R 30th Anniversary Edition ZX-6R KRT Edition ZX-6R 636cc ABS ZX-6R 30th Anniversary Edition ABS ZX6R KRT Edition ABS ZX-6R ABS ZX-6R KRT Edition ABS ST 700 KLZ 1000 Versys SE LT ABS KLZ 1000 Verseys SE LT+ ABS Z 1000 ABS ZR 1000 G ABS Model Concours 14 ZG 1400 A/C/E ABS Concours 14 ZG 1400 B/D ZX 14 Rall Models ZX 14 R ABS	13-17 15 16-17 13-17 15 16-17 18-24 18-24 14-18 18-21 19-21 14-20 08-21 08-10 06-11 12-23

BRAKE ROTOR BUYERS GUIDE - STREET

Rotor No.	F/R	Type	Dia. (mm)	Hub Color	Profile	Bobbins	Left Bracket	Right Bracket	Model	Year
MD4156XC (Right side no ABS ring)	F	Floating	300	Gold	Contour	6			KAWASAKI EX 650 Ninja ABS Ninja KRT Edition ABS Z 650 ER ABS Z 650 ABS	17-23 18-23 17 18-23
MD4156AXC (Left side with ABS ring fitted)	F	Floating	300	Gold	Contour	6			KAWASAKI EX 650 Ninja ABS KLE 650 Verseys Ninja KRT Edition ABS Z 650 ER ABS Z 650 ABS	17-23 20-23 18-23 17 18-23
MD4157C VR4157	R R	Solid Solid	250 250	N/A N/A	Contour Vee	N/A N/A			KAWASAKI KAWASAKI Z 900 ABS KAWASAKI Z900 RS KAWASAKI Z900 RS Café Versys LT ABS Versys SE LT ABS Verseys SE LT+ ABS Z 1000 ZR B Z 1000 ZR C Z 1000 ABS ZR ABS ZX10 R Ninja ZX 1000cc ZX10 R Ninja ABS ZX 1000cc ZX10 R Ninja ABS ZX 1000cc ZX 14 R ZX 14 R ABS ZX 14 R ABS ZX 14 R ABS ZX 14 R ABS Performance ZX 14 R ABS Performance Sport	18-23 18-23 18-23 18-23 18-23 19-23 07-08 07 14-20 11-13 12-13 14-19 06-07 06-07 08-11 12-21 12-19 14-23
MD4158	F	Solid	300	N/A	Plain	N/A			KAWASAKI W 800 Solid Front Disc VN 900 Classic VN 900 BBFA/CCFA Vulcan Custom Special Edition KAWASAKI VN 900 Vulcan Classic LT KAWASAKI VN 900 Vulcan Classic KAWASAKI VN 900 Vulcan Custom VN 1600 Nomad VN 1700 Vulcan Voyager VN1700 Vulcan ABS VN 1700 Vulcan Nomad VN 1700 Vulcan Nomad VN 1700 Vulcan Nomad ABS VN 1700 Vulcan Classic VN 1700 Vulcan Classic LT VN 1700 Vaquero ABS VN 1600 VN 2000 Vulcan Ltd VN 2000 Vulcan VN 2000 Vulcan Classic VN 2000 Vulcan Classic LT	11-12 06-21 11-12 06-22 06-22 07-22 05-08 09-12 09-22 09-12 09 14 09-12 09-12 14-22 03-08 05-06 04-09 06-09 06-10
MD4159XC VR4159BLK VR4159GRN	F F F	Floating Floating Floating	300 300 300	Gold Black Green	Contour Vee Vee	6 6 6			KAWASAKI ER 650 ER-6N EX 650 Ninja R EX 650 Ninja EX EX 650 R EX CBF KLE 650 Versys	09 06-10 12-15 11 07-23
MD4160C VR4160	R R	Solid Solid	270 270	N/A N/A	Contour Vee	N/A N/A			KAWASAKI Concours 14 ZG 1400cc Concours 14 ABS ZG 1400cc	08-11 08-14

BRAKE ROTOR BUYERS GUIDE - STREET

Rotor No.	F/R	Type	Dia. (mm)	Hub Color	Profile	Bobbins	Left Bracket	Right Bracket	Model	Year
MD4161X MD4161XC VR4161BLK VR4161GRN	F F F F	Floating Floating Floating Floating	310 310 310 310	Gold Gold Black Green	Plain Contour Vee Vee	6 6 6 6			KAWASAKI ZX 10 R ZX 10 R ZX 1000cc ZX 10 R ZX 1000 ABS ZX 10 R ZX 1000cc 30th Anniversary Edition ABS	08-10 11-15 12-15 15
MD4162C MD4162XC VR4162BLK VR4162GRN	F F F F	Solid Floating Floating Floating	290 290 290 290	N/A Gold Black Green	Contour Contour Vee Vee	N/A 6 6 6			KAWASAKI EX 250 Ninja R	08-12
MD4163C VR4163	R R	Solid Solid	220 220	N/A N/A	Contour Vee	N/A N/A			KAWASAKI EX 250 Ninja R EX 300 Ninja Ninja 300 SE	08-12 13-15 14-15
MD4164AC	R	Solid	220	N/A	Contour	N/A			KAWASAKI EX 650 Ninja EX ABS EX 650 Ninja EX 650 Ninja KRT Edition KLE 650 Versys ABS Z 650 ABS ZX-4RR 400cc	13-15 18-24 18-24 13 18-21 23-24
MD4165 MD4165C VR4165	R R R	Solid Solid Solid	220 220 220	N/A N/A N/A	Plain Contour Vee	N/A N/A N/A			KAWASAKI Z 125 BR125 ZX-6R ZX ZX-6R 30th Anniversary Edition ZX-6R KRT Edition ZX-6R ABS ZX-6R 30th Anniversary Edition ABS ZX-6R KRT Edition ABS ZX-6R ABS ZX-6R KRT Edition ABS EN 650 Vulcan S - EN A EN 650 Vulcan S ABS - EN 650 B EN 650 Vulcan S Café ABS EN 650 Vulcan S ABS SE ZX 10 R ZX 1000cc ZX 10 R ZX 1000cc ABS ZX 10 R ZX 1000cc 30th Anniversary Edition ABS ZX 10 R Ninja ZX 1000cc ZX 10 R Ninja KRT Replica ZX 1000cc Ninja ZX-10 RR ZX1000cc ZX10 R Ninja ABS ZX 1002cc ZX10 R Ninja ABS KRT Edition ZX 1002cc ZX10 RR Ninja ZX 1002cc	17-21 13-17 15 16-17 13-17 15 16-17 18-23 18-22 15-20 15-21 18-21 18-21 11-15 12-15 15 16-19 16-19 17-19 20-24 20-24 20-24
MD4166C MD4166X MD4166XC VR4166BLK VR4166GRN 5 bolt fixing	F F F F F	Solid Floating Floating Floating Floating	290 290 290 290 290	N/A Gold Gold Black Green	Contour Plain Contour Vee Vee	N/A 6 6 6 6			KAWASAKI Ninja 125 Z 125 EX 300 Ninja EX EX 300 Ninja EX Ninja 300 SE ABS ZX ZX-4RR 400cc	17-21 17-21 13-14 13-14 14-15 23-24
MD4167X MD4167XC	F F	Floating Floating	296 296	Gold Gold	Plain Contour	6 6			KAWASAKI ZX9R C1/C2	98-99
MD4169 7mm thickness	R	Solid	260	N/A	Plain	N/A			KAWASAKI KZ 550 D1 GPZ KZ 700 A1 KZ 750 E1-E3 KZ 750 F1 LTD KZ 750 H1-H4 LTD KZ 750 L3 KZ 750 N1/N2 Spectre KZ 750 R1 GPZ	81 84 80-82 83 80-83 83 82-83 82

BRAKE ROTOR BUYERS GUIDE - STREET

Rotor No.	F/R	Type	Dia. (mm)	Hub Color	Profile	Bobbins	Left Bracket	Right Bracket	Model	Year
MD4170X	F	Floating	330	Gold	Plain	6			KAWASAKI ZX10 R Ninja ABS ZX 1002cc ZX10 R Ninja ABS KRT Edition ZX 1002cc ZX10 RR Ninja ZX 1002cc	20-23 20-23 20-23
MD4171C OSX4171C	F F	Solid Floating	200 250	N/A Black	Contour Contour	N/A 6			KAWASAKI Ninja 125 ABS Z 125 BR Z 125 Pro BR Z 125 Pro SE BR	19-21 17-21 17-22 17-21
MD4172C	R	Solid	184	N/A	Contour	N/A			KAWASAKI Ninja 125 ABS Z 125 BR Z 125 Pro BR Z 125 Pro SE BR	19-21 17-21 17-21 17-21
MD4174X MD4174XC VR4174BLK VR4174GRN	F F F F	Floating Floating Floating Floating	310 310 310 310	Gold Gold Black Green	Plain Contour Vee Vee	6 6 6 6			KAWASAKI Ninja 400 all models Z 400 ABS	17-24 19-24
MD4175X	F	Floating	330	Gold	Plain	6			KAWASAKI ZX10 RR Ninja ZX 1002 GKF	18-24
MD4178AC	R	Solid	250	N/A	Plain	N/A			KAWASAKI KLE 650 F Versys/Versys LT ABS Model KLE 650 Versys 650 KLE 650 Versys 650 Tourer KLE 650 Versys 650 Grand Tourer	16-20 20-24 20-24 20-24
MD4179AC	R	Solid	220	N/A	Contour	N/A			KAWASAKI Ninja 125 ABS Z 125 ABS 300 Ninja EX 300 B ABS Model 300 Ninja SE EX 300 B ABS Model KLE 300 Versys-X Ninja 400 ABS Ninja 400 KRT ABS Z 400 ER400 Eliminator	19-21 19-21 13-16 13-16 18-21 17-23 18-22 19-23 24
MD4180	R	Solid	300	Black	Plain	N/A			KAWASAKI EN 650 Vulcan S	15-24
MD4181	F	Floating	300	Black	Contour	6			KAWASAKI Ninja 650 EX 650 ER 650	17-18 17-24
MD4182	R	Solid	250	N/A	Plain	N/A			KAWASAKI Ninja H2R ZX1000YLF	20-24
MD4183X 11.5mm offset 90mm PCD	F	Floating	330	Gold	Plain	6			KAWASAKI ZX 10 RR Ninja ZX 10 RR Ninja	17-24 19-24
MD4184X	F	Floating	320	Gold	Plain	6			KAWASAKI ZR 1000 SE Performance	20-24

BRAKE ROTOR BUYERS GUIDE - DIRTBIKE/ATV/UTV

Rotor No.	F/R	Type	Dia. (mm)	Hub Color	Profile	Bobbins	Left Bracket	Right Bracket	Model	Year
MD6001D MD6001CX OSX6001 OSX6001E SMX6001	F F F F F	Solid Solid Floating Floating Floating	240 240 280 280 320	N/A N/A Silver Silver Black	Plain Vee Contour Contour Contour	N/A N/A 6 6 6			HONDA CR 125 R CRF 230 F CRF 230 L CRF 230 M CR 250 R NX 250 XR 250 R Pro Link XR 250 R XR 250 L XR 400 R CR 500 R XR 600 R XR 650 R	92-94 03-20 08-11 09-11 92-94 88-90 91-95 96-04 91-96 96-04 92-94 91-00 00-07
MD6002D MD6002CX	R R	Solid Solid	220 220	N/A N/A	Plain Vee	N/A N/A			HONDA CR 125 R CR 250 R CR 500 R	89-97 89-96 89-00
MD6003D	F	Solid	240	N/A	Plain	N/A			HONDA CR 125 R / CR 250 R / CR 500 R	90-91
MD6004D	F	Solid	215	N/A	Plain	N/A			HONDA CR 80 R	86-95
MD6005D MD6005CX	R R	Solid Solid	190 190	N/A N/A	Plain Vee	N/A N/A			HONDA CR 80 R CR 80 R/RB Expert CR 85R/85R Expert	92-95 96-02 03-07
MD6006D	F	Solid	174	N/A	Plain	N/A			HONDA TRX 250 R 'Fourtrax' TRX 250 EX Sportrax 250 EX TRX 250 X TRX 300 EX Fourtrax TRX 300 X TRX 400 EX Fourtrax TRX 400 X TRX 450 R/ER Sportrax TRX 700 XX	88-92 01-07 09-14 93-08 09-11 99-08 09-14 04-14 08-11
MD6007D	R	Solid	186	N/A	Plain	N/A			HONDA ATC 250 R TRX 250 R 'Fourtrax'	85-86 86-89
MD6008D	F	Solid	240	N/A	Plain	N/A			HONDA CR 125 R / CR 250 R / CR 500 R	89
MD6009D	R	Solid	220	N/A	Plain	N/A			HONDA CR 125 R / CR 250 R / CR 500 R	87-88
MD6010D SMX6010 MD6010CX	F F F	Solid Solid Solid	256 320 256	N/A N/A N/A	Plain Contour Vee	N/A N/A N/A			HONDA NX 650 XR 650 L	88-89 93-21
MD6011D	R	Solid	220	N/A	Plain	N/A			YAMAHA YZ 125 2T WR 125 K 2T YZ 250 2T YZ 250 W 2T WR 250 Z 2T WR 400 F 4T WR 500 2T	88-97 98 88-97 89-90 91-97 98 92-93
MD6012D	F	Solid	245	N/A	Plain	N/A			YAMAHA YZ 125 A/B YZ 250 A/B WR 250 ZB	90-91 90-91 91

BRAKE ROTOR BUYERS GUIDE - DIRTBIKE/ATV/UTV

Rotor No.	F/R	Type	Dia. (mm)	Hub Color	Profile	Bobbins	Left Bracket	Right Bracket	Model	Year
MD6013D MD6013CX	R R	Solid Solid	220 220	N/A N/A	Plain Contour	N/A N/A			HONDA CRF 230 L CRF 230 M XR 250 R Pro Link XR 250 R XR 250 L XR 400 R XR 600 R	08-11 09-11 90-95 96-04 91-96 96-04 91-00
MD6014D MD6014CX	R R	Solid Solid	220 220	N/A N/A	Plain Vee	N/A N/A			KAWASAKI KLX 400 R B KLX 400 SR A SUZUKI RM 125 J RM 125 2T RM 250 H/J RM 250 2T RMX 2502T DR-Z 400 S DR-Z 400 E	03-04 03-04 88 89-98 87-88 89-98 89-98 00-24 00-07
MD6015D MD6015CX OSX6015 SMX6015	F F F F	Solid Solid Floating Floating	250 250 280 320	N/A N/A Silver Black	Plain Vee Contour Contour	N/A N/A 6 6		BRK023 BRK024	KAWASAKI KX 1252T KDX 200 E2T KDX 250 2T KLX 250 R D KX 250 2T KLX 300 R KLX 300 KLX 300 R KX 500 2T KLX 650 R	89-02 93-94 92-94 94-96 89-02 97-07 21-24 21-24 89-04 93-96
MD6016D	F	Solid	230	N/A	Plain	N/A			YAMAHA YZ 125 W YZ 250 W YZ 250 WRW WR 500 ZD/ZE	89 89 89 92-93
MD6017D MD6017CX OSX6017 OSX6017E SMX6017 SMX6017/1	F F F F F	Solid Solid Floating Floating Floating Floating	250 250 280 280 320 320	N/A N/A Silver Silver Black Black	Plain Vee Contour Contour Contour Contour	N/A N/A 6 6 6 6		BRK031 BRK024 BRK038	KAWASAKI KLX 400 R KLX 400 B1/B2 KLX 400 SR KLX 400 A1/A2 SUZUKI RM 125 2T DR-Z 250 RM 250 2T RMX 250 2T DR 350 SE DR-Z 400 S DR-Z 400 E	03-04 03-04 89-08 01-06 89-08 89-00 98-99 00-24 00-07
MD6018D OSX6018	F F	Solid Floating	200 250	N/A Silver	Plain Contour	N/A 6		BRK001	SUZUKI RM 80 RM 85	86-01 02-04
MD6020D	F	Solid	160	N/A	Plain	N/A			SUZUKI LT 230 E LT 230 S LT 250 R	86-93 85-90 85-92
MD6021D	R	Solid	220	N/A	Plain	N/A			CAN AM DS 450 XXC/XMX offroad without handbrake SUZUKI LT 250 R LT 230 EH Early axle 64710 22A00 LT 230 SF/SG LT 230 SH up to F no 2108531 LT 250 RF/RG	08-15 87-92 86 85-86 87 85-86

BUYERS GUIDE
BRAKE ROTORS

BRAKE ROTOR BUYERS GUIDE - DIRTBIKE/ATV/UTV

Rotor No.	F/R	Type	Dia. (mm)	Hub Color	Profile	Bobbins	Left Bracket	Right Bracket	Model	Year
MD6022D	F	Solid	170	N/A	Plain	N/A			SUZUKI LT 500 RH/RJ/RK/RL	87-90
MD6023D	R	Solid	240	N/A	Plain	N/A			SUZUKI LT 500 RH/RJ/RK/RL	87-90
MD6024D MD6024CX	R R	Solid Solid	220 220	N/A N/A	Plain Vee	N/A N/A			KAWASAKI KX 125 KDX 200 KX 250 KX 500 E	89-02 89-94 89-02 89-04
MD6025D MD6025C	R R	Solid Solid	185 185	N/A N/A	Plain Contour	N/A N/A			KAWASAKI KX 80 RM 80 RM 85 KX 100	88-00 90-01 02-04 95-00
MD6026D	F	Solid	220	N/A	Plain	N/A			KAWASAKI KX 80 KX 100	92-00 95-00
MD6027D	F	Solid	200	N/A	Plain	N/A			KAWASAKI KX 80 KX 80	88-91 84-87
MD6028D MD6028CX OSX6028 OSX6028E SMX6028	F F F F F	Solid Solid Floating Floating Floating	245 245 280 280 320	N/A N/A Silver Silver Black	Plain Vee Contour Contour Contour	N/A N/A 6 6 6		BRK035	YAMAHA YZ 125 WR 125 K YZ 250 YZ 250 WRA WR 250 Z WR 400 F YZ 400 F WR 426 F YZ 426 F	98-00 98 92-00 90 92-97 98-00 98-99 01-02 00-02
MD6029D	F	Solid	190	N/A	Plain	N/A			YAMAHA YZ 80	86-92
MD6030D MD6030CX OSXY6030 OSXS6030	F F F F	Solid Solid Floating Floating	220 220 250 250	N/A N/A Silver Silver	Plain Vee Contour Contour	N/A N/A 6 6		BRK036 BRK029	SUZUKI RM 85 YAMAHA YZ 80 YZ 85 YZ 85 LW	05-23 93-01 02-24 21-24
MD6031D MD6031CX MD6031CX	R R R	Solid Solid Solid	190 190 190	N/A N/A N/A	Plain Vee Vee	N/A N/A N/A			YAMAHA YZ 80 YZ 85 YZ 85 LW	93-01 02-24 21-24
MD6032D MD6032CX OSX6032 OSX6032E OSX6032 OSX6932 OSX6032E SMX6032 SMX6032E SMX6032 SMX6032E SMX6932	F F F F F F F F F F F	Solid Solid Floating Floating Floating Floating Floating Floating Floating Floating Floating	260 260 280 280 280 280 280 320 320 320 320	N/A N/A Silver Silver Orange Silver Silver Orange Black Black Orange Orange Black	Plain Vee Contour Contour Contour Contour Contour Contour Contour Contour Contour	6 6 6 6 6 6 6 6 6 6 6		BRK011 BRK015 BRK011 BRK013 BRK015 BRK012 BRK016 BRK014	ATK ATK 250 ATK 370 ATK 500 ATK 620 Intimidator ATK 700 Intimidator BETA 125 RR Enduro 200 RR Enduro 250 RR Enduro X-Trainer 300 300 RR Enduro 350 RR-S Enduro 390 RR-S Enduro 430 RR-S Enduro 480 RR Enduro Enduro RR 480	04 04 04 04 04 20-24 20-24 20-24 20-23 20-24 20-24 20-24 20-24 20-24 20-24 20-21

BUYERS GUIDE
BRAKE ROTORS

BRAKE ROTOR BUYERS GUIDE - DIRTBIKE/ATV/UTV

Rotor No.	F/R	Type	Dia. (mm)	Hub Color	Profile	Bobbins	Left Bracket	Right Bracket	Model	Year
MD6032D	F	Solid	260	N/A	Plain				Enduro RR 500	20-22
MD6032CX	F	Solid	260	N/A	Vee				GAS-GAS PIERER	
OSX6032	F	Floating	280	Silver	Contour	6	BRK011		MC 125	21-23
OSX6032E	F	Floating	280	Silver	Contour	6	BRK015		EC 250 2T	21-23
OSX6032	F	Floating	280	Orange	Contour	6	BRK011		EX 250 2T	21-23
OSX6932	F	Floating	280	Silver	Contour	6	BRK013		EC 250 F	21-23
OSX6032E	F	Floating	280	Orange	Contour	6	BRK015		EX 250 F	21-23
SMX6032	F	Floating	320	Black	Contour	6	BRK012		MC 250 F	21-23
SMX6032E	F	Floating	320	Black	Contour	6	BRK016		EC 300 2T	21-23
SMX6032	F	Floating	320	Orange	Contour	6			EX 300 2T	21-23
SMX6032E	F	Floating	320	Orange	Contour	6			EC 350 F	21-23
SMX6932	F	Floating	320	Black	Contour	6	BRK014		EX 350 F	21-23
Contd.									MC 350 F	21-23
									EX 450 F	21-23
									MC 450 F	21-23
									HUSABERG	
									HUSABERG All MX/Enduro models	00-08
									TE 250	11-14
									TE 300	11-14
									FE 390	10-12
									FE 450	09-14
									FX 450	10-11
									FE 501	13-14
									FE 570	09-12
									HUSQVARNA	
									TC 125	14-24
									TE 125	14-17
									TX125	18-19
									TE 150i	18-24
									FC 250	14-24
									FE 250	14-22
									FX 250	14-24
									TC 250	14-24
									TE 250	14-19
									TE 250i	19-24
									TE 300	14-19
									TE 300i	19-24
									TX 300i	18-24
									FC 350	14-24
									FE 350	14-24
									FX 350	18-24
									FC 450	14-24
									FE 450	14-24
									FX 450	18-24
									FC 501	14
									FE 501	14-24
									KTM	
									EXC/EGS 125	94
									EXC 125	95-99
									EXC 125	00-03
									EXC 125	04-08
									EXE 125	
									MX 125	92-93
									MX 125	92-93
									SX 125	94-99
									SX 125	00-03
									SX 125	04-08
									SX 125	09-24
									XC 125	20-24
									SX 150	08
									SX 150	09-24
									XC 150	10-19
									XC-W 150 Tpi	19-24
									EXC/EGS 200	98-99
									EXC/EGS 200	00-03
									XC/EXC 200	04-08
									XC-W 200	07-09
									XC-W 200	10-16
									XC 200	06-09

BRAKE ROTOR BUYERS GUIDE - DIRTBIKE/ATV/UTV

Rotor No.	F/R	Type	Dia. (mm)	Hub Color	Profile	Bobbins	Left Bracket	Right Bracket	Model	Year
MD6032D	F	Solid	260	N/A	Plain				D-XC/E-XC/T-XC/E-GS 250	92-93
MD6032CX	F	Solid	260	N/A	Vee				EXC/EGS 250	94
OSX6032	F	Floating	280	Silver	Contour	6	BRK011		EXC 250	95-99
OSX6032E	F	Floating	280	Silver	Contour	6	BRK015		EXC 250	00-03
OSX6032	F	Floating	280	Orange	Contour	6	BRK011		XC/EXC 250	04-07
OSX6932	F	Floating	280	Silver	Contour	6	BRK013		EXC-F 250	06-07
OSX6032E	F	Floating	280	Orange	Contour	6	BRK015		EXC-F 250	18-24
SMX6032	F	Floating	320	Black	Contour	6	BRK012		MX 250	92-93
SMX6032E	F	Floating	320	Black	Contour	6	BRK016		SX 250	94-99
SMX6032	F	Floating	320	Orange	Contour	6			SX 250	00-02
SMX6032E	F	Floating	320	Orange	Contour	6			SX 250	03-08
SMX6932	F	Floating	320	Black	Contour	6	BRK014		SX 250	09-24
Contd.									SX-F 250	05-08
									SX-F 250 Factory Edition	15
									SX-F 250 Factory Edition	23-24
									SX-F 250	09-24
									XC 250	06-09
									XC 250	10-22
									XC-W 250	06-08
									XC-W 250 Tpi	10-24
									XC 250 Tpi	19-24
									XC-F 250	06-09
									XC-F 250	10-24
									XCF-W 250	06-10
									XCF-W 250	12-19
									XCF-W 250 Six Days	2011
									EGS 300	94-98
									EXC 300	94-98
									EXC 300	99-03
									EXC 300	04-05
									MXC 300	94-98
									MXC 300	99-03
									MXC 300	04-06
									SX 300	94-96
									SX 300	23-24
									XC 300	06-09
									XC 300	10-19
									XC 300 Tpi	19-24
									XC-W 300	06-09
									XC-W 300	10-18
									XC-W 300 Tpi Inc Erzberg Rodeo & HardEnduro	19-24
									XC-W 300 Six Days	14-18
									EXC 350	94-95
									EXC 350	96-97
									EXC-F 350	12-24
									SX-F 350	10-24
									SX-F 350 Factory Edition	22-24
									XC-F 350 Inc Kailub Russell	10-24
									XCF-W 350	12-24
									SX 360	96-97
									EXC 380	98-99
									EXC 380	00-03
									SX 380	98-99
									SX 380	00-03
									EXC/EGS 400	00-02
									EXC 400 Racing	00-03
									XC/EXC 400	04-07
									SC 400 Supercompetition LC4	96-99
									SX 400	00-02
									XC-W 400	08-09
									XC-W 400	10-11
									EXC 440	94-95
									SX 440	94-95
									EXC 450	03-09
									EXC 450	10-11
									EXC-F 450/Six Days	18-19
									EXC-R 450	08
									SX-F 450	03-08
									SX-F 450 Inc Factory Edition	09-24

BRAKE ROTOR BUYERS GUIDE - DIRTBIKE/ATV/UTV

Rotor No.	F/R	Type	Dia. (mm)	Hub Color	Profile	Bobbins	Left Bracket	Right Bracket	Model	Year
MD6032D	F	Solid	260	N/A	Plain				XC/EXC 450	04-07
MD6032CX	F	Solid	260	N/A	Vee				XC-F 450	08-09
OSX6032	F	Floating	280	Silver	Contour	6	BRK011		XC-F 450	13-24
OSX6032E	F	Floating	280	Silver	Contour	6	BRK015		XCR-W 450	2008
OSX6032	F	Floating	280	Orange	Contour	6	BRK011		XCR-W 450	2013
OSX6932	F	Floating	280	Silver	Contour	6	BRK013		XC-W 450 Six Days/Champion Edition	2010
OSX6032E	F	Floating	280	Orange	Contour	6	BRK015		XC-W 450	08-16
SMX6032	F	Floating	320	Black	Contour	6	BRK012		XCF-W 450	23-24
SMX6032E	F	Floating	320	Black	Contour	6	BRK016		XC-W 450 Champions Edition	10
SMX6032	F	Floating	320	Orange	Contour	6			XC-W 450 Six Days	10-11
SMX6032E	F	Floating	320	Orange	Contour	6			EXC-F 500	12-24
SMX6932	F	Floating	320	Black	Contour	6	BRK014		EXC 500 Six Days	16-22
Contd.									XCF-W 500	21-22
									XCF-W 500	23-24
									SX-F 505	07-08
									XC-F 505	08-09
									EXC 520	01-03
									SX 520	01-03
									EXC 525	03
									EXC 525	04-07
									MXC 525	03
									MXC 525	04
									SX 525	03-06
									XC 525 Desert Racing	07
									EXC-R 530 EXC-R 530	08
									EXC 530	09-10
									EXC 530	11
									XCR-W 530	08
									XC-W 530	08-09
									XC-W 530 Six Days	10
									MXC 550	96
									EGS-E 620 Adventure/Rallye	99
									SC 620 Supercompetition	96-00
									SX 620/EXC/EGS	94
									SX EXC/EGS 620	95
									SX 620	96-99
									LC4 625 SC Supercompetition	02
									SXC 625	03-04
									SXC 625	05-06
MD6034D	F	Solid	220	N/A	Plain	N/A			KTM	
									D-XC/E-XC/E-GS 125	90-93
									EXC 125 B	89
									DXC/EXC 250	90
									DXC/E-XC/E-GS 250	91
									EXC/EGS 250	89
									DXC/EXC/EGS 350	90-91
									EXC 350	89
									LC-4 MX/EXC 500	89
									LC-4 EXC 500	90-91
									LC4 MX/EXC 600	89
									LC4 EXC 600	90-91
									LC4 EXC 600	90-93
MD6035D	R	Solid	220	N/A	Plain	N/A			ATK	
MD6035CE	R	Solid	220	N/A	Contour	N/A			250 2T	04
MD6035CX	R	Solid	220	N/A	Vee	N/A			370 2T	04
									500 2T	04
									620 Intimidator 2T	04
									700 Intimidator 2T	04
									GAS-GAS PIERER	
									MC 125	21-24
									EC 250 2T	21-24
									EX 250 2T	21-24
									EC 250 F	21-24
									EX 250 F	21-24
									MC 250 F	21-24
									EC 300 2T	21-24
									EX 300 2T	21-24

BUYERS GUIDE
BRAKE ROTORS

BRAKE ROTOR BUYERS GUIDE - DIRTBIKE/ATV/UTV

Rotor No.	F/R	Type	Dia. (mm)	Hub Color	Profile	Bobbins	Left Bracket	Right Bracket	Model	Year
MD6035D	R	Solid	220	N/A	Plain	N/A			EC 350 F	21-24
MD6035CE	R	Solid	220	N/A	Contour	N/A			EX 350 F	21-24
MD6035CX	R	Solid	220	N/A	Vee	N/A			MC 350 F	21-24
Contd.									EX 450 F	21-24
									MC 450 F	21-24
									HUSABERG	
									All MX/Enduro models	00-08
									All supermotard models	00-03
									FS Supermotard models	04
									FS Supermotard models	05-08
									TE 250	11-14
									TE 300	11-14
									FE 390	10-12
									FE 450	09-14
									FX 450	10-11
									FE 501	13-14
									FE 570	09-12
									FS 570 Supermoto	10-11
									HUSQVARNA	
									TC 85 SW 17/14	21-24
									TC 85 W 19/16	21-24
									TC 125	14-23
									TE 125	14-17
									TX125	18-19
									TE 150i	18-24
									FC 250	14-24
									FE 250	14-21
									FX 250	23-24
									TC 250	14-24
									TE 250	14-19
									TE 250i	19-24
									TE 300	14-19
									TE 300i	19-24
									TX 300 Tpi	18-24
									FC 350	14-24
									FE 350	14-24
									FX 350	18-24
									FS 450 Supermoto	14-21
									FC 450	14-24
									FX 450	18-24
									FC 501	14
									FE 501	14-24
									KTM	
									SX 85 SW 17/14	21-24
									SX 85 BW 19/16	21-24
									EXC 125	95-99
									SM 125	
									SX 125	94-99
									EXC 125	00-03
									EXC 125	04-08
									EXE 125	
									SX 125	00-03
									SX 125	04-08
									SX 125	09-24
									XC 125	20-24
									SX 150	2008
									XC 150	10-19
									XC-W 150 Tpi	20-24
									EXC/EGS 200	98-99
									EXC/EGS 200	00-03
									XC/EXC 200	04-08
									XC-W 200	07-09
									XC-W 200	10-16
									XC 200	06-09
									EXC/EGS 250	94
									EXC 250	95-99
									EXC 250	00-03
									XC/EXC 250	04-07
									EXC-F 250	06-07

BRAKE ROTOR BUYERS GUIDE - DIRTBIKE/ATV/UTV

Rotor No.	F/R	Type	Dia. (mm)	Hub Color	Profile	Bobbins	Left Bracket	Right Bracket	Model	Year
MD6035D	R	Solid	220	N/A	Plain	N/A			SX 250	94-99
MD6035CE	R	Solid	220	N/A	Contour	N/A			SX 250	00-02
MD6035CX	R	Solid	220	N/A	Vee	N/A			SX 250	03-08
Contd.									SX 250 2T	09-24
									SX-F 250	05-08
									SX-F 250 Factory Edition	15
									SX-F 250 Factory Edition	22-24
									SX-F 250	09-24
									SX-F 250 Troy Lee Designs	09-22
									XC 250	06-09
									XC 250	10-19
									XC-W 250	06-08
									XC-W 250 Tpi	10-24
									XC 250 Tpi	19-24
									XC-F 250	06-09
									XC-F 250	10-24
									XC-F-W 250	06-10
									XC-F-W 250	12-19
									XC-F-W 250 Six Days	11
									EGS 300	94-98
									EXC 300	94-98
									EXC 300	99-03
									EXC 300	04-05
									MXC 300	94-98
									MXC 300	99-03
									MXC 300	04-06
									SX 300	94-96
									SX 300	23-24
									XC 300	06-09
									XC 300	10-19
									XC 300 Tpi 2T	19-24
									XC-W 300	06-09
									XC-W 300 Inc ErzbergRodeo	10-22
									XC-W 300 Six Days	14-18
									EXC 350	96-97
									EXC-F 350	12-24
									SX-F 350	09-24
									SX-F 350 Factory Edition	18-24
									XC-F 350 Inc Kailub Russell	10-24
									XCF-W 350	12-23
									XW-F 350	23-24
									SX 360	96-97
									EXC 380	98-99
									EXC 380	00-03
									SX 380	98-99
									SX 380	00-03
									EXC/EGS 400	00-02
									EXC 400 Racing	00-03
									XC/EXC 400	04-07
									SX 400	00-02
									XC-W 400	08-09
									XC-W 400	10-11
									EXC 450	03
									EXC 450	09
									EXC 450	10-11
									EXC-R 450	08
									SMR 450	04
									SMR 450	05-06
									450 SMR	07-12
									450 SMR	21-22
									SX-F 450	03-08
									SX-F 450	09-24
									SX-F 450 Factory Edition	18-24
									XC/EXC 450	04-07
									XC-F 450	08-09
									XC-F 450	13-24
									XCR-W 450	08
									XCR-W 450	13
									XC-W 450 Six Days/Champion Edition	10

BUYERS GUIDE
BRAKE ROTORS

BRAKE ROTOR BUYERS GUIDE - DIRTBIKE/ATV/UTV

Rotor No.	F/R	Type	Dia. (mm)	Hub Color	Profile	Bobbins	Left Bracket	Right Bracket	Model	Year
MD6035D	R	Solid	220	N/A	Plain	N/A			XC-W 450	08-09
MD6035CE	R	Solid	220	N/A	Contour	N/A			XC-W 450	12-16
MD6035CX	R	Solid	220	N/A	Vee	N/A			XC-W 450 Champions Edition	10
Contd.									XC-W 450 Six Days	10-11
									EXC-F 500	12-24
									EXC 500 Six Days	16-22
									XCF-W 500	12-22
									XW-F 500	23-24
									LC-4 MX 500	90-91
									LC-4 EXC 500	90-91
									LC-4 MX 500	90-91
									LC-4 EXC 500	90-91
									SX-F 505	07-08
									XC-F 505	08-09
									EXC 520	01-03
									SX 520	01-03
									EXC 525	03
									EXC 525	04-07
									MXC 525	03
									MXC 525	04
									SMR 525	05
									SX 525	03-06
									XC 525 Desert Racing	07
									EXC-R 530	08
									EXC 530	09-10
									EXC 530	11
									XCR-W 530	08
									XC-W 530	08-09
									XC-W 530 Six Days	10
									MXC 550	96
									SMR 560	06
									SMR 560	07
									SMC 625	05-06
									SXC 625	03-04
									SXC 625	05-06
									690 Enduro	08
MD6036D	F	Solid	250	N/A	Plain	N/A			KAWASAKI	
									KX 125 E1/E2/F1	86-88
									KDX 200 C1/C2/C3	86-88
									KDX 200 E1/E2/E3/E4	89-92
									KX 250 E1/F1	87-88
									KX 500 C1/D1	87-88
MD6037D	F	Solid	240	N/A	Plain	N/A			HONDA	
MD6037CX	F	Solid	240	N/A	Vee	N/A			CR 125 R	95-07
OSX6037	F	Floating	280	Silver	Contour	6	BRK008		CR 250 R	95-08
SMX6037	F	Floating	320	Black	Contour	6	BRK009		CRF 250 R	04-14
									CRF 250 X	04-21
									CRF 450 R	02-14
									CRF 450 X	05-22
									CR 500 R	95-01
MD6038D	R	Solid	220	N/A	Plain	N/A			SUZUKI	
MD6038CX	R	Solid	220	N/A	Vee	N/A			DR 250	90-95
									DR 250	90-95
									DR 350	90-96
									DR 350	90-95
MD6039D	F	Solid	230	N/A	Plain	N/A			YAMAHA	
									YZ 125 U	88
									IT 200 S	86
									YZ 250 U/W	88-89
									TT 350 S/T	86-87
									YZ 490 U/W	88-89
									TT 600 N/S	85-86

BRAKE ROTOR BUYERS GUIDE - DIRTBIKE/ATV/UTV

Rotor No.	F/R	Type	Dia. (mm)	Hub Color	Profile	Bobbins	Left Bracket	Right Bracket	Model	Year
MD6040D MD6040CX OSX6040	F F F	Solid Solid Floating	250 250 280	N/A N/A Silver	Plain Vee Contour	N/A N/A 6			SUZUKI DR 250 DR 250 DR 350 DR 350	90-95 90-95 90-96 90-97
MD6042D MD6042CX SMX6042	F F F	Solid Solid Floating	260 260 320	N/A N/A Black	Plain Vee Contour			BRK017	KAWASAKI KLR 650 A	87-07
MD6044D	F	Solid	276	N/A	Plain	N/A			HONDA XL 600 V Transalp	89-90
MD6045D MD6045CX	R R	Solid Solid	220 220	N/A N/A	Plain Vee	N/A N/A			HONDA XR 650 L	93-24
MD6046D	F	Solid	166	N/A	Plain	N/A			HONDA TRX 250 R 'Fourtrax'	86-87
MD6047D	F	Solid	203	N/A	Plain	N/A			YAMAHA YTZ 250 N/S (Tri Moto)	85-86
MD6050D	R	Solid	220	N/A	Plain	N/A			YAMAHA YFS 200 Blaster	88-02
MD6051D	F	Solid	161	N/A	Plain	N/A			YAMAHA YFM 350 XT YFM 350 XU Warrior YFZ 350 Banshee T/U/W	87 88 87-89
MD6053D	R	Solid	220	N/A	Plain	N/A			YAMAHA YFM 350 F Wolverine YFM 350 X Warrior YFZ 350 Banshee T/U/W	95-05 88-89 87-89
MD6054D	F	Solid	161	N/A	Plain	N/A			YAMAHA YFM 125 R Raptor YFS 200 Blaster YFM 250 X Beartracker YFM 250 Bruin YFM 250 Big Bear YFM 250 R Raptor YFM 250 RSPA Special Edition YFM 250 R Special Edition YFM 250 R Special Edition Custom YFM 250 R YFM 350 X Warrior YFM 350 R Raptor YFZ 350 Banshee YFZ 450 R YFZ 450 LES Limited Edition YFZ 450 R Special Edition 3 spring clutch YFZ 450 RSE YFZ 450 S/T YFZ 450 SET Special Edition YFZ 450 SPV Special Edition YFZ 450 YZF 450 Bill Balance Edition YZF 450 Special Edition YFZ 450 YFM 660 R YFM 700 R Raptor YFM 700 RS Special Edition YFM 700 R Raptor YFM 700 R Raptor Special Edition YFM 700 50th Anniversary Edition YFM 700 R Raptor	11-13 03-06 01-04 05-06 07-09 08-13 11 08-09 08 11 90-04 04-13 90-06 09-13 04 14 04-05 05 06 06-11 06-07 06-08 12-13 01-05 06-14 07-14 13-14 09-15 06 13-15
MD6055D	R	Solid	245	N/A	Plain	N/A			YAMAHA YFM 350 X Warrior	90-04

BRAKE ROTOR BUYERS GUIDE - DIRTBIKE/ATV/UTV

Rotor No.	F/R	Type	Dia. (mm)	Hub Color	Profile	Bobbins	Left Bracket	Right Bracket	Model	Year
MD6057D	F	Solid	240	N/A	Plain	N/A			KAWASAKI KL 250 D2-D22 (KLR 250)	85-05
MD6058D MD6058CX OSX6058	F F F	Solid Solid Floating	220 220 280	N/A N/A Silver	Plain Vee Contour	N/A N/A 6		BRK026	HONDA CR 80 R/RB Expert CR 85R/85R Expert	96-02 03-07
MD6059D	F & R	Solid	206	N/A	Plain	N/A			HONDA ATC 200 X ATC 250 R ATC 350 X	83-87 83-86 85-86
MD6060D	F	Solid	156	N/A	Plain	N/A			HONDA ATC 250 R	81-82
MD6061D	R	Solid	206	N/A	Plain	N/A			HONDA ATC 350 X	85-86
MD6063D	R	Solid	220	N/A	Plain	N/A			SUZUKI LT 230 EH Late axle 64710 22A01 LT 230 EJ/EK/EL/EM/EN/EP LT 230 SH from F no 2108532/AJ LT 250	86 87-93 87-88 85-90
MD6064D	R	Solid	220	N/A	Plain	N/A			HONDA TRX 250 X 'Fourtrax' TRX 300 EX Fourtrax TRX 300 X	87-92 93-08 09-11
MD6066D	F	Solid	245	N/A	Plain	N/A			YAMAHA WR 200 D TT-R 250 L/M/N/P/R/S/TV	92 99-06
MD6067D	F	Solid	220	N/A	Plain	N/A			YAMAHA IT 225 S/T YZ 125 T TW 200 TT-R 225 XT 225 TT-R 230 XT 250 YZ 250 T YZ 490 N/S/T	86-87 87 01-24 99-04 92-07 05-24 08-24 87 85-87
MD6068D	F	Solid	245	N/A	Plain	N/A			YAMAHA XTZ 250 Lander F 21" / R 18" Wheels XTZ 250 Lander F 21" / R 18" Wheels XTZ 250 X F & R 17" Wheels XT 350 N/NC/S/SC XT 350 XT 350	07-14 16-18 08-10 85-86 87-90 91-00
MD6070D	F	Solid	267	N/A	Plain	N/A			YAMAHA XT 600 XT 600 XT 600 E	84-86 87-89 90-95
MD6072D	R	Solid	220	N/A	Plain	N/A			YAMAHA XT 600 E	90-95
MD6073D	F	Solid	230	N/A	Plain	N/A			SUZUKI DR 125 SP 125 G/H/J DR 200 G/H/J DR 200 SP 200 G/H/J	86-96 86-88 86-90 96-21 86-88

BRAKE ROTOR BUYERS GUIDE - DIRTBIKE/ATV/UTV

Rotor No.	F/R	Type	Dia. (mm)	Hub Color	Profile	Bobbins	Left Bracket	Right Bracket	Model	Year
MD6074D	F	Solid	260	N/A	Plain	N/A			SUZUKI DR 250 F SP 250 F	85 85
MD6075D	F	Solid	240	N/A	Plain	N/A			SUZUKI SP 600 F	85-87
MD6076D	F	Solid	280	N/A	Plain	N/A			SUZUKI DR 650 SL/SM	90-91
MD6077D	R	Solid	250	N/A	Plain	N/A			SUZUKI DR 650 S	90-95
MD6078D	F	Solid	300	N/A	Plain	N/A			SUZUKI DR 650 S	92-95
MD6080D	F	Solid	250	N/A	Plain	N/A			KAWASAKI KL 600 KLR	84-86
MD6081D	F	Solid	280	N/A	Plain	N/A			KAWASAKI KL 650 B2/B3 Tengai	90-91
MD6082D MD6082CX	R R	Solid Solid	230 230	N/A N/A	Plain Contour	N/A N/A			KAWASAKI KL 650 KLR KL 650 B2/B3 Tengai	87-07 90-91
MD6083D MD6083CX	F F	Solid Solid	250 250	N/A N/A	Plain Vee	N/A N/A			KAWASAKI KDX 200 H1-H11/H6F KDX 220 R A4-A12/A6F KDX 250 D1	95-06 97-06 91
MD6085D	R	Solid	230	N/A	Plain	N/A			KAWASAKI KLX 250 R D2/D3/D4 KLX 650 R A1/A2/A3 KLX 650 C1/C2/C3/C4	94-96 93-94 93-96
MD6086D	F	Floating	290	Gold	Plain	9			KAWASAKI KLX 650 C1/C2/C3/C4	93-96
MD6087D	F	Floating	240		Plain	9			HONDA CR 125/250 R XR 250 R Pro Link XL 350 R XR 350 R CR 500 R XR 500 R Pro Link XL 600 R XR 600 R	84-88 84-90 84-85 84-85 84-88 83-84 83-87 85-90
MD6094D MD6094CX SMX6094	F F F	Solid Solid Floating	290 290 320	N/A N/A Black	Plain Vee Contour	N/A N/A 6	BRK003		SUZUKI DR 650 S	96-24
MD6095D MD6095CX	R R	Solid Solid	240 240	N/A N/A	Plain Vee	N/A N/A			SUZUKI DR 650 S	96-24
MD6105D MD6105CX	R R	Solid Solid	220 220	N/A N/A	Plain Vee	N/A N/A			KAWASAKI KDX 200 H KDX 220 R KDX 250 D KLX 250 S H KLX 300 R KLX 650 R D1	95-06 97-06 91-94 06-07 97-07 96
MD6107D	R	Solid	210	N/A	Plain	N/A			KAWASAKI KL 250 Sherpa	00-09

BRAKE ROTOR BUYERS GUIDE - DIRTBIKE/ATV/UTV

Rotor No.	F/R	Type	Dia. (mm)	Hub Color	Profile	Bobbins	Left Bracket	Right Bracket	Model	Year
MD6110D MD6110CX	R R	Solid Solid	220 220	N/A N/A	Plain Vee	N/A N/A			SUZUKI DR-Z 250 K DR 350 SE	01-07 96-98
MD6121D	R	Solid	220	N/A	Plain	N/A			YAMAHA WR 200 D TT-R 250	92 99-06
MD6123D	F F	Solid Solid	180 180	N/A N/A	Plain Plain	N/A N/A			YAMAHA YFM 350 FX Wolverine YFM 350 FWB/LC Big Bear YFM 350 UL/ULC YFM 350 UL/ULC YFM 400 FAM/FAN/FAP Kodiak YFM 400 F Big Bear YFM 400 AM/AN YFM 400 NN/NHN/P/HP YFM 400 FWNHM/FHM Big Bear Buckmaster 4WD YFM 400 FAHM/MC/N/NC/P Kodiak 4x4 Kodiak/Hunter YFM 400 NR/NS 2x4 Big Bear YFM 400 S Big Bear 2WD YFM 400 FS/FT/FAV Big Bear 4WD YFM 400 FWBL Kodiak	95-05 99 99 99 00-02 00-06 00-01 00-02 01 00-02 03-04 04 04-06 99
MD6124D MD6124CX	R R	Solid Solid	240 240	N/A N/A	Plain Vee	N/A N/A			HONDA CR 125 R CR 250 R	98-01 97-01
MD6125D OSX6125 SMX6125	F F F	Solid Floating Floating	260 280 320	N/A Silver Black	Plain Contour Contour	N/A 6 6		BRK007	HUSQVARNA CR 125 SM 125 WR 125 WRE 125 CR 250 WR 250 TE 350 CR 360 WR 360 TE 410 TC 610 TC 610/E TE 610 TE 610/E	92-99 98-99 93-99 93-99 92-99 92-99 92-97 92-94 92-99 95-99 92-94 95-99 92-94 95-99
MD6126D	R	Solid	220	N/A	Plain	N/A			HUSQVARNA CR 125 SM 125 WR 125 WRE 125 WR 240 CR 250 WR 250 WR 260 TE 350 CR 360 WR 360 TE 410 TE 410 E TC 510 TE 510 SM 610 (6 bolt F disc) TC 610 TC 610/E TE 610 TE 610/E	91-99 98-99 91-99 93-99 90-91 91-99 90-99 90-91 90-97 92-94 92-99 95-99 00 90 90 98-99 91-94 95-99 91-94 95-00
MD6128D	R	Solid	220	N/A	Plain	N/A			APRILIA Pegaso 650 ie (All models)	99-04

BUYERS GUIDE
BRAKE ROTORS

BRAKE ROTOR BUYERS GUIDE - DIRTBIKE/ATV/UTV

Rotor No.	F/R	Type	Dia. (mm)	Hub Color	Profile	Bobbins	Left Bracket	Right Bracket	Model	Year
MD6129D	F	Solid	300	N/A	Plain	N/A			APRILIA Pegaso 650 ie (All models)	99-04
MD6130D MD6130CF MD6130DF	F F F	Solid Floating Floating	300 300 300	N/A Silver Silver	Plain Contour Plain	N/A 9 9			KTM EGS 400/EGS-E/LSE (LC4 Enduro) LC4-E 400 Enduro EGS 620 Enduro/EGS-E/LSE LC4-E 640 Enduro LC-4 640 Adventure LC-R 640 Adventure R 690 Enduro	96-99 00-01 96-99 00-04 99-02 00 08
MD6131D	F	Solid	200	N/A	Plain	N/A			KAWASAKI KLF 300 C1-C17 Bayou KVF 300 A1/A2/A3/A4 (4 x 4) Prairie KVF 300 B1/B2/B3/B4 (2 x 4) Prairie KLF 400 B1-B7 Bayou (4 x 4) KVF 400 A1/A2/B1 Prairie KVF 400 C1/C2/C3/C4 (4 x 4) Prairie KVF 400 D1/D2/D3/D4 (2 x 4) Prairie LTA 700 XK5 Kingquad	89-05 99-02 99-02 93-99 97-98 99-02 99-02 05
MD6132D	R	Solid	220	N/A	Plain	N/A			KAWASAKI KSF 250 Mojave KEF 300 Lakota KEF 300 Lakota Sport	87-04 95-00 01-03
MD6133D	F	Solid	170	N/A	Plain	N/A			KAWASAKI KSF 250 Mojave KXF 250 Tecate KEF 300 Lakota KEF 300 Lakota Sport KLF 300 Bayou	87-04 87-88 95-00 01-03 88-04
MD6134D	R	Solid	220	N/A	Plain	N/A			KAWASAKI KXT 250 B2	87
MD6135D MD6135C MD6135CX MD6135CE	R R R R	Solid Solid Solid Solid	240 240 240 240	N/A N/A N/A N/A	Plain Contour Vee Contour	N/A N/A N/A N/A			YAMAHA YZ 125 K/L/M/N YZ 125 YZ 125 50th Anniversary Edition YZ 125 Monster Energy YZ 125 X YZ 250 X 2T YZ 250 2T YZ 250 50th Anniversary Edition YZ 250 Monster Energy 2T WR 250 F YZ 250 K/L/M/N YZ 250 F YZ 250 F 50th Anniversary Edition YZ 250 FX WR 400 FL/FM WR 426 FN YZ 400 FL YZ 426 FM/FN YZ 450 FX YZ 450 F YZ 450 50th Anniversary Edition	98-01 21-24 24 21-22 21-24 19-24 21-24 24 21-22 01-06 98-01 23-24 24 22-24 99-00 01 99 00-01 21-24 22-24 24
MD6136D	R	Solid	230	N/A	Plain	N/A			KAWASAKI KXF 250 A1/A2 Tecate	87-88
MD6137D	F	Solid	163	N/A	Plain	N/A			KAWASAKI KFX 450 R KSF KSV 700 KFX V-Force KSV 700 KFX V-Force	08-14 04-08 04-08

BRAKE ROTOR BUYERS GUIDE - DIRTBIKE/ATV/UTV

Rotor No.	F/R	Type	Dia. (mm)	Hub Color	Profile	Bobbins	Left Bracket	Right Bracket	Model	Year
MD6138D	F & R	Solid	206	N/A	Plain	N/A			KAWASAKI KXT 250 B1/B2	86-87
MD6140D	F	Solid	220	N/A	Plain	N/A			YAMAHA YFM 600 F Grizzly YFM 600 Grizzly Hunting	98-00 00
MD6144D	R	Solid	256	N/A	Plain	N/A			HONDA FL 400 R Pilot	89-90
MD6145D	F	Solid	206	N/A	Plain	N/A			SUZUKI LT-F 500 FW/FX/FY/FK1/FK2 Quadrunner LT-A 500 FY/FK1	98-02 00-01
MD6147D	F	Solid	165	N/A	Plain	N/A			POLARIS Trail Boss '4 x 4' Big Boss 250 '4 x 6' Trail Boss Trail Boss '2 x 4 / 4 x 4' Trail Blazer	87 89-90 88-90 88-89 90
MD6149D	F	Solid	228	N/A	Plain	N/A			POLARIS Big Boss 250 '4 x 6' Middle Axle Brake Big Boss 250 '6 x 6' Middle Axle Brake Big Boss 350 L Big Boss 300 '6 x 6' Middle Axle Brake Big Boss 400 L '6 x 6' Big Boss 500 '6 x 6' Magnum 325 2x4/4x4 Magnum 330 2x4/HDS 350 L '4 x 4' 250 '2 x 4 / 4 x 4' 400 L '4 x 4' Magnum 425 '4 x 4' Magnum 425 '6 x 6' Magnum 500 4x4 Sportsman 350 '4 x 4' Sportsman 400 L '4 x 4' Sportsman 400 Sportsman 500 '4 x 4' Sportsman 500 HO/EFI Sportsman/Worker 500 Sportsman 335 '4 x 4' Sportsman 6x6 500/Big Boss Sportsman 6x6 Trail Boss 350 L '4 x 4' Xplorer 400 L '4 x 4' Xplorer 500 '4 x 4' Xplorer 4x4/400 Xpedition 425 Diesel 455/4x4 EBS PTV Personal Task Vehicle 6x6 PPS/PTV 6x6/Series 10 Ranger PPS LUB 6x6	89-92 91-93 93 94 94-97 98-99 00 03-05 90 90 94 95-98 96-97 99-02 93 94-97 01-05 96-00 03-04 01-02 99-00 00-07 07-08 91 95-00 97 01-02 00 99-01 03 99 02
MD6150D	F	Solid	175	N/A	Plain	N/A			POLARIS Big Boss 250 '4 x 6' Big Boss 250 '6 x 6' Big Boss 300 '6 x 6' 350 L '2 x 4' 250 '2 x 4 / 4 x 4' 350 L '4 x 4' 300 '2 x 4 / 4 x 4' 400 L '2 x 4' Magnum 425 '2 x 4' Scrambler 400 L '4 x 4' Scrambler 500 '4 x 4' Sport 400 L/400	91-92 92-93 94 90 93 93 94-95 94-95 95-98 95-97 97 94-00

BUYERS GUIDE
BRAKE ROTORS

BRAKE ROTOR BUYERS GUIDE - DIRTBIKE/ATV/UTV

Rotor No.	F/R	Type	Dia. (mm)	Hub Color	Profile	Bobbins	Left Bracket	Right Bracket	Model	Year
MD6150D Contd.	F	Solid	175	N/A	Plain	N/A			Trail Boss 250 Trail Boss 250 '2 x 4 / 4 x 4' Trail Boss 350 L '2 x 4' Trail Blazer Trail Blazer '250' Xpress 300 / 400 L Xpress 300 '2 x 4' Xplorer 300 '4 x 4'	91-99 91-92 91-93 91-93 94-98 96-97 98-00 96-00
MD6153D	F	Solid	254	N/A	Plain	N/A			POLARIS Big Boss 400 L '6 x 6' Magnum 425 '6 x 6' Middle Axle Brake	96 96
MD6154D	R	Solid	150	N/A	Plain	N/A			POLARIS Sportsman 500	97
MD6155D	F	Solid	182	N/A	Plain	N/A			POLARIS Xplorer 250 Trailblazer/Freedom 250 Magnum 325 2x4/4x4 Muse Magnum 325 4x4/2x4 Trail Boss 325 Xpedition 325 Trail Boss 330 Scrambler 400 '4 x 4' Trailblazer 400 Scrambler 500 '4 x 4' Scrambler 4 x 4/2 x 4 Scrambler 500 2x4	00 99-06 01 02 00-01 00 03-04 98-02 03 98-10 00 01-02
MD6156D	R	Solid	178	N/A	Plain	N/A			POLARIS Magnum 325 2x4/4x4 Muse Trail Boss 325 Sport 400 (4x4) Trailblazer 400 Magnum 500 (4x4) Scrambler 400 (2x4/4x4) Scrambler 500 (2x4/4x4) Trail Blazer 250/Freedom Xpedition 325 Xpedition 425 (4x4) Xplorer 4x4/400 Trail Boss 325	00-01 01 99-00 03 00-01 98-02 98-04 99-06 00 00 01-02 00
MD6157D MD6157C MD6157CX	R R R	Solid Solid Solid	240 240 240	N/A N/A N/A	Plain Contour Vee	N/A N/A N/A			SUZUKI RM 125 RM 250 RMX 250 DR-Z 400 SM	99-05 99-05 99-00 13-24
MD6158D MD6158C	F F	Solid Solid	220 220	N/A N/A	Plain Contour	N/A N/A			YAMAHA TT-R 125	00-22
MD6160D	R	Solid	220	N/A	Plain	N/A			CAGIVA Gran Canyon 900	99-00
MD6161D	R	Solid	220	N/A	Plain	N/A			KAWASAKI KX 125 E1/E2/F1 KX 250 D2/E1/F1 KX 500 B2/C1/D1	86-88 86-88 86-88
MD6163D	F	Solid	240	N/A	Plain	N/A			SUZUKI RM 125 F/G/H/J RM 250 F/G/H/J	85-88 85-88
MD6164D	R	Solid	220	N/A	Plain	N/A			HONDA TRX 400 EX TRX 400 X	99-08 09-14

BRAKE ROTOR BUYERS GUIDE - DIRTBIKE/ATV/UTV

Rotor No.	F/R	Type	Dia. (mm)	Hub Color	Profile	Bobbins	Left Bracket	Right Bracket	Model	Year
MD6166D MD6166CX	F F	Solid Solid	180 180	N/A N/A	Plain Vee	N/A N/A			KAWASAKI KX 65 SUZUKI RM 65 K3/K4/K5	00-24 03-05
MD6166D MD6166CX	R R	Solid Solid	180 180	N/A N/A	Plain Vee	N/A N/A			KAWASAKI KX 65 SUZUKI RM 65 K3/K4/K5	00-24 03-05
MD6169D	R	Solid	203	N/A	Plain	N/A			POLARIS Xplorer 400 L 4x4	99-00
MD6170D	R	Solid	228	N/A	Plain	N/A			POLARIS Sportsman 6x6 PPS LUB 6x6	00-08 02
MD6171D	F	Solid	166	N/A	Plain	N/A			BOMBARDIER/BRP DS 650 DS 650 Baja/X CAN-AM DS 650 X	00-05 01-06 07
MD6172D	R	Solid	196	N/A	Plain	N/A			BOMBARDIER/BRP DS 650 DS 650 Baja/X CAN-AM DS 650 X	00-05 01-06 07
MD6173D UTVX6173 Front & Rear	F F	Solid Solid	202 202	N/A N/A	Plain Vee	N/A N/A			ARCTIC CAT 250 2 x 4 Utility 250 2 x 4 Utility 250 4 x 4 Utility 250 4 x 4 Utility 300 4 x 4 300 4 x 4 Utility 350 ATV 366 4 x 4 Auto Utility 366 SE 400 4 x 4 ACT 400 4 x 4 Auto ACT 400 2 x 4 Utility 400 2 x 4 Auto Utility 400 4 x 4 Utility 400 4 x 4 Utility 400 4 x 4 VP Utility 400 4 x 4 Auto Utility 400 4 x 4 Auto Utility 400 4 x 4 Auto LE Utility 400 4 x 4 Auto VP Utility 400 4 x 4 Auto TBX Utility 400 4 x 4 Auto TBX Utility 400 TRV 400 TRV H1 400 4 x 4 Auto TRV Multirider 400 4 x 4 Auto TRV Plus Multirider 425i 425i SE 450 H1 EFI 450i 450i Alterra 450i GT 450 TRV 450i TRV XC 450i 454 Bearcat 2 x 4 454 Bearcat 4 x 4 500 4 x 4 Auto Utility 500 4 x 4 Auto Utility 500 4 x 4 Auto LE Utility	99-04 05-09 01-04 05/08 98-04 05 12 08-09 10 04 04 98-04 04 00-04 05-07 05-06 04 05-08 05-07 05-06 04 05-06 09 10 06 07 12 12 10 11-12 16-22 12 11-12 11 11-12 97-98 96-98 98-04 05-08 05-06

BUYERS GUIDE
BRAKE ROTORS

BRAKE ROTOR BUYERS GUIDE - DIRTBIKE/ATV/UTV

Rotor No.	F/R	Type	Dia. (mm)	Hub Color	Profile	Bobbins	Left Bracket	Right Bracket	Model	Year
MD6173D UTVX6173 Contd.	F	Solid	202	N/A	Plain	N/A			500 4 x 4 Manual G/Box Utility	98-04
	F	Solid	202	N/A	Vee	N/A			500 4 x 4 Manual G/Box Utility	05-09
									500 4 x 4 Auto TBX Utility	04
									500 4 x 4 Auto TBX Utility	05-06
									500 4 x 4 Auto TRV Utility	04
									500 4 x 4 Auto TRV Multirider	05-06/08
									550 HI EFI	09-10
									550 HI EFI LE	09-10
									550 TRV	11
									550 TRV Cruiser	11
									550 TRV EFI	09-10
									550 TRV Efi LE	09-10
									550i	11-12
									550i LTD	11-12
									550i GT	11-12
									550i GT TRV	11
									550i TRV Cruiser	11
									550 GT TRV	11-12
									550 GT S TRV	10
									550 S	10
									550 S LTD	10
									650 H1 4 x 4 Auto Utility	04
									650 H1 4 x 4 Auto Utility	05/08
									650 H1 4 x 4 Auto LE Utility	07
									650 H1 4 x 4 SE Auto Utility	06
									650 H1	10
									650 Mudpro	10-11
									650 H1 Mudpro	10
									650 H1 TRV	09
									650 H1 TBX 4 x 4 Auto Utility	07
									650 H1 TRV 4 x 4 Auto Plus Multirider	07
									650 H1 TRV 4 x 4 Auto Plus LE Multirider	07
									650 H1 TRV 4 x 4 Auto	08
									650 TBX	09
									650 V2 4 x 4 Auto Utility	04-06
									650 V2 4 x 4 Auto LE Utility	04-05
									650 V2 4 x 4 Auto LE TS Utility	06
									700 Diesel Utility	07-08
									700i GT	11-12
									700 TRV H2 Efi Cruiser	09-10
									700 TRV	11-12
									700 TRV Cruiser	11-12
									700 TRV GT	11-12
									700 EFI 4 x 4 Utility	07-08
									700 EFI 4 x 4 LE Utility	06
									700 EFI 4 x 4 SE Utility	06
									700 EFI Cruiser	11
									700 EFI 4 x 4 Auto M4	08
									700 EFI 4 x 4 Auto TRV LE	08
									700 H1 EFI	09-10
								700 H1 EFI LE	09-10	
								700 H1 EFI 4 x 4 Auto SE	08-09	
								700 H1 TBX EFI	10	
								700 Super Duty Diesel	10-11	
								700 Mudpro	10-11	
								700 H1 EFI Mudpro	09-10	
								700i	11-12	
								700i LTD	11-12	
								700i Mudpro	11-13	
								700i Mudpro LTD	11	
								700 S	10	
								700 S LTD	10	
								700 TBX LTD	11	
								1000 H2 Mudpro EFI	10	
								1000 TRV Cruiser	11	
								1000 TRV H2 Efi Cruiser	09-10	
								Thundercat 1000 H2	08-10	
								Thundercat 1000 H2 LE	10	
								1000 TRV H2 Efi	10	

BRAKE ROTOR BUYERS GUIDE - DIRTBIKE/ATV/UTV

Rotor No.	F/R	Type	Dia. (mm)	Hub Color	Profile	Bobbins	Left Bracket	Right Bracket	Model	Year
MD6173D UTVX6173 Contd.	F F	Solid Solid	202 202	N/A N/A	Plain Vee	N/A N/A			KYMCO Maxxer 375 4 x 4 IRS MXU 375 4 x 4 IRS Maxxer 450 4 x 4 IRS MXU 450 4 x 4 IRS MXU 450 4 x 4 IRS LE MXU 500 4 x 4 Carb models MXU 500 4 x 4 IRS Carb Models MXU 500i IRS All EFI Models MXU 700i All Models	10-12 08-12 11-16 11-14 11-14 07-09 10-11 10-11 14-16
MD6173D UTVX6173	R R	Solid Solid	202 202	N/A N/A	Plain Vee	N/A N/A			ARCTIC CAT HDX 700 Prowler HDX 700 LTD Prowler XTZ 1000 Prowler Wildcat 1000 GT KYMCO Maxxer 375 4x4 IRS MXU 375 4x4 IRS Maxxer 450i IRS MXU 450 i IRS/IRS-LE	96-12 11-14 14 10-14 11-12 10-12 08-12 11-12 11-12
MD6174D	R	Solid	220	N/A	Plain	N/A			YAMAHA YFM 400 FA Kodiak YFM 400 AM/AN YFM 400 F Kodiak 4x4 Kodiak/Hunter YFM 450 FA Kodiak YFM 450 FX Wolverine Auto 4x4 YFM 450 FX Wolverine Sport Special Edition	00-02 00-01 00-02 03-04 07-10 07-08
MD6181D MD6181C MD6181CX	R R R	Solid Solid Solid	240 240 240	N/A N/A N/A	Plain Contour Vee	N/A N/A N/A			HONDA XR 650 R	00-11
MD6184D MD6184C OSX6184 OSX6184K OSX6184K9 SMX6184K SMX6184H SMX6184K9	F F F F F F F F	Solid Solid Floating Floating Floating Floating Floating Floating	260 260 280 280 280 320 320 320	N/A N/A Silver Silver Silver Black Black Black	Plain Contour Contour Contour Contour Contour Contour Contour	N/A N/A 6 6 6 6 6 6			HUSQVARNA CR 125 SM 125 SMS 125 2T SMS-4-125 4T WR 125 WRE 125 WXE 125 CR 250 TC 250 TE 250 TR 250 R 4T TXC 250 R 4T TXC 250 Cross Country WR 250 TE 310 4T TE 310 R 4T TXC 310 Cross Country TXC 310 R 4T WR 360 TE 400 TE 410 TE 410 E TC 449 TE 449 TC 450 TE 450 TXC 450 Cross Country TC 510 TE 510 TXC 510 Cross Country TE 511 TXC 511 Cross Country TC 570 TE 570	00-10 00 02-11 10-11 00-10 00-11 07 00-05 02-12 02-12 13 13 09-12 00-12 09-12 13 12 13 00-02 02 00/06 00 11-12 11-12 03/05-08 03-08 08 04-09 04-10 09-10 11-12 11-12 02-03 01-04

BUYERS GUIDE
BRAKE ROTORS

BRAKE ROTOR BUYERS GUIDE - DIRTBIKE/ATV/UTV

Rotor No.	F/R	Type	Dia. (mm)	Hub Color	Profile	Bobbins	Left Bracket	Right Bracket	Model	Year
MD6184D Contd.									SM 610 R TC 610 TE 610 TE 610 E TE 610/IE TE 630	00 00 00 00-03 06-09 10
MD6186D MD6186C MD6186CX OSX6186	F F F F	Solid Solid Solid Floating	220 220 220 280	N/A N/A N/A Silver	Plain Contour Vee Contour	N/A N/A N/A 6		BRK025	KAWASAKI KX 85 KX 100 KX 100 KX112 SUZUKI RM 100 K3	01-24 01-09 11-21 21-24 03
MD6187D MD6187CX	R R	Solid Solid	185 185	N/A N/A	Plain Vee	N/A N/A			KAWASAKI KX 85 KX 100 KX 100 KX112 SUZUKI RM 100 K3	01-24 01-09 11-21 21-24 03
MD6188D UTVX6188	F F	Solid Solid	200 200	N/A N/A	Plain Vee	N/A N/A			KAWASAKI KVF 360 Prairie 360 4x4 KVF 360 Prairie 360 KVF 360 Prairie 360 4x4 Hardwoods Green HD KVF 650 Prairie KVF 650 Brute Force 4x4 KVF 650 Brute Force 650 4x4 Hardwoods Green HD KVF 650 Brute Force 650 4x4i KV 650 Brute Force 650 4x4i KVF 650 Brute Force 650 4x4i Hardwoods Green HD KVF 650 Brute Force 4x4i KSV 700 KFX V-Force KVF 700 Team Green Special Edition KVF 700 Prairie 700 4x4 Hardwoods Green HD KVF 750 Brute Force 4x4i KVF 750 Brute Force 4x4i KVF 750 Brute Force 4x4i Hardwoods Green HD KVF 750 Brute Force 4x4i NRA Outdoors KVF 750 Brute Force 4x4i KVF 750 Brute Force 4x4i EPS SUZUKI LT-V 700 Twin Peaks 4x4	03-12 03-09 03-11 02-03 05-11 05-09 06-11 12 06-10 07-08 04 05-06 04-09 05-07 06-07 05/08-09 08-09 08/10-11 12-17 04-05
MD6189D	F	Solid	220	N/A	Plain	N/A			YAMAHA YFM 660 F Grizzly YFM 660 F Ducks Unlimited Edition Side x Side YFM 660 FAHDV/W Ducks Unlimited Edition/Side x Side	02-08 06-07 06-07
MD6190D MD6190CE MD6190CX	R R R	Solid Solid Solid	245 245 245	N/A N/A N/A	Plain Contour Vee	N/A N/A N/A			YAMAHA YZ 125 2T YZ 250 2T YZ 250 F 4T YZ 250 X 2T WR 250 F 4T YZ 426 FP WR 426 FP YZ 450 F YZ 450 FX WR 450 F	02-21 02-18 02-18 15-18 14-24 02 02 03-18 2021 03-24
MD6191D MD6191C MD6191CE MD6191CX	R R R R	Solid Solid Solid Solid	240 240 240 240	N/A N/A N/A N/A	Plain Contour Contour Vee	N/A N/A N/A N/A			HONDA CR 125 R CR 125 R CR 250 R CR 250 R CRF 250 R	02-03 04-07 02-03 04-07 04-14

BRAKE ROTOR BUYERS GUIDE - DIRTBIKE/ATV/UTV

Rotor No.	F/R	Type	Dia. (mm)	Hub Color	Profile	Bobbins	Left Bracket	Right Bracket	Model	Year
MD6191D MD6191C MD6191CE MD6191CX Contd.	R R R R	Solid Solid Solid Solid	240 240 240 240	N/A N/A N/A N/A	Plain Contour Contour Vee	N/A N/A N/A N/A			CRF 250 R AC CRF 250 RX CRF 250 X CRF 450 R CRF 450 R CRF 450 R CRF 450 R CRF 450 R-S F-disc 260mm, R-disc 240mm CRF 450 RWE CRF 450 RX CRF 450 X CRF 450 L CRF 450 RL	15-24 19-24 04-16 02-03 04-14 15-21 17-24 22-24 19-24 17-24 05-21 18-20 21-22
MD6192D MD6192C	F F	Solid Solid	198 198	N/A N/A	Plain Contour	N/A N/A			KTM 60 SX 65 SX	98-99 00-03
MD6195D	F	Solid	190	N/A	Plain	N/A			SUZUKI LT-F 400 King Quad All Models LT-F 4WD V/W Quadrunner 4WD 250cc LT-A 400 Eiger LT-A 400 Kingquad Auto LT-A 400 Eiger LT-F 400 Eiger 4WD LT-F 400 King Quad 400 FSi LT-F 400 King Quad 400 FSi Camo LT-F 400 K2 Eiger Manual 2WD LT-F 400 LT-F 400 Manual LT-A 500 Vinson 4WD LT-F 500 Vinson Quadrunner	09-23 97-98 02-07 08-09 06-18 02-07 11-15 11-15 02 03-08 08 02-07 03-05
MD6196D	R	Solid	216	N/A	Plain	N/A			SUZUKI LT-A 500 Vinson 4WD LT-F 500 Vinson Quadrunner	02-07 03-05
MD6197D	R	Solid	150	N/A	Plain	N/A			YAMAHA YFM 660 Grizzly YFM 660 Ducks Unlimited Edition SxS	02-08 06-07
MD6199D MD6199C	F F	Floating Floating	320 320	Gold Gold	Plain Contour	9 9			KTM Duke 400 LC4 Duke 620 LC4 LC4 620 SC Supermoto LC4 625 SC Supermoto SMC 625 LC4 640 Adventure -R LC4 640 Adventure 640 Duke Jet Black/Yellow/Adrenalin Orange Duke II 640 Orpheus/Titan/Lime Duke II 640 Black/Orange LC4-E 640 Supermoto	94-98 94-98 00 02 05 99-02 03 03-06 01 02 00-04
MD6200D	R	Solid	206	N/A	Plain	N/A			POLARIS Magnum 330 2x4/4x4/HDS ATP 330 4x4 ATV Pro 500 4x4 PPS Magnum 500 4x4 HDS PPS/PTV 4x4/Series 10 PPS/PTV 6x6/Series 10	03-06 04-05 02 02-04
MD6201D	R	Solid	218	N/A	Plain	N/A			POLARIS ATV Sportsman 400 ATV Sportsman 400 ATV Sportsman 400 ATV Sportsman 450 ATV Sportsman 500 4 x 4 ATV Sportsman 500 HO/EFI Demand Drive	03 04 04 06 96 03-04

BUYERS GUIDE
BRAKE ROTORS

BRAKE ROTOR BUYERS GUIDE - DIRTBIKE/ATV/UTV

Rotor No.	F/R	Type	Dia. (mm)	Hub Color	Profile	Bobbins	Left Bracket	Right Bracket	Model	Year
MD6201D Contd.	R	Solid	218	N/A	Plain	N/A			ATV Sportsman 500 EFI/HO	04-06
									ATV Sportsman 600 600 4 x 4	03-05
									ATV Sportsman 700 700 4 x 4/EFI	02-06
									ATV Sportsman 700 700 MV	05-06
									ATV Sportsman 800 EFI	05-06
									ACE SXS ACE 570 R08 All models	17-20
									ACE SXS ACE 570 EFI EURO R09	17-20
									Ranger SXS 499 Ranger	17
									Ranger SXS 500 Ranger Series 10 6 x 6	
									Ranger SXS 500 Ranger 500	17-20
									Ranger SXS 500 Ranger 500	21-22
									Ranger SXS Ranger Series 10	
									Ranger SXS Ranger 2 x 4 / 4 x 4	04-05
									Ranger SXS Ranger Series 11	
									Ranger SXS Ranger 6 x 6	04-05
									Ranger SXS Ranger TM	04-05
									Ranger SXS Ranger XP	05
									MD6202D UTVX6202	F F
ATV Hawkeye 325 2 x 4	15									
ATV Magnum 325 4 x 4 HDS	02									
ATV Sportsman 325 Ace	14									
ATV Sportsman 325 Ace EFI	15									
ATV Sportsman 325 Ace Euro	14-15									
ATV Sportsman 325 Ace HD	15									
ATV 330 ATP 4 x 4	04-05									
ATV Magnum 330 4 x 4/HDS	03-04									
ATV Trail Boss 330	10-13									
ATV Trail Blazer 330	10-13									
ATV Hawkeye 400 H.O. 2 x 4	13-14									
ATV Sportsman 400	04									
ATV Sportsman 400 HO 4 x 4	11-14									
ATV Sportsman 450	06									
ATV Sportsman 450	07									
ATV Sportsman 450 HO	17-20									
ATV Sportsman 450 HO	21-22									
ATV 500 ATP HO 4 x 4	04-05									
ATV 500 ATV Pro 4 x 4 PPS	02									
ATV Magnum 500 4 x 4 HDS	02-03									
ATV Scrambler 500 4 x 4	10-12									
ATV Sportsman 500 EFI/HO	04-06									
ATV Sportsman 500 EFI/HO	07-08									
ATV Sportsman 500 HO	08									
ATV Sportsman 500 HO	09-13									
ATV Sportsman 500 X2	06-08									
ATV Sportsman 500 X 2 EFI	07-09									
ATV Sportsman 500 Forest	12									
ATV Sportsman 500 Touring H.O.	08-11									
ATV Sportsman 500 Touring H.O.	11-13									
ATV Sportsman 500 EFI Quad H.O.	08-11									
ATV Sportsman 570 570 Ace	15-18									
ATV Sportsman 570 570 Ace Euro	15-18									
ATV Sportsman 570 Efi	11-20									
ATV Sportsman 570	21-23									
ATV Sportsman 570 EFI X2	15-21									
ATV Sportsman 570 Forest Tracker Efi/EPS	15									
ATV Sportsman 570 Touring EFI	14-21									
ATV Sportsman 570 Touring Tractor Efi EPS	16-21									
ATV Sportsman 570 6X6	17-21									
ATV Sportsman 570 6X6 Tractor	17-21									
ATV Sportsman 600 600 4 x 4	03-05									
ATV Sportsman 700 700 4 x 4/EFI	02-06									
ATV Sportsman 700 700 MV	05-06									
ATV Sportsman 700 700 EFI	07									

BUYERS GUIDE
BRAKE ROTORS

BRAKE ROTOR BUYERS GUIDE - DIRTBIKE/ATV/UTV

Rotor No.	F/R	Type	Dia. (mm)	Hub Color	Profile	Bobbins	Left Bracket	Right Bracket	Model	Year
MD6202D UTVX6202 Contd.	F	Solid	228	N/A	Plain	N/A			ATV Sportsman 700 700 X 2	08
	F	Solid	228	N/A	Vee	N/A			ATV Sportsman 800 EFI	05-06
									ATV Sportsman 800 EFI	08
									ATV Sportsman 800 EFI	09
									ATV Sportsman 800 EFI	10-13
									ATV Sportsman 800 X 2 EFI	07-09
									ATV Sportsman 800 EFI Intl/HO	07-11
									ATV Sportsman 800 Touring/EFI	08-09
									ATV Sportsman 800 Big Boss/EFI 6 x 6/EFI	09-14
									ACE SXS ACE 570 R08 All models	17-20
									ACE SXS ACE 570 EFI EURO R09	17-20
									Ranger SXS 325 Ranger ETX	15-16
									Ranger SXS 400 Ranger	10-14
									Ranger SXS 499 Ranger	17
									Ranger SXS 500 Ranger 2 x 4/4 x 4	06-07
									Ranger SXS 500 Ranger 4 x 4 EFI	06-07
									Ranger SXS 500 Ranger 4 x 4 EFI	08-10
									Ranger SXS 500 Ranger 4 x 4 EFI	11-13
									Ranger SXS 500 Ranger Carb 2 x 4	08-09
									Ranger SXS 500 Ranger Crew	11-13
									Ranger SXS 500 Ranger Series 10 6 x 6	
									Ranger SXS 500 Ranger 500	17-20
									Ranger SXS 500 Ranger 500	21-22
									Ranger SXS Ranger Series 10	
									Ranger SXS Ranger 2 x 4 / 4 x 4	04-05
									Ranger SXS Ranger Series 11	
									Ranger SXS Ranger 6 x 6	04-05
									Ranger SXS Ranger TM	04-05
									Ranger SXS Ranger TM	06
									Ranger SXS Ranger XP	05
									Ranger SXS 570 Ranger EFI	14-20
									Ranger SXS 570 Ranger Crew EFI	14-15
									Ranger SXS Ranger 570	16
									Ranger SXS Ranger 570, R12	17-20
									Ranger SXS Ranger 570	18-20
									Ranger SXS Ranger 570	19-20
									Ranger SXS Ranger 570 Full Size	21-22
									Ranger SXS Ranger CREW 570FS R17RDA57A1/B1 R08	17-20
									Ranger SXS Ranger CREW 570 FS R18RDA57A1/B1 R05	16-20
									Ranger SXS Ranger CREW 570 FS R19RDA57A1/B1 R03	19-20
									Ranger SXS RGR 570 EPS CREW MD R18RNE57NV R04	18-20
									Ranger SXS RGR 570 EFI CREW R17RNA57A1/A9/EAM/ENM R10	17-20
									Ranger SXS RGR 570 CREW R18RNA57B1/B9/EBV R03	18-20
									Ranger SXS RGR 570 CREW R19RNA57B1/B9/EBX R02	16-20
									Ranger SXS SP 570	22
									Ranger SXS SP 570 Premium	22
									Ranger SXS SP 570 North Star	22
									Ranger SXS 700 Ranger 6 x 6 EFI	06-09
									Ranger SXS 700 Ranger XP 4 x 4	06
									Ranger SXS 700 Ranger 4 x 4 EFI/LE	07
									Ranger SXS 700 Ranger Crew EFI 4 x 4	09
									Ranger SXS 700 Ranger 6 x 4 EFI	08
								Ranger SXS 700 Ranger XP 4 x 4	08	
								Ranger SXS Ranger EV Electric	10-15	
								Ranger SXS Ranger EV MD R18RMAE4N8 R02	18-19	
								Ranger SXS Ranger EV LIION R17RMAL4G9 R08	16-18	
								Ranger SXS Ranger EV LIION R18RMAL4G9 R03	16-18	
								Ranger SXS Ranger EV R17RMAE4G8/G9/N8/MAE4H8 R12	16-17	
								Ranger SXS Ranger EV R18RMAE4G8/G9 R03	16-18	
								Ranger SXS 800 Ranger Mid Size	13-14	
								Ranger SXS RGR 800 6X6 R17RAA76NA MD POLAND R02	17-20	
								Ranger SXS PPS/PTV 4 x 4/Series 10		
								Ranger SXS PPS/UTV 2 x 4 Series 10		
								Ranger SXS PPS/UTV 4 x 6 Series 10		
								Ranger SXS PPS/UTV 1500 2 x 4 Series 11		
								Ranger SXS PPS/Series 11 2 x 4/4 x 4		
								Ranger SXS PPS/Series 11 6 x 6		

BRAKE ROTOR BUYERS GUIDE - DIRTBIKE/ATV/UTV

Rotor No.	F/R	Type	Dia. (mm)	Hub Color	Profile	Bobbins	Left Bracket	Right Bracket	Model	Year
MD6206D	F	Solid	168	N/A	Plain	N/A			SUZUKI LT-F 300 FK2	02
MD6207D	F	Solid	160	N/A	Plain	N/A			SUZUKI LT-F 250 Ozark	02-14
MD6208D MD6208C MD6208CE MD6208CX	R R R R	Solid Solid Solid Solid	240 240 240 240	N/A N/A N/A N/A	Plain Contour Contour Vee	N/A N/A N/A N/A			KAWASAKI KX 125 2T KX 250 2T KX 250 2T KX 250 F 4T KX 250 F 4T KX 250 F KX 250 F KX 250 F KX 250 FX KLX 450 R KX 450 F KX 450 F KX 450 F KX 450 F X SUZUKI RM-Z 250 K	03-05 03-05 06-07 04-05 06-08 09-14 15-019 21-24 21-24 08-12 06-08 09-14 15-17 21-24 04-07
MD6210D	F	Solid	170	N/A	Plain	N/A			KAWASAKI KSF 400 KFX SUZUKI LT-Z 250 LT-Z 400 ARCTIC CAT 400 DVX 2x4 Sport	03-06 04-11 03-12 04-08
MD6211D	R	Solid	220	N/A	Plain	N/A			ARCTIC CAT 400 DVX 2x4 Sport 400 DVX TS Sport KAWASAKI KSF 400 KFX SUZUKI LT-Z 400	04-08 06-07 03-06 03-12
MD6212D	F	Solid	220	N/A	Plain	N/A			KAWASAKI KLX 125 L SUZUKI DR-Z 125	03-06 03-21
MD6213D MD6213C MD6213CX OSX6213 SMX6213	F F F F F	Solid Solid Solid Floating Floating	250 250 250 280 320	N/A N/A N/A Silver Black	Plain Contour Vee Contour Contour	N/A N/A N/A 6 6			KAWASAKI KX 125 M1/M2/M3 KX 250 M1/M2/R1/R6F KX 250 N1/N2 (KX 250 F) KX 250 F (T6F) KX 250 R6F/R7F KX 450 F (D6F) SUZUKI RM-Z 250 K4/K5/K6/K7	03-05 03-06 04-05 06 06-07 06 04-07
MD6214D	F	Solid	230	N/A	Plain	N/A			APRILIA MX 50 RX 50/RX 50 Racing	04 04
MD6215D	F	Solid	200	N/A	Plain	N/A			YAMAHA YFM 350 FAS/FAT 350 Bruin 4x4 Auto YFM 350 AS/AT/AV 350 Bruin 2x4 Auto YFM 350 GW/GX/GY/GZ/GA Grizzly 2x4 (2WD) YFM 350 XV/XW/XX/XY Wolverine (2WD) YFM 350 FGIW/FGIX/FGIY/FGIZ/FGIA/FGB/FGD Grizzly Auto IRS 4x4 YFM 350 DE Grizzly Auto 4x4 YFM 400 FGW/FGX/FGY/FGZ/FGA Grizzly 4x4 YFM 400 FAR/FAS Kodiak Auto YFM 400 AR/AS Kodiak 2WD	04-06 04-06 07-11 06-09 07-13 14 07-11 03-04 03-04

BUYERS GUIDE
BRAKE ROTORS

BRAKE ROTOR BUYERS GUIDE - DIRTBIKE/ATV/UTV

Rotor No.	F/R	Type	Dia. (mm)	Hub Color	Profile	Bobbins	Left Bracket	Right Bracket	Model	Year
MD6215D Contd.	F	Solid	200	N/A	Plain	N/A			YFM 400 FAS/FAT/FAHT/FAV Kodiak 4WD YFM 400 FBHW/FBHZ/Y/Z Big Bear 400 Hunter-IRS YFM 400 FBEW Big Bear 400 IRS Exploring Edition YFM 400 FBW/FBX/FBY/FBA/FBB Big Bear 4WD IRS YFM 450 DE Grizzly 450 Auto 4x4 YFM 450 FAR/FAS/FAT/FAHT/FAV Kodiak YFM 450 FGPA/B/D (Grizzly 450 Auto/4x4/EPS) YFM 450 FGW Grizzly Auto 4x4 IRS YFM 450 FGX/FGY/FGZ/FGA/FGB/FGD Grizzly 450 Auto 4x4 YFM 450 FXV/FXW/FXX/FXY/FXZ Wolverine Auto 4x4 YFM 450 FXSEW Wolverine Sport Special Edition YFM 450 PE Grizzly 450 Auto 4x4 EPS	04-05 07-10 07 08-12 14 03-05 11-13 07 08-13 06-10 07 14
MD6216D	R	Solid	160	N/A	Plain	N/A			KTM 60 SX 65 SX	00 00-03
MD6217D	R	Floating	170	Silver	Plain	N/A			HONDA TRX 420 Fourtrax Rancher All Models SXS 500 M2 Pioneer TRX 500 FA5 AC Foreman Rubicon 4x4 Auto/DCT TRX 500 FA6 AC Foreman Rubicon 4x4 Auto/DCT/EPS TRX 500 FA7 AC, 2AC Foreman Rubicon 4x4 Auto/DCT/EPS TRX 500 FM5 Foreman Rubicon 4x4 TRX 500 FM6 AC, 2AC Foreman Rubicon 4x4/EPS TRX 520 FA Foreman Rubicon All Models TRX 650 FA TRX 650 FGA TRX 680 FGA6/FGA7/FGA8 Fourtrax Rincon Gpscape 675cc TRX 680 FA Fourtrax Rincon SXS 700 M2 Pioneer 2 Seat SXS 700 M4 Pioneer 4 Seat	09-24 15-17 15-19 15-19 15-19 15 15-19 20-24 03-05 04-05 06-08 06-23 14-23 14-23
MD6218D	R	Solid	196	N/A	Plain	N/A			POLARIS Outlaw 450 S Predator 500 500 E Predator	08 03-07 06
MD6219D	F	Solid	178	N/A	Plain	N/A			POLARIS Phoenix 200/200 Phoenix Quadricycle 200 Phoenix AA/AB Model/Rear drum model 200 Phoenix EA/EB Quadricycle Model Rear disc model Outlaw 450 S Outlaw 450 MXR Outlaw 500 Predator 500 500 E Predator 525 S Outlaw 525 Outlaw IRS	05 05 05 08 09-10 06-07 03-07 06 08-10 08-10
MD6220D	F	Solid	155	N/A	Plain	N/A			BOMBARDIER Rally 200 CAN-AM Rally 200	03-06 05-07
MD6221D	R	Solid	155	N/A	Plain	N/A			BOMBARDIER Rally 200	03-05
MD6222D UTVX6222	F F	Solid Solid	205 205	N/A N/A	Plain Vee	N/A N/A			BOMBARDIER Outlander 330 HO Outlander 400 Outlander 400 Max HO Outlander 650 HO Outlander Max 650 HO Outlander 800 CAN AM Outlander 400 4 x 4 STD Outlander 400 XT 4 x 4 Outlander Max 400 STD 4 x 4	04-05 03-04 03-06 06 06 06 07-14 07-14 07-14

BUYERS GUIDE
BRAKE ROTORS

BRAKE ROTOR BUYERS GUIDE - DIRTBIKE/ATV/UTV

Rotor No.	F/R	Type	Dia. (mm)	Hub Color	Profile	Bobbins	Left Bracket	Right Bracket	Model	Year
MD6222D UTVX6222 Contd.	F	Solid	205	N/A	Plain	N/A			Outlander Max 400 XT 4 x 4	06-13
	F	Solid	205	N/A	Vee	N/A			Outlander 400 EFI STD international	15
									Outlander 500 STD 4 x 4	07-12
									Outlander 500 XT 4 x 4	07-12
									Outlander Max 500 STD 4 x 4	07-12
									Outlander Max 500 XT 4 x 4	07-12
									Outlander 650 4 x 4 STD	07-12
									Outlander 650 XT 4 x 4	07-12
									Outlander Max 650 STD 4 x 4	07-12
									Outlander Max 650 XT 4 x 4	07-12
									Outlander Max 650 X - TP	12
									Outlander 800 STD 4 x 4	07-08
									Outlander 800 XT 4 x 4	07-08
									Outlander 800 R EFI	09
									Outlander 800 R XT	09-10
									Outlander Max 800 R EFI	09-12
									Outlander Max 800 R XT	09-12
									Outlander Max 800 Ltd 4 x 4	07-12
									Outlander Max 800 STD 4 x 4	07-12
									Outlander Max 800 XT 4 x 4	07-08
									Outlander 800 R Xmr	11-12
									Outlander 800 R XXC	11
									Outlander Max 800 R X-TP	12
									Commander Electric 9KW	13-15
									Commander 800	13-14
									Commander 1000	13-15
MD6223D UTVX6223	R	Solid	180	N/A	Plain	N/A			BOMBARDIER	
	R	Solid	180	N/A	Vee	N/A			Outlander 330 HO	04-05
									Outlander 400	03-04
									Outlander 400 Max HO	03-06
									Outlander 650 HO	06
									Outlander Max 650 HO	06
									Outlander 800	06
									CAN AM	
									Outlander 400 4 x 4 STD	07-14
									Outlander 400 XT 4 x 4	07-14
									Outlander Max 400 STD 4 x 4	07-14
									Outlander Max 400 XT 4 x 4	06-13
									Outlander 400 EFI STD international	15
									Outlander 500 STD 4 x 4	07-12
									Outlander 500 XT 4 x 4	07-12
									Outlander Max 500 STD 4 x 4	07-12
									Outlander Max 500 XT 4 x 4	07-12
									Outlander 650 4 x 4 STD	07-12
									Outlander 650 XT 4 x 4	07-12
									Outlander Max 650 STD 4 x 4	07-12
									Outlander Max 650 XT 4 x 4	07-12
									Outlander Max 650 X - TP	12
									Outlander 800 STD 4 x 4	07-08
									Outlander 800 XT 4 x 4	07-08
									Outlander 800 R EFI	09
									Outlander 800 R XT	09-10
									Outlander Max 800 R EFI	09-12
									Outlander Max 800 R XT	09-12
									Outlander Max 800 Ltd 4 x 4	07-12
									Outlander Max 800 STD 4 x 4	07-12
									Outlander Max 800 XT 4 x 4	07-08
									Outlander 800 R Xmr	11-12
									Outlander 800 R XXC	11
									Outlander Max 800 R X-TP	12
									SXS Commander Electric 9KW	13-15
									SXS Commander 800	13-14
									SXS Commander 1000	13-15

BUYERS GUIDE
BRAKE ROTORS

BRAKE ROTOR BUYERS GUIDE - DIRTBIKE/ATV/UTV

Rotor No.	F/R	Type	Dia. (mm)	Hub Color	Profile	Bobbins	Left Bracket	Right Bracket	Model	Year
MD6224D	F	Solid	203	N/A	Plain	N/A			BOMBARDIER Quest 500 4x4 Quest 500 2x4 Quest 650 2x4 Quest 650 4x4 Quest 650 XT 4x4 Quest Max 650	02-04 02 02 02-04 02 03-04
MD6224D	R	Solid	203	N/A	Plain	N/A			BOMBARDIER Traxter Autoshift	01-04
MD6225D	R	Solid	218	N/A	Plain	N/A			BOMBARDIER Quest 500 4x4 Quest 500 2x40 Quest 650 2x4 Quest 650 4x4 Quest 650 XT 4x4 Traxter Max Traxter Max 650 Traxter XL 7920/7921 Quest Max/STD/XT JOHN DEERE Trail Buck 500/650 EX/EXT Buck 500/650 EX/EXT	02-04 02 02 02-04 02 03-05 04-05 04 03-05 04-08 04-08
MD6227D	R	Solid	220	N/A	Plain	N/A			KTM EXC 125 MX/MXC/GS 125 MX 125 EXC/EGS 250 GS 250 MX 250 MX/MXC 250 MX/MXC/GS 300 EXC 350 MX/MXC/GS 350 MX 350	88-89 86 88-89 88-89 86 88-89 86 86 86 89 86/88 89
MD6229D	F	Solid	205	N/A	Plain	N/A			BOMBARDIER Traxter 4X4 Traxter XL 4x4 Traxter XT 4x4 Traxter Autoshift Traxter Footshift Traxter 4x4 Traxter XL 4x4	99-00 01 00-01 01 01 01 01-04
MD6230D	R	Solid	220	N/A	Plain	N/A			BOMBARDIER Traxter 4x4 Traxter 4x4 Traxter XL 4x4 Traxter XT 4x4 Traxter Autoshift Traxter Footshift	99-00 01 01-04 00-01 01 01
MD6232D MD6232CX	Rear Rear	Solid Solid	260 260	N/A N/A	Plain Vee	N/A N/A			SUZUKI DL 650 V-Strom DL 650 V-Strom Adventure ABS DL 650 V-Strom XT ABS DL 650 V-Strom XT Touring DL 800 DE V-Strom DL 1000 K DL 1000 V-Strom Adventure DL 1000 V-Strom ABS	04-17 12-24 15-24 18-24 24 02-12 12/14-21 14-21
MD6233D	R	Solid	190	N/A	Plain	N/A			HONDA TRX 450 R/ER	04-14

BRAKE ROTOR BUYERS GUIDE - DIRTBIKE/ATV/UTV

Rotor No.	F/R	Type	Dia. (mm)	Hub Color	Profile	Bobbins	Left Bracket	Right Bracket	Model	Year
MD6236D	R	Solid	200	N/A	Plain	N/A			YAMAHA YFM 125 R Raptor YFM 250 R RSPA YFM 250 R Raptor YFM 250 RSPA Special Edition YFM 250 RS Special Edition YFM 250 RSXPC Special Edition Custom YFM 350 R Raptor YFZ 450 LES Limited Edition YFZ 450 S/T YFZ 450 SET Special Edition YFZ 450 BB/DB YFM 700 Raptor	11-13 11 08-13 11 08-09 08 04-13 04 04-05 05 12-13 13
MD6237D	R	Solid	220	N/A	Plain	N/A			YAMAHA YFS 200 Blaster YFZ 350 Banshee YFM 660 R	03-06 90-06 01-04
MD6239D	F	Solid	240	N/A	Plain	N/A			KAWASAKI KL 250 G4-G8	00-09
MD6241D UTVX6241	F F	Solid Solid	200 200	N/A N/A	Plain Vee	N/A N/A			YAMAHA YXR 450 Rhino (All models) YXR 660 Rhino YXR 700 Rhino FI Unlimited Version	06-09 04-07 08-09/11-13
MD6242D UTVX6242 OSX6242	R R R	Solid Solid Floating	165 165 190	N/A N/A Silver	Plain Vee Contour	N/A N/A N/A		BRK030	YAMAHA YXR 450 Rhino All models YXR 660 Rhino	06-09 04-07
MD6243D MD6243C MD6243CX	F F F	Solid Solid Solid	198 198 198	N/A N/A N/A	Plain Contour Vee	N/A N/A N/A			GAS-GAS (PIERER MOB) MC 65 HUSQVARNA TC 65 KTM SX 65 SX 65 XC 65	21-23 21-23 04-09 09-23 08-10
MD6244D	R	Solid	203	N/A	Plain	N/A			YAMAHA XT 250 XTZ 250 Lander F 21" / R 18" Wheels XTZ 250 Lander F 21" / R 18" Wheels XTZ 250 X F & R 17" Wheels	08-24 07-14 16-18 08-10
MD6245D	F	Solid	203	N/A	Plain	N/A			TRAXTER MAX Traxter Max 650 Traxter XL 7920/7921 Quest Max/STD/XT JOHN DEERE Trail Buck 500/650 EX/EXT Buck 500/650 EX/EXT Buck 500/650 EX/EXT	03-05 04-05 04 04-05 04-08 04-08 04-08
MD6246C MD6246CX	R R	Solid Solid	200 200	N/A N/A	Plain Vee	N/A N/A			SUZUKI RM 85	05-21
MD6247D MD6247C	F F	Floating Floating	310 310	Silver Silver	Plain Contour	6 6			SUZUKI DR-Z 400 SM	05-24
MD6249C MD6249CX	R R	Solid Solid	160 160	N/A N/A	Contour Vee	N/A N/A			GAS-GAS (PIERER MOB) MC 65 HUSQVARNA TC 65 KTM SX 65 SX 65 XC 65	21-23 18-23 04-09 09-23 08-10

BUYERS GUIDE
BRAKE ROTORS

BRAKE ROTOR BUYERS GUIDE - DIRTBIKE/ATV/UTV

Rotor No.	F/R	Type	Dia. (mm)	Hub Color	Profile	Bobbins	Left Bracket	Right Bracket	Model	Year
MD6251D	F	Solid	180	N/A	Profile	N/A			HONDA TRX 500 FA/FG TRX 500 FE/FA Fourtrax Foreman 4x4/ES TRX 500 FMA Fourtrax Foreman 4x4 TRX 500 TM5/TM6 Fourtrax Foreman 2x4 TRX 500 FPA Fourtrax Rubicon with EPS/Power Steering TRX 500 FPE Fourtrax Foreman 4x4 ES/EPS TRX 500 FPM8 Fourtrax Foreman 4x4/EPS TRX 680 FA Fourtrax Rincon	05-14 05-12 05-12 05-06 09-14 08-12 08-11 06-23
MD6252D	R	Solid	220	N/A	Profile	N/A			YAMAHA YFM 400 F YFM 400 F Grizzly 4x4 YFM 450 F Grizzly Auto 4x4 IRS YFM 450 F	05-06 07-08 07-10 05-06
MD6253D MD6253C	R R	Solid Solid	220 220	N/A N/A	Profile Contour	N/A N/A			GAS-GAS Enduro EC 200/250/300 EC 125/200/250/300 EC 200/250/300 All models/2T MC 125 MX 125/250 Pampera 125/450 SM 125/250 4T MX 200/250/300 SM 400 FSE 2T SM 450	99-00 01-09 10-12 05 01-04 05 01-05 99-00 01-02 03-05
MD6254D MD6254CX OSX6254 SMX6254	F F F F	Solid Solid Solid Solid	250 250 280 320	N/A N/A Silver Black	Plain Vee Contour Contour	N/A N/A 6 6			SUZUKI RM-Z 250 RM-Z 450	07-21 05-21
MD6255D MD6255CE MD6255CX	R R R	Solid Solid Solid	240 240 240	N/A N/A N/A	Plain Contour Vee	N/A N/A N/A			SUZUKI RM-Z 250 RM-Z 450	04-24 04-24
MD6256D UTVX6256	R R	Solid Solid	203 203	N/A N/A	Plain Contour	N/A N/A			POLARIS Scrambler 500 2X4/4X4 500 Scrambler 4x4 Trail Blazer 250 Trail Boss 330 330 Trail Blazer 330 Trail Boss	05-10 10-12 05-06 05-10 08-12 10-12
MD6257C	R	Solid	200	N/A	Contour	N/A			KTM SX 85 17"/14" wheels SX 85 19"/16" wheels XC 85 SX 105 XC 105	03-11 03-11 08-09 07-11 08-10
MD6258C OSX6258 OSX6258ORG	F F F	Solid Floating Floating	220 220 220	N/A Silver Silver	Contour Contour Contour	N/A 6 6	BRK028 BRK028ORG		KTM SX 85 17"/14" wheels SX 85 19"/16" wheels XC 85 SX 105 XC 105	03-11 03-11 08-09 07-11 08-10
MD6259D	R	Solid	240	N/A	Plain	N/A			CAGIVA Elefant 650	86-87

BUYERS GUIDE
BRAKE ROTORS

BRAKE ROTOR BUYERS GUIDE - DIRTBIKE/ATV/UTV

Rotor No.	F/R	Type	Dia. (mm)	Hub Color	Profile	Bobbins	Left Bracket	Right Bracket	Model	Year
MD6261D	F	Solid	200	N/A	Plain	N/A			SUZUKI LT-A 450 X LT-A 450 X King Quad 450 AXi Camo LT-A 450 X King Quad 450 AXi Special Edition LT-A 700 X LT-A 750 X King Quad 750 AXi LT-A 750 X King Quad 750 AXi Camo LT-A 750 X King Quad 750 AXi Limited LT-A 750 X King Quad 750 AXi Rockstar Edition	07-09 07-09 08-09 05-07 08-22 08-14 08-13 09
MD6262D	F	Solid	182	N/A	Plain	N/A			POLARIS Trail Blazer 250 Trail Boss 330 330 Trail Blazer Scrambler 500 2x4	05-06 05-10 08-10 07-08
MD6263D MD6263C	R R	Solid Solid	200 200	N/A N/A	Plain Plain	N/A N/A			YAMAHA YZF 450 YZF 450 YZF 450 R Special Edition YZF 450 Bill Balance Edition YZF 450 Special Edition YFM 700 R Raptor YFM 700 R Special Edition YFM 700 50th Anniversary Edition YFM 700 R Raptor	06-09/11-13 09-14 14 06-07 06-08 06-14 07-15 06 13-15
MD6264D MD6264C MD6264CX OSX6264 SMX6264	F F F F F	Floating Floating Floating Floating Floating	250 250 250 280 320	Silver Silver Silver Silver Black	Plain Contour Vee Contour Contour	6 6 6 6 6			KAWASAKI KX 250 KX 250 F 4T KX 450 KX 450 F KX 450 F KLX 450 R	06-08 09-14 06-08 09-14 18-21 08-12
MD6265D	F	Floating	260	Silver	Plain	6			CAGIVA Elefant 650	86-87
MD6266D	F	Solid	300	N/A	Plain	N/A			ARCTIC CAT 250 DVX Sport KTM LC-4 640 Adventure-R LC-4 640 Adventure 950 Adventure, Inc S model	06-08 04 05-07 04-06
MD6267D	F & R	Solid	180	N/A	Plain	N/A			ARCTIC CAT 50 4x4 Auto Youth 50 DVX 4T 50 DVX 4T Sport 50 Utility Alterra 90 90 Reverse Gear 90 DVX 90 DVX SE 90 SE 90 Utility 2 x 4 90 2x4 4T Youth 150 Utility 2x4 250 Utility 250 DVX 250 DVX Sport 300 ATV 2x4 Utility 300 Alterra 300 DVX 500 Prowler KAWASAKI KFX 50 - KSF 50 KFX 90 - KSF 90 KVF 300 Brute Force	09 06-08 06/08 06-08 17-23 10-14 06-14 09 09 06-10 06 09-14 06-09 06-08 06-08 10-14 17-23 09-14 18-23 07-24 07-24 12-24

BUYERS GUIDE
BRAKE ROTORS

BRAKE ROTOR BUYERS GUIDE - DIRTBIKE/ATV/UTV

Rotor No.	F/R	Type	Dia. (mm)	Hub Color	Profile	Bobbins	Left Bracket	Right Bracket	Model	Year
MD6267D Contd.	F & R	Solid	180	N/A	Plain	N/A			KYMCO Mongoose 70 4T Mongoose 90 Mongoose 90 R Reverse gear KXR 250 MXU 150 Mongoose 300 MXU 300	07-14 02-10 10-14 04-10 03-14 06-14 05-14
MD6268D	R	Solid	220	N/A	Plain	N/A			ARCTIC CAT 250 DVX 300 DVX KYMCO KXR 250 MXU 250 Mongoose 300	06-08 09-14 04-10 04-10 06-14
MD6269D MD6269C MD6269CX MD6269CE	R R R R	Solid Solid Solid Solid	240 240 240 240	N/A N/A N/A N/A	Plain Contour Contour Contour	N/A N/A N/A N/A			BETA 125 RR Enduro RR 125 RR 125 Race 200 RR Enduro RR 250 250 RR Enduro 250 RR Race X-Trainer 250 300 RR Enduro 300 RR Race 300 RX X-Trainer 300 350 RR-S Enduro 350 RR Race 390 RR-S Enduro 390 RR Race 430 RR-S Enduro 430 RR Race 480 RR-S Enduro 480 RR Race 500 RR Enduro KTM 450 Rally 690 Rally Factory Rep 690 Enduro R 950 Adventure/S	20-24 18-19 18-23 20-24 18-19 20-24 20-23 18-22 20-24 20-23 21-24 18-23 20-24 20-23 20-24 20-23 20-24 20-23 20-23 20-23 20-23 21-22 17-21 07-08 10-15 04-06
MD6270D MD6270C	F F	Floating Floating	310 310	Gold Gold	Plain Contour	9 9			HUSABERG All supermotard models Beringer 4 piston caliper FS Supermotard Models Beringer/FTE 6 piston caliper FS Supermotard Models FTE 4 piston radial caliper KTM SMR 450/560	00-03 04 05-08 05-06
MD6271D UTVX6271	F F	Solid Solid	252 252	N/A N/A	Plain Vee	N/A N/A			ARCTIC CAT 1000 Mudpro 550 H1 EFI Prowler HDX 500 Inc.LTD Prowler HDX 500 XT Prowler XT 550 XT 550 Prowler XT 650 H1 Prowler 650 H1 Prowler 650 Prowler 4 x 4/M4 HDX 700 Inc.LTD Prowler XTX 700 H1 LE Prowler XTX 700 H1 EFI Prowler XTX 700 Prowler XTZ 1000 Prowler Wildcat 1000 GT	10-13 09 14 14 10-11 11-14 06-09 07 08 11-14 08 09 11-14 10-14 11-12

BRAKE ROTOR BUYERS GUIDE - DIRTBIKE/ATV/UTV

Rotor No.	F/R	Type	Dia. (mm)	Hub Color	Profile	Bobbins	Left Bracket	Right Bracket	Model	Year
MD6271D UTVX6271	R R	Solid Solid	252 252	N/A N/A	Plain Vee	N/A N/A			ARCTIC CAT 1000 Mudpro	10-13
MD6272D	F	Solid	198	N/A	Plain	N/A			POLARIS Hawkeye 300 2x2/4x2 Hawkeye 2x4/4x4 Sportsman 300 4x4 400 Sportsman HO 4x4	06 07 08-10 08-10
MD6273D	R	Solid	202	N/A	Plain	N/A			POLARIS Hawkeye 300 2x2/4x2 Hawkeye 2x4/4x4 Sportsman 300 4x4 400 Sportsman HO 4x4	06 07 08-10 08-10
MD6274D	F	Solid	173	N/A	Plain	N/A			POLARIS 200 Phoenix AC/AD Model and following rear drum model 200 Phoenix Rear drum model 200 Phoenix EC/ED Onwards - Quadricycle Rear Disc Model 200 Phoenix Quadricycle Rear disc model 200 Sawtooth Rear drum model 200 Sawtooth Quadricycle Rear disc model 400 Hawkeye HO 2x4	05-09 10-14 05-09 05-10 06-07 06/08 13-14
MD6274D	R	Solid	173	N/A	Plain	N/A				
MD6275D UTVX6275	R R	Solid Solid	218 218	N/A N/A	Plain Vee	N/A N/A			POLARIS Hawkeye 325 2 x 4 Sportsman 325 Ace Sportsman 325 Ace EFI Sportsman 325 Ace Euro Sportsman 325 Ace HD Sportsman 400 HO 4 x 4 Sportsman 500 EFI/HO Sportsman 500 HO Sportsman 500 HO Sportsman 500 X2 Sportsman 500 X 2 EFI Sportsman 500 Forest Sportsman 500 Touring H.O. Sportsman 500 Touring H.O. Sportsman 500 EFI Quad H.O. Sportsman 570 Ace Sportsman 570 Ace Euro Sportsman 570 EFI Inc EPS models Sportsman 570 A21SEA57A1 Sportsman 700 700 EFI Sportsman 700 700 X 2 Sportsman 800 EFI Sportsman 800 EFI Sportsman 800 EFI Sportsman 800 EFI Sportsman 800 X 2 EFI Sportsman 800 EFI Intl/HO Sportsman 800 Touring/EFI Sportsman 800 Big Boss/EFI 6 x 6/EFI Commercial Brutus HD HDPTO 325 Ranger ETX 400 Ranger 500 Ranger 2 x 4/4 x 4 500 Ranger 4 x 4 EFI SXS 500 Ranger 4 x 4 EFI 500 Ranger 4 x 4 EFI 500 Ranger Carb 2 x 4 500 Ranger Efi 4 x 4 H.O. 500 Ranger Crew 500 Ranger 500 Ranger TM Ranger 570 Ranger EFI 570 Ranger Crew EFI 570 Ranger R16	15 14 15 14-15 15 11-14 07-08 08 09-13 06-08 07-09 12 08-11 11-13 08-11 15-18 15-18 11-20 22-23 07 08 08 09 10-13 07-09 07-11 08-09 09-14 13-17 15-16 10-14 06-07 06-07 08-10 11-13 08-09 09-11 11-13 17-20 21-22 06 14-20 14-15 16

BUYERS GUIDE
BRAKE ROTORS

BRAKE ROTOR BUYERS GUIDE - DIRTBIKE/ATV/UTV

Rotor No.	F/R	Type	Dia. (mm)	Hub Color	Profile	Bobbins	Left Bracket	Right Bracket	Model	Year
									570 Ranger R12	17-20
									570 Ranger	18-20
									570 Ranger	19-20
									570 Ranger Full Size	21-22
									570 Ranger Crew FS R17RD R08	17-20
									570 Ranger Crew FS R17RD R08	16-20
									570 Ranger Crew FS R17RD R08	19-20
									570 Ranger Crew EPS MD R18RN R04	18-20
									570 Ranger Crew Efi R17RN R10	17-20
									570 Ranger Crew R18RNA R03	18-20
									570 Ranger Crew R19RNA R02	16-20
									Ranger SP 570	22
									Ranger SP 570	22
									Ranger SP 570	22
									700 Ranger 6 x 6 EFi	06-09
									700 Ranger XP 4 x 4	06
									700 Ranger 4 x 4 EFi/LE	07
									700 Ranger 4 x 4 EFi	09
									700 Ranger Crew EFi 4 x 4	09
									700 Ranger 6 x 4 EFi	08
									700 Ranger XP 4 x 4	08
									Electric Ranger EV	10-15
									800 Ranger	10-12
									800 Ranger EFi	13-14
									800 Ranger Mid Size	13-14
									800 Ranger XP	10-12
									800 Ranger 6 x 6	10-17
									800 Ranger Crew	10-14
									Ranger 800 6X6 R17RAA MD Poland R02	17-20
									900 Ranger Crew	10-15
									900 D Crew Ranger Diesel	13-14
									900 D Ranger Diesel	11-14
									900 Ranger XP 900	13-14
									900 Ranger XP R27	15-19
									900 Ranger R18RVA	16-19
									1000 Ranger Diesel	15-20
									1000 Ranger Diesel Crew	15
									Ranger Crew 1000XP PS MD R18RVE99NX R08	18
									Ranger Crew 1000XP PS R17RV_99 ALL OPTIONS R32	17
									Ranger Crew 1000XP PS R18RV_99 ALL OPTIONS R09	18
									Ranger Crew 1000XP 6P,PS,NB,MD R08 R17RVE99NY	17
									Ranger Crew 1000 PS R18RVU99AS R10	18-20
									Ranger 1000 Diesel Poland R18RTED1F1/SD1C1 R07	17-18
									Ranger 1000 Diesel EU R17RTED1F1/SD1C1 R14	17
									Ranger 1000 Diesel EU R17RTED1F1/SD1C1 R14	17-18
									Ranger Crew 1000 49/50S Factory choice ,R04, R06 R08, R11	18-20
									Ranger 1000XP PS Crew Inc EU,EPS, HD,MD, R03, R09,R13, R20	18-20
									Ranger 1000XP PS NSTR, Crew Mud R02,R15,R17,R18	18-20
									Ranger 1000 Diesel R17	17
									Ranger 1000 Diesel R17	18
									RZR 570	12-13
									RZR 570	14-19
									RZR 570 Trail Premium	20-21
									RZR Trail 570	20-21
									RZR Trail	20-21
									RZR Trail S	20-21
									RZR 800	08-14
									RZR-4 800 EPS	12
MD6277D	F	Solid	160	N/A	Plain	N/A			SUZUKI LT-R 450 LT-R 450 Quad Racer Ltd Edition	06-11 08-09
MD6278D	R	Solid	190	N/A	Plain	N/A			SUZUKI LT-R 450 LT-R 450 Quad Racer Ltd Edition	06-11 08-09
MD6281D	F	Solid	220	N/A	Plain	N/A			SUZUKI RV 200 L Van-Van	16-19

BRAKE ROTOR BUYERS GUIDE - DIRTBIKE/ATV/UTV

Rotor No.	F/R	Type	Dia. (mm)	Hub Color	Profile	Bobbins	Left Bracket	Right Bracket	Model	Year
MD6282D	R	Solid	190	N/A	Plain	N/A			BOMBARDIER DS 250 CAN-AM DS 250 YAMAHA YM 90 R Raptor	06-22 06-22 09-13
MD6283D	F	Solid	175	N/A	Plain	N/A			BOMBARDIER DS 250 CAN-AM DS 250 YAMAHA YFM 300 GB/GD Grizzly YFM 350 FB Grizzly	06-22 06-22 12-13 12
MD6285D	R	Solid	200	N/A	Plain	N/A			BOMBARDIER Rally 200 CAN-AM Rally 200	05-06 07
MD6287D	R	Solid	220	N/A	Plain	N/A			HUSQVARNA CR 125 SM 125 SMS 125 2T SMS-4-125 4T WR 125 WRE 125 CR 250 WR 250 WR 360 TE 410 SM 570 R 4 bolt front disc TE 570 SM 610 R SM 610/S 4 bolt front disc TC 610 TE 610 TE 610 E TE 610/E	00-01 00 02-11 10-11 00-01 00-11 00-01 00-01 00-01 00 01 01-04 00 02-06 00 00 02-03 06-09
MD6288D MD6288C	R R	Solid Solid	240 240	N/A N/A	Plain Contour	N/A N/A			HUSQVARNA CR 125 WR 125 TC 250 TE 250 TXC 250 Cross Country WR 250 TE 310 4T TE 410 SMR 450 RR Radial caliper SM 450 R Radial caliper TC 450 TE 450 TXC 450 Cross Country SM 510 R Radial caliper TC 510 TE 510 TXC 510 Cross Country SM 610 S Radial caliper	06-08 06-08 05-08 06-08 08 06-09 09 06 06-08 07-10 05-10 06-10 08 06-10 05-09 06-10 08 06
MD6289D MD6289C	F F	Solid Solid	260 260	N/A N/A	Plain Contour	N/A N/A			GAS-GAS EC 125/200/250/300 2T MC 125 MX 125/250	00-12 05 01-08
MD6290D	R	Solid	228	N/A	Plain	N/A			POLARIS 450 OUTLAW MXR OUTLAW 500 525 OUTLAW S/IRS	09-10 06-07 08-10

BUYERS GUIDE
BRAKE ROTORS

BRAKE ROTOR BUYERS GUIDE - DIRTBIKE/ATV/UTV

Rotor No.	F/R	Type	Dia. (mm)	Hub Color	Profile	Bobbins	Left Bracket	Right Bracket	Model	Year
MD6291D	F	Solid	220	N/A	Plain	N/A			YAMAHA YFM 550 WD Grizzly Auto Fi YFM 550 EPS Grizzly Auto Fi YFM 700 Grizzly YFM 700 Grizzly FI Auto 4x4 EPS Special Edition YFM 700 Grizzly YFM 700 Ducks Unlimited Edition	09-14 09-14 07-14 09-14 08-14 07-09
MD6292D	R	Solid	205	N/A	Plain	N/A			YAMAHA YFM 550 4WD Grizzly Auto Fi YFM 550 EPS Grizzly Auto Fi YFM 700 Grizzly YFM 700 Grizzly FI Auto 4x4 EPS Special Edition YFM 700 Grizzly YFM 700 Ducks Unlimited Edition	09-14 09-14 07-14 09-14 08-14 07-08
MD6293D	F	Floating	240	Gold	Plain	9			HUSQVARNA SM 400 R SM 450 R SMR 450 RR Radial caliper SM 450 R Radial caliper SM 510 R SM 510 R Radial caliper SM 570 R 4 bolt front disc SM 570 R SM 610/S 4 bolt front disc SM 610 S Radial caliper SM 610 IE SM 630 SMR 630 SMS 630 STR 650 CRC	02 03-06 06-08 07-10 05 06-10 01- 02-04 02-06 06 07-09 09-10 06 10-11 07
MD6294D	F	Floating	320	Gold	Plain	9			HUSQVARNA LT 610 6 bolt front disc SM 610 6 bolt front disc	00 98-99
MD6295D	R	Solid	220	N/A	Plain	N/A			HUSQVARNA CR 125 WR 125 CR 250 TC 250 TE 250 WR 250 WR 360 SM 400 R TE 400 SM 450 R TC 450 TE 450 SM 510 R TC 510 TE 510 SM 570 R TC 570 LT 610 6 bolt front disc SM 610 IE SM 630 SMR 630 SMS 630 TE 630 STR 650 CRC	02-05 02-05 02-05 02-03 02-05 02-05 02 02 03-06 03 03-05 05 04 04-05 02-04 02-03 00 07-09 09-10 06 10-11 10 07
MD6298D	R	Floating	240	Gold	Plain	9			KTM 690 SMC 950 R Super Enduro 990 Adventure R 990 Adventure S 990 Adventure ABS Inc. Baja Edition	08-10 07-08 09-12 06-08 07-14

BRAKE ROTOR BUYERS GUIDE - DIRTBIKE/ATV/UTV

Rotor No.	F/R	Type	Dia. (mm)	Hub Color	Profile	Bobbins	Left Bracket	Right Bracket	Model	Year
MD6299D MD6299C	F F	Floating Floating	300 300	Gold Gold	Plain Contour	9 9			KTM 690 Enduro R 950 R Super Enduro 990 Adventure R 990 Adventure S	10-13 07-08 09-12 06-08
MD6301D	R	Solid	160	N/A	Plain	N/A			HYOSUNG TE 50 TE 90 TE 100	05-08 05-08 05-08
MD6302D	F	Solid	185	N/A	Plain	N/A			HONDA TRX 420 Fourtrax Rancher All Models TRX 420 FM Fourtrax Rancher 4x4 TRX 420 FPE Fourtrax Rancher 4x4 ES/EPS TRX 420 FPM Fourtrax Rancher 44 PS TRX 420 TM Fourtrax Rancher TRX 420 TE Fourtrax Rancher ES TRX 420 FPA Power Steering Fourtrax Rancher AT/IRS	09-24 07-13 09-13 09-13 07-13 07-13 09-14
MD6304C	R	Solid	200	N/A	Contour	N/A			KAWASAKI KFX 450 R - KSF 450	07-14
MD6305D MD6305C MD6305CX	R R R	Solid Solid Solid	240 240 240	N/A N/A N/A	Plain Contour Vee	N/A N/A N/A			SUZUKI RM 125 K6/K7/K8 RM 250 K6/K7/K8	06-08 06-08
MD6307D	F	Solid	300	N/A	Plain	N/A			APRILIA ETV 1000 Caponord ABS - Bolt fixing	01-03
MD6308D	R	Solid	270	N/A	Plain	N/A			APRILIA ETV 1000 Caponord - Bolt fixing ETV 1000 Caponord Rally - Bush fixing ETV 1000 Caponord ABS - Bush fixing	01-03 03 04-07
MD6309CX SMX6309	F F	Solid Floating	280 320	N/A Black	Vee Contour	N/A 6			KAWASAKI KLR 650	08-15
MD6310C MD6310CX	R R	Solid Solid	240 240	N/A N/A	Contour Vee	N/A N/A			KAWASAKI KLR 650	08-15
MD6311D	R	Solid	220	N/A	Plain	N/A			POLARIS 200 Phoenix (EA/EB) Quadricycle Model (R disc model) 200 Phoenix (EC/ED Onwards - Quadricycle R Disc Model) 200 Sawtooth Quadricycle (R disc model) 200 Phoenix Quadricycle (R disc model)	05 05-09 06-08 05-09
MD6312D UTVX6312	F F	Solid Solid	235 235	N/A N/A	Plain Vee	N/A N/A			POLARIS RZR 570 RZR 800 EFI inc EPS Models RZR S 800 EFI	12-13 08-14 09-14
MD6313C	F	Solid	310	N/A	Contour	N/A			KTM 450 SMR 560 SMR	07-12 07
MD6314D MD6314C MD6314CX OSX6314 SMX6314	F F F F F	Solid Solid Solid Floating Floating	220 220 220 280 320	N/A N/A N/A Silver Black	Plain Contour Vee Contour Contour	N/A N/A N/A 6 6		BRK026	HONDA CRF 150 R/RB	07-24
MD6316D MD6316C MD6316CX	R R R	Solid Solid Solid	190 190 190	N/A N/A N/A	Plain Contour Vee	N/A N/A N/A			HONDA CRF 150 R/RB	07-24

BRAKE ROTOR BUYERS GUIDE - DIRTBIKE/ATV/UTV

Rotor No.	F/R	Type	Dia. (mm)	Hub Color	Profile	Bobbins	Left Bracket	Right Bracket	Model	Year
MD6317D MD6317C OSX6317	F F F	Solid Solid Floating	240 240 280	N/A N/A Silver	Plain Contour Contour	N/A N/A 6			HONDA CRF 150 F	03-20
MD6319C	R	Solid	230	N/A	Contour	N/A			YAMAHA WR 250 R WR 250 X Supermotard	08-15 08-11
MD6320C	F	Floating	250	Gold	Contour	6			YAMAHA WR 250 R	08-17
MD6321C	R	Solid	198	N/A	Contour	N/A			CAN AM DS 450 2x4/EFI DS 450 X 2x4/EFI DS 450 Xxc/Xxm	08-15 08-09 10-15
MD6322C	F	Solid	225.5	N/A	Contour	N/A			CAN AM DS 450 2x4/EFI DS 450 X 2x4/EFI DS 450 Xxc/Xxm	08-15 08-09 10-15
MD6323C	F	Floating	298	Gold	Contour	6			YAMAHA WR 250 X Supermotard	08-11
MD6325D UTVX6325	F F	Solid Solid	220 220	N/A N/A	Plain Vee	N/A N/A			KAWASAKI KRF 750 Teryx 750 4x4 KRF 750 Teryx 750 4x4 LE KRF 750 Teryx 750 4x4 NRA Outdoors KRF 750 Teryx 750 Fi 4x4 KRF 750 Teryx 750 Fi 4x4 LE KRF 750 Teryx 750 Fi 4x4 Le Sport KRF 750 Teryx 750 Fi 4x4 NRA Outdoors KRF 750 Teryx 750 Fi 4x4 Sport KRF 750 Teryx 750 Fi 4x4 SGE	08 08 08 09-13 09-13 09 09 10-13 10-12
MD6326C	R	Solid	240	N/A	Contour	N/A			KAWASAKI KLX 250 S KLX 300 KLX 300 R KLX 300 SM	09-21 21-24 19-24 19-24
MD6327C	R	Solid	186	N/A	Contour	N/A			KAWASAKI KLX 140 KLX 140 L	08-24 08-21
MD6328C	F	Solid	220	N/A	Contour	N/A			KAWASAKI KLX 140 KLX 140 L	08-24 08-21
MD6330D MD6330C MD6330CX OSX6330 SMX6330	F F F F F	Floating Floating Floating Floating Floating	250 250 250 280 320	Silver Silver Silver Silver Black	Plain Contour Vee Contour Contour	6 6 6 6 6		BRK021 BRK022	KAWASAKI KLX 250 S KLX 250	01-09 14-20
MD6331D	R	Solid	200	N/A	Plain	N/A			HONDA TRX 700 XX	08-11
MD6332D UTVX6332	R R	Solid Solid	185 185	N/A N/A	Plain Vee	N/A N/A			YAMAHA YXR 700 RHINO F1 ALL MODELS	08-13
MD6333D	R	Solid	165	N/A	Plain	N/A			YAMAHA YXR 700 Rhino F1 All models	08-13
MD6334D	R	Solid	180	N/A	Plain	N/A			BOMBARDIER DS 90 X 2x4/4T	08-15
MD6335D	F	Solid	165	N/A	Plain	N/A			BOMBARDIER DS 90 X 2x4/4T	08-15

BRAKE ROTOR BUYERS GUIDE - DIRTBIKE/ATV/UTV

Rotor No.	F/R	Type	Dia. (mm)	Hub Color	Profile	Bobbins	Left Bracket	Right Bracket	Model	Year
MD6336C	F	Floating	180	Gold	Contour	6			KTM SX 450 XC 450 SX 505 XC 525	09-12 08-12 09-12 08-12
MD6337D	R	Solid	200	N/A	Plain	N/A			KTM SX 450 XC 450 SX 505 XC 525	09-12 08-12 09-12 08-12
MD6338D UTVX6338	F F	Solid Solid	227 227	N/A N/A	Plain Vee	N/A N/A			POLARIS Sportsman 1000 XP S 55 Sportsman 1000 XP Tractor General 1000 EPS 500 Ranger EFi 4 x 4 H.O. 700 Ranger 4 x 4 EFi 800 Ranger 800 Ranger EFi 800 Ranger XP 800 Ranger 6 x 6 800 Ranger Crew 900 Ranger Crew 900 D Crew Ranger Diesel 900 D Ranger Diesel 900 Ranger XP 900 Ranger XP R27 900 Ranger R18RV 900 Ranger CREW XP 6P SP 900 Ranger CREW EPS 900 Ranger CREW 6P SP 1000 Ranger Diesel 1000 Ranger Diesel Crew 1000 Ranger EPS 1000 Ranger XP 1000 Ranger Crew XP PS 1000 Ranger Crew XP PS 1000 Ranger XP Crew PS 1000 Ranger Crew XP 6P PS NB 1000 Ranger Crew PS 1000 Ranger Crew Premium 1000 Ranger Crew XP Premium 1000 Ranger Crew XP NorthStar Edition Premium 1000 Ranger Diesel Poland 1000 Ranger Diesel EU 1000 Ranger Crew Diesel 1000 Ranger Crew Factory Choice 49/50S 1000 Ranger Crew PS EPS HD 1000 Ranger Crew Mud XP PS NSTR 1000 Ranger Diesel 1000 Ranger Diesel RZR 570 RZR 570 Trail Premium RZR 570 Trail RZR 570 Trail RZR 570 Trail S RZR-4 800 EPS RZR 900 RZR-S 900 RZR 900 XP RZR 900 4 XP RZR 4 900 RZR 4 900 RZR 1000 60" Inch	20-21 16-21 16-20 09-11 09-11 09-11 13-14 10-12 10-17 10-12 10-15 13-14 11-14 13-14 15-19 16-19 18 19 17 15-20 15 22-23 22-23 18 17 18-23 17 18-20 22-23 22-23 23 17-18 17 17-18 18-20 18-20 18-20 17 18 14-19 20-21 20-21 20-21 20-21 12 15-20 15-20 11-14 12-16 17 16-18

BUYERS GUIDE
BRAKE ROTORS

BRAKE ROTOR BUYERS GUIDE - DIRTBIKE/ATV/UTV

Rotor No.	F/R	Type	Dia. (mm)	Hub Color	Profile	Bobbins	Left Bracket	Right Bracket	Model	Year
MD6339D	F & R	Solid	246	N/A	Plain	N/A			POLARIS Sportsman 500 XP Sportsman 550 550 Sportsman 550 550 EPS Sportsman 550 550 Forest Sportsman 550 550 XP EPS Sportsman 550 550 X2 Sportsman 550 550 Touring EPS Sportsman 800 Sportsman 800 Forest Forest 850 Scrambler 850 Sportsman 850 Touring EPS Sportsman 850 Touring H.O. EPS Sportsman 850 Forest Scrambler 850 XP H.O. Sportsman 850 XP Sportsman 850 XP EPS Sportsman 850 XP H.O. EPS Forest 1000 Scrambler 1000 Scrambler 1000 XP Scrambler 1000 XP Sportsman 1000 MD/XP Sportsman 1000 Touring XP Sportsman 1000 MD/XP Sportsman 1000 High Lifter	09 11-13 10-14 10-12 09-11 10-14 10-14 12-14 12 15 15 10-13 13-15 12 13-15 09-13 09-13 13-15 15 15 15-21 15-19 15-20 16-22 19
MD6341D	F & R	Solid	200	N/A	Plain	N/A			HONDA SXS 500 M2 Pioneer MUV 700 Big Red SXS 700 M2 Pioneer 2 Seat SXS 700 M4 Pioneer 4 Seat	15-17 09-13 14-23 14-23
MD6342D	R	Solid	220	N/A	Plain	N/A			BMW	
MD6342C	R	Solid	220	N/A	Contour	N/A			G 450 X	08-11
MD6343C	F	Solid	260	N/A	Contour	N/A			BMW	
OSX6343	F	Floating	280	Silver	Contour	6			G 450 X	08-11
SMX6343	F	Floating	320	Black	Contour	6				
MD6344D	R	Solid	220	N/A	Plain	N/A			POLARIS	
UTVX6344	R	Solid	220	N/A	Vee	N/A			RZR 170	09-15
MD6351C	F	Floating	300	Gold	Contour	6			KAWASAKI KLX 250 SF Supermotard KLX 300 SM	09-10 21-24
MD6352C	R	Solid	240	N/A	Contour	N/A			KAWASAKI KLX 250 SF Supermotard	09-10
MD6353D	F	Solid	125	N/A	Plain	N/A			POLARIS	
UTVX6353	F	Solid	125	N/A	Vee	N/A			RZR 170	09-15
MD6355D	F	Solid	190	N/A	Plain	N/A			SUZUKI LT-A 500 King Quad AXi All Models LT-A 750 King Quad Axi All Models	09-23 09-23
MD6356D	F	Floating	250	Gold	Plain	6			YAMAHA	
MD6356C	F	Floating	250	Gold	Contour	6			YZ 125	01-16
MD6356CX	F	Floating	250	Gold	Vee	6			WR 250 F 4T	01-16
									YZ 250 2T	01-16
									YZ 250 F	01-18
									YZ 450 F	03-15
									WR 450 F	03-14

BUYERS GUIDE
BRAKE ROTORS

BRAKE ROTOR BUYERS GUIDE - DIRTBIKE/ATV/UTV

Rotor No.	F/R	Type	Dia. (mm)	Hub Color	Profile	Bobbins	Left Bracket	Right Bracket	Model	Year
MD6360C	R	Solid	210	N/A	Contour	N/A			GAS GAS PIERER MOB MC 85 HUSQVARNA TC 85 SW 17/14 TC 85 BW 19/16 KTM SX 85 SW 17/14 SX 85 BW 19/16 FREERIDE 250 R 350 Freewind 4T 350 Freewind Electric 350 Freewind Electric	21-22 14-22 14-22 12-20 12-20 15-21 12 12 12
MD6362C	R	Solid	190	N/A	Contour	N/A			KAWASAKI KLX 150 S	09-11
MD6363C	F	Solid	240	N/A	Contour	N/A			KAWASAKI KLX 150 S	09-11
MD6365D	F	Solid	196	N/A	Plain	N/A			HONDA TRX 500 FPM Fourtrax Foreman TRX 500 FM Fourtrax Foreman TRX 500 FPE Fourtrax Foreman TRX 500 FE Fourtrax Foreman	12-13 12-13 12-13 12-13
MD6366D UTVX6366	F & R F & R	Solid Solid	215 215	N/A N/A	Contour Vee	N/A N/A			CAN AM SXS Commander 800 XT/DPS SXS Commander 800 SXS Commander 800 SXS Commander 800 R SXS Commander 800 R XT SXS Commander 1000 STD SXS Commander 1000 SXS Commander 1000 SXS Commander 1000 DPS SXS Commander 1000 LTD SXS Commander 1000 X SXS Commander 1000 XT SXS Commander 1000 XT-P SXS Commander Max 1000 DPS/XT SXS Maverick 1000 Std SXS Maverick 1000 XRS SXS Maverick 1000 STD/XRS/XRS - DPS SXS Maverick 1000 XXC Ryker Ryker 600 Ace Ace Ryker Ryker 900 Ace Ace	11-15 11 12-15 11-15 11-14 11-15 11 12-17 13-15 12-14 11-13 11-15 14-15 14 13 13 14-16 14-16 18-21 18-21
MD6367C	F	Floating	260	Gold	Contour	6			BETA RR 350 4T Enduro RR 525 4T Enduro	11 05-09
MD6368C	R	Solid	240	N/A	Contour	N/A			BETA RR 350 4T Enduro RR 525 4T Enduro	11 05-09
MD6369D	R	Solid	220	N/A	Plain	N/A			YAMAHA YFM 300 FB Grizzly YFM 300 GB/GD Grizzly	12 12-13
MD6370D UTVX6370	F & R F & R	Solid Solid	215 215	N/A N/A	Contour Vee	N/A N/A			CAN AM Outlander 450 All Models Outlander L 450 EFI Outlander L 450 Max EFI Outlander 500 4 X 4 STD, DPS, XT Outlander Max 500 4 X 4 STD, DPS, XT Outlander 500 L EFI Outlander Max 500 L EFI Renegade 500 STD, EFI Outlander 570 Max Pro	18-23 15 15 13-15 13-14 15 15 12-15 17

BRAKE ROTOR BUYERS GUIDE - DIRTBIKE/ATV/UTV

Rotor No.	F/R	Type	Dia. (mm)	Hub Color	Profile	Bobbins	Left Bracket	Right Bracket	Model	Year	
MD6370D UTVX6370 Contd.	F & R	Solid	215	N/A	Contour	N/A			Outlander 570 T3 EFI inc 3FJD	18	
	F & R	Solid	215	N/A	Vee	N/A			Outlander 570 All Models	18-23	
									Renegade 570 All Models	18-23	
									Outlander 650 All Models	13-23	
									Outlander Max 650 All Models	13-23	
									Outlander 650 EFI T3 & MAX	18-19	
									Outlander 650 Max EFI T3 Pro inc DPS XT	18-19	
									Outlander 650 EFI 6x6	16-22	
									Outlander 650 T EFI, XT, XU+ & T MAX	21-22	
									Renegade 650 All Models	18-23	
									Outlander 800 R STD	12-15	
									Outlander 800 R STD, DPS, XT, XT-P	14-15	
									Outlander MAX 800 R STD, DPS, XT, XT-P	14-15	
									Outlander 800 R XT, XXC	12-15	
									Outlander 800 R Mmr	15	
									Renegade 800 EFI STD & XXC	13-15	
									Renegade 800 R XXC	12-14	
									Outlander 850 EFI G2	18-19	
									Outlander 850 EFI STD, DPS, XT & XT-P	18-21	
									Outlander 850 XMR	20-21	
									Outlander 850 EFI Max G2	18-19	
									Outlander 850 EFI Max XT XT-P	20-21	
									Renegade 850 EFI STD XXC	18-23	
									Outlander 1000 STD	12	
									Outlander 1000 XT	12	
									Outlander 1000 DPS, XT, XT-P	13	
									Outlander 1000 4 x 4	13-15	
									Outlander 1000 XMR	13-18	
									Outlander 1000 XMR	20-21	
									Outlander 1000 Max DPS, XT, XT-P	13-14	
									Outlander 1000 Max EFI T3 L and R	16-19	
									Outlander 1000 EFI T3, R, XXC	18-21	
									Outlander 1000 6x6 EFI T3	16-21	
									Outlander 1000 6x6 XT	14-15	
									Outlander 1000 All Models	18-23	
									Outlander Max 1000 All Models	18-23	
									Renegade 1000 All Models	17-23	
									Renegade 1000 STD EFI	12-14	
									Renegade 1000 XXC	12-14	
	MD6371D MD6371C	R	Solid	220	N/A	Plain	N/A			KTM	
		R	Solid	220	N/A	Contour	N/A			EXC 350 LC4 Standadr forks	94-95
										Duke 400 LC4	94-98
										EGS 400/EGS-E/LSE LC4 Enduro	96-99
										LC4-E 400 Enduro	00-01
										SC 400 Supercompetition LC4	96-99
										EXC 440	94-95
										SX 440	94-95
										LC4 MX 600 Brembo Calipers	90-91
										LC4 EXC 600 Brembo Calipers	90-91
										LC4 MX 600 Grimeca Calipers	90-91
										LC4 EXC 600 Grimeca Calipers	90-91
										LC4 EXC 600	92-93
										Duke 620 LC4	94-98
										EGS 620 Enduro/EGS-E/LSE	96-99
										EGS-E 620 Adventure/Rallye	99
										LC4 620 SC Supermoto	00
										SC 620 Supercompetition	96-00
									SX 620/EXC/EGS	94	
									SX EXC/EGS 620	95	
									SX 620	96-99	
									LC4 625 SC Supermoto	02	
									LC4 625 SC Supercompetition	02	
									Duke II 640 Orpheus/Titan/Lime	01-	
									Duke II 640 Black/Orange	02	
									LC4-E 640 Enduro	00-04	
									LC4-E 640 Supermoto	00-04	
									LC-4 640 Adventure R	99-02	
									LC-4 Adventure	03	

BRAKE ROTOR BUYERS GUIDE - DIRTBIKE/ATV/UTV

Rotor No.	F/R	Type	Dia. (mm)	Hub Color	Profile	Bobbins	Left Bracket	Right Bracket	Model	Year
MD6371D MD6371C Contd.	R R	Solid Solid	220 220	N/A N/A	Plain Contour	N/A N/A			LC 640 Adventure R LC 640 Adventure 640 Duke Jet Black/Yellow/Adrenalin Orange SMC 660 Supermoto SMC 640 LC4 SMC 660	04 05-07 03-06 03-04 05-06 05-06
MD6372C MD6372CX	F F	Solid Solid	256 256	N/A N/A	Contour Vee	N/A N/A			HONDA CRF 250 L CRF 250 LA ABS CRF 300 L	13-17 17 21-22
MD6373C MD6373CX	R R	Solid Solid	220 220	N/A N/A	Contour Vee	N/A N/A			HONDA CRF 250 L CRF 250 LA ABS CRF 250 RL Rally CRF 250 RLA Rally ABS	13-21 17-21 17-21 17-21
MD6374D UTVX6374	R R	Solid Solid	218 218	N/A N/A	Contour Vee	N/A N/A			POLARIS RZR 900 XP RZR 900 4 XP RZR 4 900	11-14 12-16 17-18
MD6375D	F & R	Solid	200	N/A	Plain	N/A			ARCTIC CAT USE MD6383D	
MD6376D UTVX6376	R R	Solid Solid	200 200	N/A N/A	Plain Vee	N/A N/A			KYMCO MXU 500 4x4/IRS MXU 500 SXS MXU 500i/IRS All EFI Models UXV 500i All EFI Models MXU 700i All models	10-11 09-14 12-14 13-14 13-14
MD6379C MD6379CX	F F	Solid Solid	240 240	N/A N/A	Contour Contour	N/A N/A			HUSQVARNA TC 85 SW TC 85 BW GAS GAS PIERER MOB MC 85 SW MC 85 BW KTM SX 85 SW 17/14 SX 85 BW 19/16	21-24 21-24 21-24 21-24 21-24 21-24
MD6380D UTVX6380	F & R F & R	Solid Solid	247 247	N/A N/A	Plain Vee	N/A N/A			POLARIS POLARIS RZR SIDE X SIDE MODELS Ranger 902D EU Tractor R07 RZR 1000 XP RZR 1000 XP RZR XP 1000 Sport RZR XP 1000 Premium RZR XP 1000 High Lifter RZR XP 4 1000 High Lifter RZR 1000 Z19VCE99AM RZR RS1 RZR 1000 XP 4 RZR 1000 XP 4 RZR 1000 XP 4 RZR 1000 XP 4 MD RZR 1000 XP 4 MD RZR Pro XP Turbo RZR Pro XP Sport RZR Pro XP Premium RZR Pro XP Ultimate RZR Pro XP 4 Sport RZR Pro XP 4 Premium RZR Pro XP 4 Ultimate RZR XP Turbo RZR XP Turbo Latin RZR XP Turbo MD RZR XP Turbo S	19-20 16-17 12-19 21-22 21-22 21-22 21-22 21-22 18-20 18-22 19-20 18 16-17 17 18-19 20-21 21-22 21-22 21-22 21-22 21-22 21-22 17-20 18 17-18 18-20

BUYERS GUIDE
BRAKE ROTORS

BRAKE ROTOR BUYERS GUIDE - DIRTBIKE/ATV/UTV

Rotor No.	F/R	Type	Dia. (mm)	Hub Color	Profile	Bobbins	Left Bracket	Right Bracket	Model	Year
MD6380D UTVX6380 Contd.	F & R	Solid	247	N/A	Plain	N/A			RZR XP Turbo Tractor	17-18
	F & R	Solid	247	N/A	Vee	N/A			RZR XP 4 1000 Turbo	17-22
									RZR XP4 Turbo Intl	17
									RZR XP4 Turbo MD	18-20
									RZR Turbo S 4	21-22
									RZR Turbo S 4 Velocity	21-22
									RZR Turbo S	19-22
									RZR Turbo S Velocity	19-22
									General 1000 Sport	21-23
									General 1000 Premium	21-22
									General 1000 Deluxe	21-22
									General 1000 Deluxe Ride Command Edition	21-22
									General 1000 XP Deluxe	21-22
									General 1000 XP Premium	23
									General 1000 XP Sport	23
									General 1000 XP Ultimate	23
									General 1000 XP Deluxe Ride Command Edition	21-22
									General 1000 XP Trailhead Edition	21-22
									General 1000 4 Premium	21-22
									General 1000 4 Deluxe Ride Command Edition	21-22
								General 1000 XP 4 Deluxe	21-22	
								General 1000 XP 4 Deluxe Ride Command Edition	21-22	
								General 1000 XP 4 Trailhead Edition	21-22	
MD6381D	R	Solid	200	N/A	Plain	N/A			YAMAHA	14-15
									YXM 700 Viking Fi 4x4 EPS Parking brake	14-15
									YXM 700 Viking Fi Parking brake	14-15
									YXC 700 DFG Viking V1 Parking brake	15-16
									YXC 700 PFG Viking V1 EPS Parking brake	15
									YXC 700 PSF Viking EPS Parking brake	15
									YXM 700 PSE/PSF Viking EPS Parking brake	14-15
									EPS YXE 85W Wolverine X2	21-24
									EPS YXF 85W Wolverine X4	21-24
MD6382D UTVX6382	F & R	Solid	205	N/A	Plain	N/A			YAMAHA	14-15
	F & R	Solid	205	N/A	Vee	N/A			YXM 700 Viking Fi 4x4 EPS	14-15
									YXM 700 Viking Fi	14-15
									YXC 700 DFG/dxg Viking V1	15-16
									YXC 700 PFG Viking V1 EPS	15
									YXC 700 PSF Viking EPS	15
									YXM 700 PSE/PSF Viking EPS	14-15
									EPS YXE 85W Wolverine X2	21-24
									EPS YXF 85W Wolverine X4	21-24
MD6383D UTVX6383	F & R	Solid	203	N/A	Plain	N/A			ARCTIC CAT ATV/SIDE X SIDE	16-18
	F & R	Solid	203	N/A	Vee	N/A			Alterra 400	16-23
									Alterra 450 all models	16-19
									Alterra 500	16-19
									Alterra TRV 550 XT	16-19
									Alterra 570	19-20
									Alterra 600 all models	22-23
									Alterra 700 inc XT & Mudpro	16-23
									Alterra TBX 700	17-18
									Alterra VLX 700	17-18
									XR 700 LTD/XT	15
									Alterra 1000 TRV XT EPS	17
									1000 Mudpro SE EPS	16
									Wildcat X 1000	14-16
								Wildcat x SE EPS 1000	16	
MD6384D UTVX6384	F & R	Solid	252	N/A	Plain	N/A			ARCTIC CAT SXS	15-19
	F & R	Solid	252	N/A	Vee	N/A			Wildcat Trail 700 XT inc LTD	14-16
									Wildcat 4X 1000	14-15
									Wildcat 4X LTD 1000	13-14
									Wildcat 4 LTD 1000	14

BRAKE ROTOR BUYERS GUIDE - DIRTBIKE/ATV/UTV

Rotor No.	F/R	Type	Dia. (mm)	Hub Color	Profile	Bobbins	Left Bracket	Right Bracket	Model	Year
MD6385C	F	Solid	260	N/A	Plain	N/A			SHERCO SE 250i SE 300i SE-R 300	12-15 12-15 12-15
MD6386C	R	Solid	220	N/A	Plain	N/A			SHERCO 250 SCF-Factory 250 SEF-R 300 SCF-Factory 300 SEF-R 450 SCF-Factory 500 SCF-Factory 500 SEF-R BETA RE 125 Enduro RR 125 Enduro	19-21 19-21 19-21 19-20 19-20 19-20 19-20 19-20 10-14 10-14
MD6387D	F	Solid	190	N/A	Plain	N/A			HONDA TRX 420 Rancher All Models TRX 500 FA5 AC Foreman Rubicon 4x4 Auto/DCT TRX 500 FA6 AC Foreman Rubicon 4x4 Auto/DCT/EPS TRX 500 FA7 AC, 2AC Foreman Rubicon 4x4 Auto/DCT/EPS TRX 500 FE1 Foreman ES TRX 500 FE2 AC/2AC Foreman ES/EPS TRX 500 FM1 AC Foreman TRX 500 FM2 AC, 2AC Foreman EPS TRX 500 FM5 Foreman Rubicon 4x4 TRX 500 FM6 AC,2AC Foreman Rubicon 4x4/EPS TRX 500 FZ2 Foreman ES/EPS TRX 520 FA5 Foreman Rubicon All Models TRX 520 FE Foreman All Models	14-24 15-19 15-19 15-19 14-21 15-19 15-19 15-19 15-21 15-19 15-19 14-21 20-24 20-24
MD6388C MD6388CX	F F	Floating Floating	270 270	Gold Gold	Contour Vee	6 6			KAWASAKI KX 250 F 270mm f/rotor, 240mm r/rotor KX 250 F 270mm f/rotor, 250mm r/rotor KX 250 F 270mm f/rotor, 240mm r/rotor KX-F 250 X KX 450 F FFF/HGF/HHF KX-F 450 KX-F 450 SR Limited Edition Special Racer KXF 450 Tomac KX-F 450 X	15-19 20 21-24 21-24 15-17 18-24 22-24 18-19 21-24
MD6389CX OSX6389 SMX6389	F F F	Solid Floating Floating	260 280 320	N/A Silver Black	Vee Contour Contour	6 6 6			HONDA HONDA CRF 250 R AC HONDA CRF 250 RX HONDA CRF 450 R HONDA CRF 450 R HONDA CRF 450 R-S F-disc 260mm, R-disc 240mm HONDA CRF 450 RWE HONDA CRF 450 X	15-24 19-24 15-21 17-24 22-24 19-24 17-21
MD6390D MD6390C	F F	Solid Solid	220 220	N/A N/A	Plain Contour	N/A N/A			HONDA CRF 125F CRF 125FB	14-22 14-22
MD6392C MD6392CX OSX6392	F F F	Floating Floating Floating	270 270 280	Gold Gold Silver	Contour Vee Contour	6 6 6		BRK002	YAMAHA YZ 125 YZ 125 50th Anniversary Edition YZ 125 Monster energy YZ 125 X WR 250 F 4T YZ 250 2T YZ 250 50th Anniversary Edition YZ 250 Monster Energy 2T YZ 250 F YZ 250 F 50th Anniversary Edition YZ 250 FGY 60th Anniversary Model YZ 450 F	17-24 24 22 21-24 17-24 21-24 24 22 16-24 24 16 16-24

BUYERS GUIDE
BRAKE ROTORS

BRAKE ROTOR BUYERS GUIDE - DIRTBIKE/ATV/UTV

Rotor No.	F/R	Type	Dia. (mm)	Hub Color	Profile	Bobbins	Left Bracket	Right Bracket	Model	Year
MD6392C MD6392CX OSX6392 Contd.	F F F	Floating Floating Floating	270 270 280	Gold Gold Silver	Contour Vee Contour	6 6 6		BRK002	YZ 450 F 50th Anniversary Edition YZ 450 FGY 60th Anniversary Model WR 450 F	24 16 16-24
MD6395D UTVX6395	F & R F & R	Solid Solid	245 245	N/A N/A	Plain Vee	N/A N/A			YAMAHA YZX 1000 R EPS Special Edition Wolverine RMAX2 LE & SE Wolverine RMAX4 LE & SE YZX 1000 R	16-21 21-22 21-22 16-22
MD6396D UTVX6396	F & R F & R	Solid Solid	220 220	N/A N/A	Plain Vee	N/A N/A			CAN AM Commander 700 EFI - DPS - XT Commander 1000R All Models Commander MAX 1000R All Models Defender HD5 500cc Defender HD8 All Models Defender Max HD8 All Models Defender HD7 All Models Defender Max HD7 All Models Defender HD8 799cc Defender HD9 All Models Defender Max HD9 All Models Defender Max HD8 All Models Defender HD10 All Models Defender Max HD10 All Models Defender PRO HD10 Defender T T Defender 976cc Defender 976cc DPS Defender 976cc XT Defender 976cc XT Cab Maverick Trail 700 All Models Maverick Trail 800 Trail EFI Maverick Sport 1000R All Models Maverick Sport MAX 1000R All Models Maverick Trail 1000 All Models Traxter HD5 All Models Traxter HD7 All Models Traxter HD8 All Models Traxter HD9 All Models Traxter HD10 All Models Traxter Max HD9 All Models Traxter Max HD10 All Models Traxter Pro HD10 Traxter T T HD5 Traxter T T HD8 Traxter T T HD10	22-23 21-23 21-23 17-19 16 17 22-23 22-23 17-21 22-23 22-23 18-21 17-23 18-23 20-23 17 16 16 16 16 22-23 18-21 19-23 19-23 18-23 17-20 22-23 18-21 22-23 18-23 22-23 18-23 22-23 18-23 22-23 18-21 18-21 18-20
MD6397D UTVX6397 OSUTVX6397	F & R F & R	Solid Solid	248 248	N/A N/A	Plain Vee	N/A N/A			POLARIS RZR XP Turbo/Latin RZR XP Turbo MD RZR XP Turbo S RZR XP Pro Turbo RZR XP Turbo Tractor RZR XP4 Turbo RZR XP4 Turbo Intl RZR XP4 Turbo MD RZR XP4 Turbo S RZR XP Turbo S Velocity RZR XP/XP4 Turbo RZR Turbo 4	17-20 17-18 18-20 20-22 17-18 17-20 17 18-20 19-20 19-20 16 19-20
MD6398D UTVX6398	F & R F & R	Solid Solid	212 212	N/A N/A	Plain Vee	N/A N/A			KAWASAKI KAF820 Mule PRO All Models KAF1000 Mule Pro All Models	15-23 16-17

BUYERS GUIDE
BRAKE ROTORS

BRAKE ROTOR BUYERS GUIDE - DIRTBIKE/ATV/UTV

Rotor No.	F/R	Type	Dia. (mm)	Hub Color	Profile	Bobbins	Left Bracket	Right Bracket	Model	Year
MD6399D UTVX6399	F & R F & R	Solid Solid	200 200	N/A N/A	Plain Vee	N/A N/A			KAWASAKI KRT 750 Tyrex 4 4X4 All Models KAWASAKI KRF/KRT 800 Teryx All models KAWASAKI KRF/KRT 800 Teryx4 All Models	12-13 14-22 14-22
MD6400D	F	Solid	260	N/A	Plain	N/A			AJP PR3 125 Enduro PR3 125 Enduro Pro PR3 125 Extreme PR3 125 Supermoto SPR 125 PR3 200 Enduro PR3 200 Enduro Pro PR3 200 M/X Pro SPR 240	13-15 13-15 13-15 13-15 22-24 12-14 12-14 12-14 22-24
MD6401D	R	Solid	220	N/A	Plain	N/A			AJP PR3 125 Enduro PR3 125 Enduro Pro PR3 125 Extreme PR3 125 Supermoto SPR 125 PR3 200 Enduro PR3 200 Enduro Pro PR3 200 M/X Pro SPR 240	13-15 13-15 13-15 13-15 22-24 12-14 12-14 12-14 22-24
MD6406D	F	Solid	300	N/A	Plain	N/A			APRILIA ETV 1000 Caponord Rally - Bush fixing ETV 1000 Caponord ABS - Bush fixing	03 04-07
MD6407C MD6407CX	F F	Solid Solid	220 220	N/A N/A	Contour Contour	N/A N/A			GAS-GAS MC 85 SW MC 85 BW HUSQVARNA TC 85 SW 17/14 TC 85 BW 19/16 KTM SX 85 SW 17/14 - 240mm F/rotor - 220mm R/rotor SX 85 BW 19/16 - 240mm F/rotor - 220mm R/rotor	21-23 21-23 14-20 14-20 14-20 14-20
MD6408D UTVX6408	F & R F & R	Solid Solid	227 227	N/A N/A	Plain Vee	N/A N/A			POLARIS 1000 General EPS 2 Seat 1000 General 4 EPS 4 Seat	17-19 17-19
MD6409C	F	Floating	296	Gold	Contour	6			HONDA CRF 250 RL Rally CRF 250 RLA Rally ABS CRF 300 RLA Rally	19-21 19-21 21-22
MD6410D UTVX6410	F & R F & R	Solid Solid	210 210	N/A N/A	Plain Vee	N/A N/A			HONDA Pioneer 1000 SXS 2 Seater Pioneer 1000 SXS 4 Seater Pioneer 1000-5 SXS 5 Seater Pioneer 1000-6 SXS 6 Seater	16-22 16-22 22-23 23
MD6411D UTVX6411 OSUTVX6411 OVERSIZE KIT DISCONTINUED	F & R F & R	Solid Solid	260 260	N/A N/A	Plain Vee	N/A N/A			CAN AM Commander 1000 EFI Commander Max 1000 DPS/XT Commander Max 1000 LTD Maverick 1000 STD/XRS/XRS - DPS Maverick 1000 STD_XRS_XRS - DPS Maverick 1000 XDS - DPS Maverick 1000 XMR Maverick 1000 XXC Maverick Max 1000 Std, XRS Maverick Max 1000 XDS - DPS Maverick Max 1000 XRS - DPS Maverick Max 1000 Max	18-19 15 15-17 14-16 15 15 14-15 14-16 14-15 15-16 14-15 16-17

BRAKE ROTOR BUYERS GUIDE - DIRTBIKE/ATV/UTV

Rotor No.	F/R	Type	Dia. (mm)	Hub Color	Profile	Bobbins	Left Bracket	Right Bracket	Model	Year
MD6411D UTVX6411 Contd.	F & R F & R	Solid Solid	260 260	N/A N/A	Plain Vee	N/A N/A			Maverick X3 Turbo All Models Maverick X3 Max Turbo All Models Maverick Turbo DS Maverick Turbo R All Models Maverick Turbo RR All Models	17-18 17-18 19-23 19-21 19-23
MD6412D UTVX6412	R R	Solid Solid	247.5 247.5	N/A N/A	Plain Vee	N/A N/A			Maverick Trail 700 All Models Maverick Trail 800 Trail EFI Maverick Sport 1000R All Models Maverick Sport MAX 1000R All Models Maverick Trail 1000 All Models Maverick X3 Turbo All Models Maverick X3 Max Turbo All Models	22-23 18-21 19-23 19-23 18-23 17-18 17-18
MD6414D MD6414C	F F	Floating Floating	320 320	Gold Gold	Plain Contour	6 6			KTM 690 SMC R ABS HUSQVARNA 701 Supermoto GAS GAS SM 700	14-24 18-24 24
MD6415D MD6415C	R R	Solid Solid	240 240	N/A N/A	Plain Contour	N/A N/A			KTM 690 Enduro R ABS 690 SMC R ABS HUSQVARNA 701 Supermoto	09-24 14-24 18-24
MD6417C	R	Floating	240	Gold	Contour	6			HUSQVARNA 701 Enduro GAS GAS ES 700	16-24 22-24
MD6418D MD6418C MD6418CX	F	Solid Solid	197 197	N/A N/A	Plain Contour	N/A N/A			YAMAHA YZ 65	18-24
MD6419D MD6419C	R	Solid Solid	190 190	N/A N/A	Plain Contour	N/A N/A			YAMAHA YZ 65	18-24
MD6421D MD6421C MD6421CX MD6421CE	R R R R	Solid Solid Solid Solid	250 250 250 250	N/A N/A N/A N/A	Plain Contour Vee Contour	N/A N/A N/A N/A			KAWASAKI KX 250 F KX 450 F SR KX 450 F	20 22-24 18-24
MD6422CX	R	Solid	270	N/A	Contour	N/A			SUZUKI RMZ 250 RMZ 450	19-24 18-24
MD6423D MD6423C	R R	Solid Solid	240 240	N/A N/A	Plain Contour	N/A N/A			KTM Super Duke 1290 R Super Duke 1290 R Evo Super Duke 1290 GT 1290 Super Adventure S 1290 Super Adventure R	14-24 21-24 16-24 15-24 15-24
MD6424D	F	Floating	267	Gold	Plain	6			KTM Adventure 1090 Adventure 1190 Super Adventure 1290 S/R	15-18 13-16 15-21
MD6425D	F & R	Solid	250	N/A	Plain	N/A			HONDA SXS 1000 R Talon Talon 1000 X Talon 1000 X-4	19-21 19-21 19-21
MD6426C	F & R	Solid	260	N/A	Contour	N/A			KTM 250 R Freeride 4T	15-21

BUYERS GUIDE
BRAKE ROTORS

BRAKE ROTOR BUYERS GUIDE - DIRTBIKE/ATV/UTV

Rotor No.	F/R	Type	Dia. (mm)	Hub Color	Profile	Bobbins	Left Bracket	Right Bracket	Model	Year
MD6429D MD6429C MD6429CX	F F F	Solid Solid Solid	260 260 260	N/A N/A N/A	Plain Contour Contour	N/A N/A N/A			SHERCO 125 SC-Factory 125 SE-Factory 125 SE-R 250 SC-Factory 250 SCF-Factory 250 SE-Factory 250 SE-Racing 250 SE-R 250 SEF-R 250 SEF-Factory 300 SE-Factory 300 SC-Factory 300 SCF-Factory 300 SE-Racing 300 SEF-R 300 SEF-Factory 300 SEF-Racing 450 SCF-Factory 450 SEF-Factory 500 SCF-Factory 500 SEF-R 500 SEF-Factory	19-24 19-24
MD6430C MD6430CX MD6430CE	R R R	Solid Solid Solid	220 220 220	N/A N/A N/A	Contour Contour Contour	N/A N/A N/A			SHERCO 125 SC Factory 125 S Factory 125 SE-R 250 SC-Factory 2T 250 SCF-Factory 250 SEF-R 250 SE-Factory 250 SE-Racing 250 SE-R 250 SEF-Factory 300 SC-Factory 2T 300 SC-Racing 2T 300 SCF-Factory 300 SEF-R 300 SEF-Factory 300 SEF-Racing 450 SCF-Factory 450 SE-R 450 SEF-Factory 500 SCF-Factory 500 SEF-R 500 SEF-Factory	19-24 19-24 19-24 19-24 19-24 19-24 21-24 19-24 19-24 19-24 22-24 19-24 19-24 19-24 19-24 19-24 19-24 19-24 19-24 19-24 19-24 19-24 19-24
MD6433CX	F	Floating	260	Silver	Contour	5			BETA RR 125 Race 200 RR Race 250 RR Race 300 RR Race 300 RX 350 RR Race 390 RR Race 430 RR Race 480 RR Race HUSQVARNA FC 450 Rockstar Edition KTM 125 EXC 250 EXC-F Six Days 250 EXC Six Days Inc Tpi 2T 250 SXF Factory Editions 250 SXF Troy Lee Editions 300 EXC Six Days Inc Tpi 300 XC-W 350 EXC-F Six Days	18-23 20-23 20-23 20-23 20-23 20-23 20-23 20-23 20-23 19-23 15-16 15-23 15-20 22-23 21-23 15-23 15-18 15-20

BUYERS GUIDE
BRAKE ROTORS

BRAKE ROTOR BUYERS GUIDE - DIRTBIKE/ATV/UTV

Rotor No.	F/R	Type	Dia. (mm)	Hub Color	Profile	Bobbins	Left Bracket	Right Bracket	Model	Year
MD6433CX Cont.	F	Floating	260	Silver	Contour	5			350 SX-F Factory Edition 350 XCF Kaleb Russel 350 XCF-W 450 EXC-F Six Days 450 SXF Factory Edition Inc Herlings and Cairoli Replicas 500 EXC-F Six Days	21-22 21 15-16 15-20 18-23 15-23
MD6434D UTVX6434	F & R	Solid	260	N/A	Plain	N/A			KAWASAKI Teryx KRX 1000 Teryx KRX 1000 eS Teryx KRX 1000 Special Edition Teryx KRX 1000 Trail Edition Teryx 1000 2 Seat Teryx 1000 Teryx 1000 2 Seat Camo Teryx 1000 Camo Teryx 1000 2 Seat LE Teryx 1000 LE Teryx4 1000 4 Seat Teryx4 1000 Teryx4 1000 4 Seat Camo Teryx4 1000 Camo Teryx4 1000 4 Seat LE Teryx4 1000 LE KRX4 Teryx 1000 eS KRX4 Tery 1000 SE	20-24 20-24 20-24 20-24 20-23 20-23 20-23 20-23 20-23 20-23 23-24 23-24
MD6435C	F	Solid	240	N/A	Plain	N/A			ZERO DS ZF8.5/ZF11.4 DS ZF8.5/ZF11.4 DS ZF9.4/ZF12.5 FX ZF2.8/ZF5.7 FX ZF2.8/ZF5.7 FX ZF2.8/ZF5.7 FX ZF3.3/ZF6.5	13 14 15 15 13 14 16-21
MD6435C	R	Solid	240	N/A	Plain	N/A			ZERO DS ZF13.0 DS ZF6.0/ZF9.0 DS ZF8.5/ZF11.4 DS ZF8.5/ZF11.4 DS ZF9.4/ZF12.5 DS II ZF14.4 DS II ZF7.2 DSR ZF13.0 DSR ZF14.4.0 DSR Black Forest Edition - ZF14.4.0 FX ZF2.8/ZF5.7 FX ZF2.8/ZF5.7 FX ZF2.8/ZF5.7 FX ZF3.3/ZF6.5 FXS ZF3.3/ZF6.5 S ZF14.4 S ZF6.0 S ZF7.2 S ZF8.5/ZF11.4 S ZF8.5/ZF11.4 S ZF9.4/ZF12.5 S ZF9.8/ZF13.0 SR ZF11.4 SR ZF12.5 SR ZF13.0 SR/ F ZF13.0 SR/S ZF13.0 SR/S Deus X ZF13.0	16-19 10-12 13 14 15 19-21 19-22 17-19 19-22 19-21 15 13 14 14 16-21 17-21 19-21 10-12 19-22 13 14 15 16-19 14 15 16-21 19-21 19-21 21
MD6436CX	R	Solid	240	N/A	Contour	N/A			TM RACING MX 125 2S EN 125 2S Inc Tsi 2T EN 144 2S Inc Tsi MX 144 2S EN 250 Fi ES Twin Enduro 4T EN 250 Tsi ES Enduro MX 250 ES 2S 2T MX 250 Fi ES 4T	10-24 10-24 10-24 10-24 10-24 10-24 10-24 10-24

BRAKE ROTOR BUYERS GUIDE - DIRTBIKE/ATV/UTV

Rotor No.	F/R	Type	Dia. (mm)	Hub Color	Profile	Bobbins	Left Bracket	Right Bracket	Model	Year
MD6436CX Contd.	R	Solid	240	N/A	Contour	N/A			EN 300 2S Inc Tsi 2T EN 300 Fi Es Twin Enduro MX 300 2S ES 2T MX 300 Fi ES 4T EN 450 Fi ES MX 450 Fi ES EN 530 Fi ES MX 530 Fi ES	10-24 10-24 10-24 10-24 10-24 10-24 10-24 10-24
MD6437CX	F	Solid	270	N/A	Contour	N/A			TM RACING MX 125 2S EN 125 2S Inc Tsi 2T EN 144 2S Inc Tsi MX 144 2S EN 250 Fi ES Twin Enduro 4T EN 250 Tsi ES Enduro MX 250 ES 2S 2T MX 250 Fi ES 4T EN 300 2S Inc Tsi 2T EN 300 Fi Es Twin Enduro MX 300 2S ES 2T MX 300 Fi ES 4T EN 450 Fi ES MX 450 Fi ES EN 530 Fi ES	10-24 10-24 10-24 10-24 10-24 10-24 10-24 10-24 10-24 10-24 10-24 10-24 10-24 10-24 10-24
MD6438C	R	Solid	220	N/A	contour	N/A			CAN AM DS 450 Xxc/Xxm	10-15
MD6441D	R	Solid	170	N/A	Plain	N/A			HONDA TRX 420 FA5 Rancher 4x4 Auto DCT/IRS TRX 420 FA6 Rancher 4x4 Auto/DCT/IRS/EPS SXS 500 M2 Pioneer TRX 500 FA5 AC Foreman Rubicon 4x4 Auto/DCT TRX 500 FA6 AC Foreman Rubicon 4x4 Auto/DCT/EPS TRX 500 FA7 AC, 2AC Foreman Rubicon 4x4 Auto/DCT/EPS TRX 500 FM5 Foreman Rubicon 4x4 TRX 500 FM6 AC, 2AC Foreman Rubicon 4x4/EPS TRX 520 FA5 A/AC Foreman Rubicon 4x4 Auto/DCT TRX 520 FA6 AC Foreman Rubicon 4x4 Auto/DCT/EPS TRX 520 FA7 AC, 2AC Foreman Rubicon 4x4 Auto/DCT/EPS TRX 520 FM6 A/AC, 2A/2AC, 3A/AC Foreman Rubicon 4x4/EPS TRX 650 FA TRX 650 FGA TRX 680 FGA6/FGA7/FGA8 Fourtrax Rincon Gpscape 675cc TRX 680 FA Fourtrax Rincon SXS 700 M2 Pioneer 2 Seat SXS 700 M4 Pioneer 4 Seat	14-15 14-15 15-17 15-19 15-19 15-19 15 15-19 20-22 20-22 20-22 20-22 03-05 04-05 06-08 06-22 16-18 16-18
MD6442D	R	Solid	245	N/A	Plain	N/A			YAMAHA YZZ 1000 R Wolverine R-Max 2 Wolverine R-Max 4	19-23 23-24 23-24
MD6443D	F	Solid	255	N/A	Plain	N/A			YAMAHA YZZ 1000 R Wolverine R-Max 2 Wolverine R-Max 4	19-23 23-24 23-24
OSX6728 SMX6728	F F	Solid Floating	280 320	Siver Silver		6 6	BRK002 BRK034		YAMAHA YZ 125 YZ 250 2T YZ 250 4T YZ 450	08-16 08-16 07-15 08-15

BUYERS GUIDE
BRAKE ROTORS

EBC BRAKES CLUTCH KITS



HONDA



		CK cork OEM style Kit #	CKF carbon fiber style upgrade Kit #	CSK Spring Kit #	DRC Series Kit #	DRCF Series Kit #	SRC Series Kit #	SRK Series Kit #	CT Tool #
MB 5	82	CK1150		CSK3					CT012SP
CRF 50 F	04-21	CK1148		N/A			SRC90		
Dream 50 R (CB 50 R) (AR02)	04	CK1150		CSK48					CT012SP
NSR 50 R (RS 50)	04	CK1150		CSK3					CT012SP
XR 50 R	00-03	CK1148		N/A					
CR 60 R	83-84	CK1151	CKF1151	CSK3					CT012SP
ATC 70	78-85	CK1148		CSK18					
C 70	80-81	CK1148		CSK18					
C 70	82-83	CK1148		CSK18					
CRF 70 F	04-14	CK1148		CSK18					
CT 70 Trail	77-82	CK1148		CSK18					
CT 70 Trail	91-94	CK1148		CSK18					
SL 70 /K1	70-73	CK1105		N/A					
TRX 70 Fourtrax	86-87	CK1148		CSK18					
XR 70 R	97-03	CK1148		CSK18					
XL 75	77-79	CK1150		CSK48					CT012SP
CR 80 R	80-82	CK1151	CKF1151	CSK3					CT012SP
CR 80 R	83	CK1151	CKF1151	CSK23					CT012SP
CR 80 R	84	CK1119		CSK23					CT012SP
CR 80 R	85-86	CK1119		CSK173	DRC1				CT012SP
CR 80 R/RB Expert	87-02	CK1119		CSK173	DRC1				CT012SP
CRF 80 F	04-16	CK1150		CSK48					CT012SP
XL 80 S	80-85	CK1150		CSK22					CT012SP
XR 80/XR 80 R	79-94	CK1150		CSK22					CT012SP
XR 80 R	95-03	CK1150		CSK48					CT012SP
CR 85 R/RB	03-06	CK1119		CSK173	DRC1				CT012SP
TRX 90 Fourtrax/Sportrax	93-06	CK1151	CKF1151	N/A					CT012SP
TRX 90 EX	07-08	CK1151	CKF1151	N/A					CT012SP
TRX 90 X	09-15	CK1151	CKF1151	N/A					CT012SP
CRF 100 F	04-15	CK1151	CKF1151	CSK23	DRC49	DRCF49			CT012SP
NSF 100 R	06	CK1151	CKF1151	CSK23					CT012SP
SL 100 K	70-74	CK1119		CSK4					CT012SP
XL 100	74	CK1119		CSK4					CT012SP
XL 100 K	75	CK1119		CSK4					CT012SP
XL 100	76-78	CK1119		CSK167					CT012SP
XL 100 S	79-80	CK1151	CKF1151	CSK8					CT012SP
XL 100 S	81-85	CK1151	CKF1151	CSK8					CT012SP
XR 100 R	81-86	CK1151	CKF1151	CSK22					CT012SP
XR 100 R	87-03	CK1151	CKF1151	CSK23	DRC49	DRCF49			CT012SP
ATC 110	79-85	CK1156		CSK18					
CRF 110 R	13-19	TBA		N/A					
CT 110 Trail	80-86	CK1156		CSK18					
ATC 125 M	84-85	CK1156		CSK21					
ATC 125 M	86-87	CK1151	CKF1151	CSK48					CT012SP
CB 125 S	80-82	CK1119		CSK167					CT012SP
CB 125 S	84-85	CK1119		CSK167					CT012SP
CB 125 TT	90	CK1252		CSK167					CT012SP
CBR 125 R/RW (With Judder Spring / Canada)	04-06	CK1252		CSK193					CT012SP
CBR 125 RW/R (No Judder Spring / Canada)	07-13	CK1119	CKF1119	CSK193			SRC119	SRK119	CT012SP
CG 125 (CA/KS/KSE) Drum Front Brake	01-06	CK1119		CSK167					CT012SP
CG 125 (ES) Disc Front Brake	01-04	CK1119		CSK167					CT012SP
CL 125 A (Scrambler Twin)	65	N/A		N/A					
CL 125 S (Single)	67-74	CK1119		CSK4					CT012SP
CR 125 M Elsinore	74-78	CK1144		CSK36					CT002
CR 125 R Elsinore	79-80	CK1199		CSK31					
CR 125 R Elsinore	81	CK1191	CKF1191	CSK31					CT002
CR 125 R	82	CK1186		CSK31					CT002

CLUTCH APPLICATIONS

EBC BRAKES CLUTCH KITS



HONDA



		CK cork OEM style Kit #	CKF carbon fiber style upgrade Kit #	CSK Spring Kit #	DRC Series Kit #	DRCF Series Kit #	SRC Series Kit #	SRK Series Kit #	CT Tool #
CR 125 R	83-84	CK1190	CKF1190	CSK24	DRC67				CT013
CR 125 R	85	CK1200		CSK24	DRC68				CT001
CR 125 R	86-99	CK1222		CSK24	DRC2				CT001
CR 125 R	00-03	CK1293	CKF1293	CSK77	DRC262	DRCF262			CT001
CR 125 R	00-07	CK1293	CKF1293	CSK77	DRC101	DRCF101			CT001
CRF 125 F	14-16	CK1325		CSK273					
CRF 125 FB	14-16	CK1325		CSK273					
CT 125	77	CK1119		CSK167					CT012SP
Monkey 125	19-21	CK1315		CSK197			SRC122	SRK122	CT084SP
MSX 125 GROM	13-21	CK1315		CSK197			SRC122	SRK122	CT084SP
MSX 125 GROM (ABS)	18-21	CK1315		CSK197			SRC122	SRK122	CT084SP
MT 125/K1 Elsinore	74-76	CK1144		N/A					CT002
NX 125	88-90	CK1252		CSK167	DRC50				CT012SP
NXR 125 (JC30)	03-08	CK1119		CSK167					CT012SP
SL 125 K	71-73	CK1119		CSK4					CT012SP
SS 125 A (Supersport 125)	65	N/A		N/A					
TL 125 K	71-75	CK1151		CSK167					CT012SP
TL 125 S	76	CK1119		CSK167					CT012SP
TRX 125 Fourtrax	85-86	CK1156		CSK21					
TRX 125 Fourtrax	87-88	CK1151	CKF1151	CSK48					CT012SP
XL 125 K	74-75	CK1119		CSK4					CT012SP
XL 125	76-78	CK1119		CSK4					CT012SP
XL 125 S	79-84	CK1119		CSK31					CT012SP
XL 125 S	85	CK1119		CSK167					CT012SP
CRF 150 F	03-05	CK1304		CSK77	DRC180				CT012SP
CRF 150 R (Small Wheel F 17 Inch/ R 14 Inch)	07-21	CK1191	CKF1191	CSK134	DRC182	DRCF182			CT002
CRF 150 RB (Big Wheel F 19 Inch/ R 16 Inch)	07-21	CK1191	CKF1191	CSK134	DRC182	DRCF182			CT002
NXR 150 (KD02)	03-08	CK1252		TBA					CT012SP
NXR 150 (KD03) Front Disc Model	03-08	CK1119		TBA					CT012SP
NXR 150 (KD03) Front Drum Model	03-08	CK1119		TBA					CT012SP
CD 175	67-68	CK1123		CSK8					
CD 175 K	69-71	CK1134		CSK8					
CL 175 (6 Friction Plate Clutch)	68-69	CK1123		CSK8					
CL 175 K (5 Friction Plate Clutch)	70-71	CK1134		CSK8					
MR 175 Elsinore	75-77	CK1144		CSK36					CT002
SL 175 K	72-73	CK1134		CSK8					
XL 175 K/76/77/78	72-78	CK1134		CSK8					
ATC 185/185 S	80-83	CK1151	CKF1151	CSK22					CT012SP
ATC 185/185 S Centrifugal (one way) clutch	80-83	CK5544							
XL 185 S	79-80	CK1119		CSK167					CT012SP
XL 185 S	81-83	CK1119		CSK9					CT012SP
XR 185	79	CK1119		CSK167					CT012SP
ATC 200	81-83	CK1151	CKF1151	CSK22					CT012SP
ATC 200 Centrifugal (one way) clutch	81-83	CK5544							
ATC 200 E Big Red	82-83	CK1151	CKF1151	CSK22					CT012SP
ATC 200 E Big Red Centrifugal (one way) clutch	82-83	CK5544							
ATC 200 ES Big Red	84	CK1151	CKF1151	CSK22					CT012SP
ATC 200 ES Big Red Centrifugal (one way) clutch	84	CK5544							
ATC 200 M	84-85	CK1151	CKF1151	CSK22					CT012SP
ATC 200 M Centrifugal (one way) clutch	84-85	CK5544							
ATC 200 S	84-86	CK1151	CKF1151	CSK22					CT012SP
ATC 200 S Centrifugal (one way) clutch	84-86	CK5544							
ATC 200 X	83-85	CK1119		CSK24					CT012SP
ATC 200 X	86-87	CK1119		CSK30					CT012SP
CM 200 T	80-82	CK1119		CSK9					CT012SP
TLR 200	86-87	CK1119		CSK167					CT012SP
TR 200 Fatcat	86-87	CK1119		CSK172					CT012SP

CLUTCH
APPLICATIONS

EBC BRAKES CLUTCH KITS



HONDA



		CK cork OEM style Kit #	CKF carbon fiber style upgrade Kit #	CSK Spring Kit #	DRC Series Kit #	DRCF Series Kit #	SRC Series Kit #	SRK Series Kit #	CT Tool #
TRX 200 Fourtrax	84	CK1151	CKF1151	CSK22					CT012SP
TRX 200 Fourtrax Centrifugal (one way) clutch	84	CK5544							
TRX 200 SX Fourtrax	86-88	CK1119		CSK172	DRC4				CT012SP
TRX 200 Fourtrax	90-91	CK1119		CSK172	DRC4				CT012SP
TRX 200 D Type II Fourtrax	91-97	CK1119		CSK172	DRC4				CT012SP
XL 200 R	83-84	CK1119		CSK105					CT012SP
XR 200	80-84	CK1119		CSK105	DRC91				CT012SP
XR 200 R	81-83	CK1119		CSK105	DRC91				CT012SP
XR 200 R	84-85	CK1180		CSK4	DRC60				CT013SP
XR 200 R	86-02	CK1119		CSK105	DRC91				CT012SP
CRF 230 F	03-16	CK1304		CSK24	DRC136				CT012SP
CRF 230 L	08-11	CK1252		CSK9	DRC249				CT012SP
CRF 230 M	09-11	CK1252		CSK9	DRC249				CT012SP
ATC 250 R	81-84	CK1163		CSK31					
ATC 250 R	85	CK1193	CKF1193	CSK28	DRC93				CT013SP
ATC 250 R	86	CK1193	CKF1193	CSK32	DRC5				CT013SP
ATC 250 ES Big Red	85-87	CK1194		CSK4					CT013SP
ATC 250 SX	85-87	CK1194		CSK4					CT013SP
CB 250 Nighthawk	91-08	CK1191	CKF1191	CSK24					CT012SP
CBR 250 R (Non ABS)	11-14	CK1313	CKF1313	CSK188					
CBR 250 RA (ABS Model)	11-14	CK1313	CKF1313	CSK188					
CM 250 C Rebel	82-83	CK1191	CKF1191	CSK105					CT012SP
CMX 250 C/CD Rebel	85-87	CK1191	CKF1191	CSK105					CT012SP
CMX 250 C/C2 Rebel	96/97/99-14	CK1191	CKF1191	CSK105					CT012SP
CMX 250 X	15	CK1191	CKF1191	CSK105					CT012SP
CRF 250 F A/AC	19-21	CK1217		TBA	DRC335				
CR 250 M 76 Elsinore	73-77	CK1131		N/A					CT009
CR 250 R Elsinore	78-80	CK1163		CSK31					
CR 250 R Elsinore	81	CK1131		CSK41					CT009
CR 250 R	82	CK1170	CKF1170	CSK41					CT009
CR 250 R	83-89	CK1170	CKF1170	CSK28	DRC3				CT009
CR 250 R	90-93	CK1247	CKF1247	CSK28	DRC75				CT009
CR 250 R	94-07	CK1247	CKF1247	CSK178	DRC79	DRCF79			CT009
CRF 250 L (Non ABS)	13-21	CK1314	CKF1314	CSK188	DRC277	DRCF277			CT081SP
CRF 250 LA (ABS)	17-21	CK1314	CKF1314	CSK188	DRC277	DRCF277			CT081SP
CRF 250 Rally (Non ABS)	17-21	CK1314	CKF1314	CSK188	DRC277	DRCF277			CT081SP
CRF 250 Rally (ABS)	17-21	CK1314	CKF1314	CSK188	DRC277	DRCF277			CT081SP
CRF 250 R	04-07	CK1293	CKF1293	CSK176	DRC129	DRCF129			CT001
CRF 250 R	08-09	CK1305	CKF1305	CSK176	DRC208	DRCF208			CT001
CRF 250 R	10	CK1293	CKF1293	CSK164	DRC256	DRCF256			CT001
CRF 250 R	11-19	CK1305	CKF1305	CSK215	DRC261	DRCF261			CT001
CRF 250 X	04-17	CK1305	CKF1305	CSK176	DRC208	DRCF208			CT001
CRF 250 RX	18-19								
MR 250 Elsinore	76	CK1131		N/A					CT009
MT 250 K1/76	74-76	CK1131		N/A					CT009
NX 250	88-90	CK1190	CKF1190	CSK30	DRC51				CT013SP
TL 250	75-76	CK1131		CSK4					
TRX 250 Fourtrax	85-87	CK1194		CSK4					CT013SP
TRX 250 R Fourtrax	86-87	CK1193	CKF1193	CSK32	DRC5				CT013
TRX 250 R Fourtrax	88-89	CK1193	CKF1193	CSK45	DRC81				CT013
TRX 250 X Fourtrax	87-88/91-92	CK1190	CKF1190	CSK4	DRC44	DRCF44			CT013SP
TRX 250 EX (Sportrax 250 EX)	01-08	CK1119		CSK172	DRC4				CT012SP
TRX 250 TE Recon ES	97-14	CK1119		CSK172	DRC4				CT012SP
TRX 250 TM Recon	97-14	CK1119		CSK172	DRC4				CT012SP
TRX 250 X	09-14	CK1119		TBA					CT012SP
VTR 250 Interceptor	88-90	CK1235		CSK9					CT012SP
XL 250 K/76	72-76	CK1119		CSK4					

CLUTCH APPLICATIONS

Part numbers, prefixes, suffixes, photos and illustrations shown in this catalog are trademarks and/or copyrights of EBC Brakes or the trademark owner A C Freeman Investments Ltd and use without express written permission of the owners is punishable by law.

EBC BRAKES CLUTCH KITS



HONDA



		CK cork OEM style Kit #	CKF carbon fiber style upgrade Kit #	CSK Spring Kit #	DRC Series Kit #	DRCF Series Kit #	SRC Series Kit #	SRK Series Kit #	CT Tool #
XL 250 S	78-80	CK1152		CSK9					CT013SP
XL 250 S	81	CK1153		CSK9					CT013SP
XL 250 R	82-83	CK1153		CSK9					CT013SP
XL 250 R	84-87	CK1180		CSK4	DRC60				CT013SP
XR 250	79-80	CK1152		CSK9					CT013SP
XR 250 R	81-82	CK1153		CSK9					CT013SP
XR 250 R	84-85	CK1180		CSK4	DRC60				CT013SP
XR 250 R	86-95	CK1190	CKF1190	CSK4	DRC44	DRCF44			CT013SP
XR 250 R	96-04	CK1190	CKF1190	CSK77	DRC84				CT013SP
XR 250 L	91-96	CK1190	CKF1190	CSK4	DRC44	DRCF44			CT013SP
CB 300 F	15	TBA		TBA					
CBF 300 NA	18-21	CK1314		CSK188	DRC277				CT081SP
CBR 300 R (Non ABS Model)	15	TBA		TBA					
CBR 300 R (ABS Model)	15	TBA		TBA					
TRX 300 All models (2wd & 4wd) Fourtrax	88-00	CK1196		CSK23	DRC6				CT013SP
TRX 300 EX Fourtrax/Sportrax	93-08	CK1190	CKF1190	CSK4	DRC44	DRCF44			CT013SP
TRX 300 X	09-11	CK1190	CKF1190	CSK4	DRC44	DRCF44			CT013SP
ATC 350 X	85-86	CK1190	CKF1190	CSK173					CT013SP
CB 350 F/F1		CK1140		CSK82					CT013SP
CB 350 G/K		CK1132		CSK82					CT009
SL 350 KO/K1/K2	69-73	CK1134		CSK3					
TRX 350 All models	86-89	CK1196		CSK23	DRC6				CT013SP
TRX 350 TE/FE (Electric Shift)	00-05	CK1160		CSK48	DRC127				CT013SP
TRX 350 TM/FM (Manual Shift)	00-05	CK1196		CSK48	DRC126				CT013SP
XL 350 R	84-85	CK1217		CSK4					CT013SP
XR 350 R	83-85	CK1190	CKF1190	CSK4	DRC44	DRCF44			CT013SP
CB 360/360 G/T	75-76	CK1132		CSK82					CT009
CJ 360 T	76-77	CK1132		CSK82					CT009
CB 400 F	75-77	CK1140		CSK82					CT013SP
CB 400 T Hawk All models	78-81	CK1140		CSK15					CT013SP
CB-1 (CB 400 F)	89-90	CK1228		CSK6					CT009SP
CM 400 T	79-81	CK1140		CSK47					CT013SP
CM 400 C Custom	81	CK1140		CSK47					CT013SP
CM 400 E	80-81	CK1140		CSK47					CT013SP
FL 400 R Pilot	89-90	CK1234		TBA					
TRX 400 FW Fourtrax Foreman	95-01/03	CK1196		CSK23	DRC6				CT013SP
TRX 400 EX Fourtrax/Sportrax	99-08	CK1193	CKF1193	CSK73	DRC100	DRCF100			
TRX 400 FM Fourtrax Foreman	02	CK1196		CSK23	DRC6				CT013SP
TRX 400 X	09-14	CK1193	CKF1193	CSK73	DRC100	DRCF100			CT013
XR 400 R	96	CK1193	CKF1193	CSK28	DRC93				CT013
XR 400 R	97-04	CK1193	CKF1193	CSK33	DRC106				CT013
TRX 420 TM Fourtrax Rancher	07-13	CK1196		CSK154	DRC239				CT013SP
TRX 420 TM1 Rancher	14-15	CK1196		CSK154	DRC239				CT013SP
TRX 420 TE Fourtrax Rancher ES	07-13	CK1196		CSK155	DRC238				CT013SP
TRX 420 TE1 Rancher ES	13-15	CK1196		CSK155	DRC238				CT013SP
TRX 420 FP/FPA Fourtrax Rancher 4x4 ES/EPS	09-13	CK1196		CSK155	DRC238				CT013SP
TRX 420 FE/FEA Fourtrax Rancher 4x4/ES	07-13	CK1196		CSK155	DRC238				CT013SP
TRX 420 FE1 Rancher 4x4/ES	14-15	CK1196		CSK155	DRC238				CT013SP
TRX 420 FM/FMA Fourtrax Rancher 4x4	07-13	CK1154		CSK154	DRC239				CT013SP
TRX 420 FM1 Rancher 4x4	14-15	CK1196		CSK154	DRC239				CT013SP
TRX 420 FM2 Rancher 4x4 With Power Steering	14-15	CK1196		CSK154	DRC239				CT013SP
TRX 420 FPM/FPMA Fourtrax 4WD	09-13	CK1154		CSK154	DRC239				CT013SP
CB 450 K		CK1130		N/A					CT031
CB 450 T Hawk	82	CK1140		CSK47					CT013SP
CB 450 SC Nighthawk	82-86	CK1140		TBA					CT013SP
CB 450 DX-K	89-92	CK1140		CSK47					CT013SP
CM 450 E	82/83	CK1140		CSK15					CT013SP

CLUTCH APPLICATIONS

EBC BRAKES CLUTCH KITS



HONDA



		CK cork OEM style Kit #	CKF carbon fiber style upgrade Kit #	CSK Spring Kit #	DRC Series Kit #	DRCF Series Kit #	SRC Series Kit #	SRK Series Kit #	CT Tool #
CM 450 C Custom	82	CK1140		CSK15					CT013SP
CMX 450 C Rebel	86-87	CK1140		TBA					CT013SP
CR 450 R	81	CK1131		CSK41					CT009
CRF 450 R (6 Spring type)	02-03	CK1247	CKF1247	CSK178	DRC112				CT009
CRF 450 R (6 Spring type)	04-05	CK1247	CKF1247	CSK120	DRC148	DRCF148			CT009
CRF 450 R (6 Spring type)	06-08	CK1247	CKF1247	CSK178	DRC112				CT009
CRF 450 R (4 Spring type)	09-10	CK1247	CKF1247	CSK157	DRC244	DRCF244			CT009
CRF 450 R (4 Spring type)	11-12	CK3433	CKF3433	CSK174	DRC259	DRCF259			CT009
CRF 450 R (6 Spring type)	13	CK3433	CKF3433	CSK201	DRC276	DRCF276			CT009
CRF 450 R (6 Spring type)	14-17	CK3433	CKF3433	CSK227	DRC301	DRCF301			CT009
CRF 450 R (6 Spring type)	17-21	CK1317	CKF1317	CSK227	DRC299	DRCF299			CT092
CRF 450 R 8 Plate kit	22	TBA	TBA	TBA	TBA	TBA			TBA
CRF 450 R-S 7 Plate kit	22	TBA	TBA	TBA	TBA	TBA			TBA
CRF 450 RX (18" Rear wheel)	17-19	CK1317	CKF1317	CSK227	DRC299	DRCF299			CT092
CRF 450 X	05-17	CK1247	CKF1247	CSK120	DRC148	DRCF148			CT009
CRF 450 X	18-21	CK1317	CKF1317	CSK227	DRC299	DRCF299			CT092
CRF 450 L	18-21	CK1317	CKF1317	CSK227	DRC299	DRCF299			CT092
TRX 450 ES	98-01	CK1196		CSK23	DRC6				CT013SP
TRX 450 R/ER	04-14	CK1302	CKF1302	CSK178	DRC131	DRCF131			CT009
TRX 450 S	98-01	CK1196		CSK23	DRC6				CT013SP
TRX 450 FE	02-04	CK1196		CSK23	DRC6				CT013SP
TRX 450 FM	02-04	CK1196		CSK23	DRC6				CT013SP
CR 480 R	82	CK1170	CKF1170	CSK24					CT009
CR 480 R	83	CK1170	CKF1170	CSK28	DRC3				CT009
CB 500 K	71-73	CK1135		CSK82					CT009
CB 500 F (Non ABS)	13-21	CK1323		CSK33					
CB 500 FA (ABS)	13-21	CK1323		CSK33					
CB 500 X (Non ABS)	13-21	CK1323		CSK33					
CB 500 XA (ABS)	13-21	CK1323		CSK33					
CBR 500 R (Non ABS)	13-21	CK1323		CSK33					
CBR 500 RA (ABS)	13-21	CK1323		CSK33					
CR 500 R	84-89	CK1170	CKF1170	CSK28	DRC3				CT009
CR 500 R	90-94	CK1247	CKF1247	CSK28	DRC75				CT009
CR 500 R	95-01	CK1247	CKF1247	CSK28	DRC75				CT009
CX 500 C/D Custom/Deluxe	79-82	CK1146		CSK41					
CX 500 TC Turbo	82	CK1159		CSK167					
SXS 500 M2 Pioneer	15	CK1140		TBA					
FT 500 Ascot	82-83	CK1140		CSK248					CT013SP
GB 500	89-90	CK1219		CSK16					CT009
GL 500/500 I Silverwing/Silverwing Interstate	81-82	CK1146		CSK41					
TRX 500 FE/FEA Fourtrax Foreman 4x4/ES	05-11	CK1154		CSK117	DRC236				CT013SP
TRX 500 FE Fourtrax Foreman 4x4	12-13	CK1154		CSK29	DRC270				CT013SP
TRX 500 FM/FMA Fourtrax Foreman 4x4	05-11	CK1154		CSK153	DRC237				CT013SP
TRX 500 FM Fourtrax Foreman 4x4	12-13	CK1154		CSK79	DRC271				CT013SP
TRX 500 FPE Fourtrax Foreman 4x4 ES/EPS	08-11	CK1154		CSK117	DRC236				CT013SP
TRX 500 FPE Fourtrax Foreman 4x4	12-13	CK1154		CSK29	DRC270				CT013SP
TRX 500 FPM Fourtrax Foreman 4x4 EPS	08-11	CK1154		CSK153	DRC237				CT013SP
TRX 500 FPM Fourtrax Foreman 4x4	12-13	CK1154		CSK79	DRC271				CT013SP
TRX 500 TM Fourtrax Foreman 2x4	05-06	CK1154		CSK153	DRC237				CT013SP
VT 500 C Shadow	83-86	CK1160		N/A					CT013SP
VT 500 FT Ascot	83-84	CK1160		N/A					CT013SP
VF 500 CV 30 Magna	84-85	CK1177		CSK9					CT002
VF 500 F Interceptor	84-86	CK1177		CSK9					CT002
XL 500 S	79-81	CK1140		CSK248					CT013SP
XL 500 R	82	CK1140		CSK248					CT013SP
XR 500	79-80	CK1154		CSK248					CT013SP
XR 500 R	81-82	CK1154		CSK248					CT013SP

CLUTCH APPLICATIONS

Part numbers, prefixes, suffixes, photos and illustrations shown in this catalog are trademarks and/or copyrights of EBC Brakes or the trademark owner A C Freeman Investments Ltd and use without express written permission of the owners is punishable by law.

EBC BRAKES CLUTCH KITS



HONDA



		CK cork OEM style Kit #	CKF carbon fiber style upgrade Kit #	CSK Spring Kit #	DRC Series Kit #	DRCF Series Kit #	SRC Series Kit #	SRK Series Kit #	CT Tool #
XR 500 R	83-84	CK1170	CKF1170	CSK248					CT009
CB 550 F/K	75-78	CK1146		CSK9					
CB 550 K/K1	74-75	CK1147		CSK9					
CB 550 SC Nighthawk	83	CK1171		CSK167					CT009
599 (CB 600 F)	04-06	CK1206		CSK45			SRC19	SRK19	CT014SP
CBR 600 F Hurricane	87	CK1228		CSK12			SRC16	SRK16	CT009SP
CBR 600 F1	88-89	CK1228		CSK12			SRC16	SRK16	CT009SP
CBR 600 F1	90	CK1228		CSK47			SRC42	SRK42	CT009SP
CBR 600 F2	91-94	CK1206		CSK45			SRC19	SRK19	CT014SP
CBR 600 F3/SJR/SE	95-98	CK1206		CSK45			SRC19	SRK19	CT014SP
CBR 600 F4 (Carb Model)	99-00	CK1193	CKF1193	CSK29			SRC66	SRK66	CT014
CBR 600 F4i Sport Injection Model)	01-06	CK1218	CKF1218	CSK178			SRC143	SRK143	CT014
CBR 600 RR	03-20	CK1218	CKF1218	CSK101			SRC75	SRK75	CT014
CBR 600 RRA ABS Model	09-20	CK1218	CKF1218	CSK101			SRC75	SRK75	CT014
VT 600 C Shadow VLX	88	CK1181		CSK33					CT013SP
VT 600 C Shadow VLX	89-90	CK1230		CSK28					CT013SP
VT 600 C/CD Shadow VLX/Shadow Deluxe CD2	91-07	CK1181		CSK33					CT013SP
XL 600 V	89-90	CK1181		CSK33	DRC53				CT013SP
XL 600 R	83-84	CK1170	CKF1170	CSK15	DRC92				CT009
XL 600 R to 520822	85	CK1170	CKF1170	CSK15	DRC92				CT009
XL 600 R from 5208023	85	CK1170	CKF1170	CSK15	DRC92				CT009
XL 600 R	86-87	CK1170	CKF1170	CSK15	DRC92				CT009
XR 600 R	85-00	CK1170	CKF1170	CSK16	DRC54	DRCF54			CT009
CB 650	79-82	CK1147		CSK167					
CB 650 C Custom	80-81	CK1147		CSK167					
CB 650 SC Nighthawk	82	CK1147		CSK167					
CB 650 SC Nighthawk	83-85	CK1171		CSK167					CT009
CBR 650 F (Non ABS Model)	14-21	CK1181		CSK246			SRC149	SRK149	CT014
CBR 650 FA (ABS Model)	14-21	CK1181		CSK246			SRC149	SRK149	CT014
CX 650 C Custom	83	CK1147		CSK12					
CX 650 T Turbo	83	CK1159		CSK167					
GL 650/650 I Silverwing/Silverwing Interstate	83	CK1147		CSK12					
NT 650 Hawk GT	88-90	CK1230		CSK28			SRC64	SRK64	CT013SP
NX 650	88-89	CK1170	CKF1170	CSK16	DRC54	DRCF54			CT009
XR 650 L	93-15	CK1170	CKF1170	CSK16	DRC54	DRCF54			CT009
XR 650 R	00-07	CK1295		CSK45	DRC179				
CB 700 SC/S Nighthawk	84-86	CK1166		CSK167					CT031
CTX 700 (Top Fairing/Manual Clutch Model)	14	CK1230		CSK33			SRC62	SRK62	CT013SP
CTX 700 N (Naked/ Manual Clutch Model)	14	CK1230		CSK33			SRC62	SRK62	CT013SP
NC 700 X (Manual Clutch Model)	12-17	CK1230		CSK33			SRC62	SRK62	CT013SP
NT 700 V/A	10-13	CK1230		CSK33			SRC62	SRK62	CT013SP
TRX 700 XX	08-11	CK1302	CKF1302	CSK178	DRC240	DRCF240			CT009
VF 700 C Magna	84-87	CK1166		CSK167					CT031
VF 700 F Interceptor	84-85	CK1167		CSK900			SRC2	SRK2	CT031
VFR 700 F Interceptor	86-87	CK1206		CSK28			SRC3	SRK3	CT014
VF 700 S Sabre	84-85	CK1166		CSK167					CT031
VT 700 C Shadow	84-87	CK1166		N/A					CT031
CB 750 C Custom	80-82	CK1149		CSK41					CT078SP
CB 750 F Supersport	76	CK1145		CSK82					CT076SP
CB 750 F Supersport	79-82	CK1149		CSK41					CT078SP
CB 750 K	71-75	CK1133		CSK82					CT076SP
CB 750 K	77-78	CK1145		CSK82					CT076SP
CB 750 K	79-82	CK1149		CSK41					CT078SP
CB 750 L Limited Edition	79	CK1149		CSK9					CT078SP
CB 750 SC Nighthawk	82-83	CK1149		CSK41					CT078SP
CB 750 Nighthawk	91-03	CK1265		CSK12					CT009SP
NC 750 S	14-15	CK1230		CSK33			SRC62	SRK62	CT013SP

CLUTCH APPLICATIONS

EBC BRAKES CLUTCH KITS



HONDA



		CK cork OEM style Kit #	CKF carbon fiber style upgrade Kit #	CSK Spring Kit #	DRC Series Kit #	DRCF Series Kit #	SRC Series Kit #	SRK Series Kit #	CT Tool #
NC 750 S (ABS)	14-18	CK1230		CSK33			SRC62	SRK62	CT013SP
NC 750 X	14-15	CK1230		CSK33			SRC62	SRK62	CT013SP
NC 750 X (ABS)	14-18	CK1230		CSK33			SRC62	SRK62	CT013SP
VF 750 C V45 Magna	82-88	CK1166		CSK167					CT031
VF 750 F V45 Interceptor	83-84	CK1167		CSK900			SRC2	SRK2	CT031
VF 750 C Magna/CD Magna Deluxe	94-03	CK1206		CSK28			SRC3	SRK3	CT014
RVF 750 R (RC 45)	94	CK1257		N/A					CT031
VFR 750 F Interceptor 750	86	CK1206		CSK28			SRC3	SRK3	CT014
VFR 750 F	90-97	CK1206		CSK28			SRC3	SRK3	CT014
VFR 750 R (RC 30)	90	CK1229		CSK901			SRC5	SRK5	CT014
VF 750 S V45 Sabre	82	CK1166		CSK167					CT031
VF 750 S V45 Sabre	83	CK1166		N/A					CT031
VT 750 C Shadow	83	CK1166		N/A					CT031
VT 750 C/CD Shadow/Shadow Deluxe	98-02	CK1230		CSK28					CT013SP
VT 750 Shadow Aero	04-07	CK1230		CSK28					CT013SP
VT 750 Shadow Aero	08-14	CK1230		CSK28					CT013SP
VT 750 CSE Shadow Aero	13-14	CK1230		CSK28					CT013SP
VT 750 C2 Shadow Spirit	08-14	CK1230		CSK28					CT013SP
VT 750 DC Shadow Spirit	01-02	CK1230		CSK28					CT013SP
VT 750 C2S Shadow Spirit	13-14	CK1230		CSK28					CT013SP
VT 750 DC Shadow Spirit	03-07	CK1230		CSK28					CT013SP
VT 750 CD Shadow American Classic Edition	02-03	CK1230		CSK28					CT013SP
VT 750 C2B Shadow Phantom	10-15	CK1230		CSK28					CT013SP
VT 750 RS Shadow	10-14	CK1230		CSK28					CT013SP
VT 800 Shadow	88	CK1166		CSK24					CT031
VFR 800 FI	98-99	CK1206		CSK135					CT014
VFR 800 FI	00-01	CK1253		CSK101					CT014
VFR 800 Interceptor/ABS	02-11	CK1218	CKF1218	CSK101			SRC75	SRK75	CT014
VFR 800 F Interceptor	14-15	CK1218	CKF1218	CSK101			SRC75	SRK75	CT014
VFR 800 FD Interceptor DLX	14-15	CK1218	CKF1218	CSK101			SRC75	SRK75	CT014
PC 800 Pacific Coast	89-90/94-98	CK1167		CSK30					CT009
CB 900 C Custom	80-82	CK1149		CSK167					CT078SP
CB 900 F Supersport	81-82	CK1149		CSK167					CT078SP
CBR 900 RR	96-97	CK1206		CSK247			SRC94	SRK94	CT014
CBR 900 RR	96-97	CK1284		CSK45			SRC55	SRK55	CT014
CBR 900 RR	98-99	CK1218	CKF1218	CSK45			SRC57	SRK57	CT014
919 (CB 900 F)	02-07	CK1218	CKF1218	CSK45			SRC57	SRK57	CT014
CBR 929 RR (929cc model)	00-01	CK1206		CSK45			SRC19	SRK100	CT014
CBR 954 RR	02-03	CK1206		CSK45			SRC19	SRK100	CT014
CBX	79	CK1183		CSK167					CT066SP
CBX	80-82	CK1183		CSK10					CT066SP
RVT 1000 R (RC51)	00-01	CK1291		CSK43					CT021
RVT 1000 (RC51)	02-06	CK1300		CSK43					CT021
VTR 1000 F Superhawk	98-05	CK1290		CSK206			SRC60	SRK60	CT009
CB 1000 C Custom	83	CK1149		CSK207					CT078SP
CB 1000	94-95	CK1248		CSK29			SRC4	SRK4	CT009
CB 1000 R	11-14	CK1303		CSK90					CT009SP
CBF 1000 A8 (Canada)	08	CK1303		CSK90					
CBR 1000 F Hurricane	87-88	CK1248		CSK29			SRC4	SRK4	CT009
CBR 1000 F	90-96	CK1248		CSK29			SRC4	SRK4	CT009
CBR 1000 RR (Coil Spring Type Clutch)	04-07	CK1303		CSK112			SRC80	SRK80	CT009SP
CBR 1000 RR (Diaphragm Type Clutch)	08-16	CK1312		CSK905			SRC95	SRK95	CT043SP
CBR 1000 RAA ABS Model (Diaphragm Type Clutch)	09-16	CK1312		CSK905			SRC95	SRK95	CT043SP
CBR 1000 RR SP	14-15	CK1312		CSK905			SRC95	SRK95	CT043SP
CBR 1000 RR Fireblade	17-19								
CRF 1000 L Africa Twin (Manual clutch/Non ABS)	16	CK1319	CKF1319	CSK254	DRC306	DRCF306			CT009
CRF 1000 LAG Africa Twin (Manual clutch/ABS)	16-20	CK1319	CKF1319	CSK254	DRC306	DRCF306			CT009

CLUTCH APPLICATIONS

EBC BRAKES CLUTCH KITS



HONDA



		CK cork OEM style Kit #	CKF carbon fiber style upgrade Kit #	CSK Spring Kit #	DRC Series Kit #	DRCF Series Kit #	SRC Series Kit #	SRK Series Kit #	CT Tool #
GL 1000 K Goldwing (Up to Eng No 1020727)	75	CK1143		CSK167					CT076SP
GL 1000 K Goldwing (From Eng No 1020728)	75	CK1221		CSK167					CT053SP
GL 1000 Goldwing All models	76-79	CK1143		CSK167					CT076SP
VF 1000 F Interceptor	84	CK1176		N/A					CT031
VF 1000 R	85-86	CK1176		N/A					CT031
XL 1000 VA8 Varadero (Canada)	08	CK1257		CSK138					CT009
CB 1100 F Supersport	83	CK1149		CSK207					CT078SP
CB 1100 (Non ABS)	13-14	CK1257		CSK43					CT009
CB 1100 (ABS)	13-14	CK1257		CSK43					CT009
CB 1100 EX	16-19	CK1332		CSK70			SRC161	SRK161	
CBR 1100 XX Blackbird	97-98	CK1286		CSK70					CT021
CBR 1100 XX Blackbird	99-03	CK1291		CSK43					CT021
GL 1100/1100 I Goldwing/Goldwing Interstate	80-83	CK1159		CSK167					CT053SP
GL 1100 A Goldwing Aspencade	82-83	CK1159		CSK167					CT053SP
ST 1100/1100A	91-01	CK1264		CSK33			SRC70	SRK70	CT056SP
VF 1100 C V65 Magna	83-86	CK4409		N/A					
VF 1100 S V65 Sabre	84-85	CK4409		N/A					
VT 1100 C Shadow 1100	85-86	CK1209		N/A					CT009
VT 1100 C Shadow 1100	87-94	CK1239		N/A					CT009
VT 1100 C Shadow 1100	95-96	CK1239		N/A					CT009
VT 1100 C Shadow 1100 Spirit	97-06	CK1176		CSK68					CT009
VT 1100 CS Shadow American Classic Edition	95-97	CK1176		CSK68					CT009
VT 1100 C2-2 Shadow American Classic Edition	97	CK1176		CSK68					CT009
VT 1100 D2 Shadow American Classic Edition	99	CK1176		CSK68					CT009
VT 1100 C2 Shadow Sabre	00-06	CK1176		CSK68					CT009
VT 1100 C3 Shadow Aero	98-02	CK1176		CSK68					CT009
VT 1100 T Shadow American Classic Edition Tourer	98-01	CK1176		CSK68					CT009
GL 1200/1200 I-A/1200 L Goldwing All models	84-85	CK1210		N/A					CT053SP
GL 1200 I-A/GL 12SE-I	86	CK1224		N/A					
GL 1200 1/A Goldwing All models	87	CK1224		N/A					
VFR 1200 F (Manual Gearbox Model)	10-14	CK1312		CSK907			SRC103	SRK103	CT043SP
CTX 1300	14	TBA		TBA					
CTX 1300 DLX (ABS)	14	TBA		TBA					
ST 1300/1300 A	02-13	CK1297		CSK175					CT021
VT 1300 CX Fury (Non ABS Model)	10-15	CK1298		CSK90					TBA
VT 1300 CXA Fury (ABS Model)	10-15	CK1298		CSK90					TBA
VT 1300 CS Sabre (Non ABS)	10-14	CK1298		CSK90					TBA
VT 1300 CSA Sabre (ABS)	11-14	CK1298		CSK90					TBA
VT 1300 CT Interstate (Non ABS)	10-15	CK1298		CSK90					TBA
VT 1300 CTA Interstate (ABS)	11-15	CK1298		CSK90					TBA
VT 1300 CR Stateline (Non ABS)	10-15	CK1298		CSK90					TBA
VT 1300 CRA Stateline (ABS)	11-15	CK1298		CSK90					TBA
VTX 1300 C	04-11	CK1298		CSK90					TBA
VTX 1300 S	03-06	CK1298		CSK90					TBA
VTX 1300 R	05-11	CK1298		CSK90					TBA
VTX 1300 T	08-11	CK1298		CSK90					TBA
GL 1500 Goldwing	88-96	CK1285		N/A					CT068SP
GL 1500 A/SE/I Goldwing	99-00	CK1285		N/A					CT068SP
GL 1500 C/CT Valkyrie/Valkyrie Tourer	97-03	CK1285		N/A					CT068SP
GL 1800 A (ABS)/1800 Goldwing (All models)	01-16	CK1297		N/A					CT073
F6B Goldwing (GL 1800 B)	13-16	CK1297		N/A					CT073
F6B Goldwing Deluxe (GL 1800 BD)	13-16	CK1297		N/A					CT073
GL 1800 C Valkyrie	13-14	CK1297		N/A					CT073
NRX 1800 Rune DA/DB/EA	04-05	CK1297		N/A					CT073
VTX 1800 C	02-08	CK1298		CSK90					TBA
VTX 1800 R (Cast Models)	02-08	CK1298		CSK90					TBA
VTX 1800 S (Spoke Model)	02-07	CK1298		CSK90					TBA

CLUTCH APPLICATIONS

Part numbers, prefixes, suffixes, photos and illustrations shown in this catalog are trademarks and/or copyrights of EBC Brakes or the trademark owner A C Freeman Investments Ltd and use without express written permission of the owners is punishable by law.

EBC BRAKES CLUTCH KITS



HONDA



		CK cork OEM style Kit #	CKF carbon fiber style upgrade Kit #	CSK Spring Kit #	DRC Series Kit #	DRCF Series Kit #	SRC Series Kit #	SRK Series Kit #	CT Tool #
VTX 1800 T	07-Nov	CK1298		CSK90					TBA
VTX 1800 F	05-Nov	CK1298		CSK90					TBA
VTX 1800 N	04-Nov	CK1298		CSK90					TBA

KAWASAKI

AR 50 A	82	CK4442		CSK18					
KDX 50 A	03-Jun	CK3366		N/A					
KX 60 A	83-84	CK4438	CKF4438	CSK18					CT070SP
KX 60 B	85-03	CK4438	CKF4438	CSK18	DRC7				CT070SP
KX 65	00-21	CK4438	CKF4438	CSK40	DRC98	DRCF98			CT070SP
AR 80 A	82	CK4440		CSK18					
KD 80 M	80-81	CK4440		CSK19					
KD 80 M	82-87	CK4440		CSK19					
KD 80 N	88-90	CK4440		CSK19					
KX 80 A	80	CK4440		CSK18					
KDX 80 A	81	CK4440		CSK40					
KDX 80 B	82-83	CK4438	CKF4438	CSK40					CT070SP
KDX 80 C	84-88	CK4438	CKF4438	CSK40					CT070SP
KX 80 C	81/82	CK4438	CKF4438	CSK40					CT070SP
KX 80 E	83/84	CK4438	CKF4438	CSK40					CT070SP
KX 80 E/G/J	85-87	CK4468		CSK34	DRC8				CT070SP
KX 80 L	88	CK4477		CSK35	DRC9				
KX 80 L/N	89-90	CK4478		CSK35	DRC10				
KX 80 R	91-97	CK4478		CSK35	DRC10				
KX 80 W	98-00	CK4453	CKF4453	CSK41	DRC45	DRCF45			CT002
KX 85	01-22	CK4453	CKF4453	CSK41	DRC45	DRCF45			CT002
KE 100 A	76-81	CK4440		CSK19					
KE 100 B	85-01	CK4440		CSK19					
KM 100 A	76-81	CK4440		CSK19					
KX 100 B	95-97	CK4478		CSK35	DRC10				
KX 100 C/D/F	98-09/11-16	CK4453	CKF4453	CSK41	DRC45	DRCF45			CT002
KLF 110 A/B Mojave	87-88	CK4463		N/A					
KLT 110 A	84-86	CK4463		N/A					
KLX 110	02-21	CK4438	CKF4438	CSK40	DRC98	DRCF98			CT070SP
BN 125 A Eliminator	01-09	CK4511		CSK41					
KD 125 A	75-79	CK4411		CSK143					CT058
KE 125 A	80-83	CK4411		CSK143					CT058
KLX 125 A	03-06	CK3318	CKF3318	CSK34					CT011
KLX 125 L (B)	03-06	CK3318	CKF3318	CSK34					CT011
KX 125 A	78-81	CK4436		CSK143					CT058
KX 125 B	82	CK4436		CSK143					CT058
KX 125 B	83	CK4457		CSK152					CT058
KX 125 C	84	CK4457		CSK143					CT058
KX 125 D/E	85-87	CK4469		CSK143	DRC11				CT042
KX 125 F/G	88-89	CK4482		CSK6	DRC13				CT042
KX 125 H	90-91	CK4485		CSK116	DRC36				CT042
KX 125 J	92	CK4485		CSK116	DRC83				CT042
KX 125 J	93	CK4498		CSK116	DRC69				CT042
KX 125 K	94-96	CK4425		CSK7	DRC73				CT004
KX 125 K/L	97-02	CK4425		CSK65	DRC73				CT004
KX 125 M	03-05	CK4425		CSK97	DRC122				CT004
Z 125 (BR 125 GGF/GHF Auto G/Box)	16-17	CK4438		TBA					
Z 125 Pro (BR 125 HGF/JHF Manual G/Box)	16-22	CK4438		TBA					
KLX 140 (F 17"/R 14")	08-21	CK4522		CSK142	DRC211				
KLX 140 L (F 19"/R 16")	08-21	CK4522		CSK142	DRC211				
KLX 140 G (F 21"/R 18")	17-21	CK4522		CSK142	DRC211				
KLX 150 S	09-11	CK4522		CSK142	DRC211				

CLUTCH APPLICATIONS

EBC BRAKES CLUTCH KITS



KAWASAKI



		CK cork OEM style Kit #	CKF carbon fiber style upgrade Kit #	CSK Spring Kit #	DRC Series Kit #	DRCF Series Kit #	SRC Series Kit #	SRK Series Kit #	CT Tool #
KLT 160 A	85	CK1119		CSK3					CT012SP
KDX 175 A	80-82	CK4436		CSK143					CT058
KE 175 D	80-83	CK4411		CSK39					CT058
KLF 185 A Bayou	85-88	CK1119		CSK3					CT012SP
KLT 185 A	86-87	CK1119		CSK3					CT012SP
KDX 200 A	83-84	CK4457		CSK152					CT058
KDX 200 A	85	CK4457		CSK143					CT058
KDX 200 C	86-88	CK4469		CSK143	DRC74				CT042
KDX 200 E	89-94	CK4482		CSK10	DRC61				CT042
KDX 200 H	95-06	CK4505		CSK30	DRC62				
KLT 200 A	81-83	CK4425		CSK148					CT004
KLT 200 B	83	CK4425		CSK148					CT004
KLT 200 C	83-84	CK4425		CSK148					CT004
KDX 220 R A	97-06	CK4505		CSK30	DRC62				
KLF 220 A Bayou	88-02	CK1180		CSK116	DRC224				CT013SP
KLX 230	20	CK4514	CKF4514	CSK97	DRC123	DRCF123			CT004
EL 250 B Eliminator	88-89	CK4473		CSK4					CT016
EL 250 E 250 HS	91-95	CK4473		CSK4					CT016
EX 250 E Ninja	86-87	CK4473		CSK4					CT016
EX 250 F/D Ninja	88-07	CK4484		CSK4					CT016
EX 250 J Ninja 250 R	08-12	CK4521		CSK142					CT009
KDX 250 A/B	80-81	CK4439		CSK10					CT006
KDX 250 B	82-84	CK4433		CSK10					CT006
KDX 250 D	91-94	CK4475		CSK30	DRC41				CT006
KE 250 B	77-79	CK4439		CSK116					CT006
KH 250 A	76	CK4436		CSK1					CT058
KL 250 A	78-79	CK4425		CSK148					CT004
KL 250 A	80-82	CK4425		CSK148					CT004
KL 250 C	83-84	CK4425		CSK148					CT004
KL 250 G Super Sherpa	00-04	CK4469		CSK74					
KLF 250 A Bayou	03-11	CK1180		CSK116	DRC224				CT013SP
KLR 250 (KL 250) D	85-05	CK4446		CSK148	DRC63				CT004
KLT 250 A	82-83	CK4425		CSK148					CT004
KLT 250 C	83-85	CK4425		CSK148					CT004
KLT 250 P Police	84	CK4425		CSK148					CT004
KLX 250 A	79-80	CK4425		CSK148					CT004
KLX 250 D	93-95	CK4469		CSK1					CT042
KLX 250 S (KLX 250 H)	06-07	CK4469		CSK144	DRC212				CT042
KLX 250 S (KLX 250 T)	09-14	CK4469		CSK144	DRC212				CT042
KLX 250 SF (KLX 250 W) Supermotard	09-10	CK4469		CSK144	DRC212				CT042
KSF 250 A Mojave	87-04	CK4425		CSK148	DRC225				CT004
KX 250 A	80-81	CK4439		CSK10					CT006
KX 250 B/C	82-83	CK4433		CSK10					CT006
KX 250 C	84	CK4465		CSK10					CT006
KX 250 D	85-86	CK4459		CSK10					CT006
KX 250 E/F	87-88	CK4475		CSK10					CT006
KX 250 G	89	CK4475		CSK7	DRC15				CT006
KX 250 H	90	CK4475		CSK6	DRC17				CT006
KX 250 H	91	CK4475		CSK30	DRC41				CT006
KX 250 J/K/L/M/R	92-07	CK4435	CKF4435	CSK7	DRC46	DRCF46			CT016
KX 250 N (KX 250 F)	04-05	CK4514	CKF4514	CSK97	DRC123	DRCF123			CT004
KX 250 F (T)	06-08	CK4514	CKF4514	CSK97	DRC123	DRCF123			CT004
KX-F 250 (4T)	09-19	CK4514	CKF4514	CSK97	DRC123	DRCF123			CT004
KX-F 250 (4T)	20-22	TBA	TBA	TBA	TBA	TBA			TBA
KXF 250 A Tecate 4	87-88	CK4475		CSK10					CT006
KXT 250 A Tecate	84	CK4433		CSK148					CT006
KXT 250 A Tecate	85	CK4465		CSK148					CT006

CLUTCH APPLICATIONS

EBC BRAKES CLUTCH KITS



KAWASAKI



		CK cork OEM style Kit #	CKF carbon fiber style upgrade Kit #	CSK Spring Kit #	DRC Series Kit #	DRCF Series Kit #	SRC Series Kit #	SRK Series Kit #	CT Tool #
KXT 250 B Tecate	86-87	CK4459		CSK10	DRC38				CT006
KZ 250 D (LTD)	80	CK4425		CSK148					CT004
KZ 250 D (CSR)	81	CK4425		CSK148					CT004
KZ 250 L (CSR)	82	CK4425		CSK148					CT004
KZ 250 W (LTD)	83	CK4425		CSK148					CT004
S1-A/B/C (250cc)	73-75	CK4436		CSK1					CT058
EX 300 A (Non ABS) Ninja 300	13-19	CK4524		CSK203			SRC118	SRK118	CT009
EX 300 A (Non ABS) Ninja SE 300	14-19	CK4524		CSK203			SRC118	SRK118	CT009
EX 300 B (With ABS) Ninja 300	13-19	CK4524		CSK203			SRC118	SRK118	CT009
EX 300 B (With ABS) Ninja SE 300	14-19	CK4524		CSK203			SRC118	SRK118	CT009
KEF 300 A Lakota	95-00	CK4419		CSK151	DRC233				CT006
KEF 300 B Lakota Sport	01-03	CK4419		CSK151	DRC233				CT006
KLF 300 A/B/C Bayou	86-05	CK4419		CSK151	DRC233				CT006
KLX 300 R A	97	CK4469		CSK1					CT042
KLX 300 R A	98-07	CK4469		CSK144	DRC212				CT042
KLX 300 R	19-21	CK4469		CSK144	DRC212				CT042
Versys-X 300 ABS	17-21	CK4524		CSK203			SRC118	SRK118	CT009
EX 305 B (GPz)	83	CK4433		CSK6					CT006
KZ 305 A (CSR)	81-82	CK4433		CSK6					CT006
KZ 305 B (CSR)	82	CK4433		CSK6					CT006
KZ 305 B (LTD)	87-88	CK4433		CSK6					CT006
S2/S2-A (350cc)	72-73	CK4436		CSK192					CT058
KDX 400 A	79-80	CK4439		CSK10					CT006
KH 400 A	76-78	CK4457		CSK192					CT058
KLF 400 B Bayou (4 x 4)	93-98	CK4439		CSK151	DRC234				CT006
KLX 400 R (KLX 400 B)	03-04	CK3433	CKF3433	CSK79	DRC105	DRCF105			CT006
KLX 400 SR (KLX 400 A)	03-04	CK3433	CKF3433	CSK79	DRC105	DRCF105			CT006
KSF 400 A (KFX 400)	03-04	CK3433	CKF3433	CSK79	DRC105	DRCF105			CT006
KSF 400 A (KFX 400)	05-06	CK3447	CKF3447	CSK79	DRC137	DRCF137			CT006
S3/S3-A (400cc)	74-75	CK4457		CSK192					CT058
KZ 400 S Series	75-77	CK4421		CSK7					CT006
KDX 420 B	81	CK4439		CSK10					CT006
Ninja 400	17-21	CK4530		CSK264			SRC167	SRK167	
Z 400	17-21	CK4530		CSK264			SRC167	SRK167	
KX 420 A	80-81	CK4439		CSK10					CT006
KZ 440 A	80-83	CK4421		CSK4					
KZ 440 B	80-81	CK4421		CSK4					
KZ 440 D	80-83	CK4421		CSK4					
KZ 440 G	82	CK4421		CSK4					
EN 450 A (454 LTD)	85-90	CK4424		CSK10			SRC22	SRK22	CT016
KDX 450 A	82	CK4439		CSK10					CT006
KFX 450 R (KSF 450 B8)	08-14	CK4519		CSK177	DRC185				CT006
KLX 450 R A	08-12	CK1247	CKF1247	CSK180	DRC158	DRCF158			CT006
KX 450 F D/E	06-11	CK1247	CKF1247	CSK180	DRC158	DRCF158			CT006
KX-F 450 (4T)	12-19	CK1247	CKF1247	CSK29	DRC269	DRCF269			CT006
KX-F 450 (4T)	19-21	CK4531	TBA	TBA	TBA	TBA			TBA
EN 500 A/C	90-09	CK4424		CSK10			SRC22	SRK22	CT016
EX 500 A/D	87-09	CK4424		CSK10			SRC22	SRK22	CT016
HI 500 Mach III	69-70	CK4425		CSK194					CT004
HI-A 500 S Mach III	71	CK4425		CSK194					CT004
HI-B 500 Mach III	72	CK4425		CSK194					CT004
HI-C 500 Mach III	72	CK4425		CSK194					CT004
HI-D 500	73	CK4425		CSK194					CT004
HI-E 500	74	CK4425		CSK194					CT004
HI-F 500	75	CK4425		CSK194					CT004
KH 500 A8		CK4425		CSK194					CT004
KX 500 A	83/84	CK4433		CSK10					CT006

CLUTCH APPLICATIONS

EBC BRAKES CLUTCH KITS



KAWASAKI



		CK cork OEM style Kit #	CKF carbon fiber style upgrade Kit #	CSK Spring Kit #	DRC Series Kit #	DRCF Series Kit #	SRC Series Kit #	SRK Series Kit #	CT Tool #
KX 500 B	85-86	CK4459		CSK10					CT006
KX 500 C/D	87-88	CK4475		CSK10	DRC16				CT006
KX 500 E	89-04	CK4475		CSK10	DRC16				CT006
KZ 550 A	80-83	CK4424		CSK10			SRC22	SRK11	CT016
KZ 550 C (LTD)	80-83	CK4424		CSK10			SRC22	SRK11	CT016
KZ 550 D (GPz)	81	CK4424		CSK10			SRC22	SRK11	CT016
KZ 550 F Spectre	83	CK4424		CSK10			SRC22	SRK11	CT016
KZ 550 F (LTD)	84	CK4424		CSK10			SRC22	SRK11	CT016
KZ 550 H (GPz)	82-83	CK4424		CSK10			SRC22	SRK11	CT016
KZ 550 M (LTD)	83	CK4424		CSK10			SRC22	SRK11	CT016
ZX 550 A (GPz)	84-86	CK4424		CSK10			SRC22	SRK11	CT016
ZR 550 B Zephyr	90-93	CK4424		CSK10			SRC22	SRK11	CT016
KLR 600 (KL 600 A/B)	84-86	CK4424		CSK23	DRC64				CT016
ZL 600 A	86-87	CK4424		CSK10			SRC22		CT016
ZL 600 Eliminator B	96-97	CK4424		CSK10					CT016
ZX 600 A/B Ninja	85-87	CK4424		CSK23					CT016
ZX 600 C Ninja R	88-89	CK4424		CSK10			SRC22	SRK11	CT016
ZX 600 C Ninja R	90-97	CK4424		CSK10			SRC22	SRK44	CT016
ZX 600 D (ZX6)	90-93	CK4424		CSK10			SRC22	SRK22	CT016
ZX 600 E (ZX6)	93-05	CK4424		CSK43			SRC43	SRK43	CT016
ZX6R (ZX 600 F/G)	95-99	CK4503		CSK56			SRC38	SRK108	CT004
ZX6R (ZX 600 J)	00-02	CK4503		CSK56			SRC38	SRK38	CT004
ZX6R (ZX 636 A)	02	CK4503		CSK56			SRC38	SRK38	CT004
ZX6R (ZX 636 B) 636cc	03-04	CK4503		CSK56			SRC38	SRK38	CT004
ZX6R (ZX 636 C) 636cc	05-06	CK4514	CKF4514	CSK117			SRC84	SRK84	CT004
ZX6R (ZX 600 P/R)	07-12	CK4514	CKF4514	CSK165			SRC101	SRK101	CT004
ZX6R (ZX 636 E) 636cc/Non ABS	13-19	CK4514		CSK202					CT004
ZX6R (ZX 636 E) 636cc/Non ABS/30th Anniversary Edition	15	CK4514		CSK202					CT004
ZX6R (ZX 636 E) 636cc/Non ABS/KRT Edition	16-19	CK4514		CSK202					CT004
ZX6R (ZX 636 F) 636cc/ABS	13-19	CK4514		CSK202					CT004
ZX6R (ZX 636 F) 636cc/ABS/30th Anniversary Edition ABS	15	CK4514		CSK202					CT004
ZX6R (ZX 636 F) 636cc/ABS/KRT Edition	16-19	CK4514		CSK202					CT004
ZX6RR (ZX 600 K) 599cc	03	CK4503		CSK99			SRC76	SRK76	CT004
ZX6RR (ZX 600 M)	04	CK4514	CKF4514	CSK99			SRC83	SRK83	CT004
ZX6RR (ZX 600 N) 599cc	05-06	CK4514	CKF4514	CSK117				SRK107	CT004
ZZR 600 (ZX 600 J)	05	CK4503		CSK56			SRC38	SRK38	CT004
ZZR 600 J	06-08	CK4503		CSK56			SRC38	SRK38	CT004
EN 650 Vulcan S (Non ABS) EN 650 A	15	CK4424		CSK10			SRC22	SRK22	CT016
EN 650 Vulcan S (ABS) EN 650 B	15	CK4424		CSK10			SRC22	SRK22	CT016
ER6-n (ER 650 C)	09-10	CK4424		CSK10			SRC22	SRK22	CT016
ER-6F (EX 650)	06-11	CK4424	CKF4424	CSK10			SRC22	SRK102	CT016
ER-6F ABS (EX 650 ABS)	06-11	CK4424	CKF4424	CSK10			SRC22	SRK102	CT016
Ninja 650 (EX 650)	12-18	CK4527					SRC155	SRK155	
Ninja 650 ABS (EX 650 ABS)	12-18	CK4527					SRC155	SRK155	
ER-6N (ER 650)	06-11	CK4424	CKF4424	CSK10			SRC22	SRK102	CT016
ER-6N ABS (ER 650 ABS)	06-11	CK4424	CKF4424	CSK10			SRC22	SRK102	CT016
Z 650 (ER 650)	12-18	CK4527					SRC155	SRK155	
Z 650 ABS (ER 650 ABS)	12-18	CK4527					SRC155	SRK155	
KL 650 B Tengai	90-91	CK4424		CSK7	DRC65				CT016
KL 650 E Up To KL650AEA72319 = 8 Friction Plates (KLR 650)	08-11	CK4435	CKF4435	CSK224	DRC168				CT016
KL 650 E From KL650AEA72320 = 7 Friction Plates (KLR 650)	11-15	CK4424		CSK10					CT016
KLE 650 A/C/D Versys	07-14	CK4424		CSK10			SRC22		CT016
KLE 650 F Versys/Versys LT	15-16	CK4424		CSK10					CT016
KLR 650 (KL 650 A)	87-95	CK4424		CSK7	DRC65				CT016
KLR 650 (KL 650 A)	96-07	CK4435	CKF4435	CSK224	DRC168				CT016
KLX 650 A/D (KLX 650 R)	93-96	CK4424		CSK10	DRC64				CT016
KLX 650 C	93-96	CK4424		CSK7	DRC65				CT016

CLUTCH APPLICATIONS

EBC BRAKES CLUTCH KITS



KAWASAKI



		CK cork OEM style Kit #	CKF carbon fiber style upgrade Kit #	CSK Spring Kit #	DRC Series Kit #	DRCF Series Kit #	SRC Series Kit #	SRK Series Kit #	CT Tool #
KZ 650 B	77-79	CK4413		CSK10					CT019
KZ 650 C Custom	77-79	CK4413		CSK10					CT019
KZ 650 D SR	78-79	CK4413		CSK10					CT019
KZ 650 E (LTD)	80	CK4413		CSK10					CT019
KZ 650 F	80	CK4413		CSK10					CT019
KZ 650 H (CSR)	81-83	CK4413		CSK10					CT019
W 650 (EJ 650 A)	00-02	CK4435	CKF4435	CSK10			SRC46	SRK46	CT016
KZ 700 A	84	CK4413		CSK10					CT019
VN 700 A Vulcan	85	CK4435	CKF4435	CSK10			SRC46	SRK46	CT016
ZN 700 A (LTD)	84-85	CK4413		CSK10					CT019
H1/H2-A Mach IV (750-2T)	72-73	CK4415		CSK23					CT004
H2-B/H2-C Mach IV (750-2T)	74-75	CK4523		CSK23					CT004
KZ 750 E	80-82	CK4413		CSK10					CT016
KZ 750 F (LTD)	83	CK4413		CSK10					CT019
KZ 750 G (LTD)	80	CK4435		CSK10			SRC46	SRK46	CT016
KZ 750 H (LTD)	80-83	CK4413		CSK10					CT019
KZ 750 K (LTD)	83-84	CK4435	CKF4435	CSK10					CT016
KZ 750 L	83	CK4413		CSK10					CT019
KZ 750 M (CSR)	82	CK4435	CKF4435	CSK10			SRC46	SRK46	CT016
KZ 750 N Spectre	82-83	CK4413		CSK10					CT019
KZ 750 R (GPz)	82	CK4413		CSK10					CT019
VN 750 A Vulcan	86-06	CK4435	CKF4435	CSK10			SRC46	SRK46	CT016
ZX 750 A (GPz)	83-85	CK4413		CSK10					CT019
ZX 750 E (GPz Turbo)	84-85	CK4443		CSK10					CT019
ZX 750 F Ninja	87-90	CK4435	CKF4435	CSK7			SRC53	SRK53	CT016
ZX 750 H Ninja ZX-7	89-90	CK4424		CSK23					CT016
ZX 750 K	91-92	CK4435	CKF4435	CSK88			SRC24	SRK24	CT016
ZX 750 J	91-92	CK4435	CKF4435	CSK88			SRC24	SRK24	CT016
ZX 750 L (ZX-7)	93-95	CK4435	CKF4435	CSK88			SRC24	SRK24	CT016
ZX 750 M (ZX-7R)	93-94	CK4435	CKF4435	CSK88			SRC24	SRK24	CT016
ZX 750 P (ZX 7 R)	96-03	CK4435	CKF4435	CSK88			SRC24	SRK24	CT016
ZX 750 N (ZX 7 RR)	96-99	CK4435	CKF4435	CSK38			SRC41	SRK41	CT016
ZR 750 C Zephyr	91-93	CK4493		CSK10					CT019
ZR 750 F (ZR-7)	00-01	CK4493		CSK117					CT019
Z 750 S (ZR 750 K)	05-06	CK4503		CSK56			SRC38	SRK38	CT004
ZR7-S (ZR 750 H)	01-05	CK4493		CSK117					CT019
VN 800 A/B	95-05	CK4435	CKF4435	CSK10			SRC46	SRK46	CT016
VN 800 Drifter C/E	99-06	CK4435	CKF4435	CSK7			SRC53	SRK53	CT016
VN 900 Vulcan Classic LT (Spoke Wheels & Screen) (D)	06-19	CK4435	CKF4435	CSK7			SRC53	SRK53	CT016
VN 900 Vulcan Classic (Spoke Wheels) (B)	06-19	CK4435	CKF4435	CSK7			SRC53	SRK53	CT016
VN 900 Vulcan Custom (Cast Wheels) (C)	07-19	CK4435	CKF4435	CSK7			SRC53	SRK53	CT016
Z1/A/B 900	73-75	CK4409		CSK10					CT019
KZ 900 A	76-77	CK4409		CSK10					CT019
KZ 900 B LTD	76	CK4409		CSK10					CT019
Z 900 (ZR 900 A)	17-21	CK4510		CSK169					CT004
Z 900 ABS (ZR 900 B)	17-21	CK4510		CSK169					CT004
Z 900 RS (ZR 900 C)	18-21	CK4510		CSK169					CT004
Z 900 RS Café (ZR 900 E)	18-21	CK4510		CSK169					CT004
ZL 900 A Eliminator	85-86	CK4434		CSK23			SRC20	SRK20	CT016
ZX 900 A Ninja	84-86	CK4435	CKF4435	CSK7			SRC53	SRK53	CT016
ZX9R B Ninja	94-97	CK4435	CKF4435	CSK38			SRC41	SRK41	CT016
ZX9R (ZX 900 C)	98-99	CK4510		CSK67			SRC59	SRK59	CT004
ZX9R (ZX 900 E/F)	00-03	CK4510		CSK128			SRC89	SRK89	CT004
KLZ 1000 B Versys	15-19	CK4503		TBA					CT004
KZ 1000 A	77-80	CK4409		CSK10					CT019
KZ 1000 B (LTD)	79-80	CK4409		CSK10					CT019
KZ 1000 C Police	78-81	CK4409		CSK10					CT019

CLUTCH APPLICATIONS

Part numbers, prefixes, suffixes, photos and illustrations shown in this catalog are trademarks and/or copyrights of EBC Brakes or the trademark owner A C Freeman Investments Ltd and use without express written permission of the owners is punishable by law.

EBC BRAKES CLUTCH KITS



KAWASAKI



		CK cork OEM style Kit #	CKF carbon fiber style upgrade Kit #	CSK Spring Kit #	DRC Series Kit #	DRCF Series Kit #	SRC Series Kit #	SRK Series Kit #	CT Tool #
KZ 1000 D (Z1-R)	78-80	CK4409		CSK10					CT019
KZ 1000 E Shaft	79-80	CK4434		CSK23			SRC20	SRK20	CT016
KZ 1000 G Classic	80	CK4409		CSK10					CT019
KZ 1000 J	81-83	CK4434		CSK10			SRC54	SRK54	CT016
KZ 1000 K (LTD)	81-82	CK4434		CSK10			SRC54	SRK54	CT016
KZ 1000 M (CSR)	81-82	CK4434		CSK10			SRC54	SRK54	CT016
KZ 1000 P Police	82-03/05	CK4434		CSK10			SRC54	SRK54	CT016
KZ 1000 R Replica	82-83	CK4434		CSK10			SRC54	SRK54	CT016
Z 1000 (ZR 1000 A)	03-05	CK4510		CSK128			SRC89	SRK89	CT004
Z 1000 (ZR 1000 A)	06	CK4510		CSK128			SRC89	SRK89	CT004
Z 1000 (ZR 1000 B)	07-08	CK4510		CSK110					CT004
Z 1000 (ZR 1000 C)	07	CK4510		CSK110					CT004
Z 1000 (ZR 1000 D) Non ABS	10-13	CK4510		CSK169					CT004
Z 1000 ABS (ZR 1000 D) ABS	14-15	CK4510		CSK169					CT004
Z 1000 ABS (ZR 1000 G) ABS/3 Spring Clutch	16	CK4503		TBA					CT004
Z 1000 Performance	16-19	CK4510		CSK169					CT004
Z 1000 SX Tourer	16-19	CK4510		CSK169					CT004
ZG 1000 A Concours	86-05	CK4434		CSK23			SRC20	SRK20	CT016
ZG 1000 A Concours	6	CK4434		CSK23			SRC20	SRK20	CT016
ZL 1000 A	87	CK4434		CSK23			SRC20	SRK20	CT016
ZX 1000 A Ninja	86-87	CK4434		CSK23			SRC20	SRK20	CT016
ZX 1000 B Ninja ZX10	88-90	CK4434		CSK23			SRC20		CT016
1000 Ninja ABS (ZX 1000 H)	12-13	CK4510		CSK169					CT004
1000 Ninja (ZX 1000 G)	11-13	CK4510		CSK169					CT004
1000 Ninja ABS (ZX 1000 M)	14-15	CK4510		CSK169					CT004
Ninja H2	15-21	CK4528		CSK269			SRC163	SRK163	
Ninja H2R	15-21	CK4529		CSK270			SRC164	SRK164	
ZX10 R (ZX 1000 C)	04-05	CK4510		CSK111			SRC79	SRK79	CT004
ZX10 R (ZX 1000 D/E/F)	06-10	CK4510		CSK111			SRC79		CT004
ZX10 R (ZX 1000 J - Non ABS)	11-15	CK4510		CSK111			SRC79		CT004
ZX10 R (ZX 1000 J 30th Anniversary Edition - Non ABS)	15	CK4510		CSK111			SRC79		CT004
ZX10 R (ZX 1000 K - ABS)	11-15	CK4510		CSK111			SRC79		CT004
ZX10 R (ZX 1000 F 30th Anniversary Edition - ABS)	15	CK4510		CSK111			SRC79		CT004
ZX10 R (ZX 1000 SGF)	16	CK4510		CSK111			SRC79		CT004
ZX10 R KRT Replica (ZX 1000 SGFA)	16	CK4510		CSK111			SRC79		CT004
ZX10 R (ZX 1000 SGF)	16-19	CK4510		CSK111			SRC79		CT004
ZX10 R KRT Replica (ZX 1000 SGFA)	16-19	CK4510		CSK111			SRC79		CT004
ZX10 RR	17-21	CK4510	CKF4510	CSK111			SRC79	SRK79	CT004
ZX10 RR Performance	17-21	CK4510	CKF4510	CSK111			SRC79	SRK79	CT004
KZ 1100 A	81-83	CK4434		CSK23			SRC20	SRK20	CT016
KZ 1100 B (GPz)	81-82	CK4434		CSK23			SRC20	SRK20	CT016
KZ 1100 D Spectre	82-83	CK4434		CSK23			SRC20	SRK20	CT016
KZ 1100 L (LTD)	83	CK4434		CSK23			SRC20	SRK20	CT016
ZN 1100 B (LTD)	84-85	CK4434		CSK23			SRC20	SRK20	CT016
ZX 1100 A (GPz)	83-84	CK4434		CSK23			SRC20	SRK20	CT016
ZR 1100 A Zephyr	92-95	CK4434		CSK23			SRC20	SRK20	CT016
(ZR 1100 C) ZRX 1100	99-00	CK4434		CSK23			SRC20	SRK20	CT016
ZX 1100 C/D (ZX11)	90-01	CK4488		CSK29			SRC25	SRK25	CT021
ZX 1100 E/F GPZ 1100	95-97	CK4488		CSK29			SRC25	SRK25	CT021
ZG 1200 A/B	86-90	CK4434		CSK23			SRC20		CT016
ZG 1200 B Voyager X11	91-03	CK4434		CSK23			SRC20		CT016
ZX12 R (ZX 1200 A)	0	CK4513		CSK109					CT009
ZX12 R (ZX 1200 A/B)	01-05	CK4515		CSK67					CT009
ZRX 1200 R (ZR 1200 A)	01-05	CK4434		CSK38					CT016
ZZR 1200 (ZX 1200 C)	02-05	CK4488		CSK29			SRC25	SRK25	CT021
KZ 1300 A	79-81	CK4452		CSK10					
KZ 1300 A	82	CK4458		CSK10					

CLUTCH
APPLICATIONS

EBC BRAKES CLUTCH KITS



KAWASAKI



		CK cork OEM style Kit #	CKF carbon fiber style upgrade Kit #	CSK Spring Kit #	DRC Series Kit #	DRCF Series Kit #	SRC Series Kit #	SRK Series Kit #	CT Tool #
KZ 1300 B Touring	80	CK4452		CSK10					
ZN 1300 A Voyager	83-88	CK4455		CSK10					CT032
Concours 14 (ZG 1400 A/C/E) ABS	08-16	CK4520		CSK23					CT021
Concours 14 (ZG 1400 B/D)	08-10	CK4520		CSK23					CT021
ZX 14 R (ZX 1400 A6F/A7F)	06-07	CK4518		CSK124					CT021
ZX 14 R ABS (ZX 1400 B6F/B7F)	06-07	CK4518		CSK124					CT021
ZX 14 R ABS	08-11	CK4518		CSK124					CT021
ZX 14 R ABS	12-16	CK4518		CSK23					CT021
ZX 14 R ABS Performance	12-21	CK4518		CSK23					CT021
ZX 14 R ABS Performance Sport (ZX 1400 JGF)	14-21	CK4518		CSK23					CT021
VN 1500 A Vulcan 88	87-99	CK4455		N/A					CT032
VN 1500 B/C Vulcan 88 SE/Classic	87-99	CK4455		N/A					CT032
VN 1500 D/E Vulcan 88 SE/Classic	96-04	CK4455		N/A					CT032
VN 1500 G Nomad	99-01	CK4455		N/A					CT032
VN 1500 Drifter J/R	99-05	CK4455		N/A					CT032
VN 1500 L Vulcan 1500 Nomad F1	01-05	CK4455		N/A					CT032
VN 1500 N Vulcan 1500 Classic Fi	00-02	CK4455		N/A					CT032
VN 1500 Vulcan Mean Streak P	02-03	CK4455		N/A					CT032
VN 1500 N Vulcan 1500 Classic	05-08	CK4455		N/A					CT032
VN 1600 A Classic	03-08	CK4455		N/A					CT032
VN 1600 B Mean Streak	04	CK4455		N/A					CT032
VN 1600 B Mean Streak	05-08	CK4455		N/A					CT032
VN 1600 D Nomad	05-08	CK4455		N/A					CT032
VN 1700 G Vulcan 1700 Classic LT	09-10	CK4516		CSK170					CT032
VN 1700 A Vulcan 1700 Voyager	09-13	CK4516		CSK170					CT032
VN 1700 B Vulcan 1700 Voyager ABS	09-16	CK4516		CSK170					CT032
VN 1700 C Vulcan 1700 Nomad	09-13	CK4516		CSK170					CT032
VN 1700 D Vulcan 1700 Nomad	14	CK4516		CSK170					CT032
VN 1700 C Vulcan 1700 Nomad 2T	09	CK4516		CSK170					CT032
VN 1700 E Vulcan 1700 Classic	09-11	CK4516		CSK170					CT032
VN 1700 G Vulcan 1700 Classic LT	09-10	CK4516		CSK170					CT032
VN 1700 J Vulcan Vaquero	11-13	CK4516		CSK170					CT032
VN 1700 K Vulcan Vaquero ABS	14-21	CK4516		CSK170					CT032
VN 1700 K Vulcan Vaquero ABS SE	14-21	CK4516		CSK170					CT032
VN 2000 A/G Vulcan	04-09	CK4516		CSK110					CT032
VN 2000 D/G Vulcan Ltd	05-06	CK4516		CSK110					CT032
VN 2000 E/H Vulcan Classic	06-09	CK4516		CSK110					CT032
VN 2000 F/J Vulcan Classic LT	06-10	CK4516		CSK110					CT032
SUZUKI									
AC 50 R	70-71	CK3311		CSK25					CT051
AS 50 Sport/Colt	68-69	CK3311		CSK25					CT051
DR-Z 50	19-21	CK3458							
JR 50 C/N/T/X/Z/F/G/H/J/K/L/N/P/R/S/T/V/W/X/Y/K	78-06	CK3366		N/A					
RB 50 H (GSXR 50)	87	CK3380		CSK13					CT051
RM 50 C/NT	78-80	CK3328		CSK1					CT011
RM 60 NT/X/Z/D	79-83	CK3318	CKF3318	CSK1					CT011
RM 60 K	3	CK4438	CKF4438	CSK18	DRC7				CT070SP
RM 65 K	03-05	CK4438	CKF4438	CSK40	DRC98	DRCF98			CT070SP
DR-Z 70	15-21	CK3458		N/A					
DS 80 T/X/Z	80-82	CK3340		CSK1					CT011
DS 80 D/F/G/H/J/K/L/M/N/P/R/S/T/V/W/X/Y	83-00	CK3340		CSK1					CT011
JR 80 K	01-04	CK3340		CSK1					CT011
RM 80 T/X	80-81	CK3318	CKF3318	CSK1					CT011
RM 80 Z/D	82-83	CK3340		CSK36					CT011
RM 80 E/F	84-85	CK3318	CKF3318	CSK34					CT011
RM 80 G	86	CK3367		CSK34					

CLUTCH APPLICATIONS

EBC BRAKES CLUTCH KITS



SUZUKI



		CK cork OEM style Kit #	CKF carbon fiber style upgrade Kit #	CSK Spring Kit #	DRC Series Kit #	DRCF Series Kit #	SRC Series Kit #	SRK Series Kit #	CT Tool #
RM 80 H/J	87-88	CK3367		CSK55	DRC19				
RM 80 K/L	89-90	CK3318		CSK36	DRC20				CT011
RM 80 M/N/P/R/S/T/V/W/X/Y/K	91-01	CK3318	CKF3318	CSK14	DRC25	DRCF25			CT011
RM 85	02-21	CK3318	CKF3318	CSK14	DRC25	DRCF25			CT011
TC 90/R/J Blazer	70-72	CK3312		CSK25					CT051
TS 90/R/J Honcho	70-72	CK3312		CSK25					CT051
A 100 A/B Gofer	76-77	CK3312		CSK25					CT051
B 100 P Magnum (118cc)	65-66	N/A		N/A					
DR 100 D/E	83-84	CK3318	CKF3318	CSK34					CT011
DR 100 F/G/H/J/K/L	85-90	CK3318	CKF3318	CSK34					CT011
DS 100 C/N/T/X	78-81	CK3318	CKF3318	CSK25					CT011
RM 100 A	76	CK3319	CKF3319	CSK25					CT011
RM 100 A/B	77-78	CK3329		CSK25					CT011
RM 100 N/T/X	79-81	CK3319		CSK25					CT011
RM 100 K	03-04	CK4438	CKF4438	CSK40	DRC98	DRCF98			CT070SP
SP 100 D	83	CK3318	CKF3318	CSK1					CT011
TC 100 K/L/M/A/B Blazer	73-77	CK3326		CSK25					CT051
TS 100 K/L/M/A/B Honcho	73-77	CK3326		CSK25					CT051
TS 100 T/X	80-81	CK3337		CSK25					CT011
DR-Z 110 K	03-05	CK4438	CKF4438	CSK40	DRC98	DRCF98			CT070SP
B 120 (118cc - 106mm outer diameter friction plate)	71-77	CK3306		CSK1					CT052
KT 120 Trail	68-70	N/A		N/A					CT052
TC 120 Trailcat	68-71	CK3306		CSK1					CT052
ALT 125 D/E/F/G	83-86	CK3328		N/A					CT011
DR 125 Z/D/E	82-84	CK3318		CSK34					CT011
DR 125 G/H/J	86-88	CK3318		CSK34					CT011
DR 125 SER/SES/SET	94-96	CK3318		CSK34					CT011
DR-Z 125 K/L	03-20	CK3318		CSK34					CT011
DR-Z 125 LK/LL	03-20	CK3318		CSK34					CT011
DS 125 N/T/X	79-81	CK3318		CSK25					CT011
GN 125 Z/D	82-83	CK3318	CKF3318	CSK34					CT011
GN 125 E	91-97	CK3318	CKF3318	CSK34					CT011
GSX-R 125	18-21	CK3318	CKF3318	CSK245			SRC148	SRK148	CT011
GSX-S 125	18-21	CK3318	CKF3318	CSK245			SRC148	SRK148	CT011
LT 125 D/E/F/G/H	83-87	CK3328		N/A					CT
RM 125 A/B/C	76-78	CK3329		CSK25					CT011
RM 125 X/Z	81-82	CK3329		CSK36					CT011
RM 125 D	83	CK3329		CSK34					CT011
RM 125 E	84	CK3356		CSK34					CT011
RM 125 F	85	CK3329		CSK34					CT011
RM 125 G/H	86-87	CK3319		CSK1	DRC21				CT011
RM 125 J/K/L/M	88-91	CK3356		CSK53	DRC22				CT011
RM 125 N	92	CK3401		CSK32	DRC114				CT003
RM 125 P/R/S/T/V/W	93-98	CK3401		CSK27	DRC76S				CT003
RM 125 X/Y/K	99-01	CK3401		CSK91	DRC115				CT003
RM 125 K	02-08	CK4514	CKF4514	CSK91	DRC130	DRCF130			CT003
RV 125 K/L/M/A/B Tracker	73-77	CK3318	CKF3318	CSK25					CT011
SP 125 Z/D	82-83	CK3318	CKF3318	CSK34					CT011
SP 125 G/H/J	86-88	CK3318	CKF3318	CSK34					CT011
T 125/11/R Stinger	69-71	CK3306		CSK25					CT052
TC 125 J/K/L/M/A/B Prospector	72-77	CK3318	CKF3318	CSK25					CT011
TM 125 K/L/M Challenger	73-75	CK3319	CKF3319	CSK25					CT011
TS 125 T/X	80-81	CK3337		CSK25					CT011
GSX-R 150	18-21	CK3318	CKF3318	CSK245			SRC148	SRK148	CT011
GSX-S 150	18-21	CK3318	CKF3318	CSK245			SRC148	SRK148	CT011
S32 (150cc)	65	N/A		N/A					
S32-11 (150cc)	66-67	N/A		N/A					

CLUTCH APPLICATIONS

Part numbers, prefixes, suffixes, photos and illustrations shown in this catalog are trademarks and/or copyrights of EBC Brakes or the trademark owner A C Freeman Investments Ltd and use without express written permission of the owners is punishable by law.

EBC BRAKES CLUTCH KITS



SUZUKI



		CK cork OEM style Kit #	CKF carbon fiber style upgrade Kit #	CSK Spring Kit #	DRC Series Kit #	DRCF Series Kit #	SRC Series Kit #	SRK Series Kit #	CT Tool #
LT 160 EK /EL/EM/EN	89-92	CK3364		CSK48	DRC218				CT011
LT 160 K	03-04	CK3364		CSK48	DRC218				CT011
LT-F 160 M/N/P/R/S/T/V/W/X/Y/K1/K3	91-03	CK3364		CSK48	DRC218				CT011
PE 175 T/X/Z/D/E	80-84	CK3329		CSK25					CT011
RS 175 T/X/Z	80-82	CK3329		CSK25					CT011
ALT 185 F	85	CK3328		N/A					CT011
DS 185 T	80	CK3319		CSK25					CT011
GT 185 K/L/M/A/B Adventurer	73-77	CK3319		CSK25					CT011
LT 185 E/F/G/H	84-87	CK3328		N/A					CT011
TS 185 T/X	80-81	CK3319		CSK25					CT011
DR 200 G/H/J	86-88	CK3319	CKF3319	CSK34	DRC94				CT011
DR 200 SE	96-19	CK3319	CKF3319	CSK34	DRC274				CT011
SP 200 G/H/J	86-88	CK3319	CKF3319	CSK34	DRC94				CT011
T 200 X5 - Invader	68-69	CK3319		CSK25					
TC 200 X5 Stingray	67-69	CK3319	CKF3319	CSK25					
LT 230 GEF/GEG	85-86	CK3364		CSK48	DRC218				CT011
LT 230 S up to E/No. 104360	85-88	CK3364		CSK34					CT011
LT 230 S from E/No. 104361	85-88	CK3319		CSK34	DRC94				CT011
LT-F 230 G/H	86-87	CK3364		CSK48	DRC218				CT011
LT 230 E	87-93	CK3364		CSK48	DRC218				CT011
DR 250 Z/D/F	82-85	CK3358		CSK26					CT029
DR 250 L/M/N/P	90-93	CK3399	CKF3399	CSK34	DRC58	DRCF58			CT022
DR 250 S/SE	90-95	CK3399	CKF3399	CSK34	DRC58	DRCF58			CT022
DR-Z 250 K	01-07	CK1181	CKF1181	CSK46	DRC280	DRCF280			CT013
DS 250 T	80	CK3315		CSK158					CT022
GS 250 TT/TX	80-81	CK3329		CSK36					CT011
GN 250 Z/D/F/J	82-88	CK3358		CSK158					CT029
GT 250 K/L Hustler	73-74	CK3313		CSK6					CT022
GT 250 M/A/B Hustler	75-77	CK3315		CSK6					CT022
GW 250 L (Naked)	14-15	CK3358		CSK204					CT029
GW 250 FL (Fairing)	14-15	CK3358		CSK204					CT029
GZ 250 X/Y/K/L Marauder	99-10	CK3358		CSK68					CT029
LT 250 EFF/EG	85-86	CK3390		CSK48	DRC89				CT011
LT 250 SK/SL	89-90	CK3329		CSK34	DRC96				CT011
LT 250 R	85	CK3319		CSK34					CT011
LT 250 R	86	CK3319		CSK146					CT011
LT 250 R	87-92	CK3372		CSK34	DRC23				CT022
LT 4WD Quadrunner 4WD H/J/K/L/M/N/P/R/S/T/V	87-97	CK3390		CSK48	DRC89				CT011
LT-F 4WD V/W Quadrunner 4WD (250cc)	97-98	CK3390		CSK48	DRC89				CT011
LT-F 250 J/K/L/M/N/P/R/S/V/W/X/Y/K1	88-01	CK3390		CSK48	DRC89				CT011
LT-F 250 FX/FY/FK1/FK2 Quadrunner	99-02	CK3390		CSK48	DRC89				CT011
LT-F 250 K Ozark Up to frame JSAAJ51A22100696	02	CK3364		CSK48	DRC220				CT011
LT-F 250 K Ozark From frame JSAAJ51A22100697-	02	CK3364		CSK147	DRC297				CT011
LT-F 250 K Ozark	03	CK3390		CSK147	DRC221				CT011
LT-F 250 K Ozark	04	CK3448		CSK48	DRC222				CT011
LT-F 250 K/L Ozark	05-14	CK3390		CSK147	DRC221				CT011
LT-Z 250 K QuadSport	04-11	CK3448		CSK48	DRC222				CT011
PE 250 T/X	80-81	CK3331		CSK158					CT022
RM 250 T/X/Z/D/E/F	80-85	CK3331		CSK158					CT022
RM 250 G	86	CK3372		CSK34					CT022
RM 250 H	87	CK3372		CSK55	DRC52				CT022
RM 250 J/K/L	88-90	CK3374		CSK27	DRC24				CT022
RM 250 M	91	CK3400		CSK45	DRC40				CT022
RM 250 N/P	92-93	CK3400		CSK32	DRC48				CT022
RM 250 R/S	94-95	CK3374		CSK32	DRC72				CT022
RM 250 T	96	CK4435	CKF4435	CSK32	DRC80				CT016
RM 250 V/W/X/Y/K	97-02	CK4435	CKF4435	CSK91	DRC95				CT016

CLUTCH APPLICATIONS

EBC BRAKES CLUTCH KITS



SUZUKI



		CK cork OEM style Kit #	CKF carbon fiber style upgrade Kit #	CSK Spring Kit #	DRC Series Kit #	DRCF Series Kit #	SRC Series Kit #	SRK Series Kit #	CT Tool #
RM 250 K	03-05	CK3454		CSK91	DRC161				CT016
RM 250 K	06-08	CK3453		CSK119	DRC160				CT016
RMX 250 K/L	89-90	CK3374		CSK27					CT022
RMX 250 M	91	CK3374		CSK45					CT022
RMX 250 N/P	92-93	CK3400		CSK32					CT022
RMX 250 R/S/T/V/W/X/Y	94-00	CK3374		CSK32	DRC72				CT022
RM-Z 250 K	04-06	CK4514	CKF4514	CSK97	DRC123	DRCF123			CT004
RM-Z 250 K	07-09	CK4514	CKF4514	CSK141	DRC189	DRCF189			CT004
RM-Z 250 L	10-21	CK4514	CKF4514	CSK164	DRC255	DRCF255			CT004
RS 250 T/X	80-81	CK3331		CSK158					CT022
SP 250 Z/D/F	82-85	CK3358		CSK26					CT029
T 10 (250cc)	66-67	N/A		N/A					
T 20 X6 (250cc)	65-69	CK3310		CSK76					CT038SP
T 250 11/R/J Hustler	69-72	CK3313		CSK6					CT046
TC 250 X6 Scrambler	67-69	CK3310		CSK76					CT038SP
TS 250 N/T/X	80-81	CK3315		CSK158					CT022
TU 250 XK/XL	09-16	CK3358		CSK158					CT029
GS 300 LZ/LD/LF	82-85	CK3356		CSK34					CT011
LT 300 EH/EJ/EK Quadrunner	87-88	CK3390		CSK48	DRC89				CT011
LT-F 300 F/FK King Quad	99-02	CK3356		CSK48	DRC103				CT011
LT-F 4WD XM/N/P/R/S/T/V/W 300 King Quad	91-97	CK3356		CSK48	DRC103				CT011
T 305 Raider	68-69	CK3313		CSK6					CT046
TC 305 Laredo	68	CK3313		CSK6					CT046
DR 350 L/M/N/P/R/S/T/V/W	90-98	CK3399	CKF3399	CSK34	DRC58	DRCF58			CT022
DR 350 S/SE	90-99	CK3399	CKF3399	CSK34	DRC58	DRCF58			CT022
T 350 Rebel	69-72	CK3313		CSK6					CT046
DR 370 C/N (4T)	78-79	CK3334		CSK158					CT022
RM 370 A/B (2T)	76-77	CK3315		CSK158					CT022
GT 380 J/K/L/M/A/B Sebring	72-77	CK3315		CSK6					CT022
DR 400 T	80	CK3332		CSK158					CT022
DR-Z 400 S	00-16	CK3433	CKF3433	CSK79	DRC105	DRCF105			CT006
DR-Z 400 EY/Y/EK/K	00-07	CK3433	CKF3433	CSK79	DRC105	DRCF105			CT006
DR-Z 400 SMK	08-24	CK3433	CKF3433	CSK79	DRC105	DRCF105			CT006
GSF 400 M/N/P	91-93	CK3397		CSK34					CT011
GN 400 T/XT/TX/TZ	80-82	CK3332		CSK158					CT022
GS 400 B/C	77-78	CK3343		CSK6					CT018SP
GS 400 XB/XC	77-78	CK3343		CSK6					CT018SP
LT-F 400 FK King Quad 400 FS	08-09	CK4439		CSK98	DRC120				CT006
LT-F 400 FCK King Quad 400 FS Camo	08-09	CK4439		CSK98	DRC120				CT006
LT-F 400 FK (Eiger 4WD)	02-07	CK4439		CSK98	DRC120				CT006
LT-F 400 K Eiger Manual 2WD	02	CK4439		CSK98	DRC223				CT006
LT-F 400 K	03-08	CK4439		CSK98	DRC120				CT006
LT-F 400 FQK King Quad 400 FS Anniversary Edition	09	CK4439		CSK98	DRC120				CT006
LT-F 400 FL King Quad 400 FSi	11-16	CK4439		CSK98	DRC120				CT006
LT-F 400 FCL King Quad Camo 400 FSi	11-16	CK4439		CSK98	DRC120				CT006
LT-Z 400 K Quadsport	03-04	CK3433	CKF3443	CSK79	DRC105	DRCF105			CT006
LT-Z 400 K/ZK/L2	05-14	CK3447	CKF3447	CSK79	DRC137	DRCF137			CT006
PE 400 T/X	80-81	CK3332		CSK158					CT022
RM 400 C	78	CK3315		CSK158					CT022
RM 400 N/T	79-80	CK3332		CSK158					CT022
SP 400 T	80	CK3332		CSK158					CT022
TM 400 R/J/K/L/M Cyclone	71-75	CK3316		CSK158					CT022
GS 425 N (Spoke Wheel)	79	CK3343		CSK6					CT018SP
GS 425 EN (Cast Wheel)	79	CK3343		CSK6					CT018SP
GS 425 LN	79	CK3343		CSK6					CT018SP
GS 450 E	80-83	CK3333		CSK158					CT022
GS 450 L	80-88	CK3333		CSK158					CT022

CLUTCH
APPLICATIONS

EBC BRAKES CLUTCH KITS



SUZUKI



		CK cork OEM style Kit #	CKF carbon fiber style upgrade Kit #	CSK Spring Kit #	DRC Series Kit #	DRCF Series Kit #	SRC Series Kit #	SRK Series Kit #	CT Tool #
GS 450 T	81-83	CK3333		CSK158					CT022
LT-R 450 K	06-11	CK3450	CKF3450	CSK125	DRC164	DRCF164			CT045
LT-R 450 ZK Quadracer SE	08-10	CK3450	CKF3450	CSK125	DRC164	DRCF164			CT045
RMX 450 ZL	10-11	CK3450	CKF3450	CSK186	DRC155	DRCF155			CT045
RM-Z 450 K	05-07	CK3450	CKF3450	CSK164	DRC254	DRCF254			CT045
RM-Z 450	08-21	CK3450	CKF3450	CSK186	DRC155	DRCF155			CT045
RM 465 X/Z	81-82	CK3348		CSK158					CT029
DR 500 X/Z/D	81-83	CK3359		CSK115					CT029SP
GS 500 E/K	89-03	CK3333		CSK61					CT022
GS 500 FK	04-10	CK3333		CSK61					CT022
LT 500 RH/RJ/RK/RL	87-90	CK3374		CSK34	DRC26				CT022
LT-F 500 F/FK Quadrunner	98-02	CK4439		CSK88	DRC217				CT006
LT-F 500 FK Vinson 4WD	03-09	CK3452		CSK7	DRC216				CT006
RM 500 D/E	83-84	CK3348		CSK158					CT029
SP 500 X/Z/D	81-83	CK3359		CSK115					CT029SP
T 500 1 Cobra (18 Ear Clutch Plate)	68	CK3314		CSK6					CT046
T 500 39873 Titan (18 Ear Clutch Plate)	69-70	CK3314		CSK6					CT046
T 500 R/J/K/L/M Titan (12 Ear Clutch Plate)	71-75	CK3316		CSK6					CT022
RE 5 M/A (Rotary)	75-76	CK3373		CSK6					CT035SP
GS 550 B/C/EC/N/EN/ET	77-80	CK3344		CSK159					CT018SP
GS 550 MZ	82	CK3344		CSK159					CT018SP
GS 550 LT/LX/LZ	80-82	CK3344		CSK159					CT018SP
GS 550 LD/LF/LG/TX	81-85	CK3344		CSK159					CT018SP
GS 550 E/ES	83	CK3344		CSK159					CT018SP
GS 550 ES/E	84-85	CK3344		CSK159					CT018SP
GT 550 J/K/L/M/A/B Indy	72-77	CK3321		CSK158					CT035SP
GSF 600 S Bandit	96-98	CK3348		CSK198					CT047SP
GSF 600 S/SK	00-02	CK3348		CSK198					CT047SP
GSX 600 F Katana	88-91	CK3348		CSK26			SRC13	SRK13	CT047SP
GSX 600 F Katana	92-97	CK3387		CSK198			SRC17	SRK17	CT036SP
GSX 600 F/FK - Katana	98-06	CK3357		CSK198					CT047SP
GSX-R 600 WN/WP	92-93	CK3387		CSK198			SRC17	SRK104	CT036SP
GSX-R 600 V/W	97-98	CK1206		CSK902			SRC58	SRK106	CT055SP
GSX-R 600 X/Y	99-00	CK1206		CSK902			SRC58	SRK58	CT055SP
GSX-R 600 K/ZK	01-03	CK3466		CSK261			SRC112	SRK112	CT014
GSX-R 600 K	04-08	CK1206		CSK156			SRC78	SRK78	CT014
GSX-R 600 K	06-07	CK3455		CSK205			SRC86	SRK86	CT015
GSX-R 600 K	08-Oct	CK3456		CSK205			SRC88	SRK109	CT015
GSX-R 600 L	11-21	CK3456		CSK183			SRC110	SRK110	CT015
RF 600 R	94-96	CK3408		CSK198			SRC45	SRK45	CT036SP
SP 600 F	85	CK3359		CSK115					CT029SP
DL 650 KV-Strom	04-09	CK1219		CSK133					CT033SP
DL 650 AK/AL V-Strom (ABS Model)	07-21	CK1219		CSK133			SRC82	SRK82	CT033SP
DL 650 XT V-Strom ABS (DL 650 XAL5/XAL6)	15-21	CK1219		CSK133			SRC82	SRK82	CT033SP
DL 650 AAL V-Strom (ABS Adventure)	12-21	CK1219		CSK133			SRC82	SRK82	CT033SP
DR 650 S	90-93	CK3402		CSK115	DRC59				CT029SP
DR 650 S	94-95	CK3402		CSK115	DRC142				CT029SP
DR 650 SE/SEK/SEL	96-16	CK3386		CSK26	DRC87				CT024
GR 650 D/XD	83	CK3357		CSK26					CT029
GS 650 E/G	81-83	CK3330		CSK159					CT018SP
GS 650 GL	81-83	CK3330		CSK159					CT018SP
GS 650 MD	83	CK3330		CSK159					CT018SP
GSX 650 FK	08-10	CK1218	CKF1218	CSK122					CT014
LS 650 F/P/PK	86-88/95-04	CK3359		CSK26					CT029SP
LS 650 K/L Boulevard S40 (650cc)	08-15	CK3359		CSK26					CT029SP
SFV 650 K/L	09-10/13-15	CK1219		CSK133			SRC82	SRK82	CT033SP
SV 650 X/Y/K/SK	99-02	CK3377		CSK69			SRC81	SRK81	CT022

CLUTCH APPLICATIONS

EBC BRAKES CLUTCH KITS



SUZUKI



		CK cork OEM style Kit #	CKF carbon fiber style upgrade Kit #	CSK Spring Kit #	DRC Series Kit #	DRCF Series Kit #	SRC Series Kit #	SRK Series Kit #	CT Tool #
SV 650 K/SK	03-10	CK1219		CSK133			SRC82	SRK82	CT033SP
SV 650 AK/SAK ABS	07-10	CK1219		CSK133			SRC82	SRK82	CT033SP
SV 650 AL (ABS)	16-21	CK1219		CSK133			SRC82	SRK82	CT033SP
XN 85 D	83	CK3347		CSK158					CT018SP
GS 700 E	85	CK3330		CSK115					CT018SP
GV 700 GL	85	CK3374		CSK115					CT022
VS 700 GL	86-87	CK3377		CSK115					CT029
GS 750 B/C/E/N/E	77-79	CK3324		CSK158					CT018SP
GS 750 E	80-82	CK3330		CSK158					CT018SP
GS 750 T	82-83	CK3330		CSK158					CT018SP
GS 750 L	80-81	CK3330		CSK158					CT018SP
GS 750 E/ES	83	CK3330		CSK115					CT018SP
GS 750 SD	83	CK3330		TBA					CT018SP
GSX 750 F	89-96	CK3391		CSK12					
GSX 750 F Katana	98-06	CK3357		CSK198					CT047SP
GSX-R 750 RG (Dry Clutch - Sintered Friction)	86	CK3376		CSK198			N/A	SRK138	CT072SP
GSX-R 750 G/H	86-87	CK3348		CSK115			SRC13	SRK13	CT047SP
GSX-R 750 J/K	88-89	CK3387		CSK12			SRC14	SRK14	CT036SP
GSX-R 750 L/M/N	90-92	CK3387		CSK198			SRC17	SRK17	CT036SP
GSX-R 750 WP/WR/WS	93-95	CK3387		CSK198			SRC17	SRK104	CT036SP
GSX-R 750 T/V/W/X	96-99	CK3417		CSK902			SRC40	SRK40	CT055SP
GSX-R 750 Y	00	CK1229		CSK156			SRC71	SRK71	CT014
GSX-R 750 K	01-03	CK3465		CSK156			SRC111	SRK111	CT014
GSX-R 750 K	04-05	CK3417		CSK75			SRC121	SRK121	CT014
GSX-R 750 K	06-07	CK3456		CSK205			SRC88	SRK88	CT015
GSX-R 750 K/L	08-10	CK3456		CSK205			SRC88	SRK109	CT015
GSX-R 750	11-21	CK3456		CSK183			SRC110	SRK110	CT015
GSX-S 750	15-16	CK3417		CSK109			SRC169	SRK169	CT014
GSX-S 750 ABS	17-21	CK3417		CSK109			SRC169	SRK169	CT014
GT 750 J/K/L/M/A/B	73-77	CK3324		CSK158					CT018SP
VS 750 GLP	88-91	CK3377		CSK115					CT029
VL 800 K Intruder Volusia	01-04	CK3377		CSK66					CT029
VL 800 ZK Volusia LTD (Seat Trimmed With Chrome Studs)	03-04	CK3377		CSK66					CT029
VL 800 CK/K/ZK/L (C 50 Boulevard)	05-15	CK3377		CSK66					CT029
VL 800 TK/TL (C 50 T Boulevard Tourer)	05-15	CK3377		CSK66					CT029
VL 800 BTL4 (Boulevard C50 B.O.S.S./Cast Wheels)	14	CK3377		CSK66					CT029
VL 800 CL3 (Boulevard C50/Cast Wheels)	13	CK3377		CSK66					CT029
VX 800 L/M/N/P (8 spring CSK kit)	90-93	CK3377		CSK162					CT029
VS 800 Intruder GL/GLK	92-04	CK3377		CSK115					CT029
VS 800 K/L S50 Boulevard	05-10	CK3377		CSK115					CT029
VZ 800 V/W/X/Y/K Marauder (8 spring CSK kit)	97-04	CK3377		CSK162					CT029
VZ 800 K/BK/ZK (M50 Boulevard)	05-10	CK3377		CSK66					CT029
VZ 800 L (M50 Boulevard)	10-15	CK3377		CSK66					CT029
GS 850 G	79-80	CK3330		CSK158					CT018SP
GS 850 G	81-83	CK3330		CSK158					CT018SP
GS 850 G	80-81	CK3330		CSK158					CT018SP
GS 850 G	82-83	CK3330		CSK158					CT018SP
RF 900 R	94	CK3418		CSK902			SRC39	SRK39	CT055SP
RF 900 R	95-97	CK3417		CSK29					CT014
DL 1000 K/L V-Strom	02-12	CK3443		CSK43					CT021
DL 1000 AL V-Strom ABS	14-20								
DL 1000 AL/AAL V-Strom Adventure	14-20								
GS 1000 C/N/EC/EN/SN/ET/ST	78-80	CK3345		CSK158			SRC115	SRK115	CT035SP
GS 1000 SZ	82	CK3335		CSK6					CT024SP
GS 1000 GT/GX	80-81	CK3335		CSK158			SRC50	SRK50	CT024SP
GS 1000 GLT/GLX/SZ	80-82	CK3335		CSK158			SRC50	SRK50	CT024SP
GSX-R 1000 K/ZK	01-04	CK4510		CSK128			SRC89	SRK89	CT004

CLUTCH
APPLICATIONS

Part numbers, prefixes, suffixes, photos and illustrations shown in this catalog are trademarks and/or copyrights of EBC Brakes or the trademark owner A C Freeman Investments Ltd and use without express written permission of the owners is punishable by law.

EBC BRAKES CLUTCH KITS



SUZUKI



		CK cork OEM style Kit #	CKF carbon fiber style upgrade Kit #	CSK Spring Kit #	DRC Series Kit #	DRCF Series Kit #	SRC Series Kit #	SRK Series Kit #	CT Tool #
GSX-R 1000 K	05-08	CK3451		CSK145			SRC85	SRK85	CT015
GSX-R 1000 K/L	09-11	CK3462		CSK160			SRC97	SRK97	CT009
GSX-R 1000 L	12-16	CK3462		CSK196			SRC120	TBA	CT009
GSX-R 1000 AL ABS	15-16	CK3462		CSK196			SRC120	TBA	CT009
GSX-R 1000 AL ABS/3 Spring clutch	17	CK3468		CSK242			SRC142	SRK142	CT009
GSX-S 1000	16-17	CK4510		CSK223					CT004
GSX-S 1000 ABS	16-17	CK4510		CSK223					CT004
GSX-S 1000	18-19	CK3451		CSK145			SRC85	SRK85	CT015
GSX-S 1000 ABS	18-19	CK3451		CSK145			SRC85	SRK85	CT015
GSX-S 1000 F	16-17	CK4510		CSK223					CT004
GSX-S 1000 F ABS	16-17	CK4510		CSK223					CT004
GSX-S 1000 F	18-19	CK3451		CSK145			SRC85	SRK85	CT015
GSX-S 1000 F ABS	18-19	CK3451		CSK145			SRC85	SRK85	CT015
Katana	19-21	CK3451		CSK145			SRC85	SRK85	CT015
SV 1000 K/SK	03-07	CK3443		CSK114					CT021
TL 1000 S	97-98	CK3417		CSK78					CT014
TL 1000 S	99-00	CK3428		CSK71			SRC68	SRK68	CT009
TL 1000 R	98-00	CK3428		CSK71			SRC68	SRK68	CT009
TL 1000 RK	01-03	CK3435		CSK71					CT009
TL1 000 SK	01-02	CK3435		CSK71					CT009
GS 1100 E	80-82	CK3335		CSK158			SRC50	SRK50	CT024SP
GS 1100 E	83	CK3346		CSK6					CT024SP
GS 1100 G	82-83	CK3335		CSK158			SRC50	SRK50	CT024SP
GS 1100 GL	82-83	CK3335		CSK158			SRC50	SRK50	CT024SP
GS 1100 GK	82-84	CK3335		CSK158			SRC50	SRK50	CT024SP
GS 1100 LT	80	CK3335		CSK158			SRC50	SRK50	CT024SP
GS 1100 SD	83	CK3346		CSK6					CT024SP
GSX 1100 F	88-93	CK3381		CSK12					CT048SP
GSX 1100 G	91-93	CK3392		CSK902			SRC10	SRK10	CT055SP
GSX-R 1100 G/H/J	86-88	CK3381		CSK115			SRC15	SRK15	CT048SP
GSX-R 1100 K/L/M/N	89-92	CK3392		CSK902			SRC10	SRK10	CT055SP
GSX-R 1100 W	93-98	CK3418		CSK902			SRC39	SRK39	CT055SP
GS 1150 ES	83-86	CK3335		CSK6					CT024SP
GSF 1200 S/SK	97-05	CK3417		CSK902			SRC40	SRK40	CT055SP
GV 1200 GL	85-86	CK3375		CSK115					CT029
GSF 1250 SAK (ABS)	07-10	CK3459		CSK124					CT021
GSF 1250 SK Bandit	07-10	CK3459		CSK124					CT021
GSX 1250 FAL	11-12	CK3459		CSK124					CT021
GSX 1250 SAL Bandit	16	CK3459		CSK124					CT021
GSX 1300 RX Hayabusa	99	CK3430		CSK72			SRC67	SRK67	CT021
GSX 1300 RY/RK1 Hayabusa	00-01	CK3430		CSK171					CT021
GSX 1300 RK/RZK	02-07	CK3443		CSK171					CT021
GSX 1300 RK/RL	08-12	CK3443		CSK139					CT021
GSX 1300 RAL ABS Hayabusa	13-16	CK3443		CSK139					CT021
GSX 1300 RZL (Hayabusa 50th Anniversary Edition)	14	CK3443		CSK139					CT021
GSX 1300 BKA/K B-King ABS	08-10	CK3443		CSK139					CT021
GSX 1300 BKK/K B-King	08-10	CK3443		CSK139					CT021
GV 1400 G	86-88	CK3388		CSK115					CT029
VS 1400 GLP/GLF	87-04	CK3382		N/A					CT029
VS 1400 GLPK/K/L Boulevard S83 (1400cc)	05-10	CK3382		N/A					CT029
VL 1500 W/X/Y/K Intruder Legendary Classic	98-04	CK3335		CSK31					CT024SP
VL 1500 BK/K/TK/L/TL Boulevard C90/C90T	05/10/2013	CK3335		CSK31					CT024SP
VL 1500 BL (Boulevard C90 B.O.S.S.)	13-15	CK3459		TBA					CT021
VL 1500 BTL (Boulevard C90T B.O.S.S./With Windshield)	13-14	CK3459		TBA					CT021
VL 1500 L (Boulevard C90)	13	CK3459		TBA					CT021
VL 1500 TL (Boulevard C90T/With Windshield)	13-14	CK3459		TBA					CT021
VZ 1500 K/L M90 Boulevard	09/13-15	CK3459		TBA					CT021

CLUTCH APPLICATIONS

Part numbers, prefixes, suffixes, photos and illustrations shown in this catalog are trademarks and/or copyrights of EBC Brakes or the trademark owner A C Freeman Investments Ltd and use without express written permission of the owners is punishable by law.

EBC BRAKES CLUTCH KITS



SUZUKI



		CK cork OEM style Kit #	CKF carbon fiber style upgrade Kit #	CSK Spring Kit #	DRC Series Kit #	DRCF Series Kit #	SRC Series Kit #	SRK Series Kit #	CT Tool #
VZ 1600 K Marauder	04	CK4455		N/A					CT032
VZ 1600 K M95 Boulevard/Marauder	05	CK4455		N/A					CT032
VLR 1800 RTK (C109RT Boulevard Touring)	08-10	CK3463		CSK75					
VLR 1800 K (C109R Boulevard)	08-10	CK3463		CSK75					
VZR 1800 K/L Boulevard M109R	06-14	CK3457		CSK122					
VZR 1800 NK Boulevard Limited M109R2	08-09	CK3457		CSK122					
VZR 1800 ZK/ZL Boulevard RZ Limited (M109RZ)	08-14	CK3457		CSK122					
VZR 1800 BL (Boulevard B.O.S.S. M109R)	14-15	CK3457		CSK122					

YAMAHA

DT 50 U/W/A (DTL/C)	88-89	CK2206		CSK42					CT044
RX 50 MK Midnight Special	83	CK2205		CSK42					CT044
RX 50 K/L 50 Special	83/84	CK2205		CSK42					CT044
TT-R 50 E	06-09/12-14	TBA		N/A					
YFM 50 S/T/R Raptor	04-08	CK2303		N/A					
YSR 50 T/U/W	87-89	CK2205		CSK42					CT044
YSR 50 A/B/D	90-92	CK2205		CSK42					CT044
YZ 50 G	80	CK2206		CSK42					CT044
YZ 60 H/J/K	81-83	CK2265		CSK42					CT010
YZ 65	19-21	CK2304		CSK42					CT010
BW 80 S/T/U/A	86-90	CK2303		N/A					
DT 80 H/J/K	81-83	CK2206		CSK42					CT044
MX 80 G/H/J	80-82	CK2206		CSK42					CT044
PW 80 K/N/B/D/E/F/G/H/J/K/L/M/N/P/R/S/TV	83-06	CK2303		N/A					
V 80 (3NX3/4)	94	CK2303		N/A					
V 80 (4GC5/6/3NX6)	98	CK2303		N/A					
V 80 D (4GC2/3/4) - 3 = Single Seat / 4 = Dual Street	94-96	CK2303		N/A					
YFM 80 N/S/T/U (Moto 4)	85-88	CK2303		N/A					
YFM 80 D/E/F/G/H/J/K/L/M/N Badger	91-01	CK2303		N/A					
YFM 80 WP/WR/WS/RT/RV/RW/RX Raptor	02-08	CK2303		N/A					
YFM 80 GT/GW/GX Grizzly	05-08	CK2303		N/A					
YZ 80 G	80	CK2238		CSK42					CT044
YZ 80 H/J/K/L/N	81-85	CK2287		CSK42					CT010
YZ 80 S/T/U/W/A/B/D	86-92	CK2304		CSK42	DRC27				CT010
YZ 80 E/F	93-94	CK2304		CSK39	DRC66				CT010
YZ 80 G/H/J/K/L/M/N	95-01	CK2335	CKF2335	CSK42	DRC78				CT010
YZ 85 2T	02-21	CK2335	CKF2335	CSK42	DRC111	DRCF111			CT010
TT-R 90 M/N/P/R/ES/S/ET/EV/EW	00-07	CK2354		N/A					
DT 100 G/H/J/K	80-83	CK2254	CKF2254	CSK42					CT044
MX 100 G/H/J/K	80-83	CK2254	CKF2254	CSK42					CT044
RT 100 A/D/E/F/G/H/J/K/L/M	92-00	CK2254	CKF2254	CSK42					CT044
RX 100 (36L/36L0/5RD1/2)	01-03	CK2254		CSK42					CT044
RX 100 (5RD3/4)	04	CK2254		CSK42					CT044
RX 100 C (5RC1/2/3)	04	CK2254		CSK42					CT044
RXZ 100 S (3HS1/2)	88-95	CK2208		CSK42					CT039
YFM 100 T/U/W/A/B Champ	87-91	N/A		N/A					
YZ 100 G/H/J/K	80-83	CK2234		CSK39					CT039
T 105 E Crypton (5AM4)	99-02	CK2354		N/A					
T 105 SE Crypton (1D81/1D82)	03-09	CK2354		N/A					
TTR 110 E	08-21	CK2375		CSK150					
RXS 115 (3HB6/7)	94-97	CK2254		CSK42					CT044
RXS 115 (3HB8)	99	CK2254		CSK42					CT044
DT 125 G/H	80-81	CK2236		CSK42					CT039
IT 125 G/H	80-81	CK2234		CSK42					CT039
TT-R 125 M/N/P/R/S/E	00-09	CK2254	CKF2254	CSK42	DRC230	DRCF230			CT044
TT-R 125 LWM/L/LE	00-19	CK2254	CKF2254	CSK42	DRC230	DRCF230			CT044
XT 125 J/K/KC	82-83	CK2256		CSK52					CT039

CLUTCH APPLICATIONS

EBC BRAKES CLUTCH KITS



YAMAHA



		CK cork OEM style Kit #	CKF carbon fiber style upgrade Kit #	CSK Spring Kit #	DRC Series Kit #	DRCF Series Kit #	SRC Series Kit #	SRK Series Kit #	CT Tool #
YBA 125 Vision (5AP1)	01	CK2254		CSK42					CT044
YBA 125 Enticer (3P41)	05	TBA		TBA					
YBA 125 Enticer (5US1)	05	TBA		TBA					
YBA 125 Enticer (16C1/3P42/3)	07-12	TBA		TBA					
YBR 125 (5PY1/2)	01	CK2283		CSK42					CT044
YBR 125 (2D0D/2CS1)	11-13	CK1151		N/A					CT012
YBR 125 C (36S1/2/3/4)	08-13	CK1151		N/A					CT012
YBR 125 E (4P24/4P27/4P2B/4P2H)	06-13	CK1151		N/A					CT012
YBR 125 EB (5RR2/3/4/5/6)	02-05	CK2254		CSK42					CT044
YBR 125 EB (5RR8/9)	06-05	CK2254		CSK42					CT044
YBR 125 ED (5RR1)	01	CK2254		CSK42					CT044
YBR 125 ED (4P28) Cast Wheel	07-09	CK1151		N/A					CT012
YBR 125 ED (4P2C/4P2J) Cast Wheel	10-13	CK1151		N/A					CT012
YBR 125 ESD (4P26) Cast Wheel	07-09	CK1151		N/A					CT012
YBR 125 ESD (4P2A/4P2G) Cast Wheel	10-13	CK1151		N/A					CT012
YBR 125 ESG (43B1/3/5/6/8)	08-13	CK1151		N/A					CT012
YBR 125 K (5TU1/2/4/6/8)	02-06	CK2254		CSK42					CT044
YBR 125 R (1PX1/X2)	11-12	CK1151		N/A					CT012
YFM 125 R Raptor	11-13	CK1151	CKF1151	CSK42					CT012
YT 125 G/H	80-81	CK2252		N/A					
YT 125 J/K/L/N	82-85	CK2251		N/A					
YZ 125 G	80	CK2234		CSK42					CT039
YZ 125 H	81	CK2235		CSK39					CT039
YZ 125 J	82	CK2276		CSK39					
YZ 125 K/L/N	83-85	CK2278		CSK39					CT054SP
YZ 125 S/T	86-87	CK2278		CSK2	DRC28				CT054SP
YZ 125 U	88	CK2312		CSK2	DRC29				CT054SP
YZ 125 W/A	89-90	CK2311		CSK2	DRC30				CT054SP
YZ 125 B/D	91-92	CK2319		CSK81	DRC39				CT005
YZ 125 E/F/G	93-95	CK2325	CKF2325	CSK81	DRC70	DRCF70			CT005
YZ 125 H	96	CK2325	CKF2325	CSK14	DRC85				CT005
YZ 125 J/K/L/M/N	97-01	CK2325	CKF2325	CSK81	DRC70	DRCF70			CT005
YZ 125 P/R/S	02-04	CK2325	CKF2325	CSK14	DRC85				CT005
YZ 125 (2T)	05-21	CK2325	CKF2325	CSK81	DRC70	DRCF70			CT005
RX-Z 135 (2UX/3UK1)	87-89	CK2349		CSK42					
RX-Z 135 (3UK3/3RSA/3RSB/3UK1)	93-97	CK2349		CSK42					
RX-Z 135 (3XL3/5PV1/5PV2)	00-05	CK2304		CSK42					CT010
FZ 150 (3C12/3C11)	07-08	TBA		TBA					
SR 150 (3UR8)	95	CK2304		CSK42					CT010
YZF-R 15 (150cc) (54C2/3/6)	10-13	TBA		TBA					
FZ 16 (160cc) (1ES1/2/3)	10-13	TBA		TBA					
FZ 16 (160cc) (1ES4)	12-13	TBA		TBA					
FZ 16 ST (160cc) (1ES4)	11-13	TBA		TBA					
DT 175 G/H	80-81	CK2245		CSK42					CT039
IT 175 G/H/J/K	80-83	CK2235		CSK39					CT039
MX 175 G/H	80-81	CK2245		CSK42					CT039
YT 175 J/K	82-83	CK2251		N/A					
RT 180 A/B/D/E/G/H/J	90-97	CK2245		CSK42					CT039
XC 180 K/KC/L/LC/N/NC/DN/DWC/ZL/ZLC/ZN/ZNC	83-85	CK2298		N/A					
SR 185 H/J	81/82	CK2234		CSK42					CT039
BW 200 N/S/ES/ET/EU	85-88	CK2292		CSK149	DRC55				CT039
IT 200 L/N/S	84-86	CK2235		CSK1					CT039
TW 200 Trailway	87-15	CK2234		CSK149	DRC231				CT039
WR 200 D	92	CK2313	CKF2313	CSK42	DRC42	DRCF42			CT010
XT 200 J/K/KC	82-83	CK2236		N/A					CT039
YFM 200 N	85	CK2287		CSK149	DRC232				CT010SP
YFM 200 D (Moto 4)	86-89	CK2287		CSK149	DRC232				CT010SP

CLUTCH APPLICATIONS

Part numbers, prefixes, suffixes, photos and illustrations shown in this catalog are trademarks and/or copyrights of EBC Brakes or the trademark owner A C Freeman Investments Ltd and use without express written permission of the owners is punishable by law.

EBC BRAKES CLUTCH KITS



YAMAHA



		CK cork OEM style Kit #	CKF carbon fiber style upgrade Kit #	CSK Spring Kit #	DRC Series Kit #	DRCF Series Kit #	SRC Series Kit #	SRK Series Kit #	CT Tool #
YFS 200 U/W/A/B/D/E/F/G/H/J/K/L/M/N/P/R/S/T/V Blaster	88-06	CK2313	CKF2313	CSK42	DRC42	DRCF42			CT010
YTM 200 K/L/N	83-85	CK2287		CSK149	DRC232				CT010SP
YTM 200 E	83-85	CK2287		CSK149	DRC232				CT010SP
TT 225 S/T	86-87	CK2324		CSK149	DRC229				CT039
TT-R 225 L/M/N/P/R/S	99-04	CK2324		CSK149	DRC229				CT039
XT 225 D/DC/E/EC/F/FC/G/GC/H/HC	92-96	CK2234		CSK149	DRC231				CT039
XT 225	92-07	CK2324		CSK149	DRC229				CT039
YFM 225 S/T/U/W (Moto 4)	86-89	CK2287		CSK52	DRC104				CT010SP
YTM 225 DX	83-85	CK2287		CSK52	DRC104				CT010SP
YTM 225 DR	85-86	CK2287		CSK149	DRC232				CT010SP
TT-R 230 T/V/W/X/Y/A/B/D/E/F	05-09/11-15	CK2324		CSK149	DRC229				CT039
DT 250 A/B/C	74-76	CK2240		CSK2					CT008
DT 250 D/E/F	77-79	CK2223		CSK2					CT008
IT 250 F/G	80	CK2250		CSK2					CT008
IT 250 H/J	81-82	CK2279	CKF2279	CSK2					CT008
IT 250 K	83	CK2280		CSK2	DRC32				CT060
SR 250 G/H/TH	80-81	CK2267		CSK2					CT008
SR 250 J	82	CK2267		CSK2					CT008
SR 250 K (3Y9)	93	CK2261		CSK2					CT008
SR 250 (4GR1/2/3/4/9)	93-08	CK2261		CSK2					CT008
SRX 250 T/TC	87	CK2261		CSK49					CT008
TT 250 G/H/J	80-82	CK2267		CSK1					CT008
TT-R 250 L/M/N/P/R/S/T/V	99-06	CK2319		CSK14	DRC226				CT005
WR 250 Z	91-93	CK2309		CSK81					CT020
WR 250 Z	94-97	CK2274	CKF2274	CSK81	DRC71				CT020
WR 250 F	01	CK2355	CKF2355	CSK81	DRC109	DRCF109			
WR 250 F	02-13	CK2355	CKF2355	CSK2	DRC119	DRCF119			
WR 250 F Reverse Cylinder 4T	15-21	CK2355	CKF2355	CSK214					CT005
WR 250 R	08-15	CK2319		CSK81	DRC39				CT005
WR 250 X Supermotard	08-11	CK2319		CSK81	DRC39				CT005
XT 250 G/H/J/K/KC/L/LC	80-84	CK2267		CSK2					CT008
XT 250 X/Y/Z/A/B/D/E/F/G/H	08-17	CK2370	CKF2370	CSK81	DRC295				CT005
XTZ 250 Lander	Jul-14	CK1217		CSK132					CT014
XTZ 250 Lander	16-18	CK1217		CSK132					CT014
XTZ 250 X	08-10	CK1217		CSK132					CT014
XV 250 Route 66/Mirago	88-90/95-07	CK2316		CSK2					CT008
XV 250 V-Star	08-13	CK2316		CSK2					CT008
YBR 250 (41S2/3)	10-12	CK1217		CSK132					CT014
YFB 250 D/E Timberwolf	92-93	CK2287		CSK52	DRC104				CT010SP
YFB 250 F/G/H/UH/J/UJ/UK Timberwolf	94-98	CK2287		CSK52	DRC104				CT010SP
YFB 250 FWF Timberwolf	94-00	CK2287		CSK52	DRC104				CT010SP
YFM 250 W/A/B	89-91	CK2287		CSK52	DRC104				CT010SP
YFM 250 Bear Tracker L/M/X	99-03	CK2287		CSK52	DRC104				CT010SP
YFM 250 B Bruin	05-06	CK2287		CSK52	DRC104				CT010SP
YFM 250 B Big Bear	07-09	CK2287		CSK52	DRC104				CT010SP
YFM 250 R Raptor	08-13	CK2370	CKF2370	CSK58	DRC200	DRCF200			CT005
YFM 250 RS Special Edition	08-09	CK2370	CKF2370	CSK58	DRC200	DRCF200			CT005
YFM 250 RSPXC Special Edition Custom	08	CK2370	CKF2370	CSK58	DRC200	DRCF200			CT005
YFM 250 RSPA Special Edition	11	CK2370	CKF2370	TBA					CT005
YFUW/YFUITW Pro Hauler (230cc)	89	CK2287		CSK52	DRC104				CT010SP
YP 250 Fazer (5D41/2/3/56C1)	06-10	CK1217		CSK132					CT014
YTZ 250 N/S	85-86	CK2280		CSK2	DRC32				CT060
YZ 250 H	81	CK2279	CKF2279	CSK2					CT008
YZ 250 J/K/L	82-84	CK2280		CSK2					CT060
YZ 250 N/S/T	85-87	CK2280		CSK103	DRC35				CT060
YZ 250 U/W/A/B/D	88-92	CK2309		CSK2	DRC31				CT020
YZ 250 WR	89-90	CK2309		CSK2					CT020

CLUTCH APPLICATIONS

EBC BRAKES CLUTCH KITS



YAMAHA



		CK cork OEM style Kit #	CKF carbon fiber style upgrade Kit #	CSK Spring Kit #	DRC Series Kit #	DRCF Series Kit #	SRC Series Kit #	SRK Series Kit #	CT Tool #
YZ 250 E/F/G/H/J/K/L	93-99	CK2274	CKF2274	CSK81	DRC71				CT020
YZ 250 M/N	00-01	CK2274	CKF2274	CSK49	DRC97				CT020
YZ 250 P/R/S/T/V/W/X/Y/Z/A/B/D/E/F/G (2T)	02-16	CK2274	CKF2274	CSK92	DRC113	DRCF113			CT020
YZ 250 XG (2T)	16	CK2274	CKF2274	CSK92	DRC113	DRCF113			CT020
YZ 250 F (4T)	01-07	CK2355	CKF2355	CSK191	DRC109	DRCF109			CT005
YZ 250 F (4T)	08-13	CK2355	CKF2355	CSK137	DRC227	DRCF227			CT005
YZ 250 F (4T)	14-16	CK2355	CKF2355	CSK214	DRC288	DRCF288			CT005
YZ 250 F FK (4T)	19-21								
MT-03	12-21	CK1193		CSK219			SRC128	SRK128	CT080
YZ-F R3 (321cc)	15-21	CK1193		CSK219			SRC128	SRK128	CT080
BW 350 T/U	87-88	CK2240		CSK103					CT008
R5/5A/5B - 350cc	70-72	CK2240		CSK39					CT008
RD 350 73-75	72-75	CK2240		CSK39					CT008
RZ 350 L/N/NCII	84-85	CK2240		CSK2					CT008
TT 350 S/T	86-87	CK2240		CSK14	DRC56				CT008
TY 350 N/S	85-86	CK2295		CSK34					CT060
XT 350	85-00	CK2240		CSK14	DRC56				CT008
YFM 350 ER	87-94	CK2290	CKF2290	CSK58	DRC33	DRCF33			CT090SP
YFM 350 ER	95	CK2290	CKF2290	CSK49	DRC82				CT008
YFM 350 FW (Big Bear)	87-93	CK2290	CKF2290	CSK58	DRC33	DRCF33			CT008
YFM 350 FW (Big Bear)	94-97	CK2290	CKF2290	CSK49	DRC82				CT090SP
YFM 350 FWB (Big Bear)	99	CK2240		CSK81	DRC228				CT008
YFM 350 FX Wolverine	95-05	CK2240		CSK81	DRC228				CT008
YFM 350 U	96-99	CK2290	CKF2290	CSK49	DRC82				CT090SP
YFM 350 X (Warrior)	87-04	CK2290	CKF2290	CSK58	DRC33	DRCF33			CT090SP
YFM 350 R Raptor	04-13	CK2290	CKF2290	CSK58	DRC33	DRCF33			CT090SP
YFZ 350 (Banshee)	87-06	CK2279	CKF2279	CSK2	DRC43	DRCF43			CT008
YFP 350 U (Terrapro)	88	CK2279	CKF2279	CSK58					CT008
FZR 400 U/W/SUC/SWC/A/SAC	88-90	CK2317		CSK185			SRC6	SRK6	CT010
RD 400 C/D/E	76-78	CK2240		CSK2					CT008
RD 400 F Daytona	79	CK2240		CSK2					CT008
SR 400 F	14	CK2296		CSK2					CT008
XS 400 G/SG/H/SH/SJ	80-82	CK2279	CKF2279	CSK2					CT008
XS 400 J/K/RJ/RK	82-83	CK2262		CSK2					CT017
YFM 400 FW Kodiak	93-99	CK2290	CKF2290	CSK49	DRC82				CT090SP
YFM 400 FWN Big Bear 4WD/Real Tree Xtra	00-01	CK2240		CSK81	DRC228				CT008
YFM 400 NM/NMC/NN/NHN/P/HP Big Bear 2WD	00-03	CK2240		CSK81	DRC228				CT008
YFM 400 FWR (4x4) Big Bear	03	CK2290	CKF2290	CSK49	DRC82				CT008
YFM 400 S Big Bear 2WD	04	CK2240		CSK81	DRC228				CT008
YFM 400 F Big Bear 4WD	04-05	CK2240		CSK81	DRC228				CT008
YFM 400 FB Big Bear 4WD IRS	08-12	CK2240		CSK81	DRC228				CT008
YFM 400 FBHW Big Bear 400 Hunter-IRS	07	CK2240		CSK81	DRC228				CT008
YFM 400 FBEW Big Bear 400 IRS Exploring Edition	07	CK2240		CSK81	DRC228				CT008
WR 400 F	98-00	CK2310		CSK49	DRC99				CT008
YZ 400 F	98-99	CK2310		CSK181	DRC265				CT008
IT 425 G	80	CK2279	CKF2279	CSK2					CT008
WR 426 F	01-02	CK2356		CSK62	DRC110				CT020
YZ 426 F	00	CK2352		CSK181	DRC102				CT020
YZ 426 F	01-Feb	CK2356		CSK92	DRC116				CT020
WR 450 F	03	CK2356		CSK62	DRC110				CT020
WR 450 F	04	CK2352		CSK62	DRC263				CT020
WR 450 F	05-15	CK2274	CKF2274	CSK92	DRC194				CT020
WR 450 F	16-21	CK2274	CKF2274	CSK37	DRC298	DRCF298			CT020
YFZ 450 S/T/V	04-06	CK2364	CKF2364	CSK187	DRC159	DRCF159			CT020
YFZ 450 W/X/Y	07-09	CK2364	CKF2364	CSK58	DRC201	DRCF201			CT020
YFZ 450 B/D	12-13	CK2364	CKF2364	CSK92					CT020
YFZ 450 LES Limited Edition	04	CK2364	CKF2364	CSK187	DRC159	DRCF159			CT020

CLUTCH APPLICATIONS

EBC BRAKES CLUTCH KITS



YAMAHA



		CK cork OEM style Kit #	CKF carbon fiber style upgrade Kit #	CSK Spring Kit #	DRC Series Kit #	DRCF Series Kit #	SRC Series Kit #	SRK Series Kit #	CT Tool #
YFZ 450 BB Bill Balance Edition	06	CK2364	CKF2364	CSK187	DRC159	DRCF159			CT020
YFZ 450 BB Bill Balance Edition	07	CK2274		CSK58					CT020
YFZ 450 SET/SPV Special Edition	05-06	CK2364	CKF2364	CSK187	DRC159	DRCF159			CT020
YFZ 450 SEW/SPX Special Edition	07-08	CK2364	CKF2364	CSK58	DRC201	DRCF201			CT020
YFZ 450 R R	09-13	CK2274	CKF2274	CSK58					CT020
YFZ 450 R (3 Spring Clutch - YFZ 450 RE)	14	CK2364		CSK272					
YFZ 450 R Special Edition (3 Spring Clutch - YFZ 450 RSE)	14	CK2364		CSK272					
YFZ 450 R	14-21	CK2389		CSK272	DRC322				TBA
YZ 450 F	03-04	CK2352		CSK92	DRC121				CT020
YZ 450 F	05-06	CK2352		CSK58	DRC162				CT020
YZ 450 F (4T)	07-13	CK2274	CKF2274	CSK37	DRC195	DRCF195			CT020
YZ 450 F (4T)	14-21	CK2274	CKF2274	CSK213	DRC287	DRCF287			CT020
IT 465 H/J	81-82	CK2279	CKF2279	CSK2					CT008
YZ 465 G/H	80-81	CK2279	CKF2279	CSK2					CT008
IT 490 K/L	83-84	CK2280		CSK2	DRC32				CT060
YZ 490 J/K/L/N/S/T/U/W	82-89	CK2280		CSK2	DRC32				CT060
SR 500 E/F/G/H	78-81	CK2296		CSK14					CT008
TT 500 G/H	80-81	CK2255		CSK14					CT008
WR 500 Z	92-93	CK2280		CSK2	DRC32				CT060
XP 500 T-Max (5GJ5)	01	CK2378		CSK189					
XP 500 T-Max (5VUA/15B1)	05-08	CK2378		CSK189					
XP 500 T-Max (4B51)	09-11	CK2378		CSK189					
XT 500 G/H	80-81	CK2296		CSK14					CT008
XV 500 K Virago	83	CK2299		CSK91					CT020
T Max 530 ABS	12-19	CK2382		CSK267	DRC284				
T Max 530 DX ABS	17-19	CK2382		CSK267	DRC284				
T Max 530 SX ABS	17-19	CK2382		CSK267	DRC284				
T Max 530 Black Max ABS	13	CK2382		CSK267	DRC284				
T Max 530 Bronze Max ABS	14	CK2382		CSK267	DRC284				
T Max 530 Iron Max ABS	15	CK2382		CSK267	DRC284				
XV 535 Virago	87-99	CK2299		CSK91					CT020
XJ 550 H/J/K Maxim	81-83	CK2306		CSK14					CT008SP
XJ 550 R Seca	81-83	CK2306		CSK14					CT008SP
XT 550 J	82	CK2306		CSK14					CT008
XT 550 K	83	CK2297	CKF2297	CSK14					CT008
XZ 550 R/J/RK Vision	82-83	CK2296		CSK14					CT008
FJ 600 L/N	84-85	CK2255		CSK14					CT008SP
FZ 600 S/SC/T/TC/UC/U	86-88	CK2255		CSK14					CT008SP
FZR 600 W/R/A/H	89-99	CK2315		CSK185			SRC7	SRK7	CT010
FZ6	04-09	CK2255		CSK17			SRC51	SRK51	CT008SP
FZ6R (FZS 6 Y/Z/A/B/D/E)	09-14	CK2306		CSK17					CT008SP
YZF 600 R	95-07	CK2332		CSK102			SRC33	SRK33	CT054SP
YZF 600 R/RR/PC R6	99-02	CK2255		CSK17			SRC51	SRK51	CT008SP
YZF-R6 RR/T	03-05	CK2255		CSK92			SRC74	SRK74	CT008SP
YZF-R6 V/W/X/Y/Z/A/B/D/E/F/G	06-17	CK2318		CSK126			SRC87	SRK87	CT008SP
YZF-R6	18-21	CK2358		CSK126			SRC160	SRK160	CT008SP
YZF-R6 S	06-09	CK2255		CSK92			SRC74	SRK74	CT008SP
SRX 600 S	86	CK2297	CKF2297	CSK14			SRC72	SRK72	CT008
TT 600 K/L/N/S	83-86	CK2297	CKF2297	CSK2	DRC57				CT008
XJ 600 SD/SE/SF/SG/SH/SJ/SK Seca 11	92-98	CK2255		CSK14					CT008SP
XT 600 L/LC/N/NC/S/SC/T/TC/U/UC/W/WC	84-89	CK2297	CKF2297	CSK2	DRC57				CT008
XT 600 E	90-95	CK2297	CKF2297	CSK14	DRC88	DRCF88			CT008
YX 600 S/SC/T/TC/U/UC/W/WC/A/AC	86-90	CK2255		CSK14					CT008SP
XJ 650 G/H/J/K Maxim	80-83	CK2255		CSK81					CT008SP
XJ 650 LH Midnight	81	CK2255		CSK81					CT008SP
XJ 650 LJ/LK Seca Turbo	82-83	CK2255		CSK14					CT008SP
XJ 650 RJ Seca	82	CK2255		CSK81					CT008SP

CLUTCH
APPLICATIONS

EBC BRAKES CLUTCH KITS



YAMAHA



		CK cork OEM style Kit #	CKF carbon fiber style upgrade Kit #	CSK Spring Kit #	DRC Series Kit #	DRCF Series Kit #	SRC Series Kit #	SRK Series Kit #	CT Tool #
TX 650 A/XS 650 B/C	74-76	CK2226		CSK2					CT074
XS 650 D/E/F/2F	77-79	CK2226		CSK2					CT074
XS 650 SG/G/H/SH/SJ/SK	80-83	CK2242		CSK14					CT074
XVS 650 V-Star Custom	97-11/13-14	CK2309		CSK91					CT020
XVS 650 V-Star Classic	98-10	CK2309		CSK91					CT020
XVS 650 V-Star Silverado	03-10	CK2309		CSK91					CT020
YFM 660 R Raptor	01-05	CK2297	CKF2297	CSK14	DRC88	DRCF88			CT008
FZ 700 T/TC	87	CK2306		CSK17					CT008SP
FZX 700 S/SC/T/TC	86-87	CK2255		CSK17			SRC51	SRK51	CT008SP
FZ-07 (689cc/2Cyl)	15-16	CK2309		CSK37					CT0
MT-07	14-21	CK2309		CSK37			SRC125	SRK125	CT020
MT-07 ABS	14-21	CK2309		CSK37			SRC125	SRK125	CT020
XJ 700 N/NC/S/SC Maxim	85-86	CK2255		CSK37					CT008SP
XJ 700 XN/XS Maxim	85-86	CK2255		N/A					CT008SP
XV 700 L/N Virago	84-85	CK2274	CKF2274	CSK81					CT020
XV 700 CS/CSC/SS/ST/STC/CT/CTC/SSC Virago	86-87	CK2274	CKF2274	CSK81					CT020
YFM 700 R Raptor	06-14	CK2364	CKF2364	CSK37	DRC128	DRCF128			CT020
YFM 700 RSPV Raptor 50th Anniversary Edition	06	CK2364	CKF2364	CSK37	DRC128	DRCF128			CT020
YFM 700 RS Raptor Special Edition	07-14	CK2364	CKF2364	CSK37	DRC128	DRCF128			CT020
FZ 750 N	85	CK2255		CSK17			SRC51	SRK51	CT008SP
FZ 750 S/SC	86	CK2255		CSK17			SRC51	SRK51	CT008SP
FZ 750 U/JC	88	CK2306		CSK17					CT008SP
FZR 750 R	87-88	CK2308		CSK17			SRC8	SRK8	CT008SP
FZR 750 OW01	89-91	CK2318		CSK17			SRC9	SRK9	CT008SP
XJ 750 J/K/MK Maxim	82-83	CK2255		CSK14					CT008SP
XJ 750 R Seca	81-83	CK2255		CSK14					CT008SP
XS 750 D/2D/E/F/SE/SF	77-79	CK2279	CKF2279	CSK14					CT008SP
XV 750 H/J/K/MK Virago	81-83	CK2274	CKF2274	CSK81					CT020
XV 750 U/UC/W/WCM Virago	88-89	CK2274	CKF2274	CSK81					CT020
XV 750 A/AC/B/BC Virago	90	CK2274	CKF2274	CSK81					CT020
XV 750 D/DC/E/EC/F/FC/G/GC/HI/HCI/J/JC Virago	92-97	CK2274	CKF2274	CSK81					CT020
YZF 750 SP/RF/RFC/RG/RGC/RH/RHC	94-96	CK2318		CSK17			SRC9	SRK9	CT008SP
YZF 750 R7 OW02	99-01	CK2353		N/A					CT020
FZ8	11-13	CK2364	CKF2364	CSK119					CT020
XS 850 G/H/LG/LH/SG/SH	80-81	CK2273		CSK14					CT008SP
TDM 850 D/DC/E/EC	92-93	CK2255		CSK17			SRC51	SRK51	CT008SP
FJ-09	15-16	CK2352		CSK119					CT020
FZ-09 (6 Spring clutch)	14-16	CK2352		CSK119					CT020
FZ-09 (3 Spring clutch)	17	TBA		TBA					
MT-09 Tracer ABS (847cc/3 Cyl Engine)	15-21	CK2352	CKF2352	CSK119			SRC124	SRK124	CT020
MT-09A (2DR/ABS/847cc/3 Cyl Engine)	14-21	CK2352	CKF2352	CSK119			SRC124	SRK124	CT020
MT-09A Sport Tracker ABS (847cc/3 Cyl Engine)	14-21	CK2352	CKF2352	CSK119			SRC124	SRK124	CT020
MT-09A Street Rally ABS (847cc/3 Cyl Engine)	14-21	CK2352	CKF2352	CSK119			SRC124	SRK124	CT020
XJ 900 RK Seca	83	CK2255		CSK49					CT008SP
XSR 900 ABS (MTM850)	16-21	CK2388					SRC162	SRK162	
XV 920 R	81-82	CK2274	CKF2274	CSK14					CT020
XV 920 J/K/MK Virago	82-83	CK2274	CKF2274	CSK14					CT020
XVS 950 (V-Star 950)	09-14	CK2379		CSK911					CT017
XVS 950 (V-Star 950 Tourer)	09-14	CK2379		CSK911					CT017
XVS 950 Bolt (Standard Rear Shocks)	14-16	CK2379		CSK911					CT017
XVS 950 Bolt C-Spec (Remote Rear Shocks)	15-16	CK2379		CSK911					CT017
XVS 950 Bolt R-Spec (Remote Rear Shocks)	14-16	CK2379		CSK911					CT017
FZR 1000 T/U Genesis	87-88	CK2308		CSK17			SRC8	SRK8	CT008SP
FZR 1000 W/WC/A/AC/B/BC/D/DC	89-92	CK2321		CSK37			SRC31	SRK31	CT008SP
FZR 1000 E/EC/F/FC/G/GC	93-95	CK2327		CSK37			SRC29	SRK29	CT008SP
FZ1-FZS 1000 N/P/R/S/T	01-05	CK2358		CSK37					CT008SP
FZ1-FZS 1000 VW/X/Y/Z/A/B/D/E	06-14	CK2356		CSK119			SRC77	SRK77	CT020

CLUTCH APPLICATIONS

EBC BRAKES CLUTCH KITS



YAMAHA



		CK cork OEM style Kit #	CKF carbon fiber style upgrade Kit #	CSK Spring Kit #	DRC Series Kit #	DRCF Series Kit #	SRC Series Kit #	SRK Series Kit #	CT Tool #
FZ-10	17	CK4510		CSK218			SRC129	SRK129	CT079SP
GTS 1000 A	93-94	CK2327		CSK17					CT008SP
XV 1000 L/N Virago	84-85	CK2274	CKF2274	CSK14					CT020
YZF 1000 R (R.J)	97	CK2327		CSK37			SRC29	SRK29	CT008SP
YZF 1000 R1	98	CK2226		CSK903			SRC56	SRK56	CT017
YZF 1000 R1	99-03	CK2350		CSK903			SRC65	SRK65	CT017
YZF R1 (5VY)	04-06	CK2356		CSK119			SRC77	SRK77	CT020
YZF R1 LE	06	CK2356		CSK211			SRC93	SRK93	CT020
YZF R1 (6 piston caliper)	07-08	CK2356		CSK211			SRC93	SRK93	CT020
YZF R1 (6 piston caliper)	09-14	CK2352		CSK211			SRC96	SRK96	CT020
YZF R1	15-21	CK4510		CSK218			SRC129	SRK129	CT079SP
YZF R1 M	15-21	CK4510		CSK218			SRC129	SRK129	CT079SP
YZF R1 S	16	CK4510		CSK218			SRC129	SRK129	CT079SP
FJ 1100 L/LC/N/NC	84-85	CK2285		CSK903					CT017
XJ 1100 J Maxim	82	CK2230		CSK14					CT017
XS 1100	82	CK2230		CSK14					CT077SP
XS 1100 H Venturer	82	CK2230		CSK14					CT077SP
XS 1100 SF/SG/SH	82	CK2230		CSK14					CT077SP
XS 1100 LG/LH Midnight Special	82	CK2230		CSK14					CT077SP
XV 1100 S/T/U/W/A/B/D/E/F/G/H/SH/J/SJ Virago	86-97	CK2274	CKF2274	N/A					CT020
XVS 1100 V-Star Custom	99-08	CK2274	CKF2274	N/A					CT020
XVS 1100 V-Star Classic	01-09	CK2274	CKF2274	N/A					CT020
XVS 1100 ATS V-Star Silverado	03-09	CK2274	CKF2274	N/A					CT020
XVS 1100 W-M V-Star Custom Midnight	07	CK2274	CKF2274	N/A					CT020
FJ 1200 S/T/U/W/A/B/AD/D/AE	86-94	CK2285		CSK903					CT017
V-Max VMX 12 N/NC	85	CK2300		CSK906					CT050SP
V-Max VMX 12 S/SC	86	CK2300		CSK906					CT050SP
VMX 12 (V-Max 1200 All Models)	88-07	CK2300		CSK906					CT050SP
XT 1200 Z Super Tenere	12-13	CK2362		CSK903			SRC131	SRK131	CT017
XVZ 12 TK Venture	83	CK2300		CSK46					CT050SP
XVZ 12 TDK Venture Royale	83	CK2300		CSK46					CT050SP
XVZ 12 L/KC2 Venture	84	CK2300		CSK46					CT050SP
XVZ 12 DL/DKC2 Venture Royale	84	CK2300		CSK46					CT050SP
XVZ 12 DN Venture Royale	85	CK2300		CSK46					CT050SP
FJR 1300 R/RC/S/AS/T/AT	03-05	CK2362		CSK903			SRC131	SRK131	CT017
FJR 1300 A	06-15	CK2362		CSK903			SRC131	SRK131	CT017
FJR 1300 AE (Electric Gear shift Model)	06-09	CK2362		N/A			N/A	N/A	CT017
FJR 1300 ES	14-15	TBA		TBA					
XVS 1300 V-Star	07-14	CK2362		CSK903			SRC131	SRK131	CT017
XVS 1300 V-Star De Luxe	13-14	CK2362		CSK903			SRC131	SRK131	CT017
XVS 1300 V-Star Tourer	07-14	CK2362		CSK903			SRC131	SRK131	CT017
XVS 1300 Stryker	11-14	CK2362		CSK903			SRC131	SRK131	CT017
XVZ 13 DS/DSC Venture	86	CK2300		CSK906					CT050SP
XVZ 13 T/TC Venture	87-88	CK2300		CSK906					CT050SP
XVZ 13 D Venture Royale	86-89	CK2300		CSK906					CT050SP
XVZ 13 D Venture Royale	92-93	CK2300		CSK906					CT050SP
XVZ 1300 Royal Star	96-97/00	CK2300		CSK906					CT050SP
XVZ 1300 Royal Star Boulevard	99-01	CK2300		CSK906					CT050SP
XVZ 1300 Royal Star Midnight Venture	02-07	CK2300		CSK906					CT050SP
XVZ 1300 Royal Star Standard	98	CK2300		CSK906					CT050SP
XVZ 1300 Royal Star Tour Classic	96-00	CK2300		CSK906					CT050SP
XVZ 1300 Royal Star Tour Deluxe	97-01/05-07	CK2300		CSK906					CT050SP
XVZ 1300 Royal Star Venture	99-07	CK2300		CSK906					CT050SP
XVZ 1300 Royal Star Venture S	08-13	CK2300		CSK906					CT050SP
XVZ 1300 CTM Royal Star Midnight Tour Deluxe	06-07	CK2300		CSK906					CT050SP
XVZ 1300 LTK Venture	96-98	CK2300		CSK906					CT050SP
XVZ 1300 Venture MM Limited Edition	01	CK2300		CSK906					CT050SP

CLUTCH
APPLICATIONS

EBC BRAKES CLUTCH KITS



YAMAHA



		CK cork OEM style Kit #	CKF carbon fiber style upgrade Kit #	CSK Spring Kit #	DRC Series Kit #	DRCF Series Kit #	SRC Series Kit #	SRK Series Kit #	CT Tool #
XV 1600 Road Star	99-05	CK2351		CSK906					CT050SP
XV 1600 Road Star Silverado	99-09	CK2351		CSK906					CT050SP
XV 1600 Road Star Midnight	03	CK2351		CSK906					CT050SP
XV 1600 Midnight Star	02-03	CK2351		CSK906					CT050SP
VMX 1700 V-Max (6 piston radial caliper)	09-16	CK2380		CSK903					CT017
XV 1700 Road Star (9 Spoke Cast wheels - XV17 AS/AW)	04/07/2009	CK2351		CSK906					CT050SP
XV 1700 Road Star (9 Spoke Cast wheels - XV17 AWX)	08	CK2363		CSK906					CT050SP
XV 1700 Road Star (Spoke wheel / Solid Front Discs - XV17 ATW)	05-07	CK2351		CSK906					CT050SP
XV 1700 Road Star S (9 Spoke Cast wheels - XV17 AS)	08-13	CK2363		CSK906					CT050SP
XV 1700 Road Star Midnight (9 Spoke Cast Wheels - XV17 AM)	04-07	CK2351		CSK906					CT050SP
XV 1700 Road Star Midnight Warrior (3 Spoke Cast Wheels - XV17 PCT)	05	CK2351		CSK906					CT050SP
XV 1700 Road Star Midnight Warrior (5 Spoke Cast Wheels - XV17 PCM)	06-09	CK2363		CSK906					CT050SP
XV 1700 Road Star Midnight Silverado (9 Spoke Cast wheels - XV17 ATM)	04-07	CK2351		CSK906					CT050SP
XV 1700 Road Star (Spoke wheel / Solid Front Discs - XV17 ATW)	05-07	CK2351		CSK906					CT050SP
XV 1700 Road Star Silverado (Spoke Wheel - XV17 AT)	07	CK2363		CSK906					CT050SP
XV 1700 Road Star Silverado (Spoke Wheel - XV17 AT)	08-10	CK2363		CSK906					CT050SP
XV 1700 Road Star Silverado S (9 Spoke Cast Wheel - XV17 ATS)	11-13	CK2363		CSK906					CT050SP
XV 1700 Road Star Warrior (3 Spoke Cast Wheels - XV17 PC)	04-05	CK2363		CSK906					CT050SP
XV 1700 Road Star Warrior (5 Spoke Cast Wheels - XV17 PC)	06-08	CK2363		CSK906					CT050SP
XV 1900 Roadliner	06-07	CK2367		CSK903					CT017
XV 1900 M Roadliner Midnight	06-09	CK2367		CSK903					CT017
XV 1900 Roadliner S (Diaphragm Spring Clutch)	06/10/2012	CK2367		CSK903					CT017
XV 1900 Roadliner S (3 Spring Clutch)	13-14	TBA		TBA					
XV 1900 Raider (Diaphragm Spring Clutch)	08-12	CK2367		TBA					CT017
XV 1900 Raider S (Diaphragm Spring Clutch)	08-12	CK2367		TBA					CT017
XV 1900 Raider SCL (Diaphragm Spring Clutch)	12	CK2367		TBA					CT017
XV 1900 Raider (3 Spring Clutch)	13-14	TBA		TBA					
XV 1900 Raider S (3 Spring Clutch)	13-14	TBA		TBA					
XV 1900 Raider SCL (3 Spring Clutch)	13-14	TBA		TBA					
XV 1900 Stratoliner	06-09	CK2367		CSK903					CT017
XV 1900 Stratoliner Midnight	06-08	CK2367		CSK903					CT017
XV 1900 Stratoliner S (Diaphragm Spring Clutch)	07-13	CK2367		CSK903					CT017
XV 1900 Stratoliner Deluxe (Diaphragm Spring Clutch)	11-12	CK2367		CSK903					CT017
XV 1900 Stratoliner S (3 Spring Clutch)	13-14	TBA		TBA					
XV 1900 Stratoliner Deluxe (3 Spring Clutch)	13-14	TBA		TBA					
ARCTIC CAT (NOTE MANUAL GEARBOX MODELS ONLY)									
250 (2 x 4 / 4 x 4)	01-04	CK3390		CSK48	DRC89				CT011
250 (2 x 4 / 4 x 4)	05	CK3390		CSK48	DRC89				CT011
300 (2 x 4 / 4 x 4)	98-04	CK3356		CSK48	DRC103				CT011
300 (4 x 4)	05	CK3356		CSK48	DRC103				CT011
400 (2 x 4 / 4 x 4)	98-	CK4439		CSK88	DRC215				CT006
400 (2 x 4)	98	CK4439		CSK88	DRC214				CT006
400 (2 x 4 / 4 x 4)	00-02	CK4419		CSK88	DRC215				CT006
400 (2 x 4 / 4 x 4)	03-04	CK4439		CSK98	DRC120				CT006
400 (4 x 4 Manual)	05-08	CK4439		CSK98	DRC120				CT006
400 DVX	04-07	CK3433	CKF3433	CSK79	DRC105	DRCF105			CT006
400 DVX	07-08	CK3447	CKF3447	CSK79	DRC137	DRCF137			CT006
Bearcat 454 (4 x 4)	96-98	CK4439		CSK88	DRC216				CT006
Bearcat 454 (2 x 4)	97-98	CK4439		CSK88	DRC216				CT006
500 (4 x 4)	98-02	CK4439		CSK88	DRC214				CT006
500 (4 x 4 Manual)	03-04	CK3452		CSK7	DRC216				CT006
500 (Manual 4x4)	05-09	CK3452		CSK7	DRC216				CT006

CLUTCH APPLICATIONS

EBC BRAKES CLUTCH KITS



AJP



		CK cork OEM style Kit #	CKF carbon fiber style upgrade Kit #	CSK Spring Kit #	DRC Series Kit #	DRCF Series Kit #	SRC Series Kit #	SRK Series Kit #	CT Tool #
PR5 TR	13-17	CK1318		CSK226	DRC300				CT091
PR5 SM	13-17	CK1318		CSK226	DRC300				CT091
PR5 EN	13-17	CK1318		CSK226	DRC300				CT091
PR5 EX	13-17	CK1318		CSK226	DRC300				CT091

APRILIA

RSV 1000 R Factory/R	04-08	CK6680		CSK200					
RSV4 R	10-12	CK6681		CSK184			SRC113	SRK113	CT041
RSV4 Factory	09-12	CK6681		CSK184			SRC113	SRK113	CT041
RSV4 Factory APRC	11-12	CK6681		CSK184			SRC113	TBA	CT041
RSV4 APRC	11-12	CK6681		CSK184			SRC113	TBA	CT041

BENELLI

TNT 600 i Tornado	16-17	CK1230		CSK241			SRC141	SRK141	CT014SP
-------------------	-------	--------	--	--------	--	--	--------	--------	---------

BETA

Enduro RR 250 2T	18-20	CK5672							
Enduro RR 300 2T	18-20	CK5672							
Enduro RR 350 4T	18-20	CK5672							
Enduro RR 390 4T	18-20	CK5672							
Enduro RR 400 4T	10-15	CK2364			DRC333				
Enduro RR 430 4T	18-20	CK5672							
Enduro RR 450 4T	10-15	CK2364			DRC333				
Enduro RR 480 4T	18-20	CK5672							

BMW

G 310 GS	17-21	CK1253		CSK249			SRC151	SRK151	CT013
G 310 R	17-21	CK1253		CSK249			SRC151	SRK151	CT013
F 650 (E169/0161)	09/93-96	CK5605		CSK104					
F 650 (E169/0162/Funduro/High Screen/19" Front Wheel)	97-00	CK5605		CSK104					
F 650 CS Scarver (K14/0174/0184/Belt Drive/17" Front Wheel)	00-03	CK5636		CSK104					
F 650 CS Scarver (K14/0177/0187/Belt Drive/17" Front Wheel)	04-Jul	CK5636		CSK104					
F 650 GS Dakar (R13/0173/0183/21" Front Wheel)	99-03	CK5636		CSK104					
F 650 GS Dakar (R13/0176/0186/21" Front Wheel)	04-07	CK5635		CSK104					
F650 GS (Late type plates 2 x 13mm/7 x 14mm ears)	07-19	CK5660		CSK240			SRC130	SRK130	CT085
F 650 ST (E169/163/168/Strada/18" Front Wheel)	97-00	CK5605		CSK104					
G 650 GS (R13)	08-16	CK5635		CSK133			SRC145	SRK145	CT083
G 650 GS Sertao (R13)	10-14	CK5635		CSK133			SRC145	SRK145	CT083
G 650 XCountry (K15)	08-10	CK5635		CSK133			SRC145	SRK145	CT083
F700 GS (Late type plates 2 x 13mm/7 x 14mm ears)	11-19	CK5660		CSK240			SRC130	SRK130	CT085
F 750 GS (OB08, OB018, OB28 & OB38)	16-22	CK5685		CSK271			SRC170	SRK170	TBA
F800 S (Early type plates 14mm ears)	08-11	CK5667		CSK240			SRC144	SRK144	CT085
F800 GS (Late type plates 2 x 13mm/7 x 14mm ears)	12-19	CK5660		CSK240			SRC130	SRK130	CT085
F800 GS Adventure (Late type plates 2x13mm/7x14mm ears)	12-19	CK5660		CSK240			SRC130	SRK130	CT085
F800 GT (Early type plates 14mm ears)	04-06	CK5667		CSK240			SRC144	SRK144	CT085
F800 GT (Late type plates 2 x 13mm/7 x 14mm ears)	07-19	CK5660		CSK240			SRC130	SRK130	CT085
F800 S (Early type plates 14mm ears)	04-06	CK5667		CSK240			SRC144	SRK144	CT085
F800 S (Late type plates 2 x 13mm/7 x 14mm ears)	07-19	CK5660		CSK240			SRC130	SRK130	CT085
F800 ST (Early type plates 14mm ears)	04-06	CK5667		CSK240			SRC144	SRK144	CT085
F800 ST (Late type plates 2 x 13mm/7 x 14mm ears)	07-19	CK5660		CSK240			SRC130	SRK130	CT085
F800 R (Late type plates 2 x 13mm/7 x 14mm ears)	05-17	CK5660		CSK240			SRC130	SRK130	CT085
F 850 GS (OB09, OB019, OB29 & OB39) Inc Adventure models	16-22	CK5685		CSK271			SRC170	SRK170	TBA
R 1200 GS	19-21	CK5676		TBA			SRC165	SRK165	
R 1200 GS Adventure	19-21	CK5676		TBA			SRC165	SRK165	
R 1200 R	19-21	CK5676		TBA			SRC165	SRK165	
R 1200 RS	19-21	CK5676		TBA			SRC165	SRK165	
R 1250 GS	19-21	CK5676		TBA			SRC165	SRK165	

CLUTCH APPLICATIONS

EBC BRAKES CLUTCH KITS



BMW



		CK cork OEM style Kit #	CKF carbon fiber style upgrade Kit #	CSK Spring Kit #	DRC Series Kit #	DRCF Series Kit #	SRC Series Kit #	SRK Series Kit #	CT Tool #
R 1250 GS TE	19-21	CK5676		TBA			SRC165	SRK165	
R 1250 GS Rallye	19-21	CK5676		TBA			SRC165	SRK165	
R 1250 GS Rallye TE	19-21	CK5676		TBA			SRC165	SRK165	
R 1250 GS Adventure	19-21	CK5676		TBA			SRC165	SRK165	
R 1250 GS Adventure TE	19-21	CK5676		TBA			SRC165	SRK165	
R 1250 GS Adventure Rallye	19-21	CK5676		TBA			SRC165	SRK165	
R 1250 GS Adventure Rallye TE	19-21	CK5676		TBA			SRC165	SRK165	
K 1300 GT	08-11	CK5682							
K 1300 R	08-12	CK5682							
K 1300 S	08-16	CK5682							

DUCATI

Monster 620 ie	01-06	CK5675							
899 Panigale	13-15	CK5661							
959 Panigale	17-20	CK5670							

HARLEY-DAVIDSON® DYNA

FLD 103 Switchback	12-16	CK7008		CSK916			SRC7012	SRK7012	CT703SP
FLD Dyna Switchback	12-21	CK7008		CSK916			SRC7013	SRK7013	CT703SP
FLDE Deluxe	18	TBA		CSK236			TBA	TBA	
FXB Super Glide B80	81-82	CK7012		CSK255			SRC7018	SRK7018	CT704SP
FXD Super Glide	98-03	CK7008		CSK917			SRC7011	SRK7011	CT703SP
FXD Super Glide	95-97	CK7009		TBA			SRC7019	SRK7019	CT701SP
FXD Super Glide	04-05	CK7008		CSK916			SRC7012	SRK7012	CT703SP
FXD Super Glide	07-10	CK7008		CSK915			SRC7013	SRK7013	CT703SP
FXD 35th Anniversary Super Glide	06	CK7008		CSK915			SRC7013	SRK7013	CT703SP
FXDB 103 Street Bob	14-17	CK7008		CSK916			SRC7012	SRK7012	CT703SP
FXDB Daytona	92	CK7009		TBA			SRC7019	SRK7019	CT701SP
FXDB Dyna Street Bob	07-21	CK7008		CSK915			SRC7013	SRK7013	CT703SP
FXDB Sturgis	91	CK7009		TBA			SRC7019	SRK7019	CT701SP
FXDBA 103 Street Bob (H-D1)	13-15	CK7008		CSK916			SRC7012	SRK7012	CT703SP
FXDBA Street Bob (H-D1)	13-15	CK7008		CSK915			SRC7013	SRK7013	CT703SP
FXDBC 103 Street Bob Limited	16	CK7008		CSK916			SRC7012	SRK7012	CT703SP
FXDBC Street Bob Limited	16	CK7008		CSK915			SRC7013	SRK7013	CT703SP
FXDBI Street Bob	6	CK7008		CSK915			SRC7013	SRK7013	CT703SP
FXDBP 103 Dyna Street Bob	16	CK7008		CSK916			SRC7012	SRK7012	CT703SP
FXDC 103 Super Glide Custom	14	CK7008		CSK916			SRC7012	SRK7012	CT703SP
FXDC Super Glide Custom	5	CK7008		CSK916			SRC7012	SRK7012	CT703SP
FXDC Super Glide Custom	07-14	CK7008		CSK915			SRC7013	SRK7013	CT703SP
FXDC Super Glide Custom	92	CK7009		TBA			SRC7019	SRK7019	CT701SP
FXDC ANV Super Glide Custom Anniversary	13	CK7008		CSK915			SRC7013	SRK7013	CT703SP
FXDCI Super Glide Custom	05-06	CK7008		CSK915			SRC7013	SRK7013	CT703SP
FXDF 103 Fat Bob	12-17	CK7008		CSK916			SRC7012	SRK7012	CT703SP
FXDF Fat Bob	08-17	CK7008		CSK915			SRC7013	SRK7013	CT703SP
FXDG Super Glide Custom	83	CK7012		CSK255			SRC7018	SRK7018	CT704SP
FXDI Super Glide	04-06	CK7008		CSK915			SRC7013	SRK7013	CT703SP
FXDL 103 Low Rider	14-16	CK7008		CSK916			SRC7012	SRK7012	CT703SP
FXDL 103 Low Rider	17	CK7008		CSK916			SRC7012	SRK7012	CT703SP
FXDL Low Rider	93-97	CK7009		TBA			SRC7019	SRK7019	CT701SP
FXDL Low Rider	98-03	CK7008		CSK917			SRC7011	SRK7011	CT703SP
FXDL Low Rider	04-05	CK7008		CSK916			SRC7012	SRK7012	CT703SP
FXDL Dyna Low Rider	06-21	CK7008		CSK915			SRC7013	SRK7013	CT703SP
FXDLI Low Rider	04-08	CK7008		CSK916			SRC7012	SRK7012	CT703SP
FXDLS Low Rider S	16-21	CK7008		CSK914			SRC7009	SRK7009	CT703SP
FXDS Glide Convertible	93	CK7009		TBA			SRC7019	SRK7019	CT701SP
FXDS Glide Convertible	99-00	CK7008		CSK917			SRC7011	SRK7011	CT703SP
FXDWG 103 Wide Glide	12-17	CK7008		CSK916			SRC7012	SRK7012	CT703SP

CLUTCH APPLICATIONS

Part numbers, prefixes, suffixes, photos and illustrations shown in this catalog are trademarks and/or copyrights of EBC Brakes or the trademark owner A C Freeman Investments Ltd and use without express written permission of the owners is punishable by law.

EBC BRAKES CLUTCH KITS



HARLEY-DAVIDSON® DYNA



		CK cork OEM style Kit #	CKF carbon fiber style upgrade Kit #	CSK Spring Kit #	DRC Series Kit #	DRCF Series Kit #	SRC Series Kit #	SRK Series Kit #	CT Tool #
FXDWG Wide Glide	93-97	CK7009		TBA			SRC7019	SRK7019	CT701SP
FXDWG Wide Glide	98-05	CK7008		CSK917			SRC7011	SRK7011	CT703SP
FXDWG Wide Glide	07-16	CK7008		CSK915			SRC7013	SRK7013	CT703SP
FXDWG Wide Glide 105th Anniversary	08	CK7008		CSK915			SRC7013	SRK7013	CT703SP
FXDWGI Wide Glide	04-05	CK7008		CSK916			SRC7012	SRK7012	CT703SP
FXDWGI Wide Glide	06	CK7008		CSK915			SRC7013	SRK7013	CT703SP
FXDX Super Glide Sport	99-03	CK7008		CSK917			SRC7011	SRK7011	CT703SP
FXDX Super Glide Sport	04-05	CK7008		CSK916			SRC7012	SRK7012	CT703SP
FXDXT Super Glide T-Sport	01-03	CK7008		CSK917			SRC7011	SRK7011	CT703SP
FXE Super Glide	81-84	CK7012		CSK255			SRC7018	SRK7018	CT704SP
FXE Super Glide	84	CK7010		TBA			SRC7016	SRK7016	CT705SP
FXEF Super Glide Fat Bob	81	CK7012		CSK255			SRC7018	SRK7018	CT704SP
FXEF Super Glide Fat Bob	85	CK7010		TBA			SRC7016	SRK7016	CT705SP
FXWG Wide Glide	81-84	CK7012		CSK255			SRC7018	SRK7018	CT704SP
FXWG Wide Glide	84-86	CK7010		TBA			SRC7016	SRK7016	CT705SP

HARLEY-DAVIDSON® SOFTAIL

FXBB Street Bob	18	TBA		CSK236			TBA	TBA	
FXBR Breakout	18-21	TBA		CSK236			TBA	TBA	
FXBRS Breakout 114	18-21	CK7007		CSK236			SRC7008	SRK7008	CT708SP
FXBRS Breakout 114 Anniversary	18	CK7007		CSK236			SRC7008	SRK7008	CT708SP
FXCW Rocker	08-09	CK7008		CSK915			SRC7013	SRK7013	CT703SP
FXCWC Rocker C	08-11	CK7008		CSK915			SRC7013	SRK7013	CT703SP
FXFB Fat Bob	18-21	TBA		CSK236			TBA	TBA	
FXFBS Fat Bob 114	18-21	CK7007		CSK236			SRC7008	SRK7008	CT708SP
FXLR Low Rider	18	TBA		CSK236			TBA	TBA	
FXS Super Glide	81-82	CK7012		CSK255			SRC7018	SRK7018	CT704SP
FXS 103 Blackline	12-13	CK7008		CSK916			SRC7012	SRK7012	CT703SP
FXS Blackline	11	CK7008		CSK915			SRC7013	SRK7013	CT703SP
FXS Blackline	12	CK7008		CSK916			SRC7012	SRK7012	CT703SP
FXS Blackline	13	CK7008		CSK915			SRC7013	SRK7013	CT703SP
FXSB 103 Breakout	13-15	CK7008		CSK916			SRC7012	SRK7012	CT703SP
FXSB Low Rider	83-84	CK7012		CSK255			SRC7018	SRK7018	CT704SP
FXSB Low Rider	84-85	CK7010		TBA			SRC7016	SRK7016	CT705SP
FXSB Breakout	13-17	CK7008		CSK915			SRC7013	SRK7013	CT703SP
FXST Softail Standard	90	CK7009		TBA			SRC7019	SRK7019	CT701SP
FXST Softail Standard	84-89	CK7010		TBA			SRC7016	SRK7016	CT705SP
FXST Softail Standard	99-03	CK7008		CSK917			SRC7011	SRK7011	CT703SP
FXST Softail Standard	04-06	CK7008		CSK916			SRC7012	SRK7012	CT703SP
FXST Softail Standard	07-11	CK7008		CSK915			SRC7013	SRK7013	CT703SP
FXST Softail Standard	12-15	CK7008		CSK916			SRC7012	SRK7012	CT703SP
FXST Softail Standard	Early 1984	CK7012		CSK255			SRC7018	SRK7018	CT704SP
FXSTB Night Train	99-03	CK7008		CSK917			SRC7011	SRK7011	CT703SP
FXSTB Night Train	04-05	CK7008		CSK916			SRC7012	SRK7012	CT703SP
FXSTB Night Train	06-09	CK7008		CSK915			SRC7013	SRK7013	CT703SP
FXSTBI Night Train	01-03	CK7008		CSK917			SRC7011	SRK7011	CT703SP
FXSTBI Night Train	04-05	CK7008		CSK916			SRC7012	SRK7012	CT703SP
FXSTBI Night Train	06	CK7008		CSK915			SRC7013	SRK7013	CT703SP
FXSTC Softail Custom	90-97	CK7009		TBA			SRC7019	SRK7019	CT701SP
FXSTC Softail Custom	86-89	CK7010		TBA			SRC7016	SRK7016	CT705SP
FXSTC Softail Custom	98-99	CK7008		CSK917			SRC7011	SRK7011	CT703SP
FXSTC Softail Custom	07-10	CK7008		CSK915			SRC7013	SRK7013	CT703SP
FXSTD Softail Deuce	00-03	CK7008		CSK917			SRC7011	SRK7011	CT703SP
FXSTD Softail Deuce	04-05	CK7008		CSK916			SRC7012	SRK7012	CT703SP
FXSTD Softail Deuce	06-07	CK7008		CSK915			SRC7013	SRK7013	CT703SP
FXSTDI Softail Deuce	01-03	CK7008		CSK917			SRC7011	SRK7011	CT703SP
FXSTDI Softail Deuce	04-05	CK7008		CSK916			SRC7012	SRK7012	CT703SP

CLUTCH APPLICATIONS

EBC BRAKES CLUTCH KITS



HARLEY-DAVIDSON® SOFTAIL



		CK cork OEM style Kit #	CKF carbon fiber style upgrade Kit #	CSK Spring Kit #	DRC Series Kit #	DRCF Series Kit #	SRC Series Kit #	SRK Series Kit #	CT Tool #
FXSTDI Softail Deuce	06	CK7008		CSK915			SRC7013	SRK7013	CT703SP
FXSTI Softail Standard	01-03	CK7008		CSK917			SRC7011	SRK7011	CT703SP
FXSTI Softail Standard	04-05	CK7008		CSK916			SRC7012	SRK7012	CT703SP
FXSTI Softail Standard	06	CK7008		CSK915			SRC7013	SRK7013	CT703SP
FXSTS Softail Springer	90-97	CK7009		TBA			SRC7019	SRK7019	CT701SP
FXSTS Softail Springer	88-89	CK7010		TBA			SRC7016	SRK7016	CT705SP
FXSTS Softail Springer	98-03	CK7008		CSK917			SRC7011	SRK7011	CT703SP
FXSTS Softail Springer	04-05	CK7008		CSK916			SRC7012	SRK7012	CT703SP
FXSTS Softail Springer	06	CK7008		CSK915			SRC7013	SRK7013	CT703SP
FXSTSI Softail Springer	01-03	CK7008		CSK917			SRC7011	SRK7011	CT703SP
FXSTSI Softail Springer	04-05	CK7008		CSK916			SRC7012	SRK7012	CT703SP
FXSTSI Softail Springer	06	CK7008		CSK915			SRC7013	SRK7013	CT703SP
FLFB Fat Boy	18-21	CK7007		CSK236			SRC7013	SRK7013	CT703SP
FLFBS Fat Boy 114	18-21	CK7007		CSK236			SRC7008	SRK7008	CT708SP
FLFBS Fat Boy 114 Anniversary	18-21	CK7007		CSK236			SRC7008	SRK7008	CT708SP
FLS 103 Slim	13-15	CK7008		CSK916			SRC7012	SRK7012	CT703SP
FLS 103 Slim	12	CK7008		CSK916			SRC7012	SRK7012	CT703SP
FLS Slim	12-15	CK7008		CSK915			SRC7013	SRK7013	CT703SP
FLS Softail Slim	16-21	CK7008		CSK916			SRC7012	SRK7012	CT703SP
FLSL Slim	18	TBA		CSK236			TBA	TBA	
FLSS Slim S	17-21	CK7002		CSK235			SRC7003	SRK7003	CT702SP
FLST Heritage	08-09	CK7008		CSK915			SRC7013	SRK7013	CT703SP
FLST Heritage	06	CK7008		CSK915			SRC7013	SRK7013	CT703SP
FLST Heritage	89-89	CK7010		TBA			SRC7016	SRK7016	CT705SP
FLST Heritage	90	CK7009		TBA			SRC7019	SRK7019	CT701SP
FLSTC 103 Heritage Classic	12-15	CK7008		CSK916			SRC7012	SRK7012	CT703SP
FLSTC Heritage Classic	98-03	CK7008		CSK917			SRC7011	SRK7011	CT703SP
FLSTC Heritage Classic	04-05	CK7008		CSK916			SRC7012	SRK7012	CT703SP
FLSTC Heritage Classic	06-15	CK7008		CSK915			SRC7013	SRK7013	CT703SP
FLSTC Heritage Classic	16-17	CK7008		CSK916			SRC7012	SRK7012	CT703SP
FLSTC Heritage Classic	87-89	CK7010		TBA			SRC7016	SRK7016	CT705SP
FLSTC Heritage Classic	90-97	CK7009		TBA			SRC7019	SRK7019	CT701SP
FLSTC Heritage Classic Anniversary	13	CK7008		CSK916			SRC7012	SRK7012	CT703SP
FLSTC Heritage Classic Anniversary	13	CK7008		CSK915			SRC7013	SRK7013	CT703SP
FLSTCI Heritage Classic	01-03	CK7008		CSK917			SRC7011	SRK7011	CT703SP
FLSTCI Heritage Classic	04-05	CK7008		CSK916			SRC7012	SRK7012	CT703SP
FLSTCI Heritage Classic	06	CK7008		CSK915			SRC7013	SRK7013	CT703SP
FLSTCI Heritage Classic Shrine	05	CK7008		CSK916			SRC7012	SRK7012	CT703SP
FLSTF 103 Fat Boy	12-14	CK7008		CSK916			SRC7012	SRK7012	CT703SP
FLSTF 103 Fat Boy	15	CK7008		CSK916			SRC7012	SRK7012	CT703SP
FLSTF Fat Boy	91-97	CK7009		TBA			SRC7019	SRK7019	CT701SP
FLSTF Fat Boy	12	CK7008		CSK915			SRC7013	SRK7013	CT703SP
FLSTF Fat Boy	98-99	CK7008		CSK917			SRC7011	SRK7011	CT703SP
FLSTF Fat Boy	00-03	CK7008		CSK917			SRC7011	SRK7011	CT703SP
FLSTF Fat Boy	04-05	CK7008		CSK916			SRC7012	SRK7012	CT703SP
FLSTF Fat Boy	06-15	CK7008		CSK915			SRC7013	SRK7013	CT703SP
FLSTF Fat Boy	16-17	CK7008		CSK916			SRC7012	SRK7012	CT703SP
FLSTF Fat Boy	90	CK7009		TBA			SRC7019	SRK7019	CT701SP
FLSTFB 103 Fat Boy LO	12-15	CK7008		CSK916			SRC7012	SRK7012	CT703SP
FLSTFB Fat Boy LO	10-11	CK7008		CSK915			SRC7013	SRK7013	CT703SP
FLSTFB Fat Boy LO	12	CK7008		CSK916			SRC7012	SRK7012	CT703SP
FLSTFB Fat Boy LO	13-15	CK7008		CSK915			SRC7013	SRK7013	CT703SP
FLSTFB Fat Boy LO	16-17	CK7008		CSK916			SRC7012	SRK7012	CT703SP
FLSTFB Fat Boy 103 LO Anniversary	13	CK7008		CSK916			SRC7012	SRK7012	CT703SP
FLSTFB Fat Boy LO Anniversary	13	CK7008		CSK915			SRC7013	SRK7013	CT703SP
FLSTFBS Fat Boy S	16-17	CK7002		CSK235			SRC7003	SRK7003	CT702SP
FLSTFI Fat Boy	01-03	CK7008		CSK917			SRC7011	SRK7011	CT703SP

CLUTCH APPLICATIONS

Part numbers, prefixes, suffixes, photos and illustrations shown in this catalog are trademarks and/or copyrights of EBC Brakes or the trademark owner A C Freeman Investments Ltd and use without express written permission of the owners is punishable by law.

EBC BRAKES CLUTCH KITS



HARLEY-DAVIDSON® SOFTAIL



		CK cork OEM style Kit #	CKF carbon fiber style upgrade Kit #	CSK Spring Kit #	DRC Series Kit #	DRCF Series Kit #	SRC Series Kit #	SRK Series Kit #	CT Tool #
FLSTFI Fat Boy	04-05	CK7008		CSK916			SRC7012	SRK7012	CT703SP
FLSTFI Fat Boy	06	CK7008	CSK915	SRC7013	SRK7013	CT703SP			
FLSTFI Fat Boy Shrine	05	CK7008	CSK916	SRC7012	SRK7012	CT703SP			
FLSTI Heritage	06	CK7008	CSK915	SRC7013	SRK7013	CT703SP			
FLSTN 103 Deluxe	12-15	CK7008	CSK916	SRC7012	SRK7012	CT703SP			
FLSTN Deluxe	17	CK7008	CSK916	SRC7012	SRK7012	CT703SP			
FLSTN Heritage Nostalgia	93-96	CK7009	TBA	SRC7019	SRK7019	CT701SP			
FLSTN Deluxe	05	CK7008	CSK916	SRC7012	SRK7012	CT703SP			
FLSTN Deluxe	06	CK7008	CSK915	SRC7013	SRK7013	CT703SP			
FLSTN Deluxe	07-15	CK7008	CSK915	SRC7013	SRK7013	CT703SP			
FLSTN Deluxe	16	CK7008	CSK916	SRC7012	SRK7012	CT703SP			
FLSTNI Deluxe	06	CK7008	CSK915	SRC7013	SRK7013	CT703SP			
FLSTNI Deluxe	05	CK7008	CSK916	SRC7012	SRK7012	CT703SP			
FLSTS Heritage Springer	97	CK7009	TBA	SRC7019	SRK7019	CT701SP			
FLSTS Heritage Springer	98-03	CK7008	CSK917	SRC7011	SRK7011	CT703SP			
FLSTSB Cross Bones	08-11	CK7008	CSK915	SRC7013	SRK7013	CT703SP			
FLSTSC Springer Classic	06-07	CK7008	CSK915	SRC7013	SRK7013	CT703SP			
FLSTSC Springer Classic	05	CK7008	CSK916	SRC7012	SRK7012	CT703SP			
FLSTSI Heritage Springer	01-03	CK7008	CSK917	SRC7011	SRK7011	CT703SP			
FLHC Heritage Classic	18	TBA	CSK236	TBA	TBA				
FLHC Electra Glide Classic	81-82	CK7012	CSK255	SRC7018	SRK7018	CT704SP			
FLHCS Heritage Classic 114	18-21	CK7007	CSK236	SRC7008	SRK7008	CT708SP			
FLHCS Heritage Classic 114 Anniversary	18-21	CK7007	CSK236	SRC7008	SRK7008	CT708SP			

HARLEY-DAVIDSON® SPORTSTER

XL 883	86-90		CK7014	CSK921	SRC7024	SRK7024	CT709SP		
XL 883	04-09		CK7009	CSK918	SRC7021	SRK7021	CT701SP		
XL 883	91-03		CK7009	CSK920	SRC7023	SRK7023	CT701SP		
XL 883 C Custom	98-03		CK7009	CSK920	SRC7023	SRK7023	CT701SP		
XL 883 C Custom	04-10		CK7009	CSK918	SRC7021	SRK7021	CT701SP		
XL 883 DLX Deluxe	86-90		CK7014	CSK921	SRC7024	SRK7024	CT709SP		
XL 883 DLX Deluxe	91-95		CK7009	CSK920	SRC7023	SRK7023	CT701SP		
XL 883 HUG Hugger	87-90		CK7014	CSK921	SRC7024	SRK7024	CT709SP		
XL 883 HUG Hugger	91-03		CK7009	CSK920	SRC7023	SRK7023	CT701SP		
XL 883 L Low	05-11		CK7009	CSK918	SRC7021	SRK7021	CT701SP		
XL 883 L SuperLow	12-21		CK7009	CSK918	SRC7021	SRK7021	CT701SP		
XL 883 N Iron	09-21		CK7009	CSK918	SRC7021	SRK7021	CT701SP		
XL 883 R Roadster	11-15		CK7009	CSK918	SRC7021	SRK7021	CT701SP		
XL 883 R	02-06		CK7009	CSK920	SRC7023	SRK7023	CT701SP		
XL 883 R	07-10		CK7009	CSK918	SRC7021	SRK7021	CT701SP		
XLH 1000 Standard	70		CK7016	TBA	TBA	TBA			
XLCH 1000	70		CK7016	TBA	TBA	TBA			
XLH 1000 Standard	71-78		CK7015	CSK256	SRC7025	SRK7025	CT709SP		
XLCH 1000	71-80		CK7015	CSK257	SRC7025	SRK7025	CT709SP		
XLH 1000	81-84		CK7015	CSK257	SRC7025	SRK7025	CT709SP		
XLS 1000 Roadster	81-84		CK7015	CSK257	SRC7025	SRK7025	CT709SP		
XLS 1000 Roadster	84		CK7014	CSK921	SRC7024	SRK7024	CT709SP		
XLS 1000 Roadster	84		CK7014	CSK921	SRC7024	SRK7024	CT709SP		
XR 1000	84		CK7014	CSK921	SRC7024	SRK7024	CT709SP		
XLH 1000	84		CK7014	CSK921	SRC7024	SRK7024	CT709SP		
XR 1000	83-84		CK7015	CSK257	SRC7025	SRK7025	CT709SP		
XLH 1100	86-87		CK7014	CSK921	SRC7024	SRK7024	CT709SP		
XLH 1200	88-90		CK7014	CSK921	SRC7024	SRK7024	CT709SP		
XL 1200 Forty Eight Anniversary	18		CK7009	CSK919	SRC7020	SRK7020	CT701SP		
XL 1200	91-03		CK7009	CSK920	SRC7023	SRK7023	CT701SP		
XL 1200 C Custom	96-03		CK7009	CSK920	SRC7023	SRK7023	CT701SP		
XL 1200 C Custom	17-21		CK7009	CSK919	SRC7020	SRK7020	CT701SP		

CLUTCH APPLICATIONS

EBC BRAKES CLUTCH KITS



HARLEY-DAVIDSON® SPORTSTER



		CK cork OEM style Kit #	CKF carbon fiber style upgrade Kit #	CSK Spring Kit #	DRC Series Kit #	DRCF Series Kit #	SRC Series Kit #	SRK Series Kit #	CT Tool #
XL 1200 CA Custom Limited A	13-16		CK7009	CSK919	SRC7020	SRK7020	CT701SP		
XL 1200 CANV Custom Anniversary	13		CK7009	CSK919	SRC7020	SRK7020	CT701SP		
XL 1200 CB Custom Limited B	13-17		CK7009	CSK919	SRC7020	SRK7020	CT701SP		
XL 1200 CP 1200 Custom (H-D1)	11-21		CK7009	CSK919	SRC7020	SRK7020	CT701SP		
XL 1200 CX Roadster	18-21		CK7009	CSK919	SRC7020	SRK7020	CT701SP		
XL 1200 L Low	06-11		CK7009	CSK919	SRC7020	SRK7020	CT701SP		
XL 1200 N Nightster	07-12		CK7009	CSK919	SRC7020	SRK7020	CT701SP		
XL 1200 R Roadster	04-09		CK7009	CSK919	SRC7020	SRK7020	CT701SP		
XL 1200 S Sport	96-03		CK7009	CSK920	SRC7023	SRK7023	CT701SP		
XL 1200 T SuperLow	18-21		CK7009	CSK919	SRC7020	SRK7020	CT701SP		
XL 1200 V Seventy-Two	12-16		CK7009	CSK919	SRC7020	SRK7020	CT701SP		
XL 1200 X Forty Eight	10-21		CK7009	CSK919	SRC7020	SRK7020	CT701SP		
XL 50 50th Anniversary	07		CK7009	CSK919	SRC7020	SRK7020	CT701SP		
XR 1200 Sportster	08-10		CK7013	CSK913	SRC7022	SRK7022	CT701SP		
XR 1200 X	10-13		CK7013	CSK913	SRC7022	SRK7022	CT701SP		

HARLEY-DAVIDSON® STREET

XG 500	15-21			CK7004	CSK230	SRC7005	SRK7005		
XG 750	15-21			CK7004	CSK229	TBA	TBA		

HARLEY-DAVIDSON® TOURING

FLH Electra Glide	81-83		CK7012	CSK255	SRC7018	SRK7018	CT704SP		
FLH Electra Glide	Early 84		CK7011	CSK255	SRC7017	SRK7017	CT704SP		
FLH Electra Glide Shrine Shovelhead	83		CK7012	CSK255	SRC7018	SRK7018	CT704SP		
FLH Electra Glide Shrine Shovelhead	Early 84		CK7011	CSK255	SRC7017	SRK7017	CT704SP		
FLHP Road King Police	11-16		CK7008	CSK914	SRC7009	SRK7009	CT703SP		
FLHP Road King Police	17		CK7007	CSK236	SRC7008	SRK7008	CT708SP		
FLHPE Road King Police	11		CK7008	CSK914	SRC7009	SRK7009	CT703SP		
FLHR 103 Road King	11		CK7008	CSK916	SRC7012	SRK7012	CT703SP		
FLHR 96 Road King	11		CK7008	CSK915	SRC7013	SRK7013	CT703SP		
FLHR Road King	17		CK7002	CSK236	SRC7010	SRK7010	CT702SP		
FLHR Road King	93-97		CK7009	TBA	SRC7014	SRK7014	CT701SP		
FLHR Road King	06-11		CK7008	CSK915	SRC7013	SRK7013	CT703SP		
FLHR Road King	12-13		CK7008	CSK916	SRC7012	SRK7012	CT703SP		
FLHR Road King	15-21		CK7008	CSK917	SRC7011	SRK7011	CT703SP		
FLHR Road King	98-03		CK7008	CSK917	SRC7011	SRK7011	CT703SP		
FLHR Road King	04-05		CK7008	CSK916	SRC7012	SRK7012	CT703SP		
FLHR Road King Anniversary	13		CK7008	CSK916	SRC7012	SRK7012	CT703SP		
FLHRC 103 Road King Classic	11		CK7008	CSK916	SRC7012	SRK7012	CT703SP		
FLHRC Road King Classic	18-21		CK7002	CSK236	SRC7010	SRK7010	CT702SP		
FLHRC Road King Classic	07-11		CK7008	CSK915	SRC7013	SRK7013	CT703SP		
FLHRC Road King Classic	12-13		CK7008	CSK916	SRC7012	SRK7012	CT703SP		
FLHRC Road King Classic	14-16		CK7008	CSK917	SRC7011	SRK7011	CT703SP		
FLHRCI Road King Classic	98-03		CK7008	CSK917	SRC7011	SRK7011	CT703SP		
FLHRCI Road King Classic	05		CK7008	CSK916	SRC7012	SRK7012	CT703SP		
FLHRCI Road King Classic	06		CK7008	CSK915	SRC7013	SRK7013	CT703SP		
FLHRCI Road King Classic	04		CK7008	CSK916	SRC7012	SRK7012	CT703SP		
FLHRI Road King	00-03		CK7008	CSK917	SRC7011	SRK7011	CT703SP		
FLHRI Road King	04-08		CK7008	CSK916	SRC7012	SRK7012	CT703SP		
FLHRI Road King	06		CK7008	CSK915	SRC7013	SRK7013	CT703SP		
FLHRS Road King Custom	04-08		CK7008	CSK916	SRC7012	SRK7012	CT703SP		
FLHRS Road King Custom	06-07		CK7008	CSK915	SRC7013	SRK7013	CT703SP		
FLHRSI 1FYW Road King Custom	04-05		CK7008	CSK916	SRC7012	SRK7012	CT703SP		
FLHRSI 1FYW Road King Custom	06		CK7008	CSK915	SRC7013	SRK7013	CT703SP		
FLHRXS Road King Special	18-21		CK7002	CSK236	SRC7010	SRK7010	CT702SP		
FLHS Electra Glide Heritage	81		CK7012	CSK255	SRC7018	SRK7018	CT704SP		
FLHS Electra Glide Sport	81-83		CK7012	CSK255	SRC7018	SRK7018	CT704SP		

CLUTCH APPLICATIONS

Part numbers, prefixes, suffixes, photos and illustrations shown in this catalog are trademarks and/or copyrights of EBC Brakes or the trademark owner A C Freeman Investments Ltd and use without express written permission of the owners is punishable by law.

EBC BRAKES CLUTCH KITS



HARLEY-DAVIDSON® TOURING



		CK cork OEM style Kit #	CKF carbon fiber style upgrade Kit #	CSK Spring Kit #	DRC Series Kit #	DRCF Series Kit #	SRC Series Kit #	SRK Series Kit #	CT Tool #
FLHS Electra Glide Sport - Early 1984	84		CK7011	CSK255	SRC7017	SRK7017	CT704SP		
FLHS Electra Glide Sport	84-89	CK7010		TBA			SRC7016	SRK7016	CT705SP
FLHS Electra Glide Sport	91-94	CK7009		TBA			SRC7014	SRK7014	CT701SP
FLHS Electra Glide Sport	90	CK7009		TBA			SRC7015	SRK7015	CT701SP
FLHT Electra Glide - Early 1984	84	CK7011		CSK255			SRC7017	SRK7017	CT704SP
FLHT Electra Glide - Later 1984	84	CK7010		TBA			SRC7016	SRK7016	CT705SP
FLHT Electra Glide Classic	83	CK7012		CSK255			SRC7018	SRK7018	CT704SP
FLHT Electra Glide Classic - Early 1984	84	CK7011		CSK255			SRC7017	SRK7017	CT704SP
FLHT Electra Glide Classic - Later 1984	84	CK7010		TBA			SRC7016	SRK7016	CT705SP
FLHT Electra Glide Shrine Shovelhead - Later 1984	84	CK7010		TBA			SRC7016	SRK7016	CT705SP
FLHT Electra Glide Standard	83	CK7012		CSK255			SRC7018	SRK7018	CT704SP
FLHT Electra Glide Standard	88	CK7010		TBA			SRC7016	SRK7016	CT705SP
FLHT Electra Glide Standard	94-97	CK7009		TBA			SRC7014	SRK7014	CT701SP
FLHT Electra Glide Standard	98-03	CK7008		CSK917			SRC7011	SRK7011	CT703SP
FLHT Electra Glide Standard	04-05	CK7008		CSK916			SRC7012	SRK7012	CT703SP
FLHT Electra Glide Standard	06-10	CK7008		CSK915			SRC7013	SRK7013	CT703SP
FLHT Electra Glide	83	CK7012		CSK255			SRC7018	SRK7018	CT704SP
FLHTC 103 Electra Glide Classic	11	CK7008		CSK916			SRC7012	SRK7012	CT703SP
FLHTC Electra Glide Classic	83-84	CK7012		CSK255			SRC7018	SRK7018	CT704SP
FLHTC Electra Glide Classic	84-89	CK7010		TBA			SRC7016	SRK7016	CT705SP
FLHTC Electra Glide Classic	91-97	CK7009		TBA			SRC7014	SRK7014	CT701SP
FLHTC Electra Glide Classic	98-03	CK7008		CSK917			SRC7011	SRK7011	CT703SP
FLHTC Electra Glide Classic	04-05	CK7008		CSK916			SRC7012	SRK7012	CT703SP
FLHTC Electra Glide Classic	07-11	CK7008		CSK915			SRC7013	SRK7013	CT703SP
FLHTC Electra Glide Classic	12-13	CK7008		CSK916			SRC7012	SRK7012	CT703SP
FLHTC Electra Glide Classic	90	CK7009		TBA			SRC7015	SRK7015	CT701SP
FLHTCI Electra Glide Classic	96-97	CK7009		TBA			SRC7014	SRK7014	CT701SP
FLHTCI Electra Glide Classic	98-03	CK7008		CSK917			SRC7011	SRK7011	CT703SP
FLHTCI Electra Glide Classic	04-05	CK7008		CSK916			SRC7012	SRK7012	CT703SP
FLHTCI Electra Glide Classic	06	CK7008		CSK915			SRC7013	SRK7013	CT703SP
FLHTCI Ultra Classic	05	CK7008		CSK916			SRC7012	SRK7012	CT703SP
FLHTCU 103 Ultra Classic	11	CK7008		CSK916			SRC7012	SRK7012	CT703SP
FLHTCU Electra Glide Classic Ultra	89	CK7010		TBA			SRC7016	SRK7016	CT705SP
FLHTCU Electra Glide Classic Ultra	18-21	CK7002		CSK236			SRC7010	SRK7010	CT702SP
FLHTCU TC Ultra Classic Twin-Cooled	14-16	CK7008		CSK917			SRC7011	SRK7011	CT703SP
FLHTCU Electra Glide Classic Ultra	90	CK7009		TBA			SRC7015	SRK7015	CT701SP
FLHTCU Ultra Classic	91-97	CK7009		TBA			SRC7014	SRK7014	CT701SP
FLHTCU Ultra Classic	07-11	CK7008		CSK915			SRC7013	SRK7013	CT703SP
FLHTCU Ultra Classic	12-13	CK7008		CSK916			SRC7012	SRK7012	CT703SP
FLHTCU Ultra Classic	14-21	CK7008		CSK917			SRC7011	SRK7011	CT703SP
FLHTCUI Ultra Classic	04	CK7008		CSK916			SRC7012	SRK7012	CT703SP
FLHTCUI Ultra Classic	98-03	CK7008		CSK917			SRC7011	SRK7011	CT703SP
FLHTCUI Ultra Classic	06	CK7008		CSK915			SRC7013	SRK7013	CT703SP
FLHTCUL TC Ultra Classic Low Twin-Cooled	15-21	CK7002		CSK235			SRC7003	SRK7003	CT702SP
FLHTCUL Ultra Classic Low	15-21	CK7002		CSK235			SRC7003	SRK7003	CT702SP
FLHTI Electra Glide Standard	03	CK7008		CSK917			SRC7011	SRK7011	CT703SP
FLHTI Electra Glide Standard	04-05	CK7008		CSK916			SRC7012	SRK7012	CT703SP
FLHTI Electra Glide Standard	06	CK7008		CSK915			SRC7013	SRK7013	CT703SP
FLHTK 103 CVO Limited	14	CK7002		CSK235			SRC7003	SRK7003	CT702SP
FLHTK Electra Glide Ultra Limited	10-13	CK7008		CSK916			SRC7012	SRK7012	CT703SP
FLHTK Ultra Limited	14-16	CK7008		CSK917			SRC7011	SRK7011	CT703SP
FLHTK Ultra Limited	17-21	CK7002		CSK236			SRC7010	SRK7010	CT702SP
FLHTK Ultra Limited Anniversary	18-21	CK7002		CSK236			SRC7010	SRK7010	CT702SP
FLHTK Ultra Limited Shrine Edition	18	CK7002		CSK236			SRC7010	SRK7010	CT702SP
FLHTK ANV Electra Glide Ultra Limited Anniversary	13	CK7008		CSK916			SRC7012	SRK7012	CT703SP
FLHTKL Ultra Limited Low	15-21	CK7002		CSK235			SRC7003	SRK7003	CT702SP
FLHTP Electra Glide Standard Police	11-16	CK7008		CSK914			SRC7009	SRK7009	CT703SP

CLUTCH APPLICATIONS

Part numbers, prefixes, suffixes, photos and illustrations shown in this catalog are trademarks and/or copyrights of EBC Brakes or the trademark owner A C Freeman Investments Ltd and use without express written permission of the owners is punishable by law.

EBC BRAKES CLUTCH KITS



HARLEY-DAVIDSON® TOURING



		CK cork OEM style Kit #	CKF carbon fiber style upgrade Kit #	CSK Spring Kit #	DRC Series Kit #	DRCF Series Kit #	SRC Series Kit #	SRK Series Kit #	CT Tool #
FLHTP Electra Glide Standard Police	17	CK7007		CSK236			SRC7008	SRK7008	CT708SP
FLHX 103 Street Glide	11	CK7008		CSK916			SRC7012	SRK7012	CT703SP
FLHX Street Glide	12-13	CK7008		CSK916			SRC7012	SRK7012	CT703SP
FLHX Street Glide	14-16	CK7008		CSK917			SRC7011	SRK7011	CT703SP
FLHX Street Glide	17-18	CK7002		CSK236			SRC7010	SRK7010	CT702SP
FLHX Street Glide Anniversary	18-21	CK7002		CSK236			SRC7010	SRK7010	CT702SP
FLHX Street Glide	06-11	CK7008		CSK915			SRC7013	SRK7013	CT703SP
FLHXS Street Glide Special	14-16	CK7008		CSK917			SRC7011	SRK7011	CT703SP
FLHXS Street Glide Special	17-21	CK7002		CSK236			SRC7010	SRK7010	CT702SP
FLHXS Street Glide Anniversary	18	CK7002		CSK236			SRC7010	SRK7010	CT702SP
FLT Classic Tour Glide Classic - Early 1984	84	CK7011		CSK255			SRC7017	SRK7017	CT704SP
FLT Tour Glide	81-83	CK7012		CSK255			SRC7018	SRK7018	CT704SP
FLT Tour Glide - Early 1984	84	CK7011		CSK255			SRC7017	SRK7017	CT704SP
FLT Tour Glide - Later 1984	84	CK7010		TBA			SRC7016	SRK7016	CT705SP
FLTC Tour Glide Classic	80-84	CK7012		CSK255			SRC7018	SRK7018	CT704SP
FLTC Tour Glide Classic	84-89	CK7010		TBA			SRC7016	SRK7016	CT705SP
FLTC Tour Glide Classic	90-92	CK7009		TBA			SRC7014	SRK7014	CT701SP
FLTCU Tour Glide Classic Ultra	89	CK7010		TBA			SRC7016	SRK7016	CT705SP
FLTCU Tour Glide Classic Ultra	90-95	CK7009		TBA			SRC7014	SRK7014	CT701SP
FLTCUI Tour Glide Classic Ultra	96	CK7009		TBA			SRC7014	SRK7014	CT701SP
FLTR Road Glide	98-03	CK7008		CSK917			SRC7011	SRK7011	CT703SP
FLTR Road Glide	06-09	CK7008		CSK915			SRC7013	SRK7013	CT703SP
FLTRI Road Glide	04-05	CK7008		CSK916			SRC7012	SRK7012	CT703SP
FLTRU Road Glide Ultra	16	CK7008		CSK917			SRC7011	SRK7011	CT703SP
FLTRU Road Glide Ultra	11-13	CK7008		CSK916			SRC7012	SRK7012	CT703SP
FLTRU Road Glide Ultra	18-21	CK7002		CSK236			SRC7010	SRK7010	CT702SP
FLTRX 103 Road Glide Custom	11	CK7008		CSK916			SRC7012	SRK7012	CT703SP
FLTRX Road Glide	15-16	CK7008		CSK917			SRC7011	SRK7011	CT703SP
FLTRX Road Glide	18-21	CK7002		CSK236			SRC7010	SRK7010	CT702SP
FLTRX 103 Road Glide Custom	10-11	CK7008		CSK915			SRC7013	SRK7013	CT703SP
FLTRX 103 Road Glide Custom	12-13	CK7008		CSK916			SRC7012	SRK7012	CT703SP
FLTRXS Road Glide Special	15-16	CK7008		CSK917			SRC7011	SRK7011	CT703SP
FLTRXS Road Glide Special	18-21	CK7002		CSK236			SRC7010	SRK7010	CT702SP
HARLEY-DAVIDSON® TRIKE									
FLHTCUTG Tri Glide Ultra	17-18	CK7007		CSK236			SRC7008	SRK7008	CT708SP
FLHTCUTG Tri Glide Ultra Anniversary	18-21	CK7007		CSK236			SRC7008	SRK7008	CT708SP
FLHTCUTG Tri Glide Ultra Classic	09-13	CK7008		CSK914			SRC7009	SRK7009	CT703SP
FLHTCUTG Tri Glide Ultra Classic	14-16	CK7002		CSK235			SRC7003	SRK7003	CT702SP
FLHTCUTG ANV Tri Glide Ultra Classic Anniversary	13	CK7008		CSK914			SRC7009	SRK7009	CT703SP
FLHXXX Street Glide Trike	10-11	CK7008		CSK914			SRC7009	SRK7009	CT703SP
FLRT Freewheeler	15-16	CK7002		CSK235			SRC7003	SRK7003	CT702SP
FLRT Freewheeler	17-18	CK7007		CSK236			SRC7008	SRK7008	CT708SP
HARLEY-DAVIDSON® V-ROD									
VRSCA	02-06	CK7006		CSK232			SRC7007	SRK7007	CT707SP
VRSCAW	09-10	CK7005		CSK233			SRC7006	SRK7006	CT706SP
VRSCAW Wide Tire	07	CK7006		CSK232			SRC7007	SRK7007	CT707SP
VRSCAW Wide Tire	08	CK7005		CSK233			SRC7006	SRK7006	CT706SP
VRSCAWA Wide Tire With ABS	08	CK7005		CSK233			SRC7006	SRK7006	CT706SP
VRSCD Night Rod	08	CK7005		CSK233			SRC7006	SRK7006	CT706SP
VRSCDA Night Rod With ABS	08	CK7005		CSK233			SRC7006	SRK7006	CT706SP
VRSCDX Night Rod Special	12	CK7005		CSK233			SRC7006	SRK7006	CT706SP
VRSCDX Night Rod Special	08-21	CK7005		CSK233			SRC7006	SRK7006	CT706SP
VRSCDXA Night Rod Special With ABS	08	CK7005		CSK233			SRC7006	SRK7006	CT706SP
VRSCF Muscle 1HPH V-Rod	09-21	CK7005		CSK233			SRC7006	SRK7006	CT706SP
VRSCR Street Rod	06-07	CK7006		CSK232			SRC7007	SRK7007	CT707SP

CLUTCH APPLICATIONS

EBC BRAKES CLUTCH KITS



HARLEY-DAVIDSON® V-ROD



CK cork OEM style Kit #	CKF carbon fiber style upgrade Kit #	CSK Spring Kit #	DRC Series Kit #	DRCF Series Kit #	SRC Series Kit #	SRK Series Kit #	CT Tool #
----------------------------------	--	------------------------	------------------------	-------------------------	------------------------	------------------------	-----------------

VRSCSE CVO V-Rod	05-06	CK7006		CSK232		SRC7007	SRK7007	CT707SP
VRSCX Screamin' Eagle	07	CK7006		CSK232		SRC7007	SRK7007	CT707SP
VRXSE CVO VR Destroyer	06	CK7006		CSK232		SRC7007	SRK7007	CT707SP

HUSQVARNA

TC 50	17-19	CK5674						
TC 85 F 17"/R 14"	14-17	CK5610		CSK042	DRC139			CT028
TC 85 F19"/R 16"	14-17	CK5610		CSK042	DRC139			CT028
TC 85 F 17"/R 14"	18-21	CK5668	CKF5668	CSK908	DRC304	DRCF304		CT087SP
TC 85 F19"/R 16"	18-21	CK5668	CKF5668	CSK908	DRC304	DRCF304		CT087SP
CR 125	00-11	CK1222		CSK182	DRC264			CT001
TC 125	14-18	CK5611	CKF5611	CSK210	DRC303	DRCF303		CT001
TC 125	19-22	TBA	TBA	TBA	TBA	TBA		CT001
TE 125	14-16	CK5611	CKF5611	CSK210	DRC303	DRCF303		CT001
TX 125	17-18	CK5611	CKF5611	CSK210	DRC303	DRCF303		CT001
WR 125	00-11	CK1222		CSK182	DRC264			CT001
WRE 125	00-11	CK1222		CSK182	DRC264			CT001
SMS 125	00-11	CK1222		CSK182	DRC264			CT001
TE 150	17-18	CK5611	CKF5611	CSK210	DRC303	DRCF303		CT001
TE 150i	19-22	TBA	TBA	TBA	TBA	TBA		TBA
FC 250	14-17	CK5651	CKF5651	CSK221	DRC293			CT023
FC 250	18-22	TBA	TBA	TBA	TBA	TBA		CT023
TC 250	03-08	CK5657						
TC 250	14-21	CK5651	CKF5651	CSK910	TBA			CT023
TE 250 2T	03-09	CK5657						
TE 250 2T	14-17	CK5651	CKF5651	CSK910	TBA			CT023
TE 250 2T	18-21	CK5651	CKF5651	CSK910	TBA			CT023
TE 300 2T	14-17	CK5651	CKF5651	CSK910	TBA			CT023
TE 300i 2T	18-22	CK5651	CKF5651	CSK910	TBA			CT023
TX 300i	18-22	CK5651	CKF5651	CSK910	TBA			CT023
TE 310	08-10	CK5657						
FC 350	14-17	CK5651	CKF5651	CSK221	DRC293			CT023
FC 350	18-22	TBA	TBA	TBA	TBA			CT023
FE 350	14-17	CK5651	CKF5651	CSK910	DRC275			CT023
FE 350 Inc S models	18-22	TBA	TBA	TBA	TBA			CT023
FX 350	17-18	CK5651	CKF5651	CSK221	DRC293			CT023
FX 350	18-22	TBA	TBA	TBA	TBA			CT023
FC 450	14-17	CK5651	CKF5651	CSK910	DRC296			CT023
FC 450 Inc Rockstar Edition models	18-22	TBA	TBA	TBA	TBA			CT023
FE 450	14-17	CK5651	CKF5651	CSK910	DRC275			CT023
FE 450	18-21	TBA	TBA	TBA	TBA			CT023
FR 450 Rally	17-21	CK5651	CKF5651	CSK909	DRC281			CT023
FS 450	15-18	CK5651	CKF5651	CSK909	DRC281			CT023
FX 450	17	CK5651	CKF5651	CSK909	DRC281			CT023
FX 450	18-22	TBA	TBA	TBA	TBA			CT023
TC 450	02-06	CK5656						
TE 450	02-06	CK5656						
FE 501	14-16	CK5651	CKF5651	CSK910	DRC275			CT023
FE 501	17-22	CK5651	CKF5651	CSK910	DRC275			CT023
FE 501S	16-22	CK5651	CKF5651	CSK910	DRC275			CT023
SMR 570	03-04	CK5656						
TC 570	03-04	CK5656						
TE 570	03-04	CK5656						
TE 610	05-12	CK5656						
701 Enduro R	16-24	CK5642		CSK131	DRC205			CT069
701 Supermoto	16-18	CK5642		CSK131	DRC205			CT069
Svartpilen 401	18-21	CK5642		CSK131	DRC205			CT069

CLUTCH
APPLICATIONS

EBC BRAKES CLUTCH KITS



HUSQVARNA



		CK cork OEM style Kit #	CKF carbon fiber style upgrade Kit #	CSK Spring Kit #	DRC Series Kit #	DRCF Series Kit #	SRC Series Kit #	SRK Series Kit #	CT Tool #
Svartpilen 701	18-21	CK5642		CSK131	DRC205				CT069
Vitpilen 401	18-21	CK5642		CSK131	DRC205				CT069
Vitpilen 701	18-21	CK5642		CSK131	DRC205				CT069
INDIAN									
Chief Classic	14-21	CK7003		CSK232			SRC7004	SRK7004	
Chief Dark Horse	16-21	CK7003		CSK232			SRC7004	SRK7004	
Chief Vintage	14-21	CK7003		CSK232			SRC7004	SRK7004	
Chieftain	14-18	CK7003		CSK232			SRC7004	SRK7004	
Chieftain Dark Horse	16-21	CK7003		CSK232			SRC7004	SRK7004	
Chieftain Elite	17-21	CK7003		CSK232			SRC7004	SRK7004	
Chieftain Limited	17-18	CK7003		CSK232			SRC7004	SRK7004	
FTR 1200 FTR 1200	19-21	CK7018							
Octane	17	CK7001		CSK231			SRC7001	SRK7001	
Roadmaster	15-21	CK7003		CSK232			SRC7004	SRK7004	
Roadmaster Classic	17-21	CK7003		CSK232			SRC7004	SRK7004	
Roadmaster Elite	18-21	CK7003		CSK232			SRC7004	SRK7004	
Scout	15-16	CK7001		CSK231			SRC7001	SRK7001	
Scout	17-21	CK7001		CSK235			SRC7002	SRK7002	
Scout 1200	17-21	CK7001		CSK235			SRC7002	SRK7002	
Scout Bobber	18	CK7001		CSK235			SRC7002	SRK7002	
Scout Sixty	16-17	CK7001		CSK231			SRC7001	SRK7001	
Scout Sixty	17-21	CK7001		CSK235			SRC7002	SRK7002	
Springfield	16-20	CK7003		CSK232			SRC7004	SRK7004	
Springfield Dark Horse	18	CK7003		CSK232			SRC7004	SRK7004	
KTM									
SX 50	13-19	CK5674							
SX 60	98-00	CK5594	CKF5594	CSK64	DRC107	DRCF107			CT027
SX 65	98-08	CK5594	CKF5594	CSK64	DRC107	DRCF107			CT027
SX 65	09-18	CK5594	CKF5594	CSK21	DRC241	DRCF241			CT057SP
XC 65	08	CK5594	CKF5594	CSK64	DRC107	DRCF107			CT027
XC 65	09-10	CK5594	CKF5594	CSK21	DRC241	DRCF241			CT057SP
SX 85	03-17	CK5610		CSK42	DRC139				CT028
SX 85	18-21	CK5668	CKF5668	CSK908	DRC304	DRCF304			CT087SP
XC 85	08-09	CK5610		CSK42	DRC139				CT028
SX 105	04-10	CK5610		CSK42	DRC139				CT028
XC 105	08-10	CK5610		CSK42	DRC139				CT028
125 EGS	98-99	CK5611		CSK24	DRC145				CT001
125 EXC	98-05	CK5611		CSK24	DRC145				CT001
125 EXE	00-01	CK5611		CSK24	DRC145				CT001
125 LC 2 Sting	96-98	N/A		N/A	N/A				
125 Supermoto	00-01	CK5611		CSK24	DRC145				CT001
SX 125	98-07	CK5611		CSK24	DRC145				CT001
SX 125	08	CK5611		CSK132	DRC174				CT001
SX 125	15-18	CK5611		CSK24	DRC145				CT001
SX 125	19-22	TBA		TBA	TBA				CT001
125 SXS	01-02	CK5611		CSK24	DRC145				CT001
SX 150	08-18	CK5611		CSK91	DRC144				CT001
SX 150	19-22	TBA		TBA	TBA				CT001
XC 150	10-14	CK5611		CSK91	DRC144				CT001
XC-W 150 Tpi	17-22	CK5611		CSK91	DRC144				CT001
200 EGS	98-99	CK5611		CSK91	DRC144				CT001
200 EXC	97-05	CK5611		CSK91	DRC144				CT001
200 MXC	98-03	CK5611		CSK91	DRC144				CT001
SX 200	03	CK5611		CSK91	DRC144				CT001
XC-W 200	07-16	CK5611		CSK91	DRC144				CT001

CLUTCH APPLICATIONS

EBC BRAKES CLUTCH KITS



KTM



		CK cork OEM style Kit #	CKF carbon fiber style upgrade Kit #	CSK Spring Kit #	DRC Series Kit #	DRCF Series Kit #	SRC Series Kit #	SRK Series Kit #	CT Tool #
XC 200	06-09	CK5611		CSK91	DRC144				CT001
250 EGS	94-99	CK5595	CKF5595	CSK80	DRC108	DRCF108			CT007
250 EXC	94-05	CK5595	CKF5595	CSK80	DRC108	DRCF108			CT007
250 EXC Racing	02-03	CK5612		CSK210	DRC171				CT023
250 EXC Racing	04	CK5602		CSK210	DRC117				CT059
250 EXC Racing	05	CK5612		CSK210	DRC154				CT023
250 EXG-G Racing	03	CK5612		CSK210	DRC171				CT023
250 EXC-G Racing	04	CK5602		CSK210	DRC117				CT059
250 MXC	98-99	CK5595	CKF5595	CSK80	DRC108	DRCF108			CT007
SX 250 2T	94-12	CK5595	CKF5595	CSK80	DRC108	DRCF108			CT007
SX 250 2T (Diaphragm Spring)	13-22	CK5651		CSK910	DRC275				CT023
SX-F 250	05-12	CK1293	CKF1293	CSK179	DRC163	DRCF163			CT001
SX-F 250	13-15	CK5651		CSK91	DRC260				CT023
SX-F 250	16-18	CK5612		CSK210	DRC171				CT023
SX-F 250	19-22	TBA		TBA	TBA				CT023
SX-F 250 Factory Edition	16-18	CK5612		CSK210	DRC171				CT023
250 R Freeride	15-16	CK5612		TBA					
XC 250 2T	06-12	CK5595	CKF5595	CSK80	DRC108	DRCF108			CT007
XC 250 2T (Diaphragm Spring)	13-16	CK5651		CSK910	DRC275				CT023
XC-F 250	06-12	CK1293	CKF1293	CSK179	DRC163	DRCF163			CT001
XC-F 250	13-15	CK5651		CSK91	DRC260				CT023
XC-F 250	16	CK5612		CSK221	DRC292				CT023
XC-F-W 250	06-13	CK1293	CKF1293	CSK179	DRC163	DRCF163			CT001
XC-F-W 250 (Diaphragm spring)	14-16	CK5651		CSK910	DRC273				CT023
XC-W 250	06-12	CK5595	CKF5595	CSK80	DRC108	DRCF108			CT007
XC-W 250 (Diaphragm Spring)	13-16	CK5651		CSK910	DRC275				CT023
XC-W 250	06-12	CK5595	CKF5595	CSK80	DRC108	DRCF108			CT007
Rekluse Aftermarket Clutch for SX/XC 250/300 (2T Models/24 Tooth Steel Plate)	03-11	CK5595	CKF5595	N/A	N/A	N/A			CT049
250 SXS	01-03	CK5595	CKF5595	CSK80	DRC108	DRCF108			CT007
300 EGS	94-99	CK5595	CKF5595	CSK80	DRC108	DRCF108			CT007
300 EXC	94-05	CK5595	CKF5595	CSK80	DRC108	DRCF108			CT007
300 MXC	94-03	CK5595	CKF5595	CSK80	DRC108	DRCF108			CT007
300 MXC	04-05	CK5595	CKF5595	CSK80	DRC108	DRCF108			CT007
SX 300	94	CK5595	CKF5595	CSK80	DRC108	DRCF108			CT007
300 Six Days	96	CK5595	CKF5595	CSK80	DRC108	DRCF108			CT007
XC 300	06-12	CK5595	CKF5595	CSK80	DRC108	DRCF108			CT007
XC 300	13-21	CK5651		CSK910	DRC275				CT023
XC-W 300 (Diaphragm Spring)	13-21	CK5651		CSK910	DRC275				CT023
XC-W 300 2T	14-16	CK5651		CSK910	DRC275				CT023
350 EXC	94	CK5631		CSK80	DRC169				CT030
350 Super Comp	94-95	CK5631		CSK80	DRC169				CT030
EXC-F 350 (Diaphragm spring)	12-17	CK5651		CSK910	DRC273				CT023
EXC-F 350 (Diaphragm spring)	18-22	TBC		TBC	TBC				CT023
SX-F 350	11-15	CK5651		CSK91	DRC260				CT023
SX-F 350	16-18	CK5612		CSK221	DRC292				CT023
SX-F 350	19-22	TBC		TBC	TBC				CT023
XC-F 350	12-15	CK5651		CSK91	DRC260				CT023
XC-F 350	16-21	CK5612		CSK221	DRC292				CT023
XC-F-W 350 (Diaphragm spring)	12-15	CK5651		CSK910	DRC273				CT023
XC-F-W 350	2014 - 2021	CK5651		CSK910	DRC273				CT0233
360 EXC	96-97	CK5595	CKF5595	CSK80	DRC108	DRCF108			CT007
360 MXC	96-97	CK5595	CKF5595	CSK80	DRC108	DRCF108			CT007
360 SX	96-97	CK5595	CKF5595	CSK80	DRC108	DRCF108			CT007
360 Six Days	96	CK5595	CKF5595	CSK80	DRC108	DRCF108			CT007
380 EGS	98-99	CK5631		CSK129	DRC170				CT030
380 EXC	98-02	CK5595	CKF5595	CSK80	DRC108	DRCF108			CT007

CLUTCH APPLICATIONS

EBC BRAKES CLUTCH KITS



KTM



		CK cork OEM style Kit #	CKF carbon fiber style upgrade Kit #	CSK Spring Kit #	DRC Series Kit #	DRCF Series Kit #	SRC Series Kit #	SRK Series Kit #	CT Tool #
380 MXC	98-01	CK5595	CKF5595	CSK80	DRC108	DRCF108			CT007
SX 380	98-02	CK5595	CKF5595	CSK80	DRC108	DRCF108			CT007
390 Duke	13-14	CK5665		CSK237			SRC139	SRK139	
RC 390	14-15	CK5665		CSK237			SRC139	SRK139	
390 Duke	15-17	CK5666		CSK239			SRC140	SRK140	
RC 390	16-17	CK5666		CSK239			SRC140	SRK140	
400 Duke	94-95	CK5631		CSK80	DRC169				CT030
400 EGS	94	CK5631		CSK80	DRC169				CT030
400 EGS	96-97	CK5631		CSK129	DRC170				CT030
400 EGS-E	97	CK5631		CSK129	DRC170				CT030
EXC 400 (LC4 Engine)	93-95	CK5632		CSK11	DRC178				CT075
400 EXC	94	CK5631		CSK80	DRC169				CT030
400 EXC	96	CK5631		CSK129	DRC170				CT030
400 EXC	00-01	CK5602		CSK210	DRC117				CT059
400 EXC	07	CK5612		CSK210	DRC171				CT023
400 EXC Racing	02	CK5612		CSK210	DRC171				CT023
400 EXC Racing	05	CK5612		CSK210	DRC154				CT023
400 EXC-G Racing	02	CK5612		CSK210	DRC171				CT023
400 EXC-G Racing	05	CK5612		CSK210	DRC154				CT023
400 EXC-G Racing	06	CK5612		CSK210	DRC171				CT023
400 LC-4	98	CK5631		CSK129	DRC170				CT030
LC4-R 400	99	CK5631		CSK129	DRC170				CT030
400 LC4-E	00-01	CK5631		CSK129	DRC170				CT030
400 LSE	97	CK5631		CSK129	DRC170				CT030
400 LSE	04	CK5631		CSK129	DRC170				CT030
400 MXC	01	CK5602		CSK210	DRC117				CT059
400 MXC	02	CK5612		CSK210	DRC171				CT023
400 Super Comp	95	CK5631		CSK80	DRC169				CT030
RXC-E 400	95	CK5595	CKF5595	CSK11	DRC108	DRCF108			CT007
400 Super Comp/EXC	96-99	CK5631		CSK129	DRC170				CT030
400 RXC-E	95	CK5632		CSK11	DRC178				CT075
400 RXC-E	96-97	CK5631		CSK129	DRC170				CT030
SC 400 (LC4 Engine)	93-95	CK5632		CSK11	DRC178				CT075
SXC 400	97	CK5631		CSK129	DRC170				CT030
400 SXC	98	CK5631		CSK129	DRC170				CT030
400 SX	99	CK5631		CSK129	DRC170				CT030
SX 400	00-01	CK5602		CSK210	DRC117				CT059
400 SX Racing	02	CK5612		CSK210	DRC171				CT023
400 SXC	00	CK5631		CSK129	DRC170				CT030
400 TXC	98	CK5631		CSK129	DRC170				CT030
XC-W 400	10-11	CK5648		CSK140	DRC252				CT041
EXC 440	94-95	N/A		N/A	N/A				
SX 440	94	N/A		N/A	N/A				
MXC 440	94	N/A		N/A	N/A				
450 EXC	06-07	CK5612		CSK210	DRC171				CT023
EXC 450	10-11	CK5648		CSK140	DRC252				CT041
450 EXC Racing	03	CK5612		CSK210	DRC171				CT023
450 EXC-G Racing	03	CK5612		CSK210	DRC171				CT023
450 EXC Racing	04	CK5602		CSK210	DRC117				CT059
450 EXC Racing	05	CK5612		CSK210	DRC154				CT023
450 EXC-G Racing	04	CK5602		CSK210	DRC117				CT059
450 LXC-G Racing	05	CK5612		CSK210	DRC154				CT023
450 EXC	04-08	CK5612		CSK210	DRC154				CT023
EXC-R 450	08	CK5648		CSK140	DRC252				CT041
MXC 450	06	CK5612		CSK210	DRC171				CT023
450 MXC-G Racing	03	CK5612		CSK210	DRC171				CT023
450 MXC-G Racing	04	CK5602		CSK210	DRC117				CT059

CLUTCH APPLICATIONS

EBC BRAKES CLUTCH KITS



KTM



		CK cork OEM style Kit #	CKF carbon fiber style upgrade Kit #	CSK Spring Kit #	DRC Series Kit #	DRCF Series Kit #	SRC Series Kit #	SRK Series Kit #	CT Tool #
450 MXC-G Racing	05	CK5612		CSK210	DRC154				CT023
450 SMR	04-08	CK5612		CSK210	DRC154				CT023
SMR 450	06	CK5612		CSK210	DRC171				CT023
SMR 450	07-12	TBA		TBA					
450 SMS	04	CK5612		CSK210	DRC172				CT023
SX 450	06	CK5612		CSK210	DRC171				CT023
SX 450	09-12	CK5638		CSK136	DRC184				CT009
450 SX Racing	03	CK5612		CSK210	DRC171				CT023
450 SX Racing	04	CK5602		CSK210	DRC117				CT059
450 SX Racing	05	CK5612		CSK210	DRC154				CT023
SX-F 450 (Coil Spring)	07-12	CK5638		CSK136	DRC184				CT009
SX-F 450 (Diaphragm spring)	12	CK5651		CSK910	DRC273				CT023
SX-F 450 (Diaphragm spring)	13	CK5651		CSK910	DRC275				CT023
SX-F 450 (Diaphragm spring)	14-17	CK5651		CSK910	DRC281				CT023
SX-F 450 (Diaphragm spring)	18	CK5651		CSK909	DRC281				CT023
SX-F 450 (Diaphragm spring)	19-22	CK5651		CSK909	DRC281				CT023
XC 450	08-12	CK5612		CSK210	DRC171				CT023
XC-F 450	08-09	CK5638		CSK136	DRC184				CT009
XC-F 450 (Diaphragm spring)	13	CK5651		CSK910	DRC275				CT023
XC-F 450 (Diaphragm spring)	14-21	CK5651		CSK909	DRC281				CT023
XCR-W 450	08	CK5648		CSK140	DRC252				CT041
XC-W 450	08-12	CK5638		CSK136	DRC184				CT009
XC-W 450 Champions Edition	10	CK5648		CSK140	DRC252				CT041
XC-W 450 (Diaphragm spring)	12-13	CK5651		CSK910	DRC273				CT023
XC-W 450 (Diaphragm spring)	14-21	CK5651		CSK909	DRC281				CT023
XC-W 450 Six Days	10-11	CK5648		CSK140	DRC252				CT041
EXC 500 (Diaphragm spring)	12	CK5651		CSK910	DRC273				CT023
EXC 500 (Diaphragm spring)	13-15	CK5651		CSK910	DRC275				CT023
EXC-F 500 (Diaphragm spring)	17	CK5651		CSK909	DRC281				CT023
EXC-F 500 (Diaphragm spring)	18-21	CK5651		CSK909	DRC281				CT023
EXC 500 Six Days	13-16	CK5651		CSK910	DRC275				CT023
EXC-F 500 Six Days (Diaphragm spring)	18-21	CK5651		CSK909	DRC281				CT023
XC-W 500 (Diaphragm spring)	12	CK5651		CSK910	DRC273				CT023
XC-W 500 (Diaphragm spring)	13-15	CK5651		CSK910	DRC275				CT023
SX 505	09-12	CK5638		CSK136	DRC184				CT009
SX-F 505	07-08	CK5638		CSK136	DRC184				CT009
XC-F 505	08-09	CK5638		CSK136	DRC184				CT009
520 EXC	00-01	CK5602		CSK210	DRC117				CT059
SX 520	00-01	CK5602		CSK210	DRC117				CT059
520 SX Racing	02	CK5612		CSK210	DRC171				CT023
525 EXC-G Racing	03	CK5612		CSK210	DRC171				CT023
525 EXC	03	CK5612		CSK210	DRC171				CT023
525 EXC Racing	04	CK5602		CSK210	DRC117				CT059
525 EXC Racing	05	CK5612		CSK210	DRC154				CT023
525 EXC-G Racing	04	CK5602		CSK210	DRC117				CT059
525 EXC-G Racing	05	CK5612		CSK210	DRC154				CT023
EXC 525 Racing	07	CK5612		CSK210	DRC171				CT023
MXC 525	06	CK5612		CSK210	DRC171				CT023
525 MXC Desert Racing	03	CK5612		CSK210	DRC171				CT023
525 MXC Desert Racing	04	CK5602		CSK210	DRC117				CT059
525 MXC Desert Racing	05	CK5612		CSK210	DRC154				CT023
525 MXC-G Racing	04	CK5602		CSK210	DRC117				CT059
525 SMR	04-05	CK5612		CSK210	DRC154				CT023
SX 525	06	CK5612		CSK210	DRC171				CT023
525 SX Racing	03	CK5612		CSK210	DRC171				CT023
525 SX Racing	04	CK5602		CSK210	DRC117				CT059
525 SX Racing	05	CK5602		CSK210	DRC154				CT023

CLUTCH APPLICATIONS

EBC BRAKES CLUTCH KITS



KTM



		CK cork OEM style Kit #	CKF carbon fiber style upgrade Kit #	CSK Spring Kit #	DRC Series Kit #	DRCF Series Kit #	SRC Series Kit #	SRK Series Kit #	CT Tool #
XC 525	08-12	CK5612		CSK210	DRC171				CT023
EXC 530 (9 Friction plates)	10-11	CK5648		CSK140	DRC252				CT041
EXC 530 Champion Edition (9 Friction plates)	10	CK5648		CSK140	DRC252				CT041
EXC-R 530 (9 Friction plate kit)	08	CK5648		CSK140	DRC252				CT041
WCR-W 530 (9 Friction plate kit)	08	CK5648		CSK140	DRC252				CT041
XC-W 530 Six Days (9 Friction plates)	10-11	CK5648		CSK140	DRC252				CT041
540 SXC	98-99	CK5639		CSK129	DRC196				CT030
540 SXS Racing	02	CK5612		CSK210	DRC171				CT023
MXC 550	94-96	N/A		N/A	N/A				
SMR 560	06	CK5612		CSK210	DRC171				CT023
620 Duke	94	CK5631		CSK80	DRC169				CT030
620 Duke	97	CK5631		CSK129	DRC170				CT030
620 EGS	94-95	CK5631		CSK80	DRC169				CT030
620 EGS-E	97	CK5631		CSK129	DRC170				CT030
620 EGS/Adventure	96-97	CK5631		CSK129	DRC170				CT030
620 Enduro Ltd	97	CK5631		CSK129	DRC170				CT030
620 EXC	94-95	CK5631		CSK80	DRC169				CT030
620 LC4	98	CK5631		CSK129	DRC170				CT030
620 LC4 Competition	99	CK5639		CSK129	DRC196				CT030
620 LC4 Super Moto	99	CK5639		CSK129	DRC196				CT030
620 LSE	97	CK5631		CSK129	DRC170				CT030
620 Six Days	96	CK5631		CSK129	DRC170				CT030
620 Super Comp	94-95	CK5631		CSK80	DRC169				CT030
620 Super Comp	96-99	CK5639		CSK129	DRC196				CT030
SX 620	97-99	CK5639		CSK129	DRC196				CT030
SX 620	99	CK5639		CSK129	DRC196				CT030
RXC-E 620	95	CK5595	CKF5595	CSK11	DRC108	DRCF108			CT007
620 RXC-E	95	CK5632		CSK11	DRC178				CT075
620 RXC-E	96-97	CK5631		CSK129	DRC170				CT030
620 SC	00-01	CK5639		CSK129	DRC196				CT030
SXC 620	97	CK5631		CSK129	DRC170				CT030
620 Supermoto	98	CK5639		CSK129	DRC196				CT030
620 TXC	98	CK5639		CSK129	DRC196				CT030
625 SMC	04-06	CK5639		CSK129	DRC196				CT030
625 SC	02	CK5639		CSK129	DRC196				CT030
625 SXC	03-04	CK5639		CSK129	DRC196				CT030
640 Adventure-R	98-02	CK5639		CSK129	DRC196				CT030
640 Duke-E	98	CK5639		CSK129	DRC196				CT030
640 Duke-II	99-04	CK5639		CSK129	DRC196				CT030
640 LC Rallye Dakar	97	CK5631		CSK129	DRC170				CT030
640 LC4	99-00	CK5639		CSK129	DRC196				CT030
640 LC4-E	00-02	CK5639		CSK129	DRC196				CT030
640 LC4 Adventure	03-06	CK5639		CSK129	DRC196				CT030
640 LC4 Supermoto	03-04	CK5639		CSK129	DRC196				CT030
640 LC4 Six Days	99	CK5639		CSK129	DRC196				CT030
660 LC4	97	CK5631		CSK129	DRC170				CT030
660 LC4 Rallye	99-00	CK5639		CSK129	DRC196				CT030
660 Rallye	01-03	CK5633		CSK129	DRC176				CT030
660 Rallye Factory	04	CK5633		CSK129	DRC176				CT030
660 SM Factory Replica	02-03	CK5639		CSK131	DRC175				CT030
660 SMC	03-04	CK5639		CSK131	DRC175				CT030
660 SMS	04	CK5639		CSK131	DRC175				CT030
690 Duke	08-14	CK5642		CSK131	DRC205				CT069
690 Enduro	08	CK5642		CSK131	DRC205				CT069
690 Enduro R	10-16	CK5642		CSK131	DRC205				CT069
690 Rally Factory Rep	07-08	CK5641		CSK131	DRC199				CT030
690 SMC	08-11	CK5642		CSK131	DRC205				CT069

CLUTCH APPLICATIONS

Part numbers, prefixes, suffixes, photos and illustrations shown in this catalog are trademarks and/or copyrights of EBC Brakes or the trademark owner A C Freeman Investments Ltd and use without express written permission of the owners is punishable by law.

EBC BRAKES CLUTCH KITS



KTM



		CK cork OEM style Kit #	CKF carbon fiber style upgrade Kit #	CSK Spring Kit #	DRC Series Kit #	DRCF Series Kit #	SRC Series Kit #	SRK Series Kit #	CT Tool #
690 SMR (Cast Wheel)	07-09	CK5642		CSK131	DRC205				CT069
690 Supermoto	07-08	CK5642		CSK131	DRC205				CT069
790 Duke	17-23	CK5669		CSK274	DRC320				TBA
790 Adventure	17-23	CK5669		CSK274	DRC320				TBA
890 Duke	21-23	CK5669		CSK274	DRC320				TBA
890 Adventure	21-23	CK5669		CSK274	DRC320				TBA
950 Adventure S	03-04	CK5634		CSK130	DRC177				CT015
950 Adventure	06	CK5634		CSK130	DRC177				CT015
950 Superenduro R	07-08	CK5634		CSK130	DRC177				CT015
950 Supermoto	05-07	CK5634		CSK130	DRC177				CT015
990 Adventure	07-11	CK5634		CSK130	DRC177				CT015
990 Adventure Baja Edition	13-14	CK5634		CSK130	DRC177				CT015
990 Adventure S	07-09	CK5634		CSK130	DRC177				CT015
990 SM-T	10-14	CK5634		CSK130	DRC177				CT015
990 SM-R	09-11	CK5634		CSK130	DRC177				CT015
990 Superduke	05-11	CK5634		CSK130	DRC177				CT015
990 Superduke R	07-11	CK5634		CSK130	DRC177				CT015
1050 Adventure	15-16	CK5683		CSK275			SRC168	SRK168	
1090 Adventure Inc R model	17-19	CK5683		CSK275			SRC168	SRK168	
1090 Adventure L and S models	2019	CK5683		CSK275			SRC168	SRK168	
1190 Adventure/Adventure R	13-16	CK5683		CSK275			SRC168	SRK168	
1190 RC8 R (3 Spring Type Clutch)	13-14	CK5683		CSK161			SRC168	SRK168	
1290 Super Adventure	15-16	CK5683		CSK275			SRC168	SRK168	
1290 Super Adventure R&S models	17-21	CK5683		CSK275			SRC168	SRK168	
1290 Super Adventure T	17	CK5683		CSK275			SRC168	SRK168	
1290 Superduke GT	17-19	CK5683		CSK275			SRC168	SRK168	
1290 Superduke R	16-19	CK5683		CSK275			SRC168	SRK168	
LIFAN									
LF 200 GY-S	05-08	CK1119		CSK77	DRC209				CT012SP
OHVALE									
GP-O 110cc, 160cc	19-20	CK1119							
MORIWAKI/HONDA									
MD 250 H	08-11	CK1305	CKF1305	CSK176					CT001
MD 250 S	08-11	CK1305	CKF1305	CSK176					CT001
TRIUMPH									
Adventurer	96-01	CK5588	CKF5588	CSK68					CT021
America (Cast Wheel)	07-09	CK5608		CSK15					
Bonneville 800 (790cc) Up to Engine no. 211132	01-04	CK5597		CSK15					CT009SP
Bonneville 800 From Engine no. 211133	01-04	CK5608		CSK15					
Bonneville America	02-06	CK5608		CSK15					
Bonneville/Bonneville Black (865cc)	07-08	CK5608		CSK15					
Bonneville (865cc)	09	CK5608		TBA					
Bonneville SE (865cc)	09	CK5608		TBA					
Bonneville T-100 (790cc) Up to Engine no. 211132	02-04	CK5597		CSK15					CT009SP
Bonneville T-100 From Engine No. 211133	02-04	CK5608		CSK15					
Bonneville T-100 (865cc)	05-09	CK5608		CSK15					
Bonneville - Steve McQueen SE	12	CK5608		CSK15					
Bonneville T100 (900cc/Liquid Cooled)	16-23	CK5669		CSK244			SRC147	SRK147	CT086SP
Bonneville T100 Black (900cc/Liquid Cooled)	16-21	CK5669		CSK244			SRC147	SRK147	CT086SP
Bonneville T120 (1200cc Liquid Cooled)	16-23	CK5669		CSK243			SRC146	SRK146	CT086SP
Bonneville T120 Black (1200cc Liquid Cooled)	16-21	CK5669		CSK243			SRC146	SRK146	CT086SP
Bonneville Bobber (1200cc Liquid Cooled)	17-23	CK5669		CSK243			SRC146	SRK146	CT086SP
Bonneville Bobber Black (1200cc Liquid Cooled)	18-21	CK5669		CSK243			SRC146	SRK146	CT086SP

CLUTCH APPLICATIONS

EBC BRAKES CLUTCH KITS



TRIUMPH



		CK cork OEM style Kit #	CKF carbon fiber style upgrade Kit #	CSK Spring Kit #	DRC Series Kit #	DRCF Series Kit #	SRC Series Kit #	SRK Series Kit #	CT Tool #
T595 Daytona (9 Friction Plates)	97-98	CK5589	CKF5589	CSK29					CT009
Daytona 600	02-05	CK1206	CKF1206	CSK83					CT013SP
Daytona 650	05	CK1181		CSK15					CT014
Daytona 675	06-12	CK1206	CKF1206	CSK135					CT014
Daytona 675	13-	CK5664							
Daytona 675 R	11-12	CK1206	CKF1206	CSK135					CT014
Daytona 675 R	13-	CK5664							
Daytona 750 (3cyl)	92	CK5588	CKF5588	CSK68					CT021
Daytona 900 (3cyl)	93-96	CK5588	CKF5588	CSK68					CT021
Daytona 955i (10 Friction Plates)	99-06	CK5599	CKF5599	CSK29					CT009
Daytona 1000 (4cyl)	92	CK5588	CKF5588	CSK15					CT021
Daytona Super III (3cyl)	94-97	CK5588	CKF5588	CSK68					CT021
Daytona 1200 (4cyl)	93-98	CK5588	CKF5588	CK45					CT021
Legend TT	98-01	CK5588	CKF5588	CSK68					CT021
Rocket III 2300cc	04-09	CK5624		CSK118					CT021
Rocket III Classic	07-09	CK5624		CSK118					CT021
Rocket III Roadster ABS	10-12	CK5624		CSK118					CT021
Rocket III Touring	08-12	CK5624		CSK118					CT021
Scrambler (865cc)	06-09	CK5608		CSK15					
Speedmaster 800 (790cc) Up to VIN 210261	03-04	CK5608		CSK15					
Speedmaster From VIN 210262	03-04	CK5608		CSK15					
Speedmaster (865cc)	05-09	CK5608		CSK15					
Speed Triple (Carb models)	94-97	CK5588	CKF5588	CSK68					CT021
Speed Triple (EFI)	97-01	CK5589	CKF5589	CSK29					CT009
Speed Triple 955cc (From VIN 141872 to 210444)	02-04	CK5599		CSK29					CT009
Speed Triple (1050cc)	05-08	CK5599		CSK29					CT009
Speed Triple R (1050cc)	12	CK5599		CSK29					
Sprint GT 1050	10-12	CK5599		CSK29					
Sprint ST (1050cc) (From VIN 208167)	05-09	CK5599		CSK29					CT009
Rocket III 2300cc (All models)	04-09	CK5624		CSK118					CT021
Sprint (All carb models up to VIN 9082)	93	CK5588	CKF5588	CSK68					CT021
Sprint (All carb models from VIN 9083)	94-98	CK5588	CKF5588	CSK68					CT021
Sprint RS (Up to VIN 139276)	99-01	CK5589	CKF5589	CSK29					CT009
Sprint RS (From VIN 139277)	02-04	CK5599		CSK29					CT009
Sprint ST (Up to VIN 139276)	99-01	CK5589	CKF5589	CSK29					CT009
Sprint ST (From VIN 139277 to 208166)	02-04	CK5599		CSK29					CT009
Street Cup (900cc Liquid Cooled)	16-20	CK5669		CSK244			SRC147	SRK147	CT086SP
Street Scrambler (900cc Liquid Cooled)	16-20	CK5669		CSK244			SRC147	SRK147	CT086SP
Street Triple 675	07-16	CK1206	CKF1206	CSK135					CT014
Street Triple R 675	09-16	CK1206	CKF1206	CSK135					CT014
Street Triple S 765	17-23	CK5664		CSK135					CT014
Street Triple R 765	17-23	CK1206	CKF1206	CSK135					CT014
Street Triple RS 765	17-23	CK1206	CKF1206	CSK135					CT014
Street Twin (900cc Liquid Cooled)	16-23	CK5669		CSK244			SRC147	SRK147	CT086SP
TT 600	00-03	CK1206	CKF1206	CSK83					CT013SP
Thunderbird	95-03	CK5588	CKF5588	CSK68					CT021
Thunderbird Sport	98-04	CK5588	CKF5588	CSK68					CT021
Thunderbird (1597cc)	09-12	TBA		TBA					
Thunderbird Storm (1699cc)	11-12	TBA		TBA					
Thrupton 900	04-12	CK5608		CSK15					
Tiger 800	11-12	CK1206	CKF1206	CSK135			SRC166	SRK166	CT014
Tiger 800 XC	11-12	CK1206	CKF1206	CSK135			SRC166	SRK166	CT014
Tiger 800 XR (from VIN 674842)	>2018	CK5681		TBA			SRC166	SRK166	CT014
Tiger 900cc (Up to VIN 71698) Carb Models	93-96	CK5588	CKF5588	CSK68					CT021
Tiger 900cc (From VIN 71699) Injection Models	97-98	CK5589	CKF5589	CSK29					CT009
Tiger 955cc (Up to VIN 198874)	99-04	CK5589	CKF5589	CSK29					CT009
Tiger 955 (From VIN 198875)	04-06	CK5589	CKF5589	CSK29					CT009

CLUTCH APPLICATIONS

Part numbers, prefixes, suffixes, photos and illustrations shown in this catalog are trademarks and/or copyrights of EBC Brakes or the trademark owner A C Freeman Investments Ltd and use without express written permission of the owners is punishable by law.

CK CLUTCH KIT BUYERS GUIDE

Part no.	Make/Model	Year	Part no.	Make/Model	Year
CK1105	HONDA SL70 K1	70-73	CK1135	HONDA CB 500 / K1 / K3	71-73
CK1119 CKF1119 CT012SP ■	HONDA CR 80 R CR 85 R/85 R Expert SL 100 K1/K2/K3 XL 100 XL 100 K1 CB 125s/S1/S2 CG 125 Drum Front Brake CGT 125 (ES12/ES2/3/4) Disc Front Brake CL 125s CT 125 NXR 125 (JC30) SL 125 K1/K2 TL 125s XL 125s XL 125 K1 XL 125 CRF 150 F NXR 150 (KD03) XL 185s XR 185 ATC 200 X CM 200 T TRX 200sX Fourtrax TLR 200 TR 200 'Fatcat' XL 200 R XR 200 TRX 200 D Type II Fourtrax XR 200 R XR 200 R TRX 250 EX TRX 250 X TRX 250 TE Recon ES TRX 250 TM Recon KAWASAKI KLT 160 A1 KLF 185 A1/A1A/A2/A3/A4 Bayou KLT 185 A1/A2 LIFAN LF 200 GY-S OHVALE GP-0 110cc,160cc	84-02 ■ 03-07 ■ 70-74 ■ 74/76-78 ■ 75 ■ 80-82 ■ 01-06 ■ 01-04 ■ 84-85 ■ 77 ■ 03-08 ■ 71-73 ■ 76 ■ 79-85 ■ 74-75 ■ 76-78 ■ 06-19 ■ 03-08 ■ 79-83 ■ 79 ■ 83-87 ■ 80-82 ■ 86-91 ■ 86-87 ■ 86-87 ■ 83-84 ■ 80-84 ■ 91-97 ■ 81-83 ■ 86-02 ■ 01-08 ■ 09-14 ■ 97-14 ■ 97-14 ■ 85 ■ 85-88 ■ 86-87 ■ 05-08 ■ 19-20 ■	CK1140 CT013SP ■	HONDA CB 350 F/F1 CB 400 F CB 400 T 'Hawk' All models CM 400 T/C/E CB 450 DX-K CB 450 T 'Hawk' CB 450sC 'Nighthawk' CM 450 C Custom CM 450 E CMX 450 C 'Rebel' FT 500 'Ascot' XL 500s XL 500 R	75-77 ■ 78-81 ■ 79-81 ■ 89-92 ■ 82 ■ 82-86 ■ 82 ■ 82-83 ■ 86-87 ■ 82-83 ■ 79-81 ■ 82 ■
CK1123	HONDA CD 175 CL 175 (6 Friction Plate Clutch)	67-68 68-69	CK1143	HONDA GL 1000 K Goldwing (Up to Engno 1020727) GL 1000 Goldwing All models	75 76-79
CK1130 CT031 ▲	HONDA CB 450 K2-K7	▲	CK1144 CT002 ▲	HONDA CT 125 M/M1 Elsinore MT 125 K1 Elsinore MR 175 Elsinore	73-78 ▲ 74-76 ▲ 75-77 ▲
CK1131 CT009 ▲	HONDA CR 250 R CR 250 M1/M/M76 Elsinore MR 250 Elsinore MT 250 K1/76 TL 250 XL 250 K1/K2/76 XL 350 K1 XL 350 CR 450 R	81 ▲ 73-77 ▲ 76 ▲ 74-76 ▲ 75-76 ▲ 72-76 ▲ 74-75 ▲ 76-78 ▲ 81 ▲	CK1145	HONDA CB 750 F 'Supersport' CB 750 K	76 77-78
CK1132 CT009 ▲	HONDA CB 350 G/K2/K3/K4 CB 360/360 G/T	75-77 ▲	CK1146	HONDA CX 500 C/D Custom/Deluxe GL 500/500 Isilverwing/Silverwing Interstate CB 550 F/K	79-82 81-82 75-78
CK1133	HONDA CB 750 K1/K2/K3/K4/K5	71-75	CK1147	HONDA CB 550 K/K1 CB 650 CB 650 C Custom CB 650sC 'Nighthawk' CX 650 C Custom GL 650/650 Isilverwing/Silverwing Interstate	74-75 79-82 80-81 82 83 83
CK1134	HONDA SL 175 K1 XL 175 K1/K2 XL 175 SL 350 K/K1/K2	73-73 73-75 72-78 69-73	CK1148	HONDA CRF 50 F XR 50 R C 70 CRF 70 F CT 70 Trail SL 70 K1 XR 70 R ATC 70 TRX 70	04-21 00-03 80-83 04-14 77-82/91-94 70-73 97-03 78-85 86-87
			CK1149 CT021 ▲	HONDA CB 750 C Custom CB 750 F 'Supersport' CB 750 K CB 750 Limited Edition CB 750sC 'Nighthawk' CB 900 C Custom HONDA CB 900 Fsupersport CB 1000 C Custom CB 1100 Fsupersport	80-82 ▲ 79-82 ▲ 79-82 ▲ 79 ▲ 82-83 ▲ 80-82 ▲ 81-82 ▲ 83 ▲ 83 ▲
			CK1150 CT012SP ■	HONDA Dream 50 R (CB50) NSR 50 MB5 XL 75 XR 75/K1/K2/76 XR 75 CRF 80 F XL 80s 80/ XR 80 R	04 ■ 04 ■ 82 ■ 77-79 ■ 71-76 ■ 77-78 ■ 04-16 ■ 80-85 ■ 79-03 ■

CK CLUTCH KIT BUYERS GUIDE

Part no.	Make/Model	Year	Part no.	Make/Model	Year	
CK1151 CKF1151 CT012SP ■	HONDA		CK1166 CT031 ▲ Contd.	VF 750s V45 'Sabre'	82-83 ▲	
	CRF 100 F	04-14 ■		VT 750 C 'Shadow'	83 ▲	
	ATC 125 M	86-87 ■	CK1167 CT031 ▲ CT009 ■	VT 800shadow	88 ▲	
	ATC 185/185s	80-83 ■		HONDA		
	ATC 200/E/ES/M/S	81-86 ■	VF 700 F 'Interceptor'	84-85 ▲		
	TRX 125 Fourtrax	87-88 ■	VF 750 F V45 'Interceptor'	83-84 ▲		
	TRX 200 Fourtrax	84 ■	PC 800 Pacific Coast	89-90/94-98 ■		
	CR 60 R	83-84 ■	CK1170 CKF1170 CT009 ▲	HONDA		
	CR 80 R	80-83 ■		CR 250 R	82-89 ▲	
	TRX 90	93-06 ■		CR 480 R	82-83 ▲	
	TRX 90 EX	07-08 ■		CR 500 R	84-89 ▲	
	TRX 90 X	09-14 ■		XR 500 R	83-84 ▲	
	XL 100s	79-85 ■		XL 600 R	83-87 ▲	
	XR 100 R	81-03 ■		XR 600 R	85-00 ▲	
	TL 125 K1/K2	71-75 ■		NX 650	88-89 ▲	
	YAMAHA			XR 650 L	93-22 ▲	
	YBR 125 (2D0D/2CS1)	11-13 ■		CK1171 CT009 ▲	HONDA	
YBR 125 C (36S1/2/3/4)	08-13 ■	CB 550sC 'Nighthawk'	83 ▲			
YBR 125 E (4P24/4P27/4P2B/4P2H)	06-13 ■	CK1176 CT031 ■ CT009 ▲	CB 650sC 'Nighthawk'	83-85 ▲		
YBR 125 ED (4P28) Cast Wheel	07-09 ■		HONDA			
YBR 125 ED (4P2C/4P2J) Cast Wheel	10-13 ■		VF 1000 F 'Interceptor'	84 ■		
YBR 125 ESD (4P26) Cast Wheel	07-09 ■		VF 1000 R	85-86 ■		
YBR 125 ESD (4P2A/4P2G) Cast Wheel	10-13 ■		VT 1100 Cshadow 1100spirit	97-06 ▲		
YBR 125 ESG (43B1/3/5/6/8)	08-13 ■		VT 1100 C2shadow 1100 American Classic Edition	95-97 ▲		
YBR 125 R (1PX1/X2)	11-12 ■		VT 1100 C2-2shadow 1100 American Classic Edition	97 ▲		
YFM 125 RA/RB/RD Raptor	11-13 ■		VT 1100 D2shadow 1100 American Classic Edition	99 ▲		
CK1152 CT013SP ■	HONDA			VT 1100 CD2shadow sabre	00-06 ▲	
	XL 250s		78-80 ■	VT 1100 C3shadow Aero	98-02 ▲	
	XR 250	79-80 ■	VT 1100 Tshadow 1100 American Classic Edition Tourer	98-01 ▲		
CK1153 CT013SP ■	HONDA		CK1177 CT002 ▲	HONDA		
	XL 250s	81 ■		VF 500 C 'V30 Magna'	84-85 ▲	
	XL 250 R	82-83 ■		VF 500 F 'Interceptor'	84-86 ▲	
CK1154 CT013SP ■	XR 250 R	81-82 ■	CK1180 CT013SP ■	HONDA		
	HONDA			XR 200 R	84-85 ■	
	TRX 420 TM Fourtrax Rancher	07-13 ■		XL 250 R	84-87 ■	
	TRX 420 FM7/FM8/FM9 Fourtrax Rancher 4x4	07-13 ■		XR 250 R	84-85 ■	
	TRX 420 FPM/FPMA Fourtrax 4WD	09-13 ■		KAWASAKI		
	TRX 500 FE Fourtrax Foreman 4x4/ES	05-11 ■		KLF 220 A1-A15 Bayou	88-02 ■	
	TRX 500 FM Fourtrax Foreman 4x4	05-11 ■		KLF 250 Bayou	03-11 ■	
	TRX 500 FM Fourtrax Foreman	12-13 ■		CK1181 CKF1181 CT013 ▲ CT013SP ■ CT014 ★	HONDA	
	TRX 500 TM Fourtrax Foreman 2x4	05-06 ■			CB 500 R/T/V/W	94-98 ■
	TRX FE Fourtrax Foreman	12-13 ■			XL 600 V	89-90 ■
	TRX 500 FPE Fourtrax Foreman 4x4 ES/EPS	08-11 ■	VT 600 C/CDshadow VLX CD2shadow Deluxe		88/91-07 ■	
	TRX FPE Fourtrax Foreman	12-13 ■	CBR 650 F (Non ABS)	14-21 ■		
	TRX 500 FPM Fourtrax Foreman 4x4/EPS	08-11 ■	CBR 650 FA (ABS)	14-21 ■		
	TRX 500 FPM Fourtrax Foreman	12-13 ■	SUZUKI			
XR 500	79-80 ■	DR-Z 250 K1/K2/K3/K4/K5/K6/K7	01-07 ▲			
XR 500 R	81-82 ■	TRIUMPH				
CK1156	HONDA		Daytona 650	05 ★		
	ATC 110	79-85	CK1183 CT066SP ▲	HONDA		
	ATC 125 M	84-85		CBX	79-82 ▲	
	TRX 125 Fourtrax	85-86		CK1186 CT002	HONDA	
CT 110 Trail	80-86	CR 125 R			82	
CK1159 CT053SP ▲	HONDA		CK1190 CKF1190 CT013 ▲ CT013SP ■	HONDA		
	CX 500 TC Turbo	82 ▲		CR 125 R	83-84 ■	
	CX 650 T Turbo	83 ▲		NX 250	88-90 ■	
	GL 1100/1100 1 Goldwing/Goldwing Interstate	80-83 ▲		TRX 250 X Fourtrax	87-88/91-92 ■	
GL 1100 A Goldwing Aspencade	82-83 ▲	XR 250 L	91-96 ■			
CK1160 CT013SP ■	HONDA		XR 250 R	86-04 ■		
	TRX 350 TE/FE	00-05 ■	TRX 300 EX Fourtrax/Sportrax	93-08 ■		
	VT 500 C 'Shadow'	83-86 ■	TRX 300 X	09-11 ■		
CK1163	HONDA		XR 350 R	83-85 ■		
	ATC 250 R	81-84	ATC 350 X	85-86 ■		
CR 250 R	78-80	CK1166 CT031 ▲	HONDA			
CK1166 CT031 ▲	HONDA			CB 700sC/S 'Nighthawk'	84-86 ▲	
	VF 700 C 'Magna'		84-87 ▲	VF 700 C 'Magna'	84-87 ▲	
	VF 700s 'Sabre'		84-85 ▲	VF 700s 'Sabre'	84-85 ▲	
	VT 700 C 'Shadow'		84-87 ▲	VT 700 C 'Shadow'	84-87 ▲	
	VF 750 C V45 'Magna'		82-88 ▲	VF 750 C V45 'Magna'	82-88 ▲	

CK CLUTCH KIT BUYERS GUIDE

Part no.	Make/Model	Year	Part no.	Make/Model	Year
CK1191 CKF1191 CT002 ▲ CT012SP ■	HONDA CR 125 R Elsinore CRF 150 R/RB CB 250nighthawk CM 250 C Rebel CMX 250 C/C2 Rebel CMX 250 C/CD Rebel	81 ▲ 07-21 ▲ 91-08 ▲ 82-83 ■ 96/97/99-14 ■ 85-87 ■	CK1210 CT053SP ▲	HONDA GL 1200/1200 1-A/1200 L Goldwing	84-85 ▲
CK1193 CKF1193 CT013 ▲ CT013SP ■ CT014 ★ CT080 ●	HONDA ATC 250 R TRX 250 R Fourtrax TRX 400 EX TRX 400 X XR 400 R TRX 450s/ES CBR 600 F4 (Carb Model) YAMAHA YZ-F R3 (321cc) MT-03	85-86 ■ 86-89 ▲ 99-08 ▲ 09-14 ▲ 96-04 ▲ 99-00 ■ 99-00 ★ 15-21 ● 12-21 ●	CK1217 CT013SP ▲ CT014 ■	HONDA CRF 250 F A/AC XL 350 R YAMAHA XTZ 250 Lander XTZ 250 Lander XTZ 250 X YBR 250 (41S2/3) YP 250 Fazer (5D41/2/3/56C1)	19-21 84-85 ▲ 07-14 ■ 16-18 ■ 08-10 ■ 10-12 ■ 06-10 ■
CK1194 CT013SP ■	HONDA ATC 250 ES Big Red ATC 250sX TRX 250 'Fourtrax'	85-87n ■ 85-87n ■ 85-87n ■	CK1218 CKF1218 CT014 ▲	HONDA CBR 600 RR/RA CBR 600 F4isport (Injection Model) VFR 800/A Interceptor ABS CBR 900 RR 919 (CB 900 F) SUZUKI GSX 650 FK8/FK9	03-20 ▲ 01-06 ▲ 02-11 ▲ 98-99 ▲ 02-07 ▲ 08-10 ▲
CK1196 CT013SP ■	HONDA TRX 300 (All Models 2WD/4WD) TRX 350 (All Models 2WD/4WD) TRX 350 TM/FM TRX 400 FW 'Fourtrax Foreman' TRX 400 FM TRX 420 TE Fourtrax Rancher ES TRX 420 FPA Fourtrax Rancher 4x4 ES/EPS TRX 420 FE/FEA Fourtrax Rancher 4x4/ES TRX 420 FE1 Rancher 4x4 ES TRX 420 FM1 Rancher 4x4/4x4 EPS TRX 420 TE1 Rancher ES TRX 420 TM1 Rancher TRX 450 ES/S TRX 450 FE Fourtrax Foreman ES/ FM Fourtrax Foremans	88-00 ■ 86-89 ■ 00-05 ■ 95-01/03 ■ 02 ■ 07-13 ■ 09-13 ■ 07-13 ■ 14-15 ■ 14-15 ■ 14-15 ■ 98-03 ■ 02-04 ■	CK1219 CT009 ▲ CT022 ■ CT033SP ●	HONDA GB 500 SUZUKI DL 650 V-Strom DL 650 AAL2/AAL3/AAL4/AAL5 DL 650 XT Vstrom ABS (DL650 XAL5/XAL6) SFV 650 K9/L3/L4/L5 SV 650 AK7/AK8 ABS SV 650 AL (ABS) SV 650sAK7/SAK8/SAK9 ABS	89-90 ▲ 04-21 ● 12-211 ● 15-21 ● 09-10/13-15 ● 07-08 ■ 16-211 ● 07-10 ●
CK1199	HONDA CR 125 R Elsinore	79-80	CK1221 CT053SP ▲	HONDA GL 1000 K Goldwing (From Engno.1020728)	75 ▲
CK1200 CT001 ▲	HONDA CR 125 R	85 ▲	CK1222 CT001 ▲	HONDA CR 125 R	86-99 ▲
CK1206 CKF1206 CT014 ▲ CT014SP ● CT055SP ■	HONDA CBR 600 F2 CBR 600 F3/SJR/SE 599 (CB 600 F) VFR 700 F/F2 'Interceptor' VFR 750 F 'Interceptor' 750 VFR 750 F VF 750 C Magna/CD Magna Deluxe VFR 800 Fi CBR 900 RR CBR 929 RR CBR 954 RR SUZUKI GSX R 600 V/W/X/Y GSX R 600 K4/K5/XK5 TRIUMPH Daytona 600 Speedfour 600 TT 600 Daytona 675 Street Triple 675 Street Triple R 675 Street Triples/R/RS 675 Tiger 800 Tiger 800 XC Tiger XR	91-94 ● 95-98 ● 04/06 ● 86 ▲ 86 ▲ 90-97 ▲ 94-03 ▲ 98-99 ▲ 93-95 ▲ 00-01 ▲ 02-03 ▲ 97-00 ■ 04-05 ■ 03-04 02-05 00-03 06-09 ▲ 07-12 ▲ 09-16 ▲ 17-21 ▲ 11-12 ▲ 11-12 ▲ 2018-	CK1224	HONDA GL 1200 1-A/GL 12sE/1 GL 1200 1/A Goldwing	86 87
CK1209 CT008 ▲	HONDA VT 1100 Cshadow 1100	85-86 ▲	CK1228 CT009SP ■	HONDA CB-1 400 (CB 400F) CBR 600 F Hurricane CB 600 F1	89-90 ■ 87 ■ 88-90 ■
			CK1229 CT014 ▲	HONDA VFR 750 R (RC30) GSXR 750 Y	90 ▲ 00 ▲
			CK1230 CT013SP ■ CT014SP ▲	HONDA PCX 150 VT 600 Cshadow VLX NT 650 Hawk GT CTX 700n (Naked/Manual G/box) CTX 700 (Top Fairing/Manual G/box) NC 700 X (2 Piston Caliper) NT 700 V/VA NC 750s NC 750s (ABS) NC 750X VT 750 C/CD/CD2/DC/DCA/DCB VT 750 CDA/CDB/CDC/CDDshadow American Classic Edition 750 Deluxe VT 750 Cshadowspirit VT 750 DCshadowspirit VT 750 DCA/DCBshadowspirit VT 750shadow Aero VT 750shadow Aero VT 750shadow Aero VT 750 C2shadowspirit VT 750 CSEshadow Aero (ABS/Rear disc) VT 750 C2Sshadowspirit (ABS/Rear disc) VT 750 RSshadow VT 750 Tshadow Tourer VT 750 C2Bshadow Phantom BENELLI TNT 600 i Tornado	13-14 ■ 89-90 ■ 88-90 ■ 14 ■ 14 ■ 12-17 ■ 10-13 ■ 14-15 ■ 14-18 ■ 14-15 ■ 98-08 ■ 02-03 ■ 07-14 ■ 01-02 ■ 03-07 ■ 08-15 ■ 04-14 ■ 07-14 ■ 13-14 ■ 13-14 ■ 10-14 ■ 09 ■ 10-15 ■ 16-17 ▲

CK CLUTCH KIT BUYERS GUIDE

Part no.	Make/Model	Year	Part no.	Make/Model	Year	
CK1234	HONDA FL 400 R Pilot	89-90	CK1295 CT009 ▲	HONDA XR 650 R	00-07 ▲	
CK1235 CT012SP ■	HONDA VTR 250 Interceptor	88-90 ■	CK1297 CT021 ▲ CT073 ■	HONDA ST 1300/1300 A GL 1800/ABS (All models) Goldwing F6B Deluxe (GL 1800 B2) Goldwing G6B (GL 1800 B) NRX 1800 DA/DB/EA/EB	02-13 ▲	
CK1239 CT009 ▲	HONDA VT 1100 Cshadow 1100	87-96 ▲			01-13 ■	
CK1247 CKF1247 CT009 ▲ CT006 ■	HONDA CR 250 R CFR 450 R CRF 450 X CR 500 R KAWASAKI KLX 450 R A8F/A9F/AAF/ABF/ACF KX 450 F	90-07 ▲	CK1298	HONDA VT 1300 CXA Fury (ABS Model) VT 1300 CX Fury (Non ABS Model) VT 1300 CSAsabre VT 1300 CSAsabre (ABS) VT 1300 CRstateline VT 1300 CRAstateline (ABS) VT 1300 CT Interstate VT 1300 CTA Interstate (ABS) VTX 1300 C VTX 1300 R VTX 1300s/T VTX 1800 C/C1/C2/C3 VTX 1800 R VTX 1800s VTX 1800 C1/C2/C3 VTX 1800 F1/F2/F3 VTX 1800n1/N2/N3 VTX 1800 T1/T2	10-15	
		02-12 ▲			10-15	
		05-17 ▲			10-14	
		90-01 ▲			11-14	
CK1248 CT009 ▲	HONDA CB 1000 CBF 1000 F CBR 1000 F Hurricane	94-95 ▲			10-15	
		90-96 ▲			10-15	
		87-88 ▲			10-15	
CK1252 CT012SP ■	HONDA NX 125 CB 125 TT NXR 150 (KD02) CRF 230 L CRF 230 M	88-90 ■			11-14	
		90 ■			11-14	
		03-08 ■			03-10	
		08-11 ■	02-08			
		09-11 ■	02-08			
CK1253 CT013 ■ CT014 ▲	BMW G 310 GS G 310 R HONDA VFR 800 Fi	17-21 ■	CK1300 CT021 ▲	HONDA RVT 1000 (RC51)	02-06 ▲	
		17-21 ■	CK1302 CKF1302 CT009 ▲	HONDA TRX 450 R/ER TRX 700 XX	04-14 ▲	
00-01 ▲	08-11 ▲					
CK1257 CT031 ▲ CT009 ■	HONDA RVF 750 R (RC45) XL 1000 VA8 Varadero (Canada) CB 1100 (Non ABS) CB 1100 A (ABS)	94 ▲	CK1303 CT009 ▲	HONDA CB 1000 R CBF 1000 A8 (Canada) CBR 1000 RR	11-14 ▲	
		08 ■			08 ▲	
		13-14 ■			04-07 ▲	
		13-14 ■				
CK1264 CT056SP ■	HONDA ST 1100/1100 A	91-01 ■	CK1304 CT012SP ■	HONDA CRF 150 F CRF 230 F	03-05 ■ 03-16 ■	
CK1265 CT009SP ■	HONDA CB 750nighthawk	91-03 ■	CK1305 CKF1305 CT001 ▲	HONDA CRF 250 RX CRF 250 X CRF 250 R	18-21 ▲ 04-17 ▲ 08-19 ▲	
CK1284 CT068SP ▲	HONDA CBR 900 RR	96-97 ▲	CK1312 CT043SP ▲	HONDA CBR 1000 RR CBR 1000 RAA ABS Model VFR 1200 FA	08-16 ▲ 09-16 ▲ 10-14 ▲	
CK1285 CT021 ▲	HONDA GL 1500 Goldwing GL 1500 A/SE/1 Goldwing GL 1500 C/CT/CF/CD Valkyrie/Valkyrie Tourer	88-96 ▲	CK1313 CKF1313	HONDA CBR 250 R/RA	Nov-14	
		99-00 ▲				
		97-03 ▲				
CK1286 CT021 ▲	HONDA CBR 1100 XX Blackbird	97-98 ▲	CK1314 CKF1314 CT081SP ■	HONDA CRF 250 LA (ABS) CRF 250 Rally (ABS) CBF 300nA	17-21 ■ 17-21 ■ 18-21 ■	
CK1290 CT009 ▲	HONDA VTR 1000 Fsuperhawk	98-05 ▲	CK1315 CT084SP ■	HONDA MSX 125 AH Grom (ABS) Monkey 125	18-21 ■ 19-23 ■	
CK1291 CT021 ▲	HONDA RVT 1000 (RC51) CBR 1100 XX Blackbird	00-01 ▲			CK1317 CKF1317 CT092 ■	HONDA CRF 450 R (6spring type) CRF 450 RX (18" Rear wheel) CRF 450 X CRF 450 L
		99-03 ▲				
CK1293 CKF1293 CT001 ▲	GAS-GAS EC 125 (All models/2T) HONDA CR 125 R CRF 250 R CRF 250 R SX-F 250 (4T) XC-F 250 XC-F-W 250 XC-F-W 250six Days	10-11 ▲				
		00-07 ▲				
		04-07 ▲				
		10 ▲				
		05-12 ▲				
		06-12 ▲				
		06-13 ▲				
		11 ▲				

CK CLUTCH KIT BUYERS GUIDE

Part no.	Make/Model	Year	Part no.	Make/Model	Year
CK1318 CT091 ■	AJP 250 - PR5 Trail 250 - PR5supermoto 250 - PR5 Enduro 250 - PR5 EX Extreme	13-17 ■ 13-17 ■ 13-17 ■ 13-1 ■	CK2240 CT008 ▲	YAMAHA Contd. TT 350s/T YFM 350 FWBL/LC Big Bear XT 350 YFM RD 400 C/D/E RD 400 F Daytona YFM 400nM/NMC/NN/NHN/P/HP/NR YFM 400s Big Bear 2WD YFM 400 FS/FT Big Bear 4WD YFM 400 FBHW Big Bear 400 Hunter IRS YFM 400 FBEW Big Bear 400 IRS Exploring Edition YFM 400 FBW/FBX/FBY/FBA/FBB Big Bear 4WD IRS	86-87 ▲ 99 ▲ 85-00 ▲ 95-05 ▲ 76-78 ▲ 79 ▲ 00-03 ▲ 04 ▲ 04-05 ▲ 07- ▲ 07 ▲ 07-12 ▲
CK1319 CKF1319 CT009 ■	HONDA CRF 1000 LAG Africa Twin (Manual clutch/ABS)	16-21 ■	CK2242	YAMAHA XS 650sG/G/H/SH/SJ/SK	80-83
CK1323	HONDA CB 500 F (Non ABS) CB 500 FA (ABS) CB 500 X (Non ABS) CB 500 XA (ABS) CBR 500 R (Non ABS) CBR 500 RA (ABS)	13-21 13-21 13-21 13-21 13-21 13-21	CK2245 CT039 ▲	YAMAHA DT 175 G/H MX 175 G/H RT 180 A/B/D/E/G/H/J	80-81 ▲ 80-81 ▲ 90-97 ▲
CK1325	HONDA CRF 125 F/FB	14-21	CK2250 CT008 ▲	YAMAHA IT 250 F/G	80 ▲
CK1332	HONDA CB 1100 EX	16-19	CK2251	YAMAHA YT 125 J/K/L/N YT 175 J/K	82-85 82-83
CK2205 CT044 ▲	YAMAHA RX 50 MK 'Midnightspecial' RX 50 K/L 50special YSR 50 T/U/W/A/B/D	83 ▲ 83-84 ▲ 87-92 ▲	CK2252	YAMAHA YT 125 G/H	80-81
CK2206 CT044 ▲	YAMAHA YZ 50 G DT 50 U/W/A (DTL/C) DT 80 H/J/K MX 80 G/H/J	80 ▲ 88-89 ▲ 81-83 ▲ 80-82 ▲	CK2254 CKF2254 CT044 ▲	YAMAHA DT 100 G/H/J/K MX 100 G/H/J/K RT 100 A/D/E/F/G/H/J/K/L/M RX 100 (36L/36LO/5RD1/2) RX 100 (5RD3/4) RX 100 C (5RC1/2/3) RXS 115 (3HB6/7) RXS 115 (3HB8) TT-R 125 TT-R 125 YBA 125 Vision (5AP1) YBR 125 EB (5RR2/3/4/5/6/8/9) YBR 125 ED (5RR1) YBR 125 K (5TU1/2/4/6/8)	80-83 ▲ 80-83 ▲ 92-00 ▲ 01-03 ▲ 04 ▲ 04 ▲ 94-97 ▲ 99 ▲ 00-09 ▲ 00-09/11-19 ▲ 01 ▲ 02-08 ▲ 01 ▲ 02-06 ▲
CK2208	YAMAHA RXZ 100s (3HS1/2)	88-95	CK2255 CT008 ▲ CT008SP ■	YAMAHA TT 500 G/H FJ 600 L/LC/N/NC FZ 600s/SC/T/TC/UC/U XJ 600 YZF-R6 RRR/RRS/T/TC YZF R6S (SV/SW/SX/SY) FZ6 (All models) YX 600s YZR 600 R6 XJ 650 G/H/J/K 'Maxim' XJ 650 LH 'Midnight' XJ 650 LJ/LK 'Seca Turbo' XJ 650 RJ 'Seca' FZX 700s/SC/T/TC XJ 700n/NC/S/SC/XN/XNC/XS/XSC 'Maxim' FZ 750n FZ 750s/SC XJ 750 J/K/MK 'Maxim' XJ 750 RH/RJ/RKseca TDM 850 D/DC/E/EC XJ 900 RK 'Seca'	80-81 ▲ 84-85 ■ 86-88 ■ 92-98 ■ 03-05 ■ 06-09 ■ 04-09 ■ 86-90 ■ 99-02 ■ 80-83 ■ 81 ■ 82-83 ■ 82 ■ 86-87 ■ 85-86 ■ 85 ■ 86 ■ 82-83 ■ 81-83 ■ 92-93 ■ 83 ■
CK2223 CT008 ▲	YAMAHA DT 250 D/E/F	77-79s ▲	CK2256 CT039 ▲	YAMAHA XT 125 J/K/KC	82-83 ▲
CK2226 CT017 ▲ CT074 ■	YAMAHA TX 650 A/XS 650 B/C YZF 1000 R1 XS 650 D/E/F/2F	74-76 ▲ 98 ▲ 77-79 ■	CK2261 CT008 ▲	YAMAHA SRX 250 T/TC SR 250 K (3Y9) SR 250 (4GR1/2/3/4/9)	87 ▲ 93 ▲ 93-08 ▲
CK2230 CT017 ▲	YAMAHA XJ 1100 J 'Maxim' XS 1100 XS 1100 H 'Venturer' XS 1100sF/SG/SH XS 1100 LG/LH 'Midnightspecial'	82 ▲ 80 ▲ 81 ▲ 79-81 ▲ 80-81 ▲			
CK2234 CT039 ▲	YAMAHA YZ 100 G/H/J/K IT 125 G/H YZ 125 G SR 185 H/J TW 200 Trailway XT 225 D/DC/E/EC/F/FC/G/GC/H/H/C	80-83 ▲ 80-81 ▲ 80 ▲ 81/82 ▲ 87-15 ▲ 92-96 ▲			
CK2235 CT039 ▲	YAMAHA YZ 125 H IT 175 G/H/J/K IT 200 L/N/S	81 ▲ 80-83 ▲ 84-86 ▲			
CK2236 CT039 ▲	YAMAHA DT 125 G/H XT 200 J/K/KC	80-81 ▲ 82-83 ▲			
CK2238 CT044 ▲	YAMAHA YZ 80 G	80 ▲			
CK2240 CT008 ▲	YAMAHA DT 250 A/B/C BW 350 T/U R5/5A/5B - 350cc RD 350 73-75 RZ 350 L/N/NCII	74-76 ▲ 87-88 ▲ 70-72 ▲ 72-75 ▲ 84-85 ▲			

CK CLUTCH KIT BUYERS GUIDE

Part no.	Make/Model	Year	Part no.	Make/Model	Year
CK2262 CT017 ▲	YAMAHA XS 400 J/K/RJ/RK	82-83 ▲	CK2287 CT010 ▲ CT010SP ■ Contd.	YAMAHA Cont. YTM 200 K/L/N/EK/EL/ERN YTM 225 DXK/DXL/DXN YTM 225 DRN/DRS YFM 225s/T/U/W YFUJW/YFUITW Pro Hauler (230cc) YFM 250 BT/BV/BW/BX/BY	83-85 ■
CK2265 CT010 ▲	YAMAHA YZ 60 H/J/K	81-83 ▲			83-85 ■
CK2267 CT008 ▲	YAMAHA IT 250 G/H/J XT 250 G/H/J/K/KC/L/LC SR 250 G/H/TH/J	80-82 ▲ 80-84 ▲ 80-82 ▲			85-86 ■ 86-89 ■ 89 ■ 05-09 ■
CK2273 CT008SP ■	YAMAHA XS 850 G/H/LG/LH/SG/SH	80-81 ■	CK2290 CKF2290 CT090SP ▲ CT008 ■	YAMAHA YFM 350 YFM 350 Big Bear YFM 350 Warrior YFM 350 YFM 350 Raptor YFM 400 Kodiak YFM 400 FWR	87-95 ▲
CK2274 CKF2274 CT020 ▲	YAMAHA WR 250 ZF/ZG/ZH/ZJ YZ 250 (2T) YZ 450 (4T) WR 450 F YFZ 450 R YZ 450 F (4T) YFZ 450 BBW Bill Balance Edition XV 700 L/LC/N/NC 'Virago' XV 700 Virago XV 750 H/J/K/MK 'Virago' XV 750 Virago XV 750 Virago XV 920 RH/RJ XV 920 J/K/MK 'Virago' XV 1000 L/LC/N/NC 'Virago' XV 1100 Virago XVS 1100 Vstar/Vstar Custom XVS 1100 ATS V-Starsilverado XVS 1100 AS V-Star Classic XVS 1100 W-M V-Star Custom Midnight	94-97 ▲ 93-16 ▲ 14-21 ▲ 05-21 ▲ 09-13 ▲ 07-16 ▲ 07 ▲ 84-85 ▲ 86-87 ▲ 81-83 ▲ 88-90 ▲ 92-97 ▲ 81-82 ▲ 82-83 ▲ 84-85 ▲ 86-97 ▲ 99-09 ▲ 03-09 ▲ 04-09 ▲ 07-09 ▲			87-97 ▲ 87-04 ▲ 96-99 ▲ 04-13 ▲ 93-99 ▲ 03 ■
		CK2276			YAMAHA YZ 125 J
CK2278 CT054SP ▲	YAMAHA YZ 125 K/L/N/S/T	83-87 ▲	CK2295 CT060 ▲	YAMAHA TY 350n/S	85-86 ▲
CK2279 CKF2279 CT008 ▲ CT1008SP ■	YAMAHA YFP 350 U Terrapro YFZ 350 Banshee XS 400 G/SG/H/SH/SJ IT 250 H/J YZ 250 H IT 425 G IT 465 H/J YZ 465 G/H XS 750 D/2D/E/F/SE/SF	88 ▲ 87-06 ▲ 80-82 ▲ 81-82 ▲ 81 ▲ 80 ▲ 81-82 ▲ 80-81 ▲ 77-79 ■	CK2296 CT008 ▲	YAMAHA SR 500 E/F/G/H XT 500 G/H XZ 550 RJ/RK Vision	78-81 ▲ 80-81 ▲ 82-83 ▲
		CK2280 CT060 ▲			YAMAHA YZ 250 J/K/L/N/S/T IT 490 K/L YZ 490 J/K/L/N/S/T/U/W YTZ 250n/S IT 250 K WR 500 ZD/ZE
CK2283	YAMAHA YBR 125 (5PY1/2)	01	CK2298	YAMAHA XC 180 All Models	83-85
CK2285 CT017 ▲	YAMAHA FJ 1100 L/LC/N/NC FJ 1200s	84-85 ▲ 86-94 ▲	CK2299 CT020 ▲	YAMAHA XV 500 K 'Virago' XV 535 T/TC/U/A/AC/E/EC/F/FC/SF/SFC/G/GC /SG/SGC/H/HC/SH/SHC/J/JC/SJ/SJC Virago	83 ▲ 87-99 ▲
CK2287 CT010 ▲ CT010SP ■	YAMAHA YZ 80 H/J/K/L/N YFM 200n YFM 200 DXS/DXT/DXU/DXW YFB 250 YFM 250 W/A/B YFM 250 Beartracker	81-85 ▲ 85 ■ 86-89 ■ 92-00 ■ 89-91 ■ 00-04 ■	CK2300 CT050SP ▲		YAMAHA XVZ 12 'All models' V-Max VMX 12 All models XVZ 1300 Royalstar Tour Deluxe XVZ 1300 LTK Venture XVZ 1300 Venture MM Limited Edition XVZ 1300 Royalstar XVZ 1300 Royalstarstandard XVZ 1300 Royalstar Boulevard XVZ 1300 Royalstar Midnight Venture XVZ 1300 Royalstar Midnight Tour Deluxe XVZ 1300 Royalstar Tour Classic XVZ 1300 Royalstar Venture XVZ 1300 Royalstar Ventures
		CK2287 CT010 ▲ CT010SP ■	YAMAHA YZ 80 H/J/K/L/N YFM 200n YFM 200 DXS/DXT/DXU/DXW YFB 250 YFM 250 W/A/B YFM 250 Beartracker	81-85 ▲ 85 ■ 86-89 ■ 92-00 ■ 89-91 ■ 00-04 ■	
			CK2304 CT010 ▲	YAMAHA YZ 80s/T/U/W/A/B/D/E/F YZ 65 RX-Z 135 (3XL3/5PV1/5PV2) SR 150 (3UR8)	86-94 ▲ 19-21 ▲ 00-05 ▲ 95 ▲

CK CLUTCH KIT BUYERS GUIDE

Part no.	Make/Model	Year	Part no.	Make/Model	Year
CK2306 CT008SP ■	YAMAHA XJ 550 H/J/K 'Maxim' XJ 550 RH/RJ/RK 'Seca' XT 550 J FZ6R FZ 700 T/TC FZ 750 U/UC	81-83 ■	CK2332 CT054SP ▲	YAMAHA YZF 600 RG/RGC/RH/RHC YZF 600 R	95-96 ▲
		81-83 ■			97-07 ▲
CK2308 CT008 ■	YAMAHA FZR 750 RT/RU FZR 1000 T/TC/U/UC/Genesis	82	CK2335 CKF2335 CT010 ▲	YAMAHA YZ 80 G/H/J/K/L/M/N YZ 85 (2T/Small Wheel F 17"/R 14") YZ 85 (2T/Big Wheel F 19"/R 16")	95-01 ▲
		09-14 ■			02-21 ▲
CK2309 CT020 ▲	YAMAHA FZ 09 YZ 250 U/W/A/B/D YZ 250 WRW/WRA WR 250 ZB/ZD/ZE XVS 650 Vstar Custom XVS 650 A V-Star Classic XVS 650 Vstarsilverado MT-07 (689cc/2Cyl) MT-07 ABS (689cc/2Cyl)	87 ■	CK2349	YAMAHA RX-Z 135 (2UX/3UK1) RX-Z 135 (3UK3/3RSA/3RSB/3UK1)	87-89
		87-88 ■			93-97
CK2310 CT008 ▲	YAMAHA WR 400 FK/FL/FM YZ 400 FK/FL	15-16 ▲	CK2350 CT017 ▲	YAMAHA YZF R1 (1000)	99-03 ▲
		88-92 ▲			CK2351 CT050SP ▲
CK2311 CT054SP ▲	YAMAHA YZ 125 W/A	89-90 ▲	CK2352 CKF2352 CT020 ▲	YAMAHA YZ 426 FM WR 450 FS YZ 450 FR/FS/FT/FV YZF-R1 FZ-09 (847cc/3 cyl/6spring clutch) MT-09 Tracer ABS (847cc/3 Cyl Engine) MT-09A (2DR/ABS/847cc/3 Cyl Engine) MT-09Asport Tracker ABS (847cc/3 Cyl Engine) MT-09Astreet Rally ABS (847cc/3 Cyl Engine)	
		88 ▲			04 ▲
CK2312 CT054SP ▲	YAMAHA YZ 125 U	88 ▲	CK2353 CT020 ▲	YAMAHA YZF 750 R7 OW02	03-06 ▲
		88-06 ▲			09-14 ▲
CK2313 CKF2313 CT010 ▲	YAMAHA YFS 200 Blaster WR 200 D	88-06 ▲	CK2354	YAMAHA TT-R 90 M/N/P/R/ES/S/ET/EV/EW T 105 E Crypton (5AM4) T 105sE Crypton (1D81/1D82)	14-16 ▲
		92 ▲			15-21 ▲
CK2315 CT010 ▲	YAMAHA FZR 600	89-99 ▲	CK2355 CKF2355 CT005 ▲	YAMAHA WR 250 FN WR 250 FP/FR/FS/FT/FV/FW/FX/FY/FZ/FA/FB/FD WR 250 F Reverse Cylinder 4T YZ 250 FN/FP/FR/FS/FT/FV/FW (4T) YZ 250 FX/FY/FZ/FA/FB/FD (4T) YZ 250 F (4T)	14-21 ▲
		88-90/95-07 ▲			02-13
CK2316 CT008 ▲	YAMAHA XV 250 Route 66/Virago XV 250 X V-Star	08-12 ▲	CK2356 CT020 ▲	YAMAHA WR 426 FN/FP/YZ 426 FN/FP WR 450 FR YZF R1 (5VY) YZF R1 YZR R1 IE FZ1 V/W/X/Z/A/B/D/E	03-06
		88-90 ▲			07-08
CK2317 CT010 ▲	YAMAHA FZR 400 U/W/SUC/SWC/A/SAC	88-90 ▲	CK2358 CT008SP ■	YAMAHA FZS 1000n/NC/P/PC/R/RC/S/RS/T FZ1 YZF-R6	06
		89-91 ■			06-14
CK2318 CT008SP ■	YAMAHA FZR 750 OW01 YZF 750sP/RF/RFC/RG/RGC/RH/RHC YZF-R6 V/W/X/Y/Z/A/B/D/E/F/G/H/J	94-96 ■	CK2361	YAMAHA YZ 250 F 4T	01-05 ■
		06-17 ■			18-21 ■
CK2319 CT005 ▲	YAMAHA YZ 125 B/D TT-R 250 L/M/N/P/R/S/T/V WR 250 RX/RV/RZ/RA/RB/RD/RE/RF WR 250 XX/XY/XZ/ZAsupermotard	91-92 ▲	CK2362 CT017 ▲	YAMAHA XT 1200 Zsuper Tenere FJR 1300 FJR 1300 A FJR 1300 ES XVS 1300 V-Star 1300 Tourer XVS 1300 V-Star XVS 1300stryker XVS 1300 V-Star De Luxe	12-13 ▲
		99-06 ▲			03-12 ▲
CK2321 CT008SP ■	YAMAHA FZR 1000 W/WC/A/AC/B/BC/D/DC	99-05 ▲	CK2361	YAMAHA YZ 250 F 4T	06-09 ▲
		08-15 ▲			06-15 ▲
CK2324 CT039 ▲	YAMAHA XT 225 TT 225s/T TT-R 225 TT-R 230	99-05 ▲	CK2362 CT017 ▲	YAMAHA XT 1200 Zsuper Tenere FJR 1300 FJR 1300 A FJR 1300 ES XVS 1300 V-Star 1300 Tourer XVS 1300 V-Star XVS 1300stryker XVS 1300 V-Star De Luxe	07-14 ▲
		05-09/11-15 ▲			07-14 ▲
CK2325 CKF2325 CT005 ▲	YAMAHA YZ 125 (2T)	93-21 ▲	CK2361	YAMAHA YZ 250 F 4T	11-14 ▲
		93-94 ■			13-14 ▲
CK2327 CT008SP ■	YAMAHA GTS 1000 AE/AEC/AF/AFC FZR 1000 E/EC/F/FC/G/GC YZF 1000 Thunderace	93-95 ■	CK2361	YAMAHA YZ 250 F 4T	93-94 ■
		97-00 ■			93-95 ■

Part numbers, prefixes, suffixes, photos and illustrations shown in this catalog are trademarks and/or copyrights of EBC Brakes or the trademark owner A C Freeman Investments Ltd and use without express written permission of the owners is punishable by law.

CK CLUTCH KIT BUYERS GUIDE

Part no.	Make/Model	Year	Part no.	Make/Model	Year		
CK2363 CT050SP ▲	YAMAHA XV 1700 Roadstars (9spoke Cast Wheel) XV 1700 Roadstarsilverados XV 1700 Roadstarsilverado XV 1700 Roadstar XV 1700 Roadstar Midnight Warrior XV 1700 Roadstar Warrior	08-14 ▲	CK3306 CT052 ▲	SUZUKI B120 (118cc) (106mm outer dia. friction plate) TC 120 Trailcat T 125/11/Rstinger	71-77 ▲		
		11-14 ▲			68-71 ▲		
CK2364 CKF2364 CT020 ▲ CT045 ■	YAMAHA YFZ 450 LES Limited Edition YFZ 450s/T/V/W/X/Y/B/D YFZ 450 BBW Bill Balance Edition YFZ 450sETspecial Edition YFZ 450sPV/SEW/SPXspecial Edition YFZ 450sPVspecial Edition YFZ 450 BB/DB YFZ 450 R (3spring Clutch - YFZ 450 RE) YFZ 450 Rspecial Edition (3spring Clutch - YFZ 450 RSE) YAMAHA YFM 700 Raptor YFM 700 Special Edition YFM 700 Raptorspecial Edition YFM 700 Raptor YFM 700 50th Anniversary Edition - YFM 700 RSPV FZ8	04 ▲	CK3310 CT038SP ▲	SUZUKI T 20 X6 TC 250 X6scrambler	65-69 ▲		
		04-09/12-13 ▲			67-69 ▲		
		07 ▲	CK3311 CT051 ▲	SUZUKI AC 50/R AS 50sport/Colt	70-71 ▲		
		05 ■			68-69 ▲		
		06-08 ▲	CK3312 CT051 ▲	SUZUKI TC 90 R/J Blazer TS 90 R/J Honcho A 100 A/B Go-Fer	70-72 ▲		
		06 ▲			70-72 ▲		
		12-13 ▲	CK3313 CT046 ▲	SUZUKI GT 250 K/L Hustler T 250 II/R/J Hustler T 305 Raider TC 305 Laredo T 350 1/2/R/J Rebel	73-74 ▲		
		14			69-72 ▲		
		CK2364 CKF2364 CT020 ▲	YAMAHA YFM 700 Raptor YFM 700 Special Edition YFM 700 Raptorspecial Edition YFM 700 Raptor YFM 700 50th Anniversary Edition - YFM 700 RSPV FZ8	06-14 ▲	CK3314 CT046 ▲	SUZUKI T 500 1 Cobra (18 Ear Clutch Plate) T 500 2/3 Titan (18 Ear Clutch Plate)	68 ▲
				07-14 ▲			69-70 ▲
CK2367 CT017 ▲	YAMAHA XV 1900 Roadliner XV 1900 Roadliner Midnight XV 1900 Roadliners XV 1900 Raider XV 1900 Raiders XV 1900 RaidersCL XV 1900stratoliners	06-07 ▲	CK3315 CT022 ▲	SUZUKI DS 250 T GT 250 M/A/B Hustler TS 250n/T/X RM 370 A/B (2T) GT 380 J/K/L/M/A/Bsebring RM 400 C	80 ▲		
		06-09 ▲			75-77 ▲		
CK2370 CKF2370 CT005 ▲	YAMAHA XT 250 X/Y/Z/A/B/D/E/F/G/H YFM 250 RX/RV/RZ/RA/RB/RD Raptor YFM 250 RSPAspecial Edition YFM 250 RSPX/RSEYspecial Edition YFM 250 RSPXCspecial Edition Custom	08-17 ▲	CK3316 CT022 ▲	SUZUKI TM 400 R/J/K/L/M Cyclone T 500 R/J/K/L/M Titan (12 Ear Clutch Plate)	71-75 ▲		
		08-13 ▲			71-75 ▲		
CK2375	YAMAHA TTR 110 EX/EY/EA/EB/ED/EE/EF/EG	08-21	CK3318 CKF3318 CT011 ▲	KAWASAKI KLX 125 A1/A2/A3/A6F KLX 125 L (B1/B2/B3/B6F) SUZUKI RM 60n/T/X/Z/D RM 80 T/X RM 80 E/F RM 80 RM 85 (Small Wheel F 17"/R 14" Wheel) RM 85 (Big Wheel F 19"/R 16" Wheel) DR 100 D/E/F/G/H/J/K/L DR 100 C/N/T/X SP 100 D GN 125 Z/D GN 125 EM/EN/EP/ER/ES/ET/EV DR 125 Z/D/E/G/H/J DR 125sER/SES/SET DR-Z 125 DR-Z 125 DS 125n/T/X GSX-R 125 GSX-S 125 RV 125 K/L/M/A/B Tracker SP 125 Z/D SP 125 G/H/J TC 125 J/K/L/M/A/B Prospector GSX-R 150 GSX-S 150	03-06 ▲		
		08-09 ▲			03-06 ▲		
CK2378	YAMAHA XP 500 T-Max (5GJ5) XP 500 T-Max (5VUA/15B1/4B51)	1	CK3319 CKF3319 CT011 ▲	SUZUKI RM 100 A RM 100n/T/X RM 125 G/H TM 125 K/L/M Challenger	79-83 ▲		
		05-11			80-81 ▲		
CK2379 CT017 ▲	YAMAHA XVS 950 (V-Star 950) XVS 950 (V-Star 950 Tourer) XVS 950 Bolt (Standard rearshocks) XVS 950 R (Remote reservoir rearshocks)	09-14 ▲	CK3319 CKF3319 CT011 ▲	SUZUKI RM 100 A RM 100n/T/X RM 125 G/H TM 125 K/L/M Challenger	84-85 ▲		
		09-14 ▲			89-01 ▲		
CK2380 CT017 ▲	YAMAHA VMX 1700 V-Max (6 piston radial caliper)	14-16 ▲	CK3319 CKF3319 CT011 ▲	SUZUKI RM 100 A RM 100n/T/X RM 125 G/H TM 125 K/L/M Challenger	02-21 ▲		
		14-16 ▲			02-21 ▲		
CK2382	YAMAHA T Max 530 ABS T Max 530 DX ABS T Max 530sX ABS T Max 530 Black Max ABS T Max 530 Bronze Max ABS T Max 530 Iron Max ABS	12-19	CK3319 CKF3319 CT011 ▲	SUZUKI RM 100 A RM 100n/T/X RM 125 G/H TM 125 K/L/M Challenger	83-90 ▲		
		17-19			78-81 ▲		
CK2387 CKF2387	YAMAHA YZ 250 F FK	19-21	CK3319 CKF3319 CT011 ▲	SUZUKI RM 100 A RM 100n/T/X RM 125 G/H TM 125 K/L/M Challenger	83 ▲		
		17-19			83 ▲		
CK2388	YAMAHA XSR 900 ABS (MTM850)	16-21	CK3319 CKF3319 CT011 ▲	SUZUKI RM 100 A RM 100n/T/X RM 125 G/H TM 125 K/L/M Challenger	82-83 ▲		
		17-19			82-83 ▲		
CK2389	YAMAHA YFZ 450 R Quad	14-21	CK3319 CKF3319 CT011 ▲	SUZUKI RM 100 A RM 100n/T/X RM 125 G/H TM 125 K/L/M Challenger	86-88 ▲		
		14-21			86-88 ▲		

CK CLUTCH KIT BUYERS GUIDE

Part no.	Make/Model	Year	Part no.	Make/Model	Year
CK3319 CKF3319 CT011 ▲ Contd.	SUZUKI DS 185 T GT 185 K/L/M/A/B Adventurer TS 185 T/X DR 200 G/H/J DR 200s SP 200 G/H/J T 200 X5-Invader TC 200 X5stingray DR 200 G/H/J DR 200s SP 200 G/H/J LT 230sF/SG/SH/SJ (from E/No.104361) LT 250 RF/RG	80 ▲ 73-76 ▲ 80-81 ▲ 86-88 ▲ 96-19 ▲ 86-88 ▲ 67-69 ▲ 67-69 ▲ 86-88 ▲ 96-09/13/15 ▲ 86-88 ▲ 85-88 ▲ 85-86 ▲	CK3335 CT024SP ▲	SUZUKI GS 1000sZ GS 1000 GT/GX/GLT/GLX/SZ GS 1100 ET/EX/EZ GS 1100 GZ/GD/GLZ/GLD GS 1100 LT GS 1150 ES3/ESE/EF/ESF/EF2/EG/ESG VL 1500 W/X/Y/K1-K4 Intruder Legendary Classic VL 1500 Boulevard C90/C90T VL 1500 Boulevard C90/C90T	82 ▲ 80-82 ▲ 80-82 ▲ 82-83 ▲ 80 ▲ 83-86 ▲ 98-04 ▲ 05-10 ▲ 13 ▲
CK3321 CT035SP ▲	SUZUKI GT 550 J/K/L/M Indy GT 550 A/B Indy	72-75 ▲ 76-77 ▲	CK3337 CT011 ▲	SUZUKI TS 100 T/X TS 125 T/X	80-81 ▲ 80-81 ▲
CK3324 CT018SP ▲	SUZUKI GS 750 B/C/EC/N/EN/LN GT 750 J/K/L/M/A/B	77-79 ▲ 73-77 ▲	CK3340 CT011 ▲	SUZUKI DS 80 JR 80 RM 80 Z/D	80-00 ▲ 01-04 ▲ 82-83 ▲
CK3326 CT051 ▲	SUZUKI TC 100 K/L/M/A/B Blazer TS 100 K/L/M/A/B Honcho	74-77 ▲ 74-77 ▲	CK3343 CT018SP ▲	SUZUKI GS 400 XB/XC GS 400 B/C GS 425n (Spoke Wheel) GS 425 EN (Cast Wheel) GS 425 LN	77-78 ▲ 77-78 ▲ 79 ▲ 79 ▲ 79 ▲
CK3328 CT011 ▲	SUZUKI LT 125 D/E/F/G/H LT 185 E/F/G/H ALT 125 D/E/F/G ALT 185 F RM 50 C/N/T	83-87 ▲ 84-87 ▲ 83-86 ▲ 85 ▲ 78-80 ▲	CK3344 CT018SP ▲	SUZUKI GS 550 B/C/EC/N/EN/ET GS 550 MZ GS 550 LT/LX/LZ GS 550 LD/LF/LG/TX GS 550 ED/ESD/ES3/ESE/EF/ESF/ESG	77-80 ▲ 82 ▲ 80-82 ▲ 81-85 ▲ 83-85 ▲
CK3329 CT011 ▲	SUZUKI RM 100 B/C RM 125 A/B/C RM 125 X/Z/D RM 125 F PE 175 T/X/Z/D/E RS 175 T/X/Z GS 250 TT/TX LT 250sK/SL	77-78 ▲ 76-78 ▲ 81-83 ▲ 85 ▲ 80-84 ▲ 80-82 ▲ 80-81 ▲ 89-90 ▲	CK3345 CT035SP ▲	SUZUKI GS 1000 C/N/EC/EN/SN/ET/ST	78-80 ▲
CK3330 CT018SP ▲	SUZUKI GS 650 EX/EZ/GX/GZ/GD/GLX/GLZ/GLD/MD GS 700 EF/ESF GS 750 ET/EX/EZ/TZ/TD GS 750 LT/LX GS 750 ED/ESD/SD GS 850 GN/GT/GX/GZ/GD/GLT/GLX/GLZ/GLD	81-83 ▲ 85 ▲ 80-83 ▲ 80-81 ▲ 83 ▲ 79-83 ▲	CK3346 CT024SP ▲	SUZUKI GS 1100sD GS 1100 ED/ESD	83 ▲ 83 ▲
CK3331 CT022 ▲	SUZUKI PE 250 T/X RS 250 T/X RM 250 T/X/Z/D/E/F	80-81 ▲ 80-81 ▲ 80-85 ▲	CK3347 CT018SP ▲	SUZUKI XN 85 D	83 ▲
CK3332 CT022 ▲	SUZUKI GN 400 T/XT/TX/TZ DR 400 T SP 400 T PE 400 T/X RM 400nT	80-82 ▲ 80 ▲ 80 ▲ 80-81 ▲ 79-80 ▲	CK3348 CT029 ▲ CT047SP ■	SUZUKI RM 465 X/Z RM 500 D/E GSX 600 FJ/FK/FL/FM 'Katana' GSF 600sT/SV/SW Bandit GSF 600sY/SK1/SK2/SK3 GSX R 750 G/H	81-82 ■ 83-84 ■ 88-91 ▲ 96-98 ▲ 00-03 ▲ 86-87 ▲
CK3333 CT022 ▲	SUZUKI GS 450 ET/ST/EX/SX/EZ/ED GS 450 LT/LX/LZ/LD/LF/LG/LH/LJ GS 450 TX/TZ/TXZ/TXD GS 500 GS 500 F	80-83 ▲ 80-88 ▲ 81-83 ▲ 89-03 ▲ 04-09 ▲	CK3356 CT011 ▲	SUZUKI GS 300 LZ/LD/LF RM 125 E RM 125 J/K/L/M LT-F 4WD XM/N/P/R/S/T/V/W 250 (2 x 4) LT-F 300 FX/FY/FK1/FK2 "King Quad" 300 (2 x 4 / 4 x 4) 30 (4 x 4)	82-85 ▲ 84 ▲ 88-91 ▲ 91-97 ▲ 99-00 ▲ 99-02 ▲ 98-04 ▲ 05 ▲
CK3334 CT022 ▲	SUZUKI DR 370 C/N (4T)	78-79 ▲	CK3357 CT029 ■ CT047SP ▲	SUZUKI GSX 600 FW/FX/FY/FK1-FK6/FK8 Katana GR 650 D/XD GSX 750 FW/FX/FY/FK1-FK6 Katana	98-06/08 ▲ 83 ■ 98-06 ▲
			CK3358 CT029 ■	SUZUKI GN 250 Z/D/F/J DR 250 Z/D/F GW 250 L4/L5 GZ 250 X/Y/K1-K9/L0 Marauder SP 250 Z/D/F TU 250 XL1/XL2/XL3/XL4/XL5/XL6	82-88 ■ 82-85 ■ 14-15 ■ 99-10 ■ 82-85 ■ 09-16 ■

CK CLUTCH KIT BUYERS GUIDE

Part no.	Make/Model	Year	Part no.	Make/Model	Year
CK3359 CT029SP ■	SUZUKI DR 500 X/Z/D SP 500 X/Z/D SP 600 F LS 650 LS 650 K5-K9/L1/L2/L3/L4/L5 Boulevard S40 (650cc)	81-83 ■	CK3381 CT048SP ▲	SUZUKI GSX 1100 FJ/FK/FL/FM/FN/FP GSXR 1100 G/H/J	88-93 ▲
		81-83 ■			86-88 ▲
CK3364 CT011 ▲	SUZUKI LT 160 EK/EL/EM/EN LT-F 160 M/N/P/R/S/T/V/W/X/Y/K1/K3 LT 160 K3/K4 Quadrunner LT-F 230 G/H LT 230 GEF/GEG LT 230 EH/EJ/EK/EL/EM/EN/EP LT 230sF/SG/SH/SJ up to E.no 104360 LT-F 250 K2	86-88/95-04 ■	CK3382 CT029 ■	SUZUKI VS 1400 GLPH/GLFH/GLPJ/GLPL/GLPM/GLPN /GLPP/GLPR/GLPS/GLPT/GLPV/GLPW/GLPX /GLPY/GLPK1/GLPK2//GLPK3/GLPK4 VS 1400 GLPK5/K6/K7/K8/K9/L0 Boulevards83 (1400cc)	87-04 ■
		05-15 ■			05-10 ■
CK3366	KAWASAKI KDX 50 A1/A2/A3/A6F SUZUKI JR 50 C/N/T/X/Z/F/G/H/J/K/L/N/P/R/S/T/V/W /X/Y/K1/K2/K3/K4/K5/K6	03-06	CK3386 CT024 ▲	SUZUKI DR 650sET/SEV/SEW/SEX/SEY/SEK1/SEK2 /SEK3/SEK4/SEK5/SEK6/SEK7/SEK8/SEK9 /SEL1/SEL2/SEL3/SEL4/SEL5/SEL6	96-16 ▲
		78-06			92-93 ▲
CK3367	SUZUKI RM 80 G/H/J	86-88	CK3387 CT036SP ▲	SUZUKI GSXR 600 WN/WP GSX 600 FN/FP/FR/FS/FT/FV Katana GSX R 750 J/K/L/M/N GSX-R 750 WP/WR/WS	92-97 ▲
CK3372 CT022 ▲	SUZUKI LT 250 RH/RJ/RK/RL/RM/RN RM 250 G/H	87-92 86-87			88-92 ▲
CK3373 CT035SP ▲	SUZUKI RE 5 M/A (Rotary)	75-76	CK3388 CT029 ▲	SUZUKI GV 1400 GDG/GTG/GCG/GDH/GTH/GCH/GDJ	86-88
CK3374 CT022 ▲	SUZUKI RM 250 J/K/L/R/S RMX 250 K/L/M RMX 250 R/S/T/V/W/X/Y LT 500 RH/RJ/RK/RL GV 700 GLFG/GLF2	88-90/94-95 ▲ 89-91 ▲ 94-00 ▲ 87-90 ▲ 85 ▲			CK3390 CT011 ▲
CK3375	SUZUKI GV 1200 GLF/GLF2/GLG	85-86	CK3391	SUZUKI GSX 750 FK/FL/FM/FN/FP/FR/FS/FT	
CK3376 CT072SP ▲	SUZUKI GSX-R 750 RG (Dry Clutch -sintered Friction)	86 ▲	CK3392 CT055SP ▲	SUZUKI GSX R 1100 K/L/M/N GSX 1100 GM/GN/GP	89-92 ▲ 91-93 ▲
CK3377 CT022 ▲ CT029 ■	YAMAHA SV 650 X/Y/K1/SK1/K2/SK2 VS 700 GLF/GLP/GLEF/GLEP/GLEG/GLEH VS 750 GLPJ/GLPK/GLPL/GLPM VL 800 ZK3/ZK4 Volusia LTD (Seat Trimmed With Chromestuds) VL 800 (C50 Boulevard) VL 800 (C50T Boulevard Tourer) VL 800 K1/K2/K3/K4 Intruder Volusia VL 800 Boulevard C50/C50 T VL 800 ZL2 C 50 T Boulevard Classic VL 800 BTL4 (Boulevard C50 B.O.S.S. Cast Wheels) VL 800 CL3 (Boulevard C50special Edition /Cast Wheels) VX 800 L/M/N/P VS 800 Intruder GLW VZ 800 V/W/X/Y/K1-K4 Marauder VZ 800 M50 Boulevard VS 800 K5/K6/K7/K8/K9/L0s50 Boulevard	99-02 ▲ 86-87 ■ 88-91 ■	CK3397 CT011 ▲	SUZUKI GSF 400 M/N/P	91-93 ▲
		03-04 ■ 05-15 ■ 05-15 ■ 01-04 ■ 05-12 ■ 12 ■ 14 ■ 13 ■ 90-93 ■ 92-04 ■ 97-04 ■ 05-10 ■ 05-10 ■			90-93 ▲ 90-95 ▲ 90-96 ▲ 90-99 ▲
CK3380 CT051 ▲	SUZUKI RB 50 H (GSXR50)	87 ▲	CK3400 CT022 ▲	SUZUKI RM 250 M/N/P RMX 250n/P	91-93 ▲ 92-93 ▲
			CK3401 CT003 ●	SUZUKI RM 125n/P/R/S/T/V/W/X/Y/K1	92-01 ●
			CK3402 CT029SP ■	SUZUKI DR 650sL/SM/SN/SP/SER/SES	90-95 ■
			CK3408 CT036SP ▲	SUZUKI RF 600 RR/RS/RT	94-96 ▲
			CK3417 CT014 ▲ CT055SP ■	SUZUKI GSX-R 750 T/V/W/X GSXR 750 K4/K5 GSX-S 750 GSX-S 750 ABS RF 900 RS/RS2/RT/RV TL 1000sV/SW GSF 1200s	96-99 ■ 04-05 ▲ 15-16 ▲ 15-21 ▲ 95-97 ▲ 97-98 ▲ 97-05 ■
			CK3418 CT055SP ▲	SUZUKI RF 900 RR GSXR 1100 WR/WP/WS/WT/WV/WW	94 ▲ 93-98 ▲

CK CLUTCH KIT BUYERS GUIDE

Part no.	Make/Model	Year	Part no.	Make/Model	Year
CK3428 CT009 ▲	SUZUKI TL 1000 RW/RX/RV TL 1000sX/SY	98-00 ▲ 99-00 ▲	CK3456 CT015 ▲	SUZUKI GSXR 600 GSXR 600 L GSXR 750	08-21 ▲ 11-21 ▲ 06-21 ▲
CK3430 CT021 ▲	SUZUKI GSX 1300 RX Hayabusa GSX 1300 RY/RK1 Hayabusa	99 ▲ 00-01 ▲	CK3457	SUZUKI VZR 1800 BL4/BL5 (Boulevard M109R B.O.S.S.) VZR 1800 K6/K7/K8/K9/L1/L2/3/L4 (M109R Boulevard) VZR 1800nK8/NK9 M109R2 Limited VZR 1800 ZK8/ZK9/ZL1/ZL2/ZL3/ZL4 M109RZ Limited	14-15 Jun-14 08-11 08-14
CK3433 CKF3433 CT006 ▲ CT009 ■	ARCTIC CAT 400 DVX HONDA CRF 450 R (4spring type) CRF 450 R (6spring type) CRF 450 R (6spring type) KAWASAKI KLX 400 R (KLX 400 B1) KLX 400sR (KLX 400 A1) SUZUKI KSF 400 A1/A2 (KFX 400) DR-Z 400s DR-Z 400 E DR-Z 400sM LT-Z 400 K3/K4	04-06 11-12 ■ 13 ■ 14-16 ■ 03-04 ▲ 03-04 ▲ 03-04 ▲ 00-16 ▲ 00-08 ▲ 05-22 ▲ 03-04 ▲	CK3458	SUZUKI DR-Z 50 DR-Z 70	19-22 08-22
CK3435 CT009 ▲	SUZUKI TL 1000 RK1/RK2/RK3 TL 1000sK1	01-03 ▲ 01 ▲	CK3459 CT021 ▲	SUZUKI GSF 1250sKA7/SKA8/SKA9 GSF 1250sK7/SK8/SK9 Bandit GSX 1250 FAL1/FAL2 GSX 1250sAL6 Bandit V 1500 BL3/BL4/BL5 (Boulevard C90 B.O.S.S.) V 1500 BTL3/4 (Boulevard C90T B.O.S.S. with windshield) VZ 1500 L3 C90 Boulevard VZ 1500 TL3/TL4/TL5 C90T Boulevard with windshield VZ 1500 K9/L3/L4/L5 M90 Boulevard	07-10 ▲ 07-10 ▲ 11-12 ▲ 16 ▲ 13-15 ▲ 13-14 ▲ 13 ▲ 13-15 ▲ 09/13-15 ▲
CK3443 CKF3443 CT021 ▲	SUZUKI DL 1000 AL4/AL5/AL6 DL 1000 AL2/AAL4/AAL5/AAL6 V-Strom Adventure DL 1000 K2-K9/L2 V-Strom SV 1000 K3/SK3/K4/SK4/K5/SK5/SK6/SK7 GSX 1300 ral3/ral4/ral5/ral6 GSX 1300 RK2/RZK3/RK4/RZK4/RK5/RZK6/RK6 /RK7/RK8/RK9/RL1/RL2 GSX 1300 RZL4 Hayabusa 50th Anniversary Edition GSX 1300 BKA8/K9 B-King ABS GSX 1300 BKK8/K9 B-King	12/14-20 ▲ 12/14-20 ▲ 02-12 ▲ 03-07 ▲ 13-16 02-12 ▲ 14 ▲ 08-09 ▲ 08-09 ▲	CK3462 CT009 ▲	SUZUKI GSXR 1000 K9/L1/L2/L3/ZL3/L4/L5/L6	09-16 ▲
CK3447 CKF3447 CT006 ▲	ARCTIC CAT 400 DVX KAWASAKI KSF 400 A3/A6F (KFX 400) SUZUKI LT-Z 400 K5/K6/K7/K8/K9/ZK9/L2/L3/L4	07-08 ▲ 05-06 ▲ 05-14 ▲	CK3463	SUZUKI VLR 1800 TK8/TK9 C109 RT Touring VLR 1800 K8/K9 C109 R	08-10 08-10
CK3448 CT011 ▲	SUZUKI LT-Z 250 K4/K5/K6/K7/K8/K9/L0 QuadSport LT-F 250 K4 Ozark	04-10 ▲ 04 ▲	CK3465 CT014 ▲	SUZUKI GSXR 750 K1/K2/K3	01-03 ▲
CK3450 CKF3450 CT045 ▲	SUZUKI RM-Z 450 LT-R 450 K6/K7/K8/K9 LTR 450 ZK8/ZK9 Quadracer Limited	05-21 ▲ 06-11 ▲ 08-10 ▲	CK3466 CT014 ▲	SUZUKI GSXR6 600 K1/K2/K3/ZK3	01-03 ▲
CK3451 CT015 ▲	SUZUKI GSXR 1000 K5/K6/K7/K8 GSX-S 1000 L8 (Naked - non ABS) GSX-S 1000 AL8 (Naked - ABS) GSX-S 1000 F L8 (Faired -Non ABS) GSX-S 1000 F AL8 (Faired -ABS) Katana	05-08 ▲ 18-21 ▲ 18-21 ▲ 18-21 ▲ 18-21 ▲ 19-21 ▲	CK3468 CT009 ▲	SUZUKI GSX-R 1000 AL7	17 ▲
CK3452 CT006 ▲	SUZUKI LT-F 500 FK3/FK4/FK5/FK6/FK7 500 (Manual 4x4)	03-07 ▲ 03-09 ▲	CK4409 CT019 ▲	KAWASAKI Z1/A/B 900 KZ 900 A4/A5 Z 900 B1 Ltd KZ 1000 A1-A4 / KZ 1000 B1-B4 (Ltd) KZ 1000 C1/C1A/C2/C3/C4 Police KZ 1000 D1/D3 (Z1-R) KZ 1000 G1 Classic	73-75 ▲ 76-77 ▲ 76 ▲ 77-80 ▲ 78-81 ▲ 78-80 ▲ 80 ▲
CK3453 CT016 ▲	SUZUKI RM 250 K6/K7/K8	06-08 ▲	CK4411 CT058 ▲	KAWASAKI KD 125 A2/A3/A4/A5 KE 125 A7/A8/A9/A10 KE 175 D2/D3/D4/D5	75-79 ▲ 80-83 ▲ 80-83 ▲
CK3454 CT016 ▲	SUZUKI RM 250 K3/K4/K5	03-05 ▲	CK4413 CT019 ▲	KAWASAKI KZ 650 B1/B2/B2A/B3 KZ 650 C1/C2/C3 Custom KZ 650 D1/D1A/D2sR KZ 650 E1 (Ltd)/F1/H1/H2/H3 (CSR) KZ 700 A1 ZN 700 A1/A2 (Ltd) KZ 750 E1/E2/E3 KZ 750 F1 (Ltd) KZ 750 H1/H2/H3/H4 (Ltd) KZ 750 L3 KZ 750n1/N2 'Spectre' KZ 750 R1 (GPZ) ZX 750 A1/A2/A3 (GPZ)	77-79 ▲ 77-79 ▲ 78-79 ▲ 80-83 ▲ 84 ▲ 84-85 ▲ 80-82 ▲ 83 ▲ 80-83 ▲ 83 ▲ 82-83 ▲ 82 ▲ 83-85 ▲
CK3455 CT015 ▲	SUZUKI GSXR 600 K6/K7	06-07 ▲	CK4415 CT004 ▲	KAWASAKI H2/H2-A "Mach IV"	72-73 ▲

CK CLUTCH KIT BUYERS GUIDE

Part no.	Make/Model	Year	Part no.	Make/Model	Year
CK4419 CT006 ▲	ARCTIC CAT		CK4434 CT016 ▲ Contd.	KAWASAKI Contd.	
	400 (2 x 4 / 4 x 4)	00-02 ▲		KZ 1000 E1/E2 'Shaft'	79-80 ▲
	KAWASAKI			KZ 1000 K1/K2 (Ltd)	81-82 ▲
	KLF 300 A1/A2/B1-B17/C1-C17 'Bayou'	86-05 ▲		KZ 1000 M1/M2 (CSR)	81-82 ▲
	KEF 300 A1/A2/A3/A4/A5/A6 'Lakota'	95-00 ▲		KZ 1000 P1-P22/P24 Police	82-03/05 ▲
	KEF 300 B1/B2/B3 "Lakotasport"	01-03 ▲		KZ 1000 R1/R2 'Replica'	82-83 ▲
CK4421	KAWASAKI			KZ 1000 J1/J2/J3	81-83 ▲
	KZ 400s/S2/S3	75-77		ZG 1000 A6F Concours	06 ▲
	KZ 440 A1/A2/A3/A4	80-83		ZX 1000 A1/A2ninja	86-87 ▲
	KZ 440 B1/B2/D1/D2/D3/D4/D5	80-83		ZX 1000 B1/B2/B3ninja ZX10	88-90 ▲
	KZ 440 G1	82		KZ 1100 A1/A2/A3	81-83 ▲
CK4424 CKF4424 CT016 ▲	KAWASAKI			KZ 1100 B1/B2 (GPZ)	81-82 ▲
	KLR 600 (KL 600 A1/B1/B2)	84-86 ▲		KZ 1100 D1/D2 'Spectre'	82-83 ▲
	EN 450 A1-A6 (454 Ltd)	85-90 ▲		KZ 1100 L1 (Ltd)	83 ▲
	EN 500 A1-A7/C1-C10/C6F/C7F/C8F/C9F	90-09 ▲		ZN 1100 B1/B2 (Ltd)	84-85 ▲
	EX 500 A1-A7/D1-D12/D6F/D7F/D8F/D9F	87-09 ▲		ZX 1100 A1/A2ninja	86-87 ▲
	KZ 550 D1 (GPZ)	81 ▲		ZR 1100 A1/A2/A3/A4 Zephyr	92-95 ▲
	KZ 550 F1 'Spectre'	83 ▲		(ZR 1100 C3/C4) ZRX 1100	99-00 ▲
	KZ 550 F2 (Ltd)	84 ▲		ZG 1200 A1/B1-B17 Voyager X11	86-03 ▲
	KZ 550 H1/H2 (GPZ)	82-83 ▲		ZRX 1200 R (ZR 1200 A1/A2/A3/A4/A5)	01-05 ▲
	KZ 550 M1 (Ltd)	83 ▲			
	KZ 550 A1/A2/A3/A4	80-83	CK4435 CKF4435 CT016 ▲	KAWASAKI	
	KZ 550 C1/C2/C3/C4 (Ltd)	80-83		KX 250	92-07 ▲
	ZX 550 A1/A2/A3 (GPZ)	84-86 ▲		KL 650 E8F/E9F/EAF/EBF (KLR 650)	08-11 ▲
	ZR 550 B1-B4 "Zephyr"	90-93 ▲		KLR 650 (KL 650 A10-A19/A6F/A7F)	96-07 ▲
	ZL 600 A1/A2	86-87 ▲		W 650 (EJ 650 A2/A3/A4)	00-02 ▲
	ZL 600 Eliminator B2/B3	96-97 ▲		VN 700 A1 'Vulcan'	85 ▲
	ZX 600 C1-C10ninja R	88-97 ▲		VN 750 A2-A21/A6F 'Vulcan'	86-06 ▲
	ZX 600 D1-D4/E1-E13 (ZX6)	90-05 ▲		ZX 750 F1/F2/F3/F4ninja	87-90 ▲
	ZX 600 A1/A2/A3/B1 'Ninja'	85-87 ▲		ZX 750 L1/L2/L3 (ZX7)	93-95 ▲
	ER-6N (ER 650 C9F/CAF)	09-10 ▲		ZX 750 J1/J2	91-92 ▲
	EN 650 Vulcans EN650 Aff/BFF	15 ▲		ZX 750 P1-P8 (ZX7R)	96-03 ▲
	ER-6F (EX 650)	06-11 ▲		ZX 750n1/N2 (ZX7RR)	96-99 ▲
	ER-6F ABS (EX 650 ABS)	06-11 ▲		ZX 750 K1/K2	91-92 ▲
	Ninja 650 (EX 650)	12-18 ▲		ZX 750 M1/M2 (ZX7R)	93-94 ▲
	Ninja 650 ABS (EX 650 ABS)	12-18 ▲		KZ 750 G1 (Ltd)	80 ▲
	ER-6N (ER 650)	06-11 ▲		KZ 750 M1 (CSR)	82 ▲
	ER-6N ABS (ER 650 ABS)	06-11 ▲		VN 800 A1-A11/B1-B10	95-05 ▲
	Z 650 (ER 650)	12-18		VN 800 C1/C2/E1-E5/E6F Drifter	99-06 ▲
	Z 650 ABS (ER 650 ABS)	12-18		VN 900 B6F/B7F/B8F/B9F/BAF/BBF/BCF	
	KLE 650 A7F/A8F/AAF/CAF/CBF/CCF/CDF/CEF Versys	07-11 ▲		/BDFA/BEF/BEFA/BFF	06-15 ▲
	KLE 650 FFF/FFFAS/FGF/FGFAS Versys/Versys LT	15-16 ▲		VN 900 D6F/D7F/D8F/D9F/DAF/DBF/DCF/DDF	
	KLR 650 (KL 650 A1-A9)	87-95 ▲		/DEF/DFE	06-15 ▲
	KLX 650 C1/C2/C3/C4	93-96 ▲		VN 900 Custom C7F/C8F/C9F/CAF/CBF/CCF	
	KL 650 B2/B3 "Tengai"	90-91 ▲		/CDFA/CEFA/CFE	07-16 ▲
	KL 650 EBF/ECF/EDF/EEF (from KL 650 AEA 72320-)	11-15 ▲		VN 900 Vulcan Classic LT	
	KLX 650 A1/A2/A3/D1 (KLX650R)	93-96 ▲		(Spoke Wheels &screen) (D)	06-19 ▲
	ZX 750 H1/H2ninja ZX-7	89-90 ▲		VN 900 Vulcan Classic (Spoke Wheels) (B)	06-19 ▲
				VN 900 Vulcan Custom (Cast Wheels) (C)	07-19 ▲
CK4425 CT004 ▲	KAWASAKI			ZX 900 A1/A2/A3ninja	84-86 ▲
	KX 125 K1/K2/K3/K4/K5/L1-L4/M1-M3	94-05 ▲		ZX-9R B1/B2/B3/B4ninja	94-97 ▲
	KLT 200 A1/A2/A3/A4/A4A	81-83 ▲	CK4436 CT058 ▲	SUZUKI	
	KLT 200 B1/C1/C2	83-84 ▲		RM 250 T/V/W/X/Y/K1/K2	96-02 ▲
	KL 250 A1/A1A/A2/A3/A4/A5	78-82 ▲			
	KL 250 C1/C2	83-84 ▲			
	KLT 250 A1/A2/C1/C2/C3/P1	82-85 ▲			
	KZ 250 D1 (Ltd)	80 ▲			
	KZ 250 D2/L1 (CSR)	81-82 ▲			
	KZ 250 W1 (Ltd)	83 ▲			
	KLX 250 A1/A2	79-80 ▲			
	KSF 250 A1-A18 Mojave	87-04 ▲			
HI 500 Mach III	69-75 ▲				
KH 500 A8	s ▲				
CK4433 CT006 ▲	KAWASAKI				
	KXT 250 A1 'Tecate'	84 ▲			
	KZ 305 A1/A2/B1 (CSR)	81-82 ▲			
	EX 305 B1 (GPZ)	83 ▲			
	KZ 305 B2/B3 (Ltd)	87-88 ▲			
	KDX 250 B2/B3/B4	82-84 ▲			
	KX 250 B1/C1	82-83 ▲			
	KX 500 A1/A2	83-84 ▲			
CK4434 CT016 ▲	KAWASAKI				
	ZL 900 A1/A2 'Eliminator'	85-86 ▲			
	ZG 1000 A1-A20 'Concours'	86-05 ▲			
	ZL 1000 A1	87 ▲			

CK CLUTCH KIT BUYERS GUIDE

Part no.	Make/Model	Year	Part no.	Make/Model	Year																																																													
CK4439	ARCTIC CAT		CK4458	KAWASAKI																																																														
	400 (2 x 4 / 4 x 4)	98-		KZ 1300 A4		82																																																												
	400 (2 x 4)	98			CK4459	KAWASAKI																																																												
	400 (2 x 4 / 4 x 4)	03-04				KXT 250 B1/B2 'Tecate'		86-87																																																										
	400 (4 x 4 Manual)	05-08					KX 250 D1/D2		85-86																																																									
	Bearcat 454 (4 x 4)	96-98						KX 500 B1/B2		85-86																																																								
	Bearcat 454 (2 x 4)	97-98							CK4463	KAWASAKI																																																								
	500 (4 x 4)	98-02								KLT 110 A1/A2/A3		84-86																																																						
	KAWASAKI										KLF 110 A1/A2/B1/B2 'Mojave'		87-88																																																					
	KDX 250 A1/B1	80-81										CK4465	KAWASAKI																																																					
	KE 250 B1/B2/B3	77-79											CT002 ▲	KXT 250 A2 Tecate	85 ▲																																																			
	KX 250 A6/A7	80-81													KX 250 C2	84 ▲																																																		
	KDX 400 A1/A2	79-80														CK4468	KAWASAKI																																																	
	KLF 400 B1-B7 Bayou (4 x 4)	93-98															KX 80 E3/G1/G2/J2		85-87																																															
	KDX 420 B1	81																CK4469	KAWASAKI																																															
KX 420 A1/A2	80-81	CT042 ▲	KX 125 D1/E1/E2																85-87 ▲																																															
KDX 450 A1	82			KDX 200 C1/C2/C3															86-88 ▲																																															
SUZUKI					KL 250 G4/G5/G6/G7/G8 "Supersherpa"														00-04 ▲																																															
LT-F 400 K2 Eiger Manual 2WD	03					KLX 250 D2/D3/D4													93-95 ▲																																															
LT-F 400 K3/4/5/6/7	03-08						KLX 250s (KLX 250 H6F/H7F)												06-07 ▲																																															
LT-F 400 FK2/FK3/FK4/FK5/FK6/FK7 (Eiger 4WD)	02-07							KLX 250s (KLX 250 T9F/TAF/TBF/TCF/TDF/TEF)											09-14 ▲																																															
LT-F 400 FK8/FK9/FL0 King Quad 400 FS	08-10								KLX 250sF (KLX 250 W9F/TAF)supermotard										09-10 ▲																																															
LT-F 400 FCK8/FCK9 King Quad 400 FS Camo	08-09									KLX 300 R A2-A10/A6F/A7F									97-07 ▲																																															
LT-F 400 FL1-FL6 King Quad 400 FSi	11-16										KLX 300 R CLF								19-21 ▲																																															
LT-F 400 FCL1/FCL2/FCL3/FCL4/FCL5/FCL6 King Quad Camo 400 FSi	11-16											CK4473							KAWASAKI																																															
LT-F 500 FW/FX/FY/FK1-FK2	98-02												CT016 ▲	EL 250 B2/B3 Eliminator					88-89 ▲																																															
CK4440	KAWASAKI																		EL 250 E1/E2/E3/E4 (250 HS)	91-95 ▲																																														
	AR 80 A1														82	EX 250 E1/E2ninja				86-87 ▲																																														
	KD 80 M1-M8/N1/N2/N3														80-90		EX 250 F2-F19/D6F/D7Fninja			88-07 ▲																																														
	KDX 80 A1/A2														80-81			CK4475		KAWASAKI																																														
	KE 100 A5/A6/A7/A8/A9/A10	76-81	CT006 ▲												KX 250 E1/F1/G1/H1/H2					87-91 ▲																																														
KE 100 B1-B20	82-01	KX 500 C1/D1/E1-E16		87-04 ▲																																																														
KM 100 A1/A2/A3/A3A/A4/A6/A7	76-81			KXF 250 A1/A2 Tecate 4	87-88 ▲																																																													
CK4442	KAWASAKI					KDX 250 D1/D2/D3/D4														91-94 ▲																																														
	AR 50 A1				82		CK4477													KAWASAKI																																														
CK4443	KAWASAKI							KX 80 L1													88																																													
	CT019 ▲				ZX 750 E1/E2 (GPZ Turbo)				84-85 ▲											CK4478	KAWASAKI																																													
CK4446	KAWASAKI								KX 80 L2/N2/L3/N3/R1/R2/R3/R4/R5/R6/R7	KX 100 B5/B6/B7												89-97																																												
	CT004 ▲				KLR 250 (KL 250 D2-D22)						85-05 ▲											95-97																																												
CK4452	KAWASAKI										CK4482	KAWASAKI																																																						
	KZ 1300 B2 'Touring'				80							CT042 ▲	KX 125	88-89 ▲																																																				
KZ 1300 A1/A2/A3	79-81				KDX 200 E1-E6									89-94 ▲																																																				
CK4453	KAWASAKI															CK4485			KAWASAKI																																															
	CKF4453																CT042 ▲		KX 125 H1/H2/J1		90-92 ▲																																													
	CT002 ▲													KX 80 W1/W2/W3				98-00 ▲			CK4488	KAWASAKI																																												
			KX 85 (F 17"/R 14") (F 19"/R 16")											01-21 ▲	CT021 ▲			ZX 1100 C1-C4/D1-D9 (ZX11)				90-01 ▲																																												
	KX 100 C1-C3/D1-D5/D6F-D9F/DBF/DCF/DDF/FEF/FFF/FGF	98-09/11-17 ▲	ZX 1100 E1/E2/E3/F1 'GPZ 1100'											95-97 ▲																																																				
CK4455	KAWASAKI			ZX 1200 C1/C2/C3/C4 (ZZR 1200)										02-04 ▲																																																				
	CT032 ▲					CK4493								KAWASAKI																																																				
	ZN 1300 A1-A6 'Voyager'	83-88 ▲					CT019 ▲							ZR 750 C1/C2/C3/C4 Zephyr								91-93 ▲																																												
	VN 1500 A1-A13 Vulcan 88	87-99 ▲						ZR 750 F2 (ZR-7)														00 ▲																																												
	VN 1500 B1-B4/C3/C4/D1/D2/E1-E7 All Vulcan 88sE	87-04 ▲																		ZR 750 H1/H2/H3/H4/H5 (ZR-7S)		01-05 ▲																																												
	VN 1500 G1/G1A/G2A/G3nomad	99-01 ▲							CK4498	KAWASAKI																																																								
	VN 1500 Classic Fi (VN 1500n1/N2/N3)	00-02 ▲								CT042 ▲												KX 125 J2	93 ▲																																											
	VN 1500 J1/J2/R1-R5 Drifter	99-05 ▲									CK4503												KAWASAKI																																											
	VN 1500 P1/P2 'Vulcan Meanstreak'	02-03 ▲										CT004 ▲	ZX6-R (ZX 600 F1-F3/G1/G2/J1/J2/J3)										95-02 ▲																																											
	VN 1500 L2/L3/L4/L5nomad Fi	01-05 ▲			ZX6RR (ZX 600 K1)																		03 ▲																																											
	VN 1500n4/N6F/N7F/N7FA/N8F/N8FA	05-08 ▲														ZX6R (ZX 636 B1/B2)							03-04 ▲																																											
	VN 1600 A1/A2/A3/A6F/A7F/A7FA/A8F/A8FA Classic	03-08 ▲															ZZR 600 J6F/J7F/J8F		06-08 ▲																																															
	VN 1600 B1 Meanstreak	04 ▲																	Z 750s (ZR 750 K1/K6F)		05-06 ▲																																													
	VN 1600 B2/B6F/B7F/B7FA/B8F/B8FA Meanstreak	05-08 ▲													KLZ 1000 B Versys			15-19 ▲																																																
	VN 1600 D1/D6F/D7F/D7FA/D8F/D8FAnomad	05-08 ▲	CK4457															KAWASAKI																																																
SUZUKI		CT058 ▲		KDX 200 A1/A2/A3														83-85 ▲																																																
VZ 1600 K4 Marauder	04 ▲					KX 125 B2/C1												83-84 ▲																																																
VZ 1600 K5 M95 Boulevard/Marauder	05 ▲						KH 400 A3/A4/A5							76-78 ▲																																																				
CK4457	KAWASAKI													S3/S3-A (400cc)				74-75 ▲																																																
	CT058 ▲																	CK4458		KAWASAKI																																														
	KDX 200 A1/A2/A3							83-85 ▲	CK4459											KXT 250 B1/B2 'Tecate'	86-87																																													
	KX 125 B2/C1							83-84 ▲		KX 250 D1/D2										KX 500 B1/B2	85-86																																													
	KH 400 A3/A4/A5							76-78 ▲			CK4463									KAWASAKI																																														
	S3/S3-A (400cc)							74-75 ▲				KLT 110 A1/A2/A3	KLF 110 A1/A2/B1/B2 'Mojave'							84-86																																														
	BUYERS GUIDE				CLUTCHES								CK4465							KAWASAKI																																														
																CT002 ▲				KXT 250 A2 Tecate	KX 250 C2	CK4468	KAWASAKI																																											
																	CK4469						CT042 ▲	KX 125 D1/E1/E2	KDX 200 C1/C2/C3	KL 250 G4/G5/G6/G7/G8 "Supersherpa"	KLX 250 D2/D3/D4	KLX 250s (KLX 250 H6F/H7F)	KLX 250s (KLX 250 T9F/TAF/TBF/TCF/TDF/TEF)	KLX 250sF (KLX 250 W9F/TAF)supermotard	KLX 300 R A2-A10/A6F/A7F	KLX 300 R CLF																																		
																			CK4473														CT016 ▲	EL 250 B2/B3 Eliminator	EL 250 E1/E2/E3/E4 (250 HS)	EX 250 E1/E2ninja	EX 250 F2-F19/D6F/D7Fninja																													
															CK4475																							CT006 ▲	KX 250 E1/F1/G1/H1/H2	KX 500 C1/D1/E1-E16	KXF 250 A1/A2 Tecate 4	KDX 250 D1/D2/D3/D4																								
			CK4477																																								KAWASAKI	KX 80 L1																						
		CK4478		KAWASAKI																																									KX 80 L2/N2/L3/N3/R1/R2/R3/R4/R5/R6/R7	KX 100 B5/B6/B7																				
						CK4482																																									CT042 ▲	KX 125	KDX 200 E1-E6																	
							CK4485																																											CT042 ▲	KX 125 H1/H2/J1															
CK4488														CT021 ▲																																						ZX 1100 C1-C4/D1-D9 (ZX11)	ZX 1100 E1/E2/E3/F1 'GPZ 1100'	ZX 1200 C1/C2/C3/C4 (ZZR 1200)												
																		CK4493																																					CT019 ▲	ZR 750 C1/C2/C3/C4 Zephyr	ZR 750 F2 (ZR-7)	ZR 750 H1/H2/H3/H4/H5 (ZR-7S)								
									CK4498																																																		CT042 ▲	KX 125 J2						
										CK4503																																																			CT004 ▲	ZX6-R (ZX 600 F1-F3/G1/G2/J1/J2/J3)	ZX6RR (ZX 600 K1)	ZX6R (ZX 636 B1/B2)	ZZR 600 J6F/J7F/J8F	Z 750s (ZR 750 K1/K6F)

CK CLUTCH KIT BUYERS GUIDE

Part no.	Make/Model	Year	Part no.	Make/Model	Year
CK4505	KAWASAKI KDX 200 H1-H11/H6F KDX 220 R A4-A12/A6F	95-06 97-06	CK4516 CT032 ▲ Contd.	KAWASAKI Contd. VN 1700 KEF (Vaquero ABS Vulcan) VN 2000 A1/A2/A6F/A7F/G8F/G9F Vulcan VN 2000 D1/D6F/G8F Vulcan Ltd VN 2000 E6F/E7F/H8F/H9F Vulcan Classic VN 2000 F6F/F7F/J8F/J9F/JAF Vulcan Classic LT	14-21 ▲ 04-09 ▲ 05-06 ▲ 06-09 ▲ 06-10 ▲
CK4510 CKF4510 CT004 ▲ CT079SP ●	KAWASAKI Z 900 (ZR 900 A) Z 900 ABS (ZR 900 B) Z 900 RS (ZR 900 C)/RS Café (ZR 900 E) ZX9R (ZX 900 C1/C2/E1/E2/F1/F2) Z 1000 (ZR 1000 A1/A2/A3) Z 1000 ABS (ZR 1000 A6F/C7F) Z 1000 (ZR 1000 DAF/DBF/DCF/DDF) ZR 1000 B7F/B8F (Z1000) Z 1000 Performance Z 1000sX Tourer ZX 10C1/C2/D6F/D7F/E8F/E9F/FAF/JBF/KBF/ JCF/KCF/JDF/JEF/JFF (ZX10R) ZX 1000ninja GBF/GCF/GDF 1000ninja ABS (ZX1000 HCF/HDF) 1000ninja ABS (ZX1000 MEF/MFF) ZX-10R (ZX 1000 KBF/KCF/KDF/KEF/KFF) ZX10 R (ZX 1000 C1/C2) ZX10 R (ZX 1000 D6F/D7F/E8F/E9F/FAF) ZX10 R (ZX 1000 JBF/JCF/JDF/JEF /JJFnon ABS) ZX10 R (ZX 1000 FFFA 30th Anniversary Edition - ABS) ZX10 R (ZX 1000sGF) KRT Replica (ZX1000SGFA) ZX10 RR ZX10 RR Performance SUZUKI GSXR 1000 K1/K2/K3/K4/ZK4 GSX-S 1000 (Naked)/ABS (Naked) GSX-S 1000 F (Faired)/F ABS (Faired) YAMAHA FZ-10 YZF-R1/R1M YZF-R1S	17-21 ▲ 17-21 ▲ 18-21 ▲ 18-21 ▲ 98-03 ▲ 03-05 ▲ 06-07 ▲ 10-13 ▲ 07-08 ▲ 16-19 ▲ 16-19 ▲ 11-13 ▲ 12-13 ▲ 14-15 ▲ 11-15 ▲ 04-05 ▲ 06-10 ▲ 11-15 ▲ 15 ▲ 16 ▲ 16-19 ▲ 17-21 ▲ 17-21 ▲ 01-04 ▲ 16-17 ▲ 16-17 ▲ 17 15-21 ● 16 ●	CK4518 CT021 ▲	KAWASAKI ZX 14 R (ZX 1400 A6F/A7F) ZX 14 R ABS (ZX 1400 B6F/B7F) ZX 14 R ABS ZX 14 R ABS Performance ZX 14 R ABS Performancesport (ZX 1400 JGF)	06-07 ▲ 06-07 ▲ 08-16 ▲ 12-21 ▲ 14-21 ▲
			CK4519 CT006 ▲	KAWASAKI KFX 450 R (KSF 450 B8F/B9F/BAF/BBF/BCS)	08-12 ▲
			CK4520 CT021 ▲	KAWASAKI Concours 14 (ZG 1400 B8F/B9F/DAF) Concours 14 ABS (ZG 1400 A8F/A9F/CAF/CBF /CCF/CDF/CEF)	08-10 ▲ 08-14 ▲
			CK4521 CT009 ▲	KAWASAKI EX 250 J8F/J9F/JAF/JBF/JCFninja 250 R	08-12 ▲
			CK4522	KAWASAKI KLX 140 (F 17"/R 14") KLX 140 L (F 19"/R 16") KLX 140 G (F 21"/R 18") KLX 150s	08-21 08-21 17-21 09
			CK4523 CT004 ▲	KAWASAKI H2-B Mach IV (2T) H2-C Mach IV (2T)	74 ▲ 75 ▲
			CK4524 CT009 ▲	KAWASAKI EX 300 ADF/ADFA/AEF/AEFA/AES/AESAninja EX 300 BDFA/BDF/BEF/BEFAninja Versys-X 300 ABS	13-19 ▲ 13-19 ▲ 17-21 ▲
CK4511	KAWASAKI BN 125 A4-A8/A6F/A7F/A9F	01-09	CK4528	KAWASAKI Ninja H2	15-21
CK4513 CT009 ▲	KAWASAKI ZX12R (ZX 1200 A1)	00 ▲	CK4529	KAWASAKI Ninja H2R	15-21
CK4514 CKF4514 CT003 ● CT004 ▲	KAWASAKI KLX 230 KX 250 F ZX6RR (ZX 600 M1/N1/N6F) ZX6R (ZX 600 P7F/P8F/R9F/RAF/RBF/RCF) ZX 636 C1/C6F ZX6R (ZX 636 EDF/EEF/EFF/EGF/EHF) 636cc/Non ABS ZX6R (ZX 636 EFFA) 636cc/ 30th Anniversary Editionnon ABS ZX6R (ZX 636 EGFA/EHFA) 636cc/Non ABS/KRT Edition ZX6R (ZX 636 FDF/FDF/FFF/FGF/FHF) 636cc/ABS ZX6R (ZX 636 FFFA) 636cc/ 30th Anniversary Edition ABS ZX6R (ZX 636 FGFA/FHFA) 636cc/ABS/KRT Edition SUZUKI RM 125 K2/K3/K4/K5/K6/K7/K8 RM-Z 250	20 ▲ 04-21 ▲ 04-06 ▲ 07-12 ▲ 05-06 ▲ 13-19 ▲ 15 ▲ 16-19 ▲ 13-19 ▲ 15 ▲ 16-19 ▲ 02-08 ● 04-21s ▲	CK4530	KAWASAKI Ninja 400 Z 400	17-21 17-21
			CK4531	KAWASAKI KX-F 450	19-21
			CK5544	HONDA ATC 185/185s Centrifugal (one way) clutch ATC 200 Centrifugal (one way) clutch ATC 200 E Big Red Centrifugal (one way) clutch ATC 200 ES Big Red Centrifugal (one way) clutch ATC 200 M Centrifugal (one way) clutch ATC 200s Centrifugal (one way) clutch TRX 200 Fourtrax Centrifugal (one way) clutch	80-83 81-83 82-83 84 84-85 84-86 84
CK4515 CT009 ▲	KAWASAKI ZX12R (ZX 1200 A2/B1/B2/B3/B4)	01-05 ▲	CK5588 CKF5588 CT021 ▲	TRIUMPH Adventurer Daytona 750 (3cyl) Daytona 1000 (4cyl) Daytona 900 (3cyl) Daytonasuper III (3cyl) Daytona 1200 (4cyl) Legend TT Speed Triple (carb model) Sprint (All carb models) Thunderbird Thunderbirdsport Tiger 900cc Trident 900 Trophy 900 (3cyl) Trophy 1200 (4cyl)	96-01 ▲ 92 ▲ 92 ▲ 93-96 ▲ 94-97 ▲ 93-98 ▲ 98-01 ▲ 94-97 ▲ 93-98 ▲ 95-03 ▲ 98-04 ▲ 93-96 ▲ 92-98 ▲ 92-01 ▲ 92-01 ▲
CK4516 CT032 ▲	KAWASAKI VN 1700 G9F/GAF Vulcan 1700 Classic LT VN 1700 A9FA/AAF/ABF/ACF/ADF Vulcan 1700 Voyager VN 1700 B9FA/BAF/BBF/BCF/BDF/BEF Vulcan 1700 Voyager ABS VN 1700 C9F/CAF/CBF/CCF/CFD Vulcan 1700nomad VN 1700 C9FA Vulcan 1700nomad 2T VN 1700 E9F/EAF/EBF/ECF Vulcan 1700 Classic VN 1700 JBF/JBFA/JCF Vaquero VN 1700 DEF/DEFA (Vulcannomad ABS)	09-10 ▲ 09-13 ▲ 09-14 ▲ 09-13 ▲ 09 09-12 ▲ 11-13 ▲ 14-21 ▲			

CK CLUTCH KIT BUYERS GUIDE

Part no.	Make/Model	Year	Part no.	Make/Model	Year
CK5589 CKF5589 CT009 ▲	TRIUMPH T595 Daytona Daytona 955i Speed Triple (EFI) Sprint RS SprintsT Tiger 900cc Tiger 955cc	97-98 ▲ 98-00 ▲ 97-01 ▲ 99-01 ▲ 99-01 ▲ 97-98 ▲ 99-06 ▲	CK5608	TRIUMPH America (865cc) Bonneville (865cc) (Cast wheel) BonnevilleE (865cc) (Cast wheel) Bonneville America Speedmaster 800 Scrambler (865cc) ThruxtonsE (865cc) Thruxton 900 Bonneville T100 Bonneville T100 (865cc)steve McQueen	08-12 09-12 09-12 02-08 03-09 06-09 12 04-09 05-09 12
CK5594 CKF5594 CT027 ▲ CT057SP ■	KTM SX 60 SX 65 SX 65 XC 65 XC 65	98-00 ▲ 98-08 ▲ 09-18 ■ 08 ▲ 09-13 ■	CK5610 CT027 ▲ CT028 ■	KTM 85sX (17/14" & 19/16" Wheel Models) SX 85 (17"/14") SX 85 (19"/16") 85 XC 105sX XC 105	03-17 ▲ 03-17 ■ 03-17 ■ 08-09 ▲ 04-11 ▲ 08 ▲
CK5595 CKF5595 CT007 ▲ CT049 ■	KTM 250 EGS 250 EXC SX 250 (2T) 250 MXC 250sXS XC 250 (2T) XC-W 250 (2T) 300 E-GS 300 EXC 300 MXC SX 300 300six Days XC 300 XC-W 300 360 EXC 360 EGS 360 MXC 360sX 360six Days SX 380 380 MXC 380 EXC RXC-E 400 RXC-E 620 Reklus Aftermarket Clutch forsX/XC (2T Models/24 toothsteel plate)	94-99 ▲ 94-05 ▲ 94-12 ▲ 98-99 ▲ 01-03 ▲ 06-12 ▲ 06-12 ▲ 94-99 ▲ 94-05 ▲ 94-05 ▲ 94 96 06-12 ▲ 06-11 ▲ 96-97 ▲ 96-97 ▲ 96-97 ▲ 96 98-02 ▲ 98-01 ▲ 98-02 ▲ 95 ▲ 95 ▲ 03-11 ■	CK5611 CKF5611 CT001 ▲	HUSQVARNA TC 125 KTM SX 125 125 EXC 125 EXE 125 EGS 125supermoto 125sXS SX 150 XC 150 SX 200 200 EGS 200 EXC 200 MXC XC-W 200 XC 200	14-18 ▲ 98-18 ▲ 98-05 ▲ 00-01 ▲ 98-99 ▲ 00-01 ▲ 01-02 ▲ 08-18 ▲ 10-15 ▲ 03 98-99 ▲ 97-05 ▲ 98-03 ▲ 07-15 ▲ 06-09 ▲
CK5597 CT009SP ■	TRIUMPH Bonneville 800 Bonneville T-100	01-06 ■ 02-04 ■	CK5612 CT023 ▲	KTM 250 EXC Racing 250 EXC-G Racing 400sX Racing 400 EXC 400 EXC Racing 400 EXC-G Racing 400 MXC 450 EXC-G Racing 450 EXC Racing 450 EXC 450 LXC-G Racing 450 MXC-G Racing 450sX Racing MXC 450 SMR 450 450sMS SX 450 XC 450 (Quad) 520sX Racing 525 EXC 525 EXC Racing EXC 525 Racing (4T) 525 EXC G Racing 525 MXC Desert Racing MXC 525 SX 525 525sX Racing 525sMR XC 525 (Quad) 540sXS Racing SMR 560	02-03/05 ▲ 03 ▲ 02 ▲ 07 ▲ 02/05 ▲ 02/05-06 ▲ 02 ▲ 03 ▲ 03/05 ▲ 04-07 ▲ 05 ▲ 03/05 ▲ 03/05 ▲ 06 ▲ 04-06 ▲ 04 ▲ 06 ▲ 08-12 ▲ 02 ▲ 03 ▲ 05 ▲ 07 ▲ 03/05 ▲ 03/05 ▲ 06 ▲ 06 ▲ 03 ▲ 04-05 ▲ 08-12 ▲ 02 ▲ 06 ▲
CK5599 CKF5599 CT009 ▲	TRIUMPH Daytona 955i Speedtriple 955cc Sprint RS SprintsT Speedtriple (1050cc) Tiger (1050cc)	01-06 ▲ 02-04 ▲ 02-04 ▲ 02-09 ▲ 05-09 ▲ 07-09 ▲	CK5619	KTM 660sM Factory Replica 660sMC 660sMS	02-03 03-04 04
CK5602	KTM 250 EXC-G Racing 250 EXC Racing 400 EXC 400 MXC SX 400 450 EXC-G Racing 450 EXC racing 450 MXC-G Racing 450sX Racing 520 EXC SX 520 525 EXC Racing 525 EXC-G Racing 525 MXC-G Racing 525 MXC Desert Racing 525sX Racing	04 04 00-01 01 00-01 04 04 04 04 04 00-01 00-01 04 04 04 04 04 04 04 04 04 04 04 04 04 04-08	CK5624 CT021 ▲	TRIUMPH Rocket III (All models)	04-12 ▲
CK5605	BMW F 650 (E169/0161) F 650 (E169/0162) F 650sT (E169/163/168)strada	09/93-96 97-00 97-00			

BUYERS GUIDE
CLUTCHES

CK CLUTCH KIT BUYERS GUIDE

Part no.	Make/Model	Year	Part no.	Make/Model	Year		
CK5631 CT031 ▲	KTM		CK5639 CT031 ▲	KTM			
	350 EXC	94 ▲		540sXC	98-99		
	350super Comp	94-95 ▲		620 LC4 Competition/Supermoto	99 ▲		
	380 EGS	98-99 ▲		620super Comp	96-99 ▲		
	400 Duke	94-95 ▲		SX 620	97-99 ▲		
	400 EGS	94/96-97 ▲		620sC	00-01 ▲		
	400 EGS-E	97 ▲		620supermoto/TXC	98 ▲		
	400 EXC	94/96 ▲		625sMC	04/06 ▲		
	400super Comp	95 ▲		625sC	02 ▲		
	400super Comp/EXC	96-99 ▲		625sXC	03-04 ▲		
	400 LSE	97 ▲		640 Adventure-R	98-02 ▲		
	400 LC-4	98 ▲		640 Duke-E	98 ▲		
	400 LS-E	04 ▲		640 Duke II	99-04 ▲		
	400 RXC-E	96-97 ▲		640 LC4	99-00 ▲		
	400sX-C	98 ▲		640 LC4-E	00-02 ▲		
	400sX	99 ▲		640 LC4 Adventure	05-06 ▲		
	SXC 400	97 ▲		640 LC4supermoto	03-04 ▲		
	400sXC	00 ▲		640 LC4six Days	99 ▲		
	400 LC4-E	00-01 ▲		660 LC4 Rallye	99-00 ▲		
	LC4 R 400	99 ▲		660sMC	03-04 ▲		
	400 TXC	98 ▲		660sMS	04 ▲		
	620 Duke	94/97 ▲		660sM Factory Replica	02-03 ▲		
	620super Comp	94-95 ▲					
	620 EXC	94-95 ▲		CK5641 CT031 ▲	KTM		
	620 EGS	94-95 ▲		690 Rally Factory Rep	07-08 ▲		
	620 EGS/Adventure	96-97 ▲					
	620 EGS-E	97 ▲		CK5642	HUSQVARNA		
	620 LSE	97 ▲		701 Enduro R	16-21		
	620 Enduro Ltd	97 ▲		701supermoto	16-18		
	620 LC-4	98 ▲		Svartpilen 401	18-21		
	620 RXC-E	96-97 ▲		Svartpilen 701	18-21		
	SXC 620	97 ▲		Vitpilen 401	18-21		
	620six Days	96 ▲		Vitpilen 701	18-21		
	640 LC Rallye Dakar	97 ▲		KTM			
	660 LC4	97 ▲		690 Duke	08-11		
				690 Enduro	08		
				690 Enduro R	10-15		
				690supermoto	07-08		
				690sMR	07-09		
				690sMC	08-11		
				990superduke	05-11		
	CK5632 CT075 ▲	KTM			CK5644 CT021 ▲	KTM	
	400 RXC-E	95 ▲		1190 RC8-R (6spring type clutch)	09-12 ▲		
	EXC 400 (LC4 Engine)	93-95 ▲		1190 RC8 (6spring type clutch)	08-12 ▲		
	SC 400	95 ▲					
	620 RXC-E	95 ▲		CK5648 CT041 ▲	KTM		
				XC-W 400	10-11 ▲		
		XC-R-W 450	08 ▲				
		XC-W 450 Champions Edition	10 ▲				
		EXC-R 450	08 ▲				
		EXC 450	10-11 ▲				
		XC-W 450six Days	10-11 ▲				
		XC-R-W 530	08 ▲				
		EXC 530	10-11 ▲				
		EXC 530 Champion Edition	10 ▲				
		EXC-R 530	08 ▲				
		XC-W 530six Days	10-11 ▲				
CK5633 CT031 ▲	KTM		CK5651 CKF5651 CT023 ▲	HUSQVARNA			
660 Rallye	01-03 ▲	FC 250	14-17 ▲				
660 Rallye Factory	04 ▲	TC 250	14-21 ▲				
		TE 250	14-21 ▲				
		TE 300	14-21 ▲				
		TX 300i	18-21 ▲				
		FC 350	14-17 ▲				
		FE 350	14-17 ▲				
		FX 350	17-18 ▲				
		FC 450	14-17 ▲				
		FE 450	14-18 ▲				
		FR 450 Rally	17-21 ▲				
		FS 450	15-21 ▲				
		FX 450	17-18 ▲				
		FE 501	14-21 ▲				
		FE 501S	16 ▲				
		KTM					
		SX-F 250 (4T)	13-18 ▲				
		SX 250 (2T)	13-21 ▲				
		XC 250 (2T)	13-15 ▲				
CK5634 CT015 ▲	KTM						
950 Adventure	03-04/06 ▲						
950 Rsuperenduro	07-08 ▲						
950supermoto	13-14 ▲						
990superduke	06-09 ▲						
990 Adventure	07-11 ▲						
990 Adventures	07-09 ▲						
990 Adventure Baja Edition	13-14 ▲						
990superduke R	07-11 ▲						
990sM-R/SM-T	09-11 ▲						
CK5635 CT083 ▲	BMW						
F 650 GS Dakar (R13/0176/0186)	04-07						
F 650 CScarver (K14/0177/0187)	04-07						
G 650 GS (R13)	08-16 ▲						
G 650 GSsertao (R13)	10-14 ▲						
G 650 X Country (K15)	08-10 ▲						
CK5636	BMW						
F 650 GS Dakar (R13/0173/0183)	99-03						
F 650 CScarver (K14/0174/0184)	00-03						
CK5638 CT009 ▲	KTM						
XC-W 450	08-09 ▲						
SX-F 450	07-11 ▲						
SX 450 (Quad)	09-12 ▲						
XC-F 450	08-09 ▲						
SX-F 505	07-08 ▲						
SX 505 (Quad)	09-12 ▲						
XC-F 505	08-09 ▲						

CK CLUTCH KIT BUYERS GUIDE

Part no.	Make/Model	Year	Part no.	Make/Model	Year	
CK5651 CT023 ▲	KTM Contd.		CK5669 CT086SP ▲	TRIUMPH		
	XC-W 250 (2T) (Diaphragmspring)	13-15 ▲		Bonneville T100 (900cc/Liquid Cooled)	16-21 ▲	
	XC-F 250	13-15 ▲		Bonneville T100 Black (900cc/Liquid Cooled)	16-21 ▲	
	XC-W 300 (Diaphragmspring)	13-21 ▲		Bonneville T120 (1200cc Liquid Cooled)	16-21 ▲	
	XC 300 (Diaphragmspring)	13-21 ▲		Bonneville T120 Black (1200cc Liquid Cooled)	16-21 ▲	
	XC 300	13 ▲		Bonneville Bobber (1200cc Liquid Cooled)	17-21 ▲	
	EXC-F 350	12-15 ▲		Bonneville Bobber Black (1200cc Liquid Cooled)	18-21 ▲	
	SX-F 350	11-18 ▲		Street Cup (900cc Liquid Cooled)	16-21 ▲	
	XC-F 350	11-15 ▲		Streetscrambler (900cc Liquid Cooled)	16-21 ▲	
	XCF-W 350	12-21 ▲		Street Twin (900cc Liquid Cooled)	16-21 ▲	
	SX-F 450	12-15 ▲		Thrupton 1200 (Liquid Cooled)	16-21 ▲	
	SX-F 450 Diaphragmspring	13-21 ▲		Thrupton R 1200 (Liquid Cooled)	16-21 ▲	
	XC-F 450 Diaphragmspring	13-15 ▲				
	XC-W 450	12 ▲		CK5670	DUCATI	
	XC-W 450 Diaphragmspring	12-15 ▲		959 Panigale	17-20	
	EXC 500	12 ▲				
	EXC 500 Diaphragmspring	13-15 ▲		CK5672	BETA	
XC-W 500	12 ▲	Enduro RR 250 2T	18-20			
XC-W 500 Diaphragmspring	13-15 ▲	Enduro RR 300 2T	18-20			
		Enduro RR 350 4T	18-20			
		Enduro RR 390 4T	18-20			
		Enduro RR 430 4T	18-20			
		Enduro RR 480 4T	18-20			
CK5656	HUSQVARNA		CK5673	KTM		
	TC 450	02-06	TBC			
	TE 450	02-06				
	SMR 570	03-04	CK5674	HUSQVARNA		
	TC 570	03-04	TC 50	17-19		
TE 570	03-04	KTM				
TE 610	05-12	SX 50	13-19			
CK5657	HUSQVARNA		CK5675	DUCATI		
	TC 250	03-08	Monster 620 ie	01-06		
	TE 250 2T	03-09				
TE 310	08-10					
CK5660 CT085 ▲	BMW		CK5676	BMW		
	F650 GS (Late type plates 2 x 13mm 7 x 14mm ears)	07-19 ▲	R 1200 GS	13-18		
	F700 GS (Late type plates 2 x 13mm 7 x 14mm ears)	11-19 ▲	R 1200 GS Adventure	13-18		
	F800 GS (Late type plates 2 x 13mm 7 x 14mm ears)	12-19 ▲	R 1200 R	13-18		
	F800 GS Adventure (Late type plates 2 x 13mm 7 x 14mm ears)	12-19 ▲	R 1200 RS	14-18		
	F800 GS Adventure (Late type plates 2 x 13mm 7 x 14mm ears)	12-19 ▲	R 1250 GS/GS TE	19-21		
	F800 GT (Late type plates 2 x 13mm 7 x 14mm ears)	07-19 ▲	R 1250 GS Rallye/GS Rallye TE	19-21		
	F800s (Late type plates 2 x 13mm 7 x 14mm ears)	07-19 ▲	R 1250 GS Adventure	19-21		
	F800sT (Late type plates 2 x 13mm 7 x 14mm ears)	07-19 ▲	R 1250 GS Adventure TE	19-21		
	F800 R (Late type plates 2 x 13mm 7 x 14mm ears)	05-19 ▲	R 1250 GS Adventure Rallye	19-21		
		R 1250 GS Adventure Rallye TE	19-21			
CK5661	DUCATI		CK5681	TRIUMPH		
	899 Panigale	13-15	Tiger 800 XR (from VIN 674842)	>2018		
CK5664	DUCATI		CK5682	BMW		
	Daytona 675	13-	K 1300 GT	08-11		
Daytona 675 R	13-	K 1300 R	08-12			
CK5665	KTM		K 1300s	08-16		
	390 Duke	13-14				
RC 390	14-15	CK5683	KTM			
CK5666	KTM		1050 Adventure	15-16		
	390 Duke	15-17	1090 Adventure Inc R model	17-19		
RC 390	16-17	1090 Adventure L ands models	2019			
CK5667 CT085 ▲	BMW		1190 Adventure	13-16		
	F800 GS (Early type plates 14mm ears)	08-11 ▲	1190 Adventure R	13-16		
	F800 GT (Early type plates 14mm ears)	04-06 ▲	1190 RC8 R (3spring Type Clutch)	13-15		
	F800s (Early type plates 14mm ears)	04-06 ▲	1290super Adventure	15-16		
	F800sT (Early type plates 14mm ears)	04-06 ▲	1290super Adventure R&S models	17-21		
			1290super Adventure T	17		
CK5668 CKF5668 CT087SP ▲	HUSQVARNA		1290superduke GT	17-19		
	TC 85 (F 17"/R 14")	18-21 ▲	1290superduke R	16-19		
	TC 85 (F 19"/R 16")	18-21 ▲				
KTM		CK6680	APRILIA			
SX 85 (F 17"/R 14")	18-21 ▲	RSV 1000 R Factory/R	04-08			
SX 85 (F 17"/R 14")	18-21 ▲					
		CK6681 CT014 ▲	APRILIA			
		RSV4R	10-12 ▲			
		RSV4 Factory	09-12 ▲			
		RSV4 Factory APRC	11-12 ▲			

CK CLUTCH KIT BUYERS GUIDE

Part no.	Make/Model	Year	Part no.	Make/Model	Year
CK7001	INDIAN		CK7007 CT708SP ▲	HARLEY DAVIDSON®	
	Octane	17		FXFBS Fat Bob 114	18-21 ▲
	Scout	15-16		FLFBS Fat Boy 114	18 ▲
	Scout/Scout 1200	17-21		FXBRS Breakout 114	18-21 ▲
	Scout Bobber	18		FXBRS Breakout 114 Anniversary	18 ▲
Scoutsixty	16-21				
CK7002 CT702SP ▲	HARLEY DAVIDSON®		CK7008 CT703SP ▲	HARLEY DAVIDSON®	
	FLHTCUTG 1MAL Tri Glide Ultra Classic	14-16 ▲		FLHTCUTG 1MAM Tri Glide Ultra Classic	09-13 ▲
	FLRT 1MCM Freewheeler	15-16 ▲		FLHXXX 1MBMstreet Glide Trike	10-11 ▲
	FLHTK 103 1TEL CVO Limited	14 ▲		FLHTCUTG ANV 1MAM_ANV Tri Glide Ultra Classic Anv	13 ▲
	FLHTCUL 1KDM Ultra Classic Low	15-21 ▲		FLHRCI 1FRR Road King Classic	98 ▲
	FLHTCUL TC 1KFL Ultra Classic Low Twin-Cooled	15-21 ▲		FLHTC 1DJL Electra Glide Classic	98 ▲
	FLHTKL 1KKL Ultra Limited Low	15-16 ▲		FLTR 1FPL Road Glide	98 ▲
	FLHR 1FBC Road King	17 ▲		FLTRI 1FSR Road Glide	98 ▲
	FLHRC 1FRC Road King Classic	17 ▲		FLHT 1DDL Electra Glidestandard	98-02 ▲
	FLHTCU 1FCC Electra Glide Ultra Classic	17-21 ▲		FLHR 1FDL Road King	98-03 ▲
	FLHTK 1KED Ultra Limited	17-21 ▲		FLHTCI 1FFR Electra Glide Classic	98-03 ▲
	FLHTKL 1KKD Ultra Limited Low	17-21 ▲		FLHTCU 1FCR Ultra Classic	98-03 ▲
	FLHX 1KBCstreet Glide	17-18 ▲		FLHRCI 1FRW Road King Classic	99-03 ▲
	FLHXS 1KRCstreet Glidespecial	17-21 ▲		FLHTC 1DJV Electra Glide Classic	99-03 ▲
	FLTRU 1KGD Road Glide Ultra	17-21 ▲		FLTR 1FPV Road Glide	99-03 ▲
	FLTRX 1KHC Road Glide	17-21 ▲		FLTRI 1FSW Road Glide	99-03 ▲
	FLTRXS 1KTC Road Glidespecial	17-21 ▲		FLHRI 1FBW Road King	00-03 ▲
	FLHRXS 1KVC Road Kingspecial	18 ▲		FLHTCI 1FFW Electra Glide Classic	01 ▲
	FLHTK 1KND Ultra Limitedshrine Edition	18 ▲		FLHT 1DDV Electra Glidestandard	03 ▲
	FLHTK 1KWD Ultra Limited Anniversary	18 ▲		FLHTI 1FVW Electra Glidestandard	03 ▲
	FLHX 1KXCstreet Glide Anniversary	18 ▲		FLHRCI 1FRW Road King Classic	04 ▲
	FLHXS 1KYCstreet Glidespecial Anniversary	18 ▲		FLHRSI 1FYW Road King Custom	04 ▲
	FLSS 1JS9softtailslims	16 ▲		FLHTCU 1FCW Ultra Classic	04 ▲
	FLSTFBS 1JT9 Fat Boys	16-17 ▲		FLHR 1FDV Road King	04-05 ▲
	FLSS 1JS9slims	17-21 ▲		FLHRI 1FBW Road King	04-05 ▲
FLSTFBS 1JT9 Fat Boys	17 ▲	FLHRS 1FXV Road King Custom	04-05 ▲		
		FLHT 1DDV Electra Glidestandard	04-05 ▲		
		FLHTC 1DJV Electra Glide Classic	04-05 ▲		
		FLHTCI 1FFW Electra Glide Classic	04-05 ▲		
		FLHTI 1FVW Electra Glidestandard	04-05 ▲		
		FLTRI 1FSW Road Glide	04-05 ▲		
		FLHRCI 1FRW Road King Classic	05 ▲		
		FLHRSI 1FYW Road King Custom	05 ▲		
		FLHTCI 1FCW Ultra Classic	05 ▲		
		FLHR 1FDV Road King	06 ▲		
		FLHRCI 1FRW Road King Classic	06 ▲		
		FLHRI 1FBW Road King	06 ▲		
		FLHRS 1FXV Road King Custom	06 ▲		
		FLHRSI 1FYW Road King Custom	06 ▲		
		FLHTCI 1FFW Electra Glide Classic	06 ▲		
		FLHTCU 1FCW Ultra Classic	06 ▲		
		FLHTI 1FVW Electra Glidestandard	06 ▲		
		FLHX 1KAVstreet Glide	06 ▲		
		FLHXI 1KBWstreet Glide	06 ▲		
		FLTRI 1FSW Road Glide	06 ▲		
		FLHT 1DDV Electra Glidestandard	06-10 ▲		
		FLHRS 1FY4 Road King Custom	07 ▲		
		FLTR 1FS4 Road Glide	07-09 ▲		
		FLHR 1FB4 Road King	07-11 ▲		
		FLHRC 1FR4 Road King Classic	07-11 ▲		
		FLHTC 1FF4 Electra Glide Classic	07-11 ▲		
		FLHTCU 1FC4 Ultra Classic	07-11 ▲		
		FLHX 1KB4street Glide	07-11 ▲		
		FLHT 1FV4 Electra Glidestandard	08 ▲		
		FLHX 1KB4street Glide	09 ▲		
		FLTRX 1KH4 Road Glide Custom	10-11 ▲		
		FLHTK 1KEM Electra Glide Ultra Limited	10-13 ▲		
		FLHPE 1FTM Road King Police	11 ▲		
		FLHR 103 1FBM Road King	11 ▲		
		FLHR 96 FB4 Road King	11 ▲		
		FLHRC 103 1FRM Road King Classic	11 ▲		
		FLHTC 103 1FFM Electra Glide Classic	11 ▲		
		FLHTCU 103 1FCM Ultra Classic	11 ▲		
		FLHX 103 1KBMstreet Glide	11 ▲		
		FLTRX 103 1KHM Road Glide Custom	11 ▲		
		FLHP 1FHM Road King Police	11-16 ▲		
		FLHTP 1FMM Electra Glidestandard Police	11-16 ▲		
		FLTRU 1KGM Road Glide Ultra	11-13 ▲		
		FLHTC 1FFM Electra Glide Classic	12 ▲		
		FLHR 1FBM Road King	12-13 ▲		
		FLHRC 1FRM Road King Classic	12-13 ▲		
		FLHTCU 1FCM Ultra Classic	12-13 ▲		
		FLHX 1KBMstreet Glide	12-13 ▲		
CK7003	INDIAN				
	Chief Classic	14-21			
	Chief Dark Horse	16-21			
	Chief Vintage	14-18			
	Chieftain	14-21			
Chieftain Dark Horse	16-21				
Chieftain Elite	17-21				
Chieftain Limited	17-18				
Roadmaster	15-18				
Roadmaster Classic	17-21				
Roadmaster Elite	18-21				
Springfield	16-21				
Springfield Dark Horse	18				
CK7004	HARLEY DAVIDSON®STREET				
	XG500	15-20			
	XG750	15-20			
CK7005 CT706SP ▲	HARLEY DAVIDSON®				
	VRSCAW 1HFH V-Rod Wide Tire	08 ▲			
	VRSCAWA 1HKH W/ABS	08 ▲			
	VRSCD 1HDHnight Rod	08 ▲			
	VRSCDA 1HLHnight Rod W/ABS	08 ▲			
	VRSCDXA 1HMHnight Rodspecial W/ABS	08 ▲			
	VRSCDX 1HHHnight Rodspecial	08-21 ▲			
	VRSCAW 1HFH V-Rod	09-10 ▲			
	VRSCF 1HPP V-Rod Muscle	09-21 ▲			
	VRSCDX ANV 1HHH_ANVnight Rodspecial Anv	12 ▲			
CK7006 CT707SP ▲	HARLEY DAVIDSON®				
	VRSCA V-Rod	02-07 ▲			
	VRSCSE CVO V-Rod	05-06 ▲			
	VRXSE CVO VR Destroyer	06 ▲			
	VRSCRstreet Rod	06-07 ▲			
	VRSCXscreamin' Eagle V-Rod	07 ▲			
CK7007 CT708SP ▲	HARLEY DAVIDSON®				
	FLHTCUTG Tri Glide Ultra	17-21 ▲			
	FLRT Freewheeler	17-21 ▲			
	FLHTCUTG Tri Glide Ultra Anniversary	18-21 ▲			
	FLHP Road King Police	17 ▲			
	FLHTP Electra Glidestandard Police	17 ▲			
	FLFBS Fat Boy 114 Anniversary	18-21 ▲			
	FLHCS Heritage Classic 114	18-21 ▲			
	FLHCS Heritage Classic 114 Anniversary	18-21 ▲			

CK CLUTCH KIT BUYERS GUIDE

Part no.	Make/Model	Year	Part no.	Make/Model	Year
CK7008	HARLEY DAVIDSON®		CK7008	HARLEY DAVIDSON®	
CT703SP ▲	FLTRX 1KHM Road Glide Custom	12-13 ▲	CT703SP ▲	FLSTF 1BML Fat Boy	98-99 ▲
Contd.	FLHR ANV 1FBM_ANV Road King ANV	13 ▲		FXSTC 1BKLsoftail Custom	98-99 ▲
	FLHTC 1FFM Electra Glide Classic	13 ▲		FXSTS 1BLLspringersoftail	98-99 ▲
	FLHTK ANV 1KEM_ANV Electra Glide Ultra Limited ANV	13 ▲		FLSTS 1BRL Heritagespringer	98-03 ▲
	FLHRC 1FRM Road King Classic	14-21 ▲		FXST 1BHLsoftailstandard	99 ▲
	FLHTCU 1FCM Ultra Classic	14-21 ▲		FXSTB 1BTLnight Train	99 ▲
	FLHTCU TC 1KSL Ultra Classic Twin-Cooled	14-16 ▲		FLSTC 1BJY Heritagesoftail Classic	00-03 ▲
	FLHTK 1KEL Ultra Limited	14-16 ▲		FLSTF 1BMY Fat Boy	00-03 ▲
	FLHX 1KBMstreet Glide	14-16 ▲		FXST 1BHYsoftailstandard	00-03 ▲
	FLHXS 1KRMstreet Glidespecial	14-16 ▲		FXSTB 1BTYnight Train	00-03 ▲
	FLTRXS 1KTM Road Glidespecial	15 ▲		FXSTD 1BSYsoftail Deuce	00-03 ▲
	FLHR 1FBM Road King	15-21 ▲		FXSTS 1BLYspringersoftail	00-03 ▲
	FLTRX 1KHM Road Glide	15-16 ▲		FLSTCI 1BWB Heritagesoftail Classic	01-03 ▲
	FLTRU 1KGL Road Glide Ultra	16 ▲		FLSTFI 1BXB Fat Boy	01-03 ▲
	FLTRXS 1KTM Road Glidespecial	16 ▲		FLSTSI 1BYB Heritagespringer	01-03 ▲
	FXD 1GHL Dynasuper Glide	98 ▲		FXSTBI 1JABnight Train	01-03 ▲
	FXDWG 1GEL Dyna Wide Glide	98 ▲		FXSTDI 1JBBsoftail Deuce	01-03 ▲
	FXDL 1GDL Dyna Low Rider	98-03 ▲		FXSTI 1BVBsoftailstandard	01-03 ▲
	FXDS-CONV GGVX Dyna Glide Convertible	99 ▲		FXSTSI 1BZBspringersoftail	01-03 ▲
	FXDX 1GJV Dynasuper Glidesport	99-03 ▲		FLSTC 1BJY Heritagesoftail Classic	04-05 ▲
	FXDWG 1GEV Dyna Wide Glide	99-05 ▲		FLSTCI 1BWB Heritagesoftail Classic	04-05 ▲
	FXDS-CONV GGVY Dyna Glide Convertible	00 ▲		FLSTF 1BMY Fat Boy	04-05 ▲
	FXD 1GHV Dynasuper Glide	00-03 ▲		FLSTFI 1BXB Fat Boy	04-05 ▲
	FXDXT 1GLV Dynasuper Glide T-Sport	01-03 ▲		FXSTB 1BTYnight Train	04-05 ▲
	FXDWGI 1GPW Dyna Wide Glide	04 ▲		FXSTBI 1JABnight Train	04-05 ▲
	FXD 1GHV Dynasuper Glide	04-05 ▲		FXSTD 1BSYsoftail Deuce	04-05 ▲
	FXDI 1GMW Dynasuper Glide	04-05 ▲		FXSTDI 1JBBsoftail Deuce	04-05 ▲
	FXDL 1GDV Dyna Low Rider	04-05 ▲		FXSTI 1BVBsoftailstandard	04-05 ▲
	FXDLI 1GNW Dyna Low Rider	04-05 ▲		FXSTS 1BLYspringersoftail	04-05 ▲
	FXDX 1GJV Dynasuper Glidesport	04-05 ▲		FXSTSI 1BZBspringersoftail	04-06 ▲
	FXDXI 1GRW Dynasuper Glidesport	04-05 ▲		FXST 1BHYsoftailstandard	04-06 ▲
	FXDC 1GTV Dynasuper Glide Custom	05 ▲		FLSTClshrine 1JHB Heritagesoftail Classicshrine	05 ▲
	FXDCI 1GVW Dynasuper Glide Custom	05 ▲		FLSTFshrine 1JGB Fat Boyshrine	05 ▲
	FXDWGI 1GPW Dyna Wide Glide	05 ▲		FLSTN 1BNSoftail Deluxe	05 ▲
	FXD35 1GW1 Dyna 35th Anniversarysuper Glide	06 ▲		FLSTNI 1JDBsoftail Deluxe	05 ▲
	FXDBI 1GX1 Dynastreet Bob	06 ▲		FLSTSC 1BRYSpringer Classic	05 ▲
	FXDCI 1GV1 Dynasuper Glide Custom	06 ▲		FLSTSCI 1BYBSpringer Classic	05-06 ▲
	FXDI 1GM1 Dynasuper Glide	06 ▲		FLST 1JEY Heritagesoftail	06 ▲
	FXDWGI 1GP1 Dyna Wide Glide	06 ▲		FLSTC 1BJY Heritagesoftail Classic	06 ▲
	FXDL 1GN4 Dyna Low Rider	07-21 ▲		FLSTCI 1BWB Heritagesoftail Classic	06 ▲
	FXD 1GM4 Dynasuper Glide	07-10 ▲		FLSTFI 1BXB Fat Boy	06 ▲
	FXDC 1GV4 Dynasuper Glide Custom	07-14 ▲		FLSTI 1JFB Heritagesoftail	06 ▲
	FXDWG 1GP4 Dyna Wide Glide	07-16 ▲		FLSTN 1BNSoftail Deluxe	06 ▲
	FXDB 1GX4 Dynastreet Bob	07-21 ▲		FLSTNI 1JDBsoftail Deluxe	06 ▲
	FXDWG ANV 1GP4 Dyna Wide Glide 105th Anniversary	08 ▲		FLSTSC 1BRYSpringer Classic	06 ▲
	FXDF 1GY4 Dyna Fat Bob	08-17 ▲		FXSTB 1BTYnight Train	06 ▲
	FXS 1JP5 Blackline	11 ▲		FXSTBI 1JABnight Train	06 ▲
	FXS 1JP5 Blackline	12 ▲		FXSTD 1BSYsoftail Deuce	06 ▲
	FXS 103 1JPV Blackline	12-13 ▲		FXSTDI 1JBBsoftail Deuce	06 ▲
	FXDWG 103 1GPM Dyna Wide Glide	12-15 ▲		FXSTI 1BVBsoftailstandard	06 ▲
	FLD 103 1GZM Dynaswitchback	12-16 ▲		FXSTS 1BLYspringersoftail	06 ▲
	FLD 1GZ4 Dynaswitchback	12-21 ▲		FXSTSI 1BZBspringersoftail	06 ▲
	FXDF 103 1GYM Dyna Fat Bob	12-17 ▲		FLSTF 1BMY Fat Boy	06-15 ▲
	FXDBA 103 1VBM Dynastreet Bob (H-D1)	13 ▲		FLSTSC 1BY5springer Classic	07 ▲
	HARLEY DAVIDSON			FXSTD 1JB5softail Deuce	07 ▲
	FXDBA 1VB4 Dynastreet Bob (H-D1)	13 ▲		FXSTB 1JA5night Train	07-09 ▲
	FXDC ANV 1GV4_ANV Dynasuper Glide Custom ANV	13 ▲		FXSTC 1JL5softail Custom	07-10 ▲
	FXS 1JP5 Blackline	13 ▲		FXST 1BV5softailstandard	07-11 ▲
	FXDBP 103 1VAM Dynastreet Bob (H-D1)	13-14 ▲		FLSTC 1BW5 Heritagesoftail Classic	07-15 ▲
	FXSB 103 1BFVsoftail Breakout	13-15 ▲		FLSTN 1JD5softail Deluxe	07-15 ▲
	FXSB 1BF5softail Breakout	13-15 ▲		FLST 1JE5 Heritagesoftail	08-09 ▲
	FXDC 103 1GVM Dynasuper Glide Custom	14 ▲		FXCW 1JJ5 Rocker	08-09 ▲
	FXDBB 103 1VCM Dynastreet Bob (H-D1)	14-15 ▲		FLSTSB 1JM5 Cross Bones	08-11 ▲
	FXDB 103 1GXM Dynastreet Bob	14-16 ▲		FXCWC 1JK5 Rocker C	08-11 ▲
	FXDL 103 1GNM Dyna Low Rider	14-16 ▲		FLSTFB 1JN5 Fat Boy LO	10-11 ▲
	FXDBB 1VC4 Dynastreet Bob (H-D1)	15 ▲		FLS 103 1JRVsoftailslim	12 ▲
	FXDBP 103 1VAM Dynastreet Bob (H-D1)	15 ▲		FLSTC 103 1BWV Heritagesoftail Classic	12 ▲
	FXDBC 103 1VDM Dynastreet Bob Limited	16 ▲		FLSTF 1BX5 Fat Boy	12 ▲
	FXDBC 1VD4 Dynastreet Bob Limited	16 ▲		FLSTFB 1JN5 Fat Boy LO	12 ▲
	FXDBP 103 1VAM Dynastreet Bob	16 ▲		FLSTF 103 1BXV Fat Boy	12-14 ▲
	FXDWG 103 1GPM Dyna Wide Glide	16 ▲		FLS 1JR5softailslim	12-15 ▲
	FXSB 1BFVsoftail Breakout	16 ▲		FLSTFB 103 1JNV Fat Boy LO	12-15 ▲
	FXDLS 1GS8 Dyna Low Riders	16-21 ▲		FLSTN 103 1JDVsoftail Deluxe	12-15 ▲
	FXDB 103 1GXM Dynastreet Bob 103	17 ▲		FXST 1BV5softailstandard	12-15 ▲
	FXDL 103 1GNM Low Rider 103	1 ▲		FLSTC 103 ANV 1BWV_ANV Heritagesoftail Classic ANV	13 ▲
	FXDWG 103 1GPM Dyna Wide Glide 103	17 ▲		FLSTC ANV 1BW5_ANV Heritagesoftail Classic ANV	13 ▲
	FXSB 1BFV Breakout	17 ▲		FLSTFB 103 ANV 1JNV_ANV Fat Boy LO ANV	13 ▲
	FLSTC 1BJL Heritagesoftail Classic	98-99 ▲		FLSTFB ANV 1JN5_ANV Fat Boy LO ANV	13 ▲

CK CLUTCH KIT BUYERS GUIDE

Part no.	Make/Model	Year	Part no.	Make/Model	Year	
CK7008 CT703SP ▲ Contd.	HARLEY DAVIDSON®		CK7009 CT701SP ▲ Contd.	HARLEY DAVIDSON®		
	FLS 103 1JRVsoftailslim	13-15 ▲		XL1200T 1LL3superLow 1200T	14-21 ▲	
	FLSTC 103 1BWV Heritagesoftail Classic	13-15 ▲		XL1200CB 1LK3sportster 1200 Custom Limited A	16 ▲	
	FLSTFB 1JN5 Fat Boy LO	13-15 ▲		XL1200CX 1LM3 1200 Roadster	16-18 ▲	
	FLSTF 103 1BXV Fat Boy	15 ▲		XL1200CB 1LK3 1200 Custom Limited B	17 ▲	
	FLS 1JRVsoftailslim	17-20 ▲		XL1200 1LN3 Forty Eight Anniversary	18 ▲	
	FLSTN 1JDVsoftail Deluxe	16 ▲		FLST BJLLsoftail Heritage	90 ▲	
	FLSTC 1BWV Heritagesoftail Classic	16-17 ▲		FLSTC BJ04softail Heritage Classic	90 ▲	
	FLSTF 1BXV Fat Boy	16-17 ▲		FLSTF BMLLsoftail Fat Boy	90 ▲	
	FLSTFB 1JNV Fat Boy LO	16-17 ▲		FXST BHLLsoftailstandard	90 ▲	
	FLS 1JRVslim	17 ▲		FXSTC BKLLsoftail Custom	90 ▲	
	FLSTN 1JDV Deluxe	17 ▲		FXSTS BLLsoftailspringer	90 ▲	
				FLSTC 1BJL Heritagesoftail Classic	91-97 ▲	
				FLSTF 1BML Fat Boy	91-97 ▲	
		FXSTC 1BKsoftail Custom	91-97 ▲			
		FXSTS 1BLLspringersoftail	91-97 ▲			
		FLSTN 1BNL Heritagesoftailnostalgia	93-96 ▲			
		FLSTF 1BML Fat Boy	95 ▲			
		FXSTSB 1BPLspringersoftail	95-97 ▲			
		FLSTS 1BRL Heritagespringer	97 ▲			
CK7009 CT701SP ▲	HARLEY DAVIDSON®		CK7010 CT705SP ▲	HARLEY DAVIDSON®		
	FLHS FALL Touring Electra Glidesport	90 ▲		FLH Electra Glide	84-88 ▲	
	FLHTC DJLL Touring Electra Glide Classic	90 ▲		FLH Electra Glideshrineshovelhead	84 ▲	
	FLHTCU DPLL Touring Electra Glide Classic Ultra	90 ▲		FLHS Electra Glidesport	84-89 ▲	
	FLTC DBLL Touring Tour Glide Classic	90 ▲		FLHT Electra Glide Classic	84-89 ▲	
	FLTCU DMLL Touring Tour Glide Classic Ultra	90 ▲		FLHTCU Electra Glide Classic Ultra	89 ▲	
	FLTC 1DBL Tour Glide Classic	91-92 ▲		FLSTsoftail Heritage	86-89 ▲	
	FLHS 1FAL Electra Glidesport	91-94 ▲		FLSTCsoftail Heritage Classic	87-89 ▲	
	FLTCU 1DML Tour Glide Ultra Classic	91-94 ▲		FLT Tour Glide Classic	84-89 ▲	
	FLHTC 1DJL Electra Glide Classic	91-97 ▲		FLT Tour Glide	84 ▲	
	FLHTCU 1DPL Ultra Classic	91-97 ▲		FLTCU Tour Glide Classic Ultra	89 ▲	
	FLHR FD93 Road King	93 ▲		FXEsuper Glide	84 ▲	
	FLHS 1FAL Electra Glidesport	93 ▲		FXEFsuper Glide Fat Bob	85 ▲	
	FLHTC 1DJL Electra Glide Classic	93 ▲		FXSB Low Rider	84-85 ▲	
	FLHR 1FDL Road King	94-97 ▲		FXSTsoftailstandard	84-89 ▲	
	FLHT 1DDL Electra Glidestandard	94-9 ▲		FXSTCsoftail Custom	86-89 ▲	
	FLTCU 1DML Tour Glide Ultra Classic	95 ▲		FXSTSsoftailspringer	88-89 ▲	
	FLHTCU 1FCR Ultra Classic	95-96 ▲		FXWG Wide Glide	84-86 ▲	
	FLTCUI 1FER Tour Glide Ultra Classic	96 ▲				
	FLHRI 1FBR Road King	96-97 ▲	CK7011 CT704SP ▲	HARLEY DAVIDSON®		
	FLHTCI 1FFR Electra Glide Classic	96-97 ▲		FLH Electra Glide	Early 84 ▲	
	FLHTCU 1FCR Ultra Classic	97 ▲		FLH Electra Glideshrineshovelhead	Early 84 ▲	
	FXDB 1GBL Dynasturgis	91 ▲		FLHS Electra Glidesport	Early 84 ▲	
	FXDB 1GAL Dyna Daytona	92 ▲		FLHT Electra Glide	Early 84 ▲	
	FXDC 1GCLsuper Glide Custom	92 ▲		FLHT Electra Glide Classic	Early 84 ▲	
	FXDS-CONV GGLP Dyna Glide Convertible	93 ▲		FLT Tour Glide Classic	Early 84 ▲	
	FXDL 1GDL Dyna Low Rider	93-97 ▲		FLT Tour Glide	Early 84 ▲	
	FXDWG 1GEL Dyna Wide Glide	93-97 ▲				
	FXD 1GHL Dynasuper Glide	95-97 ▲		CK7012 CT704SP ▲	HARLEY DAVIDSON®	
	XL883DLX 4CFMsportster 883 Deluxe	91-95 ▲			FFLH Electra Glideshrineshovelhead	83 ▲
	XL1200 1CAPsportster 1200	91-03 ▲			FLH Electra Glide	81-83 ▲
	XL883 4CAMsportster 883	91-03 ▲			FLHC Electra Glide Classic	81-82 ▲
	XL883HUG 4CEMsportster 883 Hugger	91-03 ▲			FLHC Electra Glide Classic	81 ▲
	XL1200C 1CGPsportster 1200 Custom	96-03 ▲			FLHS Electra Glidesport	81-83 ▲
	XL1200S 1CHPsportster 1200sport	96-03 ▲			FLHS Heritage Electra Glide	81 ▲
	XL883C 4CJMsportster 883 Custom	98-03 ▲			FLHT Electra Glidestandard	83 ▲
	XL883R 4CKMsportster 883R	02-06 ▲			FLHT Electra Glide Classic	83 ▲
	XL1200C 1CGPsportster 1200 Custom	04-06 ▲	FLHT Electra Glide		83 ▲	
	XL1200R 1CLPsportster 1200 Roadster	04-06 ▲	FLHTC Electra Glide Classic		83 ▲	
	XL883 4CAMsportster 883	04-06 ▲	FLT Tour Glide		81-83 ▲	
	XL883C 4CJMsportster 883 Custom	04-06 ▲	FLT Tour Glide Classic		80-83 ▲	
	XL883L 4CMMsportster XL883 Low	05 ▲	FXBsuper Glide B80		81-82 ▲	
	XL1200L 1CWPsportster 1200 Low	06 ▲	FXDG Dyna Glide Custom		83 ▲	
	XL883L 4CMMsportster XL883 Low	06 ▲	FXEsuper Glide		81-83 ▲	
	XL50 1CY3 50th ANVsportster	07 ▲	FXEFsuper Glide Fat Bob		81 ▲	
	XL1200R 1CV3sportster 1200 Roadster	07-09 ▲	FXSB Low Rider		83-84 ▲	
	XL883 4CN2sportster 883	07-09 ▲	FXSTsoftailstandard	EARLY 84 ▲		
	XL883L 4CR2sportster XL883 Low	07-09 ▲	FXWG Wide Glide	81-84 ▲		
	XL883C 4CP2sportster 883 Custom	07-10 ▲				
	XL883R 4CS2sportster 883R	07-10 ▲	CK7013 CT701SP ▲	HARLEY DAVIDSON®		
	XL1200L 1CX3sportster 1200 Low	07-11 ▲		XR1200sportster 1200	08-10 ▲	
	XL1200N 1CZ3nightster	07-12 ▲		XR1200Xsportster 1200X	10-13 ▲	
	XL1200C 1CT3sportster 1200 Custom	17-21 ▲				
	XL883N 4LE2 Iron 883	09-21 ▲		CK7014 CT709SP ▲	HARLEY DAVIDSON®	
XL883L 4CR2sportster 883 Low	10 ▲	XL1200sportster 1200			90 ▲	
XL1200X 1LC3 Forty Eight	10-21 ▲	XL883sportster 883			86-90 ▲	
XL883L 4CR2sportster 883 Low	11 ▲	XL883sportster 883 Deluxe			86-90 ▲	
XL883R 4CS2 883 Roadster	11-15 ▲	XL883HUGsportster 883 Hugger			87-90 ▲	
XL1200CP 1LH3sportster 1200 Custom (H-D1)	11-21 ▲					
XL1200V 1LF3seventy-Two	12-16 ▲					
XL883L 4CR2superLow	12-18 ▲					
XL1200C ANV 1CT3_ANVsportster 1200 Custom ANV	13 ▲					
XL1200CB 1LK3sportster 1200 Custom Limited B	13-15 ▲					
XL1200CA 1LJ3sportster 1200 Custom Limited A	13-21 ▲					
XL883R 4CS2 883 Roadster	14 ▲					
XL883L 4CR2superLow	14-16 ▲					

CK CLUTCH KIT BUYERS GUIDE

Part no.	Make/Model	Year	Part no.	Make/Model	Year
CK7014 CT709SP ▲ Contd.	HARLEY DAVIDSON® XLH 1100sportster 1100 XLHsportster 1000 XLH883DLXsportster 883 Hugger Deluxe XLSsportster Roadster 1000 XR1000sportster	86-87 ▲ 84-85 ▲ 88-89 ▲ 84-85 ▲ 84 ▲			
CK7015 CT709SP ▲	HARLEY DAVIDSON® XLCHsportster 1000 XLHsportster 1000 XLHsportsterstandard 1000 XLSsportster Roadster 1000 XR1000sportster	71-80 ▲ 79-84 ▲ 71-80 ▲ 81-84 ▲ 83-84 ▲			
CK7016	HARLEY DAVIDSON® XLCHsportster 1000 XLHsportster 1000standard	70 70			
CK7018	INDIAN FTR 1200	19-21			

DRC CLUTCH KIT BUYERS GUIDE

Part no.	Make/Model	Year	Part no.	Make/Model	Year
DRC1 CT012SP ■	HONDA CR 80 R/RB Expert CR 85 R/RB	85-02 ■ 03-07 ■	DRC24 CT022 ▲	SUZUKI RM 250 J/K/L	88-90 ▲
DRC2 CT001 ▲	HONDA CR 125 R	86-99 ▲	DRC25 DRCF25 CT011 ▲	SUZUKI RM 80 M/N/P/R/S/T/V/W/X/Y/K1 RM 85 (Small Wheel F 17 Inch/R 14 Inch Wheel) RM 85 (Big Wheel F 19 Inch/ R 16 Inch)	91-01 ▲ 02-21 ▲ 02-21 ▲
DRC3 CT009 ▲	HONDA CR 250 R CR 480 R CR 500 R	83-89 ▲ 83 ▲ 84-89 ▲	DRC26 CT022 ▲	KAWASAKI LT 500 RH/RJ/RK/RL	87-90 ▲
DRC4 CT012SP ▲	HONDA TRX 200sX Fourtrax TRX 200 Fourtrax TRX 200 D Type II Fourtrax TRX 250 EX (Sportrax 250 EX) TRX 250 TE Recon ES TRX 250 TM Recon	86-88 ▲ 90-91 ▲ 91-97 ▲ 01-08 ▲ 97-14 ▲ 97-14 ▲	DRC27 CT010 ▲	YAMAHA YZ 80s/T/U/W/A/B/D	86-92 ▲
DRC5 CT013 ▲	HONDA ATC 250 R TRX 250 R Fourtrax	86 ▲ 86-87 ▲	DRC28 CT054SP ▲	YAMAHA YZ 125s/T	86-87 ▲
DRC6 CT013SP ▲	HONDA TRX 300 All models (2wd & 4wd) Fourtrax TRX 350 All models TRX 400 FW Fourtrax Foreman TRX 400 FM Fourtrax Foreman TRX 450 ES TRX 450s TRX 450 FE TRX 450 FM	88-00 ▲ 86-89 ▲ 95-01/03 02 ▲ 98-01 ▲ 98-01 ▲ 02-04 ▲ 02-04 ▲	DRC29 CT054SP ▲	YAMAHA YZ 125 U	88 ▲
DRC7	KAWASAKI KX 60 B1-B19 SUZUKI RM 60 K3	85-03 03	DRC30 CT054SP ▲	YAMAHA YZ 125 W/A	89-90 ▲
DRC8	KAWASAKI KX 80 E3/G1/G2/J2	85-87	DRC31	YAMAHA YZ 250 U/W/A/B/D	88-92
DRC9	KAWASAKI KX 80 L1	88	DRC32 CT060 ▲	YAMAHA YTZ 250n/S IT 250 K IT 490 K/L YZ 490 J/K/L/N/S/T/U/W WR 500 ZD/ZE	85-86 ▲ 83 ▲ 83-84 ▲ 82-89 ▲ 92-93 ▲
DRC10	KAWASAKI KX 80 L2/L3/N2/N3 KX 80 R1-R7 KX 100 B5/B6/B7	89-90 91-97 95-97	DRC33 DRCF33 CT090SP ▲	YAMAHA YFM 350 ERT/ERU/ERW/ERA/ERD/ERE/ERF YFM 350 FWT/FWU/FWW/FWA/FWB/FWD /FWE (Big Bear) YFM 350 XT/XU/XW/XA/XB/XD/XE/XF/XG/XH/XJ /XK/XL/XM/XN/XP/XR/XS (Warrior) YFM 350 RS/RT/RW/RX/RZ/XAsupermotard	87-94 ▲ 87-93 ▲ 87-04 ▲ 04-13 ▲
DRC11 CT042 ▲	KAWASAKI KX 125 D1/E1/E2	85-87 ▲	DRC35 CT060s	YAMAHA YZ 250n/S/T	85-87 ▲
DRC13 CT042 ▲	KAWASAKI KX 125 F1/G1	88-89 ▲	DRC36 CT042 ▲	YAMAHA KX 125 H1/H2	90-91 ▲
DRC15 CT006 ▲	KAWASAKI KX 250 G1	89 ▲	DRC38 CT006 ▲	YAMAHA KXT 250 B1/B2 Tecate	86-87 ▲
DRC16 CT006 ▲	KAWASAKI KX 500 C1/D1 KX 500 E1-E16	87-88 ▲ 89-04 ▲	DRC39 CT005 ▲	YAMAHA YZ 125 B/D WR 250 RX/RZ/RA/RB/RD/RE/RF WR 250 XX/XY/XZ/XAsupermotard	91-92 ▲ 08-15 ▲ 08-11 ▲
DRC17 CT006 ▲	KAWASAKI KX 250 H1	90 ▲	DRC40 CT022 ▲	SUZUKI RM 250 M	91 ▲
DRC19	SUZUKI RM 80 H/J	87-88	DRC41 CT006 ▲	KAWASAKI KDX 250 D1/D2/D3/D4 KX 250 H2	91-94 ▲ 91 ▲
DRC20 CT011 ▲	SUZUKI RM 80 K/L	89-90 ▲	DRC42 DRCF42 CT010 ▲	YAMAHA YFS 200 U/W/A/B/D/E/F/G/H/J/K/L/M/N/P/R/S /T/V Blaster WR 200 D	88-06 ▲ 92 ▲
DRC21 CT011 ▲	SUZUKI RM 125 G/H	86-87 ▲	DRC43 DRCF43 CT008 ▲	YAMAHA YFZ 350 T/U/W/A/B/D/E/F/G/H/J/K/L/M/N /P/R/S/T/V (Banshee)	87-06 ▲
DRC22 CT011 ▲	SUZUKI RM 125 J/K/L/M	88-91 ▲	DRC44 DRCF44 CT013SP ▲	HONDA ATC 250sX TRX 250 X Fourtrax XR 250 R XR 250 L TRX 300 EX Fourtrax/Sportrax TRX 300 X XR 350 R	85-87 ▲ 87-88/91-92 ▲ 86-95 ▲ 91-96 ▲ 93-08 ▲ 09-11 ▲ 83-85 ▲
DRC23	KAWASAKI LT 250 RH/RJ/RK/RL/RM/RN	87-92			

DRC CLUTCH KIT BUYERS GUIDE

Part no.	Make/Model	Year	Part no.	Make/Model	Year
DRC45 DRCF45 CT002 ■	KAWASAKI KX 80 W1/W2/W3 KX 85 (F 17"/R 14") KX 85 (F 19"/R 16") KX 100 C1/C2/C3/D1-D5/D6F/D7F/D8F/D9F /DBF/DCF/DDF/FEF/FFF/FGF/FHF	98-00 ■ 01-21 ■ 01-21 ■ 98-09/11-17		KLX 650 C1/C2/C3/C4	93-96 ▲
DRC46 DRCF46 CT016 ▲	KAWASAKI KX 250 J1/J2/K1-K5/L1-L4/M1/M2/R1/R6F/R7F	92-07 ▲	DRC66 CT010 ▲	YAMAHA YZ 80 E/F	93-94 ▲
DRC48 CT022 ▲	SUZUKI RM 250 M/N/P	91-93 ▲	DRC67 CT013 ▲	HONDA CR 125 R	83-84 ▲
DRC49 DRCF49 CT012SP ■	HONDA CRF 100 F XR 100 R	04-16 ■ 87-03 ■	DRC68 CT001 ▲	HONDA CR 125 R	85 ▲
DRC50 CT012SP ■	HONDA NX 125	88-90 ■	DRC69 CT042 ▲	KAWASAKI KX 125 J2	93 ▲
DRC51 CT013SP ■	HONDA NX 250	88-90 ■	DRC70 DRCF70 CT005 ▲	YAMAHA YZ 125 E/F/G YZ 125 J/K/L/M/N YZ 125 E/F/G/H/J/K/L/M/N/P/R/S/T/V/W/X/Y/Z A/B/D/E/F/G (2T)	93-95 ▲ 97-01 ▲ 93-21 ▲
DRC52 CT022 ▲	SUZUKI RM 250 H	87 ▲	DRC71 CT020 ▲	YAMAHA YZ 250 E/F/G/H/J/K/L WR 250 ZF/ZG/ZH/ZJ	93-99 ▲ 94-97 ▲
DRC53 CT013SP ■	HONDA XL 600 V	89-90 ■	DRC72 CT022 ▲	SUZUKI RM 250 R/S RMX 250 R/S/T/V/W/X/Y	94-95 ▲ 94-00 ▲
DRC54 DRCF54 CT009 ▲	HONDA XR 600 R NX 650 XR 650 L	85-00 ▲ 88-89 ▲ 93-16 ▲	DRC73 CT004 ▲	KAWASAKI KX 125 K4/K5/L1-L4	97-02 ▲
DRC55 CT039 ▲	YAMAHA BW 200n/S/ES/ET/EU	85-88 ▲	DRC74 CT042 ▲	KAWASAKI KDX 200 C1/C2/C3	86-88 ▲
DRC56 CT008 ▲	YAMAHA XT 350n/NC/S/SC/C/AC/B/BCT/TC/U/UC/W /WC/D/DC/E/EC/F/FC/G/GC/H/HC/J/JC/K/KC /L/M/MC TT 350s/T	85-00 ▲ 86-87 ▲	DRC75 CT009 ▲	HONDA CR 250 R CR 500 R CR 500 R	90-93 ▲ 90-94 ▲ 95-01 ▲
DRC57 CT008 ▲	YAMAHA TT 600 K/L/N/S XT 600 L/LC/N/NC/S/SC/T/TC/U/UC/W/WC	83-86 ▲ 84-89 ▲	DRC76S CT003 ▲	SUZUKI RM 125 P/R/S/T/V/W	93-98 ▲
DRC58 DRCF58 CT022 ▲	SUZUKI DR 250 L/M/N/P DR 250sL/SM/SN/SEP/SER/SES DR 350 L/M/N/P/R/S/T DR 350sL/SM/SN/SP/SER/SES/SET/SEV/SEW/SEX	90-93 ▲ 90-95 ▲ 90-96 ▲ 90-99 ▲	DRC78 CT010 ▲	YAMAHA YZ 80 G/H/J/K/L/M/N	95-01 ▲
DRC59 CT009SP ■	SUZUKI DR 650sL/SM/SN/SP	90-95 ■	DRC79 DRCF79 CT009 ▲	HONDA CR 250 R	94-07 ▲
DRC60 CT013SP ■	HONDA XR 200 R XL 250 R XR 250 R	84-85 ■ 84-87 ■ 84-85 ■	DRC80 CT016 ▲	SUZUKI RM 250 T	96 ▲
DRC61 CT042 ▲	KAWASAKI KDX 200 E1-E6	89-94 ▲	DRC81 CT013 ▲	HONDA TRX 250 R Fourtrax	88-89 ▲
DRC62	KAWASAKI KDX 200 H1-H11/H6F KDX 220 R A4-A12/A6F	95-06 97-06	DRC82 CT008s CT090SP ■	YAMAHA YFM 350 ERG YFM 350 FWF/FWG/FWH/FWJ/FWBK#(Big Bear) YFM 350 UH/UJ/UK/UL/ULC YFM 400 FWE/FWF/FWG/FWH/FWJ/FWK/FWL Kodiak YFM 400 FWR (4x4) Big Bear	95 ■ 94-98 ■ 96-99 ■ 93-99 ▲ 03 ▲
DRC63 CT004 ▲	KAWASAKI KLR 250 (KL 250) D2 to D22	85-05 ▲	DRC83 CT042 ▲	KAWASAKI KX 125 J1	92 ▲
DRC64 CT016 ▲	KAWASAKI KLR 600 (KL 600 A1/B1/B2) KLX 650 A1/A2/A3/D1 (KLX650R)	84-86 ▲ 93-96 ▲	DRC84 CT013SP ■	HONDA XR 250 R	96-04 ■
DRC65 CT016 ▲	KAWASAKI KLR 650 (KL 650 A1-A9) KL 650 B2/B3 TENGAI	87-95 ▲ 90-91 ▲	DRC85 CT005 ▲	YAMAHA YZ 125 H YZ 125 P/R/S	96 ▲ 02-04 ▲
			DRC87 CT024 ▲	SUZUKI DR 650sET/SEV/SEW/SEX/SEY/SEK1/SEK2/ sEK3/SEK4/SEK5/SEK6/SEK7/SEK8/SEK9 /SEL1/SEL2/SEL3/SEL4/SEL5/SEL6	96-16 ▲

DRC CLUTCH KIT BUYERS GUIDE

Part no.	Make/Model	Year	Part no.	Make/Model	Year
DRC88 DRCF88 CT008 ▲	YAMAHA YFM 660 RN/RP/RPB/RR/RS/RT Raptor XT 600 EA/EAC/EB/EBC/ED/EDC/EE/EEC/EF /EFC/EG/EGC	01-05 ▲ 90-95 ▲	DRC104 CT010SP ■ Contd.	YAMAHA Contd. YFM 250 Bear Tracker L/LC/M/MC/XN/XHN/XP /XHP/XR/XHR/XS YFM 250 BT/BV Bruin YFM 250 BW/BX/BY Big Bear YFUJW/YFUJTW Pro Hauler (230cc)	99-03 ■ 05-06 ■ 07-09 ■ 89 ■
DRC89 CT011 ▲	SUZUKI LT 250 EFF/EFB LT-4WD Quadrunner 4WD H/J/K/L/M/N/P/R/S/T/V LT-F 4WD V/W Quadrunner 4WD (250cc) LT-F 250 J/K/L/M/N/P/R/S/V/W/X/Y/K1 LT-F 250 FX/FY/FK1/FK2 Quadrunner LT 300 EH/EJ/EK Quadrunner 250 (2 x 4 / 4 x 4)	85-86 ▲ 87-97 ▲ 97-98 ▲ 88-01 ▲ 99-02 ▲ 87-88 ▲ 01-05 ▲	DRC105 DRCF105 CT006 ▲	ARCTIC CAT 400 DVX KAWASAKI KLX 400 R (KLX 400 B1/B2) KLX 400sR (KLX 400 A1/A2) KSF 400 A1/A2 (KFX 400) SUZUKI DR-Z 400s DR-Z 400 E DR-Z 400sM LT-Z 400 K3/K4 QuadSport	04-06 ▲ 03-04 ▲ 03-04 ▲ 03-04 ▲ 00-16 ▲ 00-07 ▲ 05-22 ▲ 03-04 ▲
DRC91 CT012SP ■	HONDA XR 200 XR 200 R XR 200 R	80-84 ■ 81-83 ■ 86-02 ■	DRC106 CT013 ▲	HONDA XR 400 R	97-04 ▲
DRC92 CT009 ▲	HONDA XL 600 R XL 600 R to 520822 XL 600 R from 5208023 XL 600 R	83-84 ▲ 85 ▲ 85 ▲ 86-87 ▲	DRC107 DRCF107 CT027 ▲	KTM SX 60 SX 65 XC 65	98-00 ▲ 98-08 ▲ 08 ▲
DRC93 CT013s CT013SP ■	HONDA ATC 250 R XR 400 R	85 ■ 96 ▲	DRC108 DRCF108 CT007 ▲	KTM SX 250 (2T) 250 EGS 250 EXC 250 MXC XC-W 250 (2T) XC 250 (2T) 250sXS 300 E-GS 300 EXC 300 MXC 300 MXC SX 300 300six Days XC 300 XC-W 300 360 EGS 360 EXC 360 MXC 360sX 360six Days 380 EXC 380 MXC SX 380 RXC-E 400 RXC-E 620	94-12 ▲ 94-99 ▲ 94-05 ▲ 98-99 ▲ 06-12 ▲ 06-12 ▲ 01-03 ▲ 94-99 ▲ 94-05 ▲ 94-03 ▲ 04-05 ▲ 94 ▲ 96 ▲ 06-12 ▲ 06-11 ▲ 96-97 ▲ 96-97 ▲ 96-97 ▲ 96-97 ▲ 96 ▲ 98-02 ▲ 98-01 ▲ 98-02 ▲ 95 ▲ 95 ▲
DRC94 CT011s	SUZUKI DR 200 G/H/J SP 200 G/H/J LT 230sF/SG/SH/SJ from E/No. 104361	86-88 ▲ 86-88 ▲ 85-88 ▲			
DRC95 CT016 ▲	SUZUKI RM 250 V/W/X/Y/K1/K2	97-02 ▲			
DRC96 CT011s DRC97 CT020 ▲	KAWASAKI LT 250sK/SL YAMAHA YZ 250 M/N	89-90 ▲ 00-01 ▲			
DRC98 DRCF98	KAWASAKI KX 65 KLX 110 KLX 110 L SUZUKI RM 65 K3/K4/K5 RM 100 K3/K4 DR-Z 110 K3/K4/K5	00-21 02-21 10-21 03-05 03-04 03-05			
DRC99 CT008 ▲	YAMAHA WR 400 FK/FL/FM	98-00 ▲	DRC109 DRCF109 CT005 ▲	YAMAHA YZ 250 FN/FP/FR/FS/FT/FV/FW WR 250 FN	01-07 ▲ 01 ▲
DRC100 DRCF100 CT013 ▲ DRC101 DRCF101 CT001 ▲	HONDA TRX 400 EX Fourtrax/Sportrax TRX 400 X HONDA CR 125 R	99-08 ▲ 09-14 ▲ 00-07 ▲	DRC110 CT020 ▲	YAMAHA WR 426 FN/FP WR 450 FR	01-02 ▲ 03 ▲
DRC102 CT020 ▲	YAMAHA YZ 426 FM	00 ▲	DRC111 DRCF111 CT010 ▲	YAMAHA YZ 85 (2T/Small Wheel F 17 Inch/R 14 Inch) YZ 85 (2T/Big Wheel F 19 Inch/R 16 Inch)	02-21 ▲ 02-21 ▲
DRC103 CT011 ▲	SUZUKI LT-F 300 FX/FY/FK1/FK2 King Quad LT-F 4WDXM/N/P/R/S/T/V/W 300 King Quad 250 (2 x 4) 300 (2 x 4 / 4 x 4) 300 (4 x 4)	99-02 ▲ 91-97 ▲ 99-00 ▲ 98-04 ▲ 05 ▲	DRC112 CT009 ▲	HONDA CRF 450 R	02-03 ▲
DRC104 CT010SP ■	YAMAHA YTM 225 DXK/DXL/ DXN YFM 225s/T/U/W (Moto 4) YBF 250 D/E Timberwolf YFB 250 F/G/H/UH/J/UJ/UK Timberwolf YFB 250 FWF/FWG/FWH/FWJ/FWK/FWL/FWM Timberwolf YFM 250 W/A/B	83-85 ■ 86-89 ■ 92-93 ■ 94-98 ■ 94-00 ■ 89-91 ■	DRC113 DRCF113 CT020s	YAMAHA YZ 250 P/R/S/T/V/W/X/Y/Z/A/B/D/E/F/G/H/J (2T)	02-18 ▲
			DRC114 CT003 ▲	SUZUKI RM 125n	92 ▲
			DRC115 CT003 ▲	SUZUKI RM 125 X/Y/K1	99-01 ▲

DRC CLUTCH KIT BUYERS GUIDE

Part no.	Make/Model	Year	Part no.	Make/Model	Year
DRC116 CT020 ▲	YAMAHA YZ 426 FN/FP	01-02 ▲	DRC170 Contd. CT030 ▲	640 LC Rallye Dakar 660 LC4	97 ▲ 97 ▲
DRC117	KTM 250 EXC Racing 250 EXC-G Racing 400 EXC 400 MXC SX 400 450 EXC Racing 450 EXC-G Racing 450 MXC-G Racing 450sX Racing 520 EXC SX 520 525 EXC/EXC-G Racing 525 MXC Desert Racing 525 MXC-G Racing 525sX Racing	04 04 00-01 01 00-01 04 04 04 04 04 00-01 00-01 04 04 04 04 00-01 00-01	DRC171 CT023 ▲	KTM XC 450/525 (Quad) 250 EXC Racing 250 EXG-G Racing 400 EXC 400 EXC Racing 400 EXC-G Racing 400 MXC 400sX Racing 450 EXC 450 EXC Racing 450 EXC-G Racing MXC 450 450 MXC-G Racing SMR 450 SX 450 450sX Racing 520sX Racing 525 EXC-G/EXC Racing EXC 525 Racing (4T) MXC 525 525 MXC Desert Racing SX 525 525sX Racing 540sXS Racing SMR 560	08-12 ▲ 02-03 ▲ 03 ▲ 07 ▲ 02 ▲ 02/06 ▲ 02 ▲ 02 ▲ 06-07 ▲ 03 ▲ 03 ▲ 06 ▲ 03 ▲ 06 ▲ 03 ▲ 03 ▲ 06 ▲ 06 ▲ 03 ▲ 02 ▲ 03 ▲ 03 ▲ 06 ▲ 06 ▲
DRC119 DRCF119 CT005 ▲	YAMAHA WR 250 FP/FR/FS/FT/FV/FW/FX/FY/FZ/FA/FB/FD	02-13 ▲	DRC172 CT023 ▲	KTM 450sMS	04 ▲
DRC120 CT006 ▲	SUZUKI LT-F 400 FK2/FK3/FK3/FK4/FK5/FK6/FK7#(Eiger 4WD) LT-F 400 K3/4/5/6/7 LT-F 400 FK8/FK9 King Quad 400 FS LT-F 400 FCK8/FCK9 King Quad 400 FS Camo 400 (2 x 4 / 4 x 4) 400 (4 x 4 Manual)	02-07 ▲ 03-08 ▲ 08-10 ▲ 08-09 ▲ 03-04 ▲ 05-08 ▲	DRC174 CT001 ▲	KTM SX 125	08 ▲
DRC164 DRCF164 CT045 ▲	SUZUKI LT-R 450 K6/K7/K8/K9 LT-R 450 ZK8/ZK9 QuadracersE	06-11 ▲ 08-10 ▲	DRC175 CT030 ▲	KTM 660sM Factory Replica 660sMC 660sMS	02-03 ▲ 03-04 ▲ 04 ▲
DRC168 CT016 ▲	KAWASAKI KLR 650 (KL 650 A10-A19/A6F/A7F) KL 650 E8F/E9F/EAF/EBF (KLR 650)	96-07 ▲ 08-11 ▲	DRC176 CT030 ▲	KTM 660 Rallye 660 Rallye Factory	01-03 ▲ 04 ▲
DRC169 CT030 ▲	KTM 350 EXC 350super Comp 400 Duke 400 EGS 400 EXC 400super Comp 620 Duke 620 EGS 620 EXC 620super Comp	94 ▲ 94-95 ▲ 94-95 ▲ 94 ▲ 94 ▲ 95 ▲ 94 ▲ 94-95 ▲ 94-95 ▲ 94-95 ▲	DRC177 CT015 ▲	KTM 950 Adventures 950 Adventure 950superduke 950 Rsuper Enduro 990 Adventure 990 Adventures 990superduke R 990sM-R 990sM-T	03-04 ▲ 06 ▲ 05-11 ▲ 07-08 ▲ 07-11 ▲ 07-09 ▲ 07-11 ▲ 09-11 ▲ 09-14 ▲
DRC170 CT030 ▲	KTM 380 EGS 400 EGS 400 EGS-E 400 EXC 400 LC-4 LC4 R 400 400 LC4-E 400 LSE 400 LS-E 400super Comp/EXC 400 RXC-E SXC 400 400sX-C 400sX 400sXC 400 TXC 620 Duke 620 EGS-E 620 EGS/Adventure 620 Enduro Ltd 620 LC-4 620 LSE 620six Days 620 RXC-E SXC 620	98-99 ▲ 96-97 ▲ 97 ▲ 96 ▲ 98 ▲ 99 ▲ 00-01 ▲ 97 ▲ 04 ▲ 96-99 ▲ 96-97 ▲ 97 ▲ 98 ▲ 99 ▲ 00 ▲ 98 ▲ 97 ▲ 97 ▲ 96-97 ▲ 97 ▲ 98 ▲ 97 ▲ 96 ▲ 96-97 ▲ 97 ▲	DRC178 CT075 ▲	KTM 400 RXC-E EXC 400 SC 400 620 RXC-E	95 ▲ 93-95 ▲ 95 ▲ 95 ▲
			DRC179 CT009 ▲	HONDA XR 650 R	00-07 ▲
			DRC180 CT012SP ■	HONDA CRF 150 F	03-05 ■
			DRC181 CT012SP ■	HONDA CRF 150 F	06-19 ■
			DRC182 DRCF182 CT002 ▲	HONDA CRF 150 R/RB	07-21 ▲

DRC CLUTCH KIT BUYERS GUIDE

Part no.	Make/Model	Year	Part no.	Make/Model	Year
DRC184 CT009 ▲	KTM SX 450 (Quad) SX 505 (Quad) SX-F 450 XC-F 450 SX-F 505 XC-F 505	09-12 ▲	DRC209 CT012SP ▲	LIFAN LF 200 GY-S	05-08 ▲
		09-12 ▲			DRC211
		07-11 ▲	DRC212 CT042 ▲	KAWASAKI KLX 250s (KLX 250H6F/H7F) KLX 250s (KLX 250 T9F/TAF/TBF/TCF/TDF/TEF) KLX 250sF (KLX 250 W9F/TAF)supermotard KLX 300 R A3-A10/A6F/A7F KLX 300 R CLF	
		08-09 ▲			DRC185 CT006 ▲
07-08 ▲	DRC189 DRCF189 CT004 ▲	SUZUKI RM-Z 250 K7/K8/K9	07-09 ▲		
08-09 ▲			DRC194 CT020 ▲	YAMAHA WR 450 FT/FV/FW/FX/FY/FZ/FA/FB/FD/FE/FF	05-15 ▲
DRC195 DRCF195 CT020 ▲	YAMAHA YZ 450 FW/FX/FY/FZ/FA/FB/FD	07-13 ▲			DRC214 CT006 ▲
		DRC196 CT030 ▲	KTM 540sXC 620 LC4 Competition 620 LC4super Moto 620super Comp SX 620 SX 620 620sC 620supermoto 620 TXC 625sMC 625sC 625sXC 640 Adventure-R 640 Duke-E 640 Duke-II 640 LC4 640 LC4-E 640 LC4 Adventure 640 LC4supermoto 640 LC4six Days 660 LC4 Rallye	98-99 ▲	
99 ▲	DRC216 CT006 ▲			ARCTIC CAT Bearcat 454 (4 x 4) Bearcat 454 (2 x 4) 500 (4 x 4 Manual) 500 (Manual 4x4) SUZUKI LT-F 500 FK3/FK4/FK5/FK6/FK7 #Vinson 4WD	96-98 ▲ 97-98 ▲ 03-04 ▲ 05-09 ▲
99 ▲					DRC217 CT006 ▲
96-99 ▲	DRC218 CT011 ▲			SUZUKI LT 160 EK/EL/EM/EN LT 160 K3/K4 LT-F 160 M/N/P/R/S/T/V/W/X/Y/K1/K3 LT 230 GEF/GEG LT-F 230 G/H LT 230 EH/EJ/EK/EL/EM/EN/EP	
97-99 ▲					DRC220 CT011 ▲
99 ▲	DRC221 CT011 ▲			SUZUKI LT-F 250 K3 Ozark LT-F 250 K5/K6/K7/K8/K9/L2/L3/L4 Ozark	
00-01 ▲					DRC222 CT011 ▲
98 ▲	DRC223 CT006 ▲			SUZUKI LT-F 400 K2 Eiger Manual 2WD	
98 ▲					DRC224 CT013SP ■
04/06 ▲	DRC225 CT004 ▲			KAWASAKI KSF 250 A1-A18 Mojave	
02 ▲					DRC226 CT005 ▲
03-04 ▲	DRC227 DRCF227 CT005 ▲			YAMAHA YZ 250 FX/FY/FZ/FA/FB/FD (4T)	
03-04 ▲					DRC228 CT008 ▲
03-06 ▲	DRC199 CT030 ▲			KTM 690 Rally Factory Rep	
03-04 ▲					DRC200 DRCF200 CT005 ▲
03-06 ▲	DRC201 DRCF201 CT020 ▲			YAMAHA YFZ 450 BBW Bill Balance Edition YFZ 450sEW/SPXspecial Edition YFZ 450 W/X/Y/A/B/D	
03-04 ▲					DRC205 CT069 ▲
03-06 ▲	DRC208 DRCF208 CT001 ▲	HONDA CRF 250 R CRF 250 X	08-09 ▲ 04-17 ▲		
03-06 ▲			DRC208 DRCF208 CT001 ▲	HONDA CRF 250 R CRF 250 X	08-09 ▲ 04-17 ▲

DRC CLUTCH KIT BUYERS GUIDE

Part no.	Make/Model	Year	Part no.	Make/Model	Year
DRC228 CT008 ▲ Contd.	YFM 400 FWNMC/FWNN/FWNHM Big Bear 4WD/Real Tree Xtra YFM 400nM/NMC/NN/NHN/P/HP Big Bear 2WD YFM 400s Big Bear 2WD YFM 400 FS/FT Big Bear 4WD YFM 400 FBW/FBX/FBY/FBA/FBB Big Bear 4WD IRS YFM 400 FBHW Big Bear 400 #Hunter-IRS YFM 400 FBEW Big Bear 400 IRS #Exploring Edition	00-01 ▲ 00-03 ▲ 04 ▲ 04-05 ▲ 07-12 ▲ 07- ▲ 07 ▲	DRC244 DRCF244 CT009 ▲	HONDA CRF 450 R/RA (4spring)	09-10 ▲
DRC229 CT039 ▲	YAMAHA TT 225s/T TT-R 225 L/M/N/P/R/S XT 225 J/JC/K/KC/L/M/MC/N/NC/P/PC/R /RC/S/SC/T/TC/V/VC/W/WC TT-R 230 T/V/W/X/Y/A/B/D/E/F	86-87 ▲ 99-04 ▲ 92-07 ▲ 05-09/11-15 ▲	DRC249 CT012SP ■	HONDA CRF 230 L CRF 230 M	08-11 ■ 09-11 ■
DRC230 DRCF230 CT044 ▲	YAMAHA TT-R 125 TT-R 125	00-09 ▲ 00-09/11-19 ▲	DRC252 CT041 ▲	KTM XC-W 400 XC-W 450six Days EXC 450 EXC-R 450 XCR-W 450 XCR-W 530 XC-W 450 Champions Edition EXC 530 EXC 530 Champion Edition EXC-R 530 XC-Wsix Days	10-11 ▲ 10-11 ▲ 10-11 ▲ 08 ▲ 08 ▲ 08 ▲ 10 ▲ 10-11 ▲ 10 ▲ 08 ▲ 10-11 ▲
DRC231 CT039 ▲	YAMAHA TW 200 Trailway XT 225	87-15 ▲ 92-96 ▲	DRC254 DRCF254 CT045 ▲	SUZUKI RM-Z 450 K5/K6/K7	05-07 ▲
DRC232 CT010SP ■	YAMAHA YTM 200 K/L/N YTM 200 EK/EL/ERN YTM 225 DRN/DRS YFM 200n YFM 200 DXS/DXT/DXU/DXW (Moto 4)	83-85 ■ 83-85 ■ 85-86 ■ 85 ■ 86-89 ■	DRC255 DRCF255 CT004 ▲	SUZUKI RM-Z 250 L0/L1/L2/L3/L4/L5/L6	10-21 ▲
DRC233 CT006 ▲	KAWASAKI KEF 300 A1 -A6 Lakota KEF 300 B1/B2/B3 Lakotasport KLF 300 A1/A2/B1-B17/C1-C17 Bayou	95-00 ▲ 01-03 ▲ 86-05 ▲	DRC256 DRCF256 CT001 ▲	HONDA CRF 250 R	10 ▲
DRC234 CT006 ▲	KAWASAKI KLF 400 B1-B7 Bayou (4 x 4)	93-98 ▲	DRC259 DRCF259 CT009 ▲	HONDA CRF 450 R (4spring type)	11-12 ▲
DRC236 CT013SP ▲	HONDA TRX 500 FPE Fourtrax Foreman 4x4 ES/EPS TRX 500 FE/FEA Fourtrax Foreman 4x4 EPS	08-11 ▲ 08-11 ▲	DRC260 CT023 ▲	KTM SX-F 250 (4T) XC-F 250 SX-F 350 XC-F 350	13-18 ▲ 13-20 ▲ 11-18 ▲ 11-18 ▲
DRC237 CT013SP ▲	HONDA TRX 500 FE5/FE6/FE7/FE8 Fourtrax Foreman 4x4/ES TRX 500 FM Fourtrax Foreman 4x4 TRX 500 FPM Fourtrax Foreman 4x4/EPS TRX 500 TM Fourtrax Foreman 2x4	05-08 ▲ 05-11 ▲ 08-11 ▲ 05-06 ▲	DRC261 DRCF261 CT001 ▲	HONDA CRF 250 R CRF 250 RX	11-19 ▲ 18-21 ▲
DRC238 CT013SP ▲ CT013 ■	HONDA TRX 420 TE Fourtrax Rancher ES TRX 420 FP/FPA Fourtrax Rancher 4x4 ES/EPS TRX 420 FE/FEA Fourtrax Rancher 4x4/ES HONDA TRX 420 FE1 Rancher 4x4 ES TRX 420 TE1 Rancher ES TRX 420 FM1 Rancher 4x4 TRX 420 FM1 Rancher 4x4 EPS TRX 420 TM Fourtrax Rancher	07-13 ▲ 09-13 ▲ 07-13 ▲ 14-15 ■ 14-15 ■ 14-15 ■ 14-15 ■ 07-13 ▲	DRC262 DRCF262 CT001 ▲	HONDA CR 125 R	00-03 ▲
DRC239 CT013SP ▲ CT013 ■	HONDA TRX 420 FM Fourtrax Rancher 4x4 TRX 420 FPM/FPMA Fourtrax 4WD TRX 420 TM1 Rancher	07-11 ▲ 09-11 ▲ 14-15 ■	DRC263 CT020 ▲	YAMAHA WR 450 FS	04 ▲
DRC240 DRCF240 CT009 ▲	HONDA TRX 700 XX	08-11 ▲	DRC264 CT001 ▲	HUSQVARNA CR 125 WR 125 WRE 125 SMS 125 YAMAHA YZ 400 FK/FL	00-11 ▲ 00-11 ▲ 00-11 ▲ 00-11 ▲ 98-99 ▲
DRC241 DRCF241 CT057SP ▲	KTM SX 65 XC 65	09-19 ▲ 09-10 ▲	DRC265 CT008 ▲	KAWASAKI KX 450 F (4T)	12-19 ▲
			DRC269 DRCF269 CT013SP ▲	HONDA TRX 500 FE Fourtrax Foreman TRX 500 FPE Fourtrax Foreman	12-13 ▲ 12-13 ▲
			DRC270 CT013SP ▲	HONDA TRX 500 FM Fourtrax Foreman TRX 500 FPM Fourtrax Foreman	12-13 ▲ 12-13 ▲
			DRC271 CT013SP ▲	HONDA TRX 500 FM Fourtrax Foreman TRX 500 FPM Fourtrax Foreman	12-13 ▲ 12-13 ▲
			DRC273 CT023 ▲	KTM EXC-F 350 Inc 6 Days (Diaphragmspring) 350 Freeride EXC 450 Inc 6 Days SX-F 450	12-20 ▲ 12-15 ▲ 12 ▲ 12 ▲

DRC CLUTCH KIT BUYERS GUIDE

Part no.	Make/Model	Year	Part no.	Make/Model	Year
DRC273 CT023 ▲ Contd.	KTM Contd.		DRC292 CT023 ▲ Contd.	KTM Contd.	
	XC-W 450	12 ▲		XC-F 250	16 ▲
	EXC 500	12-14 ▲		SX-F 350	16 ▲
	XC-W 500	12 ▲		XC-F 350	16 ▲
	EXC-F 350	12-15 ▲	DRC293 CT023 ▲	KTM	
XC-F-W 350 Diaphragm spring	11-18 ▲	SX 250 (2T) Diaphragmspring		13-21 ▲	
350 Freeride	12 ▲	HUSQVARNA			
	HUSQVARNA		FC 250	14-17 ▲	
DRC274 CT011 ▲	SUZUKI		DRC295 CT005 ▲	YAMAHA	
	DR 200s	96-09 /13/15-19		XT 250 X/Y/Z/A/B/D/E/F/G/H	08-17 ▲
DRC275 CT023 ▲	KTM		DRC296 CT023 ▲	HUSQVARNA	
	EXC 250 (2T) Inc 6 Days	13-18 ▲		FC 450	14-17 ▲
	EXC-F 250 Inc 6 Days	14-18 ▲	DRC297 CT011 ▲	HONDA	
	EXC 300 (2T) Inc 6 Days Diaphragm spring	13-21 ▲		LT-F 250 K Ozark From frame JSAAJ51A221006	02 ▲
	XC-W 300 Diaphragm spring	13-21 ▲		DRC298 DRCF298 CT020 ▲	YAMAHA
	EXC-F 450 Inc 6 Days Diaphragm spring	13-18 ▲	WR 450 FG/FH		16-21 ▲
	SX-F 450 Diaphragm spring	2016-17 ▲	DRC299 DRCF299 CT092 ▲	HONDA	
	SX-F FACTORY 450	2016 ▲		CRF 450 R	17-21 ▲
	XC-F 450 Diaphragm spring	2016-17 ▲		CRF 450 RX (18" Rear wheel)	17-21 ▲
	XC-W 450	2016 ▲	DRC300 CT091 ■	CRF 450 X (18" Rear wheel)	18-21 ▲
	EXC-F 450 6 DAYS	2017 ▲		CRF 450 L	18-21 ▲
	EXC 500, inc 6 Days Diaphragm spring	2016 ▲		AJP	
	XC-W 500 Diaphragm spring	2016 ▲		250 - PR5 Trail	13-17 ■
HUSQVARNA		250 - PR5supermoto	13-17 ■		
FE 350	14-18 ▲	250 - PR5 Enduro	13-17 ■		
FE 450	14-18 ▲	250 - PR5 EX Extreme	13-17 ■		
FE 501	14-18 ▲	DRC301 DRCF301 CT009 ▲	HONDA		
FE 501s	16 ▲		CRF 450 R	14-16 ▲	
DRC276 DRCF276 CT009 ▲	HONDA		DRC303 DRCF303 CT001 ▲	HUSQVARNA	
	CRF 450 R (6spring type)	13 ▲		TC 125	14-18 ▲
DRC277 DRCF277 CT081SP ▲	HONDA			TE 125	14-16 ▲
	CRF 250 L (Non ABS)	13-21 ▲	TX 125	17-18 ▲	
	CRF 250 LA (ABS)	17-21 ▲	DRC304 DRCF304 CT087SP ■	HUSQVARNA	
	CRF 250 Rally (ABS/Non ABS)	17-21 ▲		TC 85 (F 17"/R 14")	18-21 ■
CRF 300nA	18-21 ▲	TC 85 (F 19"/R 16")	18-21 ■		
DRC280 DRCF280 CT013 ▲	SUZUKI		DRC306 DRCF306 CT009 ▲	HONDA	
	DR-Z 250 K1-K7	01-07 ▲		CRF 1000 LAG (Manual Clutch/ABS)	16 ▲
DRC281 CT023 ▲	KTM		CRF 1000 L (Manual clutch/ABS)	16-20 ▲	
	SX-F 450 (4T)	14-21 ▲	DRC313 DRCF313 CT005 ▲	YAMAHA	
	XC-F 450	14-15 ▲		YZ 250 F 4T	16-21 ▲
	XC-W 500	16 ▲		DRC315 DRCF315 CT004 ▲	YAMAHA
	HUSQVARNA		YZ 250 F		19-21 ▲
FR 450 Rally	17-21 ▲	DRC320	KTM		
FS 450	15-18 ▲		790 Duke	17-20	
FX 450	17-18 ▲		790 Adventure	17-20	
			890 Duke	2021	
DRC284	YAMAHA		890 Adventure	2021	
	T Max 530 ABS	12-19	DRC322	YAMAHA	
T Max 530 DX ABS	17-19	YFZ 450 R		14-21	
	T Max 530sX ABS	17-19	DRC333	BETA	
	T Max 530 Black Max ABS	13		Enduro 400 RR	10-15
	T Max 530 Bronze Max ABS	14	Enduro 450 RR	10-15	
	T Max 530 Iron Max ABS	15	DRC335	HONDA	
DRC287 DRCF287 CT005 ▲	YAMAHA			CRF 250 F	19-21
	YZ 450 FE/FF/FG/FGY (4T)	14-21 ▲			
DRC288 DRCF288 CT020 ▲	YAMAHA				
	YZ 250 FE/FF/FG/FGY (4T)	14-21 ▲			
DRC292 CT023 ▲	KTM				
	SX-F 250	16 ▲			
	SX-F 250 Factory Edition	15 ▲			

SRC/SRK CLUTCH KIT BUYERS GUIDE

Part no.	Make/Model	Year	Part no.	Make/Model	Year
SRC2 SRK2 CT031 ▲	HONDA VF 700 F Interceptor VF 750 F V45 Interceptor	84-85 ▲ 83-84 ▲	SRC17 SRK17 CT036SP ▲	SUZUKI GSX 600 FN/FP/FR/FS/FT/FV Katana GSX R 600 WN/WP GSX-R 750 L/M/N GSX-R 750 WP/WR/WS	92-97 ▲ 92-93 ▲ 90-92 ▲ 92-95 ▲
SRC3 SRK3 CT014 ▲	HONDA VFR 700 F/F2 Interceptor VF 750 C Magna/CD Magna Deluxe VFR 750 F Interceptor 750 VFR 750 F	86-87 ▲ 94-03 ▲ 86 ▲ 90-97 ▲	SRC19 SRK19 CT014 ▲ CT014SP ●	HONDA 599 (CB 600 F) CBR 600 F2/F3/SJR/SE CBR 929 RR (929cc model) CBR 954 RR	04/06 ● 91-98 ● 00-01 ▲ 02-03 ▲
SRC4 SRK4 CT009 ▲	HONDA CB 1000 CBF 1000 F CBR 1000 F Hurricane	94-95 ▲ 90-96 ▲ 87-88 ▲	SRC20 SRK20 CT016 ▲	KAWASAKI ZL 900 A1/A2 Eliminator KZ 1000 E1/E2shaft ZG 1000 A1-A20 Concours ZG 1000 A6F Concours ZL 1000 A1 ZX 1000 A1/A2ninja ZX 1000 B1/B2/B3ninja ZX10 KZ 1100 B1/B2 (GPz) KZ 1100 A1/A2/A3 KZ 1100 D1/D2spectre KZ 1100 L1 (LTD) ZX 1100 A1/A2 (GPz) ZR 1100 A1/A2/A3/A4 Zephyr (ZR 1100 C3/C4) ZRX 1100 ZN 1100 B1/B2 (LTD) ZG 1200 A1/B1-B4 Voyager X11 ZG 1200 B5-B17 Voyager X11	85-86 ▲ 79-80 ▲ 86-05 ▲ 06 87 ▲ 86-87 ▲ 88-90 ▲ 81-82 ▲ 81-83 ▲ 82-83 ▲ 83 83-84 ▲ 92-95 ▲ 99-00 ▲ 84-85 ▲ 86-90 ▲ 91-03 ▲
SRC5 SRK5 CT014 ▲	HONDA VFR 750 R (RC 30)	90 ▲	SRC22 SRK22 CT016 ▲	KAWASAKI ER-6N (ER 650 C9F/CAF) ZX 600 D1/D2/D3/D4 (ZX6) ER-6F (EX 650) ER-6F ABS (EX 650 ABS) ER-6N (ER 650) ER-6N ABS (ER 650 ABS) KLE 650 A7F/A8F/A9F/CAF/CBF /CCF/CDF/DEF Versys	09-10 ▲ 90-93 ▲ 06-11 ▲ 06-11 ▲ 06-11 ▲ 06-11 ▲ 06-11 ▲ 07-14 ▲
SRC6 SRK6 CT010 ▲	YAMAHA FZR 400 U/W/SUC/SWC/A/SAC	88-90 ▲	SRC24 SRK24 CT016 ▲	KAWASAKI KZ 750 K1/K2 (LTD) ZX 750 J1/J2/K1/K2 ZX 750 L1/L2/L3 (ZX-7) ZX 750 M1/M2 (ZX-7R) ZX 750 P1-P8 (ZX 7 R)	83-84 ▲ 91-92 ▲ 93-95 ▲ 93-94 ▲ 96-03 ▲
SRC7 SRK7 CT010 ▲	YAMAHA FZR 600 W/WC/RA/AC/RAC/RB/RBC/RD /RDC/RE/REC/RF/RFC/RG/RGC/H/RHC/RJ /RJC/RK/RKC/RL/RLC	89-99 ▲	SRC25 SRK25 CT021 ▲	KAWASAKI ZX 1100 C1-C4/D1-D9 (ZX11) ZX 1100 E1/E2/E3/F1 GPZ 1100 ZZR 1200 (ZX 1200 C1-C4)	90-01 ▲ 95-97 ▲ 02-05 ▲
SRC8 SRK8 CT008SP ■	YAMAHA FZR 750 RT/RU FZR 1000 T/TC/U/UC Genesis	87-88 ■ 87-88 ■	SRC29 SRK29 CT008SP ■	YAMAHA FZR 1000 E/EC/F/FC/G/GC YZF 1000 R (RJ)	93-95 ■ 97 ■
SRC9 SRK9 CT008SP ■	YAMAHA FZR 750 OW/OI YZF 750sP/RF/RFC/RG/RGC/RH/RHC	89-91 ■ 94-96 ■	SRC31 SRK31 CT008SP ■	YAMAHA FZR 1000 W/WC/A/AC/B/BC/D/DC	89-92 ■
SRC10 SRK10 CT055SP ▲	SUZUKI GSX 1100 GM/GN/GP GSXR 1100 K/L/M/N	91-93 ▲ 89-92 ▲	SRC33 SRK33 CT054SP ▲	YAMAHA YZF 600	95-07 ▲
SRC11 SRK11 CT016 ▲	KAWASAKI EN 450 A1-A6 (454 LTD) EN 500 A1-A7/C1-C10/C6F/C7F/C8F/C9F EX 500 A1-A7/D1-D12/D6F/D7F/D8F/D9F KZ 550 A1/A2/A3/A4 KZ 550 C1/C2/C3/C4 (LTD) KZ 550 D1 (GPz) KZ 550 F1spectre KZ 550 F2 (LTD) KZ 550 H1/H2 (GPz) KZ 550 M1 (LTD) ZX 550 A1/A2/A3 (GPz) ZR 550 B1/B2/B3/B4 Zephyr KAWASAKI ZX 600 A1/A2/A3/B1ninja ZX 600 C1-C10ninja R ZL 600 A1/A2 ZL 600 B1/B2	85-90 ▲ 90-09 ▲ 87-09 ▲ 80-83 ▲ 80-83 ▲ 81 ▲ 83 84 ▲ 82-83 ▲ 83 ▲ 84-86 ▲ 90-93 ▲ 85-87 ▲ 88-97 ▲ 86-87 ▲ 96-97 ▲	SRC38 SRK38 CT004 ▲	KAWASAKI ZX 6R (ZX 600 F1/F2/F3/G1/G2) ZX 6R (ZX 600 J1/J2/J3) ZZR 600 (ZX 600 J4) ZZR 600 J6F/J7F/J8F ZX 6R (ZX 636 A1) ZX6R (ZX 636 B1/B2) 636cc Z 750s (ZR 750 K1/K6F)	95-99 ▲ 00-02 ▲ 05 ▲ 06-08 ▲ 02 ▲ 03-04 ▲ 05-06 ▲
SRC13 SRK13 CT029 ▲	SUZUKI GSX 600 FJ/FK/FL/FM Katana GSX-R 750 G/H	88-91 ▲ 86-87 ▲	SRC39 SRK39 CT055SP ▲	SUZUKI RF 900 RR GSXR 1100 WR/WP/WS/WT/WV/WW	94 ▲ 93-98 ▲
SRC14 SRK14 CT036SP ▲	SUZUKI GSX-R 750 J/K	88-89 ▲			
SRC15 SRK15 CT048SP ▲	SUZUKI GSXR 1100 G/H/J	86-88 ▲			
SRC16 SRK16 CT009SP ■	HONDA CBR 600 F Hurricane CBR 600 F1	87 ■ 88-89 ■			

SRC/SRK CLUTCH KIT BUYERS GUIDE

Part no.	Make/Model	Year	Part no.	Make/Model	Year
SRC40 SRK40 CT055SP ▲	SUZUKI GSX-R 750 T/V/W/X GSF 1200sV/SAV/SW/SX/SY/SK1-SK5	96-99 ▲ 97-05 ▲	SRC58 SRK58 CT055SP ▲	SUZUKI GSX R 600 V/W/X/Y	97-00 ▲
SRC41 SRK41 CT016 ▲	KAWASAKI ZX 750n1/N2 (ZX 7 RR) ZX-9R B1/B2/B3/B4ninja	96-99 ▲ 94-97 ▲	SRC59 SRK59 CT004 ▲	KAWASAKI ZX 9R (ZX 900 C1/C2)	98-99 ▲
SRC42 SRK42 CT009SP ■	HONDA CBR 600 F1	90 ■	SRC60 SRK60 CT009 ▲	HONDA VTR 1000 Fsuperhawk	98-05 ▲
SRC43 SRK43 CT016 ▲	KAWASAKI ZX 600 E1-E13 (ZX6)	93-05 ▲	SRC62 SRK62 CT013SP ■ CT013 ▲	HONDA CTX 700n (Naked/Manual G/box) CTX 700 (Top Fairing/Manual G/box) NC 700 X (2 Piston Caliper) NT 700 V/VA NC 750s/X NC 750s/X (ABS)	14 ▲ 14 ■ 12-14 ■ 10-13 ■ 14-15 ■ 14-18 ■
SRC45 SRK45 CT036SP ▲	SUZUKI RF 600 RR/RS/RT	94-96 ▲	SRC64 SRK64 CT013SP ■ CT013 ▲	HONDA NT 650 Hawk GT XRV 650 J/K Africa Twin	88-90 ▲ 88-89 ■
SRC46 SRK46 CT016 ▲	KAWASAKI W 650 (EJ650A1/A2/A3/A4) VN 800 A1-A11/B1-B10 VN 700 A1 Vulcan KZ 750 G1 (LTD) KZ 750 M1 (CSR) VN 750 A2-A21/A6F Vulcan	00-02 ▲ 95-05 ▲ 85 ▲ 80 ▲ 82 ▲ 86-06 ▲	SRC65 SRK65 CT017 ▲	YAMAHA YZF 1000 R1	99-03 ▲
SRC50 SRK50 CT024SP ▲	SUZUKI GS 1000sZ GS 1000 GT/GX GS 1000 GLT/GLX/SZ GS 1100 ET/EX/EZ GS 1100 GZ/GD GS 1100 GLZ/GLD GS 1100 GKZ/GK2/GKD/GKE GS 1100 LT GS 1150 ES3/ESE/EFESF/EF2/EG/ESG	82 ▲ 80-81 ▲ 80-82 ▲ 80-82 ▲ 82-83 ▲ 82-83 ▲ 82-84 ▲ 80 ▲ 83-86 ▲	SRC66 SRK66 CT014 ★	HONDA CBR 600 F4 (Carb Model)	99-00 ★
SRC51 SRK51 CT008SP ■	YAMAHA FZ6 (All models) YZF 600 RL/RRL/RM/RMC/RN/RNC/P/PC R6 FZX 700s/SC/T/TC FZ 750n FZ 750s/SC TDM 850 D/DC/E/EC	04-09 ■ 99-02 ■ 86-87 ■ 85 ■ 86 ■ 92-93 ■	SRC67 SRK67 CT021 ▲	SUZUKI GSX 1300 RX Hayabusa	99 ▲
SRC53 SRK53 CT016 ▲	KAWASAKI ZX 750 F1/F2/F3/F4ninja VN 800 Drifter C1/C2/E1-E5/E6F VN 900 Vulcan Classic LT (D6F/D7F/D8F/D9F /DAF/DBF/DCF/DDF/DEF/DFE) VN 900 B6F/B7F/B8F/B9F/BAF/BBF/BCF/BDFA /BEF/BEFA/BFF Vulcan Classic VN 900 C7F/C8F/C9F/CAF/CBF/CCF/CDFA /CEFA/CFE ZX 900 A1/A2/A3ninja	87-90 ▲ 99-06 ▲ 06-19 ▲ 06-19 ▲ 07-19 ▲ 84-86 ▲	SRC68 SRK68 CT009 ▲	SUZUKI TL 1000 RW/RX/RY TL 1000sX/SY	98-00 ▲ 99-00 ▲
SRC54 SRK54 CT016 ▲	KAWASAKI KZ 1000 J1/J2/J3 KZ 1000 K1/K2 (LTD) KZ 1000 M1/M2 (CSR) KZ 1000 P1-P22/P24 Police KZ 1000 R1/R2 Replica	81-83 ▲ 81-82 ▲ 81-82 ▲ 82-03/05 ▲ 82-83 ▲	SRC70 SRK70 CT056SP ■	HONDA ST 1100/1100 A	91-01 ■
SRC55 SRK55 CT014 ▲	HONDA CBR 900 RR	96-97 ▲	SRC71 SRK71 CT014 ▲	SUZUKI GSXR 750 Y	00- ▲
SRC56 SRK56 CT017 ▲	YAMAHA YZF 1000 R1	98 ▲	SRC72 SRK72 CT008 ▲	YAMAHA SRX 600s/SC	86 ▲
SRC57 SRK57 CT014 ▲	HONDA CBR 900 RR 919 (CB 900 F)	98-99 ▲ 02-07 ▲	SRC74 SRK74 CT008SP ■	YAMAHA YZF-R6 RRR/RRS/T/TC YZF-R6S (SV/SW/SX/SY)	03-05 ■ 06-09 ■
			SRC75 SRK75 CT014 ▲	HONDA CBR 600 RR CBR 600 RA	03-20 ▲ 09-20 ▲
			SRC76 SRK76 CT004 ▲	KAWASAKI ZX6RR (ZX 600 K1) 599cc	03 ▲
			SRC77 SRK77 CT020 ▲	YAMAHA (FZ1) FZS 1000 V/W/X/Y/Z/A/B/D/E YZF R1 (5VY)	06-14 ▲ 04-06 ▲
			SRC78 SRK78 CT014 ▲	SUZUKI GSXR 600 K4/K5	04-05 ▲
			SRC79 SRK79 CT004 ▲	KAWASAKI ZX-10R (ZX 1000 C1/C2/D6F/D7F) ZX10R (ZX 1000 E8F/E9F/FAF/JBF/KBF/JCF /KCF/KDF/JDF/JEF/KEF/JJF/KFF) ZX10 RR ZX10 RR Performance	04-07 ▲ 08-15 ▲ 17-21 ▲ 17-21 ▲

SRC/SRK CLUTCH KIT BUYERS GUIDE

Part no.	Make/Model	Year	Part no.	Make/Model	Year
SRC80 SRK80 CT009SP ■	HONDA CBR 1000 RR	04-07 ■	SRC98 SRK98 CT021 ▲	KTM 1190 RC8 (6spring type clutch) 1190 RC8 R (6spring type clutch)	09-12 ▲ 08-12 ▲
SRC81 SRK81 CT022 ▲	SUZUKI SV 650 X/Y/K1/SK1/SK2/K2	99-02 ▲	SRC101 SRK101 CT004 ▲	KAWASAKI ZX 6R (ZX 600 P7F/P8F/P9F/R9F/RAF/RBF/RCF)	07-12 ▲
SRC82 SRK82 CT033SP ▲	SUZUKI SFV 650 K9/L3/L4/L5 SV 650 K3/SK3/K4/SK4/K5/SK5/K6/SK6/K7 /SK7/SK8/K8/SK9/SLO SV 650 AK7/AK8 SV 650 AL (ABS) SV 650sAK7/SAK8/SK9/SALO ABS DL 650 AK/AL V-Strom (ABS Model) DL 650 XT V-Strom ABS (DL 650 XAL5/XAL6) DL 650 AAL V-Strom (ABS Adventure)	09-10/13-15 ▲ 03-10 ▲ 07-08 ▲ 16-21 ▲ 07-10 ▲ 04-21 ▲ 12-21 ▲ 15-21 ▲	SRC103 SRK103 CT009 ▲	HONDA VFR 1200	10-14 ▲
SRC83 SRK83 CT004 ▲	KAWASAKI ZX6RR (ZX 600 M1)	04 ▲	SRC110 SRK110 CT015 ▲	SUZUKI GSXR 600 GSXR 750	08-21 ▲ 11-21 ▲
SRC84 SRK84 CT004 ▲	KAWASAKI ZX6R (ZX 636 C1/C6F 636cc)	05-06 ▲	SRC111 SRK111 CT014 ▲	SUZUKI GSXR 750 K1/K2/K3	01-03 ▲
SRC85 SRK85 CT015 ▲	SUZUKI GSXR 1000 K5/K6/K7/K8 GSX-S 1000 (Naked) GSX-S 1000 ABS (Naked) GSX-S 1000 F (Faired) GSX-S 1000 F ABS (Faired) Katana	05-08 ▲ 18-21 ▲ 18-21 ▲ 18-21 ▲ 18-21 ▲ 19-21 ▲	SRC112 SRK112 CT014 ▲	SUZUKI GSXR6 600 K1/K2/K3/ZK3	01-03 ▲
SRC86 SRK86 CT015 ▲	SUZUKI GSXR 600 K6/K7	06-07 ▲	SRC113 SRK113 CT014 ▲	APRILIA RSV4R RSV4 Factory RSV4 Factory APRC RSV4 R APRC	10-12 ▲ 09-14 ▲ 11-14 ▲ 11-14 ▲
SRC87 SRK87 CT008SP ■	YAMAHA YZF-R6	06-17 ■	SRC115 SRK115 CT035SP ▲	SUZUKI GS 1000 C/N/EC/EN/SN/ET/ST	78-80 ▲
SRC88 SRK88 CT015 ▲	SUZUKI GSXR 600 K8/K9/L0 GSXR 750 K6/K7	08-10 ▲ 06-07 ▲	SRC118 SRK118 CT009 ▲	KAWASAKI EX 300 ADF/BDFA/ADFA/AEF/AEFA/AES /AESA/BDF/BEF/BEFA (Ninja) EX 300 BDFA/BDF/BEF/BEFAninja Verysy-X 300 ABS	13-19 ▲ 13-19 ▲ 17-21 ▲
SRC89 SRK89 CT004 ▲	SUZUKI GSXR 1000 K1/K2/K3/K4/ZK4 KAWASAKI ZX9R (ZX 900 E1/E2/F1/F2) Z 1000 (ZR 1000 A1/A2/A3) Z 1000 (ZR 1000 A6F)	01-04 ▲ 01-03 ▲ 03-05 ▲ 06 ▲	SRC119 SRK119 CT012SP ▲	HONDA CBR 125 RW7/RW8/RW9/RWA/RWB/RC/RD (No judderspring)	07-13 ▲
SRC90	HONDA CRF 50 F	04-21	SRC120 SRK120 CT009 ▲	SUZUKI GSX-R 1000 L2/L3/ZL3/L4/L5/L6	12-16 ▲
SRC93 SRK93 CT020 ▲	YAMAHA YZF R1 LE YZF-R1 (6 piston caliper)	06 ▲ 07-08 ▲	SRC121 SRK121 CT014 ▲	SUZUKI GSX-R 750 K4/K5	04-05 ▲
SRC94 SRK94 CT014 ▲	HONDA CBR 900 RR	93-95 ▲	SRC122 SRK122 CT084SP ▲	HONDA MSX 125 D/E/F/G/H Grom (Non ABS) MSX 125 AH Grom (ABS) Monkey 125	14-21 ▲ 18-21 ▲ 19-21 ▲
SRC95 SRK95 CT043SP ▲	HONDA CBR 1000 RR/RAA CBR 1000 RA/RAA	08-16 ▲ 09-16 ▲	SRC124 SRK124 CT020 ▲	YAMAHA MT-09 Tracer ABS MT-09A 2DR/ABS MT-09Asport Tracker ABS MT-09Astreet Rally ABS	15-21 ▲ 14-21 ▲ 14-21 ▲ 14-21 ▲
SRC96 SRK96 CT020 ▲	YAMAHA YZF-R1 (6 piston caliper)	09-14s ▲	SRC125 SRK125	YAMAHA MT-07 MT-07A ABS	14-21 14-21
SRC97 SRK97 CT009 ▲	SUZUKI GSXR 1000 K9/L1	09-11s ▲	SRC128 SRK128 CT080 ▲	YAMAHA YZ-F R3 (321cc) MT-03	15-21 ▲ 12-21 ▲
			SRC129 SRK129 CT079SP ●	YAMAHA FZ-10 YZF-R1 YZF-R1M YZF-R1S	17 ● 15-21 ● 15-21 ● 16 ●

SRC/SRK CLUTCH KIT BUYERS GUIDE

Part no.	Make/Model	Year	Part no.	Make/Model	Year
SRC130 SRK130 CT085 ▲	BMW		SRC148 SRK148 CT011 ▲	SUZUKI	
	F650 GS (Late type plates 2 x 13mm 7 x 14mm ears)	07-17 ▲		GSX-R 125	18-21 ▲
	F700 GS (Late type plates 2 x 13mm 7 x 14mm ears)	11-17 ▲		GSX-S 125	18-21 ▲
	F800 GS (Late type plates 2 x 13mm 7 x 14mm ears)	12-17 ▲		GSX 150 L6/DZAL6 Gixxer	16 ▲
	F800 GS Adventure (Late type plates 2 x 13mm 7 x 14mm ears)	12-17 ▲		GSX-R 150 RF-Q/RFX-Q	17-18 ▲
	F800 GT (Late type plates 2 x 13mm 7 x 14mm ears)	07-17 ▲		GSX-R 150 RFL8/RFXL8	18-21 ▲
	F800s (Late type plates 2 x 13mm 7 x 14mm ears)	07-17 ▲		GSX-S 150 MFL8/MFXL8	18-21 ▲
	F800sT (Late type plates 2 x 13mm 7 x 14mm ears)	07-17 ▲			
	F800 R (Late type plates 2 x 13mm 7 x 14mm ears)	05-17 ▲			
SRC131 SRK131 CT017 ▲	YAMAHA		SRC149 SRK149 CT014 ▲	HONDA	
	XT 1200 Zsuper Tenere	12-13 ▲		CB 650 FE/FG (Non ABS)	14-16 ▲
	FJR 1300 R/RC/S/AS/T/AT	03-05 ▲		CB 650 FAE/FAF/FAG/FAH/FAJ (ABS)	14-18 ▲
	FJR 1300 A	06-15 ▲		CBR 650 F (Non ABS)	14-21 ▲
	XVS 1300 V-Star/V-Star Tourer	07-14 ▲		CBR 650 FA (ABS)	14-21 ▲
	XVS 1300 V-Star De Luxe	13-14 ▲			
XVS 1300stryker	11-14 ▲				
SRC139 SRK139	KTM		SRC151 SRK151 CT083 ▲	BMW	
	390 Duke	13-14		G 310 GS	17-21 ▲
	RC 390	14-15		G 310 R	17-21 ▲
SRC140 SRK140	KTM		SRC155 SRK155 CT009 ▲	KAWASAKI	
	390 Duke	15-17		Ninja 650 (EX 650)	12-18 ▲
	RC 390	16-17		Ninja 650 ABS (EX 650 ABS)	12-18 ▲
SRC141 SRK141 CT014SP ▲	BENELLI		SRC160 SRK160 CT008SP ▲	YAMAHA	
	TNT 600 i Tornado	16-17 ▲		YZF-R6	18-21 ▲
SRC142 SRK142 CT009 ▲	SUZUKI		SRC161 SRK161	HONDA	
	GSX-R 1000 AL7 ABS (3spring clutch)	17 ▲		CB 1100 EX	16-19
SRC143 SRK143 CT014 ▲	SUZUKI		SRC162 SRK162	YAMAHA	
	CBR 600 F4isport Injection Model)	01-06 ▲		XSR 900 ABS (MTM850)	16-21
SRC144 SRK144 CT085 ▲	BMW		SRC163 SRK163	KAWASAKI	
	F800 GS (Early type plates 14mm ears)	08-11 ▲		Ninja H2	15-21
	F800 GT (Early type plates 14mm ears)	04-06 ▲			
	F800s/ST (Early type plates 14mm ears)	04-06 ▲			
SRC145 SRK145 CT083 ▲	BMW		SRC164 SRK164	KAWASAKI	
	G 650 GS (R13)	08-16 ▲		Ninja H2R	15-21
	G 650 GSsertao (R13)	10-14 ▲			
	G 650 X Country (K15)	08-10 ▲	SRC165 SRK165	BMW	
SRC146 SRK146 CT086SP ▲	TRIUMPH			R 1200 GS	13-18
	Bonneville T120 (1200cc Liquid Cooled)	16-21 ▲		R 1200 GS Adventure	13-18
	Bonneville T120 Black (1200cc Liquid Cooled)	16-21 ▲		R 1200 R	13-18
	Bonneville Bobber (1200cc Liquid Cooled)	17-21 ▲		R 1200 RS	14-18
	Bonneville Bobber Black (1200cc Liquid Cooled)	18-21 ▲		R 1250 GS	19-21
	Thruxton 1200 (Liquid Cooled)	16-21 ▲		R 1250 GS TE	19-21
Thruxton R 1200 (Liquid Cooled)	16-21 ▲	R 1250 GS Rallye		19-23	
SRC147 SRK147 CT086SP ▲	TRIUMPH			R 1250 GS Rallye TE	19-23
	Bonneville T100			R 1250 GS Adventure	19-23
	(900cc/Liquid Cooled/Spoke Wheel)	16-21 ▲	R 1250 GS Adventure TE	19-23	
	Bonneville T100 Black		R 1250 GS Adventure Rallye	19-23	
	(900cc/Liquid Cooled/Spoke Wheel)	16-21 ▲	R 1250 GS Adventure Rallye TE	19-21	
	Street Cup (900cc Liquid Cooled)	16-20 ▲			
	Streetscrambler (900cc Liquid Cooled)	16-20 ▲			
	Street Twin (900cc Liquid Cooled)	16-21 ▲			
SRC166 SRK166			TRIUMPH		
			Tiger 800	11-12	
			Tiger 800 XC	11-12	
			Tiger 800 XR	2018-	
	SRC167 SRK167			KAWASAKI	
				Ninja 400	17-21
				Z 400	17-21
	SRC168 SRK168			KTM	
				1050 Adventure	15-16
				1090 Adventure Inc R model	17-19
			1090 Adventure L and S models	19	
			1190 Adventure	13-16	
			1190 Adventure R	13-16	
			1190 RC8 R (3spring Type Clutch)	13-15	
			KTM		
			1290super Adventure	15-16	
			1290super Adventure R&S models	17-21	

SRC/SRK CLUTCH KIT BUYERS GUIDE

Part no.	Make/Model	Year	Part no.	Make/Model	Year
SRC169 SRK169	SUZUKI GSX-S 750	15-21	SRC7008 Contd.	FXFBS 1YLK Fat Bob 114	18 ▲
SRC7001 SRK7001	INDIAN Octane Scout Scoutsixty	17 15-16 16-17	SRC7009 SRK7009 CT703SP ▲	HARLEY DAVIDSON® FLHP 1FHM Road King Police FLHPE 1FTM Road King Police FLHTCUTG 1MAM Tri Glide Ultra Classic FLHTCUTG ANV 1MAM_ANV Tri Glide Ultra Classic Anv FLHTP 1FMM Electra Glidestandard Police FLHXXX 1MBMstreet Glide Trike FXDLS 1GS8 Dyna Low Riders	11-16 ▲ 11 ▲ 09-13 ▲ 13 ▲ 11-16 ▲ 10-11 ▲ 16-21 ▲
SRC7002 SRK7002	INDIAN Scout Scout 1200 Scout Bobber Scoutsixty	17-21 17-21 18 17-21	SRC7010 SRK7010 CT702SP ▲	HARLEY DAVIDSON® FLHR 1FBC Road King FLHRC 1FRC Road King Classic FLHRXS 1KVC Road Kingspecial FLHTCU 1FCC Electra Glide Ultra Classic FLHTK 1KED Ultra Limited FLHTK 1KND Ultra Limitedshrine Edition FLHTK 1KWD Ultra Limited Anniversary FLHTKL 1KKD Ultra Limited Low FLHX 1KBCstreet Glide FLHX 1KXCstreet Glide Anniversary FLHXS 1KRCstreet Glidespecial FLHXS 1KYCstreet Glidespecial Anniversary FLTRU 1KGD Road Glide Ultra FLTRX 1KHC Road Glide FLTRXS 1KTC Road Glidespecial	17 17 ▲ 18 17-21 17-21 ▲ 18 18 17-18 ▲ 17-21 17-21 ▲ 18 ▲ 17-18 18 17-18 17-21 ▲ 17-21 ▲ 17-21 ▲
SRC7003 SRK7003 CT702SP ▲	HARLEY DAVIDSON® FLHTCUL 1KDM Ultra Classic Low FLHTCUL TC 1KFL Ultra Classic Low Twin-Cooled FLHTCUTG 1MAL Tri Glide Ultra Classic FLHTK 103 1TEL CVO Limited	15-21 ▲ 15-21 ▲ 14-16 ▲ 14 ▲	SRC7011 SRK7011 CT703SP ▲	HARLEY DAVIDSON® FLHR 1FBM Road King FLHR 1FDL Road King FLHRC 1FRM Road King Classic FLHRCI 1FRR Road King Classic FLHRCI 1FRW Road King Classic FLHRI 1FBW Road King FLHT 1DDV Electra Glidestandard FLHT 1DDL Electra Glidestandard FLHTC 1DJL Electra Glide Classic FLHTC 1DJV Electra Glide Classic FLHTCI 1FFR Electra Glide Classic FLHTCU 1FFW Electra Glide Classic FLHTCU 1FCM Ultra Classic FLHTCU TC 1KSL Ultra Classic Twin-Cooled FLHTCUI 1FCR Ultra Classic FLHTI 1FWW Electra Glidestandard FLHTK 1KEL Ultra Limited FLHX 1KBMstreet Glide FLHXS 1KRMstreet Glidespecial FLSTC 1BJL Heritagesoftail Classic FLSTC 1BJY Heritagesoftail Classic FLSTCI 1BWB Heritagesoftail Classic FLSTF 1BML Fat Boy FLSTF 1BMY Fat Boy FLSTFI 1BXB Fat Boy FLSTS 1BRL Heritagespringer FLSTSI 1BYB Heritagespringer FLTR 1FPL Road Glide FLTR 1FPV Road Glide FLTRI 1FSR Road Glide FLTRI 1FSW Road Glide FLTRU 1KGL Road Glide Ultra FLTRX 1KHM Road Glide FLTRXS 1KTM Road Glidespecial FLTRXS 1KTM Road Glidespecial FXD 1GHL Dynasuper Glide FXD 1GHV Dynasuper Glide FXDL 1GDL Dyna Low Rider FXDS-CONV GGXX Dyna Glide Convertible FXDS-CONV GGVY Dyna Glide Convertible FXDWG 1GEL Dyna Wide Glide FXDWG 1GEV Dyna Wide Glide FXDX 1GJV Dynasuper Glidesport FXDXT 1GLV Dynasuper Glide T-Sport FXST 1BHLsoftailstandard FXST 1BHYSOFTAILSTANDARD FXSTB 1BTLnight Train FXSTB 1BTYnight Train	15-21 ▲ 98-03 ▲ 14-21 ▲ 98 ▲ 99-03 ▲ 00-03 ▲ 03 ▲ 98-02 ▲ 98 ▲ 99-03 ▲ 98-03 ▲ 01 ▲ 14-21 ▲ 14-16 ▲ 98-03 ▲ 03 ▲ 14-16 ▲ 14-16 ▲ 98-99 ▲ 00-03 ▲ 01-03 ▲ 98-99 ▲ 00-03 ▲ 01-03 ▲ 98-03 ▲ 01-03 ▲ 98 99-03 ▲ 98 99-03 ▲ 16 15-16 ▲ 15 16 98 00-03 ▲ 98-03 ▲ 99 00 98 99-05 ▲ 99-03 ▲ 01-03 ▲ 99 00-03 ▲ 99 00-03 ▲
SRC7003 SRK7003 CT702SP ▲	HARLEY DAVIDSON FLHTKL 1KKL Ultra Limited Low FLRT 1MCM Freewheeler FLSS 1JS9slims FLSS 1JS9softailslims FLSTFBS 1JT9 Fat Boys FLSTFBS 1JT9 Fat Boys	15-16 ▲ 15-16 ▲ 17-21 ▲ 16 ▲ 16-17 17			
SRC7004 SRK7004	INDIAN Chief Classic Chief Dark Horse Chief Vintage Chieftain Chieftain Dark Horse Chieftain Elite Chieftain Limited Roadmaster Roadmaster Classic Roadmaster Elite Springfield Springfield Dark Horse	14-21 16-21 14-21 14-18 16-21 17-21 17-18 15-18 17-21 18-21 16-21 18			
SRC7005 SRK7005	HARLEY DAVIDSON® XG500 XG750	15-20 15-20			
SRC7006 SRK7006 CT702SP ▲	HARLEY DAVIDSON VRSCAW V-Rod Wide Tire VRSCAWA W/ABS VRSCDnight Rod VRSCDAnight Rod W/ABS VRSCDXAnight Rodspecial W/ABS VRSCDXnight Rodspecial VRSCAW V-Rod VRSCF V-Rod Muscle VRSCDX ANVnight Rodspecial Anv	08 ▲ 08 ▲ 08 ▲ 08 ▲ 08 ▲ 08-21 ▲ 09-10 ▲ 09-21 ▲ 12 ▲			
SRC7007 SRK7007 CT707SP ▲	HARLEY DAVIDSON® VRSCA V-Rod VRSCAW V-Rod VRSCB V-Rod VRSCRstreet Rod VRSCSE CVO V-Rod VRSCSE2 CVO V-Rod VRSCXscreamin' Eagle V-Rod VRXSE CVO VR Destroyer	02-06 ▲ 07 ▲ 04-05 ▲ 06-07 ▲ 05 ▲ 06 ▲ 07 ▲ 06 ▲			
SRC7008 SRK7008 CT708SP ▲	HARLEY DAVIDSON® FLFBS 1YBK Fat Boy 114 FLFBS 1YRK Fat Boy 114 Anniversary FLFBS 1YSK Fat Boy 114 Anniversary FLHCS 1YBK Heritage Classic 114 FLHCS 1YPK Heritage Classic 114 Anniversary FLHP 1FHC Road King Police FLHTCUTG 1MAD Tri Glide Ultra FLHTCUTG 1MDD Tri Glide Ultra Anniversary FLHTP 1FMC Electra Glidestandard Police FLRT 1MCC Freewheeler FXBRS 1YHK Breakout 114 FXBRS 1YTK Breakout 114 Anniversary	18-21 ▲ 18-21 ▲ 18-21 ▲ 18-21 ▲ 18-21 ▲ 17 ▲ 17-21 ▲ 18-21 ▲ 17 ▲ 17-21 ▲ 18 ▲ 18 ▲			

SRC/SRK CLUTCH KIT BUYERS GUIDE

Part no.	Make/Model	Year	Part no.	Make/Model	Year
SRC7011 SRK7011 CT703SP ▲ Contd.	HARLEY DAVIDSON®		SRC7012 SRK7012 CT703SP ▲ Contd.	FXDC 103 1GVM Dynasuper Glide Custom	14 ▲
	FXSTBI 1JABnight Train	01-03 ▲		FXDC 1GTV Dynasuper Glide Custom	05 ▲
	FXSTC 1BKLSofail Custom	98-99 ▲		FXDCI 1GVW Dynasuper Glide Custom	05 ▲
	FXSTD 1BSYsofai Deuce	00-03 ▲		FXDF 103 1GYM Dyna Fat Bob	12-17 ▲
	FXSTDI 1JBBsofai Deuce	01-03 ▲		FXDI 1GMW Dynasuper Glide	04-05 ▲
	FXSTI 1BVBsofai standard	01-03 ▲		FXDL 103 1GNM Dyna Low Rider	14-16 ▲
	FXSTS 1BLLspringersofail	98-99 ▲		FXDL 103 1GNM Low Rider 103	17 ▲
	FXSTS 1BLYspringersofail	00-03 ▲		FXDL 1GDV Dyna Low Rider	04-05 ▲
	FXSTSI 1BZBspringersofail	01-03 ▲		FXDLI 1GNW Dyna Low Rider	04-05 ▲
					FXDWG 103 1GPM Dyna Wide Glide
SRC7012 SRK7012 CT703SP ▲	HARLEY DAVIDSON®		FXDWG 103 1GPM Dyna Wide Glide 103	17 ▲	
	FLD 103 1GZM Dynaswitchback	12-16 ▲	FXDWG 103 1GPM Dyna Wide Glide	16 ▲	
	FLHR 103 1FBM Road King	11 ▲	FXDWGI 1GPW Dyna Wide Glide	04 ▲	
	FLHR 1FBM Road King	12-13 ▲	FXDWGI 1GPW Dyna Wide Glide	05 ▲	
	FLHR 1FDV Road King	04-05 ▲	FXDX 1GJV Dynasuper Glidesport	04-05 ▲	
	FLHR ANV 1FBM_ANV Road King ANV	13 ▲	FXDXI 1GRW Dynasuper Glidesport	04-05 ▲	
	FLHRC 103 1FRM Road King Classic	11 ▲	FXS 103 1JPV Blackline	12-13 ▲	
	FLHRC 1FRM Road King Classic	12-13 ▲	FXS 1JP5 Blackline	12 ▲	
	FLHRCI 1FRW Road King Classic	04 ▲	FXSB 103 1BFVsofai Breakout	13-15 ▲	
	FLHRCI 1FRW Road King Classic	05 ▲	FXSB 1BFV Breakout	17 ▲	
FLHRI 1FBW Road King	04-05 ▲	FXSB 1BFVsofai Breakout	16 ▲		
FLHRS 1FXV Road King Custom	04-05 ▲	FXST 1BHYsofai standard	04-06 ▲		
FLHRSI 1FYW Road King Custom	04 ▲	FXST 1BVsofai standard	12-15 ▲		
FLHRSI 1FYW Road King Custom	05 ▲	FXSTB 1BTYnight Train	04-05 ▲		
FLHT 1DDV Electra Glidestandard	04-05 ▲	FXSTBI 1JABnight Train	04-05 ▲		
FLHTC 103 1FFM Electra Glide Classic	11 ▲	FXSTD 1BSYsofai Deuce	04-05 ▲		
FLHTC 1DJV Electra Glide Classic	04-05 ▲	FXSTDI 1JBBsofai Deuce	04-05 ▲		
FLHTC 1FFM Electra Glide Classic	12 ▲	FXSTI 1BVBsofai standard	04-05 ▲		
FLHTC 1FFM Electra Glide Classic	13 ▲	FXSTS 1BLYspringersofail	04-05 ▲		
FLHTCI 1FCW Ultra Classic	05 ▲	FXSTSI 1BZBspringersofail	04-05 ▲		
FLHTCI 1FFW Electra Glide Classic	04-05 ▲				
FLHTCU 103 1FCM Ultra Classic	11 ▲	SRC7013 SRK7013 CT703SP ▲	HARLEY DAVIDSON®		
FLHTCU 1FCM Ultra Classic	12-13 ▲		FLD 1GZ4 Dynaswitchback	14-21 ▲	
FLHTCUI 1FCW Ultra Classic	04 ▲		FLHR 1FB4 Road King	07-11 ▲	
FLHTI 1FVW Electra Glidestandard	04-05 ▲		FLHR 1FDV Road King	06 ▲	
FLHTK 1KEM Electra Glide Ultra Limited	10-13 ▲		FLHR 96 FB4 Road King	11 ▲	
FLHTK ANV 1KEM_ANV Electra Glide Ultra Limited ANV	13 ▲		FLHRC 1FR4 Road King Classic	07-11 ▲	
FLHX 103 1KBMstreet Glide	11 ▲		FLHRCI 1FRW Road King Classic	06 ▲	
FLHX 1KBMstreet Glide	12-13 ▲		FLHRI 1FBW Road King	06 ▲	
FLS 103 1JRVsofai slim	13-15 ▲		FLHRS 1FXV Road King Custom	06 ▲	
FLS 103 1JRVsofai slim	12 ▲		FLHRS 1FY4 Road King Custom	07 ▲	
FLS 1JRVslim	17-21 ▲	FLHRSI 1FYW Road King Custom	06 ▲		
FLS 1JRVsofai slim	16 ▲	FLHT 1DDV Electra Glidestandard	06-10 ▲		
FLSTC 103 1BWV Heritagesofail Classic	13-15 ▲	FLHT 1FV4 Electra Glidestandard	08 ▲		
FLSTC 103 ANV 1BWV_ANV Heritagesofail Classic ANV	13 ▲	FLHTC 1FF4 Electra Glide Classic	07-11 ▲		
FLSTC 1BJY Heritagesofail Classic	04-05 ▲	FLHTCI 1FFW Electra Glide Classic	06 ▲		
FLSTC 1BWV Heritagesofail Classic	16-17 ▲	FLHTCU 1FC4 Ultra Classic	07-11 ▲		
FLSTCI 1BWB Heritagesofail Classic	04-05 ▲	FLHTCUI 1FCW Ultra Classic	06 ▲		
FLSTCshrine 1JHB Heritagesofail Classicshrine	05 ▲	FLHTI 1FVW Electra Glidestandard	06 ▲		
FLSTF 103 1BXV Fat Boy	12-14 ▲	FLHX 1KAVstreet Glide	06 ▲		
FLSTF 103 1BXV Fat Boy	15 ▲	FLHX 1KB4street Glide	07-11 ▲		
FLSTF 1BMY Fat Boy	04-05 ▲	FLHX 1KB4street Glide	09 ▲		
FLSTF 1BXV Fat Boy	16-17 ▲	FLHXI 1KBWstreet Glide	06 ▲		
FLSTFB 103 1JNV Fat Boy LO	12-15 ▲	FLS 1JR5sofai slim	12-15 ▲		
FLSTFB 103 ANV 1JNV_ANV Fat Boy LO ANV	13 ▲	FLST 1JE5 Heritagesofail	08-09 ▲		
FLSTFB 1JN5 Fat Boy LO	12 ▲	FLST 1JEY Heritagesofail	06 ▲		
FLSTFB 1JNV Fat Boy LO	16-17 ▲	FLSTC 103 1BWV Heritagesofail Classic	12 ▲		
FLSTFI 1BVB Fat Boy	04-05 ▲	FLSTC 1BJY Heritagesofail Classic	06 ▲		
FLSTFshrine 1JGB Fat Boyshrine	05 ▲	FLSTC 1BW5 Heritagesofail Classic	07-15 ▲		
FLSTN 103 1JDVsofai Deluxe	12-15 ▲	FLSTC ANV 1BW5_ANV Heritagesofail Classic ANV	13 ▲		
FLSTN 1BNIsofai Deluxe	05 ▲	FLSTCI 1BWB Heritagesofail Classic	06 ▲		
FLSTN 1JDV Deluxe	17 ▲	FLSTF 1BX5 Fat Boy	12 ▲		
FLSTN 1JDVsofai Deluxe	16 ▲	FLSTF 1BMY Fat Boy	06-15 ▲		
FLSTNI 1JDBsofai Deluxe	05 ▲	FLSTFB 1JN5 Fat Boy LO	10-11 ▲		
FLSTSC 1BRYspringer Classic	05 ▲	FLSTFB 1JN5 Fat Boy LO	13-15 ▲		
FLSTSCI 1BYBspringer Classic	05-06 ▲	FLSTFB ANV 1JN5_ANV Fat Boy LO ANV	13 ▲		
FLTRI 1FSW Road Glide	04-05 ▲	FLSTFI 1BVB Fat Boy	06 ▲		
FLTRU 1KGM Road Glide Ultra	11-13 ▲	FLSTI 1JFB Heritagesofail	06 ▲		
FLTRX 103 1KHM Road Glide Custom	11 ▲	FLSTN 1BNIsofai Deluxe	06 ▲		
FLTRX 1KHM Road Glide Custom	12-13 ▲	FLSTN 1JD5sofai Deluxe	07-15 ▲		
FXD 1GHV Dynasuper Glide	04-05 ▲	FLSTNI 1JDBsofai Deluxe	06 ▲		
FXDB 103 1GXM Dynastreet Bob	14-16 ▲	FLSTSB 1JM5 Cross Bones	08-11 ▲		
FXDB 103 1GXM Dynastreet Bob 103	17 ▲	FLSTSC 1BRYspringer Classic	06 ▲		
FXDBA 103 1VBM Dynastreet Bob (H-D1)	13 ▲	FLSTSC 1BY5springer Classic	07 ▲		
FXDBB 103 1VCM Dynastreet Bob (H-D1)	14-15 ▲	FLTR 1FS4 Road Glide	07-09 ▲		
FXDBC 103 1VDM Dynastreet Bob Limited	16 ▲	FLTRI 1FSW Road Glide	06 ▲		
FXDBP 103 1VAM Dynastreet Bob	16 ▲	FLTRX 1KH4 Road Glide Custom	10-11 ▲		
FXDBP 103 1VAM Dynastreet Bob (H-D1)	15 ▲	FXCW 1JJ5 Rocker	08-09 ▲		
FXDBP 103 1VAM Dynastreet Bob (H-D1)	13-14 ▲	FXCWC 1JK5 Rocker C	08-11 ▲		

SRC/SRK CLUTCH KIT BUYERS GUIDE

Part no.	Make/Model	Year	Part no.	Make/Model	Year	
SRC7013 SRK7013 CT703SP ▲ Contd.	FXD 1GM4 Dynasuper Glide	07-10 ▲	SRC7018 SRK7018 CT704SP ▲	HARLEY DAVIDSON®		
	FXD35 1GW1 Dyna 35th Anniversarysuper Glide	06 ▲		FLH Touring Electra Glideshrineshovelhead	83 ▲	
	FXDB 1GX4 Dynastreet Bob	07-21 ▲		FLH Electra Glide	81-83 ▲	
	FXDBA 1VB4 Dynastreet Bob (H-D1)	13 ▲		FLHC Touring Electra Glide Classic	81-82 ▲	
	FXDBB 1VC4 Dynastreet Bob (H-D1)	15 ▲		FLHC Electra Glide Classic	81 ▲	
	FXDBC 1VD4 Dynastreet Bob Limited	16 ▲		FLHS Touring Electra Glidesport	81-83 ▲	
	FXDBI 1GX1 Dynastreet Bob	06 ▲		FLHS Heritage, Electra Glide	81 ▲	
	FXDC 1GV4 Dynasuper Glide Custom	07-14 ▲		FLHT Touring Electra Glidestandard	83 ▲	
	FXDC ANV 1GV4_ANV Dynasuper Glide Custom ANV	13 ▲		FLHT Electra Glide Classic	83 ▲	
	FXDCI 1GV1 Dynasuper Glide Custom	06 ▲		FLHT Electra Glide	83 ▲	
	FXDF 1GY4 Dyna Fat Bob	08-17 ▲		FLHTC Touring Electra Glide Classic	83-84 ▲	
	FXDI 1GM1 Dynasuper Glide	06 ▲		FLT Touring Tour Glide	81-83 ▲	
	FXDL 1GN4 Dyna Low Rider	07-21 ▲		FLT Classic Tour Glide Classic	81-83 ▲	
	FXDWG 1GP4 Dyna Wide Glide	07-16 ▲		FLT Tour Glide	81-83 ▲	
	FXDWG ANV 1GP4 Dyna Wide Glide 105th Anniversary	08 ▲		FLTC Touring Tour Glide Classic	80-84 ▲	
	FXDWGI 1GP1 Dyna Wide Glide	06 ▲		FXBsuper Glide B80	81-82 ▲	
	FXS 1JP5 Blackline	11 ▲		FXDG Dyna Glide Custom	83 ▲	
	FXS 1JP5 Blackline	13 ▲		FXE FXsuper Glide	81-84 ▲	
	FXSB 1BF5softail Breakout	13-15 ▲		FXEF FXsuper Glide Fat Bob	81 ▲	
	FXST 1BV5softailstandard	07-11 ▲		FXS FXsuper Glide	81-82 ▲	
	FXSTB 1BTYnight Train	06 ▲		FXSB FX Low Rider	83-84 ▲	
	FXSTB 1JA5night Train	07-09 ▲		FXSTsoftailstandard	84 ▲	
	FXSTBI 1JABnight Train	06 ▲		FXWG FX Wide Glide	81-84 ▲	
	FXSTC 1JL5softail Custom	07-10 ▲				
	FXSTD 1BSYsoftail Deuce	06 ▲		SRC7019 SRK7019 CT701SP ▲	HARLEY DAVIDSON®	
	FXSTD 1JB5softail Deuce	07 ▲			FLSTsoftail Heritage	90 ▲
	FXSTDI 1JBBsoftail Deuce	06 ▲			FLSTC Heritagesoftail Classic	90-97 ▲
	FXSTI 1BV5softailstandard	06 ▲			FLSTF Fat Boy	91-97 ▲
	FXSTS 1BLYspringerssoftail	06 ▲			FLSTFsoftail Fat Boy	90 ▲
	FXSTSI 1BZBspringerssoftail	06 ▲			FLSTN Heritagesoftailnostalgia	93-96 ▲
					FLSTS Heritagespringer	97 ▲
		FXD Dynasuper Glide	95-97 ▲			
SRC7014 SRK7014 CT701SP ▲	HARLEY DAVIDSON®		FXDB Dyna Daytona		92 ▲	
	FLHR Road King	93-97 ▲	FXDB Dynasturgis		91 ▲	
	FLHS Electra Glidesport	91-94 ▲	FXDCsuper Glide Custom		92 ▲	
	FLHT Electra Glidestandard	94-97 ▲	FXDL Dyna Low Rider		93-97 ▲	
	FLHTC Electra Glide Classic	91-97 ▲	FXDS-CONV Dyna Glide Convertible		93 ▲	
	FLHTCU Ultra Classic	91-97 ▲	FXDWG Dyna Wide Glide		93-97 ▲	
			FXSTsoftailstandard		90 ▲	
			FXSTCsoftail Custom	90-97 ▲		
			FXSTSspringerssoftail	90-97 ▲		
SRC7015 SRK7015 CT701SP ▲	HARLEY DAVIDSON®		SRC7020 SRK7020 CT701SP ▲	HARLEY DAVIDSON®		
	FLHS Touring Electra Glidesport	90 ▲		XL1200 1LN3 Forty Eight Anniversary	18 ▲	
	FLHTC Touring Electra Glide Classic	90 ▲		XL1200C 1CGPsportster 1200 Custom	04-06 ▲	
	FLHTCU Touring Electra Glide Classic Ultra	90 ▲		XL1200C 1CT3sportster 1200 Custom	17-21 ▲	
	FLTC Touring Tour Glide Classic	90 ▲		XL1200C ANV 1CT3_ANVsportster 1200 Custom ANV	13 ▲	
FLTCU Touring Tour Glide Classic Ultra	90 ▲	XL1200CA 1LJ3sportster 1200 Custom Limited A	13-21 ▲			
SRC7016 SRK7016 CT705SP ▲	HARLEY DAVIDSON®		XL1200CB 1LK3 1200 Custom Limited B	17 ▲		
	FLH Touring Electra Glide	84 ▲	XL1200CB 1LK3sportster 1200 Custom Limited A	16 ▲		
	FLH Touring Electra Glideshrineshovelhead	84 ▲	XL1200CB 1LK3sportster 1200 Custom Limited B	13-15 ▲		
	FLHS Touring Electra Glidesport	84-89 ▲	XL1200CP 1LH3sportster 1200 Custom (H-D1)	11-21 ▲		
	FLHT Touring Electra Glidestandard	88 ▲	XL1200CX 1LM3 1200 Roadster	16-18 ▲		
	FLHT Electra Glide Classic	84 ▲	XL1200L 1CWPsportster 1200 Low	06 ▲		
	FLHT Electra Glide	84 ▲	XL1200L 1CX3sportster 1200 Low	07-11 ▲		
	FLHTC Touring Electra Glide Classic	84-89 ▲	XL1200N 1CZ3nightster	07-12 ▲		
	FLHTCU Touring Electra Glide Classic Ultra	89 ▲	XL1200R 1CLPsportster 1200 Roadster	04-06 ▲		
	FLSTsoftail Heritage	86-89 ▲	XL1200R 1CV3sportster 1200 Roadster	07-09 ▲		
	FLSTCsoftail Heritage Classic	87-89 ▲	XL1200T 1LL3superLow 1200T	14-21 ▲		
	FLT Classic Tour Glide Classic	84 ▲	XL1200V 1LF3seventy-Two	12-16 ▲		
	FLT Tour Glide	84 ▲	XL1200X 1LC3 Forty Eight	10-21 ▲		
	FLTC Touring Tour Glide Classic	84-89 ▲	XL50 1CY3 50th ANVsportster	07 ▲		
	FLTCU Touring Tour Glide Classic Ultra	89 ▲				
	FXE FXsuper Glide	84 ▲	SRC7021 SRK7021 CT701SP ▲	HARLEY DAVIDSON®		
	FXEF FXsuper Glide Fat Bob	85 ▲		XL883 4CAMsportster 883	04-06 ▲	
	FXSB FX Low Rider	84-85 ▲		XL883 4CN2sportster 883	07-09 ▲	
	FXSTsoftailstandard	84-89 ▲		XL883C 4CJMsportster 883 Custom	04-06 ▲	
FXSTCsoftail Custom	86-89 ▲	XL883C 4CP2sportster 883 Custom		07-10 ▲		
FXSTSsoftailspringer	88-89 ▲	XL883L 4CMMsportster XL883 Low		05 ▲		
FXWG FX Wide Glide	84-86 ▲	XL883L 4CR2sportster 883 Low		11 ▲		
		XL883L 4CR2superLow		14-16 ▲		
SRC7017 SRK7017 CT704SP ▲	HARLEY DAVIDSON®			XL883L 4CMMsportster XL883 Low	06 ▲	
	FLH Touring Electra Glide	EARLY 84 ▲		XL883L 4CR2sportster 883 Low	10 ▲	
	FLH Touring Electra Glideshrineshovelhead	EARLY 84 ▲	XL883L 4CR2sportster XL883 Low	07-09 ▲		
	FLHS Touring Electra Glidesport	EARLY 84 ▲	XL883L 4CR2superLow	12-18 ▲		
	FLHT Electra Glide	EARLY 84 ▲	XL883N 4LE2 Iron 883	09-21 ▲		
	FLHT Electra Glide Classic	EARLY 84 ▲	XL883R 4CS2 883 Roadster	14 ▲		
	FLT Classic Tour Glide Classic	EARLY 84 ▲	XL883R 4CS2 883 Roadster	11-15 ▲		
	FLT Tour Glide	EARLY 84 ▲	XL883R 4CS2sportster 883R	07-10 ▲		

SRC/SRK CLUTCH KIT BUYERS GUIDE

Part no.	Make/Model	Year	Part no.	Make/Model	Year
SRC7022 SRK7022 CT701SP ▲	HARLEY DAVIDSON® XR 1200sportster XR 1200 X	08-10 ▲ 10-13 ▲			
SRC7023 SRK7023 CT701SP ▲	HARLEY DAVIDSON® XL1200sportster 1200 XL1200Csportster 1200 Custom XL1200Ssportster 1200sport XL883sportster 883 XL883Csportster 883 Custom XL883DLXsportster 883 Deluxe XL883HUGsportster 883 Hugger XL883Rsportster 883R	91-03 ▲ 96-03 ▲ 96-03 ▲ 91-03 ▲ 98-03 ▲ 91-95 ▲ 91-03 ▲ 02-06 ▲			
SRC7024 SRK7024 CT701SP ▲	HARLEY DAVIDSON® XL1200sportster 1200 XL883sportster 883 XL883sportster 883 Deluxe XL883HUGsportster 883 Hugger XLH 1100sportster 1100 XLHsportster 1000 XLSsportster Roadster 1000 XR-1000sportster	88-90 ▲ 86-90 ▲ 86-90 ▲ 87-90 ▲ 86-87 ▲ 84-85 ▲ 84 ▲ 84 ▲			
SRC7025 SRK7025 CT701SP ▲	HARLEY DAVIDSON® XLCH-1000sportster 1000 XLH-1000sportster 1000 XLH-1000sportsterstandard XLS 1000sportster Roadster XR 1000sportster	71-84 ▲ 79-80 ▲ 71-78 ▲ 81-84 ▲ 83-84 ▲			

Making Precision Pilot Jets

Everyone knows how sensitive an engine is to pilot jets in the acceleration stages from 1000 to 3500 rpm and getting fuel mixture right in this area is critical. For this reason jets have to be perfectly accurate in their marked size and incremental size steps. EBC Brakes' sister company A-BAX Precision Engineering Ltd in the UK has purchased the most accurate machine on the planet for this work shown below. A-BAX Precision Engineering Ltd pilot jets are precise, clearly marked and reliably gauged using pin gauges, accurate to one tenth of a thousandth of an inch, you can rely on their accuracy.

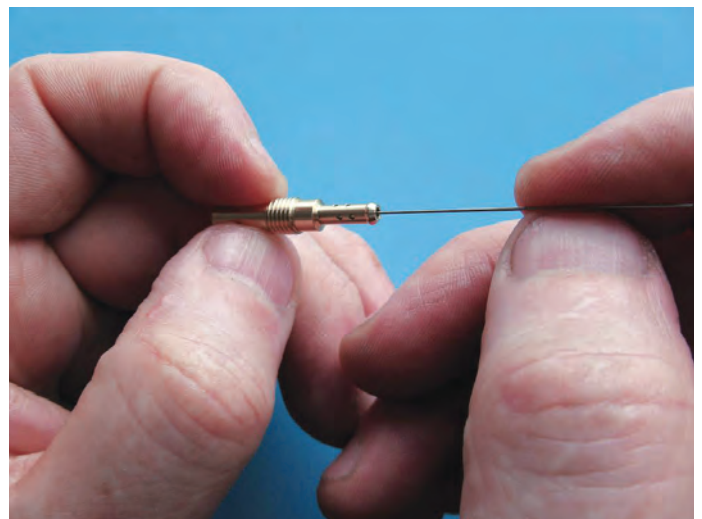
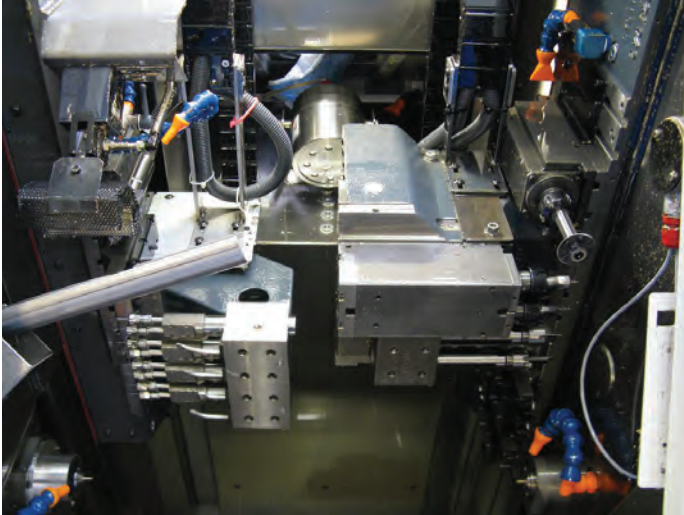

Part numbers, prefixes, suffixes, photos and illustrations shown in this catalog are trademarks and/or copyrights of EBC Brakes or the trademark owner A C Freeman Investments Ltd and use without express written permission of the owners is punishable by law.

PILOT JETS

A-BAX Precision Engineering Ltd Pilot Jets for Mikuni Carbs (Sold in packs of 4)

Jet Style - VM22/210
8 bleed hole type
VM18 / VM22 / VM26-34 Flange Type
VM26-44 Spigot Type
TM24-38 (No accelerator pump)
Early TMX/TMXCarb Types

Size	Part #
10	EBC22/210-10
12.5	EBC22/210-12.5
15	EBC22/210-15
17.5	EBC22/210-17.5
20	EBC22/210-20
22.5	EBC22/210-22.5
25	EBC22/210-25
27.5	EBC22/210-27.5
30	EBC22/210-30
32.5	EBC22/210-32.5
35	EBC22/210-35
37.5	EBC22/210-37.5
40	EBC22/210-40
42.5	EBC22/210-42.5
45	EBC22/210-45
47.5	EBC22/210-47.5
50	EBC22/210-50
52.5	EBC22/210-52.5
55	EBC22/210-55
57.5	EBC22/210-57.5
60	EBC22/210-60
65	EBC22/210-65
70	EBC22/210-70
75	EBC22/210-75
80	EBC22/210-80
85	EBC22/210-85
90	EBC22/210-90
95	EBC22/210-95
100	EBC22/210-100
105	EBC22/210-105
110	EBC22/210-110
120	EBC22/210-120
130	EBC22/210-130
140	EBC22/210-140

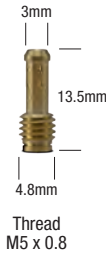

Jet Style - N224.103
2.5mm bleed end
Early TMS/TMX
OEM MX36/38 BSR CVtype
Honda / Kawasaki / Suzuki / Yamaha

Size	Part #
10	EBC224-10
12.5	EBC224-12.5
15	EBC224-15
17.5	EBC224-17.5
20	EBC224-20
22.5	EBC224-22.5
25	EBC224-25
27.5	EBC224-27.5
30	EBC224-30
32.5	EBC224-32.5
35	EBC224-35
37.5	EBC224-37.5
40	EBC224-40
42.5	EBC224-42.5
45	EBC224-45
47.5	EBC224-47.5
50	EBC224-50
52.5	EBC224-52.5
55	EBC224-55
57.5	EBC224-57.5
60	EBC224-60
62.5	EBC224-62.5
65	EBC224-65
67.5	EBC224-67.5
70	EBC224-70



Jet Style - N151.067
No bleed holes
Later OEM BStrange CVcarbs
Kawasaki / Suzuki / Yamaha

Size	Part #
30	EBC151-30
32.5	EBC151-32.5
35	EBC151-35
37.5	EBC151-37.5
40	EBC151-40
42.5	EBC151-42.5
45	EBC151-45
47.5	EBC151-47.5
50	EBC151-50
52.5	EBC151-52.5
55	EBC151-55
57.5	EBC151-57.5
60	EBC151-60



Jet Style - VM28/486
2mm bleed hole type
HS40 / HSR42 / 45 / 48 / RS34-40
TM33 / 36 / 40 with accelerator pump
Kawasaki / Suzuki / Yamaha

Size	Part #
10	EBC28/486-10
12.5	EBC28/486-12.5
15	EBC28/486-15
17.5	EBC28/486-17.5
20	EBC28/486-20
22.5	EBC28/486-22.5
25	EBC28/486-25
27.5	EBC28/486-27.5
30	EBC28/486-30
32.5	EBC28/486-32.5
35	EBC28/486-35
37.5	EBC28/486-37.5
40	EBC28/486-40
42.5	EBC28/486-42.5
45	EBC28/486-45
47.5	EBC28/486-47.5
50	EBC28/486-50
52.5	EBC28/486-52.5
55	EBC28/486-55
57.5	EBC28/486-57.5
60	EBC28/486-60
62.5	EBC28/486-62.5
65	EBC28/486-65
67.5	EBC28/486-67.5
70	EBC28/486-70



Jet Style - BS30/96
6 bleed hole type
Various OEM BStrange CV carbs
Kawasaki / Suzuki / Yamaha

Size	Part #
30	EBC30/96-30
32.5	EBC30/96-32.5
35	EBC30/96-35
37.5	EBC30/96-37.5
40	EBC30/96-40
42.5	EBC30/96-42.5
45	EBC30/96-45
47.5	EBC30/96-47.5
50	EBC30/96-50
52.5	EBC30/96-52.5
55	EBC30/96-55
57.5	EBC30/96-57.5
60	EBC30/96-60

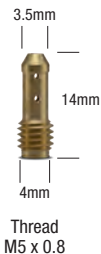

Jet Style - M28/1001
Yamaha P/No. 260-14142-Size
Blaster/Banshee/LC

Size	Part #
15	EBC1001-15
17.5	EBC1001-17.5
20	EBC1001-20
22.5	EBC1001-22.5
25	EBC1001-25
27.5	EBC1001-27.5
30	EBC1001-30
32.5	EBC1001-32.5
35	EBC1001-35
37.5	EBC1001-37.5
40	EBC1001-40
42.5	EBC1001-42.5
45	EBC1001-45
47.5	EBC1001-47.5
50	EBC1001-50
52.5	EBC1001-52.5
55	EBC1001-55
57.5	EBC1001-57.5
60	EBC1001-60
62.5	EBC1001-62.5
65	EBC1001-65
67.5	EBC1001-67.5
70	EBC1001-70



A-BAX Precision Engineering Ltd Pilot Jets for Keihin Carbs (Sold in packs of 4)

Jet Style - N424-21
Pilot / Slow Running Jet
PB16 / 18 / 20
Yamaha R6 99-07

Various Kawasaki / Suzuki Quads

Size	Part #
35	EBC424-21-35
38	EBC424-21-38
40	EBC424-21-40
42	EBC424-21-42
45	EBC424-21-45
48	EBC424-21-48
50	EBC424-21-50
52	EBC424-21-52
55	EBC424-21-55
58	EBC424-21-58
60	EBC424-21-60
62	EBC424-21-62
65	EBC424-21-65
68	EBC424-21-68
70	EBC424-21-70
72	EBC424-21-72
75	EBC424-21-75
78	EBC424-21-78
80	EBC424-21-80



Jet Style - N424-25
Pilot / Slow Running Jet
FCR 28 / 32 / 33 / 35 / 37 / 39 / 41mm
Harley D Keihin BH (Non CVType)

Various Kawasaki / Yamaha Models with CVK / FCR / BD style carbs

Size	Part #
35	EBC424-25-35
38	EBC424-25-38
40	EBC424-25-40
42	EBC424-25-42
45	EBC424-25-45
48	EBC424-25-48
50	EBC424-25-50
52	EBC424-25-52
55	EBC424-25-55
58	EBC424-25-58
60	EBC424-25-60
62	EBC424-25-62
65	EBC424-25-65

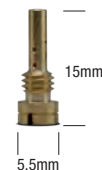

Part numbers, prefixes, suffixes, photos and illustrations shown in this catalog are trademarks and/or copyrights of EBC Brakes or the trademark owner A C Freeman Investments Ltd and use without express written permission of the owners is punishable by law.

PILOT JETS

Dealer Pilot Jet Selection Kits

(Kits include one pilot jet per size)



KIT NUMBER	CARB MODEL	JET STYLE	QTY JETS IN KIT	SIZES
KPJK-01	Keihin	N424-21	19	35-80
KPJK-02	Keihin	N424-25B	13	35-65
MPJK-01	Mikuni	VM22/210	34	10-140
MPJK-02	Mikuni	N224.103	25	10-70
MPJK-03	Mikuni	N151.067	13	30-60
MPJK-04	Mikuni	BS30/96	13	30-60
MPJK-05	Mikuni	M28/486	25	10-70

Precision machined in the UK A-BAX Precision Engineering Ltd Dealer selection kits include all the popular sizes for the better selling pilot jets and refills can be purchased from your distributor in packets of four.

A-BAX Precision Engineering Ltd

Pilot Jets for Mikuni Carbs and Keihin Carbs



MAIN JETS

A-BAX Precision Engineering Ltd MAINJETS

Made in the UK, these high precision BRASS carburettor jets are available in dealer selection kits or in top-up packs of 5 jets or 4 jets. All jets are flow calibrated and extremely accurate in terms of fuel flow rate as stamped.



DEALER SELECTION KITS

KIT TYPE	PART#	CONTENTS	
Mikuni Slot	SJK 36	4pcs each jet sizes 72.5 thru 160	144 Jets
Mikuni Hex	HJK 27A	2pcs each jet sizes 70 thru 230	54 Jets
Mikuni Hex	HJK 27B	2pcs each jet sizes 240 thru 500	54 Jets
Keihin Slot	KJK 30	4pcs each jet sizes 80 thru 190	132 Jets
Keihin Hex	CRK 32A	2pcs each jet sizes 80 thru 158	64 Jets
Keihin Hex	CRK 32B	2pcs each jet sizes 160 thru 235	64 Jets

<p>A-BAX Slot Jets for Mikuni</p> <p>(N 100/604) SJ Prefix</p>	<p>A-BAX Hex Jets for Mikuni</p> <p>(4/042) HJ Prefix</p>	<p>A-BAX Slot Jets for Keihin</p> <p>(N102 221) KJ Prefix</p>	<p>A-BAX Hex Jets for Keihin</p> <p>(357) CR Prefix</p>	<p>A-BAX Slot Jets for Dell 'Orto'</p> <p>(6413) DO Prefix</p>
--	---	---	---	--

SJ SIZES AVAILABLE	HJ SIZES AVAILABLE		KJ SIZES AVAILABLE	CR SIZES AVAILABLE		DO SIZES AVAILABLE
SJ72.5	HJ70	HJ340	KJ72.5	CR80	CR172	D070
SJ75	HJ80	HJ350	KJ75	CR82	CR175	D075
SJ77.5	HJ90	HJ360	KJ77.5	CR85	CR178	D080
SJ80	HJ100	HJ370	KJ80	CR88	CR180	D085
SJ82.5	HJ105	HJ380	KJ82.5	CR90	CR182	D090
SJ85	HJ110	HJ390	KJ85	CR92	CR185	D095
SJ87.5	HJ115	HJ400	KJ87.5	CR95	CR188	D0100
SJ90	HJ120	HJ410	KJ90	CR98	CR190	D0105
SJ92.5	HJ125	HJ420	KJ92.5	CR100	CR192	D0110
SJ95	HJ130	HJ430	KJ95	CR102	CR195	D0115
SJ97.5	HJ135	HJ440	KJ97.5	CR105	CR198	D0120
SJ100	HJ140	HJ450	KJ100	CR108	CR200	D0125
SJ102.5	HJ145	HJ460	KJ102.5	CR110	CR202	D0130
SJ105	HJ150	HJ470	KJ105	CR112	CR205	D0135
SJ107.5	HJ155	HJ480	KJ107.5	CR115	CR208	D0140
SJ110	HJ160	HJ490	KJ110	CR118	CR210	D0145
SJ112.5	HJ165	HJ500	KJ112.5	CR120	CR212	D0150
SJ115	HJ170	HJ510	KJ115	CR122	CR215	D0155
SJ117.5	HJ175	HJ520	KJ117.5	CR125	CR218	D0160
SJ120	HJ180	HJ530	KJ120	CR128	CR220	D0165
SJ122.5	HJ185	HJ540	KJ122.5	CR130	CR222	D0170
SJ125	HJ190	HJ550	KJ125	CR132	CR225	D0175
SJ127.5	HJ195	HJ560	KJ127.5	CR135	CR228	D0180
SJ130	HJ200	HJ570	KJ130	CR138	CR230	D0185
SJ132.5	HJ210	HJ580	KJ132.5	CR140	CR232	D0190
SJ135	HJ220	HJ590	KJ135	CR142	CR235	D0195
SJ137.5	HJ230	HJ600	KJ137.5	CR145	CR238	D0200
SJ140	HJ240	HJ610	KJ140	CR148		
SJ142.5	HJ250	HJ620	KJ142.5	CR150		
SJ145	HJ260	HJ630	KJ145	CR152		
SJ147.5	HJ270	HJ640	KJ147.5	CR155		
SJ150	HJ280	HJ650	KJ150	CR158		
SJ152.5	HJ290	HJ660	KJ152.5	CR160		
SJ155	HJ300	HJ670	KJ160	CR162		
SJ157.5	HJ310	HJ680	KJ170	CR165		
SJ160	HJ320	HJ690	KJ190	CR168		
SJ170	HJ330			CR170		

NOTE: The names Mikuni & Keihin are for description purposes only. These are NOT original Mikuni or Keihin jets, simply a high quality replacement.

Part numbers, prefixes, suffixes, photos and illustrations shown in this catalog are trademarks and/or copyrights of EBC Brakes or the trademark owner A C Freeman Investments Ltd and use without express written permission of the owners is punishable by law.

CARBURETTOR JETS

A-BAX Precision Engineering Ltd brass main jets for Keihin CVH carburettors, used on most big twins. Sold in packets of 2 pieces and in dealer assortment kits of 12 sizes (2 pieces each size).



DEALER SELECTION KIT PART NO – HDJK-12

MAIN JETS	SIZES AVAILABLE
<p>Slot Jets for Harley Davidson®</p> <p>424-27 slotted series part numbers adjacent are for a packet of 2 jets.</p>	EBC424-27-165
	EBC424-27-170
	EBC424-27-175
	EBC424-27-180
	EBC424-27-185
	EBC424-27-190
	EBC424-27-195
	EBC424-27-200
	EBC424-27-205
	EBC424-27-210
	EBC424-27-220

BRAKE FLUID

Now tested to meet Florida EPA requirements. Bottle label shows all specifications of the fluid.



A refined specification polyglycol fluid as fitted to most faster street bikes now produced.



Silicone fluid as used in Harley Davidson Motorcycles and many special High Performance Brake systems.



Highly refined DOT 4 Brake fluid, ideal for Racing or High Performance Road bikes. Can be used in all systems specifying DOT 4 but **NOT** with (DOT 5) silicone fluids.

TO ORDER USE THESE PART NUMBERS

SIX PACK		SINGLE BOTTLES	
DOT 4 (Six Pack)	BF004	DOT 4 (Single)	BF004A
DOT 5 (Six Pack) (Silicone)	BF005	DOT 5 (Single) (Silicone)	BF005A
BF 307 (Six Pack)	BF307	BF 307 (Single)	BF307A

CAUTION: Please check carefully the type of brake fluid used in your system. Adding incorrect fluids could cause major brake failure. DO NOT ever mix glycol fluids (DOT 4 or BF-307) with DOT 5 silicone.

BRAKE CALIPER LUBE

These sachets of dedicated, high viscosity greases are perfect for all of your customers' brake service needs. Always use sparingly on caliper slider pins and rails, but do NOT get near the pad surface and do NOT use as anti-squeal as it will not help at all. Each sachet contains 5 grammes of grease.

TO ORDER USE THESE PART NUMBERS

Ten Sachets	LUBE010
Fifty Sachets	LUBE050



NOTES

NOTES

NOTES



WARNING: Cancer and
Reproductive Harm —
www.P65Warnings.ca.gov

COPYRIGHT NOTICE: The part numbers, illustrations and listings in this publication are the copyright of EBC Brakes and any reproduction in part or whole or similarity, without advance authority in writing is contrary to international law and copyright holders will enforce vigorously. Vehicle manufacturers names and model numbers are indicated for cross reference purposes only. All products in this catalog are manufactured by EBC Brakes and are not original equipment parts.

Cover Image:

Rider – Zachary Schumacher (@z_schumacher90)

Photographer – Brian J Nelson (@brianjnelsonphoto)



EBC[®]
BRAKES

**Distribution Center for The Americas, Canada, Mexico, West Indies,
Puerto Rico, Virgin Islands and Central American States.**

Head Office: EBC Brakes USA Inc. 6180 South Pearl Street, Las Vegas, Nevada 89120 Tel: +1 (702) 826-2400

The letters EBC form a registered trademark in the United States and most countries worldwide.

www.ebcbrakes.com sales@ebcbrakesusa.com