

FASCICOLO 31/F EDIZIONE 2014

PARTI TELAIO

AMMORTIZZATORI, CUSCINETTI, CAVALLETTI



Indice

Tabella applicazioni ammortizzatori "Sebac" 5

<i>POSTERIORI</i>5	<i>MALAGUTI</i>5
<i>BETA</i>5	<i>MBK</i>5
<i>HONDA</i>5	<i>PEUGEOT</i>5
<i>KYMCO</i>5	<i>PIAGGIO</i>5
<i>ITALJET</i>5	<i>YAMAHA</i>6

Figurato ammortizzatori "Sebac" 6

Forcelle idrauliche per scooter. 6

Ammortizzatori Piaggio Vespa/Piaggio Ape

Innocenti Lambretta 7

<i>PIAGGIO VESPA</i>7	<i>INNOCENTI LAMBRETТА</i> ...9
<i>PIAGGIO APE</i>8	

Figurato ammortizz. Piaggio Vespa/Piaggio Ape

Innocenti Lambretta 9

Tabella applicazioni ammortizzatori scooter. . . . 11

<i>ANTERIORI</i>11	<i>GILERA</i>15
<i>ITALJET</i>11	<i>HONDA</i>15
<i>PEUGEOT</i>11	<i>ITALJET</i>16
<i>PIAGGIO</i>11	<i>KYMCO</i>17
	<i>MALAGUTI</i>18
<i>POSTERIORI</i>12	<i>MBK</i>18
<i>APRILIA</i>12	<i>PEUGEOT</i>19
<i>ATALA-RIZZATO</i>14	<i>PIAGGIO</i>20
<i>BENELLI</i>14	<i>SUZUKI</i>23
<i>BETA</i>14	<i>SYM</i>23
<i>BMW</i>14	<i>YAMAHA</i>23
<i>DERBI</i>14	

Figurato e misure ammortizzatori "SGR" scooter . . . 25

Figurato e misure ammortizzatori "YSS" scooter . . . 26

<i>ANTERIORI</i>26	<i>POSTERIORI</i>26
--------------------------	---------------------------

Figurato e misure ammortizzatori "Forza" 30

Ammortizzatori posteriori ciclomotori

e motocicli. 32

<i>AERMACCHI</i>32	<i>KAWASAKI</i>37
<i>AGRATI-GARELLI</i>32	<i>KYMCO</i>39
<i>APRILIA</i>32	<i>LAVERDA</i>39
<i>ATALA-RIZZATO</i>32	<i>MALAGUTI</i>39
<i>BENELLI</i>32	<i>MBK/MOTOBECANE</i>39
<i>BMW</i>33	<i>MOTO GUZZI</i>39
<i>CAGIVA</i>33	<i>MOTO MORINI</i>41
<i>DAELIM</i>34	<i>MV AGUSTA</i>41
<i>DERBI</i>34	<i>MZ</i>41
<i>DUCATI</i>34	<i>NORTON</i>42
<i>FANTIC MOTOR</i>34	<i>PEUGEOT</i>42
<i>GILERA</i>35	<i>PIAGGIO</i>42
<i>JAWA</i>35	<i>SUZUKI</i>42
<i>HARLEY-DAVIDSON</i>35	<i>TRIUMPH</i>43
<i>HONDA</i>35	<i>YAMAHA</i>44
<i>HYOSUNG</i>37	

Figurato e misure coppie ammortizzatori

"YSS" moto 45

Figurato e misure monoammortizzatori

a gas "YSS" moto 46

Figurato ammortizzatori "SGR" per ciclomotori

e moto 47

Tabella applicazioni ammortizzatori sterzo

e forcella Aprilia/Moto Guzzi 48

<i>APRILIA</i>48	<i>MOTO GUZZI</i>48
------------------------	---------------------------

Tabella cavalletti. 49

<i>APRILIA</i>49	<i>MALAGUTI</i>52
<i>BETAMOTOR</i>50	<i>MBK</i>53
<i>CAGIVA</i>50	<i>PEUGEOT</i>54
<i>DERBI</i>50	<i>PIAGGIO</i>54
<i>GILERA</i>50	<i>RIEJU</i>56
<i>HONDA</i>51	<i>SUZUKI</i>57
<i>HUSQVARNA</i>52	<i>SYM</i>57
<i>KEEWAY</i>52	<i>YAMAHA</i>57
<i>KYMCO</i>52	

Figurato cavalletti 58

<i>CENTRALI KIT/NUDO</i>58	<i>LATERALI</i>63
----------------------------------	-------------------------

Tabella applicazioni rubinetti benzina

sonde livello olio e benzina 69

<i>APRILIA - RUBINETTI</i>69	<i>MBK</i>74
<i>APRILIA - SONDE</i>69	<i>MINARELLI</i>74
<i>ASPES</i>70	<i>MORINI</i>74
<i>BENASSI</i>70	<i>MOTOM</i>74
<i>BENELLI</i>70	<i>MOTORI AGRICOLI</i>74
<i>BETAMOTOR</i>70	<i>MOTO GUZZI</i>
<i>CAGIVA</i>70	<i>RUBINETTI</i>74
<i>CICLOMOTORI VARI</i>70	<i>MOTO GUZZI</i>
<i>CIMATTI</i>71	<i>SONDE</i>75
<i>DEMM</i>71	<i>NEGRINI</i>75
<i>DERBI</i>71	<i>PERIPOLI</i>75
<i>DKW</i>71	<i>PEUGEOT</i>75
<i>DUCATI</i>71	<i>PIAGGIO CICLOMOTORI</i> ...76
<i>FANTIC</i>71	<i>PIAGGIO SCOOTER</i>76
<i>GARELLI</i>71	<i>PIAGGIO VESPA</i>76
<i>GILERA</i>71	<i>PIAGGIO APE</i>77
<i>HONDA</i>72	<i>PUCH</i>77
<i>HUSQVARNA</i>72	<i>RIZZATO</i>77
<i>INNOCENTI</i>72	<i>SACHS</i>77
<i>ITALJET</i>72	<i>SEP</i>77
<i>KTM</i>73	<i>SWM</i>77
<i>KYMCO</i>73	<i>TOMOS</i>77
<i>LAVERDA</i>73	<i>VOLPI E BOTTOLI</i>77
<i>MALAGUTI</i>73	<i>YAMAHA</i>77
<i>MALANCA</i>73	<i>ZUNDAPP</i>77

Figurato rubinetti benzina 78

Figurato sonde livello benzina e olio 83

Tabella applicazioni paraoli forcella "Vesrah" 84

<i>APRILIA</i>84	<i>KYMCO</i>95
<i>BMW</i>85	<i>MALAGUTI</i>96
<i>BUELL</i>85	<i>MOTO MORINI</i>96
<i>CAGIVA</i>85	<i>MOTO GUZZI</i>96
<i>DERBI</i>85	<i>PEUGEOT</i>96
<i>DUCATI</i>85	<i>PIAGGIO</i>96
<i>GILERA</i>86	<i>SUZUKI</i>97
<i>HONDA</i>86	<i>TRIUMPH</i>100
<i>HUSQVARNA</i>91	<i>YAMAHA</i>100
<i>KAWASAKI</i>92	

All Balls: presentazione. 104

Tabella applicazioni All Balls. 108

APRILIA.....108	KAWASAKI.....140
BETA.....108	KTM.....152
BMW.....110	MOTO GUZZI.....164
BUELL.....112	MONTESA HONDA.....164
CAGIVA.....112	SHERCO.....166
DUCATI.....112	SUZUKI.....166
GAS GAS.....114	TRIUMPH.....178
HONDA.....116	TM.....180
HUSABERG.....130	VICTORY.....182
HUSQVARNA.....132	YAMAHA.....184
HYOSUNG.....140	

Tabella paraoli per misura e profilo 196

Cuscinetti “NTN” e “Nachi” 198

PREFISSI E SUFFISSI.....198

Tabella applicazioni trasmissioni flessibiligas
starter-freno-contakm.-contagiri 200

APRILIA SCOOTER.....200	MBK.....210
APRILIA CICLOMOTORI	MOTO GUZZI.....211
E MOTO.....202	PEUGEOT.....212
BENELLI.....202	PIAGGIO SCOOTER.....213
BETAMOTOR.....202	PIAGGIO VESPA - COSA...220
BSV.....202	PIAGGIO APE.....221
CAGIVA.....202	PIAGGIO
DERBI.....203	MINIVETTURE.....221
DUCATI.....203	RIZZATO.....221
GILERA.....203	SUZUKI.....222
HONDA.....205	SYM.....222
INNOCENTI.....205	TGB.....223
ITALJET.....206	YAMAHA SCOOTER.....224
KYMCO.....206	YAMAHA MOTO.....226
MALAGUTI.....208	

Trasmissioni freno a mano, frizione,
cambio, retromarcia, avviamento,
adattabili “Piaggio Vespa-Ape” 227

TRASMISSIONI FRENO A MANO.....227
TRASMISSIONI FRIZIONE.....227
TRASMISSIONI CAMBIO.....227
TRASMISSIONI RETROMARCIA.....227
TRASMISSIONI COMANDO AVVIAMENTO.....227

Tappi al serbatoio. 228

Indice codice articolo 229

Tabella applicazioni ammortizzatori "SEBAC"

Applicazioni c.c. marca/modello	anno	confez.	Original	H.P. 76 High Performance	H.P. 77 High Performance	H.P. 78 High Performance	int. mm.	riferimento originale
			idraulico originale	idraulico rinforzato c/regolazione molla molla bianca	gas c/regolazione molla	gas c/regolazione molla e ritorno molla cromata		

POSTERIORI

BETA

50 Tempo 16	94/99	singolo			29.7700	29.7803	250	1003430000
-------------	-------	---------	--	--	---------	---------	-----	------------

HONDA

50 Dio GP	91/>	singolo			29.7700	29.7803	250	
50 50/80 NH Lead	87/95	singolo	29.7404				280	52400GC8612

KYMC0

50 DJ Y • DJ W	94/00	singolo			29.7700	29.7803	250	00166815
50 KB • K12	98/00	singolo			29.7700	29.7803	250	00166815
50 ZX Fever/Euro 2	99/07	singolo			29.7700	29.7803	250	00166815

ITALJET

50 Bazooka	91/>	singolo			29.7700	29.7803	250	9500118
50 Pista 1	</95	singolo			29.7700	29.7803	250	3331410
50 Pista 2	95/96	singolo			29.7700	29.7803	250	3351408
50 Yankee	95/96	singolo			29.7700	29.7803	250	3351408
50 Reporter 1/2	90/>	singolo			29.7700	29.7803	250	9500118

MALAGUTI

50 F10 Jetline/Euro 2/AC	92/09	singolo			29.7700	29.7803	250	01004605
50 F12 Phantom Euro 2	94/06	singolo			29.7700	29.7803	250	01003408
50 Yesterday	97/00	singolo			29.7700	29.7803	250	01004605

MBK

50 Booster/Road/Rocket/NG/Spirit	90/05	singolo			29.7700	29.7803	250	4VUF221000
50 CT S/SS Sorriso	91/94	singolo			29.7700	29.7803	250	1NTF221001
50 Evolis	92/95	singolo			29.7700	29.7803	250	4JCF221000
50 Forte	94/96	singolo			29.7700	29.7803	250	4PCF221001
50 Target	91/95	singolo			29.7700	29.7803	250	3NWF221001

PEUGEOT

50 SC Metropolis	91/>	singolo	29.7404				280	704950
50 Squab	95/97	singolo		29.7601	29.7701		265	732711N
50 ST Rapido	85/93	singolo	29.7404				280	724714
50 Zenith L/N/LN/LS	94/98	singolo			29.7700	29.7803	250	729965

PIAGGIO

125 Hexagon/LX 2T	94/99	singolo				29.7809	400	563855
150 Hexagon	94/97	singolo				29.7809	400	563855
180 Hexagon LXT 2T	98/99	singolo				29.7809	400	563855
220 APE TM P 602	82/83	singolo	29.7462				260	646466
220 APE TM P 703/V/FL/FL2	84/05	singolo	29.7462				260	646466
420 APE TM P 703 DIESEL	87/04	singolo	29.7462				260	646466
420 APE TM D LCS DIESEL	05/07	singolo	29.7462				260	646466

Applicazioni c.c. marca/modello	anno	confez.	Original	H.P. 76 High Performance	H.P. 77 High Performance	H.P. 78 High Performance	int. mm.	riferimento originale
			idraulico originale	idraulico rinforzato c/regolazione molla molla bianca	gas c/regolazione molla molla cromata	gas c/regolazione molla e ritorno molla cromata		

YAMAHA

50 Axis	95/96	singolo				29.7700	29.7803	250	4PCF221001
50 CT S/SS	90/95	singolo				29.7700	29.7803	250	1NTF221001
50 CR Z	91/95	singolo				29.7700	29.7803	250	1NTF221001
50 BW'S/Next Gen./Original/Euro2	97/09	singolo				29.7700	29.7803	250	4VUF221000

Figurato ammortizzatori "Sebac"

29.7404 molla nera



Honda • Peugeot
724714/724715

29.7462 s/molla



Piaggio
2426944

Serie H.P. 77 - molla cromata
idraulici a gas c/reg. molla

29.7700 - 250 mm.
(Piaggio/Gilera)



Serie H.P. 78 - molla cromata
idraulici a gas c/reg. molla
e ritorno

29.7803 - 250 mm.
29.7809 - 400 mm.
(Piaggio)



Forcelle idrauliche per scooter

Cod. SGR	Descrizione	Applicazione
29.5926 *	forcella completa hydro-plus	Peugeot Trekker On Road 50/100

* Non di produzione Sebac

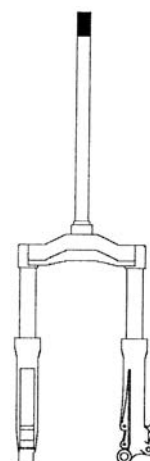

Ammortizzatori Piaggio Vespa/Piaggio Ape - Innocenti Lambretta

Applicazioni cc marca/modello	anno	ANTERIORI			POSTERIORI				
		SGR anteriore standard	SGR anteriore "Classic"	YSS anteriore rinforzato	SGR posteriore standard	SGR posteriore "Classic"	SGR posteriore rinforzato	YSS posteriore Gas	YSS post. Gas c/serbatoio
PIAGGIO VESPA									
50 Vespa/N (V5A1)	63/71				29.86562✱	29.65511❖	29.86551D	29.401220X	29.401319✓
50 Vespa L (V5A1-500001>)	66/70	29.86453■	29.64531❖	29.401007▲	29.86562✱	29.65511❖	29.86551D	29.401220X	29.401319✓
50 Vespa R (V5A1-700001>)	69/83	29.86453■	29.64531❖	29.401007▲	29.86562✱	29.65511❖	29.86551D	29.401220X	29.401319✓
50 Vespa Elestart	70/76	29.86453■	29.64531❖	29.401007▲	29.86562✱	29.65511❖	29.86551D	29.401220X	29.401319✓
50 Vespa S (V5SA1)	63/>	29.86453■	29.64531❖	29.401007▲	29.86562✱	29.65511❖	29.86551D	29.401220X	29.401319✓
50 Vespa Special	70/83	29.86453■	29.64531❖	29.401007▲	29.86562✱	29.65511❖	29.86551D	29.401220X	29.401319✓
50 Vespa Special Revival	91	29.86453■	29.64531❖	29.401007▲	29.86562✱	29.65511❖	29.86551D	29.401220X	29.401319✓
50 Vespa SS Super Sprint	66/71	29.86453■	29.64531❖	29.401007▲	29.86562✱	29.65511❖	29.86551D	29.401220X	29.401319✓
50 Vespa SS Sprinter (V5SS2)	71/73	29.86453■	29.64531❖	29.401007▲	29.86562✱	29.65511❖	29.86551D	29.401220X	29.401319✓
50 Vespa PK (V5X1)	82/85	29.86453■	29.64531❖	29.401007▲	29.86553✱	29.65531◆			29.401319✓
50 Vespa PK S (V5X2)	82/85	29.86453■	29.64531❖	29.401007▲	29.86553✱	29.65531◆			29.401319✓
50 Vespa PK SS (V5S1)	82/85	29.86453■	29.64531❖	29.401007▲	29.86553✱	29.65531◆			29.401319✓
50 Vespa PK S Automatica	84/89	29.86453■	29.64531❖	29.401007▲					29.401319✓
50 Vespa PK XL (V5X3)	85/88	29.86453■	29.64531❖	29.401007▲	29.86553✱	29.65531◆			29.401319✓
50 Vespa PK XLS (V5S2)	86/90	29.86453■	29.64531❖	29.401007▲	29.86553✱	29.65531◆			29.401319✓
50 Vespa PK XL Plurimatic	85/90	29.86453■	29.64531❖	29.401007▲					29.401319✓
50 Vespa PK XL Rush (V5X4)	88/89	29.86464□			29.86553✱	29.65531◆			29.401319✓
50 Vespa PK N (V5X5)	89/90	29.86464□			29.86553✱	29.65531◆			29.401319✓
50 Vespa PK N Speedmatic	90	29.86464□							29.401319✓
50 Vespa PK FL (V5N1)	90	29.86464□			29.86553✱	29.65531◆			29.401319✓
50 Vespa PK FL2 Automatica	90/91	29.86464□							29.401319✓
50 Vespa PK FL2 HP (V5N2)	91/97			29.401002▲	29.86553✱	29.65531◆			29.401319✓
90 Vespa (V9A1)	63/>	29.86453■	29.64531❖	29.401007▲	29.86562✱	29.65511❖	29.86551D	29.401220X	29.401319✓
90 Vespa SS Racer (V9SS2)	71/73	29.86453■	29.64531❖	29.401007▲	29.86562✱	29.65511❖	29.86551D	29.401220X	29.401319✓
90 Vespa SS SuperSprint	65/71	29.86453■	29.64531❖	29.401007▲	29.86562✱	29.65511❖	29.86551D	29.401220X	29.401319✓
125 Vespa (VN1/VN2)	54/57	29.86450■							
125 Vespa (VNA1/VNA2)	58/59	29.86450■				29.65611◆			
125 Vespa (VNB1/VNB3)	59/62	29.86450■				29.65611◆			
125 Vespa (VNB4 <0114713)	63	29.86450■				29.65611◆			
125 Vespa (VNB4 0114714>)	63	29.86450■			29.86562✱	29.65511❖	29.86551D	29.401220X	29.401319✓
125 Vespa (VNB5/VNB6)	63/66	29.86450■			29.86562✱	29.65511❖	29.86551D	29.401220X	29.401319✓
125 Vespa/Primavera (VMA)	65/83	29.86453■	29.64531❖	29.401007▲	29.86562✱	29.65511❖	29.86551D	29.401220X	29.401319✓
125 Vespa ET3 (VMB)	75/83	29.86453■	29.64531❖	29.401007▲	29.86562✱	29.65511❖	29.86551D	29.401220X	29.401319✓
125 Vespa GT (VNL2-3001>)	66/73	29.86450■			29.86562✱	29.65511❖	29.86551D	29.401220X	29.401319✓
125 Vespa GTR	69/78	29.86450■			29.86562✱	29.65511❖	29.86551D	29.401220X	29.401319✓
125 Vespa Super (VNC1)	66/68	29.86450■			29.86562✱	29.65511❖	29.86551D	29.401220X	29.401319✓
125 Vespa TS (VNL3)	75/78	29.86450■			29.86562✱	29.65511❖	29.86551D	29.401220X	29.401319✓
125 Vespa P ETS (VMS1)	84/>	29.86464□				29.65531◆			29.401319✓
125 Vespa PK (VMX1)	82/85	29.86464□				29.65531◆			29.401319✓
125 Vespa PK S (VMX5)	82/85	29.86464□				29.65531◆			29.401319✓
125 Vespa PK S Automatica	84/89	29.86464□							29.401319✓
125 Vespa PK XL (VMX6)	86/89	29.86464□				29.65531◆			29.401319✓
125 Vespa PK XL Plurimatic	87/90	29.86464□							29.401319✓
125 Vespa PK FL (VMX7)	89/91	29.86464□				29.65531◆			29.401319✓
125 Vespa PK FL Automatica	90/91	29.86464□							29.401319✓
125 Vespa PX Arcobaleno	77/97	29.86462■	29.64631❖	29.86463 D	29.86562✱	29.65511❖	29.86551D	29.401220X	29.401319✓
125 Vespa PX	98/01	29.87442●			29.86562✱	29.65511❖	29.86551D	29.401220X	29.401319✓

■ copripolvere grigio in plastica - □ copripolvere grigio/molla nera (■ e □ senza regolazione molla)
 ● cromato/molla nera s/regolazione molla - ✱ senza molla - D nero/molla rossa c/regolazione molla - D zincato bianco/molla grigia s/reg. molla
 ❖ tipo "Classic" grigio/molla grigia rinforzato c/regolazione molla - ◆ tipo "Classic" nero/molla nera rinforzato s/regolazione molla
 ♪ tipo "Classic Lusso" interasse 315 mm. nero/molla nera rinf. s/reg. molla - ♪ tipo "Classic Lusso" interasse 300 mm. nero/molla nera rinf. s/reg. molla
 ▲ YSS idraulico corpo nero/molla bianca c/reg. molla - X YSS Gas oro/molla nera c/reg. molla - ✓ YSS Gas c/serbatoio oro/molla nera c/reg. molla

VESPA APE LAMBRETTA

Applicazioni cc marca/modello	anno	ANTERIORI			POSTERIORI				
		SGR anteriore standard	SGR anteriore "Classic"	YSS anteriore rinforzato	SGR posteriore standard	SGR posteriore "Classic"	SGR posteriore rinforzato	YSS posteriore Gas	YSS post. Gas c/serbatoio
125 Vespa PX Euro 2	01/07	29.87442●			29.86562✱	29.65511❖	29.86551▶	29.401220✕	29.401319✓
125 Vespa PX 30 Anni	07/08	29.87442●			29.86562✱	29.65511❖	29.86551▶	29.401220✕	29.401319✓
125 Vespa PX	11/13	29.87442●			29.86562✱	29.65511❖	29.86551▶	29.401220✕	29.401319✓
125 Vespa PX T5	85/89	29.86462■	29.64631❖	29.86463 ▶	29.86562✱	29.65511❖	29.86551▶	29.401220✕	29.401319✓
150 Vespa (VL1/VL2/VL3)	55/56	29.86450■							
150 Vespa (VB1)	57/58	29.86450■							
150 Vespa (VBA)	58/60	29.86450■				29.65611◆			
150 Vespa (VBB1)	60/62	29.86450■				29.65611◆			
150 Vespa (VBB2)	63/67	29.86450■				29.65611◆			
150 Vespa GL (VLA1)	63/64	29.86450■				29.65611◆			
150 Vespa GL (export)	59/62	29.86450■				29.65611◆			
150 Vespa GS (VS1/VS5)	55/61	29.86450■							
150 Vespa Super (VBC1)	66/79	29.86450■			29.86562✱	29.65511❖	29.86551▶	29.401220✕	29.401319✓
150 Vespa Sprint (VLB1)	65/74	29.86450■			29.86562✱	29.65511❖	29.86551▶	29.401220✕	29.401319✓
150 Vespa Sprint Veloce	69/79	29.86450■			29.86562✱	29.65511❖	29.86551▶	29.401220✕	29.401319✓
150 Vespa P-S (VBX1)	78/>	29.86450■			29.86562✱	29.65511❖	29.86551▶	29.401220✕	29.401319✓
150 Vespa PX Arcobaleno	77/97	29.86462■	29.64631❖	29.86463 ▶	29.86562✱	29.65511❖	29.86551▶	29.401220✕	29.401319✓
150 Vespa PX	98/01	29.87442●			29.86562✱	29.65511❖	29.86551▶	29.401220✕	29.401319✓
150 Vespa PX	11/13	29.87442●			29.86562✱	29.65511❖	29.86551▶	29.401220✕	29.401319✓
160 Vespa GS (VSB1)	62/64				29.86562✱	29.65511❖	29.86551▶	29.401220✕	29.401319✓
180 Vespa Super Sport (VSC1)	65/68				29.86562✱	29.65511❖	29.86551▶	29.401220✕	29.401319✓
180 Vespa Rally (VSD1)	68/73	29.86450■			29.86562✱	29.65511❖	29.86551▶	29.401220✕	29.401319✓
200 Vespa Rally (VSE1)	72/79	29.86450■			29.86562✱	29.65511❖	29.86551▶	29.401220✕	29.401319✓
200 Vespa PX Arcobaleno	77/97	29.86462■	29.64631❖	29.86463 ▶	29.86562✱	29.65511❖	29.86551▶	29.401220✕	29.401319✓
200 Vespa PX	98/01	29.87442●			29.86562✱	29.65511❖	29.86551▶	29.401220✕	29.401319✓

PIAGGIO APE

50 Ape TL1 fino a telaio 13564	69				29.6566 ✱				
50 Ape TL1 da telaio 13565	70/71	29.6460 ✱			29.6566 ✱				
50 Ape/P/TMP/FL/FL2	71/95	29.6460 ✱			29.6566 ✱				
50 Ape FL3 Europa/N.U.	96/99	29.6460 ✱			29.6566 ✱				
50 Ape Cross FL3/Mix/Euro 2	96/13	29.6460 ✱			29.6566 ✱				
50 Ape Mix	99/03	29.6460 ✱			29.6566 ✱				
50 Ape Mix/Top Euro 2	03/13	29.6460 ✱			29.6566 ✱				
125 Ape 250 (TM1)	70/74	29.6460 ✱			29.6566 ✱				
125 Ape 350 (AE0)	65/71	29.86450■							
150 Ape "C" (AC1/AC4)	56/66	29.86450■							
175 Ape "D" 450/500 (AD)	64/74	29.86450■							
150 Ape 400 (AE1/AE2)	65/73	29.86450■							
175 Ape 400/R/P401 (AE3)	70/81	29.86450■							
175 Ape Pentarò (APB/APC)	61/68	29.86450■							
190 Ape MP 500 (MPR1)	69/78	29.6456 ✱			29.6564 ✱				
190 Ape MP 550 (MPA1)	67/72	29.6456 ✱			29.6564 ✱				
190 Ape MP 600 (MPM1)	70/78	29.6456 ✱			29.6564 ✱				
190 Ape MPV 600 (MPV1)	69/78	29.6456 ✱			29.6564 ✱				
190 Ape MP P 501 (MPR2)	78/93	29.6456 ✱			29.6564 ✱				
190 Ape MP P 601 (MPM1)	78/87	29.6456 ✱			29.6564 ✱				
190 Ape MP P 601V (MPV1)	78/87	29.6456 ✱			29.6564 ✱				
200 Ape Calessino (City)	13/14				29.6564 ✱				
220 Ape MP P 601 (MPM2)	78/88	29.6456 ✱			29.6564 ✱				

■ copripolvere grigio in plastica - □ copripolvere grigio/molla nera (■ e □ senza regolazione molla)

● cromato/molla nera s/regolazione molla - ✱ senza molla - ▶ nero/molla rossa c/regolazione molla - ◆ zincato bianco/molla grigia s/reg. molla

❖ tipo "Classic" grigio/molla grigia rinforzato c/regolazione molla - ◆ tipo "Classic" nero/molla nera rinforzato s/regolazione molla

♣ tipo "Classic Lusso" interasse 315 mm. nero/molla nera rinf. s/reg. molla - ♣ tipo "Classic Lusso" interasse 300 mm. nero/molla nera rinf. s/reg. molla

▲ YSS idraulico corpo nero/molla bianca c/reg. molla - ✕ YSS Gas oro/molla nera c/reg. molla - ✓ YSS Gas c/serbatoio oro/molla nera c/reg. molla

Applicazioni cc marca/modello	anno	ANTERIORI			POSTERIORI				
		SGR anteriore standard	SGR anteriore "Classic"	YSS anteriore rinforzato	SGR posteriore standard	SGR posteriore "Classic"	SGR posteriore rinforzato	YSS posteriore Gas	YSS post. Gas c/serbatoio
220 Ape MP P 601V(MPV2)	78/88	29.6456 ✱			29.6564 ✱				
220 Ape Car/P2/P3 (AF1/AF5)	72/86	29.6459 ✱			29.6564 ✱				
220 Ape TM P 602 (ATM1)	82/83	29.6465 ✱			29.7462 ✱				
220 Ape TM P 703/V/FL/FL2	84/05	29.6466 ✱			29.7462 ✱				
220 Ape TM Benzina	09/13	29.6466 ✱			29.7462 ✱				
420 Ape Calessino/VME Diesel	07/13				29.6564 ✱				
420 Ape Car Diesel	86/88	29.6466 ✱							
420 Ape Max Diesel	88/96	29.6466 ✱							
420 Ape TM P 703/V Diesel	87/04	29.6466 ✱			29.7462 ✱				
420 Ape TM D LCS Diesel	05/13	29.6466 ✱			29.7462 ✱				

INNOCENTI LAMBRETTA

125 Lambretta LI II serie	59/61					29.6559 ⁹			
125 Lambretta LI III serie	61/67				29.86559 ¹	29.65591 ⁹			
125 Lambretta LI Special	65/69				29.86559 ¹	29.65591 ⁹			
125 Lambretta DL (GP125)	69/71				29.86559 ¹	29.65591 ⁹			
150 Lambretta LI II serie	59/61					29.65592 ⁹			
150 Lambretta LI III serie	62/67				29.86559 ¹	29.65591 ⁹			
150 Lambretta LI Special	63/66				29.86559 ¹	29.65591 ⁹			
150 Lambretta SX	66/69				29.86559 ¹	29.65591 ⁹			
150 Lambretta DL (GP150)	69/71				29.86559 ¹	29.65591 ⁹			
175 Lambretta TV II serie	59/61	29.86451 [■]				29.65592 ⁹			
175 Lambretta TV III serie	62/67	29.86451 [■]			29.86559 ¹	29.65591 ⁹			
200 Lambretta TV (GT200)	63/65	29.86451 [■]			29.86559 ¹	29.65591 ⁹			
200 Lambretta DL (GP200)	69/71	29.86451 [■]			29.86559 ¹	29.65591 ⁹			
200 Lambretta SX	66/68	29.86451 [■]			29.86559 ¹	29.65591 ⁹			

■ copripolvere grigio in plastica - □ copripolvere grigio/molla nera (■ e □ senza regolazione molla)
 ● cromato/molla nera s/regolazione molla - ✱ senza molla - 1 nero/molla rossa c/regolazione molla - 2 zincato bianco/molla grigia s/reg. molla
 ❖ tipo "Classic" grigio/molla grigia rinforzato c/regolazione molla - ◆ tipo "Classic" nero/molla nera rinforzato s/regolazione molla
 9 tipo "Classic Lusso" interasse 315 mm. nero/molla nera rinf. s/reg. molla - 9 tipo "Classic Lusso" interasse 300 mm. nero/molla nera rinf. s/reg. molla
 ▲ YSS idraulico corpo nero/molla bianca c/reg. molla - ✱ YSS Gas oro/molla nera c/reg. molla - ✓ YSS Gas c/serbatoio oro/molla nera c/reg. molla

Figurato ammortizz. Piaggio Vespa/Piaggio Ape - Innocenti Lambretta

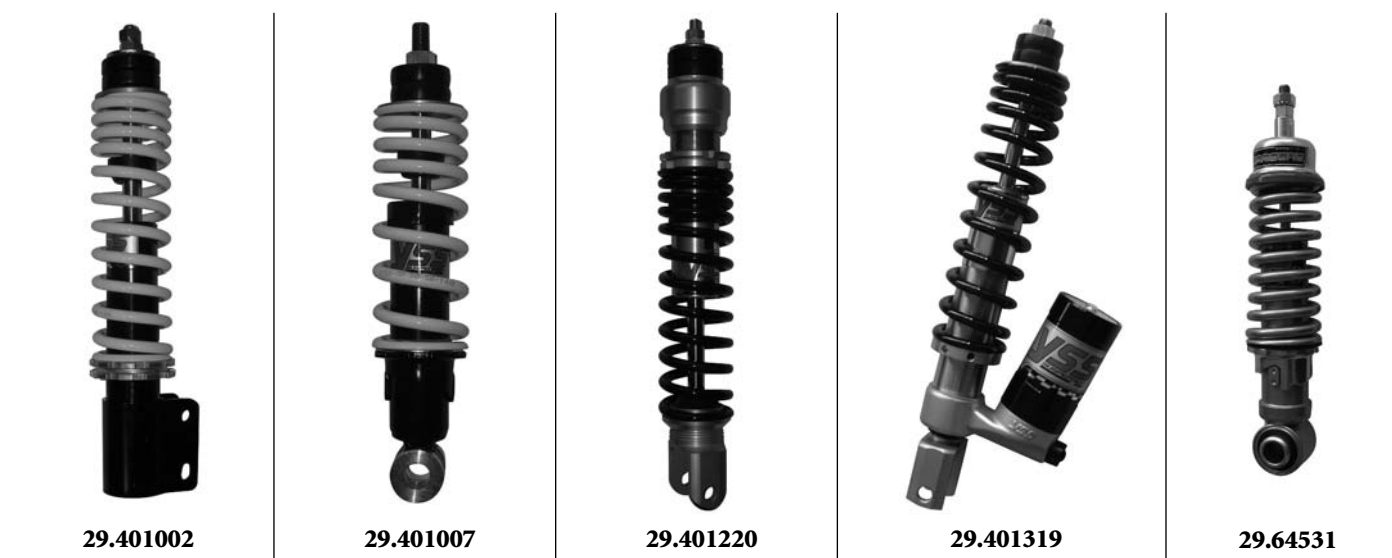



29.65456



29.6459



29.6460



29.64631



29.6465



29.6466



48
29.65511



48
29.65531



300
29.65591



315
29.65592



44
29.65611



29.6564



29.6566



29.86450



29.86451



29.86453



29.86462



29.86463



29.86464



48
29.86551



29.86553



29.86559



48
29.86562



29.87442

Tabella applicazioni ammortizzatori scooter

Applicazioni cc. marca/modello	anno	confezione	SGR	SGR	YSS Pro-X	YSS OE-302	YSS OC-302	Forza C-35	Forza GT-36
			idraulico s/regolazione molla	idraulico rinforzato c/regol. molla	idraulico c/regolaz. molla molla bianca corpo nero	gas c/regolaz. molla molla nera corpo oro	gas c/reg. molla c/serbatoio molla nera corpo oro	gas c/regolazione molla	gas rinforzato c/regol. molla

ANTERIORI

ITALJET

50 Dragster	99/03	sg			29.401008	29.401408			
125 Dragster	99/03	sg			29.401008	29.401408			
180 Dragster	99/03	sg			29.401008	29.401408			

PEUGEOT

50 Speedfight Air/LC/Cat	97/04	sg			29.401005				
50 Speedfight 2 Silversport	05/>	sg			29.401004				
50 Speedfight 2 WRC	05/>	sg			29.401004				
50 Speedfight 2 Air	05/>	sg			29.401004				
50 X-Race	03/>	sg			29.401004				
50 X-Fight	00/>	sg			29.401004				
100 X-Fight	00/>	sg			29.401004				
100 Speedfight	97/>	sg			29.401004				
100 Speedfight 2 Silversport	05/>	sg			29.401004				
100 Speedfight 2 WRC	05/>	sg			29.401004				

PIAGGIO

50 Quartz	92/96	sg			29.401002				
50 Sfera Rst	95/97	sg			29.401002				
50 Vespa FL2 HP	91/97	sg			29.401002				
50 Vespa ET2/ie	97/05	sg			29.401002				
50 Vespa ET4	00/05	sg			29.401002				
50 Vespa LX 2T/4T/FL	05/13	sg			29.401002				
50 Vespa LX 4T-4V	09/13	sg			29.401002				
50 Vespa LX Touring 2T/4T	10/13	sg			29.401002				
50 Vespa LXV 2T/Navy	06/10	sg			29.401002				
50 Vespa S 2T/College	07/13	sg			29.401002				
50 Vespa S 4T-4V/Sport	08/13	sg			29.401002				
50 Zip SP	96/00	sg			29.401001				
50 Zip SP	01/10	sg			29.401002				
125 Hexagon 2T	94/97	sg	29.87536 ●		29.401006				
125 Hexagon LX 2T	98/99	sg	29.87536 ●		29.401006				
125 Hexagon LX4 4T	98/99	sg	29.87536 ●		29.401006				
125 Hexagon GTX 4T	00	sg	29.87536 ●		29.401006				
125 Sfera FL 4T	95/97	sg			29.401002				
125 Skipper 2T	94/97	sg			29.401002				
125 Vespa ET4	96/05	sg			29.401002				
125 Vespa LX/Euro3/FL/ie	05/13	sg			29.401002				
125 Vespa LX 4T-3V ie	12/13	sg			29.401002				
125 Vespa LX Touring i.e.	10/13	sg			29.401002				
125 Vespa LXV Euro3/Navy/ie	06/12	sg			29.401002				
125 Vespa S Euro 3	07/10	sg			29.401002				
125 Vespa S ie/College/Sport	10/13	sg			29.401002				
125 Vespa S 4T-3V ie	12/13	sg			29.401002				
125 Vespa Granturismo	03/08	sg	29.87461 ●		29.401003				
125 Vespa GTS/Euro3	07/12	sg	29.87461 ●		29.401003				

▼ molla bianca - ● molla nera - ▸ molla grigia - ▹ molla gialla
 Confezione: sg = singolo • cp = coppia • sx = sinistro • dx = destro

Applicazioni cc. marca/modello	anno	confezione	SGR	SGR	YSS Pro-X	YSS OE-302	YSS OC-302	Forza C-35	Forza GT-36
			idraulico s/regolazione molla	idraulico rinforzato c/regol. molla	idraulico c/regolaz. molla	gas c/regolaz. molla	gas c/reg. molla c/serbatoio	gas c/regolazione molla	gas rinforzato c/regol. molla
					molla bianca corpo nero	molla nera corpo oro	molla nera corpo oro		
125 Vespa GTS Super ie	09/13	sg	29.87461 ●		29.401003				
125 Vespa GTV/Navy	07/09	sg	29.87461 ●		29.401003				
125 Zip 4 Tempi	00/01	sg			29.401002				
150 Hexagon 2T	94/97	sg	29.87536 ●		29.401006				
150 Skipper 2T	94/97	sg			29.401002				
150 Vespa ET4	99/05	sg			29.401002				
150 Vespa LX/Euro3/FL/ie	05/13	sg			29.401002				
150 Vespa LX Touring ie	10/13	sg			29.401002				
150 Vespa S Euro 3	07/10	sg			29.401002				
150 Vespa S ie/College/Sport	10/13	sg			29.401002				
150 Vespa S 4T-3V ie	12/13	sg			29.401002				
180 Hexagon LX 2T	98/99	sg	29.87536 ●		29.401006				
180 Hexagon GTX 4T	00	sg	29.87536 ●		29.401006				
200 Vespa Granturismo	03/08	sg	29.87461 ●		29.401003				
250 Hexagon GT/GTX	98/>	sg	29.87536 ●		29.401006				
250 Vespa GTS/Euro3	05/13	sg	29.87461 ●		29.401003				
250 Vespa GTV/Navy	06/09	sg	29.87461 ●		29.401003				
250 Vespa GT60	06/08	sg	29.87461 ●		29.401003				
300 Vespa GTS/Touring ie	10/13	sg	29.87461 ●		29.401003				
300 Vespa GTS Super ie	08/13	sg	29.87461 ●		29.401003				
300 Vespa GTS SuperSport ie	10/13	sg	29.87461 ●		29.401003				
300 Vespa GTV ie	10/13	sg	29.87461 ●		29.401003				
300 Vespa GTV M.Napoleone	10/13	sg	29.87461 ●		29.401003				

POSTERIORI

APRILIA

50 Amico LX/Sport/Cat	92/93	sg			29.401103	29.401203	29.401303		
50 Amico/GL/GLE	93/98	sg	29.87416 ▶	29.87603 ▼	29.401105	29.401205	29.401305	29.35832 ▼	
50 Habana/Custom	99/03	sg	29.87416 ▶	29.87603 ▼	29.401105	29.401205	29.401305	29.35832 ▼	
50 Mojito Retro'/Custom	99/03	sg	29.87416 ▶	29.87603 ▼	29.401105	29.401205	29.401305	29.35832 ▼	
50 Rally Air/LC	94/04	sg	29.87416 ▶	29.87603 ▼	29.401105	29.401205	29.401305	29.35832 ▼	
50 Scarabeo 2T (M.Minarelli)	93/05	sg	29.87416 ▶	29.87603 ▼	29.401105	29.401205	29.401305	29.35832 ▼	
50 Scarabeo 2T (M.Piaggio)	05/06	sg		29.7545 ●	29.401115	29.401215	29.401315		
50 Scarabeo 2T Rst/Net	06/13	sg		29.7545 ●	29.401115	29.401215	29.401315		
50 Scarabeo Di-Tech	01/04	sg	29.87479 ●		29.401107	29.401207	29.401307		
50 Scarabeo 4 Tempi/Rst	02/09	sg		29.7545 ●	29.401115	29.401215	29.401315		
50 Scarabeo 4T-4V/Net	09/13	sg		29.7545 ●	29.401115	29.401215	29.401315		
50 SR Air/LC/Replica	93/96	sg	29.87416 ▶	29.87603 ▼	29.401105	29.401205	29.401305	29.35832 ▼	
50 SR Europe/Esquire/Sunfire	93/96	sg	29.87416 ▶	29.87603 ▼	29.401105	29.401205	29.401305	29.35832 ▼	
50 SR UrbanKid/Viper/Wave	93/96	sg	29.87416 ▶	29.87603 ▼	29.401105	29.401205	29.401305	29.35832 ▼	
50 SR WWW	97/02	sg	29.87416 ▶	29.87603 ▼	29.401105	29.401205	29.401305	29.35832 ▼	
50 SR Netscaper/Stealth	97/99	sg	29.87416 ▶	29.87603 ▼	29.401105	29.401205	29.401305	29.35832 ▼	
50 SR Racing (M.Minarelli)	97/99	sg	29.87416 ▶	29.87603 ▼	29.401105	29.401205	29.401305	29.35832 ▼	
50 SR Racing/Sport (M.Aprilia)	97/03	sg	29.87416 ▶	29.87603 ▼	29.401105	29.401205	29.401305	29.35832 ▼	
50 SR Di-Tech/E2 (M.Aprilia)	00/04	sg	29.87416 ▶	29.87603 ▼	29.401105	29.401205	29.401305	29.35832 ▼	
50 SR NewDi-Tech (M.Aprilia)	04/06	sg	29.87416 ▶	29.87603 ▼	29.401105	29.401205	29.401305	29.35832 ▼	
50 SR R Factory ie (M.Aprilia)	04/06	sg	29.87416 ▶	29.87603 ▼	29.401105	29.401205	29.401305	29.35832 ▼	
50 SR R (M.Piaggio)	04/14	sg						29.35841 ▼	
50 SR R Factory ie (M.Piaggio)	04/14	sg						29.35841 ▼	
50 SR Street (M.Piaggio)	03/13	sg						29.35841 ▼	
50 SR Street ie (M.Piaggio)	03/13	sg						29.35841 ▼	
50 SR Motard 2T	12/13	sg			29.401121				

▼ molla bianca - ● molla nera - ▶ molla grigia - ▸ molla gialla
 Confezione: sg = singolo • cp = coppia • sx = sinistro • dx = destro

Applicazioni cc. marca/modello	anno	confezione	SGR	SGR	YSS Pro-X	YSS OE-302	YSS OC-302	Forza C-35	Forza GT-36
			idraulico s/regolazione molla	idraulico rinforzato c/regol. molla	idraulico c/regolaz. molla	gas c/regolaz. molla	gas c/reg. molla c/serbatoio	gas c/regolazione molla	gas rinforzato c/regol. molla
					molla bianca corpo nero	molla nera corpo oro	molla nera corpo oro		
50 Sonic/LC/GP	98/08	sg	29.87416 ▶	29.87603 ▼	29.401105	29.401205	29.401305	29.35832 ▼	
50 Sport City One 2T	08/13	sg			29.401121				
50 Sport City One 4T	08/13	sg			29.401121				
100 Scarabeo 2T	00/>	sg	29.87416 ▶	29.87603 ▼	29.401105	29.401205	29.401305	29.35832 ▼	
100 Scarabeo 4T/Rst/Net	01/13	sg		29.7550 ●					
125 Atlantic/Euro3	03/13	sg							29.36931 ●
125 Leonardo	96/97	dx							29.36960 ●
125 Leonardo	96/97	sx							29.369601 ●
125 Leonardo	96/97	cp			29.402105	29.402205			
125 Leonardo/ST	98/04	cp			29.402107	29.402207			
125 Scarabeo (Mot.Rotax)	99/03	sg			29.401114		29.401314		29.36928 ●
125 Scarabeo (Mot.Piaggio)	03/07	sg			29.401114				29.36928 ●
125 SportCity/Euro3	04/08	dx						29.35838 ●	
125 SportCity/Euro3	04/08	sx						29.358381 ●	
125 SportCity/Euro3	04/08	cp			29.402112	29.402212	29.402312		
125 SportCity Cube	08/13	dx						29.35838 ●	
125 SportCity Cube	08/13	sx						29.358381 ●	
125 SportCity Cube	08/13	cp			29.402112	29.402212	29.402312		
150 Leonardo	96/97	dx							29.36960 ●
150 Leonardo	96/97	sx							29.369601 ●
150 Leonardo	96/97	cp			29.402105	29.402205			
150 Leonardo/ST	98/04	cp			29.402107	29.402207			
150 Scarabeo (Mot.Rotax)	99/03	sg			29.401114		29.401314		29.36928 ●
200 Atlantic	03/05	sg							29.36931 ●
200 Scarabeo (Mot.Rotax)	99/03	sg			29.401114		29.401314		29.36928 ●
200 Scarabeo (Mot.Piaggio)	03/07	sg			29.401114				29.36928 ●
200 SportCity/Euro3	04/08	dx						29.35838 ●	
200 SportCity/Euro3	04/08	sx						29.358381 ●	
200 SportCity/Euro3	04/08	cp			29.402112	29.402212	29.402312		
200 SportCity Cube	08/12	dx						29.35838 ●	
200 SportCity Cube	08/12	sx						29.358381 ●	
200 SportCity Cube	08/12	cp			29.402112	29.402212	29.402312		
250 Atlantic/Euro3	03/09	sg							29.36931 ●
250 Leonardo/ST	99/04	dx							29.36960 ●
250 Leonardo/ST	99/04	sx							29.369601 ●
250 Leonardo/ST	99/04	cp			29.402105	29.402205			
250 Scarabeo/GT	04/06	sg							29.36928 ●
250 Scarabeo Light	06/09	dx						29.35838 ●	
250 Scarabeo Light	06/09	sx						29.358381 ●	
250 Scarabeo Light	06/09	cp			29.402112	29.402212	29.402312		
250 SportCity Euro3	06/08	dx						29.35838 ●	
250 SportCity Euro3	06/08	sx						29.358381 ●	
250 SportCity Euro3	06/08	cp			29.402112	29.402212	29.402312		
250 SportCity Cube	08/12	dx						29.35838 ●	
250 SportCity Cube	08/12	sx						29.358381 ●	
250 SportCity Cube	08/12	cp			29.402112	29.402212	29.402312		
300 Atlantic	10/13	sg							29.36931 ●
300 Leonardo	04/06	dx							29.36960 ●
300 Leonardo	04/06	sx							29.369601 ●
300 Leonardo	04/06	cp			29.402105	29.402205			
300 Scarabeo Light/Special	09/13	dx						29.35838 ●	
300 Scarabeo Light/Special	09/13	sx						29.358381 ●	
300 Scarabeo Light/Special	09/13	cp			29.402112	29.402212	29.402312		

▼ molla bianca - ● molla nera - ▶ molla grigia - ◀ molla gialla
 Confezione: sg = singolo • cp = coppia • sx = sinistro • dx = destro

SCOOTER

Applicazioni cc. marca/modello	anno	confezione	SGR	SGR	YSS Pro-X	YSS OE-302	YSS OC-302	Forza C-35	Forza GT-36
			idraulico s/regolazione molla	idraulico rinforzato c/regol. molla	idraulico c/regolaz. molla molla bianca corpo nero	gas c/regolaz. molla molla nera corpo oro	gas c/reg. molla c/serbatoio molla nera corpo oro	gas c/regolazione molla	gas rinforzato c/regol. molla
300 SportCity Cube	08/13	dx						29.35838 ●	
300 SportCity Cube	08/13	sx						29.358381 ●	
300 SportCity Cube	08/13	cp			29.402112	29.402212	29.402312		
500 Atlantic	01/04	sg							29.36973 ●

ATALA-RIZZATO

50 Hacker/LC		sg			29.401101				
50 Carosello		sg	29.87602 ▼	29.401104	29.401204	29.401304	29.35945 ▼		

BENELLI

50 491 GT/SP	98/02	sg	29.87416 ▶	29.87603 ▼	29.401105	29.401205	29.401305	29.35832 ▼	
50 491 Sport/ST	98/02	sg	29.87416 ▶	29.87603 ▼	29.401105	29.401205	29.401305	29.35832 ▼	
50 K2 Air/LC	98/>	sg			29.401108	29.401208		29.35857	
50 Naked (M.Minarelli)	02	sg			29.401108	29.401208		29.35857	
100 K2	98/>	sg			29.401108	29.401208		29.35857	
125 Velvet	99/06	cp			29.402119		29.402319		
150 Velvet	99/06	cp			29.402119		29.402319		
400 Velvet	03/04	cp			29.402119		29.402319		

BETA

50 Ark Air/LC/LC K	96/13	sg	29.87479		29.401107	29.401207	29.401307		
50 Chrono 502	95/99	sg			29.401103	29.401203	29.401303		
50 Eikon	99/>	sg	29.87479		29.401107	29.401207	29.401307		
50 Tempo 16	94/99	sg	29.87406 ●	29.7532 ▼	29.401102	29.401202	29.401302	29.35947 ▼	
50 Quadra	95/99	sg			29.401103	29.401203	29.401303		

BMW

125 C1	00/03	sg		29.87448 ●					
125 C1	00/03	dx							29.36943 ●
125 C1	00/03	sx							29.369431 ●
200 C1	00/03	sg		29.87448 ●					
200 C1	00/03	dx							29.36943 ●
200 C1	00/03	sx							29.369431 ●

DERBI

50 Sonar 2T	10/12	sg	29.87430 ●		29.401111	29.401211	29.401311	29.35966 ▼	29.36936 ●
50 Variant Sport 2T	12/13	sg			29.401121				
125 Boulevard/Euro 3	02/07	sg			29.401110	29.401210			
125 Rambla	08/12	dx						29.35838 ●	
125 Rambla	08/12	sx						29.358381 ●	
125 Rambla	08/12	cp			29.402112	29.402212	29.402312		
150 Boulevard/Euro 3	02/07	sg			29.401110	29.401210			
200 Boulevard	05/06	sg			29.401110	29.401210			
250 Rambla	08/09	dx						29.35838 ●	
250 Rambla	08/09	sx						29.358381 ●	
250 Rambla	08/09	cp			29.402112	29.402212	29.402312		
300 Rambla	10/12	dx						29.35838 ●	
300 Rambla	10/12	sx						29.358381 ●	
300 Rambla	10/12	cp			29.402112	29.402212	29.402312		

Applicazioni cc. marca/modello	anno	confezione	SGR	SGR	YSS Pro-X	YSS OE-302	YSS OC-302	Forza C-35	Forza GT-36
			idraulico s/regolazione molla	idraulico rinforzato c/regol. molla	idraulico c/regolaz. molla molla bianca corpo nero	gas c/regolaz. molla molla nera corpo oro	gas c/reg. molla c/serbatoio molla nera corpo oro	gas c/regolazione molla	gas rinforzato c/regol. molla

GILERA

50 ICE	01/05	sg							29.36950 ●
50 Runner/FL/Poggiali	97/02	sg	29.87428 ●		29.401111	29.401211	29.401311	29.35834 ▼	
50 Runner SP	00/04	sg	29.87428 ●		29.401111	29.401211	29.401311	29.35834 ▼	
50 Runner PureJet	02/04	sg	29.87428 ●		29.401111	29.401211	29.401311	29.35834 ▼	
50 Stalker 50/Naked/Special	97/12	sg		29.7540 ▼					
50 Storm/Euro2	94/08	sg	29.87428 ●		29.401111	29.401211	29.401311	29.35834 ▼	
50 Typhoon/X/XR	94/00	sg	29.87428 ●		29.401111	29.401211	29.401311	29.35834 ▼	
125 Runner FX/SP 2T	97/02	sg							29.36934 ●
125 Runner VX/SC/ST/Race	01/12	cp			29.402110	29.402210	29.402310		
125 Runner VX/SC/ST/Race	01/12	sg		29.87459 ▶					
180 Runner FXR/SP 2T	97/02	sg							29.36934 ●
180 Runner VXR 4T	01/02	cp			29.402110	29.402210	29.402310		
180 Runner VXR 4T	01/02	sg		29.87459 ▶					
200 Runner VXR/ST/Race	03/12	cp			29.402110	29.402210	29.402310		
200 Runner VXR/ST/Race	03/12	sg		29.87459 ▶					

HONDA

50 SJ Bali	93/02	sg						29.35890 ▼	
50 Dio GP	91/>	sg			29.401102	29.401202	29.401302	29.35826 ▼	
50 SK M Dio/SR/SP (SC01)	91/00	sg			29.401103	29.401203	29.401303		
50 Dio ZX	91/97	sg			29.401108			29.35890 ▼	
50 NH Lead	87/95	sg		29.87602 ▼	29.401104	29.401204	29.401304		
50 SA Vision	88/93	sg	29.87403 ●	29.87603 ▼	29.401105	29.401205	29.401305		
50 SKY/De Luxe (SGX)	97/02	sg		29.87602 ▼	29.401104	29.401204	29.401304	29.35818 ▼	
50 SH	91/95	cp			29.402116				
50 SH	96/02	sg			29.401105			29.35816 ▼	
50 SFX	95/02	sg		29.87602 ▼	29.401104	29.401204	29.401304	29.35931 ▼	
50 SXR	97/02	sg		29.87602 ▼	29.401104	29.401204	29.401304	29.35931 ▼	
50 X8R S/X (SZX)	97/02	sg						29.35956 ▼	
50 ZX	91/97	sg			29.401108			29.35890 ▼	
80 NH Lead 2T	87/95	sg		29.87602 ▼	29.401104	29.401204	29.401304		
100 SCV Lead 4T	03/07	sg						29.35846	
100 SJ Bali/EX	96/01	sg						29.35890 ▼	
100 SH	96/01	sg						29.35816 ▼	
125 Chiocciola@	00/06	cp			29.402101	29.402201	29.402301		
125 Chiocciola@	00/06	dx						29.35817 ●	
125 Chiocciola@	00/06	sx						29.358171 ●	
125 Dylan	02/06	cp			29.402101	29.402201	29.402301		
125 Dylan	02/06	dx						29.35817 ●	
125 Dylan	02/06	sx						29.358171 ●	
125 Pantheon 2T	98/02	sg			29.401116	29.401216	29.401316		
125 Pantheon 4T	03/06	cp			29.402109	29.402209			
125 PCX	10/13	cp				29.402213	29.402313		
125 PS i	06/13	cp			29.402101	29.402201	29.402301		
125 PS i	06/13	dx						29.35817 ●	
125 PS i	06/13	sx						29.358171 ●	
125 SH/ie	01/08	cp			29.402101	29.402201	29.402301		
125 SH/ie DD	09/12	cp			29.402101				
125 SH/ie/DD	01/12	dx						29.35817 ●	
125 SH/ie/DD	01/12	sx						29.358171 ●	
125 S-Wing	07/13	cp			29.402109	29.402209			

▼ molla bianca - ● molla nera - ▶ molla grigia - ◀ molla gialla
 Confezione: sg = singolo • cp = coppia • sx = sinistro • dx = destro

SCOOTER

Applicazioni cc. marca/modello	anno	confezione	SGR	SGR	YSS Pro-X	YSS OE-302	YSS OC-302	Forza C-35	Forza GT-36
			idraulico s/regolazione molla	idraulico rinforzato c/regol. molla	idraulico c/regolaz. molla	gas c/regolaz. molla	gas c/reg. molla c/serbatoio	gas c/regolazione molla	gas rinforzato c/regol. molla
					molla bianca corpo nero	molla nera corpo oro	molla nera corpo oro		
150 Chiocciola@	00/06	cp			29.402101	29.402201	29.402301		
150 Chiocciola@	00/06	dx						29.35817 ●	
150 Chiocciola@	00/06	sx						29.358171 ●	
150 Dylan	02/06	cp			29.402101	29.402201	29.402301		
150 Dylan	02/06	dx						29.35817 ●	
150 Dylan	02/06	sx						29.358171 ●	
150 Pantheon 2T	98/02	sg			29.401116	29.401216	29.401316		
150 Pantheon 4T	03/06	cp			29.402109	29.402209			
150 PCX	12/13	cp				29.402213	29.402313		
125 PS i	06/13	cp			29.402101	29.402201	29.402301		
125 PS i	06/13	dx						29.35817 ●	
125 PS i	06/13	sx						29.358171 ●	
150 SH/ie	01/08	cp			29.402101	29.402201	29.402301		
150 SH/ie DD	09/12	cp			29.402101				
150 SH/ie/DD	01/12	dx						29.35817 ●	
150 SH/ie/DD	01/12	sx						29.358171 ●	
150 S-Wing	07/13	cp			29.402109	29.402209			
250 Foresight	98/05	sg			29.401116	29.401216	29.401316		
250 Forza X/EX	05/07	cp			29.402114				
250 JAZZ	01/05	cp			29.402114				
300 SH / R /Sporty ie	07/13	cp			29.402114	29.402214	29.402314		
400 FJS Silver Wing/SW-T	06/13	cp				29.402215			
600 FJS Silver Wing/SW-T	01/13	cp				29.402215			

ITALJET

50 Bazooka	91/>	sg	29.87406 ●	29.7532 ▼	29.401102	29.401202	29.401302	29.35947 ▼	
50 Cruise	90/>	sg			29.401101				
50 Dragster	99/00	sg			29.401117	29.401217			
50 Formula/LC	94/00	sg			29.401102	29.401202	29.401302		
50 Pista 1	</95	sg	29.87406 ●	29.7532 ▼	29.401102	29.401202	29.401302	29.35947 ▼	
50 Pista 2	95/96	sg	29.87406 ●	29.7532 ▼	29.401102	29.401202	29.401302	29.35947 ▼	
50 Partner	90/>	sg	29.87416 ▶	29.87603 ▼	29.401105	29.401205	29.401305	29.35832 ▼	
50 Torpedo (Mot.F.Morini)	97/99	sg	29.87416 ▶	29.87603 ▼	29.401105	29.401205	29.401305	29.35832 ▼	
50 Reporter 1/2	90/>	sg	29.87406 ●	29.7532 ▼	29.401102	29.401202	29.401302	29.35947 ▼	
50 Scoop 2/3		sg			29.401108	29.401208		29.35857 ▼	
50 Velocifero	93/99	sg			29.401103	29.401203	29.401303		
50 Yankee	95/96	sg	29.87406 ●	29.7532 ▼	29.401102	29.401202	29.401302	29.35947 ▼	
125 Dragster	99/00	sg			29.401115	29.401215	29.401315		
125 Formula	97/01	sg			29.401102	29.401202	29.401302		
125 Jet Set	01/03	sg			29.401110	29.401210			
125 Jupiter	01/03	cp			29.402103	29.402203			
125 Jupiter	01/03	dx							29.36948 ●
125 Jupiter	01/03	sx							29.369481 ●
125 Torpedo	98/00	sg						29.35966 ▼	29.36936 ▼
125 Torpedo (Mot.Leader)	00/03	sg			29.401118	29.401218	29.401318		
150 Jet Set	01/03	sg			29.401110	29.401210			
150 Jupiter	01/03	cp			29.402103	29.402203			
150 Jupiter	01/03	dx							29.36948 ●
150 Jupiter	01/03	sx							29.369481 ●
150 Torpedo	00/03	sg			29.401118	29.401218	29.401318		
180 Dragster	99/00	sg			29.401115	29.401215	29.401315		
250 Jupiter	01/03	cp			29.402105				
250 Jupiter	01/03	dx							29.36948 ●
250 Jupiter	01/03	sx							29.369481 ●

▼ molla bianca - ● molla nera - ▶ molla grigia - ◀ molla gialla
 Confezione: sg = singolo • cp = coppia • sx = sinistro • dx = destro

Applicazioni cc. marca/modello	anno	confezione	SGR	SGR	YSS Pro-X	YSS OE-302	YSS OC-302	Forza C-35	Forza GT-36
			idraulico s/regolazione molla	idraulico rinforzato c/regol. molla	idraulico c/regolaz. molla molla bianca corpo nero	gas c/regolaz. molla molla nera corpo oro	gas c/reg. molla c/serbatoio molla nera corpo oro	gas c/regolazione molla	gas rinforzato c/regol. molla

KYMCO

50 Agility R12/RS 4T/Carry	05/13	sg							29.36954 ●
50 Agility R16 4T	08/13	sg			29.401107	29.401207	29.401307		
50 CX/CX Super	93/97	sg			29.401103	29.401203	29.401303		
50 DJ X	91/92	sg			29.401102	29.401202	29.401302	29.35826 ▼	
50 DJ Y - 50 DJ W	93/00	sg			29.401103	29.401203	29.401303		
50 Dink Air/LC 2T	98/02	sg	29.87416 ▶	29.87603 ▼	29.401105	29.401205	29.401305	29.35961 ▼	
50 Dink Classic/E2 2T	02/07	sg	29.87416 ▶	29.87603 ▼	29.401105	29.401205	29.401305	29.35961 ▼	
50 Filly 4T	98/00	sg			29.401103	29.401203	29.401303		
50 Gran Dink 2T	05/12	sg	29.87416 ▶	29.87603 ▼	29.401105	29.401205	29.401305	29.35961 ▼	
50 Heroism	95/97	sg	29.87416 ▶	29.87603 ▼	29.401105	29.401205	29.401305	29.35832 ▼	
50 KB - K12	98/00	sg			29.401103	29.401203	29.401303		
50 People/Euro2 2T	99/13	sg	29.87479		29.401107	29.401207	29.401307		
50 People S 4T	05/13	sg			29.401106	29.401206	29.401306		
50 Sniper/DD	93/96	sg	29.87479		29.401107	29.401207	29.401307		
50 Top Boy	97/>	sg	29.87416 ▶	29.87603 ▼	29.401105	29.401205	29.401305	29.35961 ▼	
50 ZX Fever	99/07	sg			29.401103	29.401203	29.401303		
100 Top Boy	97/>	sg	29.87416 ▶	29.87603 ▼	29.401105	29.401205	29.401305	29.35961 ▼	
125 Agility R16	08/13	cp			29.402104	29.402204	29.402304		
125 Dink	97/98	sg		29.87602 ▼	29.401104	29.401204			
125 Dink LX/Classic/Euro2	98/07	sg		29.87602 ▼	29.401104	29.401204			
125 Dink Euro 3	06/13	dx						29.35993 ●	29.36966 ●
125 Dink Euro 3	06/13	sx						29.359931 ●	29.369661 ●
125 DownTown ie	09/13	cp			29.402114	29.402214	29.402314		
125 Gran Dink/Euro2/Euro3	01/09	dx							29.36960 ●
125 Gran Dink/Euro2/Euro3	01/09	sx							29.369601 ●
125 Gran Dink/Euro2/Euro3	01/09	cp			29.402105	29.402205	29.402305		
125 People/Euro 2/Euro 3	99/13	cp			29.402116	29.402216	29.402316		
125 People S/DD Euro3	05/13	cp			29.402104	29.402204	29.402304		
150 Agility R16	08/13	cp			29.402104	29.402204	29.402304		
150 Dink	97/98	sg		29.87602 ▼	29.401104	29.401204			
150 Dink LX/Classic/Euro2	98/07	sg		29.87602 ▼	29.401104	29.401204			
150 Gran Dink/Euro2/Euro3	01/09	dx							29.36960 ●
150 Gran Dink/Euro2/Euro3	01/09	sx							29.369601 ●
150 Gran Dink/Euro2/Euro3	01/09	cp			29.402105	29.402205	29.402305		
200 Agility ie R16	10/13	cp			29.402104	29.402204	29.402304		
200 Dink Classic/Euro2	04/07	sg		29.87602 ▼	29.401104	29.401204			
200 Dink ie Euro 3	06/13	dx						29.35993 ●	29.36966 ●
200 Dink ie Euro 3	06/13	sx						29.359931 ●	29.369661 ●
200 DownTown ie	10/12	cp			29.402114	29.402214	29.402314		
200 People S/ie	05/12	cp			29.402104	29.402204	29.402304		
200 People GT i	10/13	cp			29.402114	29.402214	29.402314		
250 Gran Dink/Euro2/Euro3	02/09	cp			29.402102	29.402202			
250 People LC	03/05	cp			29.402109	29.402209			
250 People S/S i	06/08	cp			29.402108				
250 X Citing/i	05/08	cp			29.402114	29.402214	29.402314		
300 DownTown ie	09/13	cp			29.402114	29.402214	29.402314		
300 People S i	08/12	cp			29.402108				
300 People GT i / ABS	10/13	cp			29.402114	29.402214	29.402314		
300 X Citing i/R	08/13	cp			29.402114	29.402214	29.402314		
500 X Citing i/R	05/13	cp			29.402114	29.402214	29.402314		

▼ molla bianca - ● molla nera - ▶ molla grigia - ◀ molla gialla
 Confezione: sg = singolo • cp = coppia • sx = sinistro • dx = destro

Applicazioni cc. marca/modello	anno	confezione	SGR	SGR	YSS Pro-X	YSS OE-302	YSS OC-302	Forza C-35	Forza GT-36
			idraulico s/regolazione molla	idraulico rinforzato c/regol. molla	idraulico c/regolaz. molla molla bianca corpo nero	gas c/regolaz. molla molla nera corpo oro	gas c/reg. molla c/serbatoio molla nera corpo oro	gas c/regolazione molla	gas rinforzato c/regol. molla

MALAGUTI

50 Centro/SL/Cat. 2T	93/00	sg			29.401101				
50 Centro/SL 4T	08/11	sg			29.401121				
50 Ciak 2T/Master/Euro2	99/08	sg		29.87602 ▼	29.401104	29.401204	29.401304	29.35945 ▼	
50 Crosser	95/>	sg			29.401102	29.401202	29.401302	29.35826 ▼	
50 DVD	10/11	sg		29.87603 ▼	29.401106	29.401206	29.401306		
50 F10 Jetline/Euro2	92/07	sg	29.87406 ●	29.7532 ▼	29.401102	29.401202	29.401302	29.35947 ▼	
50 F10 Jetline AC/AC ECO	08/11	sg	29.87406 ●	29.7532 ▼	29.401102	29.401202	29.401302	29.35947 ▼	
50 F12 Phantom/LC/Euro2	94/07	sg			29.401102	29.401202	29.401302	29.35826 ▼	
50 F12 R Phantom LC	08/11	sg		29.87602 ▼	29.401104	29.401204	29.401304	29.35945 ▼	
50 F12 R Phantom AC	08/11	sg		29.87602 ▼	29.401104	29.401204	29.401304	29.35945 ▼	
50 F15 Firefox/Euro2	96/08	sg			29.401108	29.401208		29.35857 ▼	
50 Yesterday	97/>	sg	29.87406 ●	29.7532 ▼	29.401102	29.401202	29.401302	29.35947 ▼	
125 F12 Phantom MAX	03/>	sg		29.87448 ●					29.36943 ●
125 F12 Phantom MAX	03/>	dx							29.369431 ●
125 F12 Phantom MAX	03/>	sx							29.369431 ●
125 F18 Warrior	00/>	cp			29.402101	29.402201	29.402301		
125 F18 Warrior	00/>	dx						29.35817 ●	
125 F18 Warrior	00/>	sx						29.358171 ●	
125 Madison (Mot.Minarelli)	99/05	sg		29.87448 ●					
125 Madison (Mot.Minarelli)	99/05	dx							29.36943 ●
125 Madison (Mot.Minarelli)	99/05	sx							29.369431 ●
150 F18 Warrior	00/>	cp			29.402101	29.402201	29.402301		
150 F18 Warrior	00/>	dx						29.35817 ●	
150 F18 Warrior	00/>	sx						29.358171 ●	
150 Madison T	99/01	sg		29.87448 ●					
150 Madison T	99/01	dx							29.36943 ●
150 Madison T	99/01	sx							29.369431 ●
180 Madison R (Mot.Piaggio)	01/02	sg							29.36957 ●
180 Madison R (Mot.Piaggio)	01/02	cp			29.402117	29.402217	29.402317		
200 Madison S (Mot.Piaggio)	02/03	sg							29.36957 ●
200 Madison S (Mot.Piaggio)	02/03	cp			29.402117	29.402217	29.402317		
200 F12 Phantom MAX	03/>	sg							29.36957 ●
200 F12 Phantom MAX	03/>	cp			29.402117	29.402217	29.402317		
250 Madison S (M.Yamaha)	99/03	sg		29.87448 ●					
250 Madison S (M.Yamaha)	99/03	dx							29.36943 ●
250 Madison S (M.Yamaha)	99/03	sx							29.369431 ●
250 Madison RS (Mot.Piaggio)	04/05	sg							29.36957 ●
250 Madison RS (Mot.Piaggio)	04/05	cp			29.402117	29.402217	29.402317		
250 F12 Phantom MAX	04/05	sg							29.36957 ●
250 F12 Phantom MAX	04/05	cp			29.402117	29.402217	29.402317		

MBK

50 Booster/Road	90/95	sg	29.87406 ●	29.7532 ▼	29.401102	29.401202	29.401302	29.35947 ▼	
50 Booster Rocket	95/96	sg	29.87406 ●	29.7532 ▼	29.401102	29.401202	29.401302	29.35947 ▼	
50 Booster NG	96/05	sg	29.87406 ●	29.7532 ▼	29.401102	29.401202	29.401302	29.35947 ▼	
50 Booster Spirit	96/05	sg	29.87406 ●	29.7532 ▼	29.401102	29.401202	29.401302	29.35947 ▼	
50 CT S/SS Sorriso	91/94	sg	29.87406 ●	29.7532 ▼	29.401102	29.401202	29.401302	29.35947 ▼	
50 Evolis	92/95	sg	29.87406 ●	29.7532 ▼	29.401102	29.401202	29.401302	29.35947 ▼	
50 Flipper	98/05	sg	29.87416 ▶	29.87603 ▼	29.401105	29.401205	29.401305	29.35832 ▼	
50 Forte	94/96	sg	29.87406 ●	29.7532 ▼	29.401102	29.401202	29.401302	29.35947 ▼	
50 Mach-G	02/04	sg						29.35848 ▼	

▼ molla bianca - ● molla nera - ▶ molla grigia - ▶ molla gialla
 Confezione: sg = singolo • cp = coppia • sx = sinistro • dx = destro

Applicazioni cc. marca/modello	anno	confezione	SGR	SGR	YSS Pro-X	YSS OE-302	YSS OC-302	Forza C-35	Forza GT-36
			idraulico s/regolazione molla	idraulico rinforzato c/regol. molla	idraulico c/regolaz. molla	gas c/regolaz. molla	gas c/reg. molla c/serbatoio	gas c/regolazione molla	gas rinforzato c/regol. molla
					molla bianca corpo nero	molla nera corpo oro	molla nera corpo oro		
50 New Sorriso	95/96	sg			29.401101				
50 Nitro	97/05	sg		29.87602 ▼	29.401104	29.401204	29.401304	29.35945 ▼	
50 Ovetto	97/05	sg		29.87602 ▼	29.401104	29.401204	29.401304	29.35945 ▼	
50 Target	91/95	sg	29.87406 ●	29.7532 ▼	29.401102	29.401202	29.401302	29.35947 ▼	
50 Stunt	00/>	sg	29.87479 ●		29.401107	29.401207	29.401307		
100 Nitro	00/>	sg		29.87602 ▼	29.401104	29.401204	29.401304	29.35945 ▼	
100 Ovetto	00/>	sg		29.87602 ▼	29.401104	29.401204	29.401304	29.35945 ▼	
100 Booster	99/>	sg		29.87602 ▼	29.401104	29.401204	29.401304	29.35945 ▼	
125 Doodo	00/>	sg							29.36954 ●
125 XC T Flame	95/99	dx						29.35993 ●	29.36966 ●
125 XC T Flame	95/99	sx						29.359931 ●	29.369661 ●
125 XC K Flame R	96/99	dx						29.35993 ●	29.36966 ●
125 XC K Flame R	96/99	sx						29.359931 ●	29.369661 ●
125 XC Flame F	00/03	dx						29.35993 ●	29.36966 ●
125 XC Flame F	00/03	sx						29.359931 ●	29.369661 ●
125 Skyliner	98/05	cp			29.402103	29.402203			
125 Skyliner	98/05	dx							29.36948 ●
125 Skyliner	98/05	sx							29.369481 ●
125 Thunder	01/>	dx							29.36953 ●
125 Thunder	01/>	sx							29.369531 ●
150 Doodo	01/>	sg							29.36954 ●
150 Skyliner	00/02	cp			29.402103	29.402203			
150 Thunder	01/>	dx							29.36953 ●
150 Thunder	01/>	sx							29.369531 ●
180 Skyliner	03/05	cp			29.402103	29.402203			
250 Skyliner	00/05	dx							29.36960 ●
250 Skyliner	00/05	sx							29.369601 ●
250 Skyliner	00/05	cp			29.402105				
300 Kilibre	03/05	dx							29.36955 ●
300 Kilibre	03/05	sx							29.369551 ●

PEUGEOT

50 Buxy/RS	94/97	sg		29.87602 ▼	29.401104	29.401204	29.401304		
50 Elyseo	99/>	sg						29.35958 ▼	
50 Elystar TDSI	03/>	sg						29.35958 ▼	
50 Looxor/TDSI	01/>	sg						29.35939 ▼	
50 Ludix Blaster SP (R10)	05/>	sg	29.87479 ●		29.401107	29.401207	29.401307		
50 Ludix Blaster RS12	09/>	sg	29.87479 ●		29.401107	29.401207	29.401307		
50 Ludix 10 One/Dual Seat	04/>	sg	29.87479 ●		29.401107	29.401207	29.401307		
50 Ludix 10 Trend/Snake	04/>	sg	29.87479 ●		29.401107	29.401207	29.401307		
50 Ludix 10 Urban Track	06/>	sg	29.87479 ●		29.401107	29.401207	29.401307		
50 Ludix 14 Classic	04/>	sg	29.87479 ●		29.401107	29.401207	29.401307		
50 Metal-X	02/>	sg			29.401103	29.401203	29.401303		
50 SC Metropolis	91/>	sg		29.87602 ▼	29.401104	29.401204	29.401304		
50 Speedake	95/97	sg		29.87602 ▼	29.401104	29.401204	29.401304	29.35932 ▼	
50 Speedfight Air/LC/Cat	97/04	sg			29.401103	29.401203	29.401303	29.35943 ▼	
50 Speedfight 2 Air	05/09	sg			29.401103	29.401203	29.401303	29.35943 ▼	
50 Speedfight 2 Silversport	05/09	sg			29.401103	29.401203	29.401303	29.35943 ▼	
50 Speedfight 2 WRC/R-Cup	05/09	sg			29.401103	29.401203	29.401303	29.35943 ▼	
50 Squab	95/97	sg			29.401103	29.401203	29.401303		
50 ST Rapido	85/93	sg		29.87602 ▼	29.401104	29.401204	29.401304		
50 SV Geo	91/95	sg		29.87603 ▼	29.401106	29.401206	29.401306		
50 TKR 2 LC WRC	04/>	sg			29.401103	29.401203	29.401303		

▼ molla bianca - ● molla nera - ▸ molla grigia - ▹ molla gialla
 Confezione: sg = singolo • cp = coppia • sx = sinistro • dx = destro

Applicazioni cc. marca/modello	anno	confezione	SGR	SGR	YSS Pro-X	YSS OE-302	YSS OC-302	Forza C-35	Forza GT-36
			idraulico s/regolazione molla	idraulico rinforzato c/regol. molla	idraulico c/regolaz. molla	gas c/regolaz. molla	gas c/reg. molla c/serbatoio	gas c/regolazione molla	gas rinforzato c/regol. molla
					molla bianca corpo nero	molla nera corpo oro	molla nera corpo oro		
50 TKR Furious	04/>	sg			29.401103	29.401203	29.401303		
50 Trekker On/Off Road	98/>	sg			29.401103	29.401203	29.401303		
50 X-Fight	00/>	sg			29.401103	29.401203	29.401303	29.35943 ▼	
50 X-Race	03/>	sg			29.401103	29.401203	29.401303	29.35943 ▼	
50 V-Click	07/>	sg		29.87603 ▼	29.401106	29.401206	29.401306		
50 Vivacity/Cat/VSX/XR	99/>	sg			29.401103	29.401203	29.401303	29.35943 ▼	
50 Vivacity 2 Sportline	99/>	sg			29.401103	29.401203	29.401303	29.35943 ▼	
50 Vivacity 2/2R Compact	99/>	sg			29.401103	29.401203	29.401303	29.35943 ▼	
50 Zenith L/N/LN/LS	94/98	sg	29.87406 ●	29.7532 ▼	29.401102	29.401202	29.401302	29.35947 ▼	
100 Elyseo	99/>	sg		29.87602 ▼	29.401104	29.401204	29.401304	29.35957 ▼	
100 Speedfight/2	97/>	sg			29.401103	29.401203	29.401303	29.35943 ▼	
100 Speedfight 2 WRC	00/>	sg			29.401103	29.401203	29.401303	29.35943 ▼	
100 Trekker On/Off Road	98/>	sg			29.401103	29.401203	29.401303	29.35943 ▼	
100 X-Fight	00/>	sg			29.401103	29.401203	29.401303	29.35943 ▼	
100 Vivacity	99/>	sg			29.401103	29.401203	29.401303	29.35943 ▼	
125 Elyseo	99/>	sg		29.87448 ●					
125 Elyseo	99/>	dx							29.36943 ●
125 Elyseo	99/>	sx							29.369431 ●
125 Elystar/IS2/ISU2/Advantage	02/>	sg		29.87448 ●					
125 Elystar/IS2/ISU2/Advantage	02/>	dx							29.36943 ●
125 Elystar/IS2/ISU2/Advantage	02/>	sx							29.369431 ●
125 Satelis - int.370mm	06/>	sg		29.87448 ●					
125 Satelis - int.370mm	06/>	dx							29.36943 ●
125 Satelis - int.370mm	06/>	sx							29.369431 ●
125 Satelis - int.370mm	06/>	cp				29.402220			
125 Satelis - int.385mm	06/>	dx							29.36955 ●
125 Satelis - int.385mm	06/>	sx							29.369551 ●
150 Elyseo	99/>	sg		29.87448 ●					
150 Elyseo	99/>	dx							29.36943 ●
150 Elyseo	99/>	sx							29.369431 ●
150 Elystar/IS2/ISU2/Advantage	02/>	sg		29.87448 ●					
150 Elystar/IS2/ISU2/Advantage	02/>	dx							29.36943 ●
150 Elystar/IS2/ISU2/Advantage	02/>	sx							29.369431 ●
250 SV	01/>	sg			29.401116	29.401216	29.401316		
400 Geopolis	07/>	sg							29.36965 ●

PIAGGIO

Liberty PPTT Elettrico 3,5cv	11/12	sg			29.401118	29.401218	29.401318		
50 Liberty 2T/Sport/Moc/Elle	97/13	sg	29.87430 ●		29.401111	29.401211	29.401311	29.35966 ▼	29.36936 ●
50 Liberty 2T PPTT Euro2	04/05	sg	29.87430 ●		29.401111	29.401211	29.401311	29.35966 ▼	29.36936 ●
50 Liberty 4T/Sport/Moc/Elle	00/13	sg	29.87452 ●		29.401112	29.401212			
50 NRG	94/95	sg	29.87428 ●		29.401111	29.401211	29.401311	29.35834 ▼	
50 NRG MC2/Extreme/MC3	96/04	sg	29.87428 ●		29.401111	29.401211	29.401311	29.35834 ▼	
50 NRG Purejet	02/04	sg	29.87428 ●		29.401111	29.401211	29.401311	29.35834 ▼	
50 NRG Power Purejet	04/08	sg	29.87428 ●		29.401111	29.401211	29.401311	29.35834 ▼	
50 NRG Power DD/DT	05/08	sg	29.87428 ●		29.401111	29.401211	29.401311	29.35834 ▼	
50 NTT	94/96	sg	29.87428 ●		29.401111	29.401211	29.401311	29.35834 ▼	
50 Quartz	92/96	sg	29.87428 ●		29.401111	29.401211	29.401311	29.35834 ▼	
50 Sfera/2/Rst	91/97	sg	29.87428 ●		29.401111	29.401211	29.401311	29.35834 ▼	
50 Typhoon	01/11	sg	29.87428 ●		29.401111	29.401211	29.401311	29.35834 ▼	
50 Vespa ET2/ie	97/05	sg	29.87428 ●		29.401111	29.401211	29.401311	29.35834 ▼	
50 Vespa ET4	00/05	sg	29.87428 ●		29.401111	29.401211	29.401311	29.35834 ▼	
50 Vespa LX 2T/4T	05/13	sg	29.87428 ●		29.401111	29.401211	29.401311	29.35834 ▼	
50 Vespa LX 4T-4V/Touring	12/13	sg	29.87428 ●		29.401111	29.401211	29.401311	29.35834 ▼	
50 Vespa LXV/Navy 2T	06/08	sg	29.87428 ●		29.401111	29.401211	29.401311	29.35834 ▼	

▼ molla bianca - ● molla nera - ◐ molla grigia - ◑ molla gialla
 Confezione: sg = singolo • cp = coppia • sx = sinistro • dx = destro

Applicazioni cc. marca/modello	anno	confezione	SGR	SGR	YSS Pro-X	YSS OE-302	YSS OC-302	Forza C-35	Forza GT-36
			idraulico s/regolazione molla	idraulico rinforzato c/regol. molla	idraulico c/regolaz. molla	gas c/regolaz. molla	gas c/reg. molla c/serbatoio	gas c/regolazione molla	gas rinforzato c/regol. molla
					molla bianca corpo nero	molla nera corpo oro	molla nera corpo oro		
50 Vespa S 2T/College/Sport	07/13	sg	29.87428 ●		29.401111	29.401211	29.401311	29.35834 ▼	
50 Vespa S 4T/4V/College	07/13	sg	29.87428 ●		29.401111	29.401211	29.401311	29.35834 ▼	
50 Zip Base/Fast Rider	92/96	sg	29.87453 ●		29.401109	29.401209	29.401309		
50 Zip Rst/Fast Rider Rst	96/99	sg	29.87453 ●		29.401109	29.401209	29.401309		
50 Zip Cat/Euro2	00/13	sg	29.87453 ●		29.401109	29.401209	29.401309		
50 Zip SP	96/13	sg	29.87428 ●		29.401111	29.401211	29.401311	29.35936 ▼	
50 Zip 4 Tempi	00/08	sg	29.87428 ●		29.401111	29.401211	29.401311	29.35936 ▼	
100 Zip 4 Tempi	00/08	sg	29.87428 ●		29.401111	29.401211	29.401311	29.35936 ▼	
125 Beverly/Rst/MIC EU3	01/10	sg							29.36957 ●
125 Beverly/Rst/MIC EU3	01/10	cp			29.402117	29.402217	29.402317		
125 Beverly Rst 4T-4V ie Euro3	10/13	sg							29.36957 ●
125 Beverly Rst 4T-4V ie Euro3	10/13	cp			29.402117	29.402217	29.402317		
125 Beverly Sport	07/09	sg							29.36957 ●
125 Beverly Sport	07/09	cp			29.402117	29.402217	29.402317		
125 Beverly Tourer EU3	08/10	sg							29.36957 ●
125 Beverly Tourer EU3	08/10	cp			29.402117	29.402217	29.402317		
125 Carnaby	07/12	sg							29.36957 ●
125 Carnaby	07/12	cp			29.402117	29.402217	29.402317		
125 Hexagon/LX 2T	94/99	sg	29.87435 ●		29.401113	29.401213			
125 Liberty	98/00	sg	29.87430 ●		29.401111	29.401211	29.401311	29.35966 ▼	29.36936 ●
125 Liberty/Rst/ie 2V MOC/Elle	01/12	sg			29.401118	29.401218	29.401318		
125 Liberty Sport/EU3	06/08	sg			29.401118	29.401218	29.401318		
125 Liberty Delivery EU3	08/09	sg			29.401118	29.401218	29.401318		
125 Liberty Rst PPTT	05/11	sg			29.401118	29.401218	29.401318		
125 Liberty PPTT ie	11/12	sg			29.401118	29.401218	29.401318		
125 Sfera FL 4T	95/97	sg	29.87428 ●		29.401111	29.401211	29.401311		29.36952 ●
125 Skipper LX 2T	98/99	sg	29.87428 ●		29.401111	29.401211	29.401311		29.36952 ●
125 Skipper ST 4T	00/05	sg			29.401110	29.401210			
125 Vespa ET4	96/99	sg	29.87428 ●		29.401111	29.401211	29.401311		29.36952 ●
125 Vespa ET4 (Mot.Leader)	00/05	sg			29.401110	29.401210			
125 Vespa GT/Granturismo/E3	03/08	cp			29.402111	29.402211			
125 Vespa GTS/Euro3	07/12	cp			29.402111	29.402211			
125 Vespa GTS Super ie	09/13	cp			29.402111	29.402211			
125 Vespa GTS SuperSport ie	09/13	cp			29.402111	29.402211			
125 Vespa GTV E3/Navy	07/09	cp			29.402111	29.402211			
125 Vespa LX/E3/FL/Touring/ie	05/12	sg			29.401110	29.401210			
125 Vespa LX 3V ie/Touring	12/13	sg			29.401110	29.401210			
125 Vespa LXV E3/Navy/ie	07/12	sg			29.401110	29.401210			
125 Vespa S Special/ie/College	07/12	sg			29.401110	29.401210			
125 Vespa S Special Sport ie	09/12	sg			29.401110	29.401210			
125 Vespa S Special ie 3V	12/13	sg			29.401110	29.401210			
125 X 7 Euro 3	08/09	cp			29.402118	29.402218	29.402318		
125 X 8/Euro2/3	04/08	cp			29.402118	29.402218	29.402318		
125 X 8 Premium	04/08	cp			29.402118	29.402218	29.402318		
125 X 9/Evolution	01/07	sg							29.36959 ●
125 X 9/Evolution	01/07	sg							29.36951 ●
125 X 9/Evolution	01/07	dx						29.35842 ●	
125 X 9/Evolution	01/07	sx						29.358421 ●	
125 X-EVO	07/08	cp			29.402118	29.402218	29.402318		
125 ZIP 4T	00/02	sg			29.401110	29.401210			
150 Hexagon 2T	94/97	sg	29.87435 ●		29.401113	29.401213			
150 Liberty/Rst/Sport/MOC/Elle	00/12	sg			29.401118	29.401218	29.401318		29.36968 ●
150 Skipper LX 2T	98/99	sg	29.87428 ●		29.401111	29.401211	29.401311		29.36952 ●
150 Skipper ST 4T	00/05	sg			29.401110	29.401210			
150 Vespa ET4	00/05	sg			29.401110	29.401210			

▼ molla bianca - ● molla nera - ▸ molla grigia - ▹ molla gialla
 Confezione: sg = singolo • cp = coppia • sx = sinistro • dx = destro

SCOOTER

Applicazioni cc. marca/modello	anno	confezione	SGR	SGR	YSS Pro-X	YSS OE-302	YSS OC-302	Forza C-35	Forza GT-36
			idraulico s/regolazione molla	idraulico rinforzato c/regol. molla	idraulico c/regolaz. molla	gas c/regolaz. molla	gas c/reg. molla c/serbatoio	gas c/regolazione molla	gas rinforzato c/regol. molla
					molla bianca corpo nero	molla nera corpo oro	molla nera corpo oro		
150 Vespa LX/E3/FL/Touring/ie	05/12	sg			29.401110	29.401210			
150 Vespa LX 3V ie/Touring	12/13	sg			29.401110	29.401210			
150 Vespa S Special/ie/College	07/12	sg			29.401110	29.401210			
150 Vespa S Special Sport ie	09/12	sg			29.401110	29.401210			
150 Vespa S Special ie 3V	12/13	sg			29.401110	29.401210			
180 Hexagon LXT 2T	98/99	sg	29.87435 ●		29.401113	29.401213			
180 X 9 Amalfi	01/02	sg							29.36959 ●
180 X 9 Amalfi	01/02	dx						29.35842 ●	
180 X 9 Amalfi	01/02	sx						29.358421 ●	
200 Beverly	01/03	sg							29.36957 ●
200 Beverly	01/03	cp			29.402117	29.402217	29.402317		
200 Carnaby	07/08	sg							29.36957 ●
200 Carnaby	07/08	cp			29.402117	29.402217	29.402317		
200 Liberty/Rst	04/08	sg			29.401118	29.401218	29.401318		
200 Liberty Sport	04/08	sg			29.401118	29.401218	29.401318		
200 Liberty Delivery	04/08	sg			29.401118	29.401218	29.401318		
200 X 8	04/06	cp			29.402118	29.402218	29.402318		
200 X 9/Evolution	02/05	sg							29.36951 ●
200 X 9/Evolution	02/05	sg							29.36959 ●
200 X 9/Evolution	02/05	dx						29.35842 ●	
200 X 9/Evolution	02/05	sx						29.358421 ●	
200 Vespa Granturismo	03/08	cp			29.402111	29.402211			
250 Beverly Rst/ie/EU3/MIC	04/09	sg							29.36957 ●
250 Beverly Rst/ie/EU3/MIC	04/09	cp			29.402117	29.402217	29.402317		
250 Beverly Sport	06/09	sg							29.36957 ●
250 Beverly Sport	06/09	cp			29.402117	29.402217	29.402317		
250 Beverly Tourer	08/09	sg							29.36957 ●
250 Beverly Tourer	08/09	cp			29.402117	29.402217	29.402317		
250 Beverly Cruiser	07/09	sg							29.36957 ●
250 Beverly Cruiser	07/09	cp			29.402117	29.402217	29.402317		
250 Carnaby	08/09	sg							29.36957 ●
250 Carnaby	08/09	cp			29.402117	29.402217	29.402317		
250 Vespa GTS/Euro3/ABS	05/13	cp			29.402111	29.402211			
250 Vespa GTV/Navy	06/10	cp			29.402111	29.402211			
250 Vespa GT60	06/08	cp			29.402111	29.402211			
250 X 7 Euro 3	08/09	cp			29.402118	29.402218	29.402318		
250 X 8/Euro 3	05/08	cp			29.402118	29.402218	29.402318		
250 X 9 (Mot.Honda)	00/03	dx							29.36938 ●
250 X 9 (Mot.Honda)	00/03	sx							29.369381 ●
250 X 9 Evolution	04/09	sg							29.36951 ●
250 X-EVO	07/08	cp			29.402118	29.402218	29.402318		
300 Beverly Tourer	09/11	sg							29.36957 ●
300 Beverly Tourer	09/11	cp			29.402117	29.402217	29.402317		
300 Beverly Rst 4T-4V ie Euro3	10/13	sg							29.36957 ●
300 Beverly Rst 4T-4V ie Euro3	10/13	cp			29.402117	29.402217	29.402317		
300 Carnaby Cruiser	09/11	sg							29.36957 ●
300 Carnaby Cruiser	09/11	cp			29.402117	29.402217	29.402317		
300 Vespa GTS Super ie	08/13	cp			29.402111	29.402211			
300 Vespa GTS SuperSport ie	10/13	cp			29.402111	29.402211			
300 Vespa GTS ie/ Touring ie	11/13	cp			29.402111	29.402211			
300 Vespa GTV 4T-4V ie	10/13	cp			29.402111	29.402211			
300 Vespa GTV V.MonteN.	10/13	cp			29.402111	29.402211			
400 Beverly EU3	06/08	sg							29.36962 ●
400 Beverly Tourer	08/09	sg							29.36962 ●
500 Beverly/EU3	02/09	sg							29.36962 ●
500 Beverly Cruiser	07/13	sg							29.36962 ●
500 X 9/Evolution	01/09	sg							29.36965 ●

Applicazioni cc. marca/modello	anno	confezione	SGR	SGR	YSS Pro-X	YSS OE-302	YSS OC-302	Forza C-35	Forza GT-36
			idraulico s/regolazione molla	idraulico rinforzato c/regol. molla	idraulico c/regolaz. molla molla bianca corpo nero	gas c/regolaz. molla molla nera corpo oro	gas c/reg. molla c/serbatoio molla nera corpo oro	gas c/regolazione molla	gas rinforzato c/regol. molla

SUZUKI

50 AH Address	92/95	sg			29.401103	29.401203	29.401303		
50 AJ ZZ Sepia S	95/97	sg			29.401103	29.401203	29.401303		
50 AP R/T (R7)	94/97	sg			29.401103	29.401203	29.401303		
50 AY Katana/LC	97/04	sg			29.401103	29.401203	29.401303		
50 Estilete	00/>	sg			29.401103	29.401203	29.401303		
50 CP Lido	91/94	sg			29.401103	29.401203	29.401303		
50 Zillion	99/>	sg			29.401103	29.401203	29.401303		
100 AH Address	93/95	sg	29.87416 ▶	29.87603 ▼	29.401105	29.401205	29.401305	29.35832 ▼	
125 Burgman	02/06	dx							29.36945 ●
125 Burgman	02/06	sx							29.369451 ●
125 Burgman	07/13	cp			29.402106	29.402206			
125 Sixteen	08/13	cp			29.402104	29.402204	29.402304		
150 Burgman	02/06	dx							29.36945 ●
150 Burgman	02/06	sx							29.369451 ●
150 Sixteen	08/13	cp			29.402104	29.402204	29.402304		
200 Burgman	07/13	cp			29.402106	29.402206			
250 Burgman	98/06	sg							29.36970 ▶
400 Burgman	98/06	sg							29.36971 ▶
650 Burgman	03/13	dx							29.36958 ●
650 Burgman	03/13	sx							29.369581 ●
650 Burgman	03/13	cp				29.402220			

SYM

50 Jet 2T	99/02	sg	29.87479		29.401107	29.401207	29.401307		
50 Jet Euro X EU2 2T	03/07	sg	29.87479		29.401107	29.401207	29.401307		
50 Jet Sport X	07/11	sg	29.87479		29.401107	29.401207	29.401307		
50 Jungle 2T	99/00	sg	29.87479		29.401107	29.401207	29.401307		
50 Mask/Euro 2 2T	00/04	sg	29.87479		29.401107	29.401207	29.401307		
50 Red Devil 2T	99/00	sg	29.87479		29.401107	29.401207	29.401307		
100 Jet 2T	99/00	sg	29.87479		29.401107	29.401207	29.401307		
125 HD/EU2/Euro3/EVO	03/13	cp			29.402101	29.402201	29.402301		
125 HD/EU2/Euro3/EVO	03/13	dx						29.35817 ●	
125 HD/EU2/Euro3/EVO	03/13	sx						29.358171 ●	
200 HD/EU2/Euro3/EVO/ie	03/13	cp			29.402101	29.402201	29.402301		
200 HD/EU2/Euro3/EVO/ie	03/13	dx						29.35817 ●	
200 HD/EU2/Euro3/EVO/ie	03/13	sx						29.358171 ●	
250 GTS/JoyMax Euro3/ie	03/13	cp			29.402119		29.402319		
300 JoyMax ie/EVO	09/13	cp			29.402119		29.402319		

YAMAHA

50 Axis	95/96	sg	29.87406 ●	29.7532 ▼	29.401102	29.401202	29.401302	29.35947 ▼	
50 Aerox	97/13	sg		29.87602 ▼	29.401104	29.401204	29.401304	29.35945 ▼	
50 CT S/SS	90/95	sg	29.87406 ●	29.7532 ▼	29.401102	29.401202	29.401302	29.35947 ▼	
50 CR Z	91/95	sg	29.87406 ●	29.7532 ▼	29.401102	29.401202	29.401302	29.35947 ▼	
50 CW RS SPY	95/98	sg	29.87406 ●	29.7532 ▼	29.401102	29.401202	29.401302	29.35947 ▼	
50 CW L BW'S	03/04	sg	29.87406 ●	29.7532 ▼	29.401102	29.401202	29.401302	29.35947 ▼	
50 BW'S R	01/03	sg	29.87406 ●	29.7532 ▼	29.401102	29.401202	29.401302	29.35947 ▼	
50 BW'S / Easy	04/13	sg	29.87406 ●	29.7532 ▼	29.401102	29.401202	29.401302	29.35947 ▼	
50 BW'S Bump	97/98	sg	29.87406 ●	29.7532 ▼	29.401102	29.401202	29.401302	29.35947 ▼	

▼ molla bianca - ● molla nera - ▶ molla grigia - ▶ molla gialla
 Confezione: sg = singolo • cp = coppia • sx = sinistro • dx = destro

Applicazioni cc. marca/modello	anno	confezione	SGR	SGR	YSS Pro-X	YSS OE-302	YSS OC-302	Forza C-35	Forza GT-36
			idraulico s/regolazione molla	idraulico rinforzato c/regol. molla	idraulico c/regolaz. molla	gas c/regolaz. molla	gas c/reg. molla c/serbatoio	gas c/regolazione molla	gas rinforzato c/regol. molla
					molla bianca corpo nero	molla nera corpo oro	molla nera corpo oro		
50 BW'S Original	97/03	sg	29.87406 ●	29.7532 ▼	29.401102	29.401202	29.401302	29.35947 ▼	
50 BW'S Original Sport/SP	01/02	sg	29.87406 ●	29.7532 ▼	29.401102	29.401202	29.401302	29.35947 ▼	
50 BW'S Naked	03/13	sg	29.87406 ●	29.7532 ▼	29.401102	29.401202	29.401302	29.35947 ▼	
50 BW'S Next Generation	97/98	sg	29.87406 ●	29.7532 ▼	29.401102	29.401202	29.401302	29.35947 ▼	
50 BW'S Next Generation	99/06	sg	29.87406 ●	29.7532 ▼	29.401102	29.401202	29.401302	29.35947 ▼	
50 Jog Z	95/96	sg			29.401101				
50 Jog R	02/13	sg						29.35848 ▼	
50 Neo's 2T/Easy	97/13	sg		29.87602 ▼	29.401104	29.401204	29.401304	29.35945 ▼	
50 Neo's 4T	10/13	sg		29.87602 ▼	29.401104	29.401204	29.401304	29.35945 ▼	
50 Slider	00/>	sg	29.87479 ●		29.401107	29.401207	29.401307		
50 Why/Euro2	98/10	sg	29.87416 ◀	29.87603 ▼	29.401105	29.401205	29.401305	29.35832 ▼	
100 Aerox	00/>	sg		29.87602 ▼	29.401104	29.401204	29.401304	29.35945 ▼	
100 Neo's 2T	00/>	sg		29.87602 ▼	29.401104	29.401204	29.401304	29.35945 ▼	
100 BW'S	99/>	sg		29.87602 ▼	29.401104	29.401204	29.401304	29.35945 ▼	
125 Teo's	00/>	sg							29.36954 ●
125 XC T Cygnus	95/98	dx						29.35993 ●	29.36966 ●
125 XC T Cygnus	95/98	sx						29.359931 ●	29.369661 ●
125 XC K Cygnus R	97/99	dx						29.35993 ●	29.36966 ●
125 XC K Cygnus R	97/99	sx						29.359931 ●	29.369661 ●
125 XC Cygnus R	99/03	dx						29.35993 ●	29.36966 ●
125 XC Cygnus R	99/03	sx						29.359931 ●	29.369661 ●
125 NXC Cygnus X	04/11	dx						29.35993 ●	29.36966 ●
125 NXC Cygnus X	04/11	sx						29.359931 ●	29.369661 ●
125 Majesty	98/10	cp			29.402103	29.402203			
125 Majesty	98/10	dx							29.36948 ●
125 Majesty	98/10	sx							29.369481 ●
125 Maxster	01/>	dx							29.36953 ●
125 Maxster	01/>	sx							29.369531 ●
125 X-MAX	06/13	cp			29.402106	29.402206			
125 X-MAX	06/13	dx							29.36972 ●
125 X-MAX	06/13	sx							29.369721 ●
125 X-City	07/13	cp			29.402119		29.402319		
150 Teo's	01/>	sg							29.36954 ●
150 Majesty	00/02	cp			29.402103	29.402203			
150 Majesty	00/02	dx							29.36948 ●
150 Majesty	00/02	sx							29.369481 ●
150 Maxster	01/>	dx							29.36953 ●
150 Maxster	01/>	sx							29.369531 ●
180 Majesty	03/08	cp			29.402103	29.402203			
180 Majesty	03/08	dx							29.36948 ●
180 Majesty	03/08	sx							29.369481 ●
250 Majesty/DX	96/06	dx							29.36960 ●
250 Majesty/DX	96/06	sx							29.369601 ●
250 Majesty/DX	96/06	cp			29.402105				
250 X-MAX	05/13	cp			29.402106	29.402206			
250 X-City	07/13	cp			29.402119		29.402319		
300 Versity/XC	03/08	dx							29.36955 ●
300 Versity/XC	03/08	sx							29.369551 ●
400 Majesty	04/12	cp			29.402121	29.402221	29.402321		
500 T-MAX	01/11	sg					29.411800*		

▼ molla bianca - ● molla nera - ◀ molla grigia - ▶ molla gialla

* serie OT306 GAS c/regolazione molla speciale T-Max

Confezione: sg = singolo • cp = coppia • sx = sinistro • dx = destro

Figurato e misure ammortizzatori "SGR" scooter

Fig.	Codice	Descrizione	Colore molla	Int. mm.	Attacco superiore	Attacco inferiore
1	29.87461	ANTERIORE IDRAULICO S/REGOL. MOLLA	NERO	276	P-M10x1,25	2XM8-35mm
2	29.87536	ANTERIORE IDRAULICO S/REGOL. MOLLA	NERO	263	P-M10x1,25	2XM8-35mm
3	29.87403	IDRAULICO S/REGOL. MOLLA	NERO	295	O 10X20	F 20-M8
4	29.87406	IDRAULICO S/REGOL. MOLLA	NERO	250	O 10X20	F 20-M8
4	29.87479	IDRAULICO S/REGOL. MOLLA	NERO	310	O 10X20	F 20-M8
5	29.87416	IDRAULICO S/REGOL. MOLLA	GRIGIO	290	O 10X20	F 20-M8
6	29.87428	IDRAULICO S/REGOL. MOLLA	NERO	290+59	P-M8x1	F 34-M10
6	29.87430	IDRAULICO S/REGOL. MOLLA	NERO	290+59	P-M8x1	F 34-M10
6	29.87452	IDRAULICO S/REGOL. MOLLA	NERO	313+59	P-M8x1	F 34-M10
6	29.87453	IDRAULICO S/REGOL. MOLLA	NERO	273+59	P-M8x1	F 34-M10
7	29.87435	IDRAULICO C/REGOL. MOLLA	NERO	365+55	P-M8x1	F 38-M10
8	29.87459	IDRAULICO C/REGOL. MOLLA	GRIGIO	280+40	P-M8x1	O 14X22
9	29.87602	IDRAULICO RINFORZATO C/REGOL. MOLLA	BIANCO	280	O 10X20	F 20-M8
9	29.87603	IDRAULICO RINFORZATO C/REGOL. MOLLA	BIANCO	295	O 10X20	F 20-M8
10	29.7532	IDRAULICO C/REGOL. MOLLA	BIANCO	250	O 10X20	F 20-M8
10	29.87448	IDRAULICO C/REGOL. MOLLA	NERO	370	O 10X20	F 20-M8
11	29.7540	IDRAULICO RINFORZATO C/REGOL. MOLLA	BIANCO	335+P	P	F 34
12	29.7545	IDRAULICO C/REGOL. MOLLA C/COPRIMOLLA	NERO	290	O 10X20	F 33X10
13	29.7550	IDRAULICO C/REGOL. MOLLA C/COPRIMOLLA	NERO	350	O 10X20	F 33X10

LEGENDA ATTACCO: P = perno • O = occhiello / diametro per profondità • F = forchetta / larghezza • M = misura filetto foro e perno



Fig. 1



Fig. 2



Fig. 3



Fig. 4



Fig. 5



Fig. 6



Fig. 7



Fig. 8



Fig. 9



Fig. 10



Fig. 11



Fig. 12



Fig. 13

Figurato e misure ammortizzatori "YSS" scooter

Fig.	Idrraulico c/regolazione molla bianca corpo nero	Fig.	Gas c/regolazione molla nera corpo nero/oro	Fig.	Gas c/serbatoio molla nera corpo nero/oro	confezione	Int. mm.	Attacco superiore	Attacco inferiore	Dati molla Ø int./carico(1/2) lungh.tot.	Amm.re
1	29.401008			20	29.401408	sg	260	O 10X20	O 10X20	38-25-35-160	soft
1	29.401004					sg	260	O 10X20	O 8X20	46-25-35-140	soft
1	29.401005					sg	270	O 10X20	O 8X20	46-25-35-160	soft
2	29.401001					sg	185	P-M8	2XM8-35mm	38-20-30-120	soft
2	29.401002					sg	210	P-M8	2XM8-35mm	38-20-30-140	soft
2	29.401003					sg	240	P-M8	2XM8-35mm	38-20-30-180	soft
2	29.401006					sg	240	P-M10	2XM8-35mm	38-20-30-180	soft
3	29.401007					sg	205	P	O 14X20	38-25-35-120	soft

POSTERIORI

4	29.401101					sg	230	O 10X20	F 20-M8	46-30-50-140	soft
4	29.401102	11	29.401202	21	29.401302	sg	250	O 10X20	F 20-M8	46-30-50-140	soft
4	29.401103	11	29.401203	21	29.401303	sg	270	O 10X20	F 20-M8	46-25-35-160	soft
4	29.401104	11	29.401204	21	29.401304	sg	280	O 10X20	F 20-M8	46-25-35-160	soft
4	29.401105	11	29.401205	21	29.401305	sg	290	O 10X20	F 20-M8	46-25-35-180	soft
4	29.401106	11	29.401206	21	29.401306	sg	300	O 10X20	F 20-M8	46-25-35-180	soft
4	29.401115	11	29.401215	21	29.401315	sg	300	O 10X20	F 33-M10	46-25-35-180	soft
4	29.401107	11	29.401207	21	29.401307	sg	310	O 10X20	F 20-M8	46-25-35-200	soft
4	29.401108	11	29.401208	21		sg	320	O 10X20	F 20-M8	46-25-35-200	soft
4	29.401121					sg	335	O 10X20	F 33-M10	46-25-35-200	soft
4	29.401114	11	29.401214	21	29.401314	sg	390	O 10X20	F 33-M10	46-25-35-260	soft
4	29.401116	11	29.401216	21	29.401316	sg	395	O 10X20	F 26-M10	46-25-35-240	soft
5	29.401109	12	29.401209	22	29.401309	sg	285	P-M8	F 33-M10	46-25-35-180	soft
5	29.401111	12	29.401211	22	29.401311	sg	300	P-M8	F 33-M10	46-25-35-180	soft
5	29.401112	12	29.401212			sg	310	P-M8	F 33-M10	46-25-35-200	soft
				22	29.401319	sg	330	P-M9	F 48-M10	38-25-35-220	soft
		12	29.401220			sg	340	P-M9	F 48-M10	38-25-45-220	soft
5	29.401113	12	29.401213			sg	365	P-M8	F 37-M10	46-25-35-240	soft
6	29.401110	13	29.401210			sg	285	P-M8	O 10X20	46-25-35-180	soft
6	29.401118	13	29.401218	23	29.401318	sg	300	P-M8	O 10X30	38-25-35-220	soft
1	29.401117	14	29.401217			sg	270	O 10X20	O 10X20	46-25-35-160	soft
		15	29.411800*			sg	315	O 12X64	O 16X30	41-160-260-135	
7	29.402101	16	29.402201	24	29.402301	cp	300	O 10X20	F 20-M8	46-17-25-180	medium
7	29.402116	16	29.402216	24	29.402316	cp	300	O 10X20	F 20-M8	46-13-18-180	soft
		16	29.402213	24	29.402313	cp	310	O 10X20	F 20-M8	46-14-25-200	medium
7	29.402102	16	29.402202			cp	315	O 10X20	F 22-M10	46-13-18-200	soft
7	29.402103	16	29.402203			cp	330	O 10X20	F 20-M8	46-17-25-220	medium
7	29.402104	16	29.402204	24	29.402304	cp	330	O 10X20	F 20-M8	46-13-18-220	soft
7	29.402105	16	29.402205	24	29.402305	cp	340	O 10X20	F 20-M8	46-13-18-220	soft
7	29.402106	16	29.402206			cp	340	O 10X20	F 20-M8	46-10-15-220	soft
7	29.402107	16	29.402207			cp	350	O 8X20	F 26-M10	46-13-18-240	soft
7	29.402119	16		24	29.402319	cp	360	O 10X20	F 20-M8	17-25	medium
		16	29.402220			cp	370	O 10X20	F 20-M10	46-17-25-240	medium
7	29.402108					cp	390	O 10X20	F 22-M10 offset	46-13-18-240	soft
7	29.402109	16	29.402209			cp	390	O 10X20	F 22-M10	46-13-18-240	soft
7	29.402114	16	29.402214	24	29.402314	cp	400	O 10X20	F 26-M10	46-10-15-240	soft
		16	29.402215			cp	420	O 16X20	F 26-M10	46-13-18-260	soft

LEGENDA ATTACCO: P = perno • O = occhio / diametro per profondità • F = forchetta / larghezza (interna) • M = Ø filetto

Confezione: sg = singolo • cp = coppia

* Speciale T-Max triplo pistone 30 mm. (ATPD) gas c/regolazione precarico molla

Fig.	Idraulico c/regolazione molla bianca corpo nero	Fig.	Gas c/regolazione molla nera corpo nero/oro	Fig.	Gas c/serbatoio molla nera corpo nero/oro	confezione	Int. mm.	Attacco superiore	Attacco inferiore	Dati molla Ø int./carico(1/2) lungh.tot.	Amm.re
8	29.402117	17	29.402217	25	29.402317	cp	340	O 10X30	O 14X24	46-13-18-220	soft
8	29.402112	17	29.402212	25	29.402312	cp	350	O 10X20	O 14X24/10X24	46-13-18-220	soft
8	29.402118	17	29.402218	25	29.402318	cp	360	O 10X30	O 10X30	46-13-18-240	soft
9	29.402121	18	29.402221	26	29.402321	cp	415	F 20-M10	F 20-M8	46-10-15-240	soft
10	29.402110	19	29.402210	27	29.402310	cp	280	P-M8	O 14X24	46-17-25-180	medium
10	29.402111	19	29.402211			cp	340	P-M8	O 14X20	46-13-18-220	soft

LEGENDA ATTACCO: P = perno • O = occhiello / diametro per profondità • F = forchetta / larghezza (interna) • M = Ø filetto
 Confezione: sg = singolo • cp = coppia



Fig. 1



Fig. 2



Fig. 3



Fig. 4



Fig. 5



Fig. 6



Fig. 7



Fig. 8



Fig. 9



Fig. 10



Fig. 11



Fig. 12



Fig. 13



Fig. 14



Fig. 15



Fig. 16



Fig. 17



Fig. 18



Fig. 19



Fig. 20



Fig. 21



Fig. 22



Fig. 23



Fig. 24



Fig. 25



Fig. 26



Fig. 27

Figurato e misure ammortizzatori "Forza"

<i>Codice</i>	<i>Tipo</i>	<i>Descrizione</i>	<i>Colore molla</i>	<i>Confezione</i>	<i>Int. mm.</i>	<i>Attacco superiore</i>	<i>Attacco inferiore</i>
FIGURA 1 - ATTACCHI OCCHIELLO/OCCHIELLO - MONTAGGIO IN COPPIA							
29.35842	C-35	Gas c/regol.molla	Nero	destro	340	O 10X24	O 14X24
29.358421	C-35	Gas c/regol.molla	Nero	sinistro	340	O 10X24	O 14X24
29.36957	GT-36	Gas rinforzato c/regol.molla	Nero	singolo	340	O 10X24	O 14X20
29.36951	GT-36	Gas rinforzato c/regol.molla	Nero	singolo	340	O 10X24	O 14X24
29.36959	GT-36	Gas rinforzato c/regol.molla	Nero	singolo	340	O 10X24	O 14X24
29.36962	GT-36	Gas rinforzato c/regol.molla	Nero	singolo	375	O 10X24	O 10X30
29.36965	GT-36	Gas rinforzato c/regol.molla	Nero	singolo	375	O 10X24	O 10X24
29.36973	GT-36	Gas rinforzato c/regol.molla	Nero	destro	380	O 8X20	O 14X24
29.369731	GT-36	Gas rinforzato c/regol.molla	Nero	sinistro	380	O 8X20	O 14X24
29.36931	GT-36	Gas rinforzato c/regol.molla	Nero	singolo	385	O 10X20	O 10X20
FIGURA 2 - ATTACCHI OCCHIELLO/FORCHETTA - MONTAGGIO SINGOLO							
29.35947	C-35	Gas c/regol.molla	Bianco	singolo	245	O 10X20	F 20-Ø8
29.35826	C-35	Gas c/regol.molla	Bianco	singolo	250	O 10X20	F 20-Ø8
29.35818	C-35	Gas c/regol.molla	Bianco	singolo	280	O 10X20	F 20-Ø8
29.35931	C-35	Gas c/regol.molla	Bianco	singolo	280	O 10X20	F 20-Ø8
29.35945	C-35	Gas c/regol.molla	Bianco	singolo	280	O 10X20	F 20-Ø8
29.35957	C-35	Gas c/regol.molla	Bianco	singolo	280	O 10X20	F 18-Ø8
29.35816	C-35	Gas c/regol.molla	Bianco	singolo	285	O 10X20	F 20-Ø8
29.35848	C-35	Gas c/regol.molla	Bianco	singolo	285	O 10X20	F 20-Ø8
29.35958	C-35	Gas c/regol.molla	Bianco	singolo	285	O 10X20	F 20-Ø8
29.35832	C-35	Gas c/regol.molla	Bianco	singolo	290	O 10X20	F 20-Ø8
29.35961	C-35	Gas c/regol.molla	Bianco	singolo	290	O 10X20	F 20-Ø8
29.35841	C-35	Gas c/regol.molla	Bianco	singolo	300	O 10X20	F 33-Ø10
29.35890	C-35	Gas c/regol.molla	Bianco	singolo	315	O 10X20	F 20-Ø8
29.35857	C-35	Gas c/regol.molla	Bianco	singolo	320	O 10X20	F 20-Ø8
29.36954	GT-36	Gas rinforzato c/regol.molla	Nero	singolo	335	O 10X20	F 20-Ø8
29.35956	C-35	Gas c/regol.molla	Bianco	singolo	380	O 10X20	F 20-Ø8
29.36928	GT-36	Gas rinforzato c/regol.molla	Nero	singolo	390	O 10X20	F 30-Ø10
FIGURA 3 - ATTACCHI OCCHIELLO/FORCHETTA - MONTAGGIO IN COPPIA							
29.35817	C-35	Gas c/regol.molla	Nero	destro	300	O 10X20	F 20-Ø8
29.358171	C-35	Gas c/regol.molla	Nero	sinistro	300	O 10X20	F 20-Ø8
29.35993	C-35	Gas c/regol.molla	Nero	destro	320	O 10X20	F 20-Ø10
29.359931	C-35	Gas c/regol.molla	Nero	sinistro	320	O 10X20	F 20-Ø10
29.36966	GT-36	Gas rinforzato c/regol.molla	Nero	destro	320	O 10X20	F 20-Ø10
29.369661	GT-36	Gas rinforzato c/regol.molla	Nero	sinistro	320	O 10X20	F 20-Ø10
29.36948	GT-36	Gas rinforzato c/regol.molla	Nero	destro	335	O 10X20	F 20-Ø8
29.369481	GT-36	Gas rinforzato c/regol.molla	Nero	sinistro	335	O 10X20	F 20-Ø8
29.36972	GT-36	Gas rinforzato c/regol.molla	Nero	destro	340	O 10X20	F 20-Ø8
29.369721	GT-36	Gas rinforzato c/regol.molla	Nero	sinistro	340	O 10X20	F 20-Ø8
29.36960	GT-36	Gas rinforzato c/regol.molla	Nero	destro	345	O 10X20	F 20-Ø8
29.369601	GT-36	Gas rinforzato c/regol.molla	Nero	sinistro	345	O 10X20	F 20-Ø8
29.36943	GT-36	Gas rinforzato c/regol.molla	Nero	destro	370	O 10X20	F 20-Ø8
29.369431	GT-36	Gas rinforzato c/regol.molla	Nero	sinistro	370	O 10X20	F 20-Ø8
29.36955	GT-36	Gas rinforzato c/regol.molla	Nero	destro	385	O 10X20	F 20-Ø8
29.369551	GT-36	Gas rinforzato c/regol.molla	Nero	sinistro	385	O 10X20	F 20-Ø8
29.36938	GT-36	Gas rinforzato c/regol.molla	Nero	destro	400	O 10X24	F 26-Ø10
29.369381	GT-36	Gas rinforzato c/regol.molla	Nero	sinistro	400	O 10X24	F 26-Ø10
FIGURA 4 - ATTACCHI FORCHETTA/FORCHETTA - MONTAGGIO IN COPPIA							
29.36963	GT-36	Gas rinforzato c/regol.molla	Nero	destro	415	F 20-M8	F 20-Ø8
29.369631	GT-36	Gas rinforzato c/regol.molla	Nero	sinistro	415	F 20-M8	F 20-Ø8
FIGURA 5 - ATTACCHI FORCHETTA/OCCHIELLO - MONTAGGIO SINGOLO							
29.36970	GT-36	Gas rinforzato c/regol.molla	Giallo	singolo	345	F 35-Ø10	O 10X30
29.36971	GT-36	Gas rinforzato c/regol.molla	Giallo	singolo	345	F 35-Ø10	O 10X30
FIGURA 6 - ATTACCHI FORCHETTA/OCCHIELLO - MONTAGGIO IN COPPIA							
29.36953	GT-36	Gas rinforzato c/regol.molla	Nero	destro	435	F 22-Ø8	O 10X20
29.369531	GT-36	Gas rinforzato c/regol.molla	Nero	sinistro	435	F 22-Ø8	O 10X20

LEGENDA ATTACCO: P = perno • O = occhello / diametro per profondità • F = forchetta / larghezza • M = misura filetto • Ø = diametro foro

Codice	Tipo	Descrizione	Colore molla	Confezione	Int. mm.	Attacco superiore	Attacco inferiore
29.35966	C-35	Gas c/regol.molla	Bianco	singolo	285+60	P-M10	F 33-Ø10
29.36936	GT-36	Gas rinforzato c/regol.molla	Nero	singolo	285+60	P-M10	F 38-Ø10
29.35834	C-35	Gas c/regol.molla	Bianco	singolo	290+60	P-M10	F 33-Ø10
29.35936	C-35	Gas c/regol.molla	Bianco	singolo	290+60	P-M10	F 33-Ø10
29.36934	GT-36	Gas rinforzato c/regol.molla	Nero	singolo	290+60	P-M10	F 38-Ø10
29.36950	GT-36	Gas rinforzato c/regol.molla	Nero	singolo	390+60	P-M10	F 33-Ø10

LEGENDA ATTACCO: P = perno • O = occhiello / diametro per profondità • F = forchetta / larghezza • M = misura filetto • Ø = diametro foro

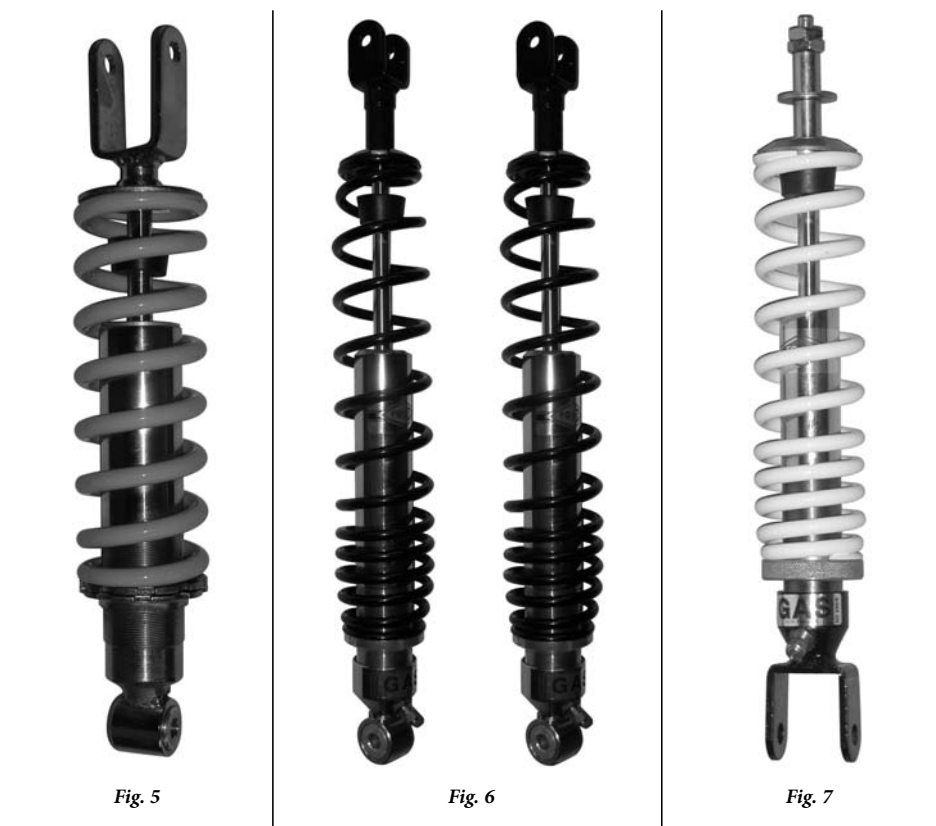
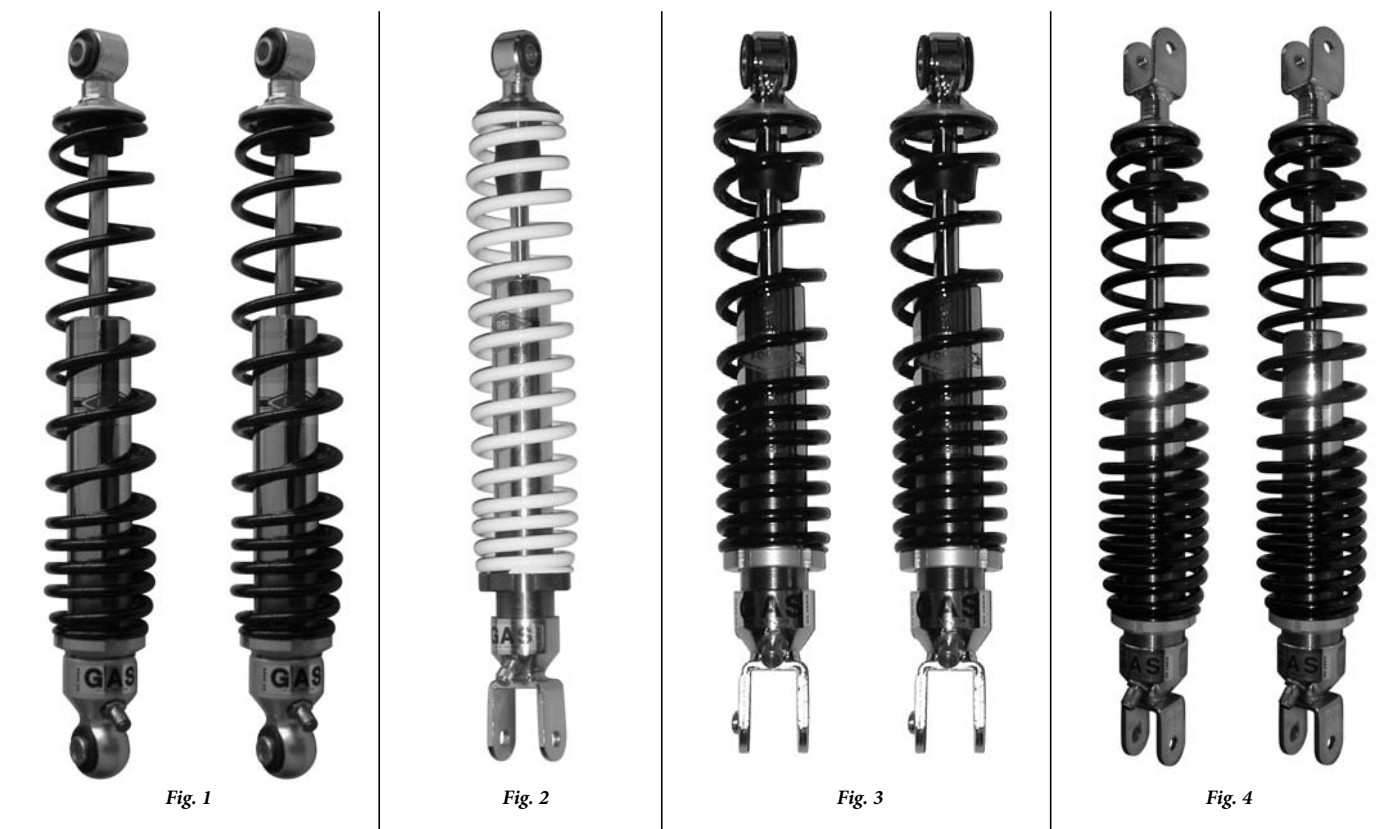

SPOONER

Ammortizzatori posteriori ciclomotori e motocicli

Applicazioni cc marca/modello	anno	SGR meccanico c/regolaz. molla	Int. mm.	SGR idraulico c/regolaz. molla	Int. mm.	YSS Pro-X idraulico c/regolaz. molla	Int. mm.	YSS Bravo idraulico c/regolaz. molla	Int. mm.	YSS MonoShock gas
		molla cromata corpo nero conf. singola		molla cromata corpo nero conf. singola		molla nera corpo nero coppia		molla nera corpo cromato coppia		mono ammortizzatore

AERMACCHI

250 Sprint C / H / SS (int. 11")	61/69							29.4627001	270	
250 Sprint SS / SX (int.12,5")	70/74			29.82320	320	29.4532019	320			
250 SS / SX (int.13")	70/>			29.82330	330	29.4533034	330	29.4633008	330	
350 SS / SX (int.13")	70/>			29.82330	330	29.4533034	330	29.4633008	330	
350 GT Sprint	70			29.82310	310			29.4631008	310	
350 GTS	71/72			29.82310	310			29.4631008	310	
350 TV	71/72			29.82310	310			29.4631008	310	
350 TV A.E.				29.82340	340			29.4634006	340	

AGRATI-GARELLI

50 Eureka Flex De Lux	76	29.83260	260	29.871351*	260					
50 Katia-Eureka		29.83260	260	29.871351*	260					
50 Gulp Lusso-Flex		29.83260	260	29.871351*	260					
50 Noi Matic/De Luxe		29.83260	260	29.871351*	260					
50 Vip 1 - Vip 2		29.83300	300							

APRILIA

50 AF1	90									29.4226506 *
50 AF1 Europa	90/92									29.4226506 *
50 AF1 Futura	90/92									29.4226506 *
50 RS/Extrema/Replica 92/05	92/05									29.4226506 *
50 RS Tuono	03/04									29.4226506 *
125 AF1 Sintesi/Replica	88/90									29.4228006 *
125 AF1 Europa	90/92									29.4228006 *
125 AF1 Futura	90/92									29.4228006 *
125 Classic	95/99			29.82310	310	29.4531009	310	29.4631008	310	
125 Red Rose	87/94			29.82310	310	29.4531009	310	29.4631008	310	
125 RS/Extrema/Replica	92/12									29.4228006 *
125 RS Tuono	03/04									29.4228006 *
250 RS/Replica	94/01									29.4431526 ●
650 Pegaso	92/96									29.4433502 ●
650 Pegaso 3	97/00									29.4433502 ●
650 Pegaso IE / Tuscany-Tibet	01/04									29.4433502 ●
660 Pegaso StradaFun/Factory	05/12									29.4431022 ●

ATALA-RIZZATO

50 Green		29.83300	300							
----------	--	----------	-----	--	--	--	--	--	--	--

BENELLI

50 Gentlemen 2/2L		29.83260	260	29.871351*	260					
50 Magnum	79/>	29.83260	260	29.871351*	260					
125 124	82/95			29.82320	320	29.4532019	320			
125 Sport	80/89			29.82320	320	29.4532019	320			
125 T	81/85			29.82320	320	29.4532019	320			
125 Turismo	81/85			29.82320	320	29.4532019	320			
125 2C/SE	72/80			29.82320	320	29.4532019	320			

* YSS mono Eco-Line gas c/regol. precarico molla

● YSS mono Top-Line gas c/regol. precarico molla e ritorno (rebound)

Applicazioni cc marca/modello	anno	SGR meccanico c/regolaz. molla	Int. mm.	SGR idraulico c/regolaz. molla	Int. mm.	YSS Pro-X idraulico c/regolaz. molla	Int. mm.	YSS Bravo idraulico c/regolaz. molla	Int. mm.	YSS MonoShock gas
		molla cromata corpo nero		molla cromata corpo nero		molla nera corpo nero		molla nera corpo cromato		mono ammortizzatore
		conf. singola		conf. singola		coppia		coppia		
250 2C/2CE/SE	72/87			29.82320	320	29.4532019	320			
250 TS	74/81			29.82320	320	29.4532019	320			
250 Quattro	77/84			29.82320	320	29.4532019	320			
250 254	78/84			29.82320	320	29.4532019	320			
300 304	84/89			29.82320	320	29.4532019	320			
350 RS	78/81			29.82330	330	29.4533034	330	29.4633010	330	
350 Quattro	79/85			29.82330	330	29.4533034	330	29.4633010	330	
350 354/T - 354 Sport/II	79/85			29.82330	330	29.4533034	330	29.4633010	330	
500 Quattro	73/76			29.82330	330	29.4533034	330	29.4633010	330	
500 504 Sport	79/82			29.82330	330	29.4533034	330	29.4633010	330	
500 LS	77/80			29.82330	330	29.4533034	330	29.4633010	330	
650 Tornado S	72/76			29.82320	320	29.4532019	320			
650 654/T	80/86			29.82330	330	29.4533034	330	29.4633010	330	
650 654 Sport	81/86			29.82330	330	29.4533034	330	29.4633010	330	
750 Sei	74/78			29.82330	330	29.4533034	330	29.4633010	330	
900 Sei	78/90			29.82340	340			29.4634006	340	

BMW

450 R 45/N/T	78/85			29.82330	330	29.4533034	330			
500 R 50/5	69/73			29.82340	340			29.4634006	340	
600 R 60/5	69/73			29.82340	340			29.4634006	340	
600 R 60/6	73/76			29.82340	340			29.4634006	340	
600 R 60/7	77/84			29.82340	340			29.4634006	340	
650 R 65/T/LS	78/85			29.82330	330	29.4533034	330			
650 R 65 Monolever	85/93									29.4341006 ●
650 R 65 RT Monolever	85/88									29.4341006 ●
650 R 65 GS	80/88									29.4236505 ●
750 K 75 /C/RT/S/T	83/96									29.4235001 ●
750 R 75/5	69/73			29.82340	340			29.4634006	340	
750 R 75/6	73/76			29.82340	340			29.4634006	340	
750 R 75/7	77/84			29.82340	340			29.4634006	340	
800 R 80 G/S	80/88									29.4236505 ●
800 R 80/RT/7	77/84			29.82340	340			29.4634006	340	
800 R 80 / R 80 RT Monolever	84/95									29.4341006 ●
900 R 90/6/S	73/76			29.82340	340			29.4634006	340	
1000 K 100/RT/LT/RS	83/88									29.4235001 ●
1000 K 100 RS	89/93									29.4438501 ●
1000 K1 1000	88/94									29.4438501 ●
1000 R 100/T/7T/S/CS/RS/RT	77/84			29.82340	340			29.4634006	340	
1000 R 100 RT/RS Monolever	87/95									29.4341006 ●
1100 K 1100 LT	89/99									29.4438501 ●
1100 K 1100 RS	92/97									29.4438501 ●

CAGIVA

125 SST	81/85			29.82310	310	29.4531009	310	29.4631008	310	
250 Ala Verde	83/87			29.82310	310	29.4531009	310	29.4631008	310	
250 SST	82/85			29.82310	310	29.4531009	310	29.4631008	310	
250 SX	81/85			29.82340	340			29.4634006	340	
350 Ala Verde	83/87			29.82310	310	29.4531009	310	29.4631008	310	
350 SST	82/86			29.82310	310	29.4531009	310	29.4631008	310	
350 SX	81/85			29.82340	340			29.4634006	340	

* YSS mono Eco-Line gas c/regol. precarico molla

● YSS mono Top-Line gas c/regol. precarico molla e ritorno (rebound)

MOTOCICLI

Applicazioni cc marca/modello	anno	SGR meccanico c/regolaz. molla	Int. mm.	SGR idraulico c/regolaz. molla	Int. mm.	YSS Pro-X idraulico c/regolaz. molla	Int. mm.	YSS Bravo idraulico c/regolaz. molla	Int. mm.	YSS MonoShock gas
		molla cromata corpo nero		molla cromata corpo nero		molla nera corpo nero		molla nera corpo cromato		mono ammortizzatore
		conf. singola		conf. singola		coppia		coppia		
350 Alazzurra	84/90			29.82310	310	29.4531009	310	29.4631008	310	
400 Alazzurra	84/90			29.82310	310	29.4531009	310	29.4631008	310	
650 Alazzurra	84/90			29.82310	310	29.4531009	310	29.4631008	310	

DAELIM

125 VT/Evolution/Evo	98/06			29.82300	300			29.4630002	300	
----------------------	-------	--	--	-----------------	-----	--	--	-------------------	-----	--

DERBI

125 Senda R/SM/Baja/EU2/EU3	04/11									29.4229001 *
-----------------------------	-------	--	--	--	--	--	--	--	--	---------------------

DUCATI

125 Enduro/Regolarita'	76/>			29.82330	330	29.4533034	330			
160 Monza Junior	64/>			29.82300	300			29.4630002	300	
200 TS Turismo	68/>			29.82310	310	29.4531009	310			
200 Elite	68/>			29.82310	310	29.4531009	310			
250 De Luxe	68/>			29.82310	310	29.4531009	310			
250 250/350/450 Scrambler (int.320)	67/>			29.82320	320	29.4532019	320			
250 250/350/450 Scrambler (int.310)	67/>			29.82310	310	29.4531009	310	29.4631008	310	
250 250/350/450 Mark III/Desmo	67/>			29.82310	310	29.4531009	310	29.4631008	310	
350 GTL/GTV/Sport/Desmo	75/>			29.82320	320	29.4532019	320			
350 Indiana	85/>			29.82360	360			29.4636021	360	
350 Pantah TL/XL	78/86			29.82310	310	29.4531009	310	29.4631008	310	
500 GTL/GTV/Sport/Desmo	75/>			29.82320	320	29.4532019	320			
500 Pantah TL/SL	78/86			29.82310	310	29.4531009	310	29.4631008	310	
600 Pantah TL/SL	79/86			29.82310	310	29.4531009	310	29.4631008	310	
650 Indiana	85/>			29.82360	360			29.4636021	360	
650 Pantah SL	82/86			29.82310	310	29.4531009	310	29.4631008	310	
750 Indiana	85/>			29.82360	360			29.4636021	360	
750 GT/Sport	72/75			29.82310	310	29.4531009	310	29.4631008	310	
750 Super Sport SS Desmo	75/80			29.82310	310	29.4531009	310	29.4631008	310	
750 Super Sport SS Replica	80/84			29.82330	330	29.4533034	330			
850 GT/GTS (fino al tel. 900989)	75/79			29.82300	300			29.4630002	300	
850 GT/GTS (da tel. 900990)	75/79			29.82320	320	29.4532019	320			
900 GTS	75/79			29.82320	320	29.4532019	320			
900 SS Desmo	75/80			29.82310	310	29.4531009	310	29.4631008	310	
900 SS Replica	80/85			29.82330	330	29.4533034	330			
900 S2 Desmo	79/85			29.82330	330	29.4533034	330			
900 MHR Replica	79/85			29.82330	330	29.4533034	330			
900 SD Darmah (fino a tel. 900989)	77/82			29.82300	300			29.4630002	300	
900 SD Darmah (da tel. 900990)	77/82			29.82320	320	29.4532019	320			
1000 S2 Desmo	84/87			29.82330	330	29.4533034	330			
1000 MHR Replica	84/87			29.82330	330	29.4533034	330			
1000 SportClassic Single Seat	06/07									29.4438003 ●
1000 Paul Smart LE	06									29.4438003 ●

FANTIC MOTOR

50 Issimo/Convert		29.83280	280							
50 Lei		29.83300	300							

* YSS mono Eco-Line gas c/regol. precarico molla

● YSS mono Top-Line gas c/regol. precarico molla e ritorno (rebound)

Applicazioni cc marca/modello	anno	SGR meccanico c/regolaz. molla	Int. mm.	SGR idraulico c/regolaz. molla	Int. mm.	YSS Pro-X idraulico c/regolaz. molla	Int. mm.	YSS Bravo idraulico c/regolaz. molla	Int. mm.	YSS MonoShock gas
		molla cromata corpo nero conf. singola		molla cromata corpo nero conf. singola		molla nera corpo nero coppia		molla nera corpo cromato coppia		mono ammortizzatore

GILERA

98	Giubileo / Extra		280							
124	Normale / Extra		280							
124	6 giorni / Special		280							
125	5V Arcore	71/>		29.82300	300			29.4630002	300	
150	5V Arcore	71/>		29.82300	300			29.4630002	300	

JAWA

125	Roadster (2T-Monocil.)	73/>		29.82300	300			29.4630002	300	
175	Roadster (2T-Monocil.)	73/>		29.82300	300			29.4630002	300	
350	638	83/86		29.82320	320	29.4532019	320			
350	639/TS	84/90		29.82320	320	29.4532019	320			
350	640/Style	84/91		29.82320	320	29.4532019	320			

HARLEY-DAVIDSON

883	XL 53 C Sportster Custom	99/03						29.4633047	330	
883	XL Sportster	04/08						29.4631027	310	
883	XL Sportster L	05						29.4631027	310	
883	XL C Sportster Custom	04						29.4631027	310	
883	XLH Sportster Hugger	92/03						29.4633047	330	
883	XLH Sportster/Deluxe	88/93						29.4635002	350	
883	XLH Sportster Deluxe	94/05						29.4633047	330	
883	XLH C Sportster Custom	99/03						29.4633047	330	
883	XL R Sportser Roadster	03						29.4633047	330	
883	XL R Sportser Roadster	05						29.4631027	310	
883	XL R Sportster	04/>						29.4631027	310	
1200	XL R Sportser Roadster	04/06						29.4631027	310	
1200	XL S Sportser Sport	95/03						29.4635002	350	
1200	XL C Sportster Custom	96/03						29.4633047	330	
1200	XLH Sportser	88/93						29.4635002	350	
1200	XLH Sportser	94/03						29.4633047	330	

HONDA

125	CA Rebel	95/99						29.4627001	270	
125	CB N/S	76/82		29.82310	310	29.4531009	310			
125	CB T	78/86		29.82310	310	29.4531009	310			
125	CBF	09/11		29.82350	350			29.4635019	350	
125	CBR R/RS/RW (JC34/JC39)	04/10								29.4226506 *
125	CBR R/RS/RT/RW (JC50)	11/13								29.4226506 *
125	CG	80/84		29.82310	310	29.4531009	310			
125	CG	92/01		29.82330	330					
125	CG ES	04/07								
125	CM C	80/99		29.82310	310	29.4531009	310			
125	NSR F (JC22)	93								29.4430003 ●
125	NSR R (JC22)	93/01								29.4430003 ●
125	XL /XL S (K2/K3 - SZ/SA/SC)	79/82		29.82400	400					
125	XL V Varadero	01/12								29.4431025 ●
150	CBR R (Estero)	02/>								29.4226506 *
200	CM T	80/83		29.82310	310	29.4531009	310			

* YSS mono Eco-Line gas c/regol. precarico molla

● YSS mono Top-Line gas c/regol. precarico molla e ritorno (rebound)

Applicazioni cc marca/modello	anno	SGR meccanico c/regolaz. molla		SGR idraulico c/regolaz. molla		YSS Pro-X idraulico c/regolaz. molla		YSS Bravo idraulico c/regolaz. molla		YSS MonoShock gas	
		Int. mm.		Int. mm.		Int. mm.		Int. mm.		Int. mm.	
		molla cromata corpo nero conf. singola		molla cromata corpo nero conf. singola		molla nera corpo nero coppia		molla nera corpo cromato coppia		mono ammortizzatore	
250 CB K0/B4 SuperSport (twin)	68/74							29.4631016	310		
250 CB Two Fifty	92/01			29.82320	320			29.4632013	320		
250 CB RS	80/82			29.82330	330			29.4633008	330		
250 CBX RS (int.335)	80/89			29.82340	340			29.4634006	340		
250 CBX RSE (int.325)	84/86			29.82330	330			29.4633008	330		
250 CM C	82/86			29.82310	310	29.4531009	310				
250 CMX C Rebel	85/86							29.4627001	270		
250 CMX C Rebel	96/12							29.4627001	270		
250 XL /XL S (K3/K4 - SZ/SA/SB)	76/83			29.82400	400						
350 CB K0/B4 SuperSport (twin)	68/74							29.4631016	310		
350 CB F Four	72/77							29.4632029	320		
350 CB S (int.330 mm.)	87/90			29.82330	330			29.4633008	330		
350 CB S (int.340 mm.)	87/90			29.82340	340			29.4634006	340		
350 XL R (ND03)	84/87									29.4437502	●
360 CB (twin)	74/76							29.4632029	320		
360 CL Scrambler	74/76							29.4632029	320		
400 CB F Four/SuperSport	75/78							29.4632029	320		
400 CM A/T/TZ	79/86							29.4632029	320		
450 CB K SuperSport (twin)	69/75							29.4632029	320		
450 CB S (int.330 mm.)	87/90			29.82330	330			29.4633008	330		
450 CB S (int.340 mm.)	87/90			29.82340	340			29.4634006	340		
450 CB SC NightHawk	82/86							29.4633502	335		
450 CL Scrambler	69/75							29.4632029	320		
500 CB K Four	71/74							29.4632029	320		
500 CB T (twin)	75/77							29.4632029	320		
500 CB / S	94/02							29.4635020	350		
500 CX	78/86							29.4633008	330		
500 CX C Custom	78/86							29.4633008	330		
500 FT	82/83							29.4632013	320		
500 VT E	83/89							29.4635006	350		
500 VT C	83/89							29.4635006	350		
500 XL S (SZ/SA/SB)	79/82			29.82400	400						
550 CB F Four/Supersport	76/78							29.4632029	320		
550 CB K Four (K/K4)	74/79							29.4632029	320		
550 CB SC NightHawk	83							29.4634001	340		
600 CB F Hornet	98/06									29.4430502	●
600 CBX E	83/85							29.4634001	340		
600 VT C Shadow	88/07									29.4426503	●
600 XL R/L/RM/LM (PD03/PD04)	83/88									29.4437502	●
600 XL V Transalp	87/90									29.4437502	●
650 CB Z/A	79/82							29.4633502	335		
650 CB C Custom	80/82							29.4633502	335		
650 CB SC NightHawk	82							29.4633502	335		
650 CB SC NightHawk	83/87							29.4634001	340		
650 CBX E	83/85							29.4634001	340		
650 NT V Deauville	98/05									29.4430011	●
650 XRV Africa Twin (RD03)	88/90									29.4437502	●
750 CB F/F1/F2 Four/SuperSport	69/79							29.4633502	335		
750 CB FA/FB/FC/FD Supersport	79/83							29.4636520	365		
750 CB K Four	69/81							29.4633502	335		
750 CB C Custom	80/84							29.4633502	335		
750 CB SC NightHawk (RC38)	91/95							29.4633037	330		

* YSS mono Eco-Line gas c/regol. precarico molla

● YSS mono Top-Line gas c/regol. precarico molla e ritorno (rebound)

Applicazioni cc marca/modello	anno	SGR meccanico c/regolaz. molla	Int. mm.	SGR idraulico c/regolaz. molla	Int. mm.	YSS Pro-X idraulico c/regolaz. molla	Int. mm.	YSS Bravo idraulico c/regolaz. molla	Int. mm.	YSS MonoShock gas
		molla cromata corpo nero		molla cromata corpo nero		molla nera corpo nero		molla nera corpo cromato		mono ammortizzatore
		conf. singola		conf. singola		coppia		coppia		
750 VF C Magna V45 (RC09)	82/86							29.4632013	320	
750 VF C SuperMagna/Shadow RC28	87/90							29.4634006	340	
750 VF C/C2 Shadow (RC43)	93/02							29.4632013	320	
750 VT C Shadow (RC14)	83/85							29.4632013	320	
750 VT C/C2/CD Shadow (RC44)	97/03							29.4632013	320	
750 VT C2B ShadowPhantom (RC53)	10/13							29.4627001	270	
750 XRV Africa Twin (RD04)	90/92									29.4437502 ●
900 CB F/F2 Bol d'Or (SC01/SC09)	79/83							29.4636520	365	
1000 CBX (6 cylinder) CB1	78/81							29.4636520	365	
1000 GL Gold Wing	75/81							29.4633502	335	
1100 CB F/F2 SuperBol'dor (SC11)	83/>							29.4636520	365	
1100 CB 1100 R (SC05/08)	81/83							29.4636520	365	
1100 VF C V65 Magna (SC12)	83/86			29.82360	360			29.4636021	360	
1100 VT C Shadow (SC18)	85/88							29.4632013	320	
1100 VT C Shadow (SC23)	88/96							29.4632013	320	

HYOSUNG

125 GV Aquila/Classic/Euro 3	05/09			29.82320	320	29.4532019	320	29.4632013	320	
250 GV Aquila/FI Euro 3	04/09			29.82320	320	29.4532019	320	29.4632013	320	
650 GT Comet/R/S/RFIFI/Euro3	04/08									29.4431526 ●
650 GV Aquila/FI Euro 3	05/12			29.82300	300			29.4630002	300	

KAWASAKI

175 KDX	80/82			29.82320	320			29.4632013	320	
200 KZ	77/81			29.82320	320			29.4632013	320	
250 KZ/CSR D1/D2	80/81			29.82320	320			29.4632013	320	
250 KZ Belt CSR/LTD	82/83			29.82340	340			29.4634006	340	
250 KZ	83/85			29.82340	340			29.4634006	340	
250 KH A5	76/79			29.82320	320			29.4632013	320	
250 BJ Estrella/RS/Custom/TR	92/02			29.82300	300			29.4630002	300	
250 EL Eliminator	88/06			29.82320	320			29.4632013	320	
250 GPX R Ninja (EX 250F)	88/07									29.4432013 ●
250 Ninja R (EX 250K)	08/12									29.4432013 ●
250 ZZR (EX 250 H5/H14)	94/03									29.4230501 *
300 Ninja R / ABS (EX 300)	13									29.4432013 ●
300 Z 305 CSR/LTD	81/88			29.82330	330			29.4633008	330	
400 KZ H1	79			29.82340	340			29.4634006	340	
400 KH A3/A4/A5	76/79			29.82320	320			29.4632013	320	
400 KZ/D/D3/D4	74/77			29.82330	330			29.4633008	330	
400 KZ Special S/S2/S3	75/77			29.82330	330			29.4633008	330	
400 KZ B1/B2/C1	78/79			29.82330	330			29.4633008	330	
400 KZ J	80/85			29.82350	350			29.4635019	350	
400 KZ LTD	81/84			29.82340	340			29.4634006	340	
400 S1-A/B/C Mach I	73/75			29.82320	320			29.4632013	320	
400 S2/S2-A Mach II	72/73			29.82320	320			29.4632013	320	
400 S3/S3-A Mach II	74/75			29.82320	320			29.4632013	320	
400 Z J (KZ400J)	80/85			29.82350	350			29.4635019	350	
400 ZR Zephyr (ZR400C)	91/95			29.82350	350			29.4635019	350	
400 ZXR (L1/L9)	91/99									29.4433016 ●
440 KZ B1/B2	80/81			29.82330	330			29.4633008	330	
440 KZ LTD A1/A4	80/83			29.82340	340			29.4634006	340	

* YSS mono Eco-Line gas c/regol. precarico molla

● YSS mono Top-Line gas c/regol. precarico molla e ritorno (rebound)

Applicazioni cc marca/modello	anno	SGR meccanico c/regolaz. molla		SGR idraulico c/regolaz. molla		YSS Pro-X idraulico c/regolaz. molla		YSS Bravo idraulico c/regolaz. molla		YSS MonoShock gas	
		molla cromata corpo nero		molla cromata corpo nero		molla nera corpo nero		molla nera corpo cromato		mono ammortizzatore	
		Int. mm.	Int. mm.	Int. mm.	Int. mm.	Int. mm.	Int. mm.	Int. mm.	Int. mm.		
440 KZ LTD BELT D1/D5	80/83			29.82340	340			29.4634006	340		
454 EN 450 A1/A6	85/90			29.82330	330			29.4633008	330		
500 EN Vulcan	90/95			29.82300	300			29.4630002	300		
500 EN Vulcan	97/04							29.4631008	310		
500 ER 5 (ER 500 A1/A4)	97/00			29.82300	300			29.4630002	300		
500 ER 5 (ER 500 C1/C5)	01/05			29.82350	350			29.4635019	350		
500 H1 Mach III	69/72			29.82320	320			29.4632013	320		
500 H1 A/B/C	70/72			29.82320	320			29.4632013	320		
500 H1 D/E/F	73/75			29.82320	320			29.4632013	320		
500 KH 500	73/77			29.82320	320			29.4632013	320		
500 Z	79/80			29.82350	350			29.4635019	350		
550 GPZ (KZ 550 D1)	81			29.82350	350			29.4635019	350		
550 KZ LTD C1/C4	80/83			29.82340	340			29.4634006	340		
550 KZ D1 (GPZ550)	81			29.82350	350			29.4635019	350		
550 ZR Zephyr B1/B4	90/93			29.82350	350			29.4635019	350		
600 ZL Eliminator	86/87			29.82340	340			29.4634006	340		
600 ZL Eliminator	96/97			29.82330	330			29.4633008	330		
600 ZZR (ZX 600 D/E)	90/06									29.4437002 ●	
650 W (EJ 650)	99/04			29.82330	330			29.4633037	330		
650 KZ B1/B2/B3	77/79			29.82330	330			29.4633008	330		
650 KZ Custom C1/C2/C3	77/79			29.82330	330			29.4633008	330		
650 KZ SR D1/D2	78/79			29.82340	340			29.4634006	340		
650 KZ LTD E1	80			29.82340	340			29.4634006	340		
650 KZ F1	80			29.82340	340			29.4634006	340		
650 KZ CSR H1/H3	80/83			29.82340	340			29.4634006	340		
750 GPZ (KZ750R1)	82			29.82350	350			29.4635019	350		
750 GT (KZ750P)	82/96			29.82330	330			29.4633008	330		
750 H2 Mach IV	72/75			29.82360	360			29.4636021	360		
750 KZ B1/B4	76/79			29.82330	330			29.4633037	330		
750 KZ E1/E3	80/83			29.82340	340			29.4634006	340		
750 KZ Spectre N1/N2	82/83			29.82330	330			29.4633008	330		
750 KZ L3	83			29.82340	340			29.4634006	340		
750 KZ LTD H1/H4	80/83			29.82340	340			29.4634006	340		
750 KZ LTD II G1	80			29.82340	340			29.4634006	340		
750 KZ LTD SHAFT F1	83			29.82340	340			29.4634006	340		
750 KZ LTD BELT K1/K2	83/84			29.82340	340			29.4634006	340		
750 KZ CSR TWIN M1	82			29.82340	340			29.4634006	340		
750 KZ R1 (GPZ750)	82			29.82350	350			29.4635019	350		
750 ZR Zephyr (C1/C4)	91/94							29.4635019	350		
750 VN Vulcan	86/98							29.4632013	320		
900 Z1 Z1/A/B	73/75			29.82350	350			29.4635019	350		
900 KZ A4/A5	76/77			29.82350	350			29.4635019	350		
900 ZL Eliminator	85/86			29.82340	340			29.4634006	340		
1000 ZL Eliminator	87			29.82340	340			29.4634006	340		
1000 KZ A1/A2	77/78			29.82350	350			29.4635019	350		
1000 KZ A3/A4	79/80			29.82350	350			29.4635019	350		
1000 KZ LTD K1/K2	81/82			29.82330	330			29.4633037	330		
1000 KZ CSR M1/M2	81/82			29.82330	330			29.4633037	330		
1100 KZ LTD/Spectre	82/83			29.82340	340			29.4634006	340		
1100 GPZ	81/82			29.82350	350			29.4635019	350		
1100 ZR Zephyr (ZRT10A)	92/97							29.4635019	350		
1100 ZRX	97/99							29.4636021	360		

* YSS mono Eco-Line gas c/regol. precarico molla

● YSS mono Top-Line gas c/regol. precarico molla e ritorno (rebound)

Applicazioni cc marca/modello	anno	SGR meccanico c/regolaz. molla	Int. mm.	SGR idraulico c/regolaz. molla	Int. mm.	YSS Pro-X idraulico c/regolaz. molla	Int. mm.	YSS Bravo idraulico c/regolaz. molla	Int. mm.	YSS MonoShock gas
		molla cromata corpo nero conf. singola		molla cromata corpo nero conf. singola		molla nera corpo nero coppia		molla nera corpo cromato coppia		mono ammortizzatore
1200 ZRX / R / S (ZR A/B)	01/04							29.4636021	360	
1500 VN Vulcan 88	87/95							29.4633037	330	
1500 VN Vulcan/L	96/99							29.4633037	330	

KYMCO

125 Zing	97/98			29.82300	300			29.4630002	300	
150 Zing	97/98			29.82300	300			29.4630002	300	

LAVERDA

350 Twin	78/79			29.82330	330			29.4633010	330	
500 Twin Alpino/S/Montjuic	77/82			29.82330	330			29.4633010	330	
750 GT/GTL/S/SF/SFC	69/77			29.82350	350					
1000 RGS/RGA/SFC	72/89			29.82360	360					
1200 MIRAGE	78/81			29.82360	360					

MALAGUTI

50 Fifty Full CX	87/88	29.83320	320	29.82320	320					
50 Fifty HF	89/90	29.83320	320	29.82320	320					
50 Fifty RV	88/93	29.83320	320	29.82320	320					

MBK/MOTOBECANE

50 Swing		29.83300	300							
50 Passion		29.83320	320							
50 Mag Max		29.83320	320							
50 Hard Rock		29.83320	320							
50 Evasion		29.83320	320							
50 NN5		29.83280	280							
50 NM32		29.83300	300							
50 NL91-NN60-NM62/70/90		29.83280	280							
50 103 Variatore		29.83320	320							
50 103 Monomarcia		29.83320	320							

MOTO GUZZI

50 Magnum	79/>	29.83260	260	29.871351*	260					
125 Stornello 4M - int.320	61/>	29.83320	320	29.82320	320					
125 Stornello 5M - int.300	72/>	29.83300	300	29.82300	300					
125 Stornello Scrambler - int.350				29.82350	350					
125 Stornello Scrambler 5M - int.330	72/>			29.82330	330					
125 Turismo	81/85	29.83320	320	29.82320	320					
160 Stornello - int.330				29.82330	330					
160 Stornello 5M - int.300	72/>	29.83300	300	29.82300	300					
250 TS	74/81			29.82320	320					
250 254	75/81			29.82320	320					
350 350/400 GTS	74/79			29.82330	330					
350 Nevada	93/97			29.82400	400					
350 Nevada Club	98/99			29.82400	400					
350 V 35	75/79			29.82320	320			29.4632013	320	
350 V 35 II	80/85			29.82310	310	29.4531009	310	29.4631008	310	
350 V 35 III	85/87			29.82330	330			29.4633008	330	
350 V 35 Imola	79/83			29.82310	310	29.4531009	310	29.4631008	310	

* YSS mono Eco-Line gas c/regol. precarico molla

● YSS mono Top-Line gas c/regol. precarico molla e ritorno (rebound)

Applicazioni cc marca/modello	anno	SGR meccanico c/regolaz. molla	Int. mm.	SGR idraulico c/regolaz. molla	Int. mm.	YSS Pro-X idraulico c/regolaz. molla	Int. mm.	YSS Bravo idraulico c/regolaz. molla	Int. mm.	YSS MonoShock gas
		molla cromata corpo nero conf. singola		molla cromata corpo nero conf. singola		molla nera corpo nero coppia		molla nera corpo cromato coppia		mono ammortizzatore
350 V 35 Imola II	84/87			29.82330	330			29.4633008	330	
350 V 35 C	82/86			29.82330	330			29.4633008	330	
350 V 35 Florida	86/90			29.82330	330			29.4633008	330	
350 V 35 PA/Polizia/Carabinieri	90/01			29.82340	340			29.4634006	340	
500 Nuovo Falcone/Militare	69/77			29.82320	320			29.4632013	320	
500 V 50	76/79			29.82320	320			29.4632013	320	
500 V 50 III	80/85			29.82310	310	29.4531009	310	29.4631008	310	
500 V 50 C	82/86			29.82330	330			29.4633008	330	
500 V 50 Monza	80/83			29.82310	310	29.4531009	310	29.4631008	310	
500 V 50 Monza II	84/87			29.82330	330			29.4633008	330	
500 V 50 III PA/Polizia/Carabinieri	82/90			29.82310	310	29.4531009	310	29.4631008	310	
500 V 50 PA/Polizia/Carabinieri	92/01			29.82340	340			29.4634006	340	
650 65 GT	87/89			29.82320	320			29.4632013	320	
650 V 65/V65 SP	82/85			29.82320	320			29.4632013	320	
650 V 65 Custom	83/86			29.82330	330			29.4633008	330	
650 V 65 Florida	85/92			29.82330	330			29.4633008	330	
650 V 65 Lario	84/87			29.82330	330			29.4633008	330	
650 V 65 PA/Polizia/Carabinieri	88/95			29.82340	340			29.4634006	340	
700 V 7	67/75			29.82320	320			29.4632013	320	
700 V 7/Polizia/Carabinieri	76/>			29.82320	320			29.4632013	320	
750 Nevada	93/97			29.82400	400					
750 Nevada Club	98/01			29.82400	400					
750 V 7 Ambassador	68/>			29.82320	320			29.4632013	320	
750 V 7 Special	69/71			29.82320	320			29.4632013	320	
750 V 7 GT California/Police	71/>			29.82320	320			29.4632013	320	
750 V 7 Sport	71/74			29.82320	320			29.4632013	320	
750 V 75 PA/Polizia/Carabinieri	92/01			29.82340	340			29.4634006	340	
750 S	74/>			29.82320	320			29.4632013	320	
750 S3	75/>			29.82320	320			29.4632013	320	
750 SP	90/92			29.82330	330			29.4633008	330	
750 Strada	93/95			29.82330	330			29.4633008	330	
750 Targa	90/92			29.82330	330			29.4633008	330	
850 V 7 Eldorado	72/>			29.82320	320			29.4632013	320	
850 V7 California Police	72/>			29.82320	320			29.4632013	320	
850 V 7 GT/GT California	72/74			29.82320	320			29.4632013	320	
850 T/Interceptor	73/75			29.82320	320			29.4632013	320	
850 T3	75/78			29.82320	320			29.4632013	320	
850 T3	79/84			29.82320	320			29.4632013	320	
850 T3 California	75/78			29.82320	320			29.4632013	320	
850 T3 California	79/85			29.82320	320			29.4632013	320	
850 T3 Polizia/Carabinieri	75/78			29.82330	330			29.4633008	330	
850 T3 Polizia/Carabinieri	79/84			29.82320	320			29.4632013	320	
850 T4	80/85			29.82320	320			29.4632013	320	
850 T5 Civile III	84/87			29.82340	340			29.4634006	340	
850 T5 PA/Polizia/Carabinieri	83/89			29.82330	330			29.4633008	330	
850 T5 PA/Polizia/Carabinieri	88/01			29.82340	340			29.4634006	340	
850 Le Mans	76/78			29.82320	320			29.4632013	320	
850 Le Mans II/CX 100	79/82			29.82320	320			29.4632013	320	
850 Le Mans III	80/85			29.82330	330			29.4633008	330	
1000 Le Mans IV/V	84/93			29.82340	340			29.4634006	340	
1000 V I-Convert	75/84			29.82320	320			29.4632013	320	

* YSS mono Eco-Line gas c/regol. precarico molla

● YSS mono Top-Line gas c/regol. precarico molla e ritorno (rebound)

Applicazioni cc marca/modello	anno	SGR meccanico c/regolaz. molla	Int. mm.	SGR idraulico c/regolaz. molla	Int. mm.	YSS Pro-X idraulico c/regolaz. molla	Int. mm.	YSS Bravo idraulico c/regolaz. molla	Int. mm.	YSS MonoShock gas
		molla cromata corpo nero		molla cromata corpo nero		molla nera corpo nero		molla nera corpo cromato		mono ammortizzatore
		conf. singola		conf. singola		coppia		coppia		
1000 California II	81/87			29.82330	330			29.4633008	330	
1000 California III Carb./IE	87/93			29.82340	340			29.4634006	340	
1000 G5/PA	78/85			29.82320	320			29.4632013	320	
1000 GT	87/91			29.82340	340			29.4634006	340	
1000 SP/SP NT	78/84			29.82320	320			29.4632013	320	
1000 SP II/III	84/87			29.82340	340			29.4634006	340	
1000 S	89/94			29.82340	340			29.4634006	340	
1000 Strada	93/94			29.82340	340			29.4634006	340	
1100 California	94/97							29.4634006	340	
1100 California EV (EV11)	97/00							29.4634006	340	
1100 California Special	99/00							29.4634006	340	
1100 California Jackal	99/01							29.4634006	340	
1100 California Sport/Special Sport	01/03							29.4634006	340	
1100 California Stone/Metal	01/05							29.4634006	340	
1100 California Aluminum/Titanium	02/05							29.4634006	340	

MOTO MORINI

50 Corsarino V/Z/ZZ		29.83300	300	29.82300	300					
98 Sbarazzino		29.83280	280							
125 H Strada	75/85	29.83300	300	29.82300	300					
125 Corsaro SuperSport	69/75	29.83280	280							
125 Corsaro Sport Lusso	69/75	29.83280	280							
125 Corsaro Veloce	61/62	29.83280	280							
150 Corsaro GranTurismo	64/>	29.83280	280							
150 Corsaro SuperSport	69/75	29.83280	280							
250 T Strada	77/80			29.82300	300			29.4630002	300	
250 J Strada 2C	80/85			29.82300	300			29.4630002	300	
350 T/S/K 3 1/2 Strada/GT/Sport	73/87			29.82300	300			29.4630002	300	
500 W/T/S/SEI-V/Special	79/85			29.82310	310	29.4531009	310	29.4631008	310	
350 Excalibur/RLX	86/92			29.82320	320			29.4632013	320	
350 New York	88/91			29.82330	330			29.4633008	330	
500 501 Excalibur/RLX	86/92			29.82320	320			29.4632013	320	
500 501 New York	88/91			29.82330	330			29.4633008	330	

MV AGUSTA

99 Checca GTES	60/70	29.83280	280							
350 B Turismo	70/>			29.82300	300			29.4630002	300	
350 Sport/Ipotesi	75/>			29.82320	320			29.4632013	320	
750 S/America	75/>			29.82340	340			29.4634006	340	

MZ

125 ETZ	77/>			29.82360	360					
150 TS	77/>			29.82360	360					
250 ETZ	77/>			29.82360	360					
250 TS	77/>			29.82360	360					
250 251 Saxon	93/>			29.82360	360					
250 251 ETZ	96/>			29.82360	360					
300 301 ETZ	96/>			29.82360	360					

* YSS mono Eco-Line gas c/regol. precarico molla

● YSS mono Top-Line gas c/regol. precarico molla e ritorno (rebound)

Applicazioni cc marca/modello	anno	SGR meccanico c/regolaz. molla	Int. mm.	SGR idraulico c/regolaz. molla	Int. mm.	YSS Pro-X idraulico c/regolaz. molla	Int. mm.	YSS Bravo idraulico c/regolaz. molla	Int. mm.	YSS MonoShock gas
		molla cromata corpo nero		molla cromata corpo nero		molla nera corpo nero		molla nera corpo cromato		mono ammortizzatore
		conf. singola		conf. singola		coppia		coppia		

NORTON

750 Commando MKI/S/Roadster	68/74			29.82330	330			29.4633037	330	
850 Commando MK II/III	73/77			29.82330	330			29.4633037	330	
850 Commando	88/94			29.82340	340			29.4634006	340	

PEUGEOT

50 103 MVL	</94	29.83320	320							
50 103 VOGSM Monomarcia	95/98	29.83320	320							

PIAGGIO

50 Superbravo/3	85/90	29.83260	260							
50 Bravo	75/>	29.83280	280							

SUZUKI

125 GN	82/01			29.82330	330	29.4533034	330			
125 GP	78/81			29.82300	300			29.4630002	300	
125 GS	82/00			29.82320	320	29.4532019	320			
125 GZ Marauder	98/04			29.82320	320	29.4532019	320			
125 TC	72/77			29.82300	300			29.4630002	300	
185 GT	73/77			29.82300	300			29.4630002	300	
185 TC	74/77			29.82300	300			29.4630002	300	
185 TS	73/76			29.82300	300			29.4630002	300	
250 GN	82/88			29.82310	310					
250 GS	80/81			29.82330	330			29.4633010	330	
250 GSX	80/85			29.82330	330			29.4633010	330	
250 GT	73/77			29.82300	300			29.4630002	300	
250 GZ Marauder	99/07			29.82320	320	29.4532019	320			
250 TU X	97/01			29.82320	320			29.4632013	320	
380 GT	72/77			29.82300	300			29.4630002	300	
400 DR	79/81			29.82400	400					
400 GN T/X	80/82			29.82330	330			29.4633010	330	
400 GS	77/79			29.82330	330			29.4633010	330	
400 GSF Bandit	91/94									29.4430504 ●
400 GSX E/S	77/89			29.82330	330			29.4633010	330	
400 GSX F	81/83			29.82330	330			29.4633010	330	
400 GSX L	80/81			29.82330	330			29.4633010	330	
400 GSX T	81/83			29.82330	330			29.4633010	330	
400 GSX / S Impulse (GK79A)	94/00							29.4631008	310	
425 GS E	79			29.82330	330			29.4633010	330	
450 GS E/S	80/88			29.82330	330			29.4633010	330	
450 GS L	83/88			29.82330	330			29.4633010	330	
450 GS L	96			29.82330	330			29.4633010	330	
450 GSX L	83/88			29.82330	330			29.4633010	330	
500 T J/K/L/M	71/75			29.82300	300			29.4630002	300	
500 GS/GS-E (4 cil.)	78/83			29.82330	330			29.4633010	330	
500 GS E (GM51A - 2 cil.)	89/00									29.4329006 ●
500 GS	01/07									29.4329006 ●
500 GT	76/77			29.82300	300			29.4630002	300	
550 GS E	77/79			29.82330	330			29.4633010	330	

* YSS mono Eco-Line gas c/regol. precarico molla

● YSS mono Top-Line gas c/regol. precarico molla e ritorno (rebound)

Applicazioni cc marca/modello	anno	SGR meccanico c/regolaz. molla	Int. mm.	SGR idraulico c/regolaz. molla	Int. mm.	YSS Pro-X idraulico c/regolaz. molla	Int. mm.	YSS Bravo idraulico c/regolaz. molla	Int. mm.	YSS MonoShock gas
		molla cromata corpo nero		molla cromata corpo nero		molla nera corpo nero		molla nera corpo cromato		mono ammortizzatore
		conf. singola		conf. singola		coppia		coppia		
550 GS L	80			29.82330	330			29.4633010	330	
550 GS T	81			29.82330	330			29.4633010	330	
550 GS M	82			29.82330	330			29.4633010	330	
550 GT	72/77			29.82300	300			29.4630002	300	
600 GSF Bandit/S	95/99									29.4430003 ●
600 GSF Bandit/S	00/04									29.4431526 ●
600 GSX-F (GN72A)	88/97									29.4430003 ●
600 RF R	93/>									29.4431020 ●
600 VS GL Intruder	95/97							29.4632013	320	
650 GS E	81/82			29.82330	330			29.4633010	330	
750 GS B/C/EC/N/EN	77/79							29.4633501	335	
750 GS E	77/82							29.4633501	335	
750 GS L	79/81							29.4633501	335	
750 GS S	83							29.4633501	335	
750 GS T	82/83							29.4633501	335	
750 GSX/E (GS75X - T/X/ET/EX)	80/81							29.4633501	335	
750 GSX S (GR72A)	82/84							29.4633501	335	
750 GSX-F (FK - GR78A)	89									29.4430003 ●
750 GT	72/77			29.82300	300			29.4630002	300	
750 VS GL Intruder	85/91							29.4632013	320	
800 VS GL Intruder	92/95							29.4632013	320	
850 GS G/GL	79/83			29.82330	330	29.4533034	330			
900 RF R	93/>									29.4431020 ●
1000 GS C/EC/N/EN	78/79							29.4633501	335	
1000 GS /E/H/L	79/82							29.4633501	335	
1000 GS G/GL	80/81			29.82330	330	29.4533034	330			
1000 GS S Katana	78/82							29.4633501	335	
1000 GSX S	82							29.4633501	335	
1100 GS E/ES	79/83							29.4633501	335	
1100 GS G/GL	82/83			29.82330	330	29.4533034	330			
1100 GS L	80/82							29.4633501	335	
1100 GS S	83							29.4633501	335	
1100 GSX E/ES	79/83							29.4633501	335	
1100 GSX S Katana	80/84							29.4633501	335	
1100 GSX-R	89/98									29.4431526 ●
1200 GSF Bandit/S	96/00									29.4430523 ●
1200 GSF Bandit/S	01/05									29.4432516 ●

TRIUMPH

500 Daytona	69/79			29.82330	330			29.4633010	330	
500 Trophy/T-100R	69/79			29.82330	330			29.4633010	330	
650 T-110/Thunderbird 6T	69/79			29.82330	330			29.4633010	330	
650 TR-6R/6C Trophy	69/79			29.82330	330			29.4633010	330	
650 T-120/R Bonneville	69/79			29.82330	330			29.4633010	330	
750 TR-7V Tiger	69/79			29.82330	330			29.4633010	330	
750 TSX Bonneville	81/84			29.82340	340			29.4634006	340	
750 T-140V Bonneville	69/79			29.82330	330			29.4633010	330	
750 T-150/V Trident	69/79			29.82330	330			29.4633010	330	
750 T-160V	69/79			29.82330	330			29.4633010	330	

* YSS mono Eco-Line gas c/regol. precarico molla

● YSS mono Top-Line gas c/regol. precarico molla e ritorno (rebound)

Applicazioni cc marca/modello	anno	SGR meccanico c/regolaz. molla	Int. mm.	SGR idraulico c/regolaz. molla	Int. mm.	YSS Pro-X idraulico c/regolaz. molla	Int. mm.	YSS Bravo idraulico c/regolaz. molla	Int. mm.	YSS MonoShock gas
		molla cromata corpo nero conf. singola		molla cromata corpo nero conf. singola		molla nera corpo nero coppia		molla nera corpo cromato coppia		mono ammortizzatore

YAMAHA

125 DT R	89/92									29.4441001 ●
125 DT R	99/00									29.4441001 ●
125 DT RE	05/06									29.4441001 ●
125 SR (2JW)	87/88			29.82300	300			29.4630002	300	
125 SR / SE (3MW)	89/00			29.82300	300			29.4630002	300	
125 XV Virago	97/00			29.82300	300			29.4630002	300	
125 XVS Drag Star	00/04			29.82300	300			29.4630002	300	
125 YBR (5VL/3D9/51D)	03/12			29.82340	340			29.4634006	340	
250 RD	73/78			29.82330	330			29.4633008	330	
250 SR / SE/Exciter (3Y8)	80/82			29.82300	300			29.4630002	300	
250 SR / Classic (21L)	91/00			29.82300	300			29.4630002	300	
250 SR SP (3TH)	90-96			29.82300	300			29.4630002	300	
250 SRV	97/99			29.82320	320			29.4632013	320	
250 XS	77/81			29.82320	320			29.4632013	320	
250 XV Virago	89/99			29.82300	300			29.4630002	300	
250 XVS Drag Star	01/04			29.82300	300			29.4630002	300	
250 YBR	07/12									29.4228011 *
350 RD	73/78			29.82330	330			29.4633008	330	
360 XS	76/77			29.82320	320			29.4632013	320	
400 RD	73/79			29.82330	330			29.4633008	330	
400 SR	78/88			29.82320	320			29.4632013	320	
400 SRX	85/89			29.82300	300			29.4630002	300	
400 XJ	80/85			29.82330	330			29.4633008	330	
400 XJR	96/04							29.4633037	330	
400 XS	77/82			29.82320	320			29.4632013	320	
500 SR	78/95			29.82320	320			29.4632013	320	
500 TX	73/74			29.82320	320			29.4632013	320	
500 XS	75/78			29.82320	320			29.4632013	320	
500 XT	76/85			29.82360	360					
535 XV Virago/DX/SE	88/03			29.82310	310			29.4631008	310	
550 XJ	81/83			29.82330	330			29.4633008	330	
600 YX Radian	86/90			29.82320	320			29.4632013	320	
600 SRX	85/89			29.82300	300			29.4630002	300	
650 TX (TX650A)	74/76			29.82320	320			29.4632013	320	
650 XJ	80/83			29.82320	320			29.4632013	320	
650 XS (XS650B/C)	74/76			29.82320	320			29.4632013	320	
650 XS / S	77/81			29.82330	330			29.4633008	330	
650 XS S Heritage/Special	81/83			29.82330	330			29.4633008	330	
750 FZX	86/93							29.4632013	320	
750 XJ R Seca (11M)	81/84			29.82320	320			29.4632013	320	
750 XJ E/F (41Y/42M)	83/88			29.82310	310			29.4631008	310	
750 XS /SE/SF/2D	76/80			29.82320	320			29.4632013	320	
750 XV Virago	92/97			29.82310	310			29.4631008	310	
850 XS	80/81			29.82320	320			29.4632013	320	
900 XJ/F/R Seca	83/94			29.82310	310			29.4631008	310	
1000 XV Virago	84/85			29.82310	310			29.4631008	310	
1100 XS	78/84			29.82320	320			29.4632013	320	
1100 XV Virago	86/88			29.82310	310			29.4631008	310	
1200 XJR	94/98							29.4633037	330	
1300 XJR	99/13							29.4633037	330	

* YSS mono Eco-Line gas c/regol. precarico molla

● YSS mono Top-Line gas c/regol. precarico molla e ritorno (rebound)

Figurato e misure coppie ammortizzatori "YSS" moto

Fig.	Codice SGR	Descrizione	Int. mm.	Attacco superiore	Attacco inferiore	Dati molla Ø int./carico(1/2) lungh.tot.	Amm.re
COPPIE SERIE "PRO-X" - ATTACCHI OCCHIELLO/OCCHIELLO							
1	29.4531009	Coppia ammortizzatori serie Pro-X	310	O 10 x 22	O 10 x 22	46-13-18-180	soft
1	29.4532019	Coppia ammortizzatori serie Pro-X	320	O 12 x 20	O 12 x 20	38-13-18-200	soft
1	29.4533034	Coppia ammortizzatori serie Pro-X	330	O 12 x 20	O 12 x 20	38-13-18-200	soft
COPPIE SERIE "BRAVO" ATTACCHI OCCHIELLO/OCCHIELLO							
2	29.4627001	Coppia ammortizzatori serie Bravo	270	O 14 x 20	O 10 x 20	46-25-45-140	hard
2	29.4630002	Coppia ammortizzatori serie Bravo	300	O 14 x 20	O 14 x 20	46-17-25-160	medium
2	29.4631008	Coppia ammortizzatori serie Bravo	310	O 14 x 20	O 14 x 20	46-25-45-180	hard
2	29.4631027	Coppia ammortizzatori serie Bravo	310 (12")	O 12,9 x 28	O 12,9 x 28	46-20-30-180	medium
2	29.4632013	Coppia ammortizzatori serie Bravo	320	O 14 x 20	O 14 x 20	46-25-35-180	hard
2	29.4633008	Coppia ammortizzatori serie Bravo	330	O 14 x 20	O 14 x 20	46-20-30-200	medium
2	29.4633010	Coppia ammortizzatori serie Bravo	330	O 12 x 24	O 12 x 24	46-17-25-200	medium
2	29.4633037	Coppia ammortizzatori serie Bravo	330	O 14 x 20	O 10 x 20	46-20-30-200	medium
2	29.4633047	Coppia ammortizzatori serie Bravo	330 (13")	O 12,9 x 28	O 12,9 x 32	46-20-30-200	medium
2	29.4634001	Coppia ammortizzatori serie Bravo	340	O 16 x 20	O 10 x 20	46-25-35-200	hard
2	29.4634006	Coppia ammortizzatori serie Bravo	340	O 14 x 20	O 14 x 20	46-20-30-200	medium
2	29.4635002	Coppia ammortizzatori serie Bravo	350 (13.75")	O 12,9 x 32	O 12,9 x 32	46-20-30-220	medium
2	29.4635006	Coppia ammortizzatori serie Bravo	350	O 16 x 20	O 16 x 20	46-25-35-220	hard
2	29.4635019	Coppia ammortizzatori serie Bravo	350	O 14 x 20	O 10 x 20	46-20-30-220	medium
2	29.4635020	Coppia ammortizzatori serie Bravo	350	O 10 x 20	O 16 x 20	46-17-25-220	medium
2	29.4636021	Coppia ammortizzatori serie Bravo	360	O 14 x 20	O 10 x 20	46-25-45-220	hard
COPPIE SERIE "BRAVO" ATTACCHI OCCHIELLO/FORCHETTA							
3	29.4631016	Coppia ammortizzatori serie Bravo	310	O 16 x 24	F.20 x M10	46-17-25-180	medium
3	29.4632029	Coppia ammortizzatori serie Bravo	320	O 16 x 26	F.20 x M10	46-17-25-200	medium
3	29.4633501	Coppia ammortizzatori serie Bravo	335	O 12 x 20	F.22 x 10	46-20-30-180	medium
3	29.4633502	Coppia ammortizzatori serie Bravo	335	O 16 x 24	F.20 x M10	46-20-30-180	medium
3	29.4636520	Coppia ammortizzatori serie Bravo	360	O 16 x 24	F.20 x M10	46-20-30-200	medium

Serie "Pro-X": idraulico c/regolazione a 5 scatti precarico molla - pistone 22 mm. - stelo Ø 10 mm.

Serie "Bravo": idraulico c/regolazione a 5 scatti precarico molla - pistone 22 mm. - stelo Ø 12 mm.

LEGENDA ATTACCO: O = occhiello / diametro per profondità • F = forchetta / larghezza per diametro foro o filetto (M)

Dati molla, esempio: 46-13-18-180 = Ø interno 46 mm. - carico parte 1: 13Newton/metri - carico parte 2: 18Newton/metri - lunghezza 180 mm.



Fig. 1



Fig. 2



Fig. 3

Figurato e misure monoammortizzatori a gas "YSS" moto

Fig.	Codice SGR	Descrizione	Int. mm.	Attacco superiore	Attacco inferiore	Dati molla Ø int./carico(1/2) lungh.tot.	Ø molla	Colore molla	Ammortizz.re
ATTACCO OCCHIELLO/OCCHIELLO									
1	29.4226506	Gas serie Ecoline "E302"	265	O 10 x 25	O 10 x 25	46-135-150	11	rosso	hard
2	29.4426503	Gas serie Topline "Z366"	265	O 10 x 30	O 10 x 30	46-200-350-100	11	rosso	hard +
3	29.4229001	Gas serie Ecoline "E302"	290*	O 12 x 30 H.30	O 12 x 24	46-105-190-160	11	rosso	medium/hard
4	29.4430011	Gas serie Topline "Z366"	300*	O 12 x 24	O 10 x 38	46-250-500-120		rosso	hard
4	29.4431022	Gas serie Topline "Z366"	310*	O 10 x 34/36	O 10 x 36	46-170-175	12,5	rosso	hard
4	29.4431025	Gas serie Topline "Z366"	310*	O 10 x 30	O 10 x 39	60-200-150		rosso	hard +
5	29.4235001	Gas serie Ecoline "E302"	350	O 12 x 22	O 12 x 22	46-45-60-200	9,5	nero	soft
5	29.4236505	Gas serie Ecoline "E302"	365	O 10 x 22	O 10 x 22	46-85-220	11	nero	medium/hard
6	29.4438003	Gas serie Topline "Z366"	380*	O 12 x 22/24	O 12 x 22/24+20	46-30-50-220	9,5	rosso	soft
7	29.4438501	Gas serie Topline "Z366"	385*	O 12 x 22	O 12 x 22	46-55-240	9,5	nero	soft
8	29.4341006	Gas serie Topline "Z302"	410	O 15.1 x 22	O 15.1 x 22	46-80-220	11	nero	medium/hard
9	29.4441001	Gas serie Topline "Z366"	410	O 12 x 40	O 12 x 30	53-55-75-245	11	rosso	medium

ATTACCO OCCHIELLO/FORCHETTA

10	29.4228006	Gas serie Ecoline "E302"	280	O 10 x 34/36	F.26 x 8	46-130-110	11	rosso	hard
11	29.4228011	Gas serie Ecoline "E302"	280	O 12 x 30	F.30 x 12	46-115-150	11	rosso	medium/hard
12	29.4329006	Gas serie Topline "Z302"	290*	O 10 x 30	F.30 x 10	46-115-150	11	rosso	medium/hard
12	29.4430003	Gas serie Topline "Z366"	300	O 10 x 30	F.30 x M10	46-80-160	11	rosso	medium/hard
12	29.4430502	Gas serie Topline "Z366"	305	O 10 x 28/30+20	F.32 x 10	46-170-120	11	rosso	hard
12	29.4430523	Gas serie Topline "Z366"	305	O 10 x 30	F.30 x 10	46-100-150	11	rosso	medium/hard
12	29.4430504	Gas serie Topline "Z366"	305	O 10 x 30	F.30 x 10	60-85-175	11	rosso	medium/hard
13	29.4230501	Gas serie Ecoline "E302"	305	O 12 x 28+10	F.33 x 12	46-80-185	11	rosso	medium/hard
12	29.4431020	Gas serie Topline "Z366"	310	O 10 x 30	F.30 x 10	46-80-185	11	rosso	medium/hard
14	29.4431526	Gas serie Topline "Z366"	315*	O 10 x 30	F.30 x 10	46-135-150	11	rosso	hard
14	29.4432013	Gas serie Topline "Z366"	320*	O 12 x 30	F.32 x 12	46-80-160	9,5	rosso	medium/hard
14	29.4432516	Gas serie Topline "Z366"	325	O 10 x 30	F.30 x M10	46-135-150	11	rosso	hard
14	29.4433016	Gas serie Topline "Z366"	330	O 12 x 28	F.30 x 12	60-75-175	11	rosso	medium
14	29.4433502	Gas serie Topline "Z366"	335*	O 10 x 35	F.26 x M10	46-170-175	12,5	rosso	hard
14	29.4437002	Gas serie Topline "Z366"	370*	O 12 x 30	F.40 H.45 x 12	46-90-220	11	rosso	medium/hard
14	29.4437502	Gas serie Topline "Z366"	375*	O 10 x 30	F.30 x M10	60-130-220		rosso	hard

Serie Ecoline "E302": gas con regolazione a ghiera precarico molla - pistone 30 mm. - stelo Ø 12 mm.

Serie Topline "Z302": gas con regolazione a ghiera precarico molla e ritorno (rebound) - pistone 30 mm. - stelo Ø 12 mm.

Serie Topline "Z366": gas con regolazione a ghiera precarico molla e ritorno (rebound) - pistone 36 mm. - stelo Ø 16 mm.

LEGENDA ATTACCO: O = occhio / diametro per profondità • F = forchetta / larghezza per diametro foro o filetto (M) • H altezza
* lunghezza regolabile

Dati molla, esempio 1: 46-135-150 = Ø interno 46 mm. - carico 135Newton/metri - lunghezza 150 mm.

Dati molla, esempio 2: 46-200-350-100 = Ø interno 46 mm. - carico parte 1: 200Newton/metri - carico parte 2: 350Newton/metri - lunghezza 100 mm.



Fig. 1



Fig. 2



Fig. 3



Fig. 4



Fig. 5



Fig. 6



Fig. 7



Fig. 8



Fig. 9



Fig. 10



Fig. 11



Fig. 12



Fig. 13



Fig. 14

Figurato ammortizzatori "SGR" per ciclomotori e moto

Ammortizzatore meccanico c/regolazione molla

molla cromata • corpo nero • fori Ø 10x19

Modelli disponibili
(venduti singolarmente):

Cod. SGR	int. mm.
29.83220	220
29.83260	260
29.83280	280
29.83300	300
29.83320	320



Ammortizzatore idraulico c/regolazione molla

molla cromata • corpo nero • fori Ø 14x22 c/riduzioni a corredo corsa 40 mm.

Modelli disponibili
(venduti singolarmente):

Cod. SGR	int. mm.
29.871351 *	260
29.82300	300
29.82310	310
29.82320	320
29.82330	330
29.82340	340
29.82350	350
29.82360	360
29.82400	400

* molla rossa - fori Ø 10 - corsa 60 mm.



Tabella applicazioni ammortizzatori sterzo e forcella Aprilia/Moto Guzzi

Applicazioni cc marca/modello	anno	Ammortizz. sterzo	Int. mm.	Riferimento originale	Ammortizz. forcella	Int. mm.	Riferimento originale
APRILIA							
500 Atlantic	01/04	29.86431	150	AP8163164			
500 Scarabeo	03/06	29.86431	150	AP8163164			
MOTO GUZZI							
350 V 35 - V 35 II	75/85				29.86350	270	GU14526407
350 V 35 C - V 35 Florida	82/90	29.86431	150	GU17530260			
500 V 50	76/79				29.86350	270	GU14526407
500 V 50 C	82/86	29.86431	150	GU17530260			
500 V 50 III PA/Polizia/Carabinieri	82/90				29.86350	270	GU14526407
650 V 65 Custom - V 65 Florida	83/92	29.86431	150	GU17530260			
650 V 65 PA/Polizia/Carabinieri	88/95	29.86431	150	GU17530260			
750 V 7 California/Police	71/>	29.86400	170	13530240			
750 V 7 Sport	71/74	29.86400	170	13530240	29.86350	270	14526405
750 S	74/>	29.86400	170	GU14530201	29.86350	270	GU14526407
750 S3	75/>				29.86350	270	GU14526407
850 V 7 GT/California/Police	72/74	29.86400	170	13530240			
850 T/Interceptor	73/75				29.86350	270	GU14526407
850 T3	75/85				29.86350	270	GU14526407
850 T3 California/Polizia/Carabinieri	75/85	29.86400	170	GU14530201	29.86350	270	GU14526407
850 T4	80/85	29.86400	170	GU14530201	29.86351	265	GU14526455
850 T5 Civile III/PA/Polizia/Carabinieri	83/01	29.86431	150	GU17530260			
850 Le Mans	76/78	29.86400	170	GU14530201	29.86350	270	GU14526407
850 Le Mans II/CX 100	79/82	29.86431	150	GU17530260	29.86351	265	GU18526460
850 Le Mans III	80/85	29.86431	150	GU17530260			
1000 Le Mans IV/V	84/93	29.86431	150	GU17530260			
1000 V I-Convert	75/84	29.86400	170	GU14530201	29.86350	270	GU14526407
1000 California II / III Carb./ III i.e.	81/93	29.86431	150	GU17530260			
1000 G5/PA	78/85	29.86400	170	GU14530201	29.86351	265	GU18526460
1000 SP/SP NT	78/84	29.86431	150	GU03530270	29.86351	265	GU14526455
1000 SP II/III	84/87	29.86431	150	GU17530260			
1000 S - 1000 Strada	89/94	29.86431	150	GU17530260			
1100 California/EV/PI./EV Touring	94/05	29.86431	150	GU03530270			
1100 California Jackal/Sport/Special	99/03	29.86431	150	GU03530270			
1100 California Stone/Metal/Alum./Titan.	01/05	29.86431	150	GU03530270			
1100 California Classic/Touring/Vintage	06/09	29.86431	150	883155			
1100 California Aquila Nera	10/13	29.86431	150	883155			

**Ammortizzatore di sterzo
c/frenata fissa**



Cod. SGR	int. mm.
29.86400	165/261±2

**Ammortizzatore di sterzo
c/frenata registrabile**



Cod. SGR	int. mm.
29.86431	145/260

Ammortizzatore forcella



Cod. SGR	int. mm.
29.86350	268/396±2
29.86351	264/411±2

Tabella cavalletti

Applicazioni cc marca/modello	anno	figura	CENTRALE			LATERALE							
			kit codice	nudo codice	accessori codice	simil OEM		opzionale nero		opzionale cromato			
						lato	codice	lato	codice	lato	codice		
APRILIA													
50 Area 51	98/00							SX	48.3332				
50 Gulliver Air	95/00							SX	48.3106				
50 Gulliver Lc	95/00							SX	48.3106				
50 Habana / Habana Custom	99/03	78	48.5340		48.9224						SX	48.3001	
50 Rally Air DT	95/99	2		48.1022	ND			SX	48.3100		SX	48.3010	
50 Rally Lc DD	96/00	2		48.1022	ND			SX	48.3100		SX	48.3010	
50 Rally Lc DT	96/00	2		48.1022	ND			SX	48.3100		SX	48.3010	
50 RX (PV00/PVA00)	06/08							SX	48.3109				
50 RX (PV00/PVA00)	09/13							SX	48.3151				
50 RX AE	89/90							SX	48.3109				
50 RX R 6V	95/98							SX	48.3109				
50 RX R AE 3V (HB)	92/93							SX	48.3109				
50 RX R AE 5V (LR)	94							SX	48.3109				
50 Scarabeo 2T DD (PF010/PFG10)	98/99	1		48.1013	ND								
50 Scarabeo 2T DT (HS/LE/T/PF00/PFG00)	98/99	1		48.1013	ND								
50 Scarabeo 2T Hiper2 (THG00)	10	22	48.5112		48.9176								
50 Scarabeo 2T Hiper2 Net (THG00)	10/12	22	48.5112		48.9176								
50 Scarabeo 4T/Rst 4T (TG000/TGA00/TGB00)	03/10	25	48.5146		48.9227								
50 Scarabeo 4T 4V (TGE00)	09/12	25	48.5146		48.9227								
50 Scarabeo 4T 4V Net (TGE00)	10/12	25	48.5146		48.9227								
50 Scarabeo Ditech	01/06	10		48.1055	ND								
50 Scarabeo Street 2T DD (PFG10)	00/05	1		48.1013	ND								
50 Scarabeo Street 2T Hiper2 (THE00)	05/06	22	48.5112		48.9176								
50 Scarabeo Street Rst 2T Hiper2 (THG00)	06/09	22	48.5112		48.9176								
50 Sonic / Sonic GP LC	98/00							SX	48.3103		SX	48.3013	
50 Sportcity One 4T (SB00/SBC00)	08/12	67	48.5292		48.9194								
50 SR Ditech (RLB1/RLD1)	00/06							SX	48.3333		SX	48.3016	
50 SR H2O Racing/Sport (RLA1)	00/04	3		48.1031	ND			SX	48.3333		SX	48.3016	
50 SR Netscaper	97/99	2		48.1022	ND			SX	48.3100		SX	48.3010	
50 SR R Factory Hiper2 (VFD)	05/10	26	48.5149		48.9176								
50 SR R Factory IE Purejet (VFB)	05/13	26	48.5149		48.9176								
50 SR R Hiper2 (VFD)	05/13	26	48.5149		48.9176								
50 SR Racing	97/00	2		48.1022	ND			SX	48.3100		SX	48.3010	
50 SR Sport	97/00							SX	48.3100		SX	48.3010	
50 SR Stealth	97/99	2		48.1022	ND			SX	48.3100		SX	48.3010	
50 SR Street H2O Hiper2 (TEA00)	03/13	26	48.5149		48.9176			SX	48.3334		SX	48.3019	
50 SR Street Purejet (TE000)	03/11	26	48.5149		48.9176			SX	48.3334		SX	48.3019	
50 SR WWW	97/00	2		48.1022	ND								
100 Scarabeo 4T/Rst 4T/Net 4T (VAA00/VAC00)	01/09	25	48.5146		48.9227								
100 Scarabeo 4T E3 (VAC00/VAA00)	10/12	25	48.5146		48.9227								
100 Scarabeo 4T Net E3 (ZD4VAC/ZD4VAA)	10/12	25	48.5146		48.9227								
125 Leonardo	96/98	9		48.1052	ND								
125 Scarabeo 4T Rotax	99/02	8		48.1049	ND	SX	48.2010						
125 Scarabeo GT 4T Piaggio	03/06							SX	48.3082		SX	48.3004	
125 Scarabeo GT E3 4T Piaggio (TD005/TDA03)	06/07							SX	48.3082		SX	48.3004	
125 Sportcity / Sportcity E3	04/09							SX	48.3088				
125 Sportcity One	08/13	67	48.5292		48.9194			SX	48.3085		SX	48.3007	
150 Leonardo	96/98	9		48.1052	ND								
150 Scarabeo 4T Rotax	99/02	8		48.1049	ND	SX	48.2010						
200 Scarabeo 4T Rotax	99/02	8		48.1049	ND	SX	48.2010						

ND = non disponibile • lato: sx = sinistro / dx = destro

Applicazioni cc marca/modello	anno	figura	CENTRALE			LATERALE					
			kit codice	nudo codice	accessori codice	simil OEM		opzionale nero		opzionale cromato	
						lato	codice	lato	codice	lato	codice
BETAMOTOR											
50 ARK	96/03							SX	48.3124	SX	48.3022
50 ARK Euro 2	03/12							SX	48.3124	SX	48.3022
50 ARK/ARK LC DD/DT	96/12							SX	48.3124	SX	48.3022
CAGIVA											
50 Mantis	98/>							SX	48.3142		
50 Progress	97/99							SX	48.3142		
DERBI											
50 Atlantis 02	02/06	75	48.5319		48.9215						
50 Atlantis 4T	07/12	68	48.5295		48.9197						
50 Atlantis Air	99/01							SX	48.3142		
50 Atlantis Lc	99/01							SX	48.3142		
50 Boulevard 4T	09/12	68	48.5295		48.9197						
50 GP 1 / E2	06/09	57	48.5262		48.9185						
50 Hunter	96/97	76	48.5334		48.9218			SX	48.3142		
50 Predator Air	98/01	76	48.5334		48.9218						
50 Predator LC	98/01	76	48.5334		48.9218						
50 Paddock	98/99	76	48.5334		48.9218						
50 Vamos	93/95	77	48.5337		48.9221						
50 Manhattan								SX	48.3142		
50 Paddock	98/99							SX	48.3142		
50 Predator Air	97/01							SX	48.3142		
50 Predator LC	98/01							SX	48.3142		
50 Senda	99/01							SX	48.3133		
50 Senda R	00/03							SX	48.3145		
50 Senda R	94/99							SX	48.3136		
50 Senda R DRD Racing (SR1A2B)	04/05							SX	48.3151		
50 Senda R DRD Racing E2 (SR1D2B)	05/08							SX	48.3151		
50 Sonar 2T	10/12	61	48.5274		48.9182						
50 Urban								SX	48.3139		
50 Variant Revolution	03/>							SX	48.3130		
50 Variant Revolution	03/>							SX	48.3139		
50 Variant Start 3 (2a Serie)								SX	48.3130		
50 Variant Start V								SX	48.3130		
50 Vriant Start 3								SX	48.3130		
50 Vriant Start 3								SX	48.3139		
50 Vriant Start V								SX	48.3139		
100 Atlantis 2T	00/01	76	48.5334		48.9218						
100 Boulevard 4T	10/12	68	48.5295		48.9197						
125 Boulevard / Boulevard E3	08/12	68	48.5295		48.9197						
125 Senda SM 4T (SC2A1A)	04							SX	48.3148		
125 Senda SM 4T (SC2B1A)	04/07							SX	48.3148		
125 Sonar	09/12	62	48.5277		48.9230						
150 Boulevard / Boulevard E3	10/12	68	48.5295		48.9197						
150 Sonar	09/12	62	48.5277		48.9230						
GILERA											
50 DNA	00/07							SX	48.3160		
50 Easy Moving	95/96	53	48.5247		48.9179						
50 ICE	01/05	58	48.5265		48.9182						
50 Runner DD/DT	97/98							SX	48.2013		

Applicazioni cc marca/modello	anno	figura	CENTRALE			LATERALE					
			kit codice	nudo codice	accessori codice	simil OEM		opzionale nero		opzionale cromato	
						lato	codice	lato	codice	lato	codice
50 Runner DD	97/01							SX	48.3163	SX	48.3025
50 Runner DT	97/01							SX	48.3163	SX	48.3025
50 Runner FL	02/07							SX	48.3163	SX	48.3025
50 Runner Poggiali	02							SX	48.3163	SX	48.3025
50 Runner Purejet / Race	05/12	58	48.5265		48.9182			SX	48.3163	SX	48.3025
50 Runner Purejet ST	08/10	58	48.5265		48.9182			SX	48.3163	SX	48.3025
50 Runner SP DD/DT	99/00							SX	48.3163	SX	48.3025
50 Runner SP Race	05/08	58	48.5265		48.9182			SX	48.3163	SX	48.3025
50 Runner SP Special Edition	07	58	48.5265		48.9182			SX	48.3163	SX	48.3025
50 Runner SP ST	08/12	58	48.5265		48.9182			SX	48.3163	SX	48.3025
50 Stalker DD/DT	97/04	58	48.5265		48.9182			SX	48.3163	SX	48.3025
50 Stalker Hiper2	03/11	58	48.5265		48.9182			SX	48.3163	SX	48.3025
50 Stalker Naked	08/12	58	48.5265		48.9182			SX	48.3163	SX	48.3025
50 Stalker Special Edition	07/08	58	48.5265		48.9182			SX	48.3163	SX	48.3025
50 Storm	94/95	58	48.5265		48.9182						
50 Storm E2	07/12	56	48.5259		48.9182						
50 Typhoon	94/97	56	48.5259		48.9182						
50 Typhoon X	98/99	56	48.5259		48.9182						
50 Typhoon XR	00	56	48.5259		48.9182						
125 Runner FX	97/02							SX	48.3163	SX	48.3025
125 Runner SP	99/02							SX	48.3163	SX	48.3025
125 Runner VX 4T	02/04							SX	48.3163	SX	48.3025
125 Runner VX SC / Race / ST 4T	05/11							SX	48.3163	SX	48.3025
180 Runner FXR	97/02							SX	48.3163	SX	48.3025
180 Runner SP	99/02							SX	48.3163	SX	48.3025
180 Runner VXR 4T	00/01							SX	48.3163	SX	48.3025
200 Runner VXR Race / ST 4T E3	06/11							SX	48.3163	SX	48.3025

HONDA

50 SFXS (AF37)	96	34	48.5173		48.9134			SX	48.3178		
50 SGX Sky	97/01							SX	48.3187		
50 SH Fifty (AF40)	96/01	27	48.5152		48.9131			SX	48.3181		
50 SJ Bali (AF32)	93/98							SX	48.3199		
50 SXR	95/>							SX	48.3178		
50 X8RS/X8RX	99/01							SX	48.3190		
100 SCV Lead (JF11)	03/07	35	48.5176		48.9128			SX	48.3166		
100 SH	96/00	27	48.5152		48.9131			SX	48.3181		
100 SJ Bali (HF07)	96/99							SX	48.3199		
110 NHX Lead	08							SX	48.3169		
125 FES Pantheon 2T (JF05)	98/02						SX	48.2052			
125 FES Pantheon 4T (JF12)	03/06	30	48.5161		48.9116		SX	48.2049			
125 NES Chiocciola (JF07)	00/06						SX	48.2046			
125 PES PS i	06/11	36	48.5179		48.9110			SX	48.3172		
125 SES Dylan (JF10)	02/04							SX	48.3193		
125 SH (JF09)	01/04	28	48.5155		48.9110			SX	48.3184		
125 SH IE (JF09)	08	28	48.5155		48.9110			SX	48.3202	SX	48.3028
125 SH IE (JF09)	05/07	28	48.5155		48.9110			SX	48.3184		
125 SH IE (JF09)	09/10	28	48.5155		48.9110			SX	48.3205	SX	48.3031
125 SH IE DD	09/12	29	48.5158		48.9113			SX	48.3205	SX	48.3031
150 FES Pantheon 2T (JF05)	98/02						SX	48.2052			
150 PES PS i	06/11	36	48.5179		48.9110			SX	48.3172		
150 SES Dylan (JF10)	02/04							SX	48.3193		
150 SH (KF04)	01/04	28	48.5155		48.9110			SX	48.3184		
150 SH IE (KF04)	08	28	48.5155		48.9110			SX	48.3202	SX	48.3028
150 SH IE (KF04)	05/07	28	48.5155		48.9110			SX	48.3184		

ND = non disponibile • lato: sx = sinistro / dx = destro

Applicazioni cc marca/modello	anno	figura	CENTRALE			LATERALE					
			kit codice	nudo codice	accessori codice	simil OEM		opzionale nero		opzionale cromato	
						lato	codice	lato	codice	lato	codice
150 SH IE (KF04)	09/10	28	48.5155		48.9110			SX	48.3205	SX	48.3031
150 SH IE DD	09/12	29	48.5158		48.9113			SX	48.3205	SX	48.3031
250 FES Foresight (MF04/MF05)	97/99	31	48.5164		48.9119						
250 FES Foresight (MF04/MF05)	00/06	32	48.5167		48.9122						
250 NSS Forza X, EX (MF08)	05/07					SX	48.2055				
250 NSS Jazz	01/04	33	48.5170		48.9125	SX	48.2058				

HUSQVARNA

50 WRS	98/>							SX	48.3142		
--------	------	--	--	--	--	--	--	----	---------	--	--

KEEWAY

50 F-ACT	07/08	23	48.5118		48.9137						
50 Focus	06	23	48.5118		48.9137						
50 Matrix	06/08	23	48.5118		48.9137						
50 RY8/SP	06/11	23	48.5118		48.9137						

KYMCO

50 Agility 2T R12	05/>	37	48.5182		48.9140						
50 Agility 4T R12	07/13	37	48.5182		48.9140						
50 Agility RS 2T R12	09/12	37	48.5182		48.9140						
125 Agility E3 R12	06/13	41	48.5193		48.9146						
125 Agility RS R12	09/13	41	48.5193		48.9146						
125 Dink Classic / E2	02	42	48.5196		48.9152						
125 Dink Classic / E2	03/06	43	48.5199		48.9155						
125 Dink LX	98/02	42	48.5196		48.9152						
125 Grand Dink / Grand Dink E2	01/02	44	48.5202		48.9149						
125 Grand Dink / Grand Dink E2	03/07	45	48.5205		48.9146						
125 People / E2	99/07	38	48.5185		48.9143						
125 People E3	07/10	38	48.5185		48.9143						
125 People E3	11/13	39	48.5188		48.9146						
125 People S / S DD	05/13	40	48.5191		48.9149						
150 Dink Classic / E2	02	42	48.5196		48.9152						
150 Dink Classic / E2	03/06	43	48.5199		48.9155						
150 Dink LX	98/02	42	48.5196		48.9152						
150 Grand Dink / Grand Dink E2	01/02	44	48.5202		48.9149						
150 Grand Dink / Grand Dink E2	03/07	45	48.5205		48.9146						
150 People / E2	99/06	38	48.5185		48.9143						
150 People E3	07/10	38	48.5185		48.9143						
200 Dink Classic	04/07	43	48.5199		48.9155						
200 People S	05/07	40	48.5191		48.9149						
200 People S IE	07/13	40	48.5191		48.9149						

MALAGUTI

50 Ciak	99/02	6	48.1043	ND							
50 Ciak Master Euro 2.3	03/05	6	48.1043	ND							
50 Ciak Mono Euro 2	03	6	48.1043	ND							
50 Ciak Mono Euro 2.3	03/05	6	48.1043	ND							
50 Ciak TD	00/01	6	48.1043	ND							
50 F10 Jet Line AC	07/08	47	48.5211	48.9158							
50 F10 Jet Line AC ECO	09/10	47	48.5211	48.9158							
50 F10 Jet Line Rst Euro 2 (ED.2003)	02/03	47	48.5211	48.9158							
50 F10 Jet Line Rst Euro 2 (ED.2006)	06/07	47	48.5211	48.9158							
50 F10 Jet Line Rst Euro 2.3	03/05	47	48.5211	48.9158							
50 F10 Jet Line/ Rst./ E1 / Kat.	92/02	47	48.5211	48.9158							

Applicazioni cc marca/modello	anno	figura	CENTRALE			LATERALE					
			kit codice	nudo codice	accessori codice	simil OEM		opzionale nero		opzionale cromato	
						lato	codice	lato	codice	lato	codice
50 F12 Phantom Air	94/98	24	48.5130		48.9217			sx	48.3247		
50 F12 Phantom Air Euro1	99/00	24	48.5130		48.9217			sx	48.3247		
50 F12 Phantom LC	94/98	24	48.5130		48.9217			sx	48.3247		
50 F12 Phantom LC Euro1	99/00	24	48.5130		48.9217			sx	48.3247		
50 F12 Phantom LC Twin Disks	98	24	48.5130		48.9217			sx	48.3247		
50 F12 Phantom R AC	07/10	46	48.5208		48.9158						
50 F12 Phantom R LC	07/10	46	48.5208		48.9158						
50 F12 Phantom Rst Air Euro 2.3	03/05	24	48.5130		48.9217			sx	48.3247		
50 F12 Phantom Rst LC Euro 2.3	03/05	24	48.5130		48.9217			sx	48.3247		
50 F12 Phantom Rst LC Euro2	06/>	24	48.5130		48.9217			sx	48.3247		
50 F12 Phantom Rst. Air E2 (ZJM46)	06/>	24	48.5130		48.9217			sx	48.3247		
50 F12 Phantom Rst. Air Euro1	01/02	24	48.5130		48.9217			sx	48.3247		
50 F12 Phantom Rst. Air Euro2	02	24	48.5130		48.9217			sx	48.3247		
50 F12 Phantom Rst. LC Euro1 (ZJM47)	01/02	24	48.5130		48.9217			sx	48.3247		
50 F12 Phantom Rst. LC Euro2 (ZJM48)	02	24	48.5130		48.9217			sx	48.3247		
50 F15 Firefox	96/05	24	48.5130		48.9217			sx	48.3214		
50 F15 Firefox / Rst / Euro 1	96/01	24	48.5130		48.9217			sx	48.3214		
50 F15 Firefox Air	96/05	24	48.5130		48.9217			sx	48.3214		
50 F15 Firefox Air Euro	05/06	24	48.5130		48.9217			sx	48.3214		
50 F15 Firefox Air Euro 2/Rst Euro 2	05/06	24	48.5130		48.9217			sx	48.3214		
50 F15 Firefox Air Rst Euro 2	05/06	24	48.5130		48.9217			sx	48.3214		
50 F15 Firefox DD/DT	96/98	24	48.5130		48.9217			sx	48.3214		
50 F15 Firefox Euro 2	02/03	24	48.5130		48.9217			sx	48.3214		
50 F15 Firefox Euro 2.3	03/04	24	48.5130		48.9217			sx	48.3214		
50 F15 Firefox Euro 2/Rst Euro 2 DD	02/03	24	48.5130		48.9217			sx	48.3214		
50 F15 Firefox Lc Euro 2/Rst Euro 2	04/05	24	48.5130		48.9217			sx	48.3214		
50 F15 Firefox LC Rst Euro 2.3	03/05	24	48.5130		48.9217			sx	48.3214		
50 F15 Firefox LC TDS Rst Euro 1 DD	01	24	48.5130		48.9217			sx	48.3214		
50 F15 Firefox Rst Euro 2.3	03/05	24	48.5130		48.9217			sx	48.3214		
50 F15 Firefox Twin Disk/Digit	98/00	24	48.5130		48.9217			sx	48.3214		
50 F15 Firefox/Kat DD	00/05	24	48.5130		48.9217			sx	48.3214		
50 F15 FirefoxTwin Disk/Digit Kat. DD	98/00	24	48.5130		48.9217			sx	48.3214		
50 Yesterday	97/00	47	48.5211		48.9158						

MBK

50 Booster L	01/03	49	48.5232		48.9164						
50 Booster Rocket	97/98							sx	48.3058		
50 Booster Track	97/98							sx	48.3058		
50 CW Booster Spirit	96/00							sx	48.3058		
50 CW RS Booster N.G.	95/00							sx	48.3058		
50 Flipper	98/04	7		48.1046	ND						
50 Mach G E1/E2	02/04							dx	48.3073	sx	48.3076
50 New Sorriso	95/96	50	48.5235		48.9167						
50 Nitro	97/00	4		48.1034	ND			sx	48.3325	sx	48.3079
50 Nitro	97/00									dx	48.3064
50 Nitro	97/00									sx	48.3067
50 Ovetto	97/00									dx	48.3061
50 Ovetto	97/00									sx	48.3070
50 Stunt	00/02	48	48.5229		48.9161					sx	48.3067
100 Nitro	00/>	4		48.1034	ND			sx	48.3325	sx	48.3079
100 Nitro	00/>									dx	48.3064
100 Nitro	00/>									sx	48.3067
100 Ovetto	00/02									dx	48.3061
100 Ovetto	00/02									sx	48.3070
250 Skyliner	00/03	51	48.5238		48.9170			sx	48.3220		

ND = non disponibile • lato: sx = sinistro / dx = destro

Applicazioni cc marca/modello	anno	figura	CENTRALE			LATERALE					
			kit codice	nudo codice	accessori codice	simil OEM		opzionale nero		opzionale cromato	
						lato	codice	lato	codice	lato	codice
PEUGEOT											
50 Buxy/Buxy RS	94/97	12		48.1124	ND						
50 Elyseo	99/>							sx	48.3232		
50 Jet Force	03/>							sx	48.3238		
50 Ludix 10 Blaster	04/>	14		48.1130	ND						
50 Ludix 14 Classic	04/>	15		48.1133	ND						
50 Ludix 14 Elegance	04/>							sx	48.3037	sx	48.3037
50 Speedake	95/97							sx	48.3223		
50 Speed ht	97/99	13		48.1127	ND			sx	48.3226	sx	48.3034
50 Squab	95/97							sx	48.3217		
50 Trekker/Trekker Road	98/00							sx	48.3217		
50 Vivacity	99/00							sx	48.3235		
100 Elyseo	99/01							sx	48.3232		
100 Vivacity	99/00							sx	48.3235		
125 Elyseo	99/02							sx	48.3232		
125 Looxor	02/04	11		48.1121	ND						
150 Elyseo	99/00							sx	48.3232		
150 Looxor	02/04	11		48.1121	ND						
PIAGGIO											
50 FLY 2T	05/12							dx	48.3265	dx	48.3043
50 FLY 2T	05/12							sx	48.3271	sx	48.3046
50 FLY 4T (C44200/C44500)	05/12	68	48.5295		48.9197			sx	48.3271	sx	48.3046
50 FLY 4T (C44200/C44500)	05/12							dx	48.3265	dx	48.3043
50 Liberty 2T	97/03	61	48.5274		48.9182			sx	48.3280		
50 Liberty MOC 2T (C49100)	09/13	61	48.5274		48.9182			sx	48.3280		
50 Liberty MOC 4T (C49200)	09/13	63	48.5280		48.1175			sx	48.3283		
50 Liberty Rst 2T	04/08	61	48.5274		48.9182			sx	48.3280		
50 Liberty Rst 4T (C42200/C42400)	04/08	64	48.5283		48.9233			sx	48.3283		
50 Liberty Sport 2T	04/06	61	48.5274		48.9182						
50 Liberty Sport 4T (C42405)	04/08	64	48.5283		48.9233						
50 NRG DD	94/96	58	48.5265		48.9182			sx	48.3271	sx	48.3046
50 NRG DD	94/96							dx	48.3265	dx	48.3043
50 NRG DT	94/96	58	48.5265		48.9182			sx	48.3271	sx	48.3046
50 NRG DT	94/96							dx	48.3265	dx	48.3043
50 NRG Extreme DD	99/00	58	48.5265		48.9182						
50 NRG Extreme DT	99/00	58	48.5265		48.9182						
50 NRG Extreme MC2 DD	96/98	58	48.5265		48.9182						
50 NRG Extreme MC2 DT	96/98	58	48.5265		48.9182						
50 NRG MC3 DD LC	01/04	58	48.5265		48.9182			sx	48.3271	sx	48.3046
50 NRG MC3 DD LC	02/04							dx	48.3265	dx	48.3043
50 NRG MC3 DT Air	01/04	58	48.5265		48.9182			sx	48.3271	sx	48.3046
50 NRG MC3 DT Air	01/04							dx	48.3265	dx	48.3043
50 NRG Power DD (C45100)	05/13	58	48.5265		48.9182			sx	48.3277	sx	48.3052
50 NRG Power DT (C45300)	05/11	58	48.5265		48.9182			sx	48.3277	sx	48.3052
50 NRG Power Purejet (C45200)	04/11	58	48.5265		48.9182			sx	48.3277	sx	48.3052
50 NRG Purejet (C32001)	02/04	58	48.5265		48.9182						
50 NRG Purejet (C45200)	10	58	48.5265		48.9182						
50 NTT	95/96	56	48.5259		48.9182			sx	48.3271	sx	48.3046
50 NTT	95/96							dx	48.3265	dx	48.3043
50 Quartz	92/96	16		48.1151	ND						
50 Sfera - Sfera Maquillage 2	91/93							sx	48.3271	sx	48.3046
50 Sfera - Sfera Maquillage 2	91/93							dx	48.3265	dx	48.3043
50 Sfera FL Rst	95/97	59	48.5268		48.9188			sx	48.3271	sx	48.3046

ND = non disponibile • lato: sx = sinistro / dx = destro

Applicazioni cc marca/modello	anno	figura	CENTRALE			LATERALE					
			kit codice	nudo codice	accessori codice	simil OEM		opzionale nero		opzionale cromato	
						lato	codice	lato	codice	lato	codice
50 Storm	94/97							dx	48.3265	dx	48.3043
50 Typhoon 2T / E2	01/12	56	48.5259		48.9182			sx	48.3271	sx	48.3046
50 Typhoon 2T / E2	01/12							dx	48.3265	dx	48.3043
50 Vespa ET2	97/05	59	48.5268		48.9188			sx	48.3274	sx	48.3049
50 Vespa ET2 IE	97/99	59	48.5268		48.9188			sx	48.3274	sx	48.3049
50 Vespa ET4 (C26100)	00/05	66	48.5289		48.9191			sx	48.3274	sx	48.3049
50 Vespa FL (V5N1)	90	73	48.5310		48.9209						
50 Vespa FL2 Automatica (V5P2T)	90/91	73	48.5310		48.9209						
50 Vespa FL2 HP (V5N2T)	91/97	73	48.5310		48.9209						
50 Vespa LX 2T	05/12	60	48.5271		48.9182						
50 Vespa LX 4T (C38300)	05/08	66	48.5289		48.9191						
50 Vespa LX 4T 4V (C38700)	09/13	66	48.5289		48.9191						
50 Vespa LX 4T 4V Touring (C38700)	10/13	66	48.5289		48.9191						
50 Vespa LX Touring 2T (C38101)	10/13	60	48.5271		48.9182						
50 Vespa LXV 2T	06/08	60	48.5271		48.9182						
50 Vespa N (V5X5T)	89/90	73	48.5310		48.9209						
50 Vespa N Speedmatic (V5P1)	90	73	48.5310		48.9209						
50 Vespa PK (V5X1T)	82/84	73	48.5310		48.9209						
50 Vespa PK S (V5X2T)	84/89	73	48.5310		48.9209						
50 Vespa PK S Automatica (VA51T)	84/89	73	48.5310		48.9209						
50 Vespa PK SS (V5S1T)	83/>	73	48.5310		48.9209						
50 Vespa PK XL (V5X3T)	85/89	73	48.5310		48.9209						
50 Vespa PK XL Elestart (V5X3T)	85/90	73	48.5310		48.9209						
50 Vespa PK XL Plurimatic (VA52T)	85/90	73	48.5310		48.9209						
50 Vespa PK XL Rush (V5X4T)	88/97	73	48.5310		48.9209						
50 Vespa R (V5A1T)	70/83	72	48.5307		48.9206						
50 Vespa S (V5SA1T)	67/82	72	48.5307		48.9206						
50 Vespa S 4T 4V	08/12	66	48.5289		48.9191						
50 Vespa Special (V5B3T)	75/83	72	48.5307		48.9206						
50 Vespa Special RST (V5R1T)	91/>	72	48.5307		48.9206						
50 Zip 2T (C25E0)	08/13							sx	48.3271	sx	48.3046
50 Zip 2T (C25E0)	08/13							dx	48.3265	dx	48.3043
50 Zip 2T Cat. (C25000)	00/07							sx	48.3271	sx	48.3046
50 Zip 2T Cat. (C25000)	00/07							dx	48.3265	dx	48.3043
50 Zip Base	92/94							sx	48.3271	sx	48.3046
50 Zip Base	92/96							dx	48.3265	dx	48.3043
50 Zip Base FD DT	92/95	53	48.5247		48.9179			sx	48.3271	sx	48.3046
50 Zip Base FD DT	95/96							dx	48.3265	dx	48.3043
50 Zip Base TT	92/95							sx	48.3271	sx	48.3046
50 Zip Base TT	92/95							dx	48.3265	dx	48.3043
50 Zip Fast Rider	93/94										
50 Zip Fast Rider Rst	96/97	53	48.5247		48.9179						
50 Zip Rst - Zip Rst Disco	96/99	53	48.5247		48.9179			sx	48.3271	sx	48.3046
50 Zip Rst - Zip Rst Disco	96/99							dx	48.3265	dx	48.3043
100 FLY 4T (M53100)	05/09	68	48.5295		48.9197			sx	48.3271	sx	48.3046
100 FLY 4T (M53100)	05/09							dx	48.3265	dx	48.3043
100 Zip 4T (M25200)	06/10	66	48.5289		48.9191			sx	48.3271	sx	48.3046
100 Zip 4T (M25200)	02/10							dx	48.3265	dx	48.3043
125 Beverly (M2810/M2820)	01/03	69	48.5298		48.9200						
125 Beverly Rst/Rst E3/MIC (M28400/M28900)	04/08	69	48.5298		48.9200						
125 Beverly Sport E3 (M28900)	07/09	69	48.5298		48.9200						
125 Beverly Tourer E3 (M28901)	08/10	69	48.5298		48.9200						
125 FLY / FLY E3 (M42100/M57100/M57200)	05/12	68	48.5295		48.9197						
125 Hexagon Super GTX 12"	01/02	71	48.5304		48.9203						
125 Liberty 4T (M1100/M2200)	98/00	54	48.5253		48.9176			sx	48.3283		
125 Liberty 4T 2V IE E3 (M67100)	09/12	65	48.5286		48.9236			sx	48.3283		

ND = non disponibile • lato: sx = sinistro / dx = destro

Applicazioni cc marca/modello	anno	figura	CENTRALE			LATERALE					
			kit codice	nudo codice	accessori codice	simil OEM		opzionale nero		opzionale cromato	
						lato	codice	lato	codice	lato	codice
125 Liberty 4T 3V IE E3 (M73400)	13							SX	48.3283		
125 Liberty 4T E3 (M38600)	07/09	65	48.5286		48.9236			SX	48.3283		
125 Liberty MOC 4T (M67100)	09/12	65	48.5286		48.9236			SX	48.3283		
125 Liberty Rst 4T (M38100)	04/08	65	48.5286		48.9236			SX	48.3283		
125 Liberty Sport / Sport E3 (M38104/M38601)	06/08	65	48.5286		48.9236						
125 Sfera FL	95/97	55	48.5256		48.9176						
125 Vespa (VMA1T)	65/67	72	48.5307		48.9206						
125 Vespa ET3 (VMB1T)	76/83	72	48.5307		48.9206						
125 Vespa FL (VMX7T)	89/90	73	48.5310		48.9209						
125 Vespa GTS IE Super 4V (M45300)	09/13	70	48.5301		48.9200	SX	48.2016				
125 Vespa PK (VMX1T)	82/85	73	48.5310		48.9209						
125 Vespa PK S (VMX5T)	82/85	73	48.5310		48.9209						
125 Vespa PK XL (VMX6T)	86/89	73	48.5310		48.9209						
125 Vespa Primavera (VMA2T)	67/83	72	48.5307		48.9206						
125 Vespa PX (VNX1T)	78/82	74	48.5316		48.9212			SX	48.3268		
125 Vespa PX E (VNX2T)	81/>	74	48.5316		48.9212			SX	48.3268		
125 Vespa PX E Arcobaleno (VNX2T)	83/97	74	48.5316		48.9212			SX	48.3268		
125 Vespa PX E DT (VNX2T)	98/12	74	48.5316		48.9212			SX	48.3268		
125 Vespa PX T5 (VNX5T)	85/89							SX	48.3268		
125 X7 E3 (M62100)	08/09									SX	48.3055
150 FLY / FLY E3 (M42200/M57100)	05/12	68	48.5295		48.9197						
150 Liberty 4T E3 (M38700)	08/09	65	48.5286		48.9236						
150 Liberty MOC 4T (M67200)	09/13	65	48.5286		48.9236						
150 Liberty Sport 4T E3 (M38701)	08/09	65	48.5286		48.9236						
150 Vespa ET4	99/04							SX	48.3274	SX	48.3049
150 Vespa PX (VLX1T)	78/89	74	48.5316		48.9212			SX	48.3268		
150 Vespa PX E (VLX1T)	81/>	74	48.5316		48.9212			SX	48.3268		
150 Vespa PX E Arcobaleno (VLX1T)	81/97	74	48.5316		48.9212			SX	48.3268		
150 Vespa PX E DT (VLX1T)	98/12	74	48.5316		48.9212			SX	48.3268		
150 Vespa Super (VBC1)	66/79	17		48.1199	ND						
200 Liberty Rst/Liberty Rst E3 (M3840001/M38400)	04/07	65	48.5286		48.9236						
200 Vespa PX E (VSX1T)	81/97	74	48.5316		48.9212			SX	48.3268		
200 Vespa PX E Arcobaleno (VSX1T)	81/97	74	48.5316		48.9212			SX	48.3268		
200 Vespa PX E DT (VSX1T)	98/06	74	48.5316		48.9212			SX	48.3268		
250 Beverly Cruiser (M28802)	07/09	69	48.5298		48.9200						
250 Beverly E3 MIC (ZAPM28800)	07/09	69	48.5298		48.9200						
250 Beverly IE E3 (ZAPM28800)	06/07	69	48.5298		48.9200						
250 Beverly Rst (M28500)	04/07	69	48.5298		48.9200						
250 Beverly Sport (M28800)	06/12	69	48.5298		48.9200						
250 Beverly Tourer E3 (ZAPM28801)	08/09	69	48.5298		48.9200						
250 Vespa GT 60 (M45102)	06/08	70	48.5301		48.9200						
250 Vespa GTS / GTS ABS (M45100/M45101)	05/11	70	48.5301		48.9200						
250 Vespa GTV (M45102)	06/11	70	48.5301		48.9200						
250 Vespa GTV Navy E3 (M45102)	08/11	70	48.5301		48.9200						
300 Beverly Tourer IE (M28A00)	09/11	69	48.5298		48.9200						
300 Vespa GTS Super (M45200)	08/12	70	48.5301		48.9200						
300 Vespa GTS Super Sport (M45200)	10/12	70	48.5301		48.9200						
300 Vespa GTV 4T 4V IE (M4520)	10/13	70	48.5301		48.9200						

RIEJU

50 Drac	92/96					SX	48.3328	SX	48.3241		
50 RR	98/>					SX	48.3328	SX	48.3244		
50 RS 1 AM	95/96					SX	48.3331				
50 RS 1 Evolution	97/98					SX	48.3331				
50 RV								SX	48.3241		

ND = non disponibile • lato: sx = sinistro / dx = destro

Applicazioni cc marca/modello	anno	figura	CENTRALE			LATERALE					
			kit codice	nudo codice	accessori codice	simil OEM		opzionale nero		opzionale cromato	
						lato	codice	lato	codice	lato	codice
SUZUKI											
50 AH Address	92/95							SX	48.3259		
50 AP R/T R7	94/97	19		48.1211	ND			SX	48.3259		
50 AY Katana Air/Lc	97/03	18		48.1208	ND			SX	48.3262	SX	48.3040
50 DR Big								SX	48.3253		
50 Minicross								SX	48.3256		
50 SK								SX	48.3256		
50 TR Street Magic	98/00							SX	48.3250		
50 UF Estilete	00/02							SX	48.3262	SX	48.3040
50 UX Zillion	99/03							SX	48.3262	SX	48.3040
125 UH Burgman	02/06					SX	48.2073				
125 UH Burgman	07/11					SX	48.2070				
250 AN Burgman	03/06					SX	48.2064				
250 AN Burgman	98/02					SX	48.2061				
400 AN Burgman (K7/K8/K9/L0/L1)	06/11					SX	48.2067				
SYM											
50 Jet	99/02	20		48.1214	ND						
YAMAHA											
50 BW'S (5WW/5WWP)	04/13	49	48.5232		48.9164						
50 BW'S N.G. (4SB/5LF/5FX1/5NU)	97/09									SX	48.3058
50 BW'S Naked (1D11/2B71)	04	49	48.5232		48.9164						
50 BW'S Naked (2B7B)	09/12	49	48.5232		48.9164						
50 CS Jog R (5RW/5RW13D43/3D4C/4D4R)	02/11	5		48.1037	ND			dx	48.3073	SX	48.3076
50 CW BW'S L (5XY1/5XYA1/2B61)	04	49	48.5232		48.9164						
50 EW Slider	00/02	48	48.5229		48.9161					SX	48.3067
50 YA ZA Jog Z (4SC1)	95/96	50	48.5235		48.9167						
50 YH Why	98/02	7		48.1046	ND						
50 YH Why E2	03/06	7		48.1046	ND						
50 YN Neo's	97/01									dx	48.3061
50 YN Neo's	97/01									SX	48.3070
50 YQ Aerox /R	97/02	4		48.1034	ND			SX	48.3325	SX	48.3079
50 YQ Aerox /R	97/02									dx	48.3064
50 YQ Aerox /R	97/02									SX	48.3067
50 YQ Aerox R E2	03/09	4		48.1034	ND			SX	48.3325	SX	48.3079
50 YQ Aerox R E2	03/09									dx	48.3064
50 YQ Aerox R E2	03/09									SX	48.3067
100 YN Neo's	00/02									dx	48.3061
100 YN Neo's	00/02									SX	48.3070
100 YQ Aerox	00/03	4		48.1034	ND			SX	48.3325	SX	48.3079
100 YQ Aerox	00/03									dx	48.3064
100 YQ Aerox	00/03									SX	48.3067
125 VP X City (16P1)	07/10					SX	48.2025				
125 YBR 4T	05/11	21		48.1217	ND						
125 YPR X Max	06/09	52	48.5241		48.9173	SX	48.2028				
125 YPR X Max	10/11					SX	48.2031				
250 YP Majesty/DX (4UC/5DF)	98/00	51	48.5238		48.9170	SX	48.2022				
250 YP Majesty (5GM/5SJ)	00/03	51	48.5238		48.9170	SX	48.2022				
250 YP Majesty/DX (4UC/5DF)	96/00					SX	48.2019				
400 YP Majesty	04/06					SX	48.2034				
400 YP Majesty (5RUJ/5RUH/5RUG/5RUX/5RUY)	07/11					SX	48.2037				
500 XP T-Max	01/07					SX	48.2040				
500 XP T-Max	08/11					SX	48.2043				

ND = non disponibile • lato: sx = sinistro / dx = destro

Figurato cavalletti

CENTRALI KIT/NUDO



Fig. 1



Fig. 2



Fig. 3



Fig. 4



Fig. 5



Fig. 6



Fig. 7



Fig. 8



Fig. 9



Fig. 10



Fig. 11



Fig. 12

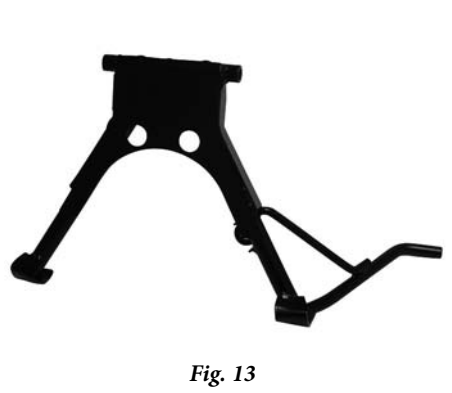

Fig. 13



Fig. 14

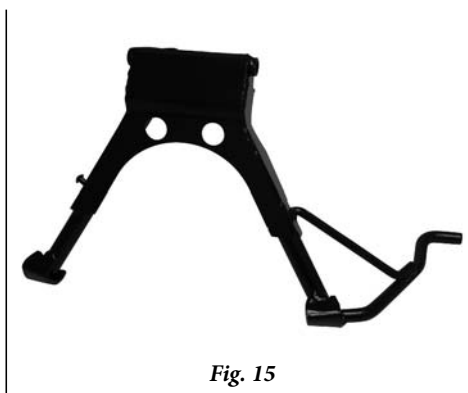

Fig. 15



Fig. 16

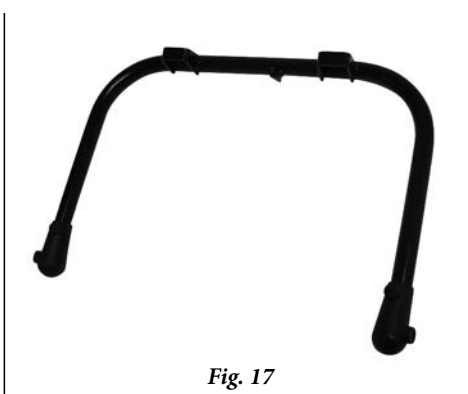

Fig. 17

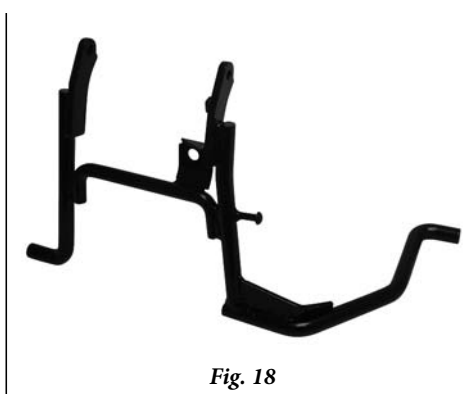

Fig. 18

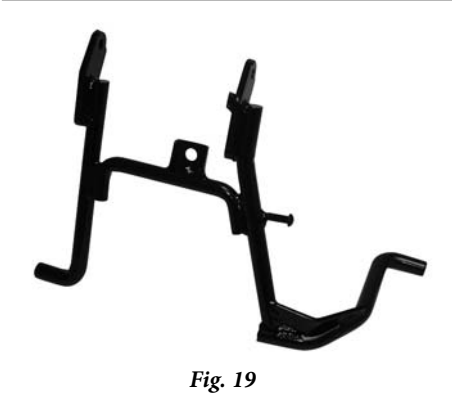

Fig. 19

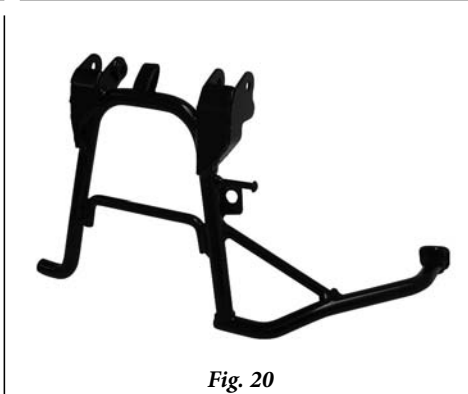

Fig. 20



Fig. 21



Fig. 22



Fig. 23

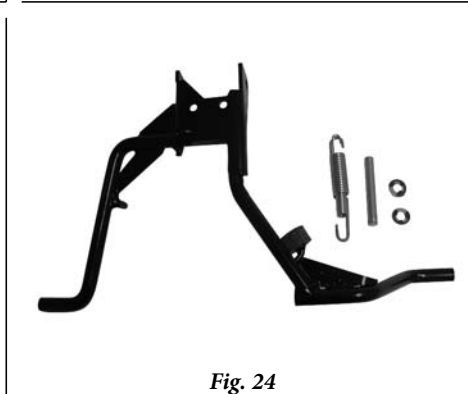

Fig. 24

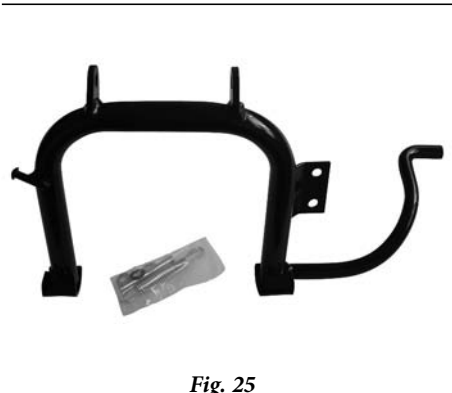

Fig. 25



Fig. 26



Fig. 27



Fig. 28



Fig. 29



Fig. 30



Fig. 31



Fig. 32



Fig. 33



Fig. 34



Fig. 35



Fig. 36



Fig. 37



Fig. 38



Fig. 39



Fig. 40



Fig. 41



Fig. 42



Fig. 43



Fig. 44



Fig. 45



Fig. 46



Fig. 47



Fig. 48



Fig. 49



Fig. 50



Fig. 51



Fig. 52



Fig. 53



Fig. 54



Fig. 55



Fig. 56



Fig. 57



Fig. 58



Fig. 59



Fig. 60



Fig. 61



Fig. 62



Fig. 63



Fig. 64



Fig. 65



Fig. 66



Fig. 67



Fig. 68



Fig. 69



Fig. 70



Fig. 71



Fig. 72

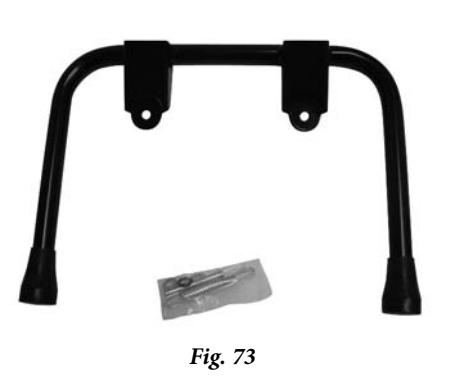

Fig. 73



Fig. 74



Fig. 75

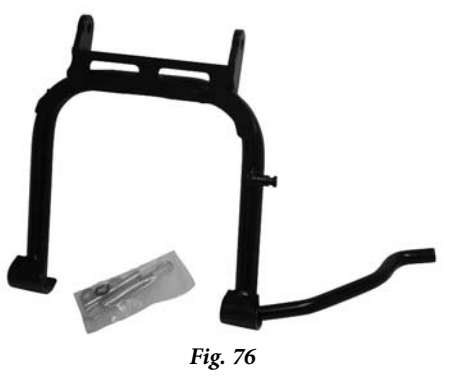

Fig. 76

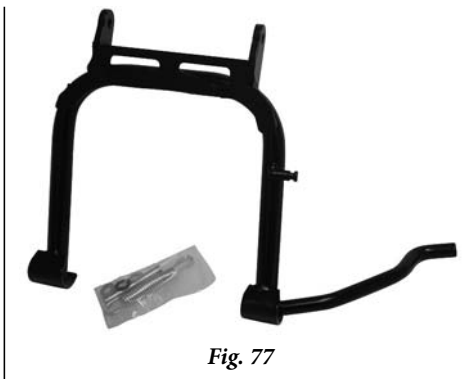

Fig. 77

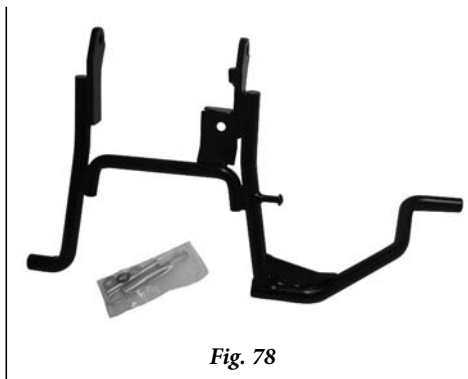

Fig. 78

LATERALI

**FIGURA
NON DISPONIBILE**

sinistro
cod. 48.2010

**FIGURA
NON DISPONIBILE**

sinistro
cod. 48.2013

**FIGURA
NON DISPONIBILE**

sinistro
cod. 48.2016

**FIGURA
NON DISPONIBILE**

sinistro
cod. 48.2019

**FIGURA
NON DISPONIBILE**

sinistro
cod. 48.2022

**FIGURA
NON DISPONIBILE**

sinistro
cod. 48.2025

**FIGURA
NON DISPONIBILE**

sinistro
cod. 48.2028

**FIGURA
NON DISPONIBILE**

sinistro
cod. 48.2031

**FIGURA
NON DISPONIBILE**

sinistro
cod. 48.2034

**FIGURA
NON DISPONIBILE**

sinistro
cod. 48.2037

**FIGURA
NON DISPONIBILE**

sinistro
cod. 48.2040

**FIGURA
NON DISPONIBILE**

sinistro
cod. 48.2043

**FIGURA
NON DISPONIBILE**

sinistro
cod. 48.2046

**FIGURA
NON DISPONIBILE**

sinistro
cod. 48.2049

**FIGURA
NON DISPONIBILE**

sinistro
cod. 48.2052

**FIGURA
NON DISPONIBILE**

sinistro
cod. 48.2055

**FIGURA
NON DISPONIBILE**

sinistro
cod. 48.2058

**FIGURA
NON DISPONIBILE**

sinistro
cod. 48.2061

**FIGURA
NON DISPONIBILE**

sinistro
cod. 48.2064

**FIGURA
NON DISPONIBILE**

sinistro
cod. 48.2067

**FIGURA
NON DISPONIBILE**

sinistro
cod. 48.2070

**FIGURA
NON DISPONIBILE**

sinistro
cod. 48.2073



sinistro
cod. 48.3001

**FIGURA
NON DISPONIBILE**

sinistro
cod. 48.3004

**FIGURA
NON DISPONIBILE**

sinistro
cod. 48.3007



sinistro
cod. 48.3010



sinistro
cod. 48.3013



sinistro
cod. 48.3016



sinistro
cod. 48.3019



sinistro
cod. 48.3022



sinistro
cod. 48.3025



sinistro
cod. 48.3028

FIGURA
NON DISPONIBILE

sinistro
cod. 48.3031

sinistro
cod. 48.3034

sinistro
cod. 48.3037

sinistro
cod. 48.3040

destra
cod. 48.3043

sinistro
cod. 48.3046

sinistro
cod. 48.3049

sinistro
cod. 48.3052

sinistro
cod. 48.3055

sinistro
cod. 48.3058

destra
cod. 48.3061

destra
cod. 48.3064

sinistro
cod. 48.3067

sinistro
cod. 48.3070

destra
cod. 48.3073

sinistro
cod. 48.3076

sinistro
cod. 48.3079

FIGURA
NON DISPONIBILE

sinistro
cod. 48.3082

sinistro
cod. 48.3085

sinistro
cod. 48.3088







Tabella applicazioni rubinetti benzina - sonde livello olio e benzina

Applicazione	Cod. SGR	Riferimento originale	Attacco	Codulo Ø	Pag.
APRILIA - RUBINETTI					
50 Amico GL/GLE/LX/Sport/Cat (92/98)	28.0514	□ AP8201481	flangia	8	81
50 SR Air/LC UrbanKid/Viper/Replica (93/96)	28.0512	□ AP8201824	depressione Ø 15	6	81
50 SR WWW/Netscaper/Stealth/Racing (97/02)	28.0512	□ AP8201824	depressione Ø 15	6	81
50 SR Racing/Sport (00/04 - Mot.Aprilia carb.)	28.0512	□ AP8201824	depressione Ø 15	6	81
50 SR R/R Factory (04/13 - Mot.Piaggio carb.)	28.0512	□ AP8201824	depressione Ø 15	6	81
50 SR Street (03/13 - Mot.Piaggio carb.)	28.0512	□ AP8201824	depressione Ø 15	6	81
50 Rally Air/LC (95/03)	28.0512	□ AP8201824	depressione Ø 15	6	81
50 RS4 4T (11/13)	28.0512	□ 00G00400181	depressione Ø 15	6	81
50 RX (06/13) - 50 SX (06/13)	28.0512	□ 00G00400181	depressione Ø 15	6	81
50 Scarabeo (93/94)	28.0523	□ AP8201750	depressione Ø 15	6	81
50 Scarabeo/Street (95/05 - Mot.Minarelli)	28.0512	□ AP8201824	depressione Ø 15	6	81
50 Sonic Air/GP (98/08)	28.0512	□ AP8201824	depressione Ø 15	6	81
100 Scarabeo 2 tempi (00/>)	28.0512	□ AP8201824	depressione Ø 15	6	81
125 AS R (85/86) - con riserva	28.0074	□ AP8101312	M 16 X 1,0	8	79
125 RS (06/10)	28.0512	□ AP8201824	depressione Ø 15	6	81
125/150 SR (99/01)	28.0512	□ AP8201824	depressione Ø 15	6	81
125 ST/STX (82/84) - con riserva	28.0074	□ AP8101312	M 16 X 1,0	8	79
125 ETX (84) - con riserva	28.0074	□ AP8101312	M 16 X 1,0	8	79
125 ETX (86) - con riserva	28.0109	□ AP8101738	M 16 X 1,0	8	79
125 Tuareg (86) - con riserva	28.0109	□ AP8101738	M 16 X 1,0	8	79
350 ETX (85/87) - con riserva	28.0074	□ AP8101312	M 16 X 1,0	8	79
350 Tuareg (86/87) - con riserva	28.0074	□ AP8101312	M 16 X 1,0	8	79
350 Tuareg Wind (87) - con riserva	28.0074	□ AP8101312	M 16 X 1,0	8	79
APRILIA - SONDE					
50 AF1/Project108/Replica (86/92) - <u>sonda livello olio mm.100</u>	28.0406	□ AP8201192	Ø 22 - a pressione		83
50 AF1 Futura (90/92) - <u>sonda livello olio mm.100</u>	28.0406	□ AP8201192	Ø 22 - a pressione		83
50 AF1 Europa (90/92) - <u>sonda livello olio mm.100</u>	28.0406	□ AP8201192	Ø 22 - a pressione		83
50 RS (93/98) - <u>sonda livello olio mm.100</u>	28.0406	□ AP8201192	Ø 22 - a pressione		83
50 Scarabeo (93/97) - <u>sonda livello benzina mm. 153 - 2 fili</u>	09.2818	□ AP8212959			83
50 Scarabeo (93/97) - <u>sonda livello olio mm.100</u>	28.0406	□ AP8201192	Ø 22 - a pressione		83
50 Scarabeo/Street (98/05 - M.Minarelli) - <u>sonda livello benzina mm. 153 - 2 fili</u>	09.2818	□ AP8212988			83
50 Sonic Air/GP (98/08) - <u>sonda livello benzina mm. 215 - 3 fili</u>	09.2819	□ AP8124478			83
50 SR WWW (97/02) - <u>sonda livello benzina - mm. 153 - 3 fili</u>	09.2825	□ AP8124814			83
50 SR Netscaper/Stealth/Racing (97/99) - <u>sonda livello benzina - mm.153 - 3 fili</u>	09.2825	□ AP8124814			83
50 SR Racing/Sport (00/03) - <u>sonda livello benzina - mm.153 - 3 fili</u>	09.2825	□ AP8124814			83
50 SR Di-Tech/Euro 2 (00/03) - <u>sonda livello benzina - mm.153 - 3 fili</u>	09.2825	□ AP8124814			83
50 SR Street (03/12 - M.Piaggio carb.) - <u>sonda livello benzina - mm.153 - 3 fili</u>	09.2825	□ AP8124814			83
50 SR Street IE (03/12 - M.Piaggio iniez.) - <u>sonda livello benzina - mm.153 - 3 fili</u>	09.2825	□ AP8124814			83
50 Tuareg Rally (90/92) - <u>sonda livello olio mm.100</u>	28.0406	□ AP8201192	Ø 22 - a pressione		83
100 Scarabeo 2 tempi (00/>) - <u>sonda livello benzina mm.153 - 2 fili</u>	09.2818	□ AP8212988			83
125 AF1/Extrema/Sintesi/Replica (87/91) - <u>sonda livello olio mm.100</u>	28.0406	□ AP8201192	Ø 22 - a pressione		83
125 AF1 Futura (90/92) - <u>sonda livello olio mm.100</u>	28.0406	□ AP8201192	Ø 22 - a pressione		83
125 AF1 Europa (90/92) - <u>sonda livello olio mm.100</u>	28.0406	□ AP8201192	Ø 22 - a pressione		83
125 Pegaso (89/94) - <u>sonda livello olio mm.100</u>	28.0406	□ AP8201192	Ø 22 - a pressione		83
125 RS/Extrema/Replica (92/10) - <u>sonda livello olio mm.100</u>	28.0406	□ AP8201192	Ø 22 - a pressione		83
125 RS Tuono (03/04) - <u>sonda livello olio mm.100</u>	28.0406	□ AP8201192	Ø 22 - a pressione		83
125 RX - 125 SX (08/10) - <u>sonda livello olio mm.100</u>	28.0406	□ AP8201192	Ø 22 - a pressione		83
125 Tuareg/Wind/Rally (88/92) - <u>sonda livello olio mm.100</u>	28.0406	□ AP8201192	Ø 22 - a pressione		83
125/150 Leonardo/ST (96/04) - <u>sonda livello benzina mm.215 - 3 fili</u>	09.2819	□ AP8124478			83
125/150 SR (99/01) - <u>sonda livello benzina - mm.153 - 3 fili</u>	09.2825	□ AP8124814			83

Applicazione	Cod. SGR	Riferimento originale	Attacco	Codulo Ø	Pag.
ASPES					
50 cc. - 125 cc. - senza riserva - a vite	28.0112	□	004322	M 10 X 1,0	6 80
BENASSI					
Motori agricoli - senza riserva - a vite	28.0041	□		M 10 X 1,0	9 78
BENELLI					
Ciclomotori vari - senza riserva - in zama	28.0001	□		M 10 X 1,0	6 78
Ciclomotori vari - con riserva - in zama	28.00251	□		M 10 X 1,0	6 78
Ciclomotori vari - con riserva	28.0088	□	35105400	M 12 X 1,0	6 79
50 491 GT/Sport/Racing (98/99)	28.0512	□	R67640011A0	depressione Ø 15	6 81
50 Magnum - con riserva	28.0088	□	35105400	M 12 X 1,0	6 79
50 S Scooter - con riserva (asta mm. 35)	28.0132	□	65105410	M 12 X 1,0	6 80
50 Cross (74) - 50 TT - con riserva	28.0088	□	35105400	M 12 X 1,0	6 79
125 Turismo - 125 Enduro - con riserva	28.0088	□	35105400	M 12 X 1,0	6 79
125/250 (1.ma serie) - con riserva	28.0088	□	35105400	M 12 X 1,0	6 79
125 2C - 125 Sport - con riserva entrambi	28.0239	dx □	63105400	M 16 X 1,0	8 81
	28.0226	sx □	63105401	M 16 X 1,0	8 81
125/250 - 250 2C/2C-E - con riserva entrambi	28.0239	dx □	3760050799	M 16 X 1,0	8 81
	28.0226	sx □	3760060799	M 16 X 1,0	8 81
250 TS - con riserva entrambi	28.0109	dx □	39105400	M 16 X 1,0	8 79
	28.0074	sx □	39105401	M 16 X 1,0	8 79
124 - 250/300 Quattro - 254/304 - con riserva entrambi	28.0109	dx □	65105400/02	M 16 X 1,0	8 79
	28.0074	sx □	65105401/03	M 16 X 1,0	8 79
500 Quattro - con riserva entrambi	28.0239	dx □	3760050799	M 16 X 1,0	8 81
	28.0226	sx □	3760060799	M 16 X 1,0	8 81
350/500 LS - 354/504/654/Sport - con riserva entrambi	28.0239	dx □	63105400	M 16 X 1,0	8 81
	28.0226	sx □	63105401	M 16 X 1,0	8 81
750 SEI - 900 SEI - con riserva entrambi	28.0109	dx □	65105400/02	M 16 X 1,0	8 79
	28.0074	sx □	65105401/03	M 16 X 1,0	8 79
BETAMOTOR					
Ciclomotori vari - senza riserva - in zama	28.0001	□		M 10 X 1,0	6 78
50 ARK Air/LC/LC K (96/05)	28.0512	□	2779910000	depressione Ø 15	6 81
50 Eikon (99/>)	28.0512	□	2779910000	depressione Ø 15	6 81
125 CR - con riserva entrambi	28.0109	dx □		M 16 X 1,0	8 79
	28.0074	sx □		M 16 X 1,0	8 79
125 Enduro - con riserva	28.0111	□		M 10 X 1,0	6 80
CAGIVA					
50 Progress/LC (97/99)	28.0512	□	00G00400181	depressione Ø 15	6 81
CICLOMOTORI VARI					
Ciclomotori vari - senza riserva - in zama - uscita verticale	28.0001	◆		M 10 X 1,0	6 78
Ciclomotori vari - con riserva - in zama - uscita verticale	28.00251	◆		M 10 X 1,0	6 78
Ciclomotori vari - con riserva - in zama - uscita orizzontale	28.00381	◆		M 10 X 1,0	6 78
Ciclomotori vari - con riserva - con scatto - uscita orizzontale	28.0063	◆		M 10 X 1,0	6 78
Ciclomotori vari - con riserva - con scatto - uscita verticale	28.0064	◆		M 10 X 1,0	6 79
Ciclomotori vari - con riserva - con scatto - uscita orizzontale - con vaschetta	28.0124	◆		M 10 X 1,0	7 80
Ciclomotori vari - con riserva - uscita orizzontale	28.0088	◆		M 12 X 1,0	6 79
Ciclomotori vari - con riserva - con scatto - uscita verticale	28.0077	◆		M 12 X 1,0	6 79
Ciclomotori vari - con riserva - con scatto - uscita verticale	28.0078	◆		M 12 X 1,0	6 79
Ciclomotori vari - con riserva - con scatto - in zama - uscita orizzontale	28.0066	◆		M 12 X 1,0	6 79
Ciclomotori vari - con riserva - con scatto - uscita verticale	28.0022	◆		M 12 X 1,5	6 78
Ciclomotori vari - con riserva - uscita verticale	28.0076	◆		M 16 X 1,0	6 79

Applicazione	Cod. SGR	Riferimento originale	Attacco	Codulo Ø	Pag.
CIMATTI					
Ciclomotori vari - con riserva - c/scatto - uscita laterale	28.0144 ◆	2014100120	M 12 X 1,0	6	80
Ciclomotori vari - con riserva - in zama - uscita verticale	28.00251 □		M 10 X 1,0	6	78
Ciclomotori vari - con riserva - in zama - uscita orizzontale	28.00381 □		M 10 X 1,0	6	78
DEMM					
Ciclomotori vari - con riserva - in zama - uscita orizzontale	28.00381 □		M 10 X 1,0	6	78
DERBI					
50/100 Atlantis 2T/4T (99/12)	28.0512 □	00G00400181	depressione Ø 15	6	81
50 Bultaco Lobito (99/01)	28.0512 □	00G00400181	depressione Ø 15	6	81
50 Hunter (96/97) - 50 Paddock (98/99) - 50 Vamos (93/95)	28.0512 □	00G00400181	depressione Ø 15	6	81
50 Predator/LC (98/01) - 50 GP1 (01/03)	28.0512 □	00G00400181	depressione Ø 15	6	81
50 Senda R/SM/X-Trem/X-Race/DRD/HypEvo/Racing/E2 (99/13)	28.0512 □	00G00400181	depressione Ø 15	6	81
DKW					
Modelli vari - con riserva - con scatto - in zama	28.0066 ◆		M 12 X 1,0	6	79
DUCATI					
350 F3	28.0226 sx □	036183090	M 16 X 1,0	8	81
450 Mark III - 450 Desmo - 450 Scrambler	28.0544 ◆	069083080	M 12 X 1,5	8	82
350/650 Indiana - con riserva entrambi	28.0239 dx □	036183080	M 16 X 1,0	8	81
	28.0226 sx □	036183090	M 16 X 1,0	8	81
350/500 Twin/Desmo/GTL/GTV - con riserva entrambi	28.0239 dx □	082083085	M 16 X 1,0	8	81
	28.0226 sx □	082083088	M 16 X 1,0	8	81
350/500/600/650 Pantah XL/TL/SL - con riserva entrambi	28.0239 dx □	080183084	M 16 X 1,0	8	81
	28.0226 sx □	080183088	M 16 X 1,0	8	81
750/900 SS Desmo (79/80) - con riserva entrambi	28.0239 dx □	080183084	M 16 X 1,0	8	81
	28.0226 sx □	080183088	M 16 X 1,0	8	81
900 SD/SSD Darmah - 900 S2 Desmo - con riserva entrambi	28.0239 dx □	080183084	M 16 X 1,0	8	81
	28.0226 sx □	080183088	M 16 X 1,0	8	81
FANTIC					
50 Issimo - con riserva	28.0101 □	19005005050	M 16 X 1,0	8	80
125 Caballero - con riserva	28.0101 □	19005005050	M 16 X 1,0	8	80
125 - con riserva entrambi	28.0239 dx □		M 16 X 1,0	8	81
	28.0226 sx □		M 16 X 1,0	8	81
GARELLI					
Vip - Katia - Eureka - Gulp - Flex - con riserva - con scatto - in zama	28.0066 ◆	0009551040	M 12 X 1,0	6	79
Eureka - Katia (82) - con riserva - con scatto	28.0078 □		M 12 X 1,0	6	79
GILERA					
Ciclomotori vari - con riserva - con scatto - uscita verticale	28.0022 ◆		M 12 X 1,5	6	78
50 - con riserva - con scatto	28.0077 □	125673	M 12 X 1,0	6	79
50 CB1 - con riserva - c/scatto	28.0144 ◆	306653	M 12 X 1,0	6	80
50 Easy Moving (95/96)	28.0536 □	575331	depressione Ø 15	6	81
50 Easy Moving (95/96) - sonda livello benzina	28.0317 □	259346	Ø 15		83
50 Eco - con riserva	28.0138 ◆	308074	M 12 X 1,0	6	80
50 ICE (01/05)	28.0536 □	575331	depressione Ø 15	6	81
50 DNA (00/02)	28.0537 ◆	577881	depressione Ø 15	6	82
50 DNA/GP EXP. (03/08)	28.0536 □	575321	depressione Ø 15	6	81
50 RCR (03/13)	28.0512 □	00G00400181	depressione Ø 15	6	81

Applicazione	Cod. SGR	Riferimento originale	Attacco	Codulo Ø	Pag.
50 Runner/SP (97/04) - 50 Runner Poggiali (02/04)	28.0537 ◆	577881	depressione Ø 15	6	82
50 SMT/Racing (03/13)	28.0512 □	00G00400181	depressione Ø 15	6	81
50 Stalker (97/08)	28.0536 □	575331	depressione Ø 15	6	81
50 Storm (94/95)	28.0536 □	575331	depressione Ø 15	6	81
50 Storm Euro 2 (07/08)	28.0536 □	575331	depressione Ø 15	6	81
50 Typhoon/X/XR (94/00)	28.0536 □	575331	depressione Ø 15	6	81
125 SP01/SP02/Crono	28.0239 dx □	943315	M 16 X 1,0	8	81
125 Typhoon/X/XR (95/00)	28.0536 □	575331	depressione Ø 15	6	81
125/180 DNA (01)	28.0537 ◆	577881	depressione Ø 15	6	82
125/180 Runner 2T FX/FXR/SP (97/02)	28.0537 ◆	577881	depressione Ø 15	6	82
125 Runner 4T VX 125 (00/04)/180 VXR (00/01)/200 VXR (02/04)	28.0537 ◆	577881	depressione Ø 15	6	82
125 - con riserva	28.0239 dx □		M 16 X 1,0	8	81
	28.0226 sx □		M 16 X 1,0	8	81
125 Enduro - con riserva - con scatto	28.0078 □	310174	M 12 X 1,0	6	79
150 - con riserva - con scatto	28.0077 □	125673	M 12 X 1,0	6	79
125/600 RC/Top Rally	28.0110 dx □	324633	M 16 X 1,0	8	80
	28.0108 sx □	324634	M 16 X 1,0	8	80
125/200 RV - 250 RV NGR - <i>sonda livello benzina</i>	28.0305 □	322286	M 16 X 1,0		83

HONDA

50 SKY/De Luxe (SGX 97/01) - 50 X8R-S/X (SZX 98/01)	28.0538 ◆	16950-GS7-950	M 16 X 1,5	6	82
50 SFX - 50 SXR (95/01)	28.0538 ◆	16950-GS7-950	M 16 X 1,5	6	82
50 SH (96/01) - 100 SH (96/01)	28.0538 ◆	16950-GS7-950	M 16 X 1,5	6	82
125 CB S/X/Endurance - con riserva	28.0137 ◆	16950-383-901	M 16 X 1,0	6	80
125 CBR R/RS/RW (04/07)	28.0538 ◆	16950-GS7-950	M 16 X 1,5	6	82
125/150 @ - 125/150 Dylan - 125/150 SH (01/04)	28.0538 ◆	16950-GS7-950	M 16 X 1,5	6	82

HUSQVARNA

125/150/250 modelli vari (anni 70/80) - con riserva - uscita verticale	28.0076 □		M 16 X 1,0	6	79
125/250 cross modelli vari (anni 70/80) - c/riserva - uscita verticale (asta mm.35)	28.00761 □		M 16 X 1,0	6	79

INNOCENTI

50 Lambretta J - 50 Lambretta De Luxe - <i>con leva</i>	28.0050 □	20058030	M 16 X 1,0	8	78
50 Lambretta J - 50 Lambretta De Luxe - <i>senza leva</i>	28.00501 □	20458020	M 16 X 1,0	8	78
100/125 Lambretta J - 125 Lambretta J 4M - <i>con leva</i>	28.0050 □	20058030	M 16 X 1,0	8	78
100/125 Lambretta J - 125 Lambretta J 4M - <i>senza leva</i>	28.00501 □	20458020	M 16 X 1,0	8	78
125/150 Lambretta LI I/II - 175 Lambretta TV I/II - <i>con leva</i>	28.0033 □	19071020/030	M 16 X 1,0	8	78
125/150 Lambretta LI I/II - 175 Lambretta TV I/II - <i>senza leva</i>	28.00331 □	22071040	M 16 X 1,0	8	78
125/150 Lambretta LI III/S/DL - 175 Lambretta TV III - <i>con leva</i>	28.0033 □	19971030	M 16 X 1,0	8	78
125/150 Lambretta LI III/S/DL - 175 Lambretta TV III - <i>senza leva</i>	28.00331 □	22071040	M 16 X 1,0	8	78
150/200 Lambretta SX - <i>con leva</i>	28.0033 □	19971030	M 16 X 1,0	8	78
150/200 Lambretta SX - <i>senza leva</i>	28.00331 □	22071040	M 16 X 1,0	8	78
200 Lambretta TV/DL - <i>con leva</i>	28.0033 □	19971030	M 16 X 1,0	8	78
200 Lambretta TV/DL - <i>senza leva</i>	28.00331 □	22071040	M 16 X 1,0	8	78
450 Lambro - 500 Lambro L/ML - 550 Lambro N/V/M	28.0052 □	410/42970110	M 16 X 1,0	8	78

ITALJET

50 Formula (94/> - fino a tel.72270) - a flangia	28.0514 □	2351809	flangia	8	81
50 Formula (94/> - da tel.72271) - a depressione	28.0512 □	3375011	depressione Ø 15	6	81
50 Torpedo 2t (Mot.Morini - 97/99)	28.0512 □	3375011	depressione Ø 15	6	81
50 Torpedo 2t (Mot.Piaggio - 00/>)	28.0536 □	4755011	depressione Ø 15	6	81
50 Torpedo 4t	28.0536 □	4755011	depressione Ø 15	6	81
50 Jet Set	28.0536 □	4755011	depressione Ø 15	6	81
50 Velocifero (93/99) - 50 Scoop 2/3	28.0514 □	2351809	flangia	8	81

Applicazione	Cod. SGR	Riferimento originale	Attacco	Codulo Ø	Pag.
125 Formula	28.0512	□	3375011	depressione Ø 15	6 81
125/150 Jet Set	28.0536	□	4755011	depressione Ø 15	6 81
125/150 Torpedo	28.0536	□	4755011	depressione Ø 15	6 81

KTM

Enduro/Cross (anni 70) - con riserva - uscita verticale	28.0076	□		M 16 X 1,0	6 79
Enduro/Cross (anni 70) - con riserva - uscita verticale (asta mm. 35)	28.00761	□		M 16 X 1,0	6 79
Enduro/Cross (anni 80/90) - con riserva - uscita orizzontale	28.0135	□	55007005200	flangia	8,5 80
Enduro - con riserva - uscita orizzontale	28.0267	□	58107005000	flangia	8 81
125/175/250/350/390/420/495/500 MX/MC/GS (81/89) - con riserva	28.0135	□	55007005200	flangia	8,5 80

KYMC0

50 Agility 4T R10/R12 (05/13) - 50 Agility 4T RS (09/13)	28.0512	□	00159001	depressione Ø 15	6 81
50 Agility 2T RS Naked (10/13) - 50 Agility Carry 4T (11/13)	28.0512	□	00159001	depressione Ø 15	6 81
50 CX/Super (93/97) - 50 DJX/DJY/DJW (91/00)	28.0512	□	00159001	depressione Ø 15	6 81
50 Filly 4t (98/00) - 50 Fever ZX/Euro 2 (99/04)	28.0512	□	00159001	depressione Ø 15	6 81
50 KB (95/00) - 50 K12 (95/00) - 50 Heroism (95/97)	28.0512	□	00159001	depressione Ø 15	6 81
50 Like 2T/4T (09/13)	28.0512	□	00159001	depressione Ø 15	6 81
50 TopBoy (97/00)	28.0512	□	00159001	depressione Ø 15	6 81
50 Vitality 2t/4t (04/06) - 50 YUP/Euro 2 (02/03)	28.0512	□	00159001	depressione Ø 15	6 81
125 Agility/Euro 3 R12 (06/13) - 125 Agility RS (09/13) - 125 Agility Carry (11/13)	28.0512	□	00159001	depressione Ø 15	6 81
125 Like / LX (09/13)	28.0512	□	00159001	depressione Ø 15	6 81
125 Movie (99/00) - 125/150 Heroism (95/97) - 125/150 Vivio (00/>)	28.0512	□	00159001	depressione Ø 15	6 81

LAVERDA

125/250/350 Moto varie - con riserva entrambi	28.0239 dx	□		M 16 X 1,0	8 81
	28.0226 sx	□		M 16 X 1,0	8 81
350/500 Twin/Alpino/S/Montjuic - con riserva entrambi	28.0239 dx	□	52101999	M 16 X 1,0	8 81
	28.0226 sx	□	52101998	M 16 X 1,0	8 81
1000 (</75) - con riserva entrambi	28.0239 dx	□	52101999	M 16 X 1,0	8 81
	28.0226 sx	□	52101998	M 16 X 1,0	8 81

MALAGUTI

Ciclomotori vari - con riserva - in zama - uscita verticale	28.00251	□		M 10 X 1,0	6 78
Ciclomotori vari - con riserva - in zama - uscita orizzontale	28.00381	□		M 10 X 1,0	6 78
50 CR1 Crosser - 50 Yesterday	28.0512	□	09304500	depressione Ø 15	6 81
50 Fifty RV/HF/Full NL/Full CX/CX/Mistral/Top/Mix (85/93) - con riserva	28.0247	□	09302100	M 10 X 1,0	6 81
50 Fifty UP (94) - con riserva	28.0247	□	09302100	M 10 X 1,0	6 81
50 F10 Jetline (92/97)	28.0514	□	09303500	flangia	8 81
50 F10 Jetline/Rst/Euro 2/2.3/AC/AC ECO (98/10)	28.0512	□	09304500	depressione Ø 15	6 81
50 F12 Phantom/LCRst/Euro 2/2.3 (94/07)	28.0512	□	09304500	depressione Ø 15	6 81
50 F12 R AC/LC (08/10)	28.0512	□	09304500	depressione Ø 15	6 81
50 F15 Firefox/LC/Rst/Euro 2/2.3 (96/06)	28.0512	□	09304500	depressione Ø 15	6 81
50 JX / JX MIX - con riserva - con scatto - uscita verticale	28.0064	◆	09300300	M 10 X 1,0	6 79
50 JX MIX - sonda livello olio - mm.100	28.0404	* □	09302500	Ø 22 X 3	-
50 MRX/MDX-Gold/MFX/MGX/MLX/MRX - c/riserva - c/scatto - uscita verticale	28.0064	◆	09300300	M 10 X 1,0	6 79
50 MRX (89-3M/4M) - sonda livello olio - mm.100	28.0404	* □	09302500	Ø 22 X 3	-
50 Sport RST- sonda livello olio - mm.100	28.0404	* □	09302500	Ø 22 X 3	-
100 F12 Phantom (99/00)	28.0512	□	09304500	depressione Ø 15	6 81
125 Runner Rally (DT125YPVS) - sonda livello olio - mm.100	28.0404	* □	09302500	Ø 22 X 3	-

MALANCA

Ciclomotori vari - senza riserva - in zama	28.0001	□		M 10 X 1,0	6 78
--	---------	---	--	------------	------

Applicazione	Cod. SGR	Riferimento originale	Attacco	Codulo Ø	Pag.
MBK					
50 Booster NG/Euro 2 (99/03)/Booster (04)	28.0536 ◆	5BRF450000	depressione Ø 15	6	81
50 Mach-G (02/04)	28.0536 ◆	5KKF450000	depressione Ø 15	6	81
50 Nitro (97/98) - 50 Ovetto (97/04)	28.0512 ◆	5ADF450000	depressione Ø 15	6	81
50 Nitro (99/04) - 50 Flipper (98/04) - 50 Stunt (00/02)	28.0536 ◆	5BRF450000	depressione Ø 15	6	81
100 Nitro - 100 Ovetto	28.0536 ◆	5KKF450000	depressione Ø 15	6	81
125/150/180 Skyliner (01/04) - 125/150 Doodo - 125/150 Thunder	28.0536 ◆	5KKF450000	depressione Ø 15	6	81
MINARELLI					
Ciclomotori vari - Motori agricoli - senza riserva - in zama	28.0001 □		M 10 X 1,0	6	78
Motori agricoli - senza riserva - a vite	28.0040 ◆		M 10 X 1,0	6,5	78
MORINI					
98/125 moto varie - con riserva - con scatto - uscita verticale	28.0022 ◆		M 12 X 1,5	6	78
MOTOM					
Ciclomotori vari - senza riserva - in zama	28.0001 □		M 10 X 1,0	6	78
MOTORI AGRICOLI					
Motori agricoli - senza riserva - in zama	28.0001 □		M 10 X 1,0	6	78
Motori agricoli - senza riserva - a vite	28.0040 ◆		M 10 X 1,0	6,5	78
Motori agricoli - senza riserva - a vite	28.0041 □		M 10 X 1,0	9	78
Motori agricoli - con riserva - in zama - uscita orizzontale	28.00381 □		M 10 X 1,0	6	78
MOTO GUZZI - RUBINETTI					
50 Ciclomotori - 50 Magnum - con riserva	28.0088 □	35105400	M 12 X 1,0	6	79
50 Cross (74) - 50 Nibbio - 50 TT - con riserva	28.0088 □	35105400	M 12 X 1,0	6	79
125 Trial (75) - 125 Turismo - con riserva	28.0088 □	35105400	M 12 X 1,0	6	79
254/354/400/GTS 4 tempi / 4 cilindri - con riserva entrambi	28.0109 dx □	GU65105400	M 16 X 1,0	8	79
	28.0074 sx □	GU65105401	M 16 X 1,0	8	79
350 V 35 (77/80)/V 35 II (81/85)/V 35 Imola/V 35 C (82/86) - con riserva entrambi	28.0109 dx □	GU65105400	M 16 X 1,0	8	79
	28.0074 sx □	GU65105401	M 16 X 1,0	8	79
350 V 35 III (85/87-da tel.12462) - 35 GT - dx senza riserva - sx con spia elettrica riserva	28.0236 dx □	GU23105470	M 16 X 1,0	8	81
	28.0241 sx □	GU23105370	M 16 X 1,0	8	81
350 V 35 Florida (86/90) - 350 V 35 Carab./Polizia (90/01) - dx senza riserva - sx con spia elettrica riserva	28.0236 dx □	GU23105470	M 16 X 1,0	8	81
	28.0241 sx □	GU23105370	M 16 X 1,0	8	81
500 V 50 (77/80)/V50 III (80/84)/V 50 Monza/V 50 C (82/86)/V 50 Polizia/ PA (82/90) - con riserva entrambi	28.0109 dx □	GU65105400	M 16 X 1,0	8	79
	28.0074 sx □	GU65105401	M 16 X 1,0	8	79
500 V 50 PA (92/01) - dx/senza riserva - sx/con spia elettrica riserva	28.0236 dx □	GU23105470	M 16 X 1,0	8	81
	28.0241 sx □	GU23105370	M 16 X 1,0	8	81
650 V 65 Custom (82/85)/V 65 Lario/V 65 Polizia/PA (88/95) - con riserva entrambi	28.0109 dx □	GU65105400	M 16 X 1,0	8	79
	28.0074 sx □	GU65105401	M 16 X 1,0	8	79
650 V 65 Florida (86/92) - 65 GT (87/89) - dx senza riserva - sx con spia elettrica riserva	28.0236 dx □	GU23105470	M 16 X 1,0	8	81
	28.0241 sx □	GU23105370	M 16 X 1,0	8	81
750 Targa (90/92) - con riserva entrambi	28.0109 dx □	GU65105400	M 16 X 1,0	8	79
	28.0074 sx □	GU65105401	M 16 X 1,0	8	79
750 V 75 PA (92/01) - 750 SP (90/92) - 750 Strada (93/95) - dx senza riserva - sx con spia elettrica riserva	28.0236 dx □	GU23105470	M 16 X 1,0	8	81
	28.0241 sx □	GU23105370	M 16 X 1,0	8	81
750 S - 750 S3 - con riserva entrambi	28.0110 dx □	GU17105460	M 16 X 1,0	8	80
	28.0108 sx □	GU17105461	M 16 X 1,0	8	80
850 Le Mans I/ II/ III (75/85) - con riserva entrambi	28.0110 dx □	GU17105460	M 16 X 1,0	8	80
	28.0108 sx □	GU17105461	M 16 X 1,0	8	80
850 T3 California/Polizia/Carb./PA/T4 (75/85) - con riserva entrambi	28.0110 dx □	GU17105460	M 16 X 1,0	8	80
	28.0108 sx □	GU17105461	M 16 X 1,0	8	80

Applicazione	Cod. SGR	Riferimento originale	Attacco	Codulo Ø	Pag.
850 T5 Polizia/Carb./PA (85/88) - con riserva entrambi	28.0110 dx □	GU17105460	M 16 X 1,0	8	80
	28.0108 sx □	GU17105461	M 16 X 1,0	8	80
850 T5 Polizia/Carabinieri/PA (89/01) - dx senza riserva - sx c/spia elettrica riserva	28.0236 dx □	GU23105470	M 16 X 1,0	8	81
	28.0241 sx □	GU23105370	M 16 X 1,0	8	81
1000 California II (83/86) - con riserva entrambi	28.0110 dx □	GU17105460	M 16 X 1,0	8	80
	28.0108 sx □	GU17105461	M 16 X 1,0	8	80
1000 S (89/94) - 1000 SP (79/83)/SP II (83/88) - con riserva entrambi	28.0110 dx □	GU17105460	M 16 X 1,0	8	80
	28.0108 sx □	GU17105461	M 16 X 1,0	8	80
1000 GT (87/91) - 1000 SP III (89/94) - 1000 Strada (93/94) - dx senza riserva - sx con spia elettrica riserva	28.0236 dx □	GU23105470	M 16 X 1,0	8	81
	28.0241 sx □	GU23105370	M 16 X 1,0	8	81

MOTO GUZZI - SONDE

350 V 35 III (85/87) - <u>sonda livello benzina</u>	28.0313 □	GU29103050	M 16 X 1,0		83
1000 California III Carb./Carenato (87/93) - <u>sonda livello benzina</u>	28.0313 □	GU29103050	M 16 X 1,0		83
1000 California III Iniezione (90/93) - <u>sonda livello benzina</u>	28.0313 □	GU29103050	M 16 X 1,0		83

NEGRINI

Ciclomotori vari - con riserva - in zama - uscita orizzontale	28.00381 □		M 10 X 1,0	6	78
---	------------	--	------------	---	----

PERIPOLI

Ciclomotori vari - con riserva - in zama - uscita orizzontale	28.00381 □		M 10 X 1,0	6	78
---	------------	--	------------	---	----

PEUGEOT

103 MVL (</94) - 104 - 105 - con riserva	28.0111 □	729837	M 10 X 1,0	6	80
50 Buxy (94/97) - senza leva - con riserva	28.0521 □	730832	M 11,5 x 1,0	6	81
50 Fox/L - con riserva - con scatto	28.0064 □	730394	M 10 X 1,0	6	79
50 Elyseo (99/>)	28.0512 □	734227	depressione Ø 15	6	81
50 Looxor (01/03)	28.0512 □	734227	depressione Ø 15	6	81
50 Ludix 10 One/Trend/Snake (04/>)	28.0539 □	760467	depressione Ø 15	6	82
50 Ludix 14 Classic/Elegant (04/>)	28.0539 □	760467	depressione Ø 15	6	82
50 Ludix 10 SP Blaster (05/>) - con spia elettrica riserva	28.0540 □	763242	depressione Ø 15	6	82
50 Ludix RS12 Blaster - con spia elettrica riserva	28.0540 □	763242	depressione Ø 15	6	82
50 Ludix 14 PRO 2T/4T - con spia elettrica riserva	28.0540 □	763242	depressione Ø 15	6	82
50 Metal X (02)	28.0512 □	734227	depressione Ø 15	6	81
50 Speedfight Air/LC (97/98) - 50 Squab (95/97)	28.0512 □	734227	depressione Ø 15	6	81
50 Speedfight Air Cat (99/04)	28.0542 □	740741	depressione Ø 15	6	82
50 Speedfight 2 Air/Silversports/R-Cup (05/08)	28.0512 □	734227	depressione Ø 15	6	81
50 Speedfight 2 LC WRC307/R-Cup/Motosport/Ultimate (05/10)	28.0512 □	734227	depressione Ø 15	6	81
50 Trekker (98/00) - 50 TKR2 WRC (02/04)	28.0512 □	734227	depressione Ø 15	6	81
50 Rapido ST (85/93) - con riserva	28.0604 □	725952	M 10 X 1,0	6	82
50 Vivacity/Cat (99/05) - con spia elettrica riserva	28.0541 □	741153	depressione Ø 15	6	82
50 Vivacity 2 Compact /2R (06/09) - con spia elettrica riserva	28.0541 □	741153	depressione Ø 15	6	82
50 Vivacity VSX/XR (02/05)	28.0512 □	734227	depressione Ø 15	6	81
50 Vivacity 2 Sportline (06/09)	28.0512 □	734227	depressione Ø 15	6	81
50 X-Race (03/>)	28.0512 □	734227	depressione Ø 15	6	81
50 X-Fight (00/>)	28.0542 □	740741	depressione Ø 15	6	82
50 Zenith L (94/95) - senza leva - con riserva	28.0521 □	730832	M 11,5 x 1,0	6	81
50 Zenith L (96/97)/ Zenith LS/N (97/98) - con spia elettrica riserva	28.0530 □	735807	depressione Ø 15	6	81
50 Zenith LN (97/98)	28.0512 □	734227	depressione Ø 15	6	81
100 Elyseo	28.0542 □	740741	depressione Ø 15	6	82
100 Looxor - 100 Trekker - 100 X-Fight	28.0512 □	734227	depressione Ø 15	6	81
100 Speedfight/2/WRC/XP/Silversport/RallyVictories	28.0512 □	734227	depressione Ø 15	6	81
125/150 Looxor	28.0542 □	740741	depressione Ø 15	6	82

Applicazione	Cod. SGR	Riferimento originale	Attacco	Codulo Ø	Pag.
PIAGGIO CICLOMOTORI					
50 Bravo R2/P/PV/EVL/3 (73/90) - 50 Superbravo/3 (85/90) - <i>c/riserva - c/scatto</i>	28.0144 ◆	257071	M 12 X 1,0	6	80
50 Ciao PX/FL/Teen (80/99) - 50 Vespino (Spagna) - <i>con riserva</i>	28.0059 □	257043	M 12 X 1,0	6	78
50 SI/FL/FL2/MIX (79/99) - <i>con riserva (asta mm. 55)</i>	28.0058 ◆	254724	M 12 X 1,0	6	78
PIAGGIO SCOOTER					
50/100 Diesis	28.0512 □	00G00400181	depressione Ø 15	6	81
50 Fly 2T/4T (05/11)	28.0536 □	575321	depressione Ø 15	6	81
50 Free/FL/Delivery (92/01)	28.0536 □	575331	depressione Ø 15	6	81
50 Liberty 2T/4T/PPTT/TNT/Delivery (97/12)	28.0536 □	575331	depressione Ø 15	6	81
50 Liberty 2T/4T/Rst/Sport/MOC/Elle (04/13)	28.0536 □	575321	depressione Ø 15	6	81
50 NRG/MC2/Extreme/MC3 (94/04) - 50 NTT	28.0536 □	575331	depressione Ø 15	6	81
50 Quartz - 50 Sfera/FL	28.0536 □	575331	depressione Ø 15	6	81
50 Typhoon 2t/Eu2/Eu3 (01/13)	28.0536 □	575331	depressione Ø 15	6	81
50 Vespa ET2/IE/ET4 (97/05)	28.0536 □	575331	depressione Ø 15	6	81
50 Vespa LX/LXV/Navy 2T/4T/4T-4V/Touring (05/13)	28.0536 □	575321	depressione Ø 15	6	81
50 Vespa S 2T (07/13) - Vespa 50 S 4T-4V (08/13)	28.0536 □	575321	depressione Ø 15	6	81
50 Zip Base/RST/Fast Rider/RST (92/99)	28.0536 □	575331	depressione Ø 15	6	81
50 Zip Base/RST/Fast Rider/RST (92/99) - <i>sonda livello benzina</i>	28.0317 □	259346	depressione Ø 15		83
50 Zip 2T/Cat Euro 2 (00/13)	28.0536 □	575321	depressione Ø 15	6	81
50 Zip SP/Euro 2 (96/13)	28.0536 □	575331	depressione Ø 15	6	81
50 Zip SP (96/00) - <i>sonda livello benzina</i>	28.0317 □	259346	depressione Ø 15		83
50 Zip 4T (00/08)	28.0536 □	575321	depressione Ø 15	6	81
100 Fly 4T (06/08)	28.0536 □	575321	depressione Ø 15	6	81
100 Free 4T	28.0537 ◆	577881	depressione Ø 15	6	82
100/125 Zip 4T	28.0536 □	575321	depressione Ø 15	6	81
125/150 Fly (05/12)	28.0536 □	575321	depressione Ø 15	6	81
125/150/200 Liberty/Rst/Sport/ie (98/13)	28.0536 □	575321	depressione Ø 15	6	81
125 Sfera FL (95/97)	28.0523 □	298232	depressione Ø 15	6	81
125/150 Skipper/LX 2T (94/98)	28.0536 □	575331	depressione Ø 15	6	81
125/150 Skipper ST 4T	28.0536 □	575321	depressione Ø 15	6	81
125 Typhoon 4T (10/13)	28.0536 □	575321	depressione Ø 15	6	81
125/150 Vespa ET4 (96/05)	28.0536 □	575321	depressione Ø 15	6	81
125/150 Vespa LX/LXV/Navy/FL (05/09 - carb.)	28.0536 □	575321	depressione Ø 15	6	81
125 Vespa GTS (07/12) - Vespa 125 GTV (07/08)	28.0536 □	575321	depressione Ø 15	6	81
125/200 Vespa GranTurismo/Euro 3 (03/08)	28.0536 □	575321	depressione Ø 15	6	81
PIAGGIO VESPA					
50 Vespa/L/R/S/SS/Sprinter/Elestart/Special - <i>con riserva - asta lunga mm.200</i>	28.0072 □	139938/098581	M 23 x 1,5	9	79
50 Vespa PK/S/SS (82/85) - <i>con riserva - asta corta mm.165</i>	28.0073 □	214267	M 24 x 1,5	9	79
50 Vespa PK XL/Rush/N (85/90) - <i>con riserva - asta corta mm.165</i>	28.0238 □	231005	M 24 x 1,5	9	81
50 Vespa PK FL/FL2/HP (90/97) - <i>con riserva - asta corta mm.165</i>	28.0238 □	231005	M 24 x 1,5	9	81
90 Vespa/SS/Racer - <i>con riserva - asta lunga mm.200</i>	28.0072 □	139938/098581	M 23 x 1,5	9	79
125 Vespa (VMA1 - 65/67) - <i>con riserva - asta lunga mm.200</i>	28.0072 □	139938/098581	M 23 x 1,5	9	79
125 Vespa Primavera/ET3 (67/83) - <i>con riserva - asta lunga mm.200</i>	28.0072 □	139938/098581	M 23 x 1,5	9	79
125 Vespa ETS - <i>con riserva - asta corta mm.165</i>	28.0238 □	231005	M 24 x 1,5	9	81
125 Vespa PK/S (82/85) - <i>con riserva - asta corta mm.165</i>	28.0073 □	214267	M 24 x 1,5	9	79
125 Vespa PK XL/FL (86/90) - <i>con riserva - asta corta mm.165</i>	28.0238 □	231005	M 24 x 1,5	9	81
125 Vespa PX T5 - <i>con riserva - asta corta mm.165</i>	28.0073 □	217872	M 24 x 1,5	9	79
125/150/200 Vespa PX-E Arcobaleno (83/97) - <i>con riserva - asta corta mm.165</i>	28.0073 □	217872	M 24 x 1,5	9	79
125/200 Vespa PX (98/01) - <i>con riserva - asta corta mm.165</i>	28.0073 □	217872	M 24 x 1,5	9	79
125 Vespa PX Euro 2/30 Anni (02/08) - <i>con riserva - asta corta mm.165</i>	28.0073 □	217872	M 24 x 1,5	9	79
125/150 Vespa PX (11/13) - <i>con riserva - asta corta mm.165</i>	28.0073 □	217872	M 24 x 1,5	9	79

Applicazione	Cod. SGR	Riferimento originale	Attacco	Codulo Ø	Pag.
PIAGGIO APE					
50 Ape FL/FL2/FL3 Europa/Cross/NU (89/99)	28.0608 ◆	189320	depressione	8,5	82
50 Ape MIX/Rst/Top/Cross/VF/VPC/VPL/Euro 2 (99/13)	28.0608 ◆	189320	depressione	8,5	82
190 Ape MP 550 (67/72) - senza riserva - a vite	28.0067 ◆	118422	M 12 X 1,0	8,5	79
190 Ape MP 600/MPV 600 (70/78) - senza riserva - a vite	28.0067 ◆	118422	M 12 X 1,0	8,5	79
190 Ape MP 601 (78) - senza riserva - a vite	28.0067 ◆	118422	M 12 X 1,0	8,5	79
220 Ape MP P 601/P 601V (78/83) - senza riserva - a vite	28.0067 ◆	118422	M 12 X 1,0	8,5	79
220 Ape Car/P2/P3 (72/>) - senza riserva - a vite	28.0070 ◆	142062	M 12 X 1,0	8,5	79
220 Ape TM P 602 (82/83) - 220 Ape TM P 703/V/FL2 (84/05)	28.0608 ◆	189320	depressione	8,5	82
220 Ape TM Benzina (05/12)	28.0608 ◆	189320	depressione	8,5	82
PUCH					
Maxi - con riserva	28.0120 □		M 12 X 1,0	6	80
RIZZATO					
Ciclomotori vari - con riserva - in zama - uscita verticale	28.00251 □		M 10 X 1,0	6	78
50 Califfone - con riserva - asta mm. 27	28.0093 □		M 10 X 1,0	6	80
50 Hacker/LC	28.0514 □		flangia	8	81
SACHS					
Ciclomotori vari - senza riserva - in zama	28.0001 □		M 10 X 1,0	6	78
Ciclomotore 50 LC - con riserva - con scatto	28.0077 □		M 12 X 1,0	6	79
SEP					
Motori agricoli - con riserva - in zama - uscita orizzontale	28.00381 □		M 10 X 1,0	6	78
SWM					
125/250 Cross - con riserva	28.0239 dx □		M 16 X 1,0	8	81
125/250 Cross - con riserva	28.0226 sx □		M 16 X 1,0	8	81
TOMOS					
Ciclomotore 50 - con riserva - asta mm. 35	28.00761 □		M 16 X 1,0	6	79
Ciclomotore 50 - con riserva	28.0076 □		M 16 X 1,0	6	79
VOLPI E BOTTOLI					
Motori agricoli - senza riserva - in zama	28.0001 □		M 10 X 1,0	6	78
YAMAHA					
50 Aerox (97/98) - 50 Neo's 2T (97/13) - 50 Neo's Easy 2T (13)	28.0512 ◆	5ADF450000	depressione Ø 15	6	81
50 Aerox (99/13) - 50 Aerox Naked (13) - 50 Why (98/06)	28.0536 ◆	5BRF450000	depressione Ø 15	6	81
50 BW'S Next Generation/Euro 2 (99/06) - 50 Slider (00/02)	28.0536 ◆	5BRF450000	depressione Ø 15	6	81
50 BW'S/L (04/13) - 50 BW'S Naked (04-09/13) - 50 BW'S Easy (13)	28.0536 ◆	5BRF450000	depressione Ø 15	6	81
50 Jog R (02/07)	28.0536 ◆	5KKF450000	depressione Ø 15	6	81
50 Jog R (08/13)	28.0512 ◆	5ADF450000	depressione Ø 15	6	81
100 Aerox - 100 Neo's	28.0536 ◆	5KKF450000	depressione Ø 15	6	81
125/150/180 Majesty (01/10) - 125/150 Teo's - 125/150 Maxster	28.0536 ◆	5KKF450000	depressione Ø 15	6	81
ZUNDAPP					
Ciclomotore 50 - con riserva - con scatto - in zama	28.0066 □		M 12 X 1,0	6	79

Figurato rubinetti benzina

28.0001 Ø 10x1 - codulo Ø 6
senza riserva - in zama

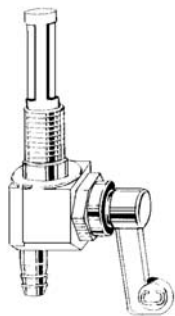

**Ciclomotori Motom • Benelli • Sachs
Malanca • Motori agricoli
Volpi & Bottoli • Minarelli • Beta**

28.0033 con riserva - con scatto - con leva
28.00331 con riserva - con scatto - senza leva
Ø 16x1 - codulo Ø 8

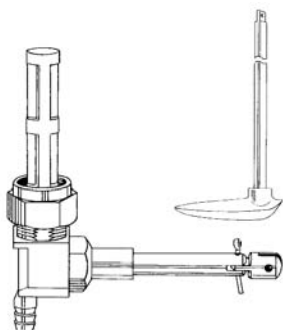

Innocenti

28.0041 Ø 10x1 - codulo Ø 9
senza riserva - a vite

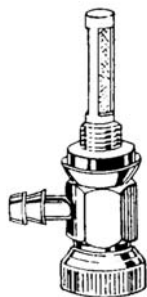

Benassi motori Agricoli
*permette un'alimentazione di carburante
di circa 30 litri/ora*

28.0058 Ø 12x1 - codulo Ø 6
con riserva - asta mm. 55

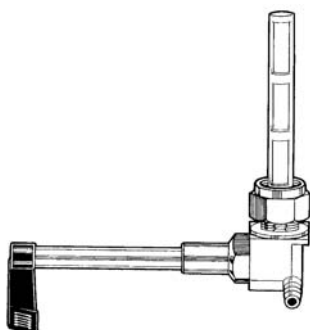

Piaggio

28.0022 Ø 12x1,5 - codulo Ø 6
con riserva - con scatto

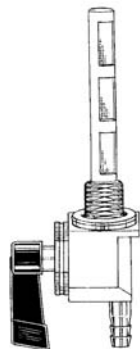

Ciclomotori e moto varie

28.00381 Ø 10x1 - codulo Ø 6 - con riserva
in zama - economico

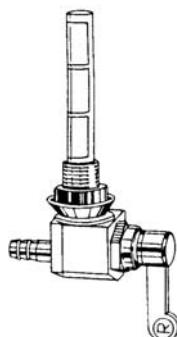

**Ciclomotori Peripoli • Cimatti • Demm
Negrini • Malaguti • Motori agricoli Sep**

28.0050 con riserva - con scatto - con leva
28.00501 con riserva - con scatto - senza leva
Ø 16x1 - codulo Ø 8

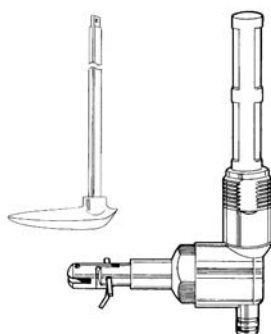

Innocenti

28.0059 Ø 12x1 - codulo Ø 6 - con riserva

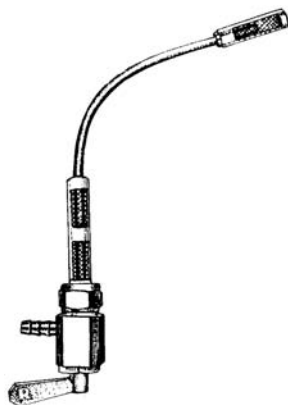

Piaggio

28.00251 Ø 10x1 - codulo Ø 6 - con riserva
in zama - economico

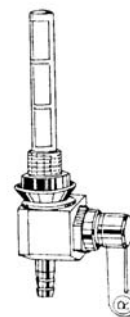

**Ciclomotori Benelli • Cimatti
Malaguti • Rizzato**

28.0040 Ø 10x1 - codulo Ø 6,5
senza riserva - a vite

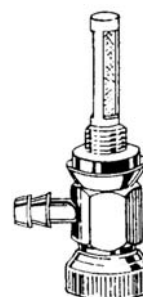

Minarelli motori agricoli
*permette un'alimentazione di carburante
di circa 30 litri/ora*

28.0052 Ø 16x1 - codulo Ø 8
con riserva - con scatto



Innocenti

28.0063 Ø 10x1 - codulo Ø 6
con riserva - con scatto



Ciclomotori vari

28.0064 Ø 10x1 - codulo Ø 6
con riserva - con scatto

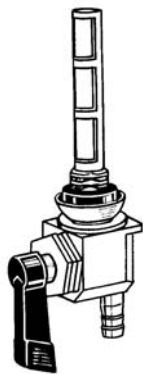

Peugeot • Ciclomotori vari

28.0066 Ø 12x1 - codulo Ø 6
con riserva - con scatto - in zama



DKW • Garelli • Zundapp

28.0067 Ø 12x1 - codulo Ø 8,5
senza riserva - a vite

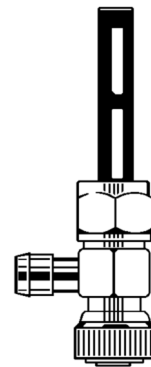

Piaggio

28.0070 Ø 12x1 - codulo Ø 8,5
senza riserva - a vite



Piaggio

28.0072 Ø 23x1,5 - codulo Ø 9
con riserva - asta lunga mm. 200

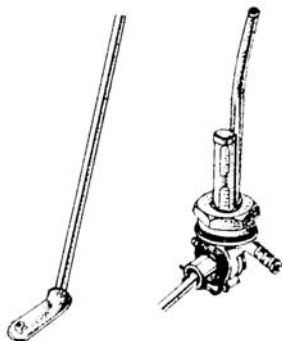

Piaggio

28.0073 Ø 24x1,5 - codulo Ø 9
con riserva - asta corta mm. 165

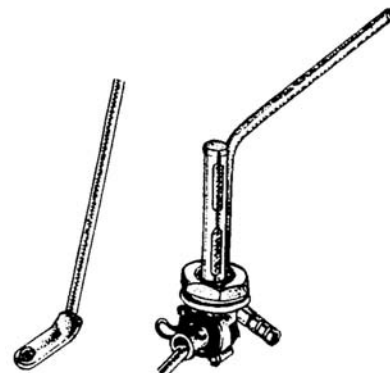

Piaggio

28.0074 sinistro con riserva
Ø 16x1 - codulo Ø 8
28.0109 destro con riserva Ø 16x1 - codulo Ø 8



Aprilia • Benelli • Beta • Guzzi

28.0076 Ø 16x1 - codulo Ø 6 - con riserva

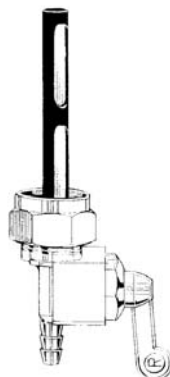

**Husqvarna • KTM • Tomos
Ciclomotori vari**

28.00761 Ø 16x1 - codulo Ø 6
con riserva (asta mm. 35)

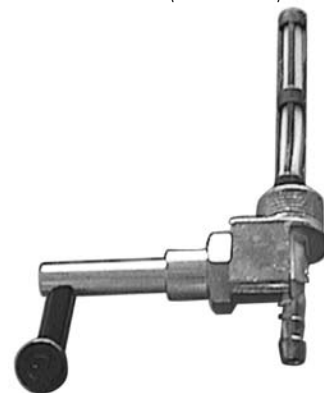

Husqvarna • KTM • Tomos

28.0077 Ø 12x1 - codulo Ø 6
con riserva - con scatto

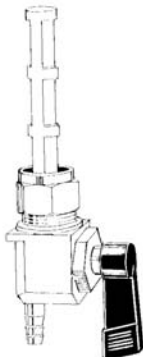

Gilera • Sachs • Ciclomotori vari

28.0078 Ø 12x1 - codulo Ø 6
con riserva - con scatto

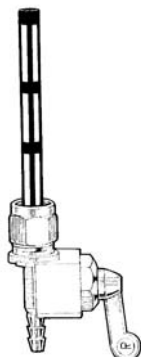

Gilera • Garelli

28.0088 Ø 12x1 - codulo Ø 6 - con riserva

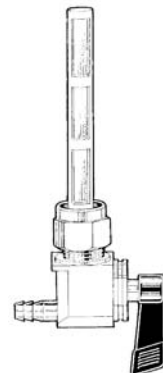

Benelli • Guzzi

RUBINETTI

28.0093 Ø 10x1 - codulo Ø 6
con riserva (asta mm. 27)

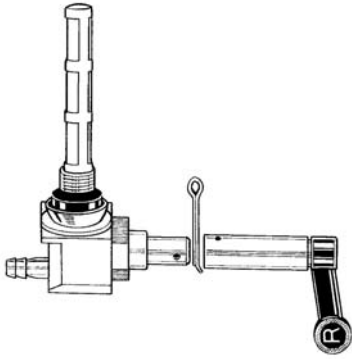

Rizzato

28.0101 Ø 16x1 - codulo Ø 8 - con riserva

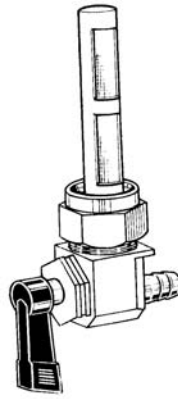

Fantic

28.0108 sinistro - con riserva
Ø 16x1 - codulo Ø 8
28.0110 destro - con riserva Ø 16x1
codulo Ø 8



Guzzi

28.0111 Ø 10x1 - codulo Ø 6 - con riserva



Beta • Peugeot

28.0112 Ø 10x1 - codulo Ø 6
senza riserva - a vite



Aspes

28.0120 Ø 12x1 - codulo Ø 6 - con riserva

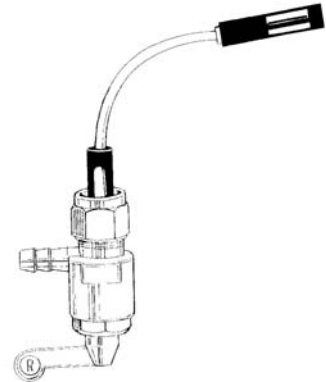

Puch

28.0124 Ø 10x1 - codulo Ø 7
con riserva - con vaschetta

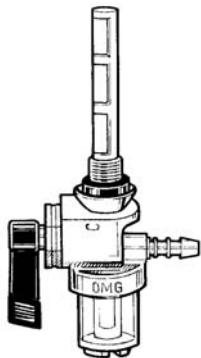

Ciclomotori vari

28.0132 Ø 12x1 - codulo Ø 6
con riserva (asta mm. 35)

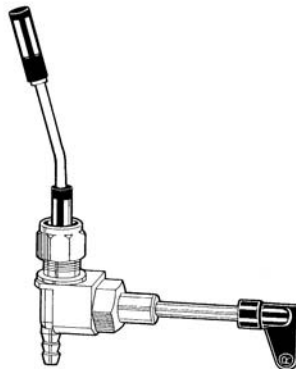

Benelli

28.0135 codulo Ø 8,5 - con riserva
attacco a flangia



KTM

28.0137 Ø 16x1 - codulo Ø 6 - con riserva

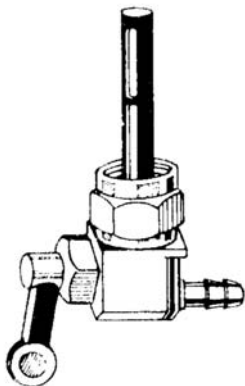

Honda

28.0138 Ø 12x1 - codulo Ø 6 - con riserva

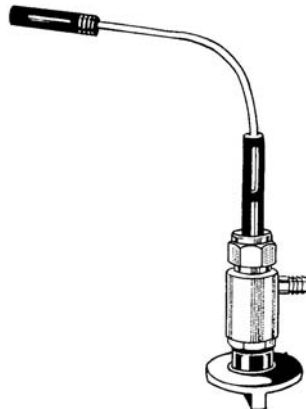

Gilera

28.0144 Ø 12x1 - codulo Ø 6 - con riserva
c/indicatore di posizione a scatto
(off - fuel - reserve)

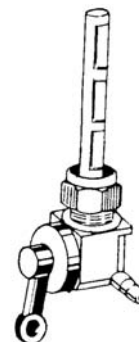

Piaggio

28.0226 sinistro - con riserva Ø 16x1
codulo Ø 8
28.0239 destro - con riserva Ø 16x1
codulo Ø 8



**Benelli • Ducati • Fantic
Gilera • Laverda • SWM**

28.0236 Ø 16x1 - codulo Ø 8 - destro
senza riserva



Guzzi

28.0238 Ø 24x1,5 - codulo Ø 9
con riserva - asta corta mm. 165

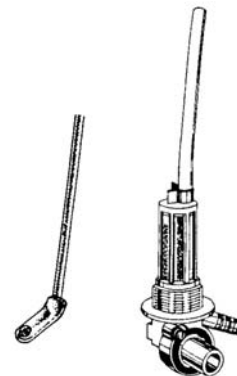

Piaggio

28.0241 Ø 16x1 - codulo Ø 8 - sinistro
con segnalatore elettrico riserva



Guzzi

28.0247 Ø 10x1 - codulo Ø 6 - con riserva

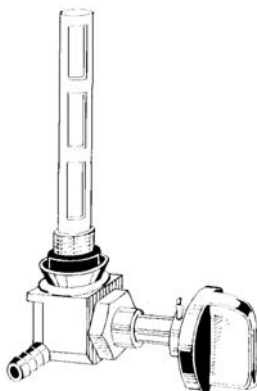

Malaguti

28.0267 codulo Ø 8 - con riserva
attacco a flangia



KTM

28.0512 codulo Ø 6 - attacco a depressione



**Aprilia • Benelli • Betamotor • Cagiva
Derbi • Gilera • Kymco • Italjet • Malaguti
MBK • Peugeot • Piaggio • Yamaha**

28.0514 codulo Ø 8 - attacco a flangia



Aprilia • Italjet • Malaguti • Rizzato

28.0521 Ø 11,5x1 - codulo Ø 6
s/leva - c/riserva

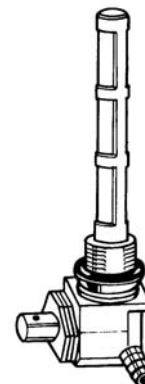

Peugeot

28.0523 codulo Ø 6 - attacco a depressione



Aprilia • Piaggio

28.0530 codulo Ø 6 - attacco a depressione
con segnalatore elettrico riserva
c/cavo 300 mm. - filtraggio 195
Micron livello riserva 55 mm.



Peugeot

28.0536 codulo Ø 6 - attacco a depressione



Gilera • MBK • Piaggio • Yamaha

28.0537 codulo Ø 6 - attacco a depressione



Gilera

28.0538 Ø 16x1,5 - codulo Ø 6



Honda

28.0539 codulo Ø 6 - attacco a depressione con riserva



Peugeot

28.0540 codulo Ø 6 - attacco a depressione con segnalatore elettrico riserva c/cavo 180 mm. - filtraggio 100 Micron livello riserva 51 mm.



Peugeot

28.0541 codulo Ø 6 - attacco a depressione con segnalatore elettrico riserva c/cavo 300 mm. - filtraggio 195 Micron livello riserva 70 mm.



Peugeot

28.0542 codulo Ø 6 - attacco a depressione



Peugeot

28.0544 Ø 12x1,5 - codulo Ø 8 - con riserva



Ducati

28.0604 Ø 10x1 - codulo Ø 6 - con riserva

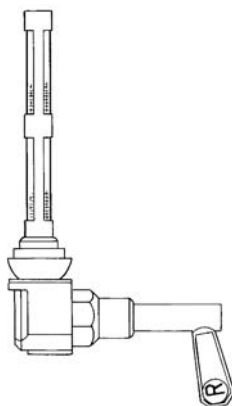

Peugeot

28.0608 codulo Ø 8,5 - attacco a depressione - senza riserva - a vite



Piaggio

Figurato sonde livello benzina e olio

09.2818 sonda livello benzina grigia
mm. 153 - 2 fili



Sostituisce 09.2820
Aprilia

09.2819 sonda livello benzina grigia
mm. 215 - 3 fili



Sostituisce 09.2817
Aprilia

09.2825 sonda livello benzina nera
mm. 153 - 3 fili



Aprilia

28.0305 sonda livello benzina
Ø 16x1 - 2 fili



Gilera

28.0313 sonda livello benzina
Ø 16x1 - 2 fili

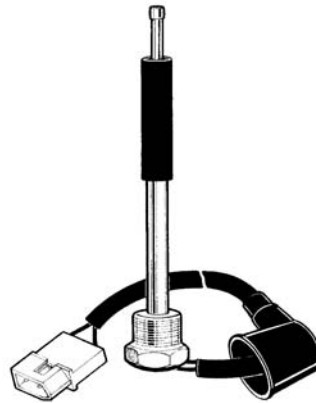

Guzzi

28.0317 sonda livello benzina - Ø 15
innesto a pressione - 2 fili



Gilera • Piaggio

28.0406 sonda livello olio



Aprilia

Tabella applicazioni paraoli forcella "Vesrah"



Applicazioni c.c. marca/modello		anno	Cod. SGR	Misure/tipo	Riferimento originale
APRILIA					
50	Red Rose	89/92	44.0821 ○	36X49X11	AP8103371
50	Classic	92/99	44.0821 ○	36X49X11	AP8103371
125	Europa	90/91	44.0266	38X50X10,5 DR3	8103908/544/285/050
125	AF1/Replica/Super	87	44.0038	36X48X10,5 DR3	AP8103731
125	AF1 Sintesi/Replica	88/89	44.0266	38X50X10,5 DR3	8103908/544/285/050
125	Atlantic/Euro 3 (Forcella Showa)	02/14	44.0040	35X48X11 DRD2	AP8123769
125	Leonardo/ST (Forcella Showa)	96/05	44.0040	35X48X11 DRD2	AP8123769
125	Pegaso	89/90	44.0266	38X50X10,5 DR3	8103908/544/285/050
125	RX	85	44.0303	40X52X8/9,5 DR2	AP8103235
125	RX	94/98	44.0303	40X52X8/9,5 DR2	AP8123718
125	Scarabeo/GT (Mot. Rotax - Forcella Showa)	99/04	44.0040	35X48X11 DRD2	AP8123769
125	Scarabeo/GT/E3 (M.Piaggio - Forc.Showa)	03/07	44.0040	35X48X11 DRD2	AP8123769
125	Scarabeo Light/Net i.e.	07/14	44.0350	36 x 48 x 11 DRD2	JC52240X92000
125	Tuareg Rally	86	44.0303	40X52X8/9,5 DR2	AP8103235
125	Tuareg Rally versione B/C/D	91/92	44.0303	40X52X8/9,5 DR2	AP8103235
125	Tuareg Wind	88/89	44.0266	38X50X10,5 DR3	AP8103908/544
150	Leonardo/ST (Forcella Showa)	96/05	44.0040	35X48X11 DRD2	AP8123769
150	Scarabeo/GT (Mot. Rotax - Forcella Showa)	99/04	44.0040	35X48X11 DRD2	AP8123769
200	Atlantic (Forcella Showa)	03/06	44.0040	35X48X11 DRD2	AP8123769
200	Scarabeo/GT (Mot. Rotax - Forcella Showa)	99/04	44.0040	35X48X11 DRD2	AP8123769
200	Scarabeo/GT/E3 (M.Piaggio - Forc.Showa)	03/07	44.0040	35X48X11 DRD2	AP8123769
200	Scarabeo Light/Net i.e.	07/14	44.0350	36 x 48 x 11 DRD2	JC52240X92000
250	Atlantic/IE/Euro 3 (Forcella Showa)	04/09	44.0040	35X48X11 DRD2	AP8123769
250	Leonardo/ST (Forcella Showa)	99/05	44.0040	35X48X11 DRD2	AP8123769
250	Scarabeo/GT (Forcella Showa)	04/06	44.0040	35X48X11 DRD2	AP8123769
250	MX/RX	83	44.0303	40X52X8/9,5 DR2	AP8103235
250	Tuareg Rally	86	44.0303	40X52X8/9,5 DR2	AP8103235
300	Atlantic (Forcella Showa)	10/14	44.0040	35X48X11 DRD2	AP8123769
300	Leonardo/ST (Forcella Showa)	04/06	44.0040	35X48X11 DRD2	AP8123769
350	ETX (I.M.A Bianco / I.M.E Rosso)	85/86	44.0266	38X50X10,5 DR3	AP8103544
350	ETX A.E. (I.M.A Blu / I.M.A nero)	85/86	44.0266	38X50X10,5 DR3	AP8103544
350	ETX A.E. 6 marce	87	44.0266	38X50X10,5 DR3	AP8103544
350	Tuareg (I.M.A Blu - Marzocchi ø38)	86	44.0266	38X50X10,5 DR3	AP8103544
350	Tuareg Wind (I.M.A)	87	44.0266	38X50X10,5 DR3	AP8103544
400	Atlantic Sprint (Forcella Showa)	05/09	44.0040	35X48X11 DRD2	AP8123769
500	Atlantic Sprint (Forcella Showa)	05/09	44.0040	35X48X11 DRD2	AP8123769
600	Pegaso	90/91	44.0266	38X50X10,5 DR3	8103908/544/285/050
850	SRV	12/14	44.1140	41x53x8/10,5 DRD2	975702/599267

○ coppia non di produzione Vesrah ad esaurimento scorte

Applicazioni c.c. marca/modello	anno	Cod. SGR	Misure/tipo	Riferimento originale
BMW				
850 R 850 C	97/00	44.0040	35X48X11 DRD2	31422311988
850 R 850 GS	96/00	44.0040	35X48X11 DRD2	31422311988
850 R 850 R	94/07	44.0040	35X48X11 DRD2	31422311988
900 R 900 RT	05/12	44.0040	35X48X11 DRD2	31422311988
1100 R 1100 R /R Rockster	93/01	44.0040	35X48X11 DRD2	31422311988
1100 R 1100 RS	92/01	44.0040	35X48X11 DRD2	31422311988
1100 R 1100 RT	94/01	44.0040	35X48X11 DRD2	31422311988
1100 R 1100 S	96/05	44.0040	35X48X11 DRD2	31422311988
1150 R 1150 GS	99/08	44.0040	35X48X11 DRD2	31422311988
1150 R 1150 GS Adventure	02/08	44.0040	35X48X11 DRD2	31422311988
1150 R 1150 R/R Rockster	00/08	44.0040	35X48X11 DRD2	31422311988
1150 R 1150 RS	00/04	44.0040	35X48X11 DRD2	31422311988
1150 R 1150 RT ABS	00/06	44.0040	35X48X11 DRD2	31422311988
1200 K 1200 GT ABS	01/05	44.0040	35X48X11 DRD2	31422311988
1200 K 1200 LT	98/10	44.0040	35X48X11 DRD2	31422311988
1200 K 1200 RS	96/05	44.0040	35X48X11 DRD2	31422311988
1200 R 1200 C Cruiser	96/03	44.0040	35X48X11 DRD2	31422311988
1200 R 1200 CL ComfortLine	02/>	44.0040	35X48X11 DRD2	31422311988
1200 R 1200 CI Independent	00/05	44.0040	35X48X11 DRD2	31422311988
1200 R 1200 Montauk	03/>	44.0040	35X48X11 DRD2	31422311988
1200 R 1200 R	06/10	44.0040	35X48X11 DRD2	31422311988
1200 R 1200 RT	05/12	44.0040	35X48X11 DRD2	31422311988
BUELL				
1200 S1 Lightning	99/00	44.0314	41X54X11 DRD2	
1200 S3 Thunderbolt	99/00	44.0314	41X54X11 DRD2	
CAGIVA				
125 SST	81/>	44.0804 ○	31,5X45X7	800023929
125 Aletta Electra (Forcella LLOBE)	81/>	44.0804 ○	31,5X45X7	800023929
125 WMX	83/84	44.0303	40X52X8/9,5 DR2	
250 WMX	84	44.0303	40X52X8/9,5 DR2	
350 Ala Rossa 4T	84/>	44.0266	38X50X10,5 DR3	800032513
900 Elefant	93/97	44.1080	45X57X11 DRD2	800072085
DERBI				
50 GPR/Replica	97/01	44.0040	35X48X11 DRD2	00H00202471
50 Senda R	00/01	44.0040	35X48X11 DRD2	00H00202471
50 Senda R Racer	03	44.0350	36 x 48 x 11 DRD2	00H00204471
50 Senda R X-Race	03	44.0350	36 x 48 x 11 DRD2	00H00204471
50 Senda R X-Trem/Euro 2	02/06	44.0350	36 x 48 x 11 DRD2	00H00204471
50 Senda SM	00/01	44.0040	35X48X11 DRD2	00H00202471
50 Senda SM X-Race	04	44.0350	36 x 48 x 11 DRD2	00H00204471
50 Senda SM X-Trem/Euro 2	02/06	44.0350	36 x 48 x 11 DRD2	00H00204471
DUCATI				
400 Monster	00/02	44.0243	43X54X11 DRD2	93010051A
600 Monster	00/01	44.0243	43X54X11 DRD2	93010051A
748 748 Biposto/SP/SPS/Racing	95/02	44.0243	43X54X11 DRD2	93010051A
748 748 R/S/Testa Stretta	00/02	44.0243	43X54X11 DRD2	93010051A
749 749/R/S	03/06	44.0243	43X54X11 DRD2	93010051A
750 FI	87	44.1030	38X50X8/9,5 DR2	079537367
750 Monster (Forcella Showa)	96/97	44.0314	41X54X11 DRD2	93010021A

<i>Applicazioni c.c. marca/modello</i>	<i>anno</i>	<i>Cod. SGR</i>	<i>Misure/tipo</i>	<i>Riferimento originale</i>
750 Monster	99/01	44.0243	43X54X11 DRD2	93010051A
750 Supersport (Forcella Showa)	91/97	44.0314	41X54X11 DRD2	93010021A
750 Supersport	99/02	44.0243	43X54X11 DRD2	93010051A
800 Supersport	03/04	44.0243	43X54X11 DRD2	93010051A
851 Supebike Strada	91/92	44.0314	41X54X11 DRD2	93010021A
860 GT (Forcella Ceriani)	75/>	44.1030	38X50X8/9,5 DR2	079537367
888 Supebike/SP/SP5	93/95	44.0314	41X54X11 DRD2	93010021A
900 SD Sport Desmo Darmah (Ceriani)	76/83	44.1030	38X50X8/9,5 DR2	079537367 a.mim3850/7
900 SSD SuperSportDesmoDarmah (Marzocchi)	76/82	44.1030	38X50X8/9,5 DR2	079537367
900 SS SuperSport	76/83	44.1030	38X50X8/9,5 DR2	079537367
900 S2	82/83	44.1030	38X50X8/9,5 DR2	079537367
900 MHR Mike Hailwood replica	82/83	44.1030	38X50X8/9,5 DR2	079537367
900 Monster (Forcella Showa)	93/99	44.0314	41X54X11 DRD2	93010021A
900 Monster	98/99	44.0314	41X54X11 DRD2	93010021A
900 Monster IE	00/01	44.0314	41X54X11 DRD2	93010021A
900 Monster IE	00/02	44.0243	43X54X11 DRD2	93010051A
900 Monster (Forcella Showa)	93/97	44.0314	41X54X11 DRD2	93010021A
900 SuperSport IE/FE	98/02	44.0243	43X54X11 DRD2	93010051A
916 916 BIP/S Senna	94/98	44.0243	43X54X11 DRD2	93010051A
916 916 SP	94/96	44.0243	43X54X11 DRD2	93010051A
916 Monster S4	01/02	44.0243	43X54X11 DRD2	93010051A
916 ST4	99/03	44.0243	43X54X11 DRD2	93010051A
944 ST2	97/03	44.0243	43X54X11 DRD2	93010051A
996 996 R Testa Stretta	01	44.0243	43X54X11 DRD2	93010051A
996 996 S/SP	99/01	44.0243	43X54X11 DRD2	93010051A
996 Monster S4R	03/06	44.0243	43X54X11 DRD2	93010051A
996 ST4 S/ABS	01/06	44.0243	43X54X11 DRD2	93010051A
998 998 BIP/Matrix/R/SBayliss/Bostrom	02/04	44.0243	43X54X11 DRD2	93010051A
998 999/S/R	03/06	44.0243	43X54X11 DRD2	93010051A
1000 ST3	05/07	44.0243	43X54X11 DRD2	93010051A
1000 Monster S	03/04	44.0243	43X54X11 DRD2	93010051A
1000 Monster S2R	06/08	44.0243	43X54X11 DRD2	93010051A
1000 Supersport SS	03/06	44.0243	43X54X11 DRD2	93010051A

GILERA

50 RCR	03/07	44.0350	36 x 48 x 11 DRD2	00H00204471
50 SMT	03/07	44.0350	36 x 48 x 11 DRD2	00H00204471
125 KK/KZ/Endurance (Paioli)	86/>	44.0040	35X48X11 DRD2	327375/327586
125 Rally (86 - Marzocchi)	88/>	44.0266	38X50X10,5 DR3	318987/326918/340164
125 RV	86/90	44.0040	35X48X11 DRD2	327375/327586
125 RX / Arizona	86/88	44.0040	35X48X11 DRD2	327375/327586
125 R1/R1S	88/>	44.0040	35X48X11 DRD2	327375/327586
125 XR1/XR2	88/>	44.0266	38X50X10,5 DR3	318987/326918/340164
250 Rally (86 - Marzocchi)	88/>	44.0266	38X50X10,5 DR3	318987/326918/340164
250 RV NGR (Marzocchi)	88/>	44.0266	38X50X10,5 DR3	318987/326918/340164
350 Dakota (Marzocchi)	88/>	44.0266	38X50X10,5 DR3	318987/326918/340164
500 Nexus	03/12	44.1140	41x53x8/10,5 DRD2	975702/599267
800 GP	08/12	44.1140	41x53x8/10,5 DRD2	975702/599267

HONDA

80 CR R	84/86	44.0027	33x46x11 DRD2	91255413881
80 CR R	87/95	44.0040	35X48X11 DRD2	91255KBH003
80 CR R/RB	96/02	44.0300	37X50X11 DRD2	51490GBFJ21
85 CR R/RB	03/07	44.0300	37X50X11 DRD2	51490GBFJ21
125 CA Rebel	95/99	44.0027	33x46x11 DRD2	51490473305

<i>Applicazioni</i> c.c. <i>marca/modello</i>	<i>anno</i>	<i>Cod. SGR</i>	<i>Misure/tipo</i>	<i>Riferimento originale</i>
125 CLR City Fly	98	44.0300	37X50X11 DRD2	51490KAZ003
125 CR R Elsinore	76/78	44.0040	35X48X11 DRD2	91255KBH003
125 CR R	79/82	44.0266	38X50X10,5 DR3	91255KA3701
125 CR R	83/86	44.1070	43X55X10,5/12 DR3	51490KA3711
125 CR R	87	44.0314	41X54X11 DRD2	51490KA4831
125 CR R	88/89	44.0314	41X54X11 DRD2	51490KS6305
125 CR R	90	44.1080	45X57X11 DRD2	51490KZ3810
125 CR R	91	44.1080	45X57X11 DRD2	51490KZ3821
125 CR R	92/93	44.1080	45X57X11 DRD2	51490ML3305
125 CR R	94/96	44.1060	43X55X9,5/10,5 DR3	51490KZ4305
125 CR R	97/98	44.1100	46X58X9,5/11,5 DRD2	51490MAC741
125 CR R	99/07	44.1100	46X58X9,5/11,5 DRD2	51490KZ4J21
125 CRE Motard	02/04	44.1100	46X58X9,5/11,5 DRD2	51490KZ4J21
125 CRE R	05/08	44.1100	46X58X9,5/11,5 DRD2	51490KZ4J21
125 CRM R	05/08	44.1100	46X58X9,5/11,5 DRD2	51490KZ4J21
125 FES Pantheon 2T	98/02	44.0027	33x46x11 DRD2	51490KL8900
125 FES Pantheon 4T	03/06	44.0027	33x46x11 DRD2	51490KL8900
125 FES S-Wind 4T	07/12	44.0027	33x46x11 DRD2	51490KL8900
125 NSR F (JC22)	93	44.0040	35X48X11 DRD2	51490KBH305
125 NSR R (JC22)	93/01	44.0040	35X48X11 DRD2	51490KBH305
125 PES PS i	05/13	44.0027	33x46x11 DRD2	51490KL8900
125 SH ie	05/12	44.0027	33x46x11 DRD2	51490KL8900
125 SH ABS	13/14	44.0027	33x46x11 DRD2	91255KL8900
125 VT C Shadow (JC29)	99/00	44.0040	35X48X11 DRD2	51490KBH305
125 VT C Shadow (JC31)	01/07	44.0040	35X48X11 DRD2	51490KBH305
125 XL R (JD04)	82/87	44.0027	33x46x11 DRD2	91255413881
125 XL V Varadero (JC32 Carb.)	01/06	44.0040	35X48X11 DRD2	51490KBH305
125 XL V Varadero (JC32 Iniez.)	07/12	44.0040	35X48X11 DRD2	51490KBH305
150 CRF F	03/14	44.0040	35X48X11 DRD2	51490KL4951
150 CRF R	07/14	44.0300	37X50X11 DRD2	51490GBFJ21
150 FES Pantheon 2T	98/02	44.0027	33x46x11 DRD2	51490KL8900
150 FES Pantheon 4T	03/06	44.0027	33x46x11 DRD2	51490KL8900
150 FES S-Wind 4T	07/12	44.0027	33x46x11 DRD2	51490KL8900
150 PES PS i	05/13	44.0027	33x46x11 DRD2	51490KL8900
150 SH ie	05/12	44.0027	33x46x11 DRD2	51490KL8900
150 SH ABS	13/14	44.0027	33x46x11 DRD2	91255KL8900
200 XR/R	80/83	44.0040	35X48X11 DRD2	91255KBH003
200 XR/R	84/99	44.0038	36X48X10,5 DR3	51490KK0305
250 ATC SX	85/86	44.0241	39X52X11 DRD2	91255463003
250 CM C	81/83	44.0027	33x46x11 DRD2	91255413881
250 CB N/Superdream (78/85)	78/85	44.0027	33x46x11 DRD2	91255369000
250 CB RS	80/83	44.0027	33x46x11 DRD2	91255413881
250 CB T/T II	77/79	44.0027	33x46x11 DRD2	91255369000
250 CBF	04/07	44.0300	37X50X11 DRD2	51490KAZ003
250 CBX	84/86	44.0027	33x46x11 DRD2	91255413881
250 CMX C Rebel (MC13)	85/87	44.0027	33x46x11 DRD2	51490473305
250 CMX C Rebel (MC13)	96/13	44.0027	33x46x11 DRD2	51490473305
250 CR R	81/83	44.0345	41X53X10,5 DR3	91255KA4004
250 CR R	84	44.0345	41X53X10,5 DR3	51490KA4731
250 CR R	85/87	44.0314	41X54X11 DRD2	51490KA4831
250 CR R	88	44.0314	41X54X11 DRD2	51490KS6305
250 CR R	89/90	44.1080	45X57X11 DRD2	51490KZ3810
250 CR R/CRE R	91	44.1080	45X57X11 DRD2	51490KZ3821
250 CR R/CRE R	92/94	44.1080	45X57X11 DRD2	51490ML3305
250 CR R/CRE R	95	44.1060	43X55X9,5/10,5 DR3	51490KZ4305
250 CR R/CRE R	96	44.1100	46X58X9,5/11,5 DRD2	51490KZ4J21

<i>Applicazioni</i>	<i>c.c.</i>	<i>marca/modello</i>	<i>anno</i>	<i>Cod. SGR</i>	<i>Misure/tipo</i>	<i>Riferimento originale</i>
250	CR R/CRE R/SM		97/07	44.1110	47X58X10 DR3	51490MEN003
250	CRE Motard 2T/4T		02/04	44.1110	47X58X10 DR3	51490MEN003
250	CRE/R		05/08	44.1110	47X58X10 DR3	51490MEN003
250	CRE F R		05/07	44.1110	47X58X10 DR3	51490MEN003
250	CRF L		13/14	44.0243	43X54X11 DRD2	51490MFL003
250	CRF R		04/09	44.1110	47X58X10 DR3	51490MEN003
250	CRF X		04/13	44.1110	47X58X10 DR3	51490KSC003
250	CRM/R		05/08	44.1110	47X58X10 DR3	51490MEN003
250	CRM F R		05/07	44.1110	47X58X10 DR3	51490MEN003
250	FES Foresight		98/05	44.0027	33x46x11 DRD2	51490KL8900
250	NSS Jazz / ABS		01/04	44.0027	33x46x11 DRD2	51490KL8900
250	NSS Forza X/EX		05/07	44.0027	33x46x11 DRD2	51490KL8900
250	NSS Forza A/S/ABS		08/12	44.0040	35X48X11 DRD2	51490KVZ631
250	XL R/S		80/83	44.0040	35X48X11 DRD2	91255KBH003
250	XR		79/80	44.0040	35X48X11 DRD2	91255KBH003
250	XR R (ME01/ME06)		81/85	44.0300	37X50X11 DRD2	51490GBFJ21
250	XR R (ME06/ME08)		86/04	44.0302	41X53X8/10,5 DR2	51490KZ1671
290	CRE IE		07/08	44.1110	47X58X10 DR3	51490KSC003
290	CRM IE		07/08	44.1110	47X58X10 DR3	51490KSC003
300	SH		07/13	44.0040	35X48X11 DRD2	51490KTW901/B01
350	CB S (NC22)		86/88	44.0040	35X48X11 DRD2	51490KBH305
350	XL		74/78	44.0040	35X48X11 DRD2	91255KBH003
350	XL R (ND03)		85/86	44.0241	39X52X11 DRD2	91255463003
400	CB F Four/SuperSport		77/78	44.0027	33x46x11 DRD2	91255369000
400	CB F (CB1/NC27)		89/90	44.0314	41X54X11 DRD2	51490MN8305
400	CB A HondaMatic		78	44.0027	33x46x11 DRD2	91255369000
400	CB N		78/84	44.0027	33x46x11 DRD2	91255369000
400	CB T/T II/TZ/TZ II/Hawk		78/81	44.0027	33x46x11 DRD2	91255369000
400	CBX F/F2 (NC07)		81/82	44.0040	35X48X11 DRD2	51490MA6305
400	CM A/C/E/T		79/81	44.0027	33x46x11 DRD2	91255369000
400	FJS Silver Wing/SW-T/ABS		06/12	44.1140	41x53x8/10,5 DRD2	51490MCT003
400	XR R/Supermotard		96/06	44.0314	41X54X11 DRD2	51490KS6305
400	VFR R		90/91	44.0314	41X54X11 DRD2	51490MN8305
440	XR R		96/02	44.0314	41X54X11 DRD2	51490MN8305
450	CB SC Nighthawk (PC05)		82/86	44.0027	33x46x11 DRD2	51490413305
450	CB T		82/>	44.0027	33x46x11 DRD2	51490413305
450	CB S (PC17)		86/89	44.0040	35X48X11 DRD2	51490KBH305
450	CM A/C/E		82/>	44.0027	33x46x11 DRD2	51490413305
450	CMX C		86/87	44.0300	37X50X11 DRD2	51490ML7305
450	CRE Motard 2T		02/04	44.1110	47X58X10 DR3	51490MEN003
450	CRE F R		05/08	44.1110	47X58X10 DR3	51490MEN003
450	CRE F R		09/13	44.1170	48X58,1X8,5/10,5 DRD2	51490MENA31
450	CRE X		07/08	44.1110	47X58X10 DR3	51490KSC003
450	CRF R		02/08	44.1110	47X58X10 DR3	51490MEN003
450	CRF R		09/14	44.1170	48X58,1X8,5/10,5 DRD2	51490MENA31
450	CRF X		05/13	44.1110	47X58X10 DR3	51490KSC003
450	CRM F R		05/08	44.1110	47X58X10 DR3	51490MEN003
450	CRM F R		09/13	44.1170	48X58,1X8,5/10,5 DRD2	51490MENA31
450	CRM X		07/08	44.1110	47X58X10 DR3	51490KSC003
480	CR R		82/83	44.0351	43X55X10,5 DR3	91255KA4701
490	CRE X IE		07/08	44.1110	47X58X10 DR3	51490KSC003
490	CRM X IE		07/08	44.1110	47X58X10 DR3	51490KSC003
500	CB/CB S (PC26/PC32)		94/03	44.0300	37X50X11 DRD2	51490KAZ003
500	CB F / FA ABS		12/13	44.0314	41X54X11 DRD2	51490MERR61
500	CB X / XA ABS		12/13	44.0314	41X54X11 DRD2	51490MERR61
500	CBF/ABS (PC39)		04/06	44.0314	41X54X11 DRD2	51490MN8305

<i>Applicazioni</i>	<i>c.c. marca/modello</i>	<i>anno</i>	<i>Cod. SGR</i>	<i>Misure/tipo</i>	<i>Riferimento originale</i>
500	CBR R / RA ABS	12/13	44.0314	41X54X11 DRD2	51490MERR61
500	CR R	85/88	44.0314	41X54X11 DRD2	51490MN8305
500	CR R	89/91	44.1080	45X57X11 DRD2	51490KZ3810/21
500	CR R	92/94	44.1080	45X57X11 DRD2	51490ML3305
500	CR R	95/01	44.1100	46X58X9,5/11,5 DRD2	51490KZ4J21
500	CX	77/81	44.0027	33x46x11 DRD2	91255369000
500	CX	82/>	44.0040	35X48X11 DRD2	91255KBH003
500	CX C Custom	78/80	44.0027	33x46x11 DRD2	91255413881
500	CX C Custom	81/>	44.0040	35X48X11 DRD2	91255KBH003
500	FT Ascot (PC07)	82/83	44.0300	37X50X11 DRD2	51490KAZ003
500	GL/Interstate	81/82	44.0040	35X48X11 DRD2	91255KBH003
500	VF C V30 Magna (PC13)	84/86	44.0300	37X50X11 DRD2	51490KAZ003
500	VF F/ F2/FL Interceptor (PC12)	84/86	44.0300	37X50X11 DRD2	51490KAZ003
500	VT C Shadow (PC08)	83/86	44.0300	37X50X11 DRD2	51490KAZ003
500	XR R	79/80	44.0040	35X48X11 DRD2	91255KBH003
500	XR R	81/82	44.0300	37X50X11 DRD2	51490GBFJ21
550	CB K Four	77/79	44.0040	35X48X11 DRD2	91255KBH003
550	CB F Four/Supersport	77/78	44.0040	35X48X11 DRD2	91255KBH003
550	CB SC Nighthawk	83	44.0300	37X50X11 DRD2	51490KAZ003
550	CBX F/F2	82/>	44.0040	35X48X11 DRD2	51490MA6305
600	CB F Hornet/S	98/04	44.0314	41X54X11 DRD2	51490MN8305
600	CB F Hornet/S	05/08	44.0314	41X54X11 DRD2	51490MEED01
600	CB F/FA Hornet/ABS	09/13	44.0314	41X54X11 DRD2	51490MERR61
600	CBF N/S (PC38)	04/07	44.0314	41X54X11 DRD2	51490MN8305
600	CBF N/S/ABS	08/13	44.0314	41X54X11 DRD2	51490MERR61
600	CBR F	87/90	44.0300	37X50X11 DRD2	51490ML7305
600	CBR F	91/98	44.0314	41X54X11 DRD2	51490MN8305
600	CBR F	99/00	44.0243	43X54X11 DRD2	51490MZ1305
600	CBR F (PC35)	01/04	44.0243	43X54X11 DRD2	51490MCF000
600	CBR F (PC35)	05/06	44.0243	43X54X11 DRD2	51490MEJ003
600	CBR F / FA (PC41)	11/13	44.0314	41X54X11 DRD2	51490MERR61
600	CBR F3 (Estero)	95/98	44.0314	41X54X11 DRD2	51490MN8305
600	CBR F4 (Estero)	99/00	44.0243	43X54X11 DRD2	51490MZ1305
600	CBR F4 (Estero)	01/04	44.0243	43X54X11 DRD2	51490MCF000
600	CBR FS Sport/FR Rossi (PC35)	01/02	44.0243	43X54X11 DRD2	51490MCF000
600	CBR RR (PC37)	03/04	44.1080	45X57X11 DRD2	51490MCA003
600	CBR RR (PC37)	05/06	44.0314	41X54X11 DRD2	51490MEED01
600	CBR RR (PC40)	07/09	44.0314	41X54X11 DRD2	51490MEED01
600	CBR RR	13/14	44.0314	41X54X11 DRD2	51490MERR61
600	FJS Silver Wing/SW-T / ABS	03/13	44.1140	41x53x8/10,5 DRD2	51490MCT003
600	NTV	88/91	44.0314	41X54X11 DRD2	51490MM8305
600	VT C/CD/CD2 Shadow (PC21)	88/07	44.0347	39X51X8/10,5 DR2	51490MR1671
600	XL V Transalp (PD06/PD10)	87/99	44.0314	41X54X11 DRD2	51490KAE003
600	XL R	83	44.0241	39X52X11 DRD2	51490MB9782
600	XR R	85/00	44.0314	41X54X11 DRD2	51490KA4831
600	XR R	85/99	44.0314	41X54X11 DRD2	51490MN8305
650	CB (RC03)	79/82	44.0040	35X48X11 DRD2	91255KBH003
650	CB C Custom (RC05)	80/82	44.0040	35X48X11 DRD2	91255KBH003
650	CB SC Nighthawk (RC08)	82	44.0300	37X50X11 DRD2	51490GBFJ21
650	CB SC Nighthawk	83/85	44.0241	39X52X11 DRD2	51490MB9782
650	CX C Custom	83	44.0241	39X52X11 DRD2	51490MB9782
650	CX T (RC16)	83	44.0300	37X50X11 DRD2	51490KAZ003
650	FX Vigor (RD09)	99/00	44.0314	41X54X11 DRD2	51490MN8305
650	GL/Interstate (RC10)	83	44.0300	37X50X11 DRD2	51490KAZ003
650	NT Hawk GT (88/91)	88/91	44.0314	41X54X11 DRD2	51490MM8305
650	NT V Deauville (RC47)	98/05	44.0314	41X54X11 DRD2	51490MN8305

<i>Applicazioni c.c. marca/modello</i>	<i>anno</i>	<i>Cod. SGR</i>	<i>Misure/tipo</i>	<i>Riferimento originale</i>
650 NTV Revere (RC33)	88/97	44.0314	41X54X11 DRD2	51490MN8305
650 NX Dominator	92/02	44.0314	41X54X11 DRD2	51490KAE003
650 SLR	97/98	44.0314	41X54X11 DRD2	51490MN8305
650 XL V Transalp	01/07	44.0314	41X54X11 DRD2	51490KAE003
650 XR L	93/13	44.0314	41X54X11 DRD2	51490KA4831
650 XR R	00/07	44.1090	46x58x10,5/11 DR3	51490MBN671
650 XRV Africa Twin (RD03)	88/90	44.0314	41X54X11 DRD2	51490KA4831
700 CTX D/N/ABS	13/14	44.0314	41X54X11 DRD2	51490MERR61
700 NC D Integra	12/13	44.0314	41X54X11 DRD2	51490MERR61
700 NC S/DCT	08/10	44.0314	41X54X11 DRD2	51490MERR61
700 NC X/DCT	08/10	44.0314	41X54X11 DRD2	51490MERR61
700 NSA DN-01	08/10	44.0314	41X54X11 DRD2	51490MERR61
700 NT V Deauville	06/11	44.0314	41X54X11 DRD2	51490MERR61
700 XL V Transalp	08/11	44.0314	41X54X11 DRD2	51490MEED01
750 CB K Four	77/82	44.0040	35X48X11 DRD2	91255KBH003
750 CB F Four/Supersport	77/80	44.0040	35X48X11 DRD2	91255KBH003
750 CB	91/92	44.0314	41X54X11 DRD2	51490MN8305
750 CB F2 Seven Fifty (RC38)	92/03	44.0314	41X54X11 DRD2	51490MN8305
750 CB SC Nighthawk	82/83	44.0300	37X50X11 DRD2	51490GBFJ21
750 CB SC Nighthawk	91/92	44.0314	41X54X11 DRD2	51490MN8305
750 RVF R (RC45)	94/95	44.0314	41X54X11 DRD2	51490MN8305
750 VF C Magna V45 (RC09)	82/86	44.0300	37X50X11 DRD2	51490KAZ003
750 VF C SuperMagna/Shadow (RC28)	87/90	44.0241	39X52X11 DRD2	51490MB9782
750 VF C Shadow/Magna/CD/C2 (RC43)	93/02	44.0314	41X54X11 DRD2	51490MN8305
750 VF F V45 Interceptor (RC15)	83/85	44.0241	39X52X11 DRD2	51490MB9782
750 VF S Sabre (RC07)	82/83	44.0300	37X50X11 DRD2	51490KAZ003
750 VFR F (RC24)	86/87	44.0300	37X50X11 DRD2	51490ML7305
750 VFR F (RC24)	88/89	44.0314	41X54X11 DRD2	51490MM8305
750 VFR F (RC36)	90/97	44.0314	41X54X11 DRD2	51490MN8305
750 VT C Shadow (RC14)	83/85	44.0241	39X52X11 DRD2	51490MB9782
750 VT C Shadow (RC44)	97/03	44.1050	41X53X8/9,5 DR3	51490MBA003
750 VT C2 Shadow (RC44)	97/03	44.1050	41X53X8/9,5 DR3	51490MBA003
750 VT C/CA Shadow/ABS (RC50)	04/13	44.1140	41x53x8/10,5 DRD2	51490MCT003
750 VT CS Shadow (RC50)	10/13	44.1140	41x53x8/10,5 DRD2	51490MCT003
750 VT C2 Shadow Spirit (RC53)	07/09	44.1140	41x53x8/10,5 DRD2	51490MCT003
750 VT C2/C2F/C2S Shadow Spirit (RC53)	10/13	44.1140	41x53x8/10,5 DRD2	51490MCT003
750 VT C2B Shadow Phantom (RC53)	10/13	44.1140	41x53x8/10,5 DRD2	51490MCT003
750 VT C2B Shadow BlackSpirit (RC53)	10/13	44.1140	41x53x8/10,5 DRD2	51490MCT003
750 VT DC Black Widow (RC48)	01/03	44.0314	41X54X11 DRD2	51490MN8305
750 VT RS RC58	10/13	44.0314	41X54X11 DRD2	51490MERR61
750 VT S RC58	10/13	44.0314	41X54X11 DRD2	51490MERR61
750 XRV Africa Twin (RD04)	90/92	44.0314	41X54X11 DRD2	51490KA4831
750 XRV Africa Twin (RD07)	93/03	44.0314	41X54X11 DRD2	51490KA4831
800 PC Pacific Coast (RC34)	89/98	44.0314	41X54X11 DRD2	51490MN8305
800 VFR Fi (RC46)	98/01	44.0314	41X54X11 DRD2	51490MN8305
800 VFR V-Tech/ABS (RC46II)	02/07	44.0243	43X54X11 DRD2	51490MCF000
800 VFR V-Tech/ABS (RC46II)	08/11	44.0243	43X54X11 DRD2	51490MCWD01
900 CB C (SC04)	80/82	44.0300	37X50X11 DRD2	51490GBFJ21
900 CB F Bol d'or (SC09)	81/82	44.0241	39X52X11 DRD2	51490MB9782
900 CB F Hornet	04/07	44.0243	43X54X11 DRD2	51490MEJ003
900 CBR 900RR Fireblade (SC28)	92/95	44.1080	45X57X11 DRD2	51490MW0003
919 CBR 900RR Fireblade (SC33)	96/99	44.1080	45X57X11 DRD2	51490MW0003
929 CBR 900RR Fireblade (SC44)	00/01	44.0243	43X54X11 DRD2	51490MCF000
954 CBR 900RR Fireblade (SC50)	02/03	44.0243	43X54X11 DRD2	51490MCF000
1000 CB C Custom	83	44.0241	39X52X11 DRD2	91255463003
1000 CB F Big One (SC30)	93/96	44.0243	43X54X11 DRD2	51490MZ1305

<i>Applicazioni c.c. marca/modello</i>	<i>anno</i>	<i>Cod. SGR</i>	<i>Misure/tipo</i>	<i>Riferimento originale</i>
1000 CB R	08/13	44.0243	43X54X11 DRD2	51490MFL003
1000 CBF/S/T/ABS	06/09	44.0314	41X54X11 DRD2	51490MEED01
1000 CBF F ABS	10/12	44.0314	41X54X11 DRD2	51490MERR61
1000 CBR F/Hurricane (SC21)	87/92	44.0314	41X54X11 DRD2	51490MN8305
1000 CBR F /Dual CBS (SC21/SC24)	93/99	44.0314	41X54X11 DRD2	51490MN8305
1000 CBR RR Fireblade (SC57)	04/07	44.0243	43X54X11 DRD2	51490MEJ003
1000 CBR RR/RA Fireblade/C-ABS (SC59)	08/13	44.0243	43X54X11 DRD2	51490MFL003
1000 CBX Super Sport (CB1/SC03 - 6 cil.)	79/80	44.0040	35X48X11 DRD2	91255KBH003
1000 CBX Super Sport (SC06 - 6 cil.)	81/82	44.0241	39X52X11 DRD2	51490MB9782
1000 VF F/F2 Interceptor (SC15/SC19)	84/86	44.0314	41X54X11 DRD2	51490MN8305
1000 VF R (SC16)	85/86	44.0314	41X54X11 DRD2	51490MN8305
1000 VTR F Fire Storm (SC36)	97/05	44.0314	41X54X11 DRD2	51490MN8305
1000 VTR SP1/SP2 (SC45)	00/06	44.0243	43X54X11 DRD2	51490MCF000
1000 XLV Varadero (SD01/SD02)	99/02	44.0243	43X54X11 DRD2	51490MZ1305
1000 XLV Varadero (SD02)	03/06	44.0243	43X54X11 DRD2	51490MCF000/3
1000 XLV Varadero (SD02)	07/12	44.0243	43X54X11 DRD2	51490MEJ003
1000 XLV Varadero ABS (SD02)	04/12	44.0243	43X54X11 DRD2	51490MEJ003
1100 CB / CB A ABS (SC65)	12/13	44.0314	41X54X11 DRD2	51490MERR61
1100 CB SF X-11 (SC42)	00/01	44.0243	43X54X11 DRD2	51490MCF000
1100 CBR XX Superblackbird (SC35)	97/06	44.0243	43X54X11 DRD2	51490MZ1305
1100 GL GoldWing (SC02)	80/83	44.0241	39X52X11 DRD2	91255463003
1100 ST Pan European	90/02	44.0314	41X54X11 DRD2	51490MN8305
1100 ST Pan European ABS	90/95	44.0314	41X54X11 DRD2	51490MN8305
1100 ST Pan European ABS	96/02	44.0243	43X54X11 DRD2	51490MZ1305
1100 VF C V65 Magna (SC12)	83/86	44.0314	41X54X11 DRD2	51490MN8305
1100 VF S V65 Sabre (SC17)	84/85	44.0314	41X54X11 DRD2	51490MN8305
1100 VT C Shadow (SC18)	85/07	44.0314	41X54X11 DRD2	51490MN8305
1100 VT C2 Shadow (SC32)	95/01	44.0314	41X54X11 DRD2	51490MN8305
1100 VT C2 Shadow (SC32)	02/06	44.1140	41x53x8/10,5 DRD2	51490MCT003
1100 VT C3 Shadow Aero (SC39)	98/02	44.0314	41X54X11 DRD2	51490MN8305
1200 GL Gold Wing (SC14)	84/87	44.0314	41X54X11 DRD2	51490MN8305
1300 CB S/F	03/09	44.0243	43X54X11 DRD2	51490MEJ003
1300 ST Pan European (SC51)	02/08	44.1080	45X57X11 DRD2	51490MCA003
1300 VT C	10/13	44.0314	41X54X11 DRD2	51490MERR61
1300 VTX R/S/T (SC52)	03/09	44.0314	41X54X11 DRD2	51490MN8305
1300 VTX C (SC55)	04/09	44.0314	41X54X11 DRD2	51490MN8305
1500 GL/A/SE/I Gold Wing (SC22)	88/00	44.0314	41X54X11 DRD2	51490MN8305
1500 GL C Valkyrie F6C (SC34)	97/03	44.1080	45X57X11 DRD2	51490MW0003
1500 GL CF Valkyrie (SC41)	99/01	44.1080	45X57X11 DRD2	51490MW0003
1800 GL Gold Wing	01/05	44.1080	45X57X11 DRD2	51490MCA003
1800 GL Gold Wing	06/09	44.1080	45X57X11 DRD2	51490MCHC11
1800 VTX (SC46)	02/04	44.1080	45X57X11 DRD2	51490MCA003
1800 VTX (SC46)	05/08	44.1080	45X57X11 DRD2	51490MCHC11

HUSQVARNA

125 CR	92/93	44.1080	45X57X11 DRD2	800072085
125 WRK	92/93	44.1080	45X57X11 DRD2	800072085
250 CR	93	44.1080	45X57X11 DRD2	800072085
250 WRK	93	44.1080	45X57X11 DRD2	800072085
350 TE	92/94	44.1080	45X57X11 DRD2	800072085
350 WXE/WXC	93	44.1080	45X57X11 DRD2	800072085
360 WR/CR	92/95	44.1080	45X57X11 DRD2	800072085
610 TC	92/94	44.1080	45X57X11 DRD2	800072085
610 TE	92/94	44.1080	45X57X11 DRD2	800072085
610 TE E	92/94	44.1080	45X57X11 DRD2	800072085

<i>Applicazioni c.c. marca/modello</i>	<i>anno</i>	<i>Cod. SGR</i>	<i>Misure/tipo</i>	<i>Riferimento originale</i>
KAWASAKI				
65 KX	00/14	44.0027	33x46x11 DRD2	92049-1524
80 KX	98/00	44.0304	36X48X8/9,5 DR2	92049-1394
80 KX BigWheel	92/94	44.0304	36X48X8/9,5 DR2	92049-1394
85 KX	01/06	44.0304	36X48X8/9,5 DR2	92049-1394
100 KX	95/06	44.0304	36X48X8/9,5 DR2	92049-1394
125 KLX-C Enduro/CDS (CA/CD)	10/13	44.0027	33x46x11 DRD2	92049-1524
125 KX	78/79	44.0038	36X48X10,5 DR3	44009-024
125 KX	80/81	44.0266	38X50X10,5 DR3	92049-1042
125 KX	82	44.0301	38x50x8/10,5 DR2	92049-1178
125 KX	83/87	44.1070	43X55X10,5/12 DR3	92049-1295
125 KX	88	44.1060	43X55X9,5/10,5 DR3	92049-1456
125 KX	89	44.1090	46x58x10,5/11 DR3	92049-1341
125 KX	90	44.1050	41X53X8/9,5 DR3	92049-1338
125 KX	91/95	44.1060	43X55X9,5/10,5 DR3	92049-1373
125 KX	96/01	44.1100	46X58X9,5/11,5 DRD2	92049-1440/1504
125 KX	05	44.1170	48X58,1X8,5/10,5 DRD2	92049-0056
140 KLX/L	09/12	44.0027	33x46x11 DRD2	92049-1524
200 KDX	93/94	44.1140	41x53x8/10,5 DRD2	92049-1356
200 KZ	78/79	44.0253	32X43X12,5 DR3	44009-028
250 EL Eliminator	88/89	44.0350	36x48x11 DRD2	92049-1226
250 EL Eliminator	96/03	44.0350	36x48x11 DRD2	92049-1226
250 EX Ninja R	88/06	44.0350	36x48x11 DRD2	92049-1226
250 Ninja R (EX250 K8)	08	44.0300	37X50X11 DRD2	92049-1421
250 KDX	92/94	44.1060	43X55X9,5/10,5 DR3	92049-1373
250 KH	76	44.0039	34x46x10,5 DR3	44009-026
250 KLR (KL250 D)	78/84	44.0038	36X48X10,5 DR3	44009-024
250 KLR (KL250 D)	85/05	44.0038	36X48X10,5 DR3	92049-1216
250 KLX (A)	79/80	44.0038	36X48X10,5 DR3	44009-024
250 KLX (KLX250 E)	94/96	44.1060	43X55X9,5/10,5 DR3	92049-1456
250 KLX R	94/96	44.1060	43X55X9,5/10,5 DR3	92049-1373
250 KLX S	06/07	44.1060	43X55X9,5/10,5 DR3	92049-1373
250 KLX S/SF	09	44.1060	43X55X9,5/10,5 DR3	92049-1373
250 KX	74/80	44.0038	36X48X10,5 DR3	44009-024
250 KX	82	44.0301	38x50x8/10,5 DR2	92049-1178
250 KX	87	44.1070	43X55X10,5/12 DR3	92049-1295
250 KX	88	44.1060	43X55X9,5/10,5 DR3	92049-1456
250 KX	89	44.1090	46x58x10,5/11 DR3	92049-1341
250 KX	90	44.1050	41X53X8/9,5 DR3	92049-1338
250 KX	91/95	44.1060	43X55X9,5/10,5 DR3	92049-1373
250 KX	96/01	44.1100	46X58X9,5/11,5 DRD2	92049-1440/1504
250 KX/KX-F	05	44.1170	48X58,1X8,5/10,5 DRD2	92049-0056
250 KZ / CSR	81	44.0253	32X43X12,5 DR3	44009-028
250 KZ LTD	80	44.0253	32X43X12,5 DR3	44009-028
250 ZZR	96/02	44.0308	37x49x8/10 DRD2	92049-1435
300 KLX R (LX300 A)	97/07	44.1060	43X55X9,5/10,5 DR3	92049-1373
400 KLX R/SR	03/05	44.1120	49x60x10 DR3	51153-36E00
400 KX	75/76	44.0038	36X48X10,5 DR3	92049-1216
400 ZXR	90	44.1140	41x53x8/10,5 DRD2	92049-1356
400 ZXR	91/99	44.0314	41X54X11 DRD2	92049-1363
400 ZZR (ZX400)	06	44.0314	41X54X11 DRD2	92049-1363
440 Z	82/84	44.0027	33x46x11 DRD2	92049-1524
450 EN 454 LTD (EN450 A1)	85/90	44.0350	36x48x11 DRD2	92049-1226
450 KLX-R	08/14	44.1170	48X58,1X8,5/10,5 DRD2	92049-0056
500 EN Vulcan (EN500)	90/93	44.0350	36x48x11 DRD2	92049-1226

<i>Applicazioni</i>	<i>anno</i>	<i>Cod. SGR</i>	<i>Misure/tipo</i>	<i>Riferimento originale</i>
<i>c.c. marca/modello</i>				
500 EN Vulcan (EN500)	94/95	44.0300	37X50X11 DRD2	92049-1421
500 EN Vulcan (EN500)	96/02	44.1140	41x53x8/10,5 DRD2	92049-1356
500 EN Vulcan (EN500)	03/05	44.1140	41x53x8/10,5 DRD2	92049-1494
500 ER 5 (ER500)	97/05	44.0300	37X50X11 DRD2	92049-1421
500 GPZ S (EX500 A/D)	87/93	44.0350	36x48x11 DRD2	92049-1226
500 GPZ S (EX500 A/D)	94/06	44.0300	37X50X11 DRD2	92049-1421
500 H1 / Mach III	69/75	44.0038	36X48X10,5 DR3	92049-1216
500 H2 / Mach IV	72/75	44.0038	36X48X10,5 DR3	92049-1216
500 KH (A8)	76	44.0038	36X48X10,5 DR3	92049-1216
500 KLE	05/07	44.1140	41x53x8/10,5 DRD2	92049-1356
500 KX	90	44.1050	41X53X8/9,5 DR3	92049-1338
500 KX	91/96	44.1060	43X55X9,5/10,5 DR3	92049-1373
500 KX	97/04	44.1100	46X58X9,5/11,5 DRD2	92049-1504
550 KZ LTD/Shaft/Spectre	83/84	44.0304	36X48X8/9,5 DR2	92049-1394
600 ZL Eliminator	86/87	44.0308	37x49x8/10 DRD2	92049-1435
600 ZL Eliminator	95/97	44.0308	37x49x8/10 DRD2	92049-1435
600 GPZ R (ZX600 A1/A4)	85/88	44.0308	37x49x8/10 DRD2	92049-1435
600 GPZ RX (ZX600RX Ninja B1)	87	44.0308	37x49x8/10 DRD2	92049-1435
600 GPX R (ZX600R Ninja C1/C6)	88/93	44.0301	38x50x8/10,5 DR2	92049-1178
600 GPX R (ZX600R Ninja C7/C10)	94/97	44.1030	38X50X8/9,5 DR2	92049-1418
600 ZZR Ninja (ZX600 D/F)	90/06	44.0314	41X54X11 DRD2	92049-1363
600 ZX-6R Ninja (ZX600 F1/F3)	95/97	44.1140	41x53x8/10,5 DRD2	92049-1356
600 ZX-6R Ninja (ZX600 J1/J3)	00/02	44.1160	46x58x10,5 DRD2	92049-1508
600 ZX-6R Ninja (ZX600 P7/P8)	07/08	44.0314	41X54X11 DRD2	92049-0058
600 ZX-6R Ninja (ZX600 R9/RD)	09/13	44.0314	41X54X11 DRD2	92049-0125
600 ZX-6RR Ninja (ZX600 K1/M1)	03/04	44.1140	41x53x8/10,5 DRD2	92049-0001
600 ZX-6RR Ninja (ZX600 N1/N6)	05/06	44.0314	41X54X11 DRD2	92049-0058
636 ZX-6R Ninja (ZX636 A1)	02	44.1160	46x58x10,5 DRD2	92049-1508
636 ZX-6R Ninja (ZX636 B1/B2)	03/04	44.1140	41x53x8/10,5 DRD2	92049-0001
636 ZX-6R Ninja (ZX636 C1/C6)	05/06	44.0314	41X54X11 DRD2	92049-0058
636 ZX-6R Ninja / ABS (ZX636 E/F)	13/14	44.0314	41X54X11 DRD2	92049-0125
650 ER 6-F / ABS (EX650)	06/14	44.1140	41x53x8/10,5 DRD2	92049-0073
650 ER 6-N / ABS (ER650)	06/14	44.1140	41x53x8/10,5 DRD2	92049-0073
650 KLE Versys	07/13	44.0314	41X54X11 DRD2	92049-0058
650 KLR (KL650 E8/E9)	08/09	44.1140	41x53x8/10,5 DRD2	92049-1356
650 KLX (LX650 C1/C4)	93/96	44.1060	43X55X9,5/10,5 DR3	92049-1373
650 KLX R (LX650 A1/A3)	93/95	44.1060	43X55X9,5/10,5 DR3	92049-1373
650 KLX R (LX650 D)	96/01	44.1060	43X55X9,5/10,5 DR3	92049-1373
650 KLX R (KLX650 C)	93/96	44.1060	43X55X9,5/10,5 DR3	92049-1456
650 Z/KZ CSR	81/83	44.0304	36X48X8/9,5 DR2	92049-1394
650 Z/KZ/Custom	78/80	44.0038	36X48X10,5 DR3	44009-024
650 Z/KZ SR (D1/D2)	78/79	44.0038	36X48X10,5 DR3	92049-1216
650 Z/KZ LTD (E1)	80	44.0038	36X48X10,5 DR3	92049-1216
650 Z/KZ (KZ B1/B3)	77/79	44.0038	36X48X10,5 DR3	92049-1216
650 Z/KZ (F1)	80	44.0038	36X48X10,5 DR3	92049-1216
700 VN Vulcan	85	44.1020	38X52X11 DRD2	92049-1230
700 ZN LTD (Shaft) (ZN)	85	44.0304	36X48X8/9,5 DR2	92049-1394
750 GPZ (KZ750 R)	82	44.0304	36X48X8/9,5 DR2	92049-1101
750 GPZ Unitrack/Turbo (ZX750 A/E)	83/85	44.0308	37x49x8/10 DRD2	92049-1435
750 GPX R (ZX 750 Ninja R F1/F4)	87/90	44.0301	38x50x8/10,5 DR2	92049-1178
750 Z/KZ (KZ B1/B4)	76/79	44.0038	36X48X10,5 DR3	92049-1216
750 KZ CSR Twin (KZ750 M)	82	44.0304	36X48X8/9,5 DR2	92049-1101
750 KZ LTD-2 Twin (KZ750 G)	80	44.0038	36X48X10,5 DR3	44009-024
750 KZ LTD-4 (KZ750 H)	80/83	44.0304	36X48X8/9,5 DR2	92049-1101
750 KZ LTD Belt (KZ750 K)	83	44.0304	36X48X8/9,5 DR2	92049-1101
750 KZ Shaft (KZ750 F)	83	44.0350	36x48x11 DRD2	92049-1063

<i>Applicazioni</i>	<i>anno</i>	<i>Cod. SGR</i>	<i>Misure/tipo</i>	<i>Riferimento originale</i>
<i>c.c. marca/modello</i>				
750 KZ Spectre (KZ750 N)	82/83	44.0350	36x48x11 DRD2	92049-1063
750 KZ Sport (KZ750 L)	83	44.0304	36X48X8/9,5 DR2	92049-1101
750 KZ Standard (KZ750 E)	80/82	44.0304	36X48X8/9,5 DR2	92049-1101
750 VN Vulcan A2,A13 (VN750 A)	86/06	44.1020	38X52X11 DRD2	92049-1230
750 Z (ZR750 J1/J2)	04/05	44.1140	41x53x8/10,5 DRD2	92049-1494
750 Z (ZR750 J6/L/M)	06/12	44.1140	41x53x8/10,5 DRD2	92049-0073
750 Z S (ZR750 K1/K6)	05/06	44.1140	41x53x8/10,5 DRD2	92049-1494
750 ZR ABS	11/12	44.0314	41X54X11 DRD2	92049-0164
750 ZR Zephyr (ZR750 C1/C4)	91/94	44.1140	41x53x8/10,5 DRD2	92049-1356
750 ZR-7 (ZR750 F1/F5)	99/03	44.1140	41x53x8/10,5 DRD2	92049-1494
750 ZR-7S (ZR750 H1/H3)	01/03	44.1140	41x53x8/10,5 DRD2	92049-1494
750 ZX-7R Ninja (ZX750 P1/P7)	96/02	44.1060	43X55X9,5/10,5 DR3	92049-1456
750 ZX-7RR Ninja (ZX750 N1)	96/98	44.1060	43X55X9,5/10,5 DR3	92049-1456
750 ZXR (ZX750 H)	89/90	44.1060	43X55X9,5/10,5 DR3	92049-1342
750 ZXR (ZX750 L)	93/95	44.1140	41x53x8/10,5 DRD2	92049-1356
750 ZXR R (ZX750 K)	91/95	44.1140	41x53x8/10,5 DRD2	92049-1356
800 VN Vulcan/Classic (VN800 A)	95/06	44.0314	41X54X11 DRD2	92049-1363
800 VN Vulcan Drifter (VN800 C)	99/06	44.0314	41X54X11 DRD2	92049-1363
800 Z / Z ABS (ZR800 A/B)	12/13	44.1140	41x53x8/10,5 DRD2	92049-0073
800 Z-E / Z-E ABS (ZR800 C/D)	12/13	44.1140	41x53x8/10,5 DRD2	92049-0073
900 GPZ R Ninja (ZX900 A1/A3)	84/86	44.0301	38x50x8/10,5 DR2	92049-1178
900 VN Vulcan Classic/Custom	06/13	44.0314	41X54X11 DRD2	92049-0058
900 Z1 (Z1 / A / B)	73/75	44.0038	36X48X10,5 DR3	92049-1216
900 Z/KZ (A4/A5)	76/77	44.0038	36X48X10,5 DR3	92049-1216
900 Z/KZ LTD (B1)	76/77	44.0038	36X48X10,5 DR3	44009-024
900 ZL Eliminator (ZL A)	85/86	44.1020	38X52X11 DRD2	92049-1230
900 ZX-9R Ninja	94/97	44.1140	41x53x8/10,5 DRD2	92049-1356
900 ZX-9R Ninja	99/03	44.1160	46x58x10,5 DRD2	92049-1508
1000 GPZ RX (ZX1000 A1/A3)	86/88	44.0303	40X52X8/9,5 DR2	92049-1251
1000 GTR Concours (ZG A)	86/98	44.1140	41x53x8/10,5 DRD2	92049-1356
1000 GTR Concours (ZG A)	99/06	44.1140	41x53x8/10,5 DRD2	92049-1494
1000 KLZ Versys	12/14	44.1150	43x55x9,5/10,5 DRD2	92049-1522
1000 Z/KZ (A1/A4)	77/80	44.0038	36X48X10,5 DR3	44009-024
1000 Z/KZ Z1R (D1/D3)	78/80	44.0038	36X48X10,5 DR3	44009-024
1000 Z/KZ CSR (KZ1000 M)	81/82	44.0303	40X52X8/9,5 DR2	92049-1251
1000 Z/KZ LTD (KZ B1/B4)	77/80	44.0038	36X48X10,5 DR3	92049-1216
1000 Z/KZ LTD (KZ1000 K)	81/82	44.0301	38x50x8/10,5 DR2	92049-1102
1000 Z/KZ Classic (G1)	80	44.0038	36X48X10,5 DR3	92049-1216
1000 Z/KZ E Shaft	79/80	44.0303	40X52X8/9,5 DR2	92049-1251
1000 Z/KZ E Shaft	81/82	44.0301	38x50x8/10,5 DR2	92049-1178
1000 Z/KZ Police (KZ P)	94/00	44.0301	38x50x8/10,5 DR2	92049-1178
1000 Z/KZ CSR/LTD/ST (KZ M/K/J)	81/82	44.0301	38x50x8/10,5 DR2	92049-1178
1000 Z (ZR1000 A1/A6)	03/06	44.0314	41X54X11 DRD2	92049-1363
1000 Z (ZR1000 B/C)	07/09	44.0314	41X54X11 DRD2	92049-0058
1000 Z / ABS (ZR1000 D/E)	10/12	44.0314	41X54X11 DRD2	92049-0125
1000 Z SX / ABS (ZR1000H/G)	11/13	44.0314	41X54X11 DRD2	92049-0125
1000 ZX-10 Tomcat Ninja (ZX1000 B1/B3)	88/90	44.1140	41x53x8/10,5 DRD2	92049-1356
1000 ZX-10R Ninja (ZX1000 C)	04/05	44.1150	43x55x9,5/10,5 DRD2	92049-1522
1000 ZX-10R Ninja (ZX1000 D/E)	06/10	44.1150	43x55x9,5/10,5 DRD2	92049-0072
1000 ZX-10R Ninja (ZX1000 J)	11/14	44.0243	43X54X11 DRD2	92049-0064
1100 GPZ (ZX A1/A2)	83/84	44.0308	37x49x8/10 DRD2	92049-1435
1100 GPZ (ZX E1/E2)	95/97	44.1140	41x53x8/10,5 DRD2	92049-1356
1100 ZN LTD Shaft (ZN B1/B2)	84/85	44.0301	38x50x8/10,5 DR2	92049-1178
1200 ZG Voyager XIII	01/03	44.0314	41X54X11 DRD2	92049-1363
1200 ZRX (ZR1200 C1/C3)	01/04	44.1150	43x55x9,5/10,5 DRD2	92049-1496
1200 ZRX R (ZR1200 A1/A6)	01/06	44.1150	43x55x9,5/10,5 DRD2	92049-1496

Applicazioni c.c. <i>marca/modello</i>	<i>anno</i>	<i>Cod. SGR</i>	<i>Misure/tipo</i>	<i>Riferimento originale</i>
1200 ZRX S (ZR1200 B1/B4)	01/04	44.1150	43x55x9,5/10,5 DRD2	92049-1496
1200 ZX-12R Ninja (ZX1200 A1/A2/B1/B6)	00/06	44.1150	43x55x9,5/10,5 DRD2	92049-1522
1200 ZZR (ZX1200 C1/C2)	02/05	44.1150	43x55x9,5/10,5 DRD2	92049-1496
1300 Z (KZ A1/A3/B2)	79/82	44.1140	41x53x8/10,5 DRD2	92049-1356
1400 GTR Concours (ZG1400)	08/14	44.1150	43x55x9,5/10,5 DRD2	92049-1522
1400 ZX-14 (ZX1400 Ninja)	06/14	44.1150	43x55x9,5/10,5 DRD2	92049-1522
1400 ZZR	06/14	44.1150	43x55x9,5/10,5 DRD2	92049-1522
1500 VN Vulcan/L/Classic/FI/Tourer	96/03	44.0314	41X54X11 DRD2	92049-1363
1500 VN Vulcan Drifter	99/00	44.0314	41X54X11 DRD2	92049-1363
1500 VN Vulcan Mean Streak	02/03	44.0243	43X54X11 DRD2	92049-1590
1500 VN Vulcan Nomad FI	00/04	44.0314	41X54X11 DRD2	92049-1363
1600 VN Vulcan Classic	03/08	44.1150	43x55x9,5/10,5 DRD2	92049-1496
1600 VN Vulcan Mean Streak	04/05	44.0243	43X54X11 DRD2	92049-1590
1600 VN Vulcan Mean Streak	06/08	44.0243	43X54X11 DRD2	92049-0064
1600 VN Vulcan Nomad FI	06/08	44.1150	43x55x9,5/10,5 DRD2	92049-1496
2000 VN Vulcan Cruiser	04/06	44.1120	49x60x10 DR3	51153-36E00
2000 VN Vulcan/Classic/LT	04/09	44.1120	49x60x10 DR3	92049-0044

KYMC0

50 Agility R16 2T	09/12	44.0027	33x46x11 DRD2	00192044
50 Agility R16 4T	08/12	44.0027	33x46x11 DRD2	00192044
50 Bet & Win/Euro 2	00/07	44.0027	33x46x11 DRD2	00192044
50 Dink Classic Euro 2 2T	03/07	44.0027	33x46x11 DRD2	00192044
50 Dink 4T	07/12	44.0027	33x46x11 DRD2	00192044
50 People S 2T	05/13	44.0027	33x46x11 DRD2	00192044
50 People S 4T	06/13	44.0027	33x46x11 DRD2	00192044
50 Super 8 4T	09/13	44.0027	33x46x11 DRD2	00192044
50 Super 8 2T	09/13	44.0027	33x46x11 DRD2	00192044
125 Bet & Win/Euro 2	00/07	44.0027	33x46x11 DRD2	00192044
125 Agility R16	08/12	44.0027	33x46x11 DRD2	00192044
125 Dink Classic/Euro 2	02/07	44.0027	33x46x11 DRD2	00192044
125 Dink Euro 3	06/10	44.0027	33x46x11 DRD2	00192044
125 Gran Dink/Euro 2	01/07	44.0027	33x46x11 DRD2	00192044
125 Movie XL	03/>	44.0027	33x46x11 DRD2	00192044
125 Movie Euro 3	06/>	44.0027	33x46x11 DRD2	00192044
125 People S/DD Euro 3	05/13	44.0027	33x46x11 DRD2	00192044
125 Quannon	08/10	44.0027	33x46x11 DRD2	00192044
125 Super 8	08/13	44.0027	33x46x11 DRD2	00192044
125 Zing	97/98	44.0027	33x46x11 DRD2	00192044
150 Bet & Win/Euro 2	00/07	44.0027	33x46x11 DRD2	00192044
150 Agility R16	08/12	44.0027	33x46x11 DRD2	00192044
150 Dink Classic/Euro 2	02/07	44.0027	33x46x11 DRD2	00192044
150 Gran Dink/Euro 2	01/09	44.0027	33x46x11 DRD2	00192044
150 Movie XL	03/>	44.0027	33x46x11 DRD2	00192044
150 Movie Euro 3	06/>	44.0027	33x46x11 DRD2	00192044
150 Super 8	08/13	44.0027	33x46x11 DRD2	00192044
150 Zing	97/98	44.0027	33x46x11 DRD2	00192044
200 Agility R16 IE	10/13	44.0027	33x46x11 DRD2	00192044
200 Dink Classic/Euro 2	04/07	44.0027	33x46x11 DRD2	00192044
200 Dink IE Euro 3	06/13	44.0027	33x46x11 DRD2	00192044
200 People S/IE	05/13	44.0027	33x46x11 DRD2	00192044
250 Gran Dink/Euro 2	01/>	44.0027	33x46x11 DRD2	00192044
250 Bet & Win	00/>	44.0027	33x46x11 DRD2	00192044

<i>Applicazioni c.c. marca/modello</i>	<i>anno</i>	<i>Cod. SGR</i>	<i>Misure/tipo</i>	<i>Riferimento originale</i>
MALAGUTI				
125 Madison	99/04	44.0350	36 x 48 x 11 DRD2	12037000
150 Madison	99/04	44.0350	36 x 48 x 11 DRD2	12037000
180 Madison R	01/02	44.0350	36 x 48 x 11 DRD2	12037000
200 Madison/Rst Euro 2	02/03	44.0350	36 x 48 x 11 DRD2	12037000
250 Madison S	99/03	44.0350	36 x 48 x 11 DRD2	12037000
250 Madison RS (04/05)	04/05	44.0350	36 x 48 x 11 DRD2	12037000
400 Madison K/Rst	02/06	44.0350	36 x 48 x 11 DRD2	12037000
MOTO MORINI				
350 Excalibur/RLX	86/92	44.0811 ○	38X52X10,5	421512
350 New York	88/91	44.0811 ○	38X52X10,5	421512
500 501 Excalibur/RLX	86/92	44.0811 ○	38X52X10,5	421512
500 501 New York	88/91	44.0811 ○	38X52X10,5	421512
MOTO GUZZI				
350 Nevada	92/97	44.0266	38X50X10,5 DR3	GU90403857
350 Nevada Club	98/99	44.0266	38X50X10,5 DR3	GU90403857
500 V 50 PA	92/01	44.0266	38X50X10,5 DR3	GU90403857
650 65 GT	88/89	44.0266	38X50X10,5 DR3	GU90403857
650 V 65 Florida	85/92	44.0266	38X50X10,5 DR3	GU90403857
650 V 65 Polizia/PA	88/95	44.0266	38X50X10,5 DR3	GU90403857
750 Nevada	91/97	44.0266	38X50X10,5 DR3	GU90403857
750 Nevada Club	98/01	44.0266	38X50X10,5 DR3	GU90403857
750 Targa	90/92	44.0266	38X50X10,5 DR3	GU90403857
750 SP	90/92	44.0266	38X50X10,5 DR3	GU90403857
750 Strada	93/95	44.0266	38X50X10,5 DR3	GU90403857
750 V 75 PA	92/01	44.0266	38X50X10,5 DR3	GU90403857
850 T5 Civile III serie	84/88	44.0266	38X50X10,5 DR3	GU90403857
850 T5 Polizia/Carab./PA	88/95	44.0304	36X48X8/9,5 DR2	GU90403952
1000 SP II	83/88	44.0266	38X50X10,5 DR3	GU90403857
1000 SP III	89/94	44.0304	36X48X8/9,5 DR2	GU90403952
PEUGEOT				
50 Jet Force Kompressor	03/04	44.0350	36 x 48 x 11 DRD2	
50 XPS T	03/>	44.0350	36 x 48 x 11 DRD2	
50 XPS SM	03/>	44.0350	36 x 48 x 11 DRD2	
50 XR6 E	03/>	44.0040	35X48X11 DRD2	754501
125 Jet Force Kompressor	03/>	44.0350	36 x 48 x 11 DRD2	
125 Elyseo	01/>	44.0350	36 x 48 x 11 DRD2	
125 Elystar	02/>	44.0350	36 x 48 x 11 DRD2	754733
150 Elyseo	01/>	44.0350	36 x 48 x 11 DRD2	
150 Elystar	02/>	44.0350	36 x 48 x 11 DRD2	
PIAGGIO				
400 Beverly Euro 3	06/08	44.1140	41x53x8/10,5 DRD2	599267
400 Beverly Tourer Euro 3	08/10	44.1140	41x53x8/10,5 DRD2	599267
500 Beverly/Euro 3	02/10	44.1140	41x53x8/10,5 DRD2	599267
500 Beverly Cruiser	07/12	44.1140	41x53x8/10,5 DRD2	599267

Applicazioni c.c. marca/modello		anno	Cod. SGR	Misure/tipo	Riferimento originale
SUZUKI					
65	RM	03/05	44.0027	33x46x11 DRD2	51153-02B00
80	RM	86/88	44.0027	33x46x11 DRD2	51153-02B00
80	RM	89/01	44.0040	35X48X11 DRD2	51153-19D10
85	RM/L	02/09	44.0300	37X50X11 DRD2	51153-03B30
125	DR S (SF42A)	82/84	44.0253	32X43X12,5 DR3	51153-16730
125	DR	86/87	44.0040	35X48X11 DRD2	51153-19D10
125	DR SE	94/95	44.0040	35X48X11 DRD2	51153-19D10
125	GZ Marauder	98/10	44.0300	37X50X11 DRD2	51153-03B30/25D00
125	RG F	92/94	44.0241	39X52X11 DRD2	51153-19D00
125	RM	01/06	44.1110	47X58X10 DR3	51153-37F80
125	RM	79/83	44.0266	38X50X10,5 DR3	51153-40300
125	RM	84/87	44.1070	43X55X10,5/12 DR3	51153-01B20
125	RM	88	44.1060	43X55X9,5/10,5 DR3	51153-46E20
125	RM	89	44.1090	46x58x10,5/11 DR3	51153-27C00
125	RM	90	44.1040	41X53X8/9,5 DR2	51153-27C20
125	RM	91/95	44.1080	45X57X11 DRD2	51153-43D00
125	RM	96/00	44.1120	49x60x10 DR3	51153-36E00
125	RM	01/08	44.1110	47X58X10 DR3	51153-37F80
125	SP	82/83	44.0253	32X43X12,5 DR3	51153-16730
125	SP	86/88	44.0040	35X48X11 DRD2	51153-19D10
125	TS R	89/94	44.0314	41X54X11 DRD2	51153-08D00
125	VL Intruder	00/07	44.0308	37x49x8/10 DRD2	51153-26F00
200	DR	86/87	44.0040	35X48X11 DRD2	51153-19D10
200	DR SE	96/09	44.0040	35X48X11 DRD2	51153-19D10
200	SP	86/88	44.0040	35X48X11 DRD2	51153-19D10
250	AN Burgman (W/K6)	98/06	44.1140	41x53x8/10,5 DRD2	51153-14F00
250	DR	85	44.0038	36X48X10,5 DR3	51153-41211
250	DR	82/83	44.0038	36X48X10,5 DR3	51153-41211
250	DR S	90/95	44.0243	43X54X11 DRD2	51153-14D00
250	DR-Z	01/05	44.0243	43X54X11 DRD2	51153-14D00
250	GN	82/96	44.0027	33x46x11 DRD2	51153-02B00
250	GZ Marauder	99/10	44.0300	37X50X11 DRD2	51153-03B30/25D00
250	GW Inazuma	13	44.0308	37x49x8/10 DRD2	51153-26F00
250	RG	83	44.0304	36X48X8/9,5 DR2	51153-16730
250	RGV Gamma	89/96	44.0314	41X54X11 DRD2	51153-08D00
250	RM	79/82	44.0266	38X50X10,5 DR3	51153-40300
250	RM	83/87	44.1070	43X55X10,5/12 DR3	51153-01B20
250	RM	88	44.1060	43X55X9,5/10,5 DR3	51153-46E20
250	RM	89/90	44.1050	41X53X8/9,5 DR3	51153-28C00
250	RM	91/95	44.1080	45X57X11 DRD2	51153-28E30
250	RM	96/00	44.1120	49x60x10 DR3	51153-36E00
250	RM	01/03	44.1100	46X58X9,5/11,5 DRD2	51153-37F00
250	RM	04/08	44.1110	47X58X10 DR3	51153-37F80
250	RM-Z	07/09	44.1110	47X58X10 DR3	51153-37F80
250	ST/X	06	44.0300	37X50X11 DRD2	51153-03B30
250	TU G/GB	06	44.0300	37X50X11 DRD2	51153-03B30
250	TU X	97/01	44.0300	37X50X11 DRD2	51153-03B30
250	VL Intruder	00/07	44.0308	37x49x8/10 DRD2	51153-26F00
350	DR S/SE	90/98	44.0243	43X54X11 DRD2	51153-14D00
400	AN Burgman (X/K6)	98/06	44.1140	41x53x8/10,5 DRD2	51153-14F00
400	AN Burgman (K7/K9)	06/09	44.1140	41x53x8/10,5 DRD2	51153-10G50
400	AN Burgman (L0/L3)	10/13	44.1140	41x53x8/10,5 DRD2	51153-10G50
400	DR	80/81	44.0038	36X48X10,5 DR3	51153-41211
400	DR-Z	00/03	44.1120	49x60x10 DR3	51153-36E00

<i>Applicazioni c.c. marca/modello</i>	<i>anno</i>	<i>Cod. SGR</i>	<i>Misure/tipo</i>	<i>Riferimento originale</i>
400 DR-Z E	05/07	44.1120	49x60x10 DR3	51153-36E00
400 DR-Z S	05/09	44.1120	49x60x10 DR3	51153-36E00
400 DR-Z SM	05/09	44.1110	47X58X10 DR3	51153-37F80
400 GSF Bandit	91/93	44.1040	41X53X8/9,5 DR2	51153-27C20
450 GS E/ET/EX/EZ	80/83	44.0027	33x46x11 DRD2	51153-02B00
450 GS GA	82/85	44.0027	33x46x11 DRD2	51153-02B00
450 GS T/TX	81/82	44.0027	33x46x11 DRD2	51153-02B00
450 GS ST/SX	80/82	44.0027	33x46x11 DRD2	51153-02B00
450 GS L	80/82	44.0027	33x46x11 DRD2	51153-02B00
450 GS L	83/88	44.0040	35X48X11 DRD2	51153-19D10
450 RM-Z 4T	05/09	44.1110	47X58X10 DR3	51153-37F80
465 RM	81/82	44.0351	43X55X10,5 DR3	51153-14300
500 DR	81/82	44.0038	36X48X10,5 DR3	51153-41211
500 GS E (Bicil.)	89/00	44.0308	37x49x8/10 DRD2	51153-08C20
500 GS	01/06	44.0308	37x49x8/10 DRD2	51153-26F00
500 RM	84	44.0351	43X55X10,5 DR3	51153-14300
550 GS T	81	44.0040	35X48X11 DRD2	51153-19D10
550 GS M	82	44.0040	35X48X11 DRD2	51153-19D10
550 GS E	77/79	44.0040	35X48X11 DRD2	51153-19D10
550 GS E/ES/EF	83/85	44.0308	37x49x8/10 DRD2	51153-08C20
550 GS L	85/86	44.0040	35X48X11 DRD2	51153-19D10
550 GSX-E/ES/EF/EG	85/87	44.0308	37x49x8/10 DRD2	51153-08C20
550 GT	73/77	44.0040	35X48X11 DRD2	51153-19D10
600 GSF Bandit/S	95/99	44.1040	41X53X8/9,5 DR2	51153-27C20
600 GSF Bandit/S	00/04	44.1140	41x53x8/10,5 DRD2	51153-14F00
600 GSR	06/10	44.1150	43x55x9,5/10,5 DRD2	51153-44G00
600 GSX-E (ESH)	87	44.0308	37x49x8/10 DRD2	51153-08C20
600 GSX-F	88/06	44.0314	41X54X11 DRD2	51153-08D00
600 GSX-R	97/03	44.1080	45X57X11 DRD2	51153-43D00
600 GSX-R	06/07	44.0314	41X54X11 DRD2	51153-01H00
600 GSX-R	08/13	44.0314	41X54X11 DRD2	51153-01H10
600 RF R	94/96	44.0314	41X54X11 DRD2	51153-08D00
600 VS GL Intruder	95/97	44.0241	39X52X11 DRD2	51153-19D00
650 AN Burgman	03/13	44.1140	41x53x8/10,5 DRD2	51153-10G50
650 DR R	90/93	44.0302	41X53X8/10,5 DR2	51153-44B00
650 DR RS	90/91	44.0302	41X53X8/10,5 DR2	51153-44B00
650 DR RSE	91/93	44.0302	41X53X8/10,5 DR2	51153-44B00
650 DR RE	94/95	44.0302	41X53X8/10,5 DR2	51153-44B00
650 DR SM	90/91	44.0302	41X53X8/10,5 DR2	51153-44B00
650 DR S	93	44.0302	41X53X8/10,5 DR2	51153-44B00
650 DR S ES	92/95	44.0302	41X53X8/10,5 DR2	51153-44B00
650 DR SE	96/09	44.1070	43X55X10,5/12 DR3	51153-14330
650 GR	83	44.0040	35X48X11 DRD2	51153-19D10
650 GS E	81/82	44.0040	35X48X11 DRD2	51153-19D10
650 GS G	81/83	44.0040	35X48X11 DRD2	51153-19D10
650 GS GL	81/83	44.0040	35X48X11 DRD2	51153-19D10
650 GSF Bandit/S	05/06	44.1140	41x53x8/10,5 DRD2	51153-14F00
650 GSF Bandit/S	07/08	44.1140	41x53x8/10,5 DRD2	51153-10G50
650 GSX-F	08/12	44.1140	41x53x8/10,5 DRD2	51153-10G50
650 LS P Savage	86/97	44.0301	38x50x8/10,5 DR2	51153-20A00
650 SFV Gladius	09/13	44.0314	41X54X11 DRD2	51153-01H10
650 SV/S	99/02	44.1140	41x53x8/10,5 DRD2	51153-14F00
650 SV/S	03/06	44.0314	41X54X11 DRD2	51153-08D00
650 SV/S	07/10	44.0314	41X54X11 DRD2	51153-08D00
650 SV/S ABS	07/10	44.0314	41X54X11 DRD2	51153-01H00
650 XN85 Turbo	83	44.0300	37X50X11 DRD2	51153-03B30

<i>Applicazioni c.c. marca/modello</i>	<i>anno</i>	<i>Cod. SGR</i>	<i>Misure/tipo</i>	<i>Riferimento originale</i>
700 GS E	85	44.0300	37X50X11 DRD2	51153-03B30
700 VS GLF/GLEF Intruder	86/87	44.0300	37X50X11 DRD2	51153-03B30
750 DR S Big	88/89	44.0302	41X53X8/10,5 DR2	51153-44B00
750 GS B/C/N/EC/EN	77/79	44.0040	35X48X11 DRD2	51153-19D10
750 GS E	80/82	44.0040	35X48X11 DRD2	51153-19D10
750 GS T	82/83	44.0040	35X48X11 DRD2	51153-19D10
750 GSR	11/13	44.1140	41x53x8/10,5 DRD2	51153-10G50
750 GSX	98/01	44.0243	43X54X11 DRD2	51153-14D00
750 GSX-F	89/06	44.0314	41X54X11 DRD2	51153-08D00
750 GSX-R	85/87	44.1040	41X53X8/9,5 DR2	51153-27C20
750 GSX-R	88/89	44.0243	43X54X11 DRD2	51153-14D00
750 GSX-R	90/93	44.0314	41X54X11 DRD2	51153-08D00
750 GSX-R SP	94	44.0243	43X54X11 DRD2	51153-14D00
750 GSX-R	94/03	44.0243	43X54X11 DRD2	51153-14D00
750 GSX-R	06/07	44.0314	41X54X11 DRD2	51153-01H00
750 GSX-R	08/13	44.0314	41X54X11 DRD2	51153-01H10
750 GT	72/77	44.0040	35X48X11 DRD2	51153-19D10
750 VS GL Intruder	85/87	44.0300	37X50X11 DRD2	51153-03B30
750 VS GL Intruder	88/91	44.0241	39X52X11 DRD2	51153-19D00
800 DR S Big	91/93	44.1070	43X55X10,5/12 DR3	51153-14330
800 VS	06/09	44.0241	39X52X11 DRD2	51153-19D00
800 VS GL Intruder	92/05	44.0241	39X52X11 DRD2	51153-19D00
800 VL Intruder Volusia	01/05	44.0314	41X54X11 DRD2	51153-08D00
800 VL Intruder C800	06/13	44.0314	41X54X11 DRD2	51153-08D00
800 VZ Intruder M800	05/13	44.1140	41x53x8/10,5 DRD2	51153-10G50
800 VZ Marauder	97/02	44.1040	41X53X8/9,5 DR2	51153-27C20
800 VX	90/94	44.1040	41X53X8/9,5 DR2	51153-27C20
850 GS G	79/83	44.0308	37x49x8/10 DRD2	51153-08C20
850 GS GL	80/83	44.0308	37x49x8/10 DRD2	51153-08C20
900 RF R	94/97	44.0243	43X54X11 DRD2	51153-14D00
1000 DL V Strom	02/10	44.0243	43X54X11 DRD2	51153-14D00
1000 GS C/EC/N/EN	78/79	44.0308	37x49x8/10 DRD2	51153-08C20
1000 GS L	79	44.0308	37x49x8/10 DRD2	51153-08C20
1000 GS E	80	44.0308	37x49x8/10 DRD2	51153-08C20
1000 GS G/GL	80/81	44.0308	37x49x8/10 DRD2	51153-08C20
1000 GS S	79/82	44.0308	37x49x8/10 DRD2	51153-08C20
1000 GSX (SZ)	82	44.0308	37x49x8/10 DRD2	51153-08C20
1000 GSX-R	01/04	44.1150	43x55x9,5/10,5 DRD2	51153-40F00
1000 GSX-R	05/08	44.1150	43x55x9,5/10,5 DRD2	51153-41G00
1000 SV	03/06	44.1160	46x58x10,5 DRD2	51153-42F00
1000 TL R	98/03	44.1150	43x55x9,5/10,5 DRD2	51153-02FA0
1000 TL S	97/02	44.1060	43X55X9,5/10,5 DR3	51153-46E20
1100 GS E/ES	80/83	44.0308	37x49x8/10 DRD2	51153-08C20
1100 GS G/GL	82/83	44.0308	37x49x8/10 DRD2	51153-08C20
1100 GS S	83	44.0308	37x49x8/10 DRD2	51153-08C20
1100 GSX-F	88/93	44.0314	41X54X11 DRD2	51153-08D00
1100 GSX-R	86/88	44.1040	41X53X8/9,5 DR2	51153-27C20
1100 GSX-R	89	44.1060	43X55X9,5/10,5 DR3	51153-46E20
1100 GSX-R	90/94	44.1040	41X53X8/9,5 DR2	51153-27C20
1100 GSX-R	95/98	44.1060	43X55X9,5/10,5 DR3	51153-46E20
1150 GS E/ES/EF/EG	84/86	44.0308	37x49x8/10 DRD2	51153-00A00
1200 GSF Bandit/S	96/05	44.0243	43X54X11 DRD2	51153-14D00
1200 GSX	99/01	44.0243	43X54X11 DRD2	51153-14D00
1200 GV GLF/GLG Madura	85/86	44.1040	41X53X8/9,5 DR2	51153-27C20
1300 GSX-R Hayabusa	99/07	44.1150	43x55x9,5/10,5 DRD2	51153-02FA0
1300 GSX-R Hayabusa	08/12	44.1150	43x55x9,5/10,5 DRD2	51153-41G00

Applicazioni c.c. <i>marca/modello</i>	<i>anno</i>	<i>Cod. SGR</i>	<i>Misure/tipo</i>	<i>Riferimento originale</i>
1300 GSX-BK B-King	08/10	44.1150	43x55x9,5/10,5 DRD2	51153-41G00
1400 GSX	02/06	44.1160	46x58x10,5 DRD2	51153-42F00
1400 GV GD/GC/GT Cavalcade	86/88	44.1040	41X53X8/9,5 DR2	51153-27C20
1400 VS	04/09	44.0314	41X54X11 DRD2	51153-08D00
1400 VS GL/GLP Intruder	87/08	44.0314	41X54X11 DRD2	51153-08D00
1500 VL Intruder	98/09	44.0314	41X54X11 DRD2	51153-08D00
1600 VZ Marauder	04/05	44.0243	43X54X11 DRD2	51153-14D00
1600 VZ Intruder M1600	04/05	44.0243	43X54X11 DRD2	K9204-91590
1800 VZR/N/Z M1800	06/09	44.1160	46x58x10,5 DRD2	51153-48G00

TRIUMPH

750 Daytona	90/99	44.0351	43X55X10,5 DR3	2040078-T0301
750 Trident	91/95	44.0351	43X55X10,5 DR3	2040078-T0301
750 Speed Triple	94/95	44.0351	43X55X10,5 DR3	2040078-T0301
885 Adventure da 43510	96/01	44.0243	43X54X11 DRD2	T2042894
885 Legend TT da 92893	99/10	44.0243	43X54X11 DRD2	T2042894
885 Tiger/885 i da 43524	93/98	44.0243	43X54X11 DRD2	T2042894
900 Daytona	93/96	44.0351	43X55X10,5 DR3	2040078-T0301
900 Trophy	91/95	44.0351	43X55X10,5 DR3	2040078-T0301
900 Trophy da 42275 a 95082	96/02	44.0243	43X54X11 DRD2	T2042894
900 Trident/Sprint	91/95	44.0351	43X55X10,5 DR3	2040078-T0301
900 Trident da 44302	95/98	44.0243	43X54X11 DRD2	T2042894
900 Speed Triple	94/95	44.0351	43X55X10,5 DR3	2040078-T0301
900 Sprint/Executive	93/99	44.0351	43X55X10,5 DR3	2040078-T0301
900 Thunderbird da 43510 a 92893	95/01	44.0243	43X54X11 DRD2	T2042894
900 Thunderbird	95/02	44.0351	43X55X10,5 DR3	2040078-T0301
956 Sprint ST	99/01	44.0243	43X54X11 DRD2	T2042894
956 Sprint RS	00/03	44.0243	43X54X11 DRD2	T2042894
1000 Daytona	90/93	44.0351	43X55X10,5 DR3	2040078-T0301
1000 Daytona Super III	95/96	44.0351	43X55X10,5 DR3	2040078-T0301
1000 Trophy	91/95	44.0351	43X55X10,5 DR3	2040078-T0301
1000 Trophy da 96152 a 98479	96/98	44.0243	43X54X11 DRD2	T2042894
1200 Daytona	91/99	44.0351	43X55X10,5 DR3	2040078-T0301
1200 Trophy	91/95	44.0351	43X55X10,5 DR3	2040078-T0301
1200 Trophy da 96152 a 98479	96/02	44.0243	43X54X11 DRD2	T2042894

YAMAHA

50 DT R/X/SM	03/>	44.0350	36 x 48 x 11 DRD2	1D4F248000
80 YZ LC/LW/N	93/01	44.0304	36X48X8/9,5 DR2	4ES2314500
85 YZ	02/09	44.0304	36X48X8/9,5 DR2	4ES2314500
100 YZ	82/83	44.0038	36X48X10,5 DR3	1W123145L0
125 BW'S	10/13	44.0027	33x46x11 DRD2	4C6F314500
125 DT R	99/00	44.1050	41X53X8/9,5 DR3	3SP23145L0
125 DT RE	05/06	44.1050	41X53X8/9,5 DR3	3SP23145L0
125 XT R/X	05/>	44.0350	36 x 48 x 11 DRD2	1D4F248000
125 NXC Cygnus X	07/12	44.0027	33x46x11 DRD2	4C6F314500
125 WR R/X	09/13	44.1140	41x53x8/10,5 DRD2	4EB2314501
125 XV Virago	97/00	44.1130	33x45x8/9,5 DR2	2UJ2314500
125 YP R X-MAX	06/09	44.0038	36X48X10,5 DR3	1B9F314501
125 YZ	74/80	44.0038	36X48X10,5 DR3	1W123145L0
125 YZ	81/83	44.0266	38X50X10,5 DR3	1W423145L0
125 YZ	84/85	44.0243	43X54X11 DRD2	55Y23145L0
125 YZ	86/87	44.1070	43X55X10,5/12 DR3	23X23145L0
125 YZ	88	44.1060	43X55X9,5/10,5 DR3	3XJ23145L0
125 YZ	89/90	44.1050	41X53X8/9,5 DR3	3SP23145L0

<i>Applicazioni c.c. marca/modello</i>	<i>anno</i>	<i>Cod. SGR</i>	<i>Misure/tipo</i>	<i>Riferimento originale</i>
125 YZ	91/95	44.1060	43X55X9,5/10,5 DR3	3XJ23145L0
125 YZ	96/03	44.1100	46X58X9,5/11,5 DRD2	5ET23145L0
125 YZ	04/14	44.1170	48X58,1X8.5/10.5 DRD2	1C323145L0
200 WR	93	44.1050	41X53X8/9,5 DR3	3SP23145L0
225 TT/R	99/04	44.0040	35X48X11 DRD2	1KH2314500
225 XT	97/07	44.0040	35X48X11 DRD2	1KH2314500
230 TT R	05/09	44.0040	35X48X11 DRD2	1KH2314500
250 DT	77/78	44.0039	34x46x10.5 DR3	5842314550
250 DT	79/82	44.0038	36X48X10,5 DR3	1W123145L0
250 TT R	99/06	44.1060	43X55X9,5/10,5 DR3	3XJ23145L0
250 TZ	93/95	44.1050	41X53X8/9,5 DR3	3SP23145L0
250 TZ	96	44.0304	36X48X8/9,5 DR2	4ES2314500
250 WR 2T	91/96	44.1060	43X55X9,5/10,5 DR3	3XJ23145L0
250 WR 2T	97/98	44.1100	46X58X9,5/11,5 DRD2	5ET23145L0
250 WR F 4T	01/04	44.1100	46X58X9,5/11,5 DRD2	5ET23145L0
250 WR F 4T	05/11	44.1170	48X58,1X8.5/10.5 DRD2	1C323145L0
250 WR R/X 4T	08/13	44.1100	46X58X9,5/11,5 DRD2	5UN23145L0
250 XT	84	44.0038	36X48X10,5 DR3	48Y2314500
250 XV Virago/H/S	89/99	44.1130	33x45x8/9,5 DR2	2UJ2314500
250 YP Majesty/DX/ABS	96/06	44.1130	33x45x8/9,5 DR2	2UJ2314500
125 YP R X-MAX	05/09	44.0038	36X48X10,5 DR3	1B9F314501
250 YZ 2T	77/80	44.0266	38X50X10,5 DR3	1W423145L0
250 YZ 2T	81/84	44.0351	43X55X10,5 DR3	2VM2314500
250 YZ 2T	85/87	44.1070	43X55X10,5/12 DR3	23X23145L0
250 YZ 2T	88	44.1060	43X55X9,5/10,5 DR3	3XJ23145L0
250 YZ 2T	89/90	44.1050	41X53X8/9,5 DR3	3SP23145L0
250 YZ 2T	91/95	44.1060	43X55X9,5/10,5 DR3	3XJ23145L0
250 YZ 2T	96/03	44.1100	46X58X9,5/11,5 DRD2	5ET23145L0
250 YZ 2T	04/14	44.1170	48X58,1X8.5/10.5 DRD2	1C323145L0
250 YZ F 4T	01/03	44.1100	46X58X9,5/11,5 DRD2	5ET23145L0
250 YZ F 4T	04/09	44.1170	48X58,1X8.5/10.5 DRD2	1C323145L0
350 RD LC	80/82	44.0253	32X43X12,5 DR3	4LO2314500
350 RD LCF	86	44.0040	35X48X11 DRD2	1UA2314500
350 RD LC	91/92	44.0040	35X48X11 DRD2	1UA2314500
350 RZ	84	44.0040	35X48X11 DRD2	1UA2314500
350 TT	85/95	44.0314	41X54X11 DRD2	3MA2314500
350 XT	85/00	44.0038	36X48X10,5 DR3	48Y2314500
400 DT	77/78	44.0039	34x46x10.5 DR3	5842314550
400 WR F	98/01	44.1100	46X58X9,5/11,5 DRD2	5ET23145L0
400 XS J/K/R	82/83	44.0040	35X48X11 DRD2	1UA2314500
400 YP Majesty/ABS	04/12	44.1140	41x53x8/10,5 DRD2	4EB2314501
400 YZ F	98/99	44.1100	46X58X9,5/11,5 DRD2	5ET23145L0
426 WR F	01/02	44.1100	46X58X9,5/11,5 DRD2	5ET23145L0
426 YZ F	00/02	44.1100	46X58X9,5/11,5 DRD2	5ET23145L0
450 WR F	03/04	44.1100	46X58X9,5/11,5 DRD2	5ET23145L0
450 WR F 4T	05/11	44.1170	48X58,1X8.5/10.5 DRD2	1C323145L0
450 YZ F	03	44.1100	46X58X9,5/11,5 DRD2	5ET23145L0
450 YZ F 4T	04/09	44.1170	48X58,1X8.5/10.5 DRD2	1C323145L0
465 YZ	80	44.0266	38X50X10,5 DR3	1W423145L0
465 YZ	81	44.0351	43X55X10,5 DR3	4V423145L0
490 YZ	82	44.0351	43X55X10,5 DR3	4V423145L0
490 YZ	83/87	44.1070	43X55X10,5/12 DR3	23X23145L0
490 YZ	88/90	44.1060	43X55X9,5/10,5 DR3	3XJ23145L0
500 RD	84/85	44.0308	37x49x8/10 DRD2	41Y2314500
500 RZ	85/86	44.0308	37x49x8/10 DRD2	2H72314501
500 TT	76/81	44.0038	36X48X10,5 DR3	48Y2314500

<i>Applicazioni</i>	<i>c.c. marca/modello</i>	<i>anno</i>	<i>Cod. SGR</i>	<i>Misure/tipo</i>	<i>Riferimento originale</i>
500	XP T-Max	08/11	44.1150	43x55x9,5/10,5 DRD2	4PU2314501
500	XS	76/78	44.0040	35X48X11 DRD2	1UA2314500
500	XT	76/81	44.0038	36X48X10,5 DR3	48Y2314500
500	XV K	83	44.0304	36X48X8/9,5 DR2	4ES2314500
530	XP T-Max	12/13	44.1150	43x55x9,5/10,5 DRD2	4PU2314501
535	XV Virago/SE/DX	88/99	44.0040	35X48X11 DRD2	1KH2314500
550	XJ	81/83	44.0304	36X48X8/9,5 DR2	4ES2314500
550	XT	82/83	44.0266	38X50X10,5 DR3	1W423145L0
600	FJ	84/85	44.0304	36X48X8/9,5 DR2	4ES2314500
600	FZ	86/88	44.0304	36X48X8/9,5 DR2	4ES2314500
600	FZR	89/93	44.1030	38X50X8/9,5 DR2	3EN2314500
600	FZR R	94/95	44.1050	41X53X8/9,5 DR3	3SP23145L0
600	FZS Fazer/S	98/03	44.1140	41x53x8/10,5 DRD2	4EB2314501
600	FZ6 Fazer/S2/ABS	04/09	44.0351	43X55X10,5 DR3	5VX2314500
600	FZ6 N/NS/S2	04/09	44.0351	43X55X10,5 DR3	5VX2314500
600	SRX	86/87	44.0304	36X48X8/9,5 DR2	4ES2314500
600	TT K/L	83/84	44.1070	43X55X10,5/12 DR3	23X23145L0
600	TT N	85/88	44.1070	43X55X10,5/12 DR3	23X23145L0
600	TT W	89/92	44.1060	43X55X9,5/10,5 DR3	3XJ23145L0
600	TT S	93/96	44.1060	43X55X9,5/10,5 DR3	3XJ23145L0
600	TT E	94/01	44.1060	43X55X9,5/10,5 DR3	3XJ23145L0
600	XJ N	95/97	44.1030	38X50X8/9,5 DR2	3EN2314500
600	XJ N	98/02	44.1140	41x53x8/10,5 DRD2	4EB2314501
600	XJ S Diversion	92/97	44.1030	38X50X8/9,5 DR2	3EN2314500
600	XJ S Diversion	98/02	44.1140	41x53x8/10,5 DRD2	4EB2314501
600	XT Z Tènèrè	83/90	44.0314	41X54X11 DRD2	3MA2314500
600	XT E	95/02	44.1050	41X53X8/9,5 DR3	3SP23145L0
600	XY Radian	86/90	44.0304	36X48X8/9,5 DR2	4ES2314500
600	YZF R6	99/04	44.1150	43x55x9,5/10,5 DRD2	4PU2314501
600	YZF R6/R46	05	44.1140	41x53x8/10,5 DRD2	4EB2314501
600	YZF Thundercat	96/06	44.1050	41X53X8/9,5 DR3	3SP23145L0
650	XJ G/H/J/L/R	80/82	44.0304	36X48X8/9,5 DR2	4ES2314500
650	XJ K	83	44.0304	36X48X8/9,5 DR2	4ES2314500
650	XJ LK	83	44.0308	37x49x8/10 DRD2	41Y2314500
650	XS LK	83	44.0308	37x49x8/10 DRD2	41Y2314500
650	XVS Drag Star	97	44.1050	41X53X8/9,5 DR3	3SP23145L0
650	XVS Drag Star/Classic	98/06	44.1140	41x53x8/10,5 DRD2	4EB2314501
660	MT-03	06	44.1060	43X55X9,5/10,5 DR3	3XJ23145L0
660	XT R/X	04/05	44.1060	43X55X9,5/10,5 DR3	3XJ23145L0
660	XTZ Tènéré	91/96	44.1070	43X55X10,5/12 DR3	23X23145L0
700	XV Virago	84	44.0301	38x50x8/10,5 DR2	42H2314500
750	FZR R Genesis	87/88	44.1050	41X53X8/9,5 DR3	3SP23145L0
750	FZR R (OW01)	89/90	44.1060	43X55X9,5/10,5 DR3	3XJ23145L0
750	XTZ Super Tènéré	89/95	44.1070	43X55X10,5/12 DR3	23X23145L0
750	XJ J	82	44.0304	36X48X8/9,5 DR2	4ES2314500
750	XJ K/MK	83	44.0304	36X48X8/9,5 DR2	4ES2314500
750	XJ RH/RJ/RK	81/83	44.0040	35X48X11 DRD2	1KH2314500
750	XS/XS-2D	77	44.0040	35X48X11 DRD2	1UA2314500
750	XV H/J Virago	81/82	44.0304	36X48X8/9,5 DR2	4ES2314500
750	XV K/MK Virago	83	44.0304	36X48X8/9,5 DR2	4ES2314500
750	XV Virago	88/96	44.1030	38X50X8/9,5 DR2	3EN2314500
750	YZF R/SP	93/95	44.1050	41X53X8/9,5 DR3	3SP23145L0
750	YZF R7 (OW02)	99/00	44.0351	43X55X10,5 DR3	5VX2314500
800	FZ8 N/S/ABS Fazer	10/13	44.1150	43x55x9,5/10,5 DRD2	4PU2314501
850	MT-09	13/14	44.1140	41x53x8/10,5 DRD2	4EB2314501
850	TDM	96/01	44.0351	43X55X10,5 DR3	5VX2314500

<i>Applicazioni</i>	<i>anno</i>	<i>Cod. SGR</i>	<i>Misure/tipo</i>	<i>Riferimento originale</i>
<i>c.c. marca/modello</i>				
850 TRX	96/97	44.1050	41X53X8/9,5 DR3	3SP23145L0
850 XS S/L Midnight Special	80/81	44.0304	36X48X8/9,5 DR2	4ES2314500
900 TDM	02/09	44.1150	43x55x9,5/10,5 DRD2	4PU2314500
900 XJ/Seca	83	44.0308	37x49x8/10 DRD2	2H72314501
900 XJ S Diversion	95/07	44.1050	41X53X8/9,5 DR3	3SP23145L0
900 XJ S Diversion	98/01	44.1140	41x53x8/10,5 DRD2	4EB2314501
920 XV R (RH/RJ)	81/82	44.0308	37x49x8/10 DRD2	41Y2314500
920 XV J Virago	82	44.0040	35X48X11 DRD2	1KH2314500
920 XV K/MK Virago/Midnight	83	44.0304	36X48X8/9,5 DR2	4ES2314500
950 XVS A Midnight Star	09/13	44.1140	41x53x8/10,5 DRD2	4EB2314501
1000 FZR Genesis	87/88	44.1050	41X53X8/9,5 DR3	3SP23145L0
1000 FZR Ex-Up	89/90	44.1060	43X55X9,5/10,5 DR3	3XJ23145L0
1000 FZR Ex-Up	91/93	44.1050	41X53X8/9,5 DR3	3SP23145L0
1000 FZS Fazer	01/05	44.0351	43X55X10,5 DR3	5VX2314500
1000 FZ1 N/S Fazer	06/12	44.1150	43x55x9,5/10,5 DRD2	4PU2314501
1000 XV TR1	81/82	44.0308	37x49x8/10 DRD2	2H72314500
1000 XV Midnight Special	83	44.0304	36X48X8/9,5 DR2	4ES2314500
1000 XV Virago	86/88	44.1030	38X50X8/9,5 DR2	3EN2314500
1000 XV Virago/SE	86/88	44.1030	38X50X8/9,5 DR2	3EN2314500
1000 YZF R1	98/01	44.1140	41x53x8/10,5 DRD2	4EB2314501
1000 YZF R1	02/06	44.1150	43x55x9,5/10,5 DRD2	4PU2314500
1000 YZF R1 SP	06	44.0351	43X55X10,5 DR3	5VX2314500
1000 YZF R1	07/08	44.1150	43x55x9,5/10,5 DRD2	4PU2314500
1000 YZF R1	09/14	44.0351	43X55X10,5 DR3	5VX2314500
1100 BT Bulldog	02/06	44.1150	43x55x9,5/10,5 DRD2	4PU2314500
1100 FJ	84/85	44.1050	41X53X8/9,5 DR3	3SP23145L0
1100 XS	78/81	44.0308	37x49x8/10 DRD2	41Y2314500
1100 XV Virago	86/97	44.1030	38X50X8/9,5 DR2	3EN2314500
1100 XV Virago	98/99	44.1140	41x53x8/10,5 DRD2	4DN2314500
1100 XVS Drag Star/Classic	99/06	44.1140	41x53x8/10,5 DRD2	4EB2314501
1200 FJ	86/92	44.1050	41X53X8/9,5 DR3	3SP23145L0
1200 V Max	86/92	44.0303	40X52X8/9,5 DR2	1NL2314500
1200 V Max	93/98	44.1060	43X55X9,5/10,5 DR3	3XJ23145L0
1200 V Max	99/06	44.1150	43x55x9,5/10,5 DRD2	4PU2314500
1200 XJR	95/97	44.1060	43X55X9,5/10,5 DR3	3XJ23145L0
1200 XVZ 12TD Venture Royale	88	44.0303	40X52X8/9,5 DR2	1NL2314500
1300 XJR/SP	99/08	44.1150	43x55x9,5/10,5 DRD2	4PU2314500
1300 XVS A Midnight Star	07/09	44.1140	41x53x8/10,5 DRD2	4EB2314501
1300 XVZ 13TD	89/90	44.0303	40X52X8/9,5 DR2	1NL2314500
1300 XVZ Royal Star/Venture	99/06	44.0243	43X54X11 DRD2	4NK2314500
1600 XV A Wild Star	99/02	44.0243	43X54X11 DRD2	4NK2314500
1600 XV Road Star Midnight/Silverado	99/03	44.0243	43X54X11 DRD2	4NK2314500
1700 MT-01/S	05/07	44.0351	43X55X10,5 DR3	5VX2314500
1700 XV Warrior	03/04	44.1140	41x53x8/10,5 DRD2	4EB2314501
1700 XV Road Star	04/06	44.0243	43X54X11 DRD2	4NK2314500
1900 XV Roadliner/Stratoliner	06/08	44.1160	46x58x10,5 DRD2	1D72314500

○ coppia non di produzione Vesrah ad esaurimento scorte



A
L
L
B
A
L
L
S

TUTTO CIO' CHE TI SERVE IN UN UNICO KIT FACILE DA MONTARE



All Balls è il compagno ideale per una rigenerazione facile e veloce della vostra moto da fuoristrada. All Balls infatti include in un unico kit tutti i componenti necessari a portare correttamente a termine il lavoro senza dover rincorrere una lista infinita di pezzi.

Tutti i prodotti All Balls sono di qualità ed eccedono la durata dei componenti di primo impianto. I cuscinetti sono tutti prodotti in acciaio AISI 52100. I distanziali sono in acciaio cementato e cromato per una maggiore resistenza all'usura e corrosione. Nei kit All Balls tutti i cuscinetti reggispinta sono stati sostituiti con cuscinetti in teflon progettato per vivere più a lungo in acqua e sporcizia.

Kit revisione ruota

A - KIT CUSCINETTI E PARAPOLVERE RUOTA

I cuscinetti delle ruote delle moto da fuoristrada hanno, in genere, vita breve per colpa delle infiltrazioni di acqua e di polvere che ne minano la durata.

I cuscinetti All-Balls sono stati sviluppati in collaborazione con la KML specificatamente per le attività motoristiche off-road. Il doppio labbro in gomma del cuscinetto tiene lontano l'acqua e lo sporco e consente una migliore ritenzione del grasso.

I kit cuscinetti e parapolvere per ruota All Balls includono tutti i cuscinetti e le guarnizioni necessari per rigenerare la ruota.



B - KIT DISTANZIALI PER RUOTA

Nell'uso fuoristradistico delle moto, acqua e sporcosi frappongono tra la guarnizione e la superficie di accoppiamento del distanziale ruota. Ciò provoca delle scanalature che con il tempo causano la perdita di tenuta delle superficie consentendo ad acqua e polvere di accedere al cuscinetto causandone la perdita di efficienza.

In linea generale i distanziali ruota di primo equipaggiamento delle moto da fuoristrada si deteriorano nel giro di un anno di uso della moto.

Per tale motivo devono essere controllati e sostituiti se necessario ad ogni sostituzione dei cuscinetti ruota.

Kit cuscinetti albero motore e kit tenuta albero secondario

C - KIT CUSCINETTI ALBERO MOTORE

I kit cuscinetti e paraolio per l'albero motore della All Balls contengono i cuscinetti da banco della Koyo e Nachi e guarnizioni in carbonio/fluorocarbon con labbro di tenuta che consente di ridurre l'attrito dovuto a carenza di lubrificazione e all'usura del perno.



D - KIT TENUTA ALBERO SECONDARIO

I kit di revisione dell'albero pignone contengono tutte le rondelle, le guarnizioni e la minuteria necessaria a riparare e rigenerare l'uscita del contralbero.

I kit All Balls racing comprendono tutti i componenti necessari per fare il lavoro nel modo corretto e con il minimo sforzo.

Kit revisione sterzo, cuscinetti e parapolvere

E - KIT CUSCINETTI E PARAPOLVERE STERZO

I kit cuscinetto e parapolvere sterzo della All Balls sono disegnati per rigenerare lo sterzo e riottenere l'agilità di sterzata persa con l'usura dei componenti dello sterzo.

Il kit include il cuscinetto superiore ed inferiore e le guarnizioni parapolvere.



Paraolio e parapolvere forcella



F/G - KIT PARAOLIO E PARAPOLVERE FORCELLA

I kit paraolio e parapolvere forcella All Balls hanno un design unico a 3 labbra che ripartisce uniformemente la pressione riducendo così la temperatura di lavoro, l'attrito e l'usura.

Gli elastomeri utilizzati sono testati per durare molto di più di quelli di primo impianto.

Durata media dalle 3 alle 5 volte superiore rispetto alle guarnizioni di primo impianto.

Riduzione dell'attrito del 50%-60% rispetto alle guarnizioni di primo impianto.

Il minore attrito comporta una durata superiore!

Kit revisione forcellone, leveraggi e mono

H - KIT REVISIONE FORCELLONE

I kit revisione forcellone All Balls contengono tutti i cuscinetti, le boccole e le guarnizioni necessarie per riparare e ripristinare la funzionalità ottimale del vostro forcellone. I cuscinetti sono prodotti con l'uso di acciaio AISI 51200 per le migliori prestazioni lunga durata. Le rondelle con rivestimento in teflon D in alternativa ai cuscinetti ad aghi di spinta offrono una superiore resistenza allo sporco, all'acqua e alla mancanza di lubrificazione.



I - KIT REVISIONE LEVERAGGI

I kit All Balls per revisionare i leveraggi comprende tutti i cuscinetti, gli alberi, le guarnizioni e le boccole per rigenerare i leveraggi del forcellone secondo le specifiche del produttore.

L - KIT REVISIONE MONO SUPERIORE ED INFERIORE

I kit revisione mono superiore ed inferiore All Balls sono progettati per sostituire le boccole e i cuscinetti usurati del monoammortizzatore e per agevolare un migliore funzionamento dello stesso.



Tabella applicazioni All Balls

Applicazioni cc marca/modello	anno	A		B		C	D	E	Applicazioni cc marca/modello	anno	F	G	H	I	L
		kit cuscinetti ruota ant.	kit cuscinetti ruota post.	kit distanziali ruota ant.	kit distanziali ruota post.	kit cuscinetti albero motore	kit tenuta albero secondario	kit cuscinetti e parapolvere sterzo			Kit paraolio e parapolvere forcella	Kit paraolio forcella	Kit cuscinetti forcellone	Kit revisione leveraggi	Kit cuscinetti mono inf.
APRILIA															
50 RS	06/08	41.10001	41.10001						50 RS	06/08					
50 RS Extrema, Replica	99/05	41.10001							50 RS Extrema, Replica	99/05					
50 Tuono	03/04	41.10001							50 Tuono	03/04					
125 MX SM (25K)	04							41.10279	125 MX SM (25K)	04					
125 RX	04							41.10279	125 RX	04					
250 RS	98/04							41.10606	250 RS	98/04					
450 RXV	05/13		41.10045					41.10616	450 RXV	05/13					
450 SXV	05/13		41.10045					41.10616	450 SXV	05/13					
550 RXV	05/13		41.10045					41.10616	550 RXV	05/13					
550 SXV	05/13		41.10045					41.10616	550 SXV	05/13					
650 Pegaso / Cube / IE	97/05							41.10279	650 Pegaso / Cube / IE	97/05					
750 Dorsoduro (SMC00/SM000/SMA00)	08/11							41.10279	750 Dorsoduro (SMC00/SM000/SMA00)	08/11					
750 Shiver (RA000/RAC00/RAE00/RAG00)	08/12							41.10279	750 Shiver (RA000/RAC00/RAE00/RAG00)	08/12					
850 Mana / Mana GT	07/12							41.10279	850 Mana / Mana GT	07/12					
1000 ETV Caponord / ABS	01/07							41.10605	1000 ETV Caponord / ABS	01/07					
1000 RST Futura	01/04							41.10605	1000 RST Futura	01/04					
1000 RSV / RSV R	00							41.10605	1000 RSV / RSV R	00					
1000 RSV / RSV R	01/03							41.10605	1000 RSV / RSV R	01/03		41.10636			
1000 RSV 4 R (RKA00)	09/10							41.10605	1000 RSV 4 R (RKA00)	09/10		41.10636			
1000 RSV 4 R APRC (RKE00/RKE01/RKH)	11							41.10605	1000 RSV 4 R APRC (RKE00/RKE01/RKH)	11					
1000 RSV 4 R Factory (RK000/RK001/RKC00)	09/10							41.10605	1000 RSV 4 R Factory (RK000/RK001/RKC00)	09/10					
1000 RSV 4 R Factory APRC (RKB00/RKB01/RKG)	11							41.10605	1000 RSV 4 R Factory APRC (RKB00/RKB01/RKG)	11					
1000 RSV R / Factory	04/05							41.10605	1000 RSV R / Factory	04/05		41.10636			
1000 RSV R / Factory	06/08							41.10605	1000 RSV R / Factory	06/08					
1000 SL Falco	00/03							41.10605	1000 SL Falco	00/03					
1000 Tuono Figter	02/05							41.10605	1000 Tuono Figter	02/05					
1000 Tuono R / Racing / Factory	06/08							41.10605	1000 Tuono R / Racing / Factory	06/08		41.10636			
1000 Tuono R / Racing / Factory	11/12							41.10605	1000 Tuono R / Racing / Factory	11/12					

BETA

50 REV	06/08	41.10001	41.10001					41.10280	50 REV	06/08					
80 EVO	09/11	41.10002	41.10002					41.10280	80 EVO	09/11					
80 EVO JR	09/11	41.10001	41.10001					41.10280	80 EVO JR	09/11					
80 Rev	08	41.10002	41.10002					41.10280	80 Rev	08					
80 Rev	06/07	41.10001	41.10001					41.10280	80 Rev	06/07					
125 Rev 2T	04	41.10002	41.10002					41.10280	125 Rev 2T	04					
125 Rev 2T	05/08	41.10002	41.10002					41.10280	125 Rev 2T	05/08		41.10652			
125 Rev 2T	09/10	41.10003	41.10003					41.10280	125 Rev 2T	09/10		41.10652			
125 Rev 2T	11/13	41.10003	41.10002					41.10280	125 Rev 2T	11/13		41.10652			
200 Rev 2T	04	41.10002	41.10002					41.10280	200 Rev 2T	04					
200 Rev 2T	05/08	41.10002	41.10002					41.10280	200 Rev 2T	05/08		41.10652			
200 Rev 2T	09/10	41.10003	41.10003					41.10280	200 Rev 2T	09/10		41.10652			
200 Rev 2T	11/13	41.10003	41.10002					41.10280	200 Rev 2T	11/13		41.10652			
250 EVO 2T	09/10	41.10003	41.10003					41.10280	250 EVO 2T	09/10		41.10652			
250 EVO 2T	11/13	41.10003	41.10002					41.10280	250 EVO 2T	11/13		41.10652			
250 EVO 4T	09/10	41.10003	41.10003					41.10280	250 EVO 4T	09/10		41.10652			
250 EVO 4T	11/12	41.10003	41.10002					41.10280	250 EVO 4T	11/12		41.10652			
250 Rev 2T	04	41.10002	41.10002					41.10280	250 Rev 2T	04					
250 Rev 2T	05/08	41.10002	41.10002					41.10280	250 Rev 2T	05/08		41.10652			

Applicazioni		anno	A		B		C	D	E	Applicazioni		anno	F	G	H	I	L	
cc	marca/modello		kit cuscinetti ruota ant.	kit cuscinetti ruota post.	kit distanziali ruota ant.	kit distanziali ruota post.	kit cuscinetti albero motore	kit tenuta albero secondario	kit cuscinetti e parapolvere sterzo	cc	marca/modello		Kit paraolio e parapolvere forcella	Kit paraolio forcella	Kit cuscinetti forcellone	Kit revisione leveraggi	Kit cuscinetti mono inf.	Kit cuscinetti mono sup.
250	REV Racing 4T	08	41.10002	41.10002					41.10280	250	REV Racing 4T	08		41.10652				
270	Rev 2T	04	41.10002	41.10002					41.10280	270	Rev 2T	04						
270	Rev 2T	05/08	41.10002	41.10002					41.10280	270	Rev 2T	05/08		41.10652				
290	EVO 2T	11	41.10003	41.10002					41.10280	290	EVO 2T	11		41.10652				
290	EVO 2T	09/10	41.10003	41.10003					41.10280	290	EVO 2T	09/10		41.10652				
300	EVO 2T	12/13	41.10003	41.10002					41.10280	300	EVO 2T	12/13		41.10652				
300	EVO 4T	09/10	41.10003	41.10003					41.10280	300	EVO 4T	09/10		41.10652				
300	EVO 4T	11/12	41.10003	41.10002					41.10280	300	EVO 4T	11/12		41.10652				
300	RR Enduro 2T	13	41.10004	41.10061						300	RR Enduro 2T	13						
350	RR Enduro (Mot.BETA)	11/12	41.10004	41.10061						350	RR Enduro (Mot.BETA)	11/12						
400	RR EN (Mot.KTM)	05/10	41.10004							400	RR EN (Mot.KTM)	05/10	41.10310	41.10651				
400	RR Enduro (Mot.BETA)	11/12	41.10004	41.10061						400	RR Enduro (Mot.BETA)	11/12						
450	RR EN (Mot.KTM)	05/10	41.10004							450	RR EN (Mot.KTM)	05/10	41.10310	41.10651				
450	RR Enduro (Mot.BETA)	11/12	41.10004	41.10061						450	RR Enduro (Mot.BETA)	11/12						
498	RR Enduro (Mot.BETA)	12	41.10004	41.10061						498	RR Enduro (Mot.BETA)	12						
520	RR Enduro (Mot.BETA)	10	41.10004							520	RR Enduro (Mot.BETA)	10	41.10310	41.10651				
520	RR Enduro (Mot.BETA)	11	41.10004	41.10061						520	RR Enduro (Mot.BETA)	11						
525	RR EN (Mot.KTM)	05/09	41.10004							525	RR EN (Mot.KTM)	05/09	41.10310	41.10651				

BMW

600	R 60/7	78/83	41.10617						41.10299	600	R 60/7	78/83						
450	G X	08/10	41.10045	41.10045						450	G X	08/10						
650	F GS / Dakar (K78)	01/07							41.10299	650	F GS / Dakar (K78)	01/07		41.10635				
650	F / ST strada / Funduro	97/99							41.10279	650	F / ST strada / Funduro	97/99		41.10635				
650	F GS 2C (800cc)	08/10							41.10299	650	F GS 2C (800cc)	08/10						
650	G GS / Sertão (R13)	08/09							41.10299	650	G GS / Sertão (R13)	08/09		41.10635				
650	R 65	78/85	41.10617						41.10299	650	R 65	78/85						
650	R 65	86/87							41.10299	650	R 65	86/87						
750	K 75 C	85/95							41.10299	750	K 75 C	85/95						
750	K 75 RT	85/95							41.10299	750	K 75 RT	85/95		41.10635				
750	K 75 S	85/95							41.10299	750	K 75 S	85/95		41.10635				
750	K 75	90/95							41.10299	750	K 75	90/95		41.10635				
750	R 75/5	69/74	41.10617						41.10299	750	R 75/5	69/74						
750	R 75/6	73/76	41.10617						41.10299	750	R 75/6	73/76						
750	R 75/7	76/80	41.10617						41.10299	750	R 75/7	76/80						
800	R 80 GS	80/86	41.10617						41.10299	800	R 80 GS	80/86						
800	R 80 RT	82/84	41.10617						41.10299	800	R 80 RT	82/84						
800	R 80 RT	85/95							41.10299	800	R 80 RT	85/95						
800	R 80 ST	80/86	41.10617						41.10299	800	R 80 ST	80/86						
800	R 80/7	76/84	41.10617						41.10299	800	R 80/7	76/84						
900	R 90	74/76							41.10299	900	R 90	74/76						
900	R 90 S	69/76							41.10299	900	R 90 S	69/76						
1000	K1	89/92							41.10299	1000	K1	89/92						
1000	K 100 LT	86/91							41.10299	1000	K 100 LT	86/91						
1000	K 100 RS	84/92							41.10299	1000	K 100 RS	84/92						
1000	K 100 RT	84/88							41.10299	1000	K 100 RT	84/88						
1000	K 100	84/86							41.10299	1000	K 100	84/86						
1000	R 100	78	41.10617						41.10299	1000	R 100	78						
1000	R 100 R	92/95							41.10299	1000	R 100 R	92/95		41.10635				
1000	R 100 RS	76/84	41.10617						41.10299	1000	R 100 RS	76/84						
1000	R 100 RS	87/92							41.10299	1000	R 100 RS	87/92						
1000	R 100 RT	78/85	41.10617						41.10299	1000	R 100 RT	78/85						
1000	R 100 RT	87/95							41.10299	1000	R 100 RT	87/95						

Applicazioni cc marca/modello		anno	A kit cuscinetti ruota ant.	kit cuscinetti ruota post.	B kit distanziali ruota ant.	kit distanziali ruota post.	C kit cuscinetti albero motore	D kit tenuta albero secondario	E kit cuscinetti e parapolvere sterzo	Applicazioni cc marca/modello		anno	F Kit paraolio e parapolvere forcella	G Kit paraolio forcella	H Kit cuscinetti forcellone	I Kit revisione leveraggi	J Kit cuscinetti mono inf.	K Kit cuscinetti mono sup.
1000 R 100 S	76/80	41.10617							41.10299	1000 R 100 S	76/80							
1000 R 100 CS	80/84	41.10617							41.10299	1000 R 100 CS	80/84							
1000 R 100 GS / R 100 GS Parigi Dakar	87/94								41.10299	1000 R 100 GS / R 100 GS Parigi Dakar	87/94							
1100 K LT	92/97								41.10299	1100 K LT	92/97							
1100 K RS	92/96								41.10299	1100 K RS	92/96							
1200 K GT (K41)	05	41.10079								1200 K GT (K41)	05							
1200 K GT (K44)	06/08	41.10079								1200 K GT (K44)	06/08							
1200 K GT (K44) ABS	06/08	41.10079								1200 K GT (K44) ABS	06/08							
1200 K R (K43)	05/08	41.10079								1200 K R (K43)	05/08							
1200 K S (K40)	05/08	41.10079								1200 K S (K40)	05/08							
1600 K GT/ GTL	10	41.10079								1600 K GT/ GTL	10							
1300 K R (K43)	09/10	41.10079								1300 K R (K43)	09/10							
1300 K S (K40)	09/10	41.10079								1300 K S (K40)	09/10							

BUELL

500 Blast	00/09								41.10291	500 Blast	00/09	41.10318	41.10628					
900 XB9R Firebolt	03								41.10291	900 XB9R Firebolt	03		41.10635					
900 XB9R Firebolt	04/06								41.10291	900 XB9R Firebolt	04/06		41.10636					
900 XB9S Lightning	03								41.10291	900 XB9S Lightning	03		41.10635					
900 XB9S Lightning	04/09								41.10291	900 XB9S Lightning	04/09		41.10636					
1125 CR	09									1125 CR	09	41.10330	41.10643					
1125 R	08/09									1125 R	08/09	41.10330	41.10643					
1200 M2 Cyclone	97/02								41.10291	1200 M2 Cyclone	97/02		41.10636					
1200 XB12R Firebolt	05/08								41.10291	1200 XB12R Firebolt	05/08		41.10636					
1200 S1 Lightning	96/98								41.10291	1200 S1 Lightning	96/98							
1200 X1 Lightning	00/02								41.10291	1200 X1 Lightning	00/02		41.10635					
1200 XB12S Lightning	05/09								41.10291	1200 XB12S Lightning	05/09		41.10636					
1200 S3 Thunderbolt	97/98								41.10291	1200 S3 Thunderbolt	97/98							
1200 S3 Thunderbolt	99/01								41.10291	1200 S3 Thunderbolt	99/01		41.10635					
1200 XB12X Ulysses	06/07								41.10291	1200 XB12X Ulysses	06/07		41.10636					
1200 XB12X Ulysses	08/09								41.10291	1200 XB12X Ulysses	08/09	41.10330	41.10643					

CAGIVA

500 Canyon	96/98								41.10291	500 Canyon	96/98	41.10310	41.10651					
650 Raptor	01/06								41.10291	650 Raptor	01/06		41.10636					
750 Elefant	93/95								41.10291	750 Elefant	93/95							
900 Elefant / Elefant I.E.	93/97								41.10291	900 Elefant / Elefant I.E.	93/97							
900 Gran Canyon	98/00								41.10291	900 Gran Canyon	98/00	41.10310	41.10651					
1000 Navigator	00/05								41.10291	1000 Navigator	00/05	41.10310	41.10651					
1000 Raptor / V Raptor	00/05								41.10291	1000 Raptor / V Raptor	00/05		41.10636					

DUCATI

600 Monster	00/01								41.10612	600 Monster	00/01		41.10636					
620 Monster	02/06								41.10605	620 Monster	02/06		41.10636					
620 Multistrada	06								41.10605	620 Multistrada	06		41.10636					
695 Monster	07								41.10605	695 Monster	07							
695 Monster	08								41.10605	695 Monster	08		41.10636					
696 Monster	08/09								41.10605	696 Monster	08/09		41.10636					
748 748 BIP	95/03								41.10605	748 748 BIP	95/03		41.10636					
748 748 SPS	98/99								41.10605	748 748 SPS	98/99		41.10636					
750 F1	87/89								41.10612	750 F1	87/89		41.10629					
750 Monster	00/01								41.10612	750 Monster	00/01		41.10636					
750 Supersport	91/96								41.10612	750 Supersport	91/96		41.10635					

		A		B		C	D	E			F	G	H	I	L			
Applicazioni cc	marca/modello	anno	kit cuscinetti ruota ant.	kit cuscinetti ruota post.	kit distanziali ruota ant.	kit distanziali ruota post.	kit cuscinetti albero motore	kit tenuta albero secondario	kit cuscinetti e parapolvere sterzo	Applicazioni cc	marca/modello	anno	Kit paraolio e parapolvere forcella	Kit paraolio forcella	Kit cuscinetti forcellone	Kit revisione leveraggi	Kit cuscinetti mono inf.	Kit cuscinetti mono sup.
750	Super Sport Desmo	72/75							41.10612	750	Super Sport Desmo	72/75		41.10629				
750	Supersport	99/02							41.10612	750	Supersport	99/02		41.10636				
800	Monster S	03/04							41.10605	800	Monster S	03/04		41.10636				
800	Monster S2R	07							41.10605	800	Monster S2R	07		41.10636				
888	888	92/94							41.10612	888	888	92/94		41.10635				
888	888 SBK	95							41.10605	888	888 SBK	95		41.10635				
900	Monster	93/99							41.10612	900	Monster	93/99		41.10635				
900	Monster IE	00/02							41.10612	900	Monster IE	00/02		41.10636				
900	Superlight	91/97							41.10612	900	Superlight	91/97		41.10635				
900	SuperSport	91/97							41.10612	900	SuperSport	91/97		41.10635				
900	SD Sport Darmah	75/85							41.10612	900	SD Sport Darmah	75/85		41.10629				
900	SuperSport	98/99							41.10612	900	SuperSport	98/99		41.10635				
900	SuperSport IE	00/02							41.10612	900	SuperSport IE	00/02		41.10636				
900	MH Evoluzione	02							41.10612	900	MH Evoluzione	02		41.10636				
916	916 S Senna	94							41.10612	916	916 S Senna	94		41.10636				
916	916 S Senna	95/98							41.10605	916	916 S Senna	95/98		41.10636				
916	916 BIP	94							41.10612	916	916 BIP	94		41.10636				
916	916 BIP	95/97							41.10605	916	916 BIP	95/97		41.10636				
916	Monster S4	01/03							41.10605	916	Monster S4	01/03		41.10636				
916	916 SP	94							41.10612	916	916 SP	94		41.10636				
916	916 SP	95/96							41.10605	916	916 SP	95/96		41.10636				
916	ST4	99/03							41.10605	916	ST4	99/03		41.10636				
944	ST2	98/03							41.10605	944	ST2	98/03		41.10636				
992	ST3	04/07							41.10605	992	ST3	04/07		41.10636				
996	996 BIP	00/01							41.10605	996	996 BIP	00/01		41.10636				
996	Monster S4 R	04/06							41.10605	996	Monster S4 R	04/06		41.10636				
998	Monster S4 R	07/08							41.10605	998	Monster S4 R	07/08						
998	998 BIP	02/04							41.10605	998	998 BIP	02/04						
998	999 S	03/06							41.10605	998	999 S	03/06		41.10636				
1000	Monster S	03/05							41.10605	1000	Monster S	03/05		41.10636				
1000	Monster S2R	06/08							41.10605	1000	Monster S2R	06/08		41.10636				
1000	Multistrada, DS	03/06							41.10605	1000	Multistrada, DS	03/06		41.10636				
1000	Paul Smart LE	06							41.10605	1000	Paul Smart LE	06		41.10636				
1000	GT	07/09							41.10605	1000	GT	07/09		41.10636				
1000	Sport S	07/09							41.10605	1000	Sport S	07/09		41.10636				
1098	1098 S	07/09							41.10605	1098	1098 S	07/09						
1100	Hypermotard	08/09							41.10605	1100	Hypermotard	08/09						
1100	Monster S	08/09							41.10605	1100	Monster S	08/09		41.10636				
1100	Multistrada	07/08							41.10605	1100	Multistrada	07/08		41.10636				

GAS GAS

50	EC Rookie	04/05	41.10005	41.10005						50	EC Rookie	04/05						
50	SM Rookie	04/05	41.10005	41.10005						50	SM Rookie	04/05						
65	MC Boy	06							41.10280	65	MC Boy	06						
125	EC 2T	01/02	41.10002						41.10279	125	EC 2T	01/02		41.10349	41.10432	41.10522		
125	EC 2T	03	41.10002	41.10063					41.10279	125	EC 2T	03		41.10349	41.10432	41.10522		
125	EC 2T	04/05	41.10006	41.10063					41.10279	125	EC 2T	04/05		41.10349	41.10432	41.10522		
125	EC 2T	06/11	41.10006	41.10063					41.10281	125	EC 2T	06/11		41.10349	41.10432	41.10522		
125	HALLEY 2T	09	41.10005						41.10279	125	HALLEY 2T	09		41.10349	41.10432	41.10522		
125	HALLEY 4T	09	41.10005	41.10005					41.10279	125	HALLEY 4T	09						
125	MC	01/02	41.10002						41.10279	125	MC	01/02		41.10349	41.10432	41.10522		
125	MC	03	41.10002	41.10063					41.10279	125	MC	03		41.10349	41.10432	41.10522		
125	MC	04/05	41.10006	41.10063					41.10279	125	MC	04/05		41.10349	41.10432	41.10522		

		A		B		C	D	E			F	G	H	I	L			
Applicazioni cc	marca/modello	anno	kit cuscinetti ruota ant.	kit cuscinetti ruota post.	kit distanziali ruota ant.	kit distanziali ruota post.	kit cuscinetti albero motore	kit tenuta albero secondario	kit cuscinetti e parapolvere sterzo	Applicazioni cc	marca/modello	anno	Kit paraolio e parapolvere forcella	Kit paraolio forcella	Kit cuscinetti forcellone	Kit revisione leveraggi	Kit cuscinetti mono inf.	Kit cuscinetti mono sup.
125	MC	06/09	41.10006	41.10063					41.10281	125	MC	06/09			41.10349	41.10432	41.10522	
125	Pampera	02/05	41.10005	41.10005					41.10280	125	Pampera	02/05						
125	SM	03/06	41.10002	41.10063					41.10279	125	SM	03/06			41.10349	41.10432	41.10522	
125	SM	07/09	41.10002	41.10063					41.10281	125	SM	07/09			41.10349	41.10432	41.10522	
125	TXT PRO	98/01							41.10617	125	TXT PRO	98/01						
125	TXT PRO	02/12							41.10280	125	TXT PRO	02/12						
200	EC 2T	99/02	41.10002						41.10279	200	EC 2T	99/02			41.10349	41.10432	41.10522	
200	EC 2T	03	41.10002	41.10063					41.10279	200	EC 2T	03			41.10349	41.10432	41.10522	
200	EC 2T	04/05	41.10006	41.10063					41.10279	200	EC 2T	04/05			41.10349	41.10432	41.10522	
200	EC 2T	06/11	41.10006	41.10063					41.10281	200	EC 2T	06/11			41.10349	41.10432	41.10522	
200	TXT PRO	98/01							41.10617	200	TXT PRO	98/01						
200	TXT PRO	02/09							41.10280	200	TXT PRO	02/09						
250	EC 2T	96/02	41.10002						41.10279	250	EC 2T	96/02			41.10349	41.10432	41.10522	
250	EC 2T	03	41.10002	41.10063					41.10279	250	EC 2T	03			41.10349	41.10432	41.10522	
250	EC 2T	04/05	41.10006	41.10063					41.10279	250	EC 2T	04/05			41.10349	41.10432	41.10522	
250	EC 2T	06/11	41.10006	41.10063					41.10281	250	EC 2T	06/11			41.10349	41.10432	41.10522	
250	EC 2T	12	41.10006	41.10063					41.10281	250	EC 2T	12						
250	EC / EC F 4T	10	41.10006	41.10063					41.10281	250	EC / EC F 4T	10	41.10310	41.10651	41.10349	41.10432	41.10522	
250	EC / EC F 4T	12	41.10006	41.10063					41.10281	250	EC / EC F 4T	12						
250	MC	99/02	41.10002						41.10279	250	MC	99/02			41.10349	41.10432	41.10522	
250	MC	03	41.10002	41.10063					41.10279	250	MC	03			41.10349	41.10432	41.10522	
250	MC	04/05	41.10006	41.10063					41.10279	250	MC	04/05			41.10349	41.10432	41.10522	
250	MC	06/09	41.10006	41.10063					41.10281	250	MC	06/09			41.10349	41.10432	41.10522	
250	Pampera	02/05	41.10005	41.10005					41.10280	250	Pampera	02/05						
250	SM	03/05	41.10002	41.10063					41.10279	250	SM	03/05			41.10349	41.10432	41.10522	
250	TXT PRO	98/01							41.10617	250	TXT PRO	98/01						
250	TXT PRO	02/12							41.10280	250	TXT PRO	02/12						
280	Pampera	02/05	41.10005	41.10005					41.10280	280	Pampera	02/05						
280	TXT PRO	98/01							41.10617	280	TXT PRO	98/01						
280	TXT PRO	02/12							41.10280	280	TXT PRO	02/12						
300	EC 2T	99/02	41.10002						41.10279	300	EC 2T	99/02			41.10349	41.10432	41.10522	
300	EC 2T	03	41.10002	41.10063					41.10279	300	EC 2T	03			41.10349	41.10432	41.10522	
300	EC 2T	04/05	41.10006	41.10063					41.10279	300	EC 2T	04/05			41.10349	41.10432	41.10522	
300	EC 2T	06/11	41.10006	41.10063					41.10281	300	EC 2T	06/11			41.10349	41.10432	41.10522	
300	EC 2T	12	41.10006	41.10063					41.10281	300	EC 2T	12						
300	TXT PRO	98/01							41.10617	300	TXT PRO	98/01						
300	TXT PRO	02/12							41.10280	300	TXT PRO	02/12						
450	FSE EC	03/05	41.10006	41.10063					41.10279	450	FSE EC	03/05			41.10349	41.10432	41.10522	
450	FSE SM	04/05	41.10006	41.10063					41.10279	450	FSE SM	04/05			41.10349	41.10432	41.10522	
450	FSE EC	06	41.10006	41.10063					41.10281	450	FSE EC	06			41.10349	41.10432	41.10522	
450	FSR EC	07/09	41.10006	41.10063					41.10281	450	FSR EC	07/09			41.10349	41.10432	41.10522	
450	FSR SM	07/09	41.10006	41.10063					41.10281	450	FSR SM	07/09			41.10349	41.10432	41.10522	
450	HALLEY EH	09	41.10003						41.10281	450	HALLEY EH	09	41.10310	41.10651	41.10349	41.10432	41.10522	
450	HALLEY SM	09	41.10003						41.10281	450	HALLEY SM	09	41.10310	41.10651	41.10349	41.10432	41.10522	
450	MC FSR	07	41.10006	41.10063					41.10281	450	MC FSR	07			41.10349	41.10432	41.10522	
450	Pampera	07	41.10006	41.10063					41.10279	450	Pampera	07			41.10349	41.10432	41.10522	

HONDA

50	CRF F	04/12							41.10282	50	CRF F	04/12						
50	CRM R	93/96							41.10282	50	CRM R	93/96			41.10625			
50	MT S	93/96							41.10282	50	MT S	93/96			41.10619			
50	XR R	00/03							41.10282	50	XR R	00/03						
50	Z	69/71	41.10010							50	Z	69/71						

Applicazioni		anno	A		B		C	D	E	Applicazioni		anno	F	G	H	I	L	
cc	marca/modello		kit cuscinetti ruota ant.	kit cuscinetti ruota post.	kit distanziali ruota ant.	kit distanziali ruota post.	kit cuscinetti albero motore	kit tenuta albero secondario	kit cuscinetti e parapolvere sterzo	cc	marca/modello		Kit paraolio e parapolvere forcella	Kit paraolio forcella	Kit cuscinetti forcellone	Kit revisione leveraggi	Kit cuscinetti mono inf.	Kit cuscinetti mono sup.
50	Z	72/78	41.10010					41.10282	50	Z	72/78							
50	Z R	79/93	41.10010					41.10282	50	Z R	79/93							
50	Z R	94/99	41.10010	41.10010				41.10282	50	Z R	94/99							
50	Z RD	86	41.10010					41.10282	50	Z RD	86							
60	CR R (DE01)	83						41.10282	60	CR R (DE01)	83							
70	CRF F	04/12						41.10282	70	CRF F	04/12		41.10619					
70	CT Trail	69/94						41.10282	70	CT Trail	69/94							
70	SL	71/73						41.10282	70	SL	71/73		41.10619					
70	XL	76						41.10282	70	XL	76		41.10619					
70	XR R (V)	97/03						41.10282	70	XR R (V)	97/03		41.10619					
75	CRM	93/94						41.10282	75	CRM	93/94		41.10625					
75	NSR	93/00						41.10282	75	NSR	93/00							
75	XL	77/79						41.10282	75	XL	77/79		41.10619					
75	XR R (V)	77/78						41.10282	75	XR R (V)	77/78		41.10619					
80	CR RA	82						41.10282	80	CR RA	82		41.10622					
80	CR RA	83							80	CR RA	83		41.10622					
80	CR RA	84							80	CR RA	84		41.10624					
80	CR RA	80/81						41.10282	80	CR RA	80/81		41.10621					
80	CR RA	85/86							80	CR RA	85/86	41.10317	41.10624					
80	CR RA	87/95						41.10283	80	CR RA	87/95		41.10625					
80	CR RA	96/02						41.10283	80	CR RA	96/02	41.10318	41.10628					
80	CR RB	82						41.10282	80	CR RB	82		41.10622					
80	CR RB	83							80	CR RB	83		41.10622					
80	CR RB	84							80	CR RB	84		41.10624					
80	CR RB	80/81						41.10282	80	CR RB	80/81		41.10621					
80	CR RB	85/86							80	CR RB	85/86	41.10317	41.10624					
80	CR RB	87/95						41.10283	80	CR RB	87/95		41.10625					
80	CR RB	96/02						41.10283	80	CR RB	96/02	41.10318	41.10628					
80	CRF F	04/13						41.10282	80	CRF F	04/13		41.10619					
80	XL S	80/85						41.10282	80	XL S	80/85		41.10619					
80	XR	79/84						41.10282	80	XR	79/84		41.10619					
80	XR R	85/03						41.10282	80	XR R	85/03		41.10619					
85	CR R RA	03/07						41.10283	85	CR R RA	03/07	41.10318	41.10628					
85	CR R RB	03/07						41.10283	85	CR R RB	03/07	41.10318	41.10628					
90	CT Trail	66/79						41.10282	90	CT Trail	66/79							
90	EZ CUB	91/96							90	EZ CUB	91/96		41.10619					
100	CB	70/72						41.10282	100	CB	70/72							
100	CL	70/73						41.10282	100	CL	70/73							
100	CRF F	04/13						41.10282	100	CRF F	04/13		41.10619					
100	XL	76/80						41.10282	100	XL	76/80		41.10622					
100	XL S	79/80						41.10282	100	XL S	79/80		41.10622					
100	XL S	81/85						41.10282	100	XL S	81/85		41.10619					
100	XR	81/84						41.10282	100	XR	81/84		41.10619					
100	XR R	85/03						41.10282	100	XR R	85/03		41.10619					
110	CT Trail	80/86						41.10282	110	CT Trail	80/86							
110	NHX Lead	10							110	NHX Lead	10		41.10622					
125	CB S	76/85						41.10282	125	CB S	76/85		41.10619					
125	CB TT	90						41.10282	125	CB TT	90		41.10622					
125	CBR R (JC34/J39)	04/06						41.10282	125	CBR R (JC34/J39)	04/06		41.10622					
125	CR M	76						41.10282	125	CR M	76		41.10625					
125	CR M	74/78						41.10282	125	CR M	74/78							
125	CR R	81						41.10284	125	CR R	81		41.10629					
125	CR R	92						41.10285	125	CR R	92		41.10637					
125	CR R	93						41.10286	125	CR R	93		41.10637					
125	CR R	94						41.10286	125	CR R	94		41.10639					

Applicazioni cc marca/modello		anno	A		B		C	D	E	Applicazioni cc marca/modello		anno	F	G	H	I	L	
			kit cuscinetti ruota ant.	kit cuscinetti ruota post.	kit distanziali ruota ant.	kit distanziali ruota post.	kit cuscinetti albero motore	kit tenuta albero secondario	kit cuscinetti e parapolvere sterzo				Kit paraolio e parapolvere forcella	Kit paraolio forcella	Kit cuscinetti forcellone	Kit revisione leveraggi	Kit cuscinetti mono inf.	Kit cuscinetti mono sup.
125	CR R	95	41.10016						41.10287	125	CR R	95		41.10639				
125	CR R	96	41.10016						41.10287	125	CR R	96		41.10639				41.10567
125	CR R	97	41.10016						41.10287	125	CR R	97	41.10325	41.10642			41.10532	41.10567
125	CR R	02/03	41.10016	41.10071	41.10128	41.10174			41.10286	125	CR R	02/03	41.10325	41.10642		41.10446	41.10532	41.10567
125	CR R	04/07	41.10016	41.10071	41.10128	41.10174		41.10252	41.10286	125	CR R	04/07	41.10325	41.10642		41.10446	41.10532	41.10567
125	CR R	00/01	41.10016	41.10071		41.10174			41.10286	125	CR R	00/01	41.10325	41.10642			41.10532	41.10567
125	CR R	79/80							41.10284	125	CR R	79/80						
125	CR R	82/83							41.10283	125	CR R	82/83		41.10629				
125	CR R	84/86							41.10283	125	CR R	84/86		41.10638				
125	CR R	87/89							41.10283	125	CR R	87/89		41.10636				
125	CR R	90/91							41.10285	125	CR R	90/91		41.10640				
125	CR R	98/99	41.10016						41.10286	125	CR R	98/99	41.10325	41.10642			41.10532	41.10567
125	CRM R	93/99							41.10288	125	CRM R	93/99						
125	CT	77							41.10282	125	CT	77		41.10622				
125	MT Elsinore	74/76							41.10282	125	MT Elsinore	74/76		41.10622				
125	NS R/R II	93/99							41.10282	125	NS R/R II	93/99						
125	NX Transcity (JD12)	95/97							41.10288	125	NX Transcity (JD12)	95/97						
125	SL Moto Sport	71/73							41.10282	125	SL Moto Sport	71/73		41.10622				
125	TL	73/76							41.10282	125	TL	73/76		41.10622				
125	VT C Shadow	99/03							41.10595	125	VT C Shadow	99/03						
125	XL	74/77							41.10282	125	XL	74/77		41.10622				
125	XL	78/85							41.10282	125	XL	78/85						
125	XL R/R PARIS DAKAR/S/SD	98							41.10283	125	XL R/R PARIS DAKAR/S/SD	98	41.10318	41.10628	41.10589			
125	XLV Varadero	01/02							41.10595	125	XLV Varadero	01/02						
125	XR L (JD19A)	03/10							41.10283	125	XR L (JD19A)	03/10		41.10622				
125	XR L (LK/LEK)	11							41.10283	125	XR L (LK/LEK)	11		41.10622				
150	CRF F	03/05							41.10283	150	CRF F	03/05		41.10625				
150	CRF F	06/09							41.10283	150	CRF F	06/09		41.10625				
150	CRF F	12/13							41.10283	150	CRF F	12/13		41.10625				
150	CRF R	13							41.10283	150	CRF R	13	41.10318	41.10628				
150	CRF R	07/09							41.10283	150	CRF R	07/09	41.10318	41.10628				
160	CB	65/69							41.10615	160	CB	65/69						
160	CL	65/69							41.10615	160	CL	65/69						
175	CA	68/73							41.10615	175	CA	68/73						
175	CB	68/73							41.10615	175	CB	68/73						
175	CL	68/73							41.10615	175	CL	68/73						
175	MR Elsinore	76/77							41.10282	175	MR Elsinore	76/77		41.10622				
175	XL	73/78							41.10601	175	XL	73/78		41.10622				
185	CM T	78/79							41.10282	185	CM T	78/79		41.10622				
185	XL S	79/83							41.10282	185	XL S	79/83		41.10622				
185	XR	79							41.10282	185	XR	79		41.10622				
200	CB	76							41.10615	200	CB	76		41.10622				
200	CB	74/75							41.10615	200	CB	74/75						
200	CL	76							41.10615	200	CL	76		41.10622				
200	CL	74/75							41.10615	200	CL	74/75						
200	CL Scrambler	76							41.10282	200	CL Scrambler	76		41.10622				
200	CM T Twinstar	80/82							41.10282	200	CM T Twinstar	80/82		41.10622				
200	CTX	03/11							41.10283	200	CTX	03/11	41.10318	41.10628				
200	TLR Reflex	86/87							41.10601	200	TLR Reflex	86/87	41.10317	41.10624				
200	TR Fatcat	86/87							41.10601	200	TR Fatcat	86/87		41.10622				
200	XL R / Paris Dakar (MD06)	83/84							41.10283	200	XL R / Paris Dakar (MD06)	83/84	41.10317	41.10624				
200	XR	80/84							41.10282	200	XR	80/84		41.10625				
200	XR R	81/83							41.10283	200	XR R	81/83						
200	XR R	84/87							41.10283	200	XR R	84/87		41.10626				
200	XR R	88/02							41.10283	200	XR R	88/02		41.10626	41.10589			

Applicazioni cc marca/modello	anno	A		B		C	D	E	Applicazioni cc marca/modello	anno	F	G	H	I	L	
		kit cuscinetti ruota ant.	kit cuscinetti ruota post.	kit distanziali ruota ant.	kit distanziali ruota post.	kit cuscinetti albero motore	kit tenuta albero secondario	kit cuscinetti e parapolvere sterzo							Kit paraolio e parapolvere forcella	Kit paraolio forcella
500 CX (B)	79							41.10595	500 CX (B)	79		41.10624				
500 CX C (PC01)	79/80							41.10595	500 CX C (PC01)	79/80		41.10624				
500 CX C (PC01)	81/82							41.10595	500 CX C (PC01)	81/82		41.10625				
500 CX D	89/91							41.10595	500 CX D	89/91		41.10624				
500 CX T Turbo (PC03)	82							41.10599	500 CX T Turbo (PC03)	82	41.10318	41.10628				
500 FT Ascot (PC07)	82/83							41.10595	500 FT Ascot (PC07)	82/83		41.10628				
500 GB TT K Clubman	89/90							41.10595	500 GB TT K Clubman	89/90		41.10625				
500 GL Silver Wing (PC02)	81/82							41.10595	500 GL Silver Wing (PC02)	81/82		41.10625				
500 NX Dominator	93/99							41.10283	500 NX Dominator	93/99		41.10635				
500 VF C V30 Magna (PC13)	84/85							41.10599	500 VF C V30 Magna (PC13)	84/85		41.10628				
500 VF F Interceptor (PC12)	84/86							41.10599	500 VF F Interceptor (PC12)	84/86		41.10628				
500 VT C Shadow (PC08)	83/84							41.10595	500 VT C Shadow (PC08)	83/84		41.10628				
500 VT C Shadow (PC08)	85/86							41.10599	500 VT C Shadow (PC08)	85/86						
500 VT FT (PC10)	83/84							41.10595	500 VT FT (PC10)	83/84		41.10628				
500 XL R (PD02)	82							41.10283	500 XL R (PD02)	82	41.10318	41.10628				
500 XL S (PD01)	79/81							41.10601	500 XL S (PD01)	79/81		41.10625				
500 XR R (PE01/PE03)	79/80							41.10601	500 XR R (PE01/PE03)	79/80		41.10625				
500 XR R (PE01/PE03)	81/82							41.10283	500 XR R (PE01/PE03)	81/82	41.10318	41.10628				
500 XR R (PE01/PE03)	83/84							41.10283	500 XR R (PE01/PE03)	83/84		41.10636				
550 CB (K/K1/K2/K3/K4)	74/78							41.10595	550 CB (K/K1/K2/K3/K4)	74/78		41.10625				
550 CB F Four	75/77							41.10595	550 CB F Four	75/77		41.10625				
550 CB SC	83							41.10595	550 CB SC	83		41.10628				
600 CB F Hornet (PC34)	98/02							41.10599	600 CB F Hornet (PC34)	98/02		41.10635				
600 CB F Hornet (PC36)	03/06							41.10599	600 CB F Hornet (PC36)	03/06		41.10635				
600 CB F Hornet (PC41)	07/08							41.10599	600 CB F Hornet (PC41)	07/08		41.10635				
600 CB F Hornet Abs (PC41)	07/08							41.10599	600 CB F Hornet Abs (PC41)	07/08		41.10635				
600 CB F Hornet S (PC34)	00/02							41.10599	600 CB F Hornet S (PC34)	00/02		41.10635				
600 CB F Hornet S (PC36)	03/06							41.10599	600 CB F Hornet S (PC36)	03/06		41.10635				
600 CBF N (PC38/PC43)	04/06							41.10599	600 CBF N (PC38/PC43)	04/06		41.10635				
600 CBF N ABS (PC38/PC43)	04/06							41.10599	600 CBF N ABS (PC38/PC43)	04/06		41.10635				
600 CBR F (PC19/PC23)	87/90							41.10599	600 CBR F (PC19/PC23)	87/90	41.10318	41.10628				
600 CBR F (PC25)	91/94							41.10599	600 CBR F (PC25)	91/94		41.10635				
600 CBR F (PC31)	95/98							41.10599	600 CBR F (PC31)	95/98		41.10635				
600 CBR F (PC35)	99/06							41.10599	600 CBR F (PC35)	99/06		41.10636				
600 CBR RR (PC37)	03/04							41.10599	600 CBR RR (PC37)	03/04		41.10640				
600 CBR RR (PC37)	05/06							41.10599	600 CBR RR (PC37)	05/06		41.10635				
600 CBR RR / ABS (PC40)	07/12							41.10599	600 CBR RR / ABS (PC40)	07/12		41.10635				
600 FJS Silver Wing ABS (PF01)	03/09							41.10603	600 FJS Silver Wing ABS (PF01)	03/09		41.10634				
600 NTV Revere	88/91							41.10599	600 NTV Revere	88/91		41.10635				
600 VT C Shadow /CD Shadow (PC21)	88/07							41.10599	600 VT C Shadow /CD Shadow (PC21)	88/07						
600 XL R / Paris Dakar (PD03)	83/87							41.10283	600 XL R / Paris Dakar (PD03)	83/87		41.10630				
600 XL V Transalp (PD06/PD10)	87/99							41.10283	600 XL V Transalp (PD06/PD10)	87/99		41.10635				
600 XR R (PE04)	85/00		41.10588					41.10283	600 XR R (PE04)	85/00		41.10636				
650 CB SC Nighthawk (RC08/RC130)	83/85							41.10595	650 CB SC Nighthawk (RC08/RC130)	83/85		41.10630				
650 CB Z,B (RC03)	79/82							41.10595	650 CB Z,B (RC03)	79/82		41.10625				
650 CX C (RC11)	83							41.10595	650 CX C (RC11)	83		41.10630				
650 CX Turbo (RC16)	83							41.10599	650 CX Turbo (RC16)	83	41.10318	41.10628				
650 FMX (RD12)	05/06							41.10283	650 FMX (RD12)	05/06						
650 FX Vigor (RD09)	99/00							41.10283	650 FX Vigor (RD09)	99/00		41.10635				
650 GL I Silver Wing Interstate (RC10)	83							41.10595	650 GL I Silver Wing Interstate (RC10)	83	41.10318	41.10628				
650 NT Hawk GT (RC312)	88/91							41.10599	650 NT Hawk GT (RC312)	88/91		41.10635				
650 NT V Deauville (RC47)	98/05							41.10599	650 NT V Deauville (RC47)	98/05		41.10635				
650 NTV Revere (RC33)	92/97							41.10599	650 NTV Revere (RC33)	92/97		41.10635				
650 NX Dominator (RD02/RD08)	88/99							41.10283	650 NX Dominator (RD02/RD08)	88/99		41.10635				
650 SLR (RD09)	97/98							41.10283	650 SLR (RD09)	97/98		41.10635				

Applicazioni cc		anno	A		B		C	D	E	Applicazioni cc		anno	F	G	H	I	L	
marca/modello	kit cuscinetti ruota ant.		kit cuscinetti ruota post.	kit distanziali ruota ant.	kit distanziali ruota post.	kit cuscinetti albero motore	kit tenuta albero secondario	kit cuscinetti e parapolvere sterzo	marca/modello	Kit paraolio e parapolvere forcella	Kit paraolio forcella		Kit cuscinetti forcellone	Kit revisione leveraggi	Kit cuscinetti mono inf.	Kit cuscinetti mono sup.		
310	TE	12/13	41.10028	41.10086					41.10293	310	TE	12/13	41.10331	41.10648	41.10380	41.10462	41.10540	
310	TXC Cross Country	12/13	41.10028	41.10086					41.10293	310	TXC Cross Country	12/13	41.10331	41.10648	41.10380	41.10462	41.10540	
350	TE	95							41.10291	350	TE	95						41.10539
350	WXC	92/93							41.10291	350	WXC	92/93						
350	WXC	94							41.10291	350	WXC	94						41.10539
350	WXE	91/93							41.10291	350	WXE	91/93						
350	WXE	94							41.10291	350	WXE	94						41.10539
360	CR	93							41.10291	360	CR	93						41.10539
360	WR	96								360	WR	96	41.10310	41.10651	41.10379			41.10539
360	WR	97								360	WR	97	41.10334	41.10646	41.10379			41.10539
360	WR	98							41.10291	360	WR	98	41.10334	41.10646	41.10379			41.10539
360	WR	99							41.10291	360	WR	99	41.10310	41.10651	41.10379			41.10539
360	WR	00/01		41.10086					41.10291	360	WR	00/01	41.10310	41.10651	41.10379			41.10539
360	WR	02		41.10086					41.10291	360	WR	02	41.10310	41.10651	41.10379	41.10460		41.10539
360	WXC	93							41.10291	360	WXC	93						41.10539
360	WXC	94/95							41.10291	360	WXC	94/95			41.10379			41.10539
360	WXE	93							41.10291	360	WXE	93						41.10539
360	WXE	94/95							41.10291	360	WXE	94/95			41.10379			41.10539
400	SM R	04		41.10086					41.10291	400	SM R	04	41.10310	41.10651	41.10379	41.10464		41.10539
400	TE	01		41.10086					41.10291	400	TE	01	41.10310	41.10651				
400	WR	88							41.10291	400	WR	88						
410	TE	96								410	TE	96	41.10310	41.10651				
410	TE	97/98								410	TE	97/98	41.10334	41.10646				
410	TE	99							41.10291	410	TE	99	41.10310	41.10651				
410	TE	00/01		41.10086					41.10291	410	TE	00/01	41.10310	41.10651				
410	TE E	99							41.10291	410	TE E	99						
430	CR	88							41.10291	430	CR	88						
430	WR	88							41.10291	430	WR	88						
430	XC	88							41.10291	430	XC	88						
450	SM R	10	41.10025	41.10086					41.10293	450	SM R	10	41.10331	41.10648	41.10380	41.10462	41.10540	
450	SM R	03		41.10086					41.10291	450	SM R	03	41.10310	41.10651	41.10379			41.10539
450	SM R	04		41.10086					41.10291	450	SM R	04	41.10310	41.10651	41.10379	41.10464		41.10539
450	SM R	05	41.10025	41.10086					41.10291	450	SM R	05	41.10310	41.10651	41.10379	41.10465		41.10539
450	SM R	06/07	41.10025	41.10086					41.10291	450	SM R	06/07	41.10334	41.10646	41.10379	41.10465		41.10539
450	SM R	08/09	41.10025	41.10086					41.10293	450	SM R	08/09	41.10334	41.10646	41.10380	41.10462		41.10540
450	TC	03	41.10025	41.10086					41.10293	450	TC	03	41.10310	41.10651	41.10379			41.10539
450	TC	04	41.10025	41.10086					41.10293	450	TC	04	41.10310	41.10651	41.10379	41.10464		41.10539
450	TC	05	41.10025	41.10086					41.10293	450	TC	05	41.10310	41.10651	41.10379	41.10465		41.10539
450	TC	06/07	41.10025	41.10086					41.10293	450	TC	06/07	41.10334	41.10646	41.10379	41.10465		41.10539
450	TC	08/09	41.10025	41.10086					41.10293	450	TC	08/09	41.10334	41.10646	41.10380	41.10462		41.10540
450	TC	10	41.10025	41.10086					41.10293	450	TC	10	41.10331	41.10648	41.10380	41.10462		41.10540
449	TC	11	41.10025	41.10086					41.10293	449	TC	11						
449	TC	12	41.10028	41.10086					41.10293	449	TC	12						
449	TC	13	41.10028	41.10086					41.10293	449	TC	13	41.10331	41.10648				
449	TE	11	41.10025	41.10086					41.10293	449	TE	11						
449	TE	12	41.10028	41.10086					41.10293	449	TE	12						
449	TE	13	41.10028	41.10086					41.10293	449	TE	13	41.10331	41.10648				
449	TXC Cross Country	11	41.10025	41.10086					41.10293	449	TXC Cross Country	11						
449	TXC Cross Country	12	41.10028	41.10086					41.10293	449	TXC Cross Country	12						
449	TXC Cross Country	13	41.10028	41.10086					41.10293	449	TXC Cross Country	13	41.10331	41.10648				
450	TE	03	41.10025	41.10086					41.10291	450	TE	03	41.10310	41.10651	41.10379			41.10539
450	TE	04	41.10025	41.10086					41.10291	450	TE	04	41.10310	41.10651	41.10379	41.10464		41.10539
450	TE	05	41.10025	41.10086					41.10291	450	TE	05	41.10310	41.10651	41.10379	41.10465		41.10539
450	TE	06/07	41.10025	41.10086					41.10291	450	TE	06/07	41.10334	41.10646	41.10379	41.10465		41.10539

Applicazioni cc marca/modello	anno	A		B		C	D	E	Applicazioni cc marca/modello	anno	F	G	H	I	L	
		kit cuscinetti ruota ant.	kit cuscinetti ruota post.	kit distanziali ruota ant.	kit distanziali ruota post.	kit cuscinetti albero motore	kit tenuta albero secondario	kit cuscinetti e parapolvere sterzo			Kit paraolio e parapolvere forcella	Kit paraolio forcella	Kit cuscinetti forcellone	Kit revisione leveraggi	Kit cuscinetti mono inf.	Kit cuscinetti mono sup.
450 TE	08/09	41.10025	41.10086					41.10293	450 TE	08/09	41.10334	41.10646	41.10380	41.10462	41.10540	
450 TE	10	41.10025	41.10086					41.10293	450 TE	10	41.10331	41.10648	41.10380	41.10462	41.10540	
450 TXC Cross Country	08/09	41.10025	41.10086					41.10293	450 TXC Cross Country	08/09	41.10334	41.10646	41.10380	41.10462	41.10540	
450 TXC Cross Country	10	41.10025	41.10086					41.10293	450 TXC Cross Country	10	41.10331	41.10648	41.10380	41.10462	41.10540	
510 SM R	10	41.10025	41.10086					41.10293	510 SM R	10	41.10331	41.10648	41.10380	41.10462	41.10540	
510 SM R	05	41.10025	41.10086					41.10291	510 SM R	05	41.10310	41.10651	41.10379	41.10465	41.10539	
510 SM R	06/07	41.10025	41.10086					41.10291	510 SM R	06/07	41.10334	41.10646	41.10379	41.10465	41.10539	
510 SM R	08/09	41.10025	41.10086					41.10293	510 SM R	08/09	41.10334	41.10646	41.10380	41.10462	41.10540	
510 TC	88							41.10291	510 TC	88						
510 TC	90							41.10291	510 TC	90						
510 TC	05	41.10025	41.10086					41.10293	510 TC	05	41.10310	41.10651	41.10379	41.10465	41.10539	
510 TC	06/07	41.10025	41.10086					41.10293	510 TC	06/07	41.10334	41.10646	41.10379	41.10465	41.10539	
510 TC	08/09	41.10025	41.10086					41.10293	510 TC	08/09	41.10334	41.10646	41.10380	41.10462	41.10540	
510 TE	88							41.10291	510 TE	88						
510 TE	90							41.10291	510 TE	90						
510 TE	04	41.10025	41.10086					41.10291	510 TE	04	41.10310	41.10651	41.10379	41.10464	41.10539	
510 TE	05	41.10025	41.10086					41.10291	510 TE	05	41.10310	41.10651	41.10379	41.10465	41.10539	
510 TE	06/07	41.10025	41.10086					41.10291	510 TE	06/07	41.10334	41.10646	41.10379	41.10465	41.10539	
510 TE	10	41.10025	41.10086					41.10293	510 TE	10	41.10331	41.10648	41.10380	41.10462	41.10540	
510 TX	88							41.10291	510 TX	88						
510 TXC Cross Country	08/09	41.10025	41.10086					41.10293	510 TXC Cross Country	08/09	41.10334	41.10646	41.10380	41.10462	41.10540	
510 TXC Cross Country	10	41.10025	41.10086					41.10293	510 TXC Cross Country	10	41.10331	41.10648	41.10380	41.10462	41.10540	
511 TE	12	41.10028	41.10086					41.10293	511 TE	12						
511 TE	13	41.10028	41.10086					41.10293	511 TE	13	41.10331	41.10648				
511 TXC Cross Country	12	41.10028	41.10086					41.10293	511 TXC Cross Country	12						
511 TXC Cross Country	13	41.10028	41.10086					41.10293	511 TXC Cross Country	13	41.10331	41.10648				
530 SM RR	09	41.10025	41.10086					41.10293	530 SM RR	09	41.10334	41.10646	41.10380	41.10462	41.10540	
570 SM R	01							41.10291	570 SM R	01	41.10310	41.10651				
570 SM R	02/04		41.10086					41.10291	570 SM R	02/04	41.10310	41.10651				
570 TC	01	41.10025						41.10293	570 TC	01	41.10310	41.10651				
570 TC	02	41.10025	41.10086					41.10293	570 TC	02	41.10310	41.10651				
570 TE	01							41.10291	570 TE	01	41.10310	41.10651				
570 TE	02/04		41.10086					41.10291	570 TE	02/04	41.10310	41.10651				
610 SM S	00/01		41.10086					41.10291	610 SM S	00/01	41.10310	41.10651				
610 SM S	06/07	41.10025	41.10086					41.10291	610 SM S	06/07	41.10310	41.10651				
610 SM S	08	41.10025	41.10086					41.10293	610 SM S	08	41.10310	41.10651				
610 SM	99/01								610 SM	99/01	41.10310	41.10651				
610 TC	96/97								610 TC	96/97	41.10334	41.10646				
610 TC	98							41.10291	610 TC	98	41.10334	41.10646				
610 TC	99							41.10293	610 TC	99	41.10310	41.10651				
610 TC	00		41.10086					41.10293	610 TC	00	41.10310	41.10651				
610 TC	01	41.10025	41.10086						610 TC	01	41.10310	41.10651				
610 TE	98							41.10291	610 TE	98	41.10334	41.10646				
610 TE	99							41.10291	610 TE	99	41.10310	41.10651				
610 TE	00/01		41.10086					41.10291	610 TE	00/01	41.10310	41.10651				
610 TE	02/03								610 TE	02/03	41.10310	41.10651				
610 TE	06/07	41.10025	41.10086					41.10291	610 TE	06/07	41.10310	41.10651				
610 TE	08	41.10025	41.10086					41.10293	610 TE	08	41.10310	41.10651				
610 TE E	98							41.10291	610 TE E	98	41.10334	41.10646				
610 TE E	99							41.10291	610 TE E	99	41.10310	41.10651				
610 TE E	00/01		41.10086					41.10291	610 TE E	00/01	41.10310	41.10651				
610 TE E	02/03								610 TE E	02/03	41.10310	41.10651				
610 TE E	06/07	41.10025	41.10086					41.10291	610 TE E	06/07	41.10310	41.10651				
610 TE E	08	41.10025	41.10086					41.10293	610 TE E	08	41.10310	41.10651				

		A		B		C	D	E			F	G	H	I	L			
<i>Applicazioni cc</i>	<i>marca/modello</i>	<i>anno</i>	<i>kit cuscinetti ruota ant.</i>	<i>kit cuscinetti ruota post.</i>	<i>kit distanziali ruota ant.</i>	<i>kit distanziali ruota post.</i>	<i>kit cuscinetti albero motore</i>	<i>kit tenuta albero secondario</i>	<i>kit cuscinetti e parapolvere sterzo</i>	<i>Applicazioni cc</i>	<i>marca/modello</i>	<i>anno</i>	<i>Kit paraolio e parapolvere forcella</i>	<i>Kit paraolio forcella</i>	<i>Kit cuscinetti forcellone</i>	<i>Kit revisione leveraggi</i>	<i>Kit cuscinetti mono inf.</i>	<i>Kit cuscinetti mono sup.</i>
610	WXC	93							41.10291	610	WXC	93						
610	WXC	94/95							41.10291	610	WXC	94/95					41.10539	
610	WXE	93							41.10291	610	WXE	93						
610	WXE	94/95							41.10291	610	WXE	94/95					41.10539	
610	WXE	91							41.10291	610	WXE	91						
610	WMX	91							41.10291	610	WMX	91						
630	SMS	10/13	41.10025	41.10086					41.10293	630	SMS	10/13	41.10310	41.10651		41.10464		
630	TE	10/13	41.10025	41.10086					41.10293	630	TE	10/13	41.10310	41.10651		41.10464		

HYOSUNG

250	GT Comet	04/05							41.10299	250	GT Comet	04/05						
250	GT Comet R	06/09							41.10299	250	GT Comet R	06/09						
250	GV Aquila	04/09							41.10299	250	GV Aquila	04/09						
650	GT Comet	04/07							41.10299	650	GT Comet	04/07						
650	GT Comet R /R TTC	05/08							41.10299	650	GT Comet R /R TTC	05/08						
650	GV Aquila	05/08							41.10299	650	GV Aquila	05/08						

KAWASAKI

60	KX	83/03		41.10032				41.10217	41.10256	41.10294	60	KX	83/03		41.10621	41.10381			
65	KX	02/04	41.10032	41.10032	41.10135	41.10180	41.10217	41.10256	41.10288	41.10288	65	KX	02/04	41.10317	41.10624	41.10381	41.10468	41.10541	
65	KX	05/13	41.10032	41.10032	41.10135	41.10180	41.10217	41.10257	41.10288	41.10288	65	KX	05/13	41.10317	41.10624	41.10381	41.10468	41.10541	
65	KX	00/01	41.10032	41.10032	41.10135	41.10180	41.10217	41.10256	41.10288	41.10288	65	KX	00/01	41.10317	41.10624	41.10381		41.10541	
80	KD	75/90								41.10294	80	KD	75/90		41.10619				
80	KDX	80/81									80	KDX	80/81		41.10621				
80	KDX	82/83						41.10217			80	KDX	82/83		41.10621				
80	KDX	84/88		41.10032				41.10217			80	KDX	84/88		41.10621	41.10381			
80	KX RA	81						41.10217			80	KX RA	81		41.10621				
80	KX RA	82						41.10217			80	KX RA	82						
80	KX RA	83		41.10032				41.10217	41.10256		80	KX RA	83		41.10624	41.10381			
80	KX RA	91						41.10217	41.10256	41.10288	80	KX RA	91		41.10625	41.10381		41.10542	
80	KX RA	79/80									80	KX RA	79/80		41.10621				
80	KX RA	84/85		41.10032				41.10217	41.10256		80	KX RA	84/85		41.10623	41.10381			
80	KX RA	86/90						41.10217	41.10256	41.10288	80	KX RA	86/90		41.10625	41.10381			
80	KX RA	92/97						41.10217	41.10256	41.10288	80	KX RA	92/97		41.10629	41.10381		41.10542	
80	KX RA	98/00	41.10032	41.10091	41.10136	41.10183	41.10217	41.10256	41.10288	41.10288	80	KX RA	98/00	41.10338	41.10627	41.10381	41.10471	41.10541	41.10542
80	KX RB	81						41.10217			80	KX RB	81		41.10621				
80	KX RB	82						41.10217			80	KX RB	82						
80	KX RB	83		41.10032				41.10217	41.10256		80	KX RB	83		41.10624	41.10381			
80	KX RB	91						41.10217	41.10256	41.10288	80	KX RB	91		41.10625	41.10381		41.10542	
80	KX RB	79/80									80	KX RB	79/80		41.10621				
80	KX RB	84/85		41.10032				41.10217	41.10256		80	KX RB	84/85		41.10623	41.10381			
80	KX RB	86/90						41.10217	41.10256	41.10288	80	KX RB	86/90		41.10625	41.10381			
80	KX RB	92/97						41.10217	41.10256	41.10288	80	KX RB	92/97		41.10629	41.10381		41.10542	
80	KX RB	98/00	41.10032	41.10091	41.10136	41.10183	41.10217	41.10256	41.10288	41.10288	80	KX RB	98/00	41.10338	41.10627	41.10381	41.10471	41.10541	41.10542
85	KX RA	01/04	41.10032	41.10091	41.10136	41.10183	41.10217	41.10256	41.10288	41.10288	85	KX RA	01/04	41.10338	41.10627	41.10381	41.10471	41.10541	41.10542
85	KX RA	05/13	41.10032	41.10091	41.10136	41.10183	41.10217	41.10257	41.10288	41.10288	85	KX RA	05/13	41.10338	41.10627	41.10381	41.10471	41.10541	41.10542
85	KX RB	01/04	41.10032	41.10091	41.10136	41.10183	41.10217	41.10256	41.10288	41.10288	85	KX RB	01/04	41.10338	41.10627	41.10381	41.10471	41.10541	41.10542
85	KX RB	05/13	41.10032	41.10091	41.10136	41.10183	41.10217	41.10257	41.10288	41.10288	85	KX RB	05/13	41.10338	41.10627	41.10381	41.10471	41.10541	41.10542
100	KD	76/79								41.10294	100	KD	76/79		41.10619				
100	KE	76/01								41.10294	100	KE	76/01		41.10620				
100	KM	76/81								41.10294	100	KM	76/81		41.10619				
100	KX	97			41.10136	41.10183	41.10217	41.10256	41.10288	41.10288	100	KX	97	41.10338	41.10627	41.10381		41.10542	
100	KX	05/13	41.10032	41.10091	41.10136	41.10183	41.10217	41.10257	41.10288	41.10288	100	KX	05/13	41.10338	41.10627	41.10381	41.10471	41.10541	41.10542

Applicazioni		A							B		C		D		E		F		G		H		I		L	
cc	marca/modello	anno	kit cuscinetti ruota ant.	kit cuscinetti ruota post.	kit distanziali ruota ant.	kit distanziali ruota post.	kit cuscinetti albero motore	kit tenuta albero secondario	kit cuscinetti e parapolvere sterzo	Applicazioni cc	marca/modello	anno	Kit paraolio e parapolvere forcella	Kit paraolio forcella	Kit cuscinetti forcellone	Kit revisione leveraggi	Kit cuscinetti mono inf.	Kit cuscinetti mono sup.								
250	KX	03	41.10003	41.10045		41.10187	41.10223	41.10259	41.10297	250	KX	03	41.10331	41.10648	41.10390		41.10541	41.10542								
250	KX	78							41.10288	250	KX	78		41.10626												
250	KX	79							41.10296	250	KX	79		41.10626												
250	KX	88							41.10296	250	KX	88		41.10639												
250	KX	89							41.10296	250	KX	89		41.10641			41.10542	41.10542								
250	KX	90							41.10296	250	KX	90		41.10634			41.10542	41.10542								
250	KX	91						41.10259	41.10296	250	KX	91		41.10639			41.10542	41.10542								
250	KX	92							41.10297	250	KX	92		41.10639			41.10542	41.10542								
250	KX	98	41.10003						41.10297	250	KX	98	41.10325	41.10642			41.10541	41.10542								
250	KX	04/05	41.10003	41.10045	41.10140	41.10187	41.10223	41.10259	41.10297	250	KX	04/05	41.10331	41.10648	41.10390	41.10482	41.10541	41.10542								
250	KX	06/07	41.10003	41.10045	41.10142	41.10187	41.10223	41.10259	41.10297	250	KX	06/07	41.10331	41.10648	41.10390	41.10482	41.10541	41.10542								
250	KX	74/76							41.10288	250	KX	74/76		41.10626												
250	KX	80/81							41.10296	250	KX	80/81		41.10629												
250	KX	82/84		41.10093					41.10296	250	KX	82/84		41.10638												
250	KX	85/87							41.10296	250	KX	85/87		41.10638												
250	KX	93/95	41.10003						41.10297	250	KX	93/95		41.10639			41.10542	41.10542								
250	KX	96/97	41.10003						41.10297	250	KX	96/97	41.10325	41.10642			41.10542	41.10542								
250	KX	99/01	41.10003						41.10297	250	KX	99/01	41.10325	41.10642	41.10390		41.10541	41.10542								
250	KX F	13	41.10003	41.10045	41.10142				41.10261	41.10297	250	KX F	13		41.10392	41.10485	41.10541	41.10542								
250	KX F	04/05	41.10003	41.10045	41.10140	41.10187	41.10224	41.10260	41.10297	250	KX F	04/05	41.10331	41.10648	41.10391	41.10482	41.10541	41.10542								
250	KX F	06/12	41.10003	41.10045	41.10142	41.10187			41.10261	41.10297	250	KX F	06/12	41.10330	41.10643	41.10392	41.10485	41.10541	41.10542							
250	KXE	06/07	41.10003	41.10045	41.10142	41.10187	41.10223	41.10259	41.10297	250	KXE	06/07	41.10331	41.10648	41.10390	41.10482	41.10541	41.10542								
250	S1 A/B/C Mach I (KH250A5)	73/75							41.10596	250	S1 A/B/C Mach I (KH250A5)	73/75														
300	KLX R (LX300A)	97/07							41.10296	300	KLX R (LX300A)	97/07		41.10639			41.10542									
305	GPZ (EX305A)	83							41.10596	305	GPZ (EX305A)	83		41.10622												
305	KZ CSR (KZ305B1)	81/82							41.10596	305	KZ CSR (KZ305B1)	81/82		41.10624												
305	KZ CSR (KZ305B1)	87/88							41.10596	305	KZ CSR (KZ305B1)	87/88		41.10624												
350	S2 Mach 2 (S2/S2A)	72/73							41.10596	350	S2 Mach 2 (S2/S2A)	72/73														
400	KDX	79/80							41.10288	400	KDX	79/80		41.10629												
400	KH (A3/A4/A5)	74/78							41.10596	400	KH (A3/A4/A5)	74/78														
400	KLX R	03	41.10003						41.10298	400	KLX R	03		41.10645	41.10393											
400	KX	75/76							41.10288	400	KX	75/76		41.10626												
400	Z (KZ)	74							41.10596	400	Z (KZ)	74		41.10624												
400	Z (KZ400A1/A2)	77/78							41.10596	400	Z (KZ400A1/A2)	77/78		41.10624												
400	Z (KZ400B1/B2)	78/79							41.10596	400	Z (KZ400B1/B2)	78/79		41.10624												
400	Z (KZ400C1)	78							41.10596	400	Z (KZ400C1)	78		41.10624												
400	Z (KZ400D1/D2)	74/75							41.10596	400	Z (KZ400D1/D2)	74/75		41.10624												
400	Z (KZ400D3/D4)	76/77							41.10596	400	Z (KZ400D3/D4)	76/77		41.10624												
400	Z (KZ400S/S2/S3 Special)	75/77							41.10596	400	Z (KZ400S/S2/S3 Special)	75/77		41.10624												
400	Z LTD (KZ400H1)	79							41.10596	400	Z LTD (KZ400H1)	79		41.10624												
400	ZXR/ZX4R Ninja (ZX400J/L/M)	91/03							41.10605	400	ZXR/ZX4R Ninja (ZX400J/L/M)	91/03														
420	KDX	81							41.10296	420	KDX	81		41.10629												
420	KX	80/81							41.10296	420	KX	80/81		41.10629												
440	Z (KZ440B1/B2)	80/81							41.10596	440	Z (KZ440B1/B2)	80/81		41.10624												
440	Z LTD (KZ440LTD A1/A2/A3/A4/A5)	80/83							41.10596	440	Z LTD (KZ440LTD A1/A2/A3/A4/A5)	80/83		41.10624												
440	Z LTD Belt (KZ440LTD Belt D1/D2/D3/D4/D5/D6)	80/83							41.10596	440	Z LTD Belt (KZ440LTD Belt D1/D2/D3/D4/D5/D6)	80/83		41.10624												
440	Z Sport Belt (KZ440 Sport Belt G1)	82							41.10596	440	Z Sport Belt (KZ440 Sport Belt G1)	82		41.10624												
450	EN 454 LTD (EN450A1/A6)	85/90							41.10594	450	EN 454 LTD (EN450A1/A6)	85/90		41.10626												
450	KDX	82							41.10296	450	KDX	82		41.10629												
450	KLX R	08/09	41.10003	41.10045		41.10187			41.10262	41.10297	450	KLX R	08/09	41.10331	41.10648	41.10392	41.10485	41.10541	41.10542							
450	KX F	06/12	41.10003	41.10045	41.10142	41.10187			41.10262	41.10297	450	KX F	06/12	41.10331	41.10648	41.10392	41.10485	41.10541	41.10542							
450	KX F	13/14	41.10003	41.10045	41.10142				41.10262	41.10297	450	KX F	13/14			41.10392	41.10485	41.10541	41.10542							
500	EN Vulcan (EN500)	90/95							41.10594	500	EN Vulcan (EN500)	90/95		41.10626												
500	EN Vulcan (EN500)	96/09							41.10594	500	EN Vulcan (EN500)	96/09		41.10634												

ALL BALLS

ALL BALLS

Applicazioni cc	marca/modello	anno	A		B		C	D	E	Applicazioni cc	marca/modello	anno	F	G	H	I	L	
			kit cuscinetti ruota ant.	kit cuscinetti ruota post.	kit distanziali ruota ant.	kit distanziali ruota post.	kit cuscinetti albero motore	kit tenuta albero secondario	kit cuscinetti e parapolvere sterzo				Kit paraolio e parapolvere forcilla	Kit paraolio forcilla	Kit cuscinetti forcellone	Kit revisione leveraggi	Kit cuscinetti mono inf.	Kit cuscinetti mono sup.
500	ER5 (ER500 A1/A4-C1/C5)	97/06							41.10597	500	ER5 (ER500 A1/A4-C1/C5)	97/06	41.10318	41.10628				
500	GPZ S (EX500A/D)	87/93							41.10597	500	GPZ S (EX500A/D)	87/93		41.10626				
500	GPZ S (EX500A/D)	94/09							41.10597	500	GPZ S (EX500A/D)	94/09	41.10318	41.10628				
500	KH 500	69/72							41.10596	500	KH 500	69/72						
500	KH 500	73/74							41.10596	500	KH 500	73/74		41.10626				
500	KLE (LE500A)	03/06							41.10594	500	KLE (LE500A)	03/06						
500	KX	88							41.10296	500	KX	88		41.10639				
500	KX	89							41.10296	500	KX	89		41.10641			41.10542	41.10542
500	KX	90							41.10296	500	KX	90		41.10634			41.10542	41.10542
500	KX	83/84		41.10093					41.10296	500	KX	83/84		41.10638				
500	KX	85/87							41.10296	500	KX	85/87		41.10638				
500	KX	91/93							41.10296	500	KX	91/93		41.10639			41.10542	41.10542
500	KX	94/96	41.10003						41.10296	500	KX	94/96		41.10639			41.10542	41.10542
500	KX	97/04	41.10003						41.10296	500	KX	97/04	41.10325	41.10642			41.10542	41.10542
550	GPZ (KZ550GPD1/H1/H2)	81							41.10597	550	GPZ (KZ550GPD1/H1/H2)	81		41.10626				
550	GPZ (KZ550GPD1/H1/H2)	82/83							41.10594	550	GPZ (KZ550GPD1/H1/H2)	82/83		41.10625				
550	GPZ (ZX550A1/A6)	84/86							41.10594	550	GPZ (ZX550A1/A6)	84/86		41.10625				
550	Z (KZ550 Standard A1/A4)	80/83							41.10597	550	Z (KZ550 Standard A1/A4)	80/83		41.10626				
550	Z F (KZ550F1 Spectre)	83/84							41.10594	550	Z F (KZ550F1 Spectre)	83/84	41.10338	41.10627				
550	Z LTD (KZ550LTD C1/C2/C3/C4)	80/83							41.10597	550	Z LTD (KZ550LTD C1/C2/C3/C4)	80/83		41.10626				
550	Z LTD Shaft (KZ550LTD Shaft M1/F2)	83							41.10594	550	Z LTD Shaft (KZ550LTD Shaft M1/F2)	83	41.10338	41.10627				
550	ZR Zephyr (ZR550B1/B9)	90/93							41.10594	550	ZR Zephyr (ZR550B1/B9)	90/93						
600	GPX R Ninja (ZX600C1/C10)	88/94							41.10594	600	GPX R Ninja (ZX600C1/C10)	88/94		41.10652				
600	GPZ R Ninja (ZXA1/A3,B1)	85/87							41.10594	600	GPZ R Ninja (ZXA1/A3,B1)	85/87						
600	KLR (KL600A)	84/86							41.10594	600	KLR (KL600A)	84/86		41.10629				
600	ZL Eliminator (ZL600A/B)	86/87							41.10594	600	ZL Eliminator (ZL600A/B)	86/87						
600	ZL Eliminator (ZL600A/B)	96/97							41.10594	600	ZL Eliminator (ZL600A/B)	96/97						
600	ZX6R Ninja (ZX600F1/F2/F3/G1/G2/J1P/J2P)	05	41.10079						41.10605	600	ZX6R Ninja (ZX600F1/F2/F3/G1/G2/J1P/J2P)	05		41.10635				
600	ZX6R Ninja (ZX600F1/F2/F3/G1/G2/J1P/J2P)	03/04	41.10079						41.10605	600	ZX6R Ninja (ZX600F1/F2/F3/G1/G2/J1P/J2P)	03/04		41.10634				
600	ZX6R Ninja (ZX600F1/F2/F3/G1/G2/J1P/J2P)	95/97							41.10594	600	ZX6R Ninja (ZX600F1/F2/F3/G1/G2/J1P/J2P)	95/97		41.10634				
600	ZX6R Ninja (ZX600F1/F2/F3/G1/G2/J1P/J2P)	98/02	41.10079						41.10604	600	ZX6R Ninja (ZX600F1/F2/F3/G1/G2/J1P/J2P)	98/02		41.10641				
600	ZX6R Ninja (ZX600P7F/P8F/R9F/RAF/RBF/RCF)	07/12	41.10079						41.10605	600	ZX6R Ninja (ZX600P7F/P8F/R9F/RAF/RBF/RCF)	07/12		41.10635				
600	ZX6RR Ninja (ZX600K1H/M1H/N1H)	03/04	41.10079						41.10605	600	ZX6RR Ninja (ZX600K1H/M1H/N1H)	03/04		41.10634				
600	ZX6RR Ninja (ZX600K1H/M1H/N1H)	05/06	41.10079						41.10605	600	ZX6RR Ninja (ZX600K1H/M1H/N1H)	05/06		41.10635				
600	ZZR Ninja (ZX600D/E)	03/04							41.10594	600	ZZR Ninja (ZX600D/E)	03/04		41.10635				
600	ZZR Ninja (ZX600D/E)	05/08	41.10079						41.10604	600	ZZR Ninja (ZX600D/E)	05/08		41.10641				
600	ZZR Ninja (ZX600D/E)	90/02							41.10594	600	ZZR Ninja (ZX600D/E)	90/02		41.10635				
636	ZX6R Ninja (ZX636A1P/B1H/B2H/C1H/C6F)	03/04	41.10079						41.10605	636	ZX6R Ninja (ZX636A1P/B1H/B2H/C1H/C6F)	03/04		41.10634				
636	ZX6R Ninja (ZX636A1P/B1H/B2H/C1H/C6F)	05/06	41.10079						41.10605	636	ZX6R Ninja (ZX636A1P/B1H/B2H/C1H/C6F)	05/06		41.10635				
650	ER6 F (EX650A6F,A7F)	06/13							41.10605	650	ER6 F (EX650A6F,A7F)	06/13		41.10634				
650	ER6 N	09/13							41.10605	650	ER6 N	09/13		41.10634				
650	KL Tengai (KL650B)	90/91							41.10594	650	KL Tengai (KL650B)	90/91		41.10629				
650	KLE Versys ABS (B7F/B8F/B9F/DAF/DBF/DCF)	07/12							41.10605	650	KLE Versys ABS (B7F/B8F/B9F/DAF/DBF/DCF)	07/12						
650	KLR (KL650A1/A5-KL650C)	87/05							41.10594	650	KLR (KL650A1/A5-KL650C)	87/05		41.10629				
650	KLR (KL650A6F/A7F) USA	06/07							41.10594	650	KLR (KL650A6F/A7F) USA	06/07		41.10629				
650	KLR (KL650EBF/ECF/EDF) USA	08/13							41.10594	650	KLR (KL650EBF/ECF/EDF) USA	08/13		41.10634				
650	KLX R (KLX650D)	93/96							41.10296	650	KLX R (KLX650D)	93/96		41.10639				
650	KLX S (KLX650C)	93/95							41.10296	650	KLX S (KLX650C)	93/95		41.10639				
650	W (EJ650A/E4/0010)	00/01							41.10594	650	W (EJ650A/E4/0010)	00/01						
650	Z (KZ650B1/B3)	77/79							41.10597	650	Z (KZ650B1/B3)	77/79		41.10626				
650	Z (KZ650E1/F1)	80							41.10597	650	Z (KZ650E1/F1)	80		41.10626				
650	Z CSR (KZ650CSR H1/H2/H3)	81/83							41.10597	650	Z CSR (KZ650CSR H1/H2/H3)	81/83		41.10627				
650	Z Custom (KZ650C1/C3)	77/79							41.10597	650	Z Custom (KZ650C1/C3)	77/79		41.10626				
650	Z LTD (KZ650E1)	80							41.10597	650	Z LTD (KZ650E1)	80		41.10626				

ALL BALLS

ALL BALLS

Applicazioni cc marca/modello		A		B		C	D	E	Applicazioni cc marca/modello		F	G	H	I	L
anno	kit cuscinetti ruota ant.	kit cuscinetti ruota post.	kit distanziali ruota ant.	kit distanziali ruota post.	kit cuscinetti albero motore	kit tenuta albero secondario	kit cuscinetti e parapolvere sterzo	anno	Kit paraolio e parapolvere forcella	Kit paraolio forcella	Kit cuscinetti forcellone	Kit revisione leveraggi	Kit cuscinetti mono inf.	Kit cuscinetti mono sup.	
650	Z SR (KZ650D1/D2)							78/79							
700	KZ (KZ700A)							84							
700	VN Vulcan							85							
700	ZN LTD (Shaft) (ZN)							84/85							
750	GPX R (ZX750F/E396)							90							
750	GPX R (ZX750F/E396)							87/89							
750	GPZ (KZ750R1)							82							
750	GPZ (ZX750A1/A5)							83/85							
750	GPZ Turbo (ZX750E)							84/85							
750	KH H2							72/75							
750	KZ (KZ750B1/B2/B3/B4)							76/79							
750	KZ (KZ750E1/E2/E3)							80/83							
750	KZ (KZ750L3/L4)							83							
750	KZ CSR Twin (KZ750M1)							82							
750	KZ LTD (KZ750H1/H2/H3/H4)							80/83							
750	KZ LTD Belt (KZ750K1/K2)							83/84							
750	KZ LTD Shaft (KZ750F1)							83							
750	KZ LTD Twin (KZ750G1/K1/M1)							80							
750	KZ Spectre (KZ750 N1/N2)							82/83							
750	VN Vulcan A2,A13 (VN750A/D097)							86/06							
750	Z (KZ750L3/L4)							83							
750	Z B (KZ750B)							76/79							
750	Z CSR Twin (KZ750M1)							82							
750	Z E (KZ750E1/E3)							80/83							
750	Z LTD (KZ750H1/H2/H3/H4)							80/83							
750	Z LTD Belt (KZ750K1/K2)							83/84							
750	Z LTD Shaft (KZ750F1)							83							
750	Z LTD Twin (KZ750G1/K1/M1)							80							
750	Z S (ZR750K1/K6)							05							
750	Z S (ZR750K1/K6)							06							
750	Z Spectre (KZ750 N1/N2)							82/83							
750	ZR Zephyr (ZR750C/D)							91/93							
750	ZR7/ZR7S (ZR750F)							00/03							
750	ZX7R Ninja (ZX750P1/P2/P3/P4/P5/P6)							96/03							
750	ZX7RR Ninja (ZX750N/H202)							96/97							
750	ZXR (ZX750H1/H2)							89/90							
750	ZXR (ZX750J1/J2)							91/92							
750	ZXR (ZX750L1/L2/L3)							93/95							
750	ZXR R (ZX750K)							91/92							
750	ZXR R (ZX750M)							93/94							
800	VN Vulcan (VN800A)							95/05							
800	VN Vulcan Classic (VN800B)							96/05							
800	VN Vulcan Drifter (VN800C)							01/06							
800	VN Vulcan Drifter (VN800C)							99/00							
900	GPZ R Ninja (ZX900A1/A3)							84/86							
900	VN Vulcan Custom (VN900C)							06/12							
900	Z (KZ A4/A5)							76/77							
900	Z1 Series (Z1900A/Z1900B)							73/75							
900	ZL Eliminator (ZL900A)							85/86							
900	ZX9R Ninja (ZX900B/C/E)							97							
900	ZX9R Ninja (ZX900B/C/E)							00/03							
900	ZX9R Ninja (ZX900B/C/E)							94/96							
900	ZX9R Ninja (ZX900B/C/E)							98/99							
1000	GPZ RX (ZXT00A A1/A3)							86/87							

		A		B		C	D	E			F	G	H	I	L			
Applicazioni cc	marca/modello	anno	kit cuscinetti ruota ant.	kit cuscinetti ruota post.	kit distanziali ruota ant.	kit distanziali ruota post.	kit cuscinetti albero motore	kit tenuta albero secondario	kit cuscinetti e parapolvere sterzo	Applicazioni cc	marca/modello	anno	Kit paraolio e parapolvere forcella	Kit paraolio forcella	Kit cuscinetti forcellone	Kit revisione leveraggi	Kit cuscinetti mono inf.	Kit cuscinetti mono sup.
1000	GTR Concours (ZG/ZGTA)	86/06							41.10594	1000	GTR Concours (ZG/ZGTA)	86/06		41.10634				
1000	KLV (A1H>A2H) (JKBS1122)	04/05							41.10593	1000	KLV (A1H>A2H) (JKBS1122)	04/05		41.10636				
1000	KLZ Versys (ACF>ADF) (LZT00AA)	12/13	41.10079						41.10605	1000	KLZ Versys (ACF>ADF) (LZT00AA)	12/13		41.10639				
1000	Z (A1H>A3H/A6F) (ZRT00AAA)	03/06	41.10079						41.10605	1000	Z (A1H>A3H/A6F) (ZRT00AAA)	03/06		41.10635				
1000	Z (B7F>B9F) (ZRT00BBA)	07/09	41.10079						41.10605	1000	Z (B7F>B9F) (ZRT00BBA)	07/09		41.10635				
1000	Z (DAF>DDFA) (ZRT00DDA)	10/13							41.10605	1000	Z (DAF>DDFA) (ZRT00DDA)	10/13						
1000	Z (KZ1000A1/A4)	77/80							41.10597	1000	Z (KZ1000A1/A4)	77/80		41.10626				
1000	Z 1R Series (KZ1000D1/D2/D3)	78/80							41.10597	1000	Z 1R Series (KZ1000D1/D2/D3)	78/80		41.10626				
1000	Z ABS (C7F>C9F) (ZRT00BCA)	07/09	41.10079						41.10605	1000	Z ABS (C7F>C9F) (ZRT00BCA)	07/09		41.10635				
1000	Z ABS (EAF>ECFA) (ZRT00DEA)	10/13							41.10605	1000	Z ABS (EAF>ECFA) (ZRT00DEA)	10/13						
1000	Z Classic (KZ1000ClassicG1)	80							41.10597	1000	Z Classic (KZ1000ClassicG1)	80		41.10626				
1000	Z CSR (KZ1000CSR M1/M2)	81/82							41.10594	1000	Z CSR (KZ1000CSR M1/M2)	81/82		41.10652				
1000	Z LTD (KZ1000LTD B1/B2/B3/B4)	80							41.10597	1000	Z LTD (KZ1000LTD B1/B2/B3/B4)	80		41.10626				
1000	Z LTD (KZ1000LTD K1/K2)	81/82							41.10594	1000	Z LTD (KZ1000LTD K1/K2)	81/82		41.10652				
1000	Z Police (KZ1000PoliceC/P)	78/81							41.10597	1000	Z Police (KZ1000PoliceC/P)	78/81		41.10629				
1000	Z Police (KZ1000PoliceC/P)	82/05							41.10594	1000	Z Police (KZ1000PoliceC/P)	82/05		41.10652				
1000	Z Replica (KZ1000ReplicaR1/R2)	82/83							41.10594	1000	Z Replica (KZ1000ReplicaR1/R2)	82/83		41.10652				
1000	Z Shaft (KZ1000Shaft E1/E2)	79/80							41.10297	1000	Z Shaft (KZ1000Shaft E1/E2)	79/80		41.10653				
1000	Z Standard (KZ1000Standard J1/J3)	81/83							41.10594	1000	Z Standard (KZ1000Standard J1/J3)	81/83		41.10652				
1000	Z SX (GBF>GDF) (ZXT00GGA)	11/13							41.10605	1000	Z SX (GBF>GDF) (ZXT00GGA)	11/13						
1000	Z SX ABS (HBF>HDF) (ZXT00GHA)	11/13							41.10605	1000	Z SX ABS (HBF>HDF) (ZXT00GHA)	11/13						
1000	ZL Eliminator (ZL1000A1)	87							41.10594	1000	ZL Eliminator (ZL1000A1)	87						
1000	ZX10 Tomcat Ninja (ZX)	88/90							41.10594	1000	ZX10 Tomcat Ninja (ZX)	88/90		41.10634				
1000	ZX10R Ninja (C1H/C2H/D6F/D7F/E8F/E9F/FAF)	04/05							41.10605	1000	ZX10R Ninja (C1H/C2H/D6F/D7F/E8F/E9F/FAF)	04/05		41.10639				
1000	ZX10R Ninja (C1H/C2H/D6F/D7F/E8F/E9F/FAF)	06/10	41.10079						41.10605	1000	ZX10R Ninja (C1H/C2H/D6F/D7F/E8F/E9F/FAF)	06/10		41.10639				
1000	ZX10R Ninja (JBF>JDF) (ZXT00JJA)	11/13	41.10079						41.10605	1000	ZX10R Ninja (JBF>JDF) (ZXT00JJA)	11/13						
1000	ZX10R Ninja ABS (KBF>KEF) (ZXT00JKA)	11/13	41.10079						41.10605	1000	ZX10R Ninja ABS (KBF>KEF) (ZXT00JKA)	11/13						
1100	GPZ (ZX1100A1/A2)	83/84							41.10594	1100	GPZ (ZX1100A1/A2)	83/84						
1100	GPZ (ZX1100E1/E2)	95/98							41.10297	1100	GPZ (ZX1100E1/E2)	95/98		41.10634				
1100	GPZ ABS (ZX_F1)	96							41.10297	1100	GPZ ABS (ZX_F1)	96		41.10634				
1100	Z LTD Shaft (KZ1100LTD Shaft L1)	83							41.10594	1100	Z LTD Shaft (KZ1100LTD Shaft L1)	83		41.10652				
1100	Z LTD Shaft (ZN1100LTD Shaft B1/B2)	81/82							41.10594	1100	Z LTD Shaft (ZN1100LTD Shaft B1/B2)	81/82		41.10652				
1100	Z Shaft (KZ1100A1/A2/A3)	81/83							41.10594	1100	Z Shaft (KZ1100A1/A2/A3)	81/83		41.10652				
1100	Z Spectre (KZ1100D1/D2)	82/83							41.10594	1100	Z Spectre (KZ1100D1/D2)	82/83		41.10652				
1100	ZN LTD (Shaft) (ZN)	84/85							41.10594	1100	ZN LTD (Shaft) (ZN)	84/85		41.10652				
1100	ZR Zephyr (ZR_A)	92/95							41.10594	1100	ZR Zephyr (ZR_A)	92/95		41.10639				
1100	ZRX (ZR_D1/D3/C3)	99/00							41.10594	1100	ZRX (ZR_D1/D3/C3)	99/00		41.10639				
1100	ZZR Ninja / ZX11 (ZXT_C/D)	90/93							41.10297	1100	ZZR Ninja / ZX11 (ZXT_C/D)	90/93		41.10639				
1100	ZZR Ninja / ZX11 (ZXT_C/D)	93/01							41.10602	1100	ZZR Ninja / ZX11 (ZXT_C/D)	93/01		41.10639				
1200	ZG Voyager XIII	86/03							41.10296	1200	ZG Voyager XIII	86/03		41.10635				
1200	ZRX R	02/05	41.10079						41.10605	1200	ZRX R	02/05		41.10639				
1200	ZRX R	00/01	41.10079						41.10604	1200	ZRX R	00/01		41.10639				
1200	ZRX S	01/05							41.10594	1200	ZRX S	01/05		41.10639				
1200	ZZR	02/05							41.10605	1200	ZZR	02/05		41.10639				
1300	Z KZ A	79/82							41.10297	1300	Z KZ A	79/82		41.10634				
1300	ZN Voyager	83/88							41.10297	1300	ZN Voyager	83/88		41.10634				
1400	GTR (ZG)	08/12	41.10079						41.10605	1400	GTR (ZG)	08/12		41.10639				
1400	ZZR / ZZR ABS (A6F>FDFA)	06/12	41.10079						41.10605	1400	ZZR / ZZR ABS (A6F>FDFA)	06/12		41.10639				
1500	VN Vulcan 88	87/95							41.10594	1500	VN Vulcan 88	87/95		41.10635				
1500	VN Vulcan 88 SE	87/90							41.10594	1500	VN Vulcan 88 SE	87/90		41.10635				
1500	VN Vulcan Classic	96/97							41.10594	1500	VN Vulcan Classic	96/97		41.10635				
1500	VN Vulcan Classic	96/99							41.10594	1500	VN Vulcan Classic	96/99		41.10635				
1500	VN Vulcan Classic	98/99							41.10594	1500	VN Vulcan Classic	98/99		41.10635				
1500	VN Vulcan Classic (USA)	06/08							41.10602	1500	VN Vulcan Classic (USA)	06/08		41.10635				

Applicazioni cc marca/modello		anno	A		B		C	D	E	Applicazioni cc marca/modello		anno	F Kit paraolio e parapolvere forcella	G Kit paraolio forcella	H Kit cuscinetti forcellone	I Kit revisione leveraggi	L Kit cuscinetti mono inf.	Kit cuscinetti mono sup.
			kit cuscinetti ruota ant.	kit cuscinetti ruota post.	kit distanziali ruota ant.	kit distanziali ruota post.	kit cuscinetti albero motore	kit tenuta albero secondario	kit cuscinetti e parapolvere sterzo									
1500 VN Vulcan Classic FI		00/02						41.10602		1500 VN Vulcan Classic FI	00/02		41.10635					
1500 VN Vulcan Classic Tourer (USA)		05						41.10594		1500 VN Vulcan Classic Tourer (USA)	05		41.10635					
1500 VN Vulcan Classic Tourer / FI		00/04						41.10594		1500 VN Vulcan Classic Tourer / FI	00/04		41.10635					
1500 VN Vulcan Classic Tourer / FI		99/01						41.10602		1500 VN Vulcan Classic Tourer / FI	99/01		41.10635					
1500 VN Vulcan Drifter / FI		99/05						41.10602		1500 VN Vulcan Drifter / FI	99/05		41.10635					
1500 VN Vulcan Mean Streak		01/05	41.10079					41.10602		1500 VN Vulcan Mean Streak	01/05		41.10636					
1600 VN Vulcan Classic		03/08	41.10079					41.10602		1600 VN Vulcan Classic	03/08		41.10639					
1600 VN Vulcan Mean Streak		04/05	41.10079					41.10602		1600 VN Vulcan Mean Streak	04/05		41.10636					
1600 VN Vulcan Mean Streak		06/08	41.10079					41.10602		1600 VN Vulcan Mean Streak	06/08							
1600 VN Vulcan Nomad FI		05/08	41.10079					41.10602		1600 VN Vulcan Nomad FI	05/08		41.10639					
1700 VN Vulcan Classic		09/12	41.10079					41.10605		1700 VN Vulcan Classic	09/12							
2000 VN Vulcan Cruiser		04/10	41.10079					41.10602		2000 VN Vulcan Cruiser	04/10		41.10645					

KTM

50 SX	10	41.10001	41.10001			41.10225		41.10280		50 SX	10	41.10343	41.10632	41.10378		41.10546	41.10546
50 SX	12/13	41.10005	41.10001			41.10225		41.10280		50 SX	12/13			41.10378		41.10546	41.10546
50 SXS	11/12	41.10001	41.10001			41.10225		41.10280		50 SXS	11/12	41.10343	41.10632	41.10378		41.10546	41.10546
50 SXS	13	41.10005	41.10001			41.10225		41.10280		50 SXS	13					41.10546	41.10546
50 JR ADV	01	41.10043	41.10043							50 JR ADV	01	41.10344	41.10632				
50 JR ADV	02/03	41.10043	41.10043							50 JR ADV	02/03	41.10343	41.10632				
50 MINI ADV	97/00	41.10043	41.10043							50 MINI ADV	97/00	41.10344	41.10632				
50 MINI ADV	02/07	41.10043	41.10043							50 MINI ADV	02/07	41.10343	41.10632				
50 SM	06	41.10001	41.10001					41.10280		50 SM	06	41.10343	41.10632			41.10546	41.10546
50 SR ADV	02/03	41.10043	41.10043							50 SR ADV	02/03	41.10343	41.10632				
50 SR ADV	04/07	41.10001	41.10043							50 SR ADV	04/07	41.10343	41.10632				
50 SX MINI	08	41.10001	41.10043							50 SX MINI	08	41.10343	41.10632				
50 SX MINI	09/11	41.10001	41.10001			41.10225		41.10280		50 SX MINI	09/11	41.10343	41.10632	41.10378			
50 SX MINI	12/13	41.10005	41.10001			41.10225		41.10280		50 SX MINI	12/13			41.10378			
50 SX PRO JR	98/01	41.10043	41.10043							50 SX PRO JR	98/01	41.10344	41.10632				
50 SX PRO JR	02/06	41.10001	41.10043							50 SX PRO JR	02/06	41.10343	41.10632			41.10546	41.10546
50 SX PRO JR	07/08	41.10001	41.10043							50 SX PRO JR	07/08	41.10343	41.10632				
50 SX PRO JR	09	41.10001	41.10001			41.10225		41.10280		50 SX PRO JR	09	41.10343	41.10632	41.10378			
50 SX PRO SR	98/99	41.10043	41.10043							50 SX PRO SR	98/99	41.10344	41.10632				
50 SX PRO SR	02/03	41.10001	41.10043							50 SX PRO SR	02/03	41.10343	41.10632			41.10546	41.10546
50 SX PRO SR	04	41.10001	41.10001							50 SX PRO SR	04	41.10343	41.10632			41.10546	41.10546
50 SX PRO SR	05/06	41.10001	41.10001					41.10280		50 SX PRO SR	05/06	41.10343	41.10632			41.10546	41.10546
50 SX PRO SR	07/08	41.10001	41.10001					41.10280		50 SX PRO SR	07/08	41.10343	41.10632				
50 SX SR	00	41.10043	41.10043							50 SX SR	00	41.10344	41.10632				
50 SXR PRO SR	97	41.10043	41.10043							50 SXR PRO SR	97	41.10344	41.10632				
50 SXR PRO JR	97	41.10043	41.10043							50 SXR PRO JR	97	41.10344	41.10632				
60 SX	98/00	41.10005				41.10213	41.10263	41.10280		60 SX	98/00	41.10344	41.10632	41.10378			
65 SX	98/99	41.10005				41.10213	41.10263	41.10280		65 SX	98/99	41.10344	41.10632	41.10378			
65 SX	00/01	41.10005	41.10093			41.10213	41.10263	41.10280		65 SX	00/01	41.10344	41.10632	41.10378			
65 SX	02/08	41.10005	41.10093			41.10213	41.10263	41.10280		65 SX	02/08	41.10345	41.10644	41.10378		41.10546	41.10546
65 SX	09/11	41.10005	41.10093			41.10226	41.10264	41.10280		65 SX	09/11	41.10345	41.10644	41.10378		41.10547	41.10547
65 SX	12/13	41.10005	41.10093			41.10226	41.10264	41.10280		65 SX	12/13			41.10378		41.10547	41.10547
65 SXS	13	41.10005	41.10093			41.10226	41.10264	41.10280		65 SXS	13			41.10378		41.10547	41.10547
65 XC	08	41.10005	41.10093			41.10213	41.10263	41.10280		65 XC	08	41.10345	41.10644	41.10378		41.10546	41.10546
65 XC	09	41.10005	41.10093			41.10226	41.10264	41.10280		65 XC	09	41.10345	41.10644	41.10378		41.10547	41.10547
85 SX 17/14	03/11	41.10044	41.10079	41.10143	41.10178		41.10265	41.10280		85 SX 17/14	03/11	41.10346	41.10631	41.10394		41.10548	41.10548
85 SX 17/14	12/13	41.10045	41.10079		41.10178		41.10265	41.10280		85 SX 17/14	12/13	41.10346	41.10631	41.10394		41.10548	41.10548
85 SX 19/16	03/11	41.10044	41.10079	41.10143	41.10178		41.10265	41.10280		85 SX 19/16	03/11	41.10346	41.10631	41.10394		41.10548	41.10548
85 SX 19/16	12/13	41.10045	41.10079		41.10178		41.10265	41.10280		85 SX 19/16	12/13	41.10346	41.10631	41.10394		41.10548	41.10548
85 SXS 17/14	13	41.10045	41.10079		41.10178		41.10265	41.10280		85 SXS 17/14	13	41.10346	41.10631	41.10394		41.10548	41.10548

Applicazioni		A								B								C								D								E								F								G								H								I								L							
cc	marca/modello	anno	kit cuscinetti ruota ant.	kit cuscinetti ruota post.	kit distanziali ruota ant.	kit distanziali ruota post.	kit cuscinetti albero motore	kit tenuta albero secondario	kit cuscinetti e parapolvere sterzo	Applicazioni cc	marca/modello	anno	Kit paraolio e parapolvere forcella	Kit paraolio forcella	Kit cuscinetti forcellone	Kit revisione leveraggi	Kit cuscinetti mono inf.	Kit cuscinetti mono sup.																																																															
85	SXS 19/16	13	41.10045	41.10079		41.10178		41.10265	41.10280	85	SXS 19/16	13	41.10346	41.10631	41.10394		41.10548	41.10548																																																															
85	XC	08/09	41.10044	41.10079	41.10143	41.10178		41.10265	41.10280	85	XC	08/09	41.10346	41.10631	41.10394		41.10548	41.10548																																																															
105	SX	06/11	41.10044	41.10079	41.10143	41.10178		41.10265	41.10280	105	SX	06/11	41.10346	41.10631	41.10394		41.10548	41.10548																																																															
105	XC	08/09	41.10044	41.10079	41.10143	41.10178		41.10265	41.10280	105	XC	08/09	41.10346	41.10631	41.10394		41.10548	41.10548																																																															
125	EGS 2T	93/95		41.10079		41.10178			41.10292	125	EGS 2T	93/95			41.10394																																																																		
125	EGS 2T	96/97		41.10079		41.10178			41.10292	125	EGS 2T	96/97	41.10310	41.10651	41.10394																																																																		
125	EGS 2T	98/99		41.10079		41.10178	41.10227		41.10292	125	EGS 2T	98/99	41.10310	41.10651			41.10537																																																																
125	EXC 2T	93/95		41.10079		41.10178			41.10292	125	EXC 2T	93/95			41.10394																																																																		
125	EXC 2T	96/97		41.10079		41.10178			41.10292	125	EXC 2T	96/97	41.10310	41.10651	41.10394																																																																		
125	EXC 2T	98/99		41.10079		41.10178	41.10227		41.10292	125	EXC 2T	98/99	41.10310	41.10651			41.10537																																																																
125	EXC 2T	00/01		41.10079		41.10178	41.10227		41.10292	125	EXC 2T	00/01	41.10346	41.10631			41.10537																																																																
125	EXC 2T	03	41.10004	41.10079	41.10133	41.10178	41.10227		41.10292	125	EXC 2T	03	41.10333	41.10647			41.10537	41.10548																																																															
125	EXC 2T	04/09	41.10004	41.10079	41.10133	41.10178	41.10227		41.10292	125	EXC 2T	04/09	41.10333	41.10647	41.10374		41.10537	41.10548																																																															
125	EXC 2T (FORCELLA 43)	02		41.10079		41.10178	41.10227		41.10292	125	EXC 2T (FORCELLA 43)	02	41.10346				41.10537	41.10548																																																															
125	EXC 2T (FORCELLA 48)	02		41.10079		41.10178	41.10227		41.10292	125	EXC 2T (FORCELLA 48)	02	41.10333				41.10537	41.10548																																																															
125	EXE 2T	00/01		41.10079		41.10178	41.10227		41.10292	125	EXE 2T	00/01	41.10346	41.10631			41.10537																																																																
125	SX 2T	93/95	41.10044	41.10079		41.10178			41.10292	125	SX 2T	93/95			41.10394																																																																		
125	SX 2T	96/97	41.10044	41.10079		41.10178			41.10292	125	SX 2T	96/97	41.10310	41.10651	41.10394																																																																		
125	SX 2T	98	41.10044	41.10079		41.10178	41.10227	41.10254	41.10292	125	SX 2T	98	41.10310	41.10651			41.10537																																																																
125	SX 2T	99	41.10044	41.10079		41.10178	41.10227	41.10254	41.10292	125	SX 2T	99		41.10650			41.10537																																																																
125	SX 2T	00/01	41.10016	41.10079	41.10147	41.10178	41.10227	41.10254	41.10292	125	SX 2T	00/01	41.10346	41.10631			41.10537																																																																
125	SX 2T	03	41.10004	41.10079	41.10133	41.10178	41.10227	41.10254	41.10292	125	SX 2T	03	41.10333	41.10647			41.10537	41.10548																																																															
125	SX 2T	04/08	41.10004	41.10079	41.10133	41.10178	41.10227	41.10254	41.10292	125	SX 2T	04/08	41.10333	41.10647	41.10374		41.10537	41.10548																																																															
125	SX 2T	12	41.10004	41.10079	41.10133	41.10178	41.10227	41.10254	41.10292	125	SX 2T	12	41.10333	41.10647	41.10374	41.10488	41.10550	41.10569																																																															
125	SX 2T	13	41.10004	41.10079	41.10133	41.10189	41.10227	41.10254	41.10292	125	SX 2T	13	41.10333	41.10647	41.10374	41.10488	41.10550	41.10569																																																															
125	SX 2T (FORCELLA 43)	02	41.10016	41.10079	41.10147	41.10178	41.10227	41.10254	41.10292	125	SX 2T (FORCELLA 43)	02	41.10346				41.10537	41.10548																																																															
125	SX 2T (FORCELLA 48)	02	41.10016	41.10079	41.10147	41.10178	41.10227	41.10254	41.10292	125	SX 2T (FORCELLA 48)	02	41.10333				41.10537	41.10548																																																															
125	SXS 2T	04	41.10004	41.10079	41.10133	41.10178	41.10227	41.10254	41.10292	125	SXS 2T	04	41.10333	41.10647	41.10374		41.10537	41.10548																																																															
144	SX 2T	07/08	41.10004	41.10079	41.10133	41.10178	41.10227	41.10254	41.10292	144	SX 2T	07/08	41.10333	41.10647	41.10374		41.10537	41.10548																																																															
150	SX 2T	09/11	41.10004	41.10079	41.10133	41.10178	41.10227	41.10254	41.10292	150	SX 2T	09/11	41.10333	41.10647	41.10374		41.10537	41.10548																																																															
150	SX 2T	12	41.10004	41.10079	41.10133	41.10178	41.10227	41.10254	41.10292	150	SX 2T	12	41.10333	41.10647	41.10374	41.10488	41.10550	41.10569																																																															
150	SX 2T	13	41.10004	41.10079	41.10133	41.10189	41.10227	41.10254	41.10292	150	SX 2T	13	41.10333	41.10647	41.10374	41.10488	41.10550	41.10569																																																															
150	XC	10/11	41.10004	41.10079	41.10133	41.10178	41.10227	41.10254	41.10292	150	XC	10/11	41.10333	41.10647	41.10374		41.10537	41.10548																																																															
150	XC	12/13	41.10004	41.10079	41.10133	41.10178	41.10227	41.10254	41.10292	150	XC	12/13	41.10333	41.10647	41.10374	41.10488	41.10550	41.10569																																																															
200	GS / EGS 2T	98/99		41.10079		41.10178	41.10227		41.10292	200	GS / EGS 2T	98/99	41.10310	41.10651			41.10537																																																																
200	EXC 2T	98/99		41.10079		41.10178	41.10227	41.10254	41.10292	200	EXC 2T	98/99	41.10310	41.10651			41.10537																																																																
200	EXC 2T	00/01		41.10079		41.10178	41.10227	41.10254	41.10292	200	EXC 2T	00/01	41.10346	41.10631			41.10537																																																																
200	EXC 2T	03	41.10004	41.10079	41.10133	41.10178	41.10227	41.10254	41.10292	200	EXC 2T	03	41.10333	41.10647			41.10537	41.10548																																																															
200	EXC 2T	04/05	41.10004	41.10079	41.10133	41.10178	41.10227	41.10254	41.10292	200	EXC 2T	04/05	41.10333	41.10647	41.10374		41.10537	41.10548																																																															
200	EXC 2T (FORCELLA 43)	02		41.10079		41.10178	41.10227	41.10254	41.10292	200	EXC 2T (FORCELLA 43)	02	41.10346				41.10537	41.10548																																																															
200	EXC 2T (FORCELLA 48)	02		41.10079		41.10178	41.10227	41.10254	41.10292	200	EXC 2T (FORCELLA 48)	02	41.10333				41.10537	41.10548																																																															
200	MXC 2T	98/99		41.10079		41.10178	41.10227	41.10254	41.10292	200	MXC 2T	98/99	41.10310	41.10651			41.10537																																																																
200	MXC 2T	00/01		41.10079		41.10178	41.10227	41.10254	41.10292	200	MXC 2T	00/01	41.10346	41.10631			41.10537																																																																
200	MXC 2T	03	41.10004	41.10079	41.10133	41.10178	41.10227	41.10254	41.10292	200	MXC 2T	03	41.10333	41.10647			41.10537	41.10548																																																															
200	MXC 2T (FORCELLA 43)	02		41.10079		41.10178	41.10227	41.10254	41.10292	200	MXC 2T (FORCELLA 43)	02	41.10346				41.10537	41.10548																																																															
200	MXC 2T (FORCELLA 48)	02		41.10079		41.10178	41.10227	41.10254	41.10292	200	MXC 2T (FORCELLA 48)	02	41.10333				41.10537	41.10548																																																															
200	SX 2T	00/01	41.10016	41.10079	41.10147	41.10178	41.10227	41.10254	41.10292	200	SX 2T	00/01	41.10346	41.10631			41.10537																																																																
200	SX 2T	02	41.10016	41.10079	41.10147	41.10178	41.10227	41.10254	41.10292	200	SX 2T	02	41.10346	41.10631			41.10537	41.10548																																																															
200	SX 2T	03	41.10004	41.10079	41.10133	41.10178	41.10227	41.10254	41.10292	200	SX 2T	03	41.10333	41.10647			41.10537	41.10548																																																															
200	SX 2T	04	41.10004	41.10079	41.10133	41.10178	41.10227	41.10254	41.10292	200	SX 2T	04	41.10333	41.10647	41.10374		41.10537	41.10548																																																															
200	XC	06/09	41.10004	41.10079	41.10133	41.10178	41.10227	41.10254	41.10292	200	XC	06/09	41.10333	41.10647	41.10374		41.10537	41.10548																																																															
200	XC-W	06/13	41.10004	41.10079	41.10133	41.10178	41.10227	41.10254	41.10292	200	XC-W	06/13	41.10333	41.10647	41.10374		41.10537	41.10548																																																															
250	GS / EGS 2T	94		41.10079		41.10178			41.10292	250	GS / EGS 2T	94			41.10394																																																																		
250	GS / EGS 2T	95		41.10079		41.10178			41.10292	250	GS / EGS 2T	95	41.10310	41.10651	41.10394																																																																		

ALL BALLS

ALL BALLS

Applicazioni cc marca/modello		anno	A		B		C	D	E	Applicazioni cc marca/modello		anno	F	G	H	I	L		
			kit cuscinetti ruota ant.	kit cuscinetti ruota post.	kit distanziali ruota ant.	kit distanziali ruota post.	kit cuscinetti albero motore	kit tenuta albero secondario	kit cuscinetti e parapolvere sterzo				Kit paraolio e parapolvere forcella	Kit paraolio forcella	Kit cuscinetti forcellone	Kit revisione leveraggi	Kit cuscinetti mono inf.	Kit cuscinetti mono sup.	
250	GS / EGS 2T	96		41.10079		41.10178				41.10292	250	GS / EGS 2T	96	41.10310	41.10651				
250	GS / EGS 2T	97		41.10079		41.10178				41.10292	250	GS / EGS 2T	97	41.10334	41.10646				
250	GS / EGS 2T	98/99		41.10079		41.10178				41.10292	250	GS / EGS 2T	98/99		41.10650			41.10537	
250	EXC 2T	94		41.10079		41.10178				41.10292	250	EXC 2T	94			41.10394			
250	EXC 2T	95/96		41.10079		41.10178				41.10292	250	EXC 2T	95/96	41.10310	41.10651				
250	EXC 2T	97		41.10079		41.10178				41.10292	250	EXC 2T	97	41.10334	41.10646				
250	EXC 2T	98/99		41.10079		41.10178				41.10292	250	EXC 2T	98/99		41.10650			41.10537	
250	EXC 2T	00/01		41.10079		41.10178				41.10292	250	EXC 2T	00/01	41.10346	41.10631			41.10537	
250	EXC 2T	03	41.10004	41.10079	41.10133	41.10178				41.10292	250	EXC 2T	03	41.10333	41.10647			41.10537	41.10548
250	EXC 2T	04/05	41.10004	41.10079	41.10133	41.10178	41.10212	41.10255		41.10292	250	EXC 2T	04/05	41.10333	41.10647	41.10374		41.10537	41.10548
250	EXC 2T (FORCELLA 43)	02		41.10079		41.10178				41.10292	250	EXC 2T (FORCELLA 43)	02	41.10346				41.10537	41.10548
250	EXC 2T (FORCELLA 48)	02		41.10079		41.10178				41.10292	250	EXC 2T (FORCELLA 48)	02	41.10333				41.10537	41.10548
250	EXC Racing 4T	04/05	41.10004	41.10079	41.10133	41.10178	41.10228	41.10254		41.10292	250	EXC Racing 4T	04/05	41.10333	41.10647	41.10375		41.10537	41.10548
250	MXC 2T	98/99		41.10079		41.10178				41.10292	250	MXC 2T	98/99		41.10650			41.10537	
250	MXC 2T	00/01		41.10079		41.10178				41.10292	250	MXC 2T	00/01	41.10346	41.10631			41.10537	
250	SX 2T	94	41.10044	41.10079		41.10178				41.10292	250	SX 2T	94			41.10394			
250	SX 2T	95	41.10044	41.10079		41.10178				41.10292	250	SX 2T	95	41.10310	41.10651	41.10394			
250	SX 2T	96	41.10044	41.10079		41.10178				41.10292	250	SX 2T	96	41.10310	41.10651				
250	SX 2T	97	41.10044	41.10079		41.10178				41.10292	250	SX 2T	97	41.10334	41.10646				
250	SX 2T	98/99	41.10044	41.10079		41.10178				41.10292	250	SX 2T	98/99		41.10650			41.10537	
250	SX 2T	00/01	41.10016	41.10079	41.10147	41.10178				41.10292	250	SX 2T	00/01	41.10346	41.10631			41.10537	
250	SX 2T	03	41.10004	41.10079	41.10133	41.10178		41.10255		41.10292	250	SX 2T	03	41.10333	41.10647	41.10374		41.10537	41.10548
250	SX 2T	04/11	41.10004	41.10079	41.10133	41.10178	41.10212	41.10255		41.10292	250	SX 2T	04/11	41.10333	41.10647	41.10374		41.10537	41.10548
250	SX 2T	12	41.10004	41.10079	41.10133	41.10178	41.10212	41.10255		41.10292	250	SX 2T	12	41.10333	41.10647	41.10374	41.10488	41.10550	41.10569
250	SX 2T	13	41.10004	41.10079	41.10133	41.10189	41.10212	41.10255		41.10292	250	SX 2T	13	41.10333	41.10647	41.10374	41.10488	41.10550	41.10569
250	SX 2T (FORCELLA 43)	02	41.10016	41.10079	41.10147	41.10178				41.10292	250	SX 2T (FORCELLA 43)	02	41.10346				41.10537	41.10548
250	SX 2T (FORCELLA 48)	02	41.10016	41.10079	41.10147	41.10178				41.10292	250	SX 2T (FORCELLA 48)	02	41.10333				41.10537	41.10548
250	SX-F 4T	05	41.10004	41.10079	41.10133	41.10178	41.10229	41.10254		41.10292	250	SX-F 4T	05	41.10333	41.10647	41.10374		41.10537	41.10548
250	SXF 4T	06/10	41.10004	41.10079	41.10133	41.10178	41.10229	41.10254		41.10292	250	SXF 4T	06/10	41.10333	41.10647	41.10374		41.10537	41.10548
250	SXF 4T	11/12	41.10004	41.10079	41.10133	41.10178	41.10229	41.10254		41.10292	250	SXF 4T	11/12	41.10333	41.10647	41.10374	41.10488	41.10550	41.10569
250	SXF 4T	13	41.10004	41.10079	41.10133	41.10189		41.10254		41.10292	250	SXF 4T	13	41.10333	41.10647	41.10374	41.10488	41.10550	41.10569
250	SXS 2T	01	41.10016	41.10079	41.10147	41.10178				41.10292	250	SXS 2T	01	41.10346	41.10631			41.10537	
250	SXS 2T	03/04	41.10004	41.10079	41.10133	41.10178	41.10212	41.10255		41.10292	250	SXS 2T	03/04	41.10333	41.10647	41.10374		41.10537	41.10548
250	XC	06/11	41.10004	41.10079	41.10133	41.10178	41.10212	41.10255		41.10292	250	XC	06/11	41.10333	41.10647	41.10374		41.10537	41.10548
250	XC	12	41.10004	41.10079	41.10133	41.10178	41.10212	41.10255		41.10292	250	XC	12	41.10333	41.10647	41.10374	41.10488	41.10550	41.10569
250	XC	13	41.10004	41.10079	41.10133	41.10189	41.10212	41.10255		41.10292	250	XC	13	41.10333	41.10647	41.10374	41.10488	41.10550	41.10569
250	XCF 4T	07/09	41.10004	41.10079	41.10133	41.10178	41.10229	41.10254		41.10292	250	XCF 4T	07/09	41.10333	41.10647	41.10374		41.10537	41.10548
250	XCF 4T	12	41.10004	41.10079	41.10133	41.10178	41.10229	41.10254		41.10292	250	XCF 4T	12	41.10333	41.10647	41.10374	41.10488	41.10550	41.10569
250	XCF 4T	13	41.10004	41.10079	41.10133	41.10189		41.10254		41.10292	250	XCF 4T	13	41.10333	41.10647	41.10374	41.10488	41.10550	41.10569
250	XCF-W 4T	07/12	41.10004	41.10079	41.10133	41.10178	41.10229	41.10254		41.10292	250	XCF-W 4T	07/12	41.10333	41.10647	41.10374		41.10537	41.10548
250	XCF-W 4T	13	41.10004	41.10079	41.10133	41.10178		41.10254		41.10292	250	XCF-W 4T	13	41.10333	41.10647	41.10374		41.10537	41.10548
250	XC-W	06/13	41.10004	41.10079	41.10133	41.10178	41.10212	41.10255		41.10292	250	XC-W	06/13	41.10333	41.10647	41.10374		41.10537	41.10548
300	GS / EGS 2T	94		41.10079		41.10178				41.10292	300	GS / EGS 2T	94			41.10394			
300	GS / EGS 2T	95		41.10079		41.10178				41.10292	300	GS / EGS 2T	95	41.10310	41.10651	41.10394			
300	GS / EGS 2T	96		41.10079		41.10178				41.10292	300	GS / EGS 2T	96	41.10310	41.10651				
300	GS / EGS 2T	97		41.10079		41.10178				41.10292	300	GS / EGS 2T	97	41.10334	41.10646				
300	GS / EGS 2T	98/99		41.10079		41.10178				41.10292	300	GS / EGS 2T	98/99		41.10650			41.10537	
300	EXC 2T	94		41.10079		41.10178				41.10292	300	EXC 2T	94			41.10394			
300	EXC 2T	95		41.10079		41.10178				41.10292	300	EXC 2T	95	41.10310	41.10651	41.10394			
300	EXC 2T	96		41.10079		41.10178				41.10292	300	EXC 2T	96	41.10310	41.10651				
300	EXC 2T	97		41.10079		41.10178				41.10292	300	EXC 2T	97	41.10334	41.10646				
300	EXC 2T	98/99		41.10079		41.10178				41.10292	300	EXC 2T	98/99		41.10650			41.10537	
300	EXC 2T	00/01		41.10079		41.10178				41.10292	300	EXC 2T	00/01	41.10346	41.10631			41.10537	
300	EXC 2T	03	41.10004	41.10079	41.10133	41.10178				41.10292	300	EXC 2T	03	41.10333	41.10647			41.10537	41.10548

		A		B		C	D	E				F	G	H	I	L		
Applicazioni cc	marca/modello	anno	kit cuscinetti ruota ant.	kit cuscinetti ruota post.	kit distanziali ruota ant.	kit distanziali ruota post.	kit cuscinetti albero motore	kit tenuta albero secondario	kit cuscinetti e parapolvere sterzo	Applicazioni cc	marca/modello	anno	Kit paraolio e parapolvere forcella	Kit paraolio forcella	Kit cuscinetti forcellone	Kit revisione leveraggi	Kit cuscinetti mono inf.	Kit cuscinetti mono sup.
300	EXC 2T	04/05	41.10004	41.10079	41.10133	41.10178	41.10212	41.10255	41.10292	300	EXC 2T	04/05	41.10333	41.10647	41.10374		41.10537	41.10548
300	EXC 2T (FORCELLA 43)	02		41.10079		41.10178			41.10292	300	EXC 2T (FORCELLA 43)	02	41.10346				41.10537	41.10548
300	EXC 2T (FORCELLA 48)	02		41.10079		41.10178			41.10292	300	EXC 2T (FORCELLA 48)	02	41.10333				41.10537	41.10548
300	MXC 2T	94		41.10079		41.10178			41.10292	300	MXC 2T	94			41.10394			
300	MXC 2T	96		41.10079		41.10178			41.10292	300	MXC 2T	96	41.10310	41.10651				
300	MXC 2T	97		41.10079		41.10178			41.10292	300	MXC 2T	97	41.10334	41.10646				
300	MXC 2T	98/99		41.10079		41.10178			41.10292	300	MXC 2T	98/99		41.10650			41.10537	
300	MXC 2T	00/01		41.10079		41.10178			41.10292	300	MXC 2T	00/01	41.10346	41.10631			41.10537	
300	MXC 2T	03	41.10004	41.10079	41.10133	41.10178			41.10292	300	MXC 2T	03	41.10333	41.10647			41.10537	41.10548
300	MXC 2T	04/05	41.10004	41.10079	41.10133	41.10178	41.10212	41.10255	41.10292	300	MXC 2T	04/05	41.10333	41.10647	41.10374		41.10537	41.10548
300	MXC 2T (FORCELLA 43)	02		41.10079		41.10178			41.10292	300	MXC 2T (FORCELLA 43)	02	41.10346				41.10537	41.10548
300	MXC 2T (FORCELLA 48)	02		41.10079		41.10178			41.10292	300	MXC 2T (FORCELLA 48)	02	41.10333				41.10537	41.10548
300	SX 2T	94	41.10044	41.10079		41.10178			41.10292	300	SX 2T	94			41.10394			
300	XC	06/11	41.10004	41.10079	41.10133	41.10178	41.10212	41.10255	41.10292	300	XC	06/11	41.10333	41.10647	41.10374		41.10537	41.10548
300	XC	12	41.10004	41.10079	41.10133	41.10178	41.10212	41.10255	41.10292	300	XC	12	41.10333	41.10647	41.10374	41.10488	41.10550	41.10569
300	XC	13	41.10004	41.10079	41.10133	41.10189	41.10212	41.10255	41.10292	300	XC	13	41.10333	41.10647	41.10374	41.10488	41.10550	41.10569
300	XC-W	06/13	41.10004	41.10079	41.10133	41.10178	41.10212	41.10255	41.10292	300	XC-W	06/13	41.10333	41.10647	41.10374		41.10537	41.10548
350	EXC F 4T	13	41.10004	41.10079	41.10133	41.10178		41.10254	41.10292	350	EXC F 4T	13	41.10333	41.10647	41.10374		41.10537	41.10548
350	LC4 EGS 4T	94/95							41.10292	350	LC4 EGS 4T	94/95			41.10394			
350	LC4 EXC 4T	93/95							41.10292	350	LC4 EXC 4T	93/95			41.10394			
350	LC4 RXC 4T	94/95							41.10292	350	LC4 RXC 4T	94/95			41.10394			
350	LC4 SX 4T	94/95							41.10292	350	LC4 SX 4T	94/95			41.10394			
350	SXF 4T	11/12	41.10004	41.10079	41.10133	41.10178		41.10254	41.10292	350	SXF 4T	11/12	41.10333	41.10647	41.10374	41.10488	41.10550	41.10569
350	SXF 4T	13	41.10004	41.10079	41.10133	41.10189		41.10254	41.10292	350	SXF 4T	13	41.10333	41.10647	41.10374	41.10488	41.10550	41.10569
350	XC-F 4T	12	41.10004	41.10079	41.10133	41.10178		41.10254	41.10292	350	XC-F 4T	12	41.10333	41.10647	41.10374	41.10488	41.10550	41.10569
350	XC-F 4T	13	41.10004	41.10079	41.10133	41.10189		41.10254	41.10292	350	XC-F 4T	13	41.10333	41.10647	41.10374	41.10488	41.10550	41.10569
350	XC-FW 4T	12/13	41.10004	41.10079	41.10133	41.10178		41.10254	41.10292	350	XC-FW 4T	12/13	41.10333	41.10647	41.10374		41.10537	41.10548
360	GS / EGS 2T	96		41.10079		41.10178			41.10292	360	GS / EGS 2T	96	41.10310	41.10651				
360	GS / EGS 2T	97		41.10079		41.10178			41.10292	360	GS / EGS 2T	97	41.10334	41.10646				
360	EXC 2T	96		41.10079		41.10178			41.10292	360	EXC 2T	96	41.10310	41.10651				
360	EXC 2T	97		41.10079		41.10178			41.10292	360	EXC 2T	97	41.10334	41.10646				
360	MXC 2T	96		41.10079		41.10178			41.10292	360	MXC 2T	96	41.10310	41.10651				
360	MXC 2T	97		41.10079		41.10178			41.10292	360	MXC 2T	97	41.10334	41.10646				
360	SX 2T	97	41.10044	41.10079		41.10178			41.10292	360	SX 2T	97	41.10310	41.10651				
360	SX 2T	98	41.10044	41.10079		41.10178			41.10292	360	SX 2T	98	41.10334	41.10646				
380	EGS 2T	98/99		41.10079		41.10178			41.10292	380	EGS 2T	98/99		41.10650			41.10537	
380	EXC 2T	98/99		41.10079		41.10178			41.10292	380	EXC 2T	98/99		41.10650			41.10537	
380	EXC 2T	00/01		41.10079		41.10178			41.10292	380	EXC 2T	00/01	41.10346	41.10631			41.10537	
380	EXC 2T (FORCELLA 43)	02		41.10079		41.10178			41.10292	380	EXC 2T (FORCELLA 43)	02	41.10346				41.10537	41.10548
380	EXC 2T (FORCELLA 48)	02		41.10079		41.10178			41.10292	380	EXC 2T (FORCELLA 48)	02	41.10333				41.10537	41.10548
380	MXC 2T	98/99		41.10079		41.10178			41.10292	380	MXC 2T	98/99		41.10650			41.10537	
380	MXC 2T	00/01		41.10079		41.10178			41.10292	380	MXC 2T	00/01	41.10346	41.10631			41.10537	
380	SX 2T	98/99	41.10044	41.10079		41.10178			41.10292	380	SX 2T	98/99		41.10650			41.10537	
380	SX 2T	00/01	41.10016	41.10079	41.10147	41.10178			41.10292	380	SX 2T	00/01	41.10346	41.10631			41.10537	
380	SX 2T (FORCELLA 43)	02	41.10016	41.10079	41.10147	41.10178			41.10292	380	SX 2T (FORCELLA 43)	02	41.10346				41.10537	41.10548
380	SX 2T (FORCELLA 48)	02	41.10016	41.10079	41.10147	41.10178			41.10292	380	SX 2T (FORCELLA 48)	02	41.10333				41.10537	41.10548
400	LC4 SC Supercompetition 4T	95/98							41.10292	400	LC4 SC Supercompetition 4T	95/98			41.10394			
400	LC4 SC Supercompetition 4T	99							41.10292	400	LC4 SC Supercompetition 4T	99	41.10346	41.10631	41.10394			
400	Duke	94/95							41.10292	400	Duke	94/95			41.10394			
400	LC4 EGS 4T	94/97							41.10292	400	LC4 EGS 4T	94/97			41.10394			
400	LC4 EGS-E 4T	97							41.10292	400	LC4 EGS-E 4T	97			41.10394			
400	EXC 4T	94				41.10178			41.10292	400	EXC 4T	94			41.10394			
400	EXC 4T	96							41.10292	400	EXC 4T	96			41.10394			
400	EXC 4T	00/01		41.10079		41.10178	41.10228	41.10254	41.10292	400	EXC 4T	00/01	41.10346	41.10631	41.10394		41.10537	

Applicazioni		A		B		C	D	E	Applicazioni		F	G	H	I	L			
cc	marca/modello	anno	kit cuscinetti ruota ant.	kit cuscinetti ruota post.	kit distanziali ruota ant.	kit distanziali ruota post.	kit cuscinetti albero motore	kit tenuta albero secondario	kit cuscinetti e parapolvere sterzo	cc	marca/modello	anno	Kit paraolio e parapolvere forcella	Kit paraolio forcella	Kit cuscinetti forcellone	Kit revisione leveraggi	Kit cuscinetti mono inf.	Kit cuscinetti mono sup.
400	EXC 4T	02		41.10079		41.10178	41.10228	41.10254	41.10292	400	EXC 4T	02	41.10346	41.10631	41.10394		41.10537	41.10548
400	EXC 4T	04/06	41.10004	41.10079	41.10133	41.10178	41.10228	41.10254	41.10292	400	EXC 4T	04/06	41.10333	41.10647	41.10375		41.10537	41.10548
400	LC4 SX 4T	98							41.10292	400	LC4 SX 4T	98			41.10394			
400	LC4 SX 4T	99							41.10292	400	LC4 SX 4T	99		41.10650	41.10394			
400	LC4-E	00/01							41.10292	400	LC4-E	00/01	41.10346	41.10631	41.10394			
400	LC4 LSE 4T	97							41.10292	400	LC4 LSE 4T	97			41.10394			
400	MXC 2T	01		41.10079		41.10178	41.10228		41.10292	400	MXC 2T	01	41.10346	41.10631	41.10394		41.10537	
400	MXC 2T (FORCELLA 43)	02		41.10079		41.10178	41.10228		41.10292	400	MXC 2T (FORCELLA 43)	02	41.10346		41.10394		41.10537	41.10548
400	MXC 2T (FORCELLA 48)	02		41.10079		41.10178	41.10228		41.10292	400	MXC 2T (FORCELLA 48)	02	41.10333		41.10394		41.10537	41.10548
400	RXC	95							41.10292	400	RXC	95			41.10394			
400	RXC	96							41.10292	400	RXC	96	41.10310	41.10651	41.10394			
400	RXC	97/98							41.10292	400	RXC	97/98			41.10394			
400	LC4 SC Supercompetition 4T	00		41.10079		41.10178			41.10292	400	LC4 SC Supercompetition 4T	00	41.10346	41.10631	41.10394			
400	LC4 SX 4T	98/99	41.10044	41.10079		41.10178			41.10292	400	LC4 SX 4T	98/99		41.10650	41.10394			
400	SX Racing 4T	00	41.10016	41.10079	41.10147	41.10178		41.10254	41.10292	400	SX Racing 4T	00	41.10346	41.10631	41.10394		41.10537	
400	SX Racing 4T	01	41.10016	41.10079	41.10147	41.10178	41.10228	41.10254	41.10292	400	SX Racing 4T	01	41.10346	41.10631	41.10394		41.10537	
400	SX Racing 4T (FORCELLA 43)	02	41.10016	41.10079	41.10147	41.10178	41.10228	41.10254	41.10292	400	SX Racing 4T (FORCELLA 43)	02	41.10346		41.10394		41.10537	41.10548
400	SX Racing 4T (FORCELLA 48)	02	41.10016	41.10079	41.10147	41.10178	41.10228	41.10254	41.10292	400	SX Racing 4T (FORCELLA 48)	02	41.10333		41.10394		41.10537	41.10548
400	SXC 4T Tiainen Replica	97		41.10079		41.10178			41.10292	400	SXC 4T Tiainen Replica	97			41.10394			
400	SXC 4T Tiainen Replica	00		41.10079		41.10178			41.10292	400	SXC 4T Tiainen Replica	00	41.10346	41.10631	41.10394		41.10537	
400	TXC	98	41.10044	41.10079		41.10178			41.10292	400	TXC	98		41.10650	41.10394			
400	XC-W	07	41.10004	41.10079	41.10147	41.10178	41.10228	41.10254	41.10292	400	XC-W	07	41.10333	41.10647	41.10375		41.10537	41.10548
400	XC-W	09/10	41.10004	41.10079	41.10133	41.10178		41.10254	41.10292	400	XC-W	09/10	41.10333	41.10647	41.10375		41.10537	41.10548
440	EXC	94		41.10079		41.10178			41.10292	440	EXC	94			41.10394			
440	EXC	95		41.10079		41.10178			41.10292	440	EXC	95	41.10310	41.10651	41.10394			
440	MXC	94	41.10044	41.10079		41.10178			41.10292	440	MXC	94			41.10394			
440	MXC	95								440	MXC	95			41.10394			
440	SX	94	41.10044	41.10079		41.10178			41.10292	440	SX	94			41.10394			
450	EXC 4T	03	41.10004	41.10079	41.10133	41.10178	41.10228	41.10254	41.10292	450	EXC 4T	03	41.10333	41.10647	41.10394		41.10537	41.10548
450	EXC 4T	04/07	41.10004	41.10079	41.10133	41.10178	41.10228	41.10254	41.10292	450	EXC 4T	04/07	41.10333	41.10647	41.10375		41.10537	41.10548
450	EXC R 4T	08/11	41.10004	41.10079	41.10133	41.10178		41.10254	41.10292	450	EXC R 4T	08/11	41.10333	41.10647	41.10375		41.10537	41.10548
450	MXC-G	03	41.10004	41.10079	41.10133	41.10178	41.10228	41.10254	41.10292	450	MXC-G	03	41.10333	41.10647	41.10394		41.10537	41.10548
450	MXC-G	04/05	41.10004	41.10079	41.10133	41.10178	41.10228	41.10254	41.10292	450	MXC-G	04/05	41.10333	41.10647	41.10375		41.10537	41.10548
450	SMR 4T	05/07	41.10004	41.10079	41.10133	41.10178	41.10228	41.10254	41.10292	450	SMR 4T	05/07	41.10333	41.10647	41.10375		41.10537	41.10548
450	SMS	03	41.10004	41.10079		41.10178	41.10228		41.10292	450	SMS	03	41.10333	41.10647	41.10394		41.10537	41.10548
450	SMS	04	41.10004	41.10079		41.10178	41.10228	41.10254	41.10292	450	SMS	04			41.10375		41.10537	41.10548
450	SXF 4T	03	41.10004	41.10079	41.10133	41.10178	41.10228	41.10254	41.10292	450	SXF 4T	03	41.10333	41.10647	41.10394		41.10537	41.10548
450	SXF 4T	04/06	41.10004	41.10079	41.10133	41.10178	41.10228	41.10254	41.10292	450	SXF 4T	04/06	41.10333	41.10647	41.10375		41.10537	41.10548
450	SXF 4T	07/10	41.10004	41.10079	41.10133	41.10178		41.10267	41.10292	450	SXF 4T	07/10	41.10333	41.10647	41.10374		41.10537	41.10548
450	SXF 4T	11/12	41.10004	41.10079	41.10133	41.10178		41.10267	41.10292	450	SXF 4T	11/12	41.10333	41.10647	41.10374	41.10488	41.10550	41.10569
450	SXF 4T	13	41.10004	41.10079	41.10133	41.10189		41.10254	41.10292	450	SXF 4T	13	41.10333	41.10647	41.10375	41.10488	41.10550	41.10569
450	SXS 4T	03	41.10004	41.10079	41.10133	41.10178	41.10228	41.10254	41.10292	450	SXS 4T	03	41.10333	41.10647	41.10394		41.10537	41.10548
450	SXS 4T	04	41.10004	41.10079	41.10133	41.10178	41.10228	41.10254	41.10292	450	SXS 4T	04	41.10333	41.10647			41.10537	41.10548
450	XC-F 4T	04	41.10004	41.10079	41.10133	41.10178	41.10228	41.10254	41.10292	450	XC-F 4T	04	41.10333	41.10647	41.10375		41.10537	41.10548
450	XC-F 4T	06/07	41.10004	41.10079	41.10133	41.10178	41.10228	41.10254	41.10292	450	XC-F 4T	06/07	41.10333	41.10647	41.10375		41.10537	41.10548
450	XC-F 4T	08/09	41.10004	41.10079	41.10133	41.10178		41.10267	41.10292	450	XC-F 4T	08/09	41.10333	41.10647	41.10375		41.10537	41.10548
450	XC-F 4T	13	41.10004	41.10079	41.10133	41.10189		41.10254	41.10292	450	XC-F 4T	13	41.10333	41.10647	41.10374	41.10488	41.10550	41.10569
450	XCR-W	08	41.10004	41.10079	41.10133	41.10178			41.10292	450	XCR-W	08	41.10333	41.10647	41.10375		41.10537	41.10548
450	XC-W	07	41.10004	41.10079	41.10133	41.10178	41.10228	41.10254	41.10292	450	XC-W	07	41.10333	41.10647	41.10375		41.10537	41.10548
450	XC-W	09/13	41.10004	41.10079	41.10133	41.10178		41.10254	41.10292	450	XC-W	09/13	41.10333	41.10647	41.10375		41.10537	41.10548
500	EXC 4T	12/13	41.10004	41.10079	41.10133	41.10178		41.10254	41.10292	500	EXC 4T	12/13	41.10333	41.10647	41.10375		41.10537	41.10548
500	LC4	91	41.10044						41.10292	500	LC4	91						
500	LC4	92							41.10292	500	LC4	92						
500	XC-W	12/13	41.10004	41.10079	41.10133	41.10178		41.10254	41.10292	500	XC-W	12/13	41.10333	41.10647	41.10375		41.10537	41.10548

		A		B		C	D	E			F	G	H	I	L			
<i>Applicazioni cc</i>	<i>marca/modello</i>	<i>anno</i>	<i>kit cuscinetti ruota ant.</i>	<i>kit cuscinetti ruota post.</i>	<i>kit distanziali ruota ant.</i>	<i>kit distanziali ruota post.</i>	<i>kit cuscinetti albero motore</i>	<i>kit tenuta albero secondario</i>	<i>kit cuscinetti e parapolvere sterzo</i>	<i>Applicazioni cc</i>	<i>marca/modello</i>	<i>anno</i>	<i>Kit paraolio e parapolvere forcella</i>	<i>Kit paraolio forcella</i>	<i>Kit cuscinetti forcellone</i>	<i>Kit revisione leveraggi</i>	<i>Kit cuscinetti mono inf.</i>	<i>Kit cuscinetti mono sup.</i>
505	SXF 4T	08	41.10004	41.10079	41.10133	41.10178		41.10267	41.10292	505	SXF 4T	08	41.10333	41.10647	41.10374		41.10537	41.10548
505	XC-F	08/09	41.10004	41.10079	41.10133	41.10178		41.10267	41.10292	505	XC-F	08/09	41.10333	41.10647	41.10374		41.10537	41.10548
520	EXC 4T	00/01		41.10079		41.10178	41.10228	41.10254	41.10292	520	EXC 4T	00/01	41.10346	41.10631	41.10394		41.10537	
520	EXC 4T (FORCELLA 43)	02		41.10079		41.10178	41.10228	41.10254	41.10292	520	EXC 4T (FORCELLA 43)	02	41.10346		41.10394		41.10537	41.10548
520	EXC 4T (FORCELLA 48)	02		41.10079		41.10178	41.10228	41.10254	41.10292	520	EXC 4T (FORCELLA 48)	02	41.10333		41.10394		41.10537	41.10548
520	MXC 4T	01		41.10079		41.10178	41.10228	41.10254	41.10292	520	MXC 4T	01	41.10346	41.10631	41.10394		41.10537	
520	MXC 4T (FORCELLA 43)	02		41.10079		41.10178	41.10228	41.10254	41.10292	520	MXC 4T (FORCELLA 43)	02	41.10346		41.10394		41.10537	41.10548
520	MXC 4T (FORCELLA 48)	02		41.10079		41.10178	41.10228	41.10254	41.10292	520	MXC 4T (FORCELLA 48)	02	41.10333		41.10394		41.10537	41.10548
520	SX 4T	00		41.10079	41.10147	41.10178	41.10228	41.10254	41.10292	520	SX 4T	00	41.10346	41.10631	41.10394		41.10537	
520	SX 4T	01	41.10016	41.10079	41.10147	41.10178	41.10228	41.10254	41.10292	520	SX 4T	01	41.10346	41.10631	41.10394		41.10537	
520	SX 4T (FORCELLA 43)	02	41.10016	41.10079	41.10147	41.10178	41.10228	41.10254	41.10292	520	SX 4T (FORCELLA 43)	02	41.10346		41.10394		41.10537	41.10548
520	SX 4T (FORCELLA 48)	02	41.10016	41.10079	41.10147	41.10178	41.10228	41.10254	41.10292	520	SX 4T (FORCELLA 48)	02	41.10333		41.10394		41.10537	41.10548
525	EXC 4T	03	41.10004	41.10079	41.10133	41.10178	41.10228	41.10254	41.10292	525	EXC 4T	03	41.10333	41.10647	41.10394		41.10537	41.10548
525	EXC 4T	04/07	41.10004	41.10079	41.10133	41.10178	41.10228	41.10254	41.10292	525	EXC 4T	04/07	41.10333	41.10647	41.10375		41.10537	41.10548
525	MXC 4T	03	41.10004	41.10079	41.10133	41.10178	41.10228	41.10254	41.10292	525	MXC 4T	03	41.10333	41.10647	41.10394		41.10537	41.10548
525	MXC 4T	04/05	41.10004	41.10079	41.10133	41.10178	41.10228	41.10254	41.10292	525	MXC 4T	04/05	41.10333	41.10647	41.10375		41.10537	41.10548
525	SMR 4T	05	41.10004	41.10079	41.10133	41.10178	41.10228	41.10254	41.10292	525	SMR 4T	05	41.10333	41.10647	41.10375		41.10537	41.10548
525	SX 4T	03	41.10004	41.10079	41.10133	41.10178	41.10228	41.10254	41.10292	525	SX 4T	03	41.10333	41.10647	41.10394		41.10537	41.10548
525	SX 4T	04/06	41.10004	41.10079	41.10133	41.10178	41.10228	41.10254	41.10292	525	SX 4T	04/06	41.10333	41.10647	41.10375		41.10537	41.10548
525	XC	06/07	41.10004	41.10079	41.10133	41.10178	41.10228	41.10254	41.10292	525	XC	06/07	41.10333	41.10647	41.10375		41.10537	41.10548
525	XC-W	07	41.10004	41.10079	41.10133	41.10178	41.10228	41.10254	41.10292	525	XC-W	07	41.10333	41.10647	41.10375		41.10537	41.10548
530	EXC R 4T	08/11	41.10004	41.10079	41.10133	41.10178		41.10254	41.10292	530	EXC R 4T	08/11	41.10333	41.10647	41.10375		41.10537	41.10548
530	XCR-W	08	41.10004	41.10079	41.10133	41.10178		41.10254	41.10292	530	XCR-W	08	41.10333	41.10647	41.10375		41.10537	41.10548
530	XC-W	09/11	41.10004	41.10079	41.10133	41.10178		41.10254	41.10292	530	XC-W	09/11	41.10333	41.10647	41.10375		41.10537	41.10548
550	MXC	94	41.10044	41.10079		41.10178			41.10292	550	MXC	94			41.10394			
550	MXC	96	41.10044	41.10079		41.10178			41.10292	550	MXC	96	41.10310	41.10651	41.10394			
560	SMR 4T	06/07	41.10004	41.10079	41.10133	41.10178			41.10292	560	SMR 4T	06/07	41.10333	41.10647	41.10375		41.10537	41.10548
600	GS LC4 4T	91	41.10044						41.10292	600	GS LC4 4T	91						
600	GS LC4 4T	92							41.10292	600	GS LC4 4T	92						
620	LC4 SC 4T Supercompetition Limited	97							41.10292	620	LC4 SC 4T Supercompetition Limited	97		41.10650	41.10394			
620	LC4 SC 4T Supercompetition	94/96							41.10292	620	LC4 SC 4T Supercompetition	94/96			41.10394			
620	LC4 SC 4T Supercompetition	97/99							41.10292	620	LC4 SC 4T Supercompetition	97/99		41.10650	41.10394			
620	Duke	94/97							41.10292	620	Duke	94/97			41.10394			
620	LC4 EGS 4T	94		41.10079					41.10292	620	LC4 EGS 4T	94			41.10394			
620	LC4 EGS 4T	95/97							41.10292	620	LC4 EGS 4T	95/97			41.10394			
620	LC4 EGS E Adventure 4T	97							41.10292	620	LC4 EGS E Adventure 4T	97			41.10394			
620	LC4 EXC 4T	94	41.10044	41.10079		41.10178			41.10292	620	LC4 EXC 4T	94			41.10394			
620	LC4 EXC 4T	95							41.10292	620	LC4 EXC 4T	95			41.10394			
620	LC4 LSE 4T	97/98							41.10292	620	LC4 LSE 4T	97/98		41.10650	41.10394			
620	LC4 Supermoto 4T	99							41.10292	620	LC4 Supermoto 4T	99		41.10650	41.10394			
620	LC4 RXC/E 4T	95							41.10292	620	LC4 RXC/E 4T	95			41.10394			
620	LC4 RXC/E 4T	96/97							41.10292	620	LC4 RXC/E 4T	96/97	41.10310	41.10651	41.10394			
620	LC4 Supermoto 4T	98		41.10079		41.10178			41.10292	620	LC4 Supermoto 4T	98		41.10650	41.10394			
620	LC4 SX 4T	97/99	41.10044	41.10079		41.10178			41.10292	620	LC4 SX 4T	97/99		41.10650	41.10394			
620	LC4 SXC 4T	97		41.10079		41.10178			41.10292	620	LC4 SXC 4T	97		41.10650	41.10394			
620	LC4 TXC 4T	98	41.10044	41.10079		41.10178			41.10292	620	LC4 TXC 4T	98		41.10650	41.10394			
625	SMC Supermoto 4T	06	41.10004						41.10292	625	SMC Supermoto 4T	06	41.10333	41.10647	41.10394			
625	LC4 SXC	03/04	41.10016	41.10079		41.10178			41.10292	625	LC4 SXC	03/04	41.10346	41.10631	41.10394			
625	LC4 SXC	05	41.10016	41.10079		41.10178			41.10292	625	LC4 SXC	05	41.10333	41.10647	41.10394			
640	LC4 Adventure	98/99	41.10044						41.10292	640	LC4 Adventure	98/99		41.10650	41.10394			
640	LC4 Adventure	00	41.10044						41.10292	640	LC4 Adventure	00	41.10346	41.10631	41.10394			
640	LC4 Adventure	03/05							41.10292	640	LC4 Adventure	03/05	41.10333	41.10647	41.10394			
640	LC4 Adventure	06/07	41.10004						41.10292	640	LC4 Adventure	06/07	41.10333	41.10647	41.10394			
640	LC4 E Enduro	05	41.10004						41.10292	640	LC4 E Enduro	05	41.10333	41.10647	41.10394			

ALL BALLS

ALL BALLS

Applicazioni cc	marca/modello	anno	A		B		C	D	E	Applicazioni cc		anno	F	G	H	I	L		
			kit cuscinetti ruota ant.	kit cuscinetti ruota post.	kit distanziali ruota ant.	kit distanziali ruota post.	kit cuscinetti albero motore	kit tenuta albero secondario	kit cuscinetti e parapolvere sterzo	marca/modello	Kit paraolio e parapolvere forcella		Kit paraolio forcella	Kit cuscinetti forcellone	Kit revisione leveraggi	Kit cuscinetti mono inf.	Kit cuscinetti mono sup.		
640	LC4 E Supermoto	00/01								41.10292	640	LC4 E Supermoto	00/01	41.10346	41.10631	41.10394			
640	LC4 E Supermoto	99								41.10292	640	LC4 E Supermoto	99		41.10650	41.10394			
660	LC4 Rallye / Factory Replica	06/07	41.10004							41.10292	660	LC4 Rallye / Factory Replica	06/07	41.10333	41.10647	41.10394			
690	LC4 Duke	08	41.10004							41.10292	690	LC4 Duke	08						
690	RFR Rallye Factory Replica	08/09	41.10004		41.10133					41.10292	690	RFR Rallye Factory Replica	08/09	41.10333	41.10647				
690	EXC Enduro / Enduro R 4T	09/12	41.10004		41.10133					41.10292	690	EXC Enduro / Enduro R 4T	09/12	41.10333	41.10647				
690	SMC R 4T	09/10	41.10004		41.10133					41.10292	690	SMC R 4T	09/10	41.10333	41.10647				
690	SM Supermoto	07	41.10004		41.10133					41.10292	690	SM Supermoto	07	41.10333	41.10647				
950	LC8 Adventure	03	41.10004							41.10292	950	LC8 Adventure	03						
950	LC8 Adventure	04/06	41.10004							41.10292	950	LC8 Adventure	04/06	41.10333	41.10647				
950	LC8 Supermoto	05/06	41.10004							41.10292	950	LC8 Supermoto	05/06	41.10333	41.10647				
950	LC8 Super Enduro R	07	41.10004							41.10292	950	LC8 Super Enduro R	07	41.10333	41.10647				
990	Adventure	07/12	41.10004							41.10292	990	Adventure	07/12	41.10333	41.10647				
990	Super Duke / R	06/08	41.10004							41.10292	990	Super Duke / R	06/08						
990	Supermoto / T	10/11	41.10004							41.10292	990	Supermoto / T	10/11	41.10333	41.10647				
1190	RC8 / R	09/10	41.10004							41.10593	1190	RC8 / R	09/10	41.10346	41.10631				
1190	RC8 / R	11/13	41.10004							41.10593	1190	RC8 / R	11/13						

MOTO GUZZI

650	NTX	89								41.10279	650	NTX	89							
750	Breva	03/07								41.10279	750	Breva	03/07							
750	Nevada/Nevada Club	98/03								41.10279	750	Nevada/Nevada Club	98/03							
750	Nevada Classic - Aquila nera (LME00/LMG00)	04/05								41.10279	750	Nevada Classic - Aquila nera (LME00/LMG00)	04/05							
750	NTX	89								41.10279	750	NTX	89							
750	NTX	93								41.10279	750	NTX	93							
750	V7 Classic (LW00/LWC00/LWJ00)	08								41.10279	750	V7 Classic (LW00/LWC00/LWJ00)	08							
1000	GT	87/93								41.10279	1000	GT	87/93							
1000	California III	89/93								41.10279	1000	California III	89/93							
1000	Daytona / Daytona RS	94								41.10279	1000	Daytona / Daytona RS	94							
1100	California Classic (KDG)	06/07								41.10279	1100	California Classic (KDG)	06/07							
1000	Quota	92/97								41.10279	1000	Quota	92/97							
1100	Breva ie	05/07								41.10605	1100	Breva ie	05/07							41.10651
1100	California Aluminium (KD)	03/04								41.10279	1100	California Aluminium (KD)	03/04	41.10310	41.10651					
1100	California (KC/KD)	94/97								41.10279	1100	California (KC/KD)	94/97							41.10653
1100	California Classic (KDG)	06/07								41.10279	1100	California Classic (KDG)	06/07	41.10310	41.10651					
1100	California Tourer (KDE)	06/07								41.10279	1100	California Tourer (KDE)	06/07	41.10310	41.10651					
1100	California EV (KD)	97/02								41.10279	1100	California EV (KD)	97/02	41.10310	41.10651					
1100	California Jackal (KD)	99/01								41.10279	1100	California Jackal (KD)	99/01	41.10310	41.10651					
1100	California Special Sport (KD)	02								41.10279	1100	California Special Sport (KD)	02	41.10310	41.10651					
1100	California Stone (KD)	01/04								41.10279	1100	California Stone (KD)	01/04	41.10310	41.10651					
1100	California Vintage (KDH00)	06/08								41.10279	1100	California Vintage (KDH00)	06/08	41.10310	41.10651					
1100	Griso	05/08								41.10605	1100	Griso	05/08							41.10636
1100	Quota ES	99/02								41.10279	1100	Quota ES	99/02							
1100	V11 Ballabio	03/05								41.10279	1100	V11 Ballabio	03/05							41.10636
1200	Breva (LPG00/LPG01)	08								41.10605	1200	Breva (LPG00/LPG01)	08	41.10310	41.10651					
1200	Griso 8V (LSE/LSE03)	07/08								41.10605	1200	Griso 8V (LSE/LSE03)	07/08							41.10636
1200	Norge (LSE00/LSE03)	06/07								41.10605	1200	Norge (LSE00/LSE03)	06/07	41.10310	41.10651					
1200	Sport 4V (LPM00/LPM01)	06/07								41.10605	1200	Sport 4V (LPM00/LPM01)	06/07	41.10310	41.10651					

MONTESA HONDA

250	Cota 315 R	97/99									250	Cota 315 R	97/99							41.10652
250	Cota 315 R	00/04								41.10283	250	Cota 315 R	00/04							41.10630
440	4RT	05/07								41.10283	440	4RT	05/07							41.10630

Applicazioni cc marca/modello		anno	A		B		C	D	E	Applicazioni cc marca/modello		anno	F	G	H	I	L	
			kit cuscinetti ruota ant.	kit cuscinetti ruota post.	kit distanziali ruota ant.	kit distanziali ruota post.	kit cuscinetti albero motore	kit tenuta albero secondario	kit cuscinetti e parapolvere sterzo				Kit paraolio e parapolvere forcella	Kit paraolio forcella	Kit cuscinetti forcellone	Kit revisione leveraggi	Kit cuscinetti mono inf.	Kit cuscinetti mono sup.
SHERCO																		
80	0.8	04/10							41.10280	80	0.8	04/10						
125	1.25	99/10							41.10280	125	1.25	99/10		41.10652				
125	1.25	11/12							41.10280	125	1.25	11/12						
200	2.0	99/09							41.10280	200	2.0	99/09		41.10652				
250	SE 2.5I Enduro	08/11	41.10002						41.10299	250	SE 2.5I Enduro	08/11		41.10641			41.10551	
250	SE 2.5I Enduro	12	41.10002						41.10299	250	SE 2.5I Enduro	12					41.10551	
250	SX 2.5I F	10	41.10002						41.10299	250	SX 2.5I F	10		41.10641			41.10551	
250	2.5	99/10							41.10280	250	2.5	99/10		41.10652				
250	2.5	11/12							41.10280	250	2.5	11/12						
290	2.9	99/11							41.10280	290	2.9	99/11		41.10652				
290	2.9	12							41.10280	290	2.9	12						
300	SE 3.0I Enduro	10/11	41.10002						41.10299	300	SE 3.0I Enduro	10/11		41.10641			41.10551	
300	SE 3.0I Enduro	12	41.10002						41.10299	300	SE 3.0I Enduro	12					41.10551	
320	3.2 4T	07/09							41.10280	320	3.2 4T	07/09		41.10652				
450	4.5I Enduro	04/11	41.10002						41.10299	450	4.5I Enduro	04/11		41.10641			41.10551	
450	4.5I Enduro	12	41.10002						41.10299	450	4.5I Enduro	12					41.10551	
450	4.5I Supermotard	04/08	41.10002						41.10299	450	4.5I Supermotard	04/08		41.10641			41.10551	
510	SE 5.1I Enduro	07/11	41.10002						41.10299	510	SE 5.1I Enduro	07/11		41.10641			41.10551	
510	SE 5.1I Enduro	12	41.10002						41.10299	510	SE 5.1I Enduro	12					41.10551	
510	5.1I Supermotard	07/08	41.10002						41.10299	510	5.1I Supermotard	07/08		41.10641			41.10551	

SUZUKI

50	OR	80								50	OR	80		41.10618				
50	RM	78/80							41.10300	50	RM	78/80		41.10618				
60	RM	79/83							41.10300	60	RM	79/83		41.10618				
60	RM	03	41.10032	41.10135					41.10294	60	RM	03	41.10317	41.10621	41.10381			
65	RM	03/05	41.10032	41.10135					41.10288	65	RM	03/05	41.10317	41.10624	41.10381	41.10468	41.10541	
70	DR Z	08/09	41.10048						41.10300	70	DR Z	08/09						
75	TM	74/76								75	TM	74/76		41.10619				
75	TS	75/77							41.10300	75	TS	75/77						
80	DS	78/00							41.10300	80	DS	78/00		41.10618				
80	JR	01/04							41.10300	80	JR	01/04		41.10618				
80	RM	77/78							41.10300	80	RM	77/78		41.10619				
80	RM	79/81							41.10300	80	RM	79/81		41.10621				
80	RM RB	82/85							41.10300	80	RM RB	82/85		41.10621				
80	RM RB	86/88							41.10301	80	RM RB	86/88	41.10317	41.10624				
80	RM RB	89							41.10231	80	RM RB	89		41.10625				
80	RM RB	90/01	41.10010	41.10104					41.10231	80	RM RB	90/01		41.10625				41.10532
85	RM RB	02	41.10010	41.10104					41.10231	85	RM RB	02	41.10318	41.10628				41.10532
85	RM RB	03	41.10010	41.10104					41.10231	85	RM RB	03	41.10318	41.10628	41.10400			41.10532
85	RM RB	04	41.10010	41.10104					41.10231	85	RM RB	04	41.10318	41.10628	41.10400	41.10490	41.10553	41.10532
85	RM RB	05/12	41.10010	41.10104					41.10231	85	RM RB	05/12	41.10318	41.10628	41.10400	41.10491	41.10551	41.10532
85	RM RA	02	41.10010	41.10104					41.10231	85	RM RA	02	41.10318	41.10628				41.10532
85	RM RA	03	41.10010	41.10104					41.10231	85	RM RA	03	41.10318	41.10628	41.10400			41.10532
85	RM RA	04	41.10010	41.10104					41.10231	85	RM RA	04	41.10318	41.10628	41.10400	41.10490	41.10553	41.10532
85	RM RA	05/12	41.10010	41.10104					41.10231	85	RM RA	05/12	41.10318	41.10628	41.10400	41.10491	41.10551	41.10532
90	RV	72/77							41.10300	90	RV	72/77						
100	DR	83/90							41.10300	100	DR	83/90		41.10621				
100	RM	78/81							41.10300	100	RM	78/81		41.10619				
100	RM	76/78							41.10302	100	RM	76/78		41.10620				
100	RM	79/81		41.10001					41.10303	100	RM	79/81		41.10625				
100	RM	03	41.10032	41.10091					41.10288	100	RM	03	41.10338	41.10627	41.10381	41.10471	41.10541	41.10542

ALL BALLS

ALL BALLS

Applicazioni cc	marca/modello	anno	A		B		C	D	E	Applicazioni cc	marca/modello	anno	F	G	H	I	L	
			kit cuscinetti ruota ant.	kit cuscinetti ruota post.	kit distanziali ruota ant.	kit distanziali ruota post.	kit cuscinetti albero motore	kit tenuta albero secondario	kit cuscinetti e parapolvere sterzo									Kit paraolio e parapolvere forcella
100	SP	83							41.10300	100	SP	83						
100	TS	73/77								100	TS	73/77		41.10620				
100	TS	78/79								100	TS	78/79		41.10619				
100	TS	80/81								100	TS	80/81		41.10621				
110	DR Z	03/05							41.10294	110	DR Z	03/05		41.10621				
125	DR S (SF42A)	82/84							41.10300	125	DR S (SF42A)	82/84						
125	DR SE (SF44A)	86/88							41.10304	125	DR SE (SF44A)	86/88		41.10625				
125	DR SE (SF44A)	94/02							41.10296	125	DR SE (SF44A)	94/02		41.10625				
125	DR Z	03/09							41.10295	125	DR Z	03/09		41.10621				
125	DR Z	12/13							41.10295	125	DR Z	12/13		41.10621				
125	DR Z L	03/09							41.10295	125	DR Z L	03/09		41.10621				
125	DR Z L	12/13							41.10295	125	DR Z L	12/13		41.10621				
125	DS	79/81							41.10300	125	DS	79/81		41.10621				
125	GN Z	82/90							41.10300	125	GN Z	82/90						
125	GN E	91/01							41.10300	125	GN E	91/01						
125	GZ Marauder	98/07							41.10296	125	GZ Marauder	98/07						
125	RG F Gamma (NF41A) N/R	92/94	41.10001						41.10296	125	RG F Gamma (NF41A) N/R	92/94		41.10630				
125	RM	75/76							41.10302	125	RM	75/76		41.10625				
125	RM	77/78							41.10302	125	RM	77/78		41.10627				
125	RM	79/80		41.10001					41.10303	125	RM	79/80		41.10629				
125	RM	81/83	41.10001	41.10001					41.10304	125	RM	81/83		41.10629				
125	RM	84/86	41.10001	41.10001					41.10304	125	RM	84/86		41.10638				
125	RM	87	41.10005							125	RM	87		41.10638				
125	RM	88	41.10005						41.10296	125	RM	88		41.10639				
125	RM	89	41.10005				41.10233		41.10299	125	RM	89		41.10641				
125	RM	90	41.10005				41.10233		41.10299	125	RM	90		41.10634				
125	RM	91	41.10005				41.10233		41.10305	125	RM	91		41.10640				
125	RM	92	41.10005				41.10233	41.10268	41.10305	125	RM	92		41.10640				
125	RM	93/95	41.10005				41.10233	41.10268	41.10298	125	RM	93/95		41.10640				
125	RM	96/99	41.10003				41.10233	41.10268	41.10298	125	RM	96/99		41.10645	41.10393		41.10551	
125	RM	00	41.10003	41.10109		41.10195	41.10233	41.10268	41.10298	125	RM	00		41.10645	41.10393			
125	RM	01	41.10051	41.10109	41.10151	41.10195	41.10233	41.10268	41.10298	125	RM	01	41.10330	41.10643	41.10393			41.10573
125	RM	02/03	41.10051	41.10109	41.10151	41.10195	41.10233	41.10268	41.10298	125	RM	02/03	41.10330	41.10643	41.10393	41.10501	41.10551	41.10573
125	RM	04	41.10051	41.10109	41.10151	41.10195	41.10233	41.10269	41.10298	125	RM	04	41.10330	41.10643	41.10393	41.10502	41.10551	41.10573
125	RM	05/08	41.10051	41.10109	41.10151	41.10195	41.10233	41.10269	41.10306	125	RM	05/08	41.10330	41.10643	41.10393	41.10502	41.10551	41.10573
125	RV Van Van	03/08							41.10296	125	RV Van Van	03/08						
125	RV Tracker	74/77							41.10300	125	RV Tracker	74/77		41.10620				
125	SP	82/83							41.10304	125	SP	82/83						
125	SP	86/88							41.10304	125	SP	86/88		41.10625				
125	TC	73/77							41.10300	125	TC	73/77		41.10620				
125	TF	79/11							41.10300	125	TF	79/11		41.10620				
125	TM	73/75							41.10300	125	TM	73/75		41.10620				
125	TS	71/77							41.10300	125	TS	71/77		41.10620				
125	TS	81							41.10300	125	TS	81						
125	UH Burgman	02/10							41.10296	125	UH Burgman	02/10						
125	VL Intruder LC	00/07							41.10296	125	VL Intruder LC	00/07						
150	UH Burgman	02/06							41.10296	150	UH Burgman	02/06						
175	PE Enduro	78/79							41.10302	175	PE Enduro	78/79		41.10627				
175	PE Enduro	80							41.10296	175	PE Enduro	80		41.10627				
175	PE Enduro	81	41.10001						41.10296	175	PE Enduro	81		41.10627				
175	PE Enduro	82/84	41.10001						41.10296	175	PE Enduro	82/84		41.10629				
175	RS	80/82		41.10001					41.10296	175	RS	80/82		41.10627				
185	DS	78/80							41.10300	185	DS	78/80						
185	TC	74/75							41.10300	185	TC	74/75		41.10620				

Applicazioni		anno	A		B		C	D	E	Applicazioni		anno	F	G	H	I	L	
cc	marca/modello		kit cuscinetti ruota ant.	kit cuscinetti ruota post.	kit distanziali ruota ant.	kit distanziali ruota post.	kit cuscinetti albero motore	kit tenuta albero secondario	kit cuscinetti e parapolvere sterzo	cc	marca/modello		Kit paraolio e parapolvere forcella	Kit paraolio forcella	Kit cuscinetti forcellone	Kit revisione leveraggi	Kit cuscinetti mono inf.	Kit cuscinetti mono sup.
185	TC	76/77		41.10001					41.10300	185	TC	76/77		41.10620				
185	TS	72		41.10001						185	TS	72						
200	DR	86/88							41.10296	200	DR	86/88		41.10625				
200	DR SE	96/09							41.10296	200	DR SE	96/09		41.10625				
200	SP	86/88							41.10304	200	SP	86/88		41.10625				
200	UH Burgman	07/10							41.10296	200	UH Burgman	07/10						
250	AN Burgman	98/07							41.10296	250	AN Burgman	98/07		41.10634				
250	DR L	82/85							41.10304	250	DR L	82/85		41.10627				
250	DR L	90/93							41.10296	250	DR L	90/93		41.10636				
250	DR S	90/95							41.10296	250	DR S	90/95		41.10636				
250	DR-Z	01/07							41.10298	250	DR-Z	01/07		41.10636				
250	DS	80							41.10302	250	DS	80		41.10627				
250	GN	82/83							41.10296	250	GN	82/83		41.10624				
250	GN	85							41.10296	250	GN	85		41.10624				
250	GS	80/81							41.10302	250	GS	80/81		41.10625				
250	GSX F	91/97							41.10296	250	GSX F	91/97						
250	GT Hustler	73/77							41.10302	250	GT Hustler	73/77		41.10624				
250	GZ Marauder	00/10							41.10296	250	GZ Marauder	00/10	41.10318	41.10628				
250	PE Enduro	77/79							41.10302	250	PE Enduro	77/79		41.10627				
250	PE Enduro	80/81							41.10296	250	PE Enduro	80/81		41.10627				
250	RGV Gamma	89/96							41.10296	250	RGV Gamma	89/96		41.10635				
250	RGV Gamma	97							41.10593	250	RGV Gamma	97		41.10635				
250	RL	74/75							41.10300	250	RL	74/75		41.10625				
250	RM	76/78							41.10302	250	RM	76/78		41.10627				
250	RM	79/80		41.10001					41.10303	250	RM	79/80		41.10629				
250	RM	81/82	41.10001	41.10001					41.10304	250	RM	81/82		41.10629				
250	RM	83	41.10001	41.10001					41.10304	250	RM	83		41.10638				
250	RM	84/86	41.10001						41.10304	250	RM	84/86		41.10638				
250	RM	87	41.10005							250	RM	87		41.10638				
250	RM	88	41.10005						41.10296	250	RM	88		41.10639				
250	RM	89/90	41.10005						41.10299	250	RM	89/90		41.10634				
250	RM	91/92	41.10005						41.10305	250	RM	91/92		41.10640				
250	RM	93/95	41.10005						41.10298	250	RM	93/95		41.10640				
250	RM	96/99	41.10003						41.10298	250	RM	96/99		41.10645	41.10393		41.10551	
250	RM	00	41.10003	41.10109		41.10195			41.10298	250	RM	00		41.10645	41.10393			
250	RM	01	41.10051	41.10109	41.10151	41.10195			41.10298	250	RM	01	41.10325	41.10642	41.10393			41.10573
250	RM	02	41.10051	41.10109	41.10151	41.10195			41.10298	250	RM	02	41.10325	41.10642	41.10393	41.10501	41.10551	41.10573
250	RM	03	41.10051	41.10109	41.10151	41.10195	41.10239	41.10271	41.10298	250	RM	03	41.10325	41.10642	41.10393	41.10501	41.10551	41.10573
250	RM	04	41.10051	41.10109	41.10151	41.10195	41.10239	41.10271	41.10298	250	RM	04	41.10330	41.10643	41.10393	41.10502	41.10551	41.10573
250	RM	05/08	41.10051	41.10109	41.10151	41.10195		41.10271	41.10306	250	RM	05/08	41.10330	41.10643	41.10393	41.10502	41.10551	41.10573
250	RMX	89/90							41.10299	250	RMX	89/90		41.10634				
250	RMX	91/92							41.10305	250	RMX	91/92		41.10640				
250	RMX	93/98							41.10298	250	RMX	93/98		41.10640				
250	RMZ 4T	04/06	41.10003	41.10045	41.10140	41.10187	41.10224	41.10260	41.10297	250	RMZ 4T	04/06	41.10331	41.10648	41.10391	41.10482	41.10541	41.10542
250	RMZ 4T	07	41.10053	41.10071	41.10152	41.10196		41.10269	41.10298	250	RMZ 4T	07	41.10330	41.10643	41.10393	41.10502	41.10551	41.10573
250	RMZ 4T	08/09	41.10053	41.10071	41.10152	41.10196		41.10269	41.10307	250	RMZ 4T	08/09	41.10330	41.10643	41.10393	41.10502	41.10551	41.10573
250	RMZ 4T	10/12	41.10053	41.10071	41.10152	41.10196		41.10269	41.10307	250	RMZ 4T	10/12	41.10330	41.10643	41.10393	41.10503	41.10558	41.10573
250	RMZ 4T	13	41.10053	41.10071	41.10152				41.10307	250	RMZ 4T	13			41.10393	41.10504	41.10558	41.10573
250	RS	80/81							41.10296	250	RS	80/81		41.10627				
250	SP	82							41.10304	250	SP	82		41.10625				
250	TM	72/73							41.10302	250	TM	72/73						
250	TM	74/75							41.10302	250	TM	74/75		41.10625				
250	TS Savage	69/76							41.10302	250	TS Savage	69/76						
250	TS Savage	77/79							41.10302	250	TS Savage	77/79		41.10625				

Applicazioni cc marca/modello	anno	A		B		C	D	E	Applicazioni cc marca/modello	anno	F	G	H	I	L	
		kit cuscinetti ruota ant.	kit cuscinetti ruota post.	kit distanziali ruota ant.	kit distanziali ruota post.	kit cuscinetti albero motore	kit tenuta albero secondario	kit cuscinetti e parapolvere sterzo			Kit paraolio e parapolvere forcella	Kit paraolio forcella	Kit cuscinetti forcellone	Kit revisione leveraggi	Kit cuscinetti mono inf.	Kit cuscinetti mono sup.
250 TS Savage	80/81							41.10302	250 TS Savage	80/81		41.10627				
250 TU X	97/01							41.10296	250 TU X	97/01	41.10318	41.10628				
250 TU X	09/12							41.10296	250 TU X	09/12	41.10318	41.10628				
250 VL Intruder LC	00/07							41.10296	250 VL Intruder LC	00/07						
300 GS L	82/83							41.10302	300 GS L	82/83		41.10624				
350 DR (USA)	90/99							41.10296	350 DR (USA)	90/99		41.10636				
350 DR S (SK42A) L-P	90/93							41.10296	350 DR S (SK42A) L-P	90/93		41.10636				
350 DR SE (SK42A) R-W	94/99							41.10296	350 DR SE (SK42A) R-W	94/99		41.10636				
370 DR	78/79							41.10302	370 DR	78/79		41.10627				
370 RM	76/77							41.10302	370 RM	76/77		41.10627				
370 SP	78/79							41.10302	370 SP	78/79		41.10627				
380 GT Sebring	73							41.10302	380 GT Sebring	73						
380 GT Sebring	74/77							41.10302	380 GT Sebring	74/77		41.10624				
400 AN Burgman	03/06							41.10296	400 AN Burgman	03/06		41.10634				
400 AN Burgman (K7/K8/K9/L0/L1)	06/12							41.10296	400 AN Burgman (K7/K8/K9/L0/L1)	06/12		41.10634				
400 DR	80							41.10296	400 DR	80		41.10627				
400 DR Z E	00/08	41.10003						41.10298	400 DR Z E	00/08		41.10645	41.10393			
400 DR Z S	00/12	41.10003						41.10298	400 DR Z S	00/12		41.10645	41.10393			
400 DR Z SM	05/10	41.10003						41.10298	400 DR Z SM	05/10	41.10330	41.10643	41.10393			
400 GN E	80/82							41.10296	400 GN E	80/82		41.10625				
400 GN T	81/82							41.10296	400 GN T	81/82		41.10625				
400 GN X	80/81							41.10296	400 GN X	80/81		41.10625				
400 GS B	77/78							41.10302	400 GS B	77/78		41.10624				
400 GS C	77/78							41.10302	400 GS C	77/78		41.10624				
400 GS XB	77/78							41.10302	400 GS XB	77/78		41.10624				
400 GS XC	77/78							41.10302	400 GS XC	77/78		41.10624				
400 GSF Bandit (GK7AA)	91/93							41.10296	400 GSF Bandit (GK7AA)	91/93		41.10634				
400 GSX R	90/94							41.10296	400 GSX R	90/94		41.10634				
400 PE Enduro	80/81							41.10296	400 PE Enduro	80/81		41.10627				
400 RM	78							41.10302	400 RM	78		41.10627				
400 RM	79/80		41.10001					41.10303	400 RM	79/80		41.10629				
400 TM	71/73							41.10302	400 TM	71/73						
400 TM	75							41.10302	400 TM	75		41.10625				
400 TS Apache	72/77							41.10302	400 TS Apache	72/77						
425 GS	79							41.10302	425 GS	79		41.10624				
450 GS E	80/83							41.10296	450 GS E	80/83		41.10624				
450 GS E	84/88							41.10296	450 GS E	84/88		41.10625				
450 RMX 4T	10/11	41.10053	41.10071	41.10152	41.10196		41.10272	41.10307	450 RMX 4T	10/11	41.10330	41.10643	41.10393	41.10503	41.10558	41.10573
450 RMZ 4T	05/07	41.10053	41.10071	41.10152	41.10196		41.10272	41.10306	450 RMZ 4T	05/07	41.10330	41.10643	41.10393	41.10502	41.10551	41.10573
450 RMZ 4T	08/09	41.10053	41.10071	41.10152	41.10196		41.10272	41.10307	450 RMZ 4T	08/09	41.10330	41.10643	41.10393	41.10502	41.10551	41.10573
450 RMZ 4T	10/12	41.10053	41.10071	41.10152	41.10196		41.10272	41.10307	450 RMZ 4T	10/12	41.10330	41.10643	41.10393	41.10503	41.10558	41.10573
450 RMZ 4T	13	41.10053	41.10071	41.10152				41.10307	450 RMZ 4T	13			41.10393	41.10504	41.10558	41.10573
465 RM	81/82	41.10001						41.10304	465 RM	81/82		41.10638				
500 DR	81/83							41.10296	500 DR	81/83		41.10627				
500 GS E (GM51A) (2Cil.)	89/02							41.10296	500 GS E (GM51A) (2Cil.)	89/02						
500 GS K/H/FH (BK111/BK211/BK221/BK411) (2Cil.)	04/09							41.10296	500 GS K/H/FH (BK111/BK211/BK221/BK411) (2Cil.)	04/09						
500 GT Titan	76/77							41.10302	500 GT Titan	76/77		41.10625				
500 RE5 Rotary	75/76							41.10302	500 RE5 Rotary	75/76		41.10625				
500 RM	83/84	41.10001						41.10304	500 RM	83/84		41.10638				
500 SP	81/83							41.10296	500 SP	81/83		41.10627				
500 T Titan	75							41.10302	500 T Titan	75						
550 GS (B/N)	77/79							41.10302	550 GS (B/N)	77/79		41.10625				
550 GS (LT/LX)	80/81							41.10296	550 GS (LT/LX)	80/81		41.10625				
550 GS E	82							41.10296	550 GS E	82		41.10625				

Applicazioni cc	marca/modello	anno	A		B		C	D	E	Applicazioni cc	marca/modello	anno	F	G	H	I	L	
			kit cuscinetti ruota ant.	kit cuscinetti ruota post.	kit distanziali ruota ant.	kit distanziali ruota post.	kit cuscinetti albero motore	kit tenuta albero secondario	kit cuscinetti e parapolvere sterzo				Kit paraolio e parapolvere forcella	Kit paraolio forcella	Kit cuscinetti forcellone	Kit revisione leveraggi	Kit cuscinetti mono inf.	Kit cuscinetti mono sup.
550	GS E	83/86							41.10296	550	GS E	83/86						
550	GT	72	41.10001						41.10302	550	GT	72		41.10625				
550	GT	73/75							41.10302	550	GT	73/75		41.10625				
600	GSF Bandit S	96/03							41.10296	600	GSF Bandit S	96/03		41.10634				
600	GSR	06/07							41.10593	600	GSR	06/07		41.10639				
600	GSX F	88/06							41.10296	600	GSX F	88/06		41.10635				
600	GSX R	92/93							41.10296	600	GSX R	92/93		41.10635				
600	GSX R	97/03							41.10593	600	GSX R	97/03		41.10640				
600	GSX R	04/05							41.10593	600	GSX R	04/05		41.10636				
600	GSX R	06/12							41.10593	600	GSX R	06/12		41.10635				
600	RF R (GN76A)	94/96							41.10296	600	RF R (GN76A)	94/96		41.10635				
600	SP	85	41.10001						41.10304	600	SP	85						
600	VS GL Intruder	95/97							41.10296	600	VS GL Intruder	95/97		41.10630				
650	AN Burgman	03/12							41.10296	650	AN Burgman	03/12		41.10634				
650	DL V Strom	04/11							41.10593	650	DL V Strom	04/11		41.10636				
650	DL V Strom ABS	04/12							41.10593	650	DL V Strom ABS	04/12		41.10636				
650	DR RS (SP42A)	90/91							41.10296	650	DR RS (SP42A)	90/91		41.10634				
650	DR RSE (SP43A)	92/96							41.10296	650	DR RSE (SP43A)	92/96		41.10634				
650	DR RSE (SP43A)	90/95							41.10304	650	DR RSE (SP43A)	90/95		41.10634				
650	DR SE (SP46A)	96/12							41.10298	650	DR SE (SP46A)	96/12		41.10638				
650	GR Temper	83							41.10296	650	GR Temper	83		41.10625				
650	GS E	81/82							41.10296	650	GS E	81/82		41.10625				
650	GS G	83							41.10296	650	GS G	83		41.10625				
650	GS GL	83								650	GS GL	83		41.10625				
650	GS GLX	81/82							41.10296	650	GS GLX	81/82		41.10625				
650	GS GLZ	81/82							41.10296	650	GS GLZ	81/82		41.10625				
650	GS GX Katana	81/82							41.10296	650	GS GX Katana	81/82		41.10625				
650	GS GZ Katana	81/82							41.10296	650	GS GZ Katana	81/82		41.10625				
650	GS M Katana	83							41.10296	650	GS M Katana	83	41.10318	41.10628				
650	GSF N Bandit	05/08							41.10296	650	GSF N Bandit	05/08		41.10634				
650	GSF N Bandit Abs	05/08							41.10296	650	GSF N Bandit Abs	05/08		41.10634				
650	GSF S Bandit	05/08							41.10296	650	GSF S Bandit	05/08		41.10634				
650	GSF S Bandit Abs	08							41.10296	650	GSF S Bandit Abs	08		41.10634				
650	GSX F / GSX F ABS	08/09							41.10296	650	GSX F / GSX F ABS	08/09		41.10634				
650	LS P Savage	86/88							41.10296	650	LS P Savage	86/88		41.10652				
650	LS P Savage	95/12							41.10296	650	LS P Savage	95/12		41.10652				
650	SFV Gladius	09/13							41.10296	650	SFV Gladius	09/13		41.10635				
650	SV	99/02							41.10296	650	SV	99/02		41.10634				
650	SV S	99/02							41.10296	650	SV S	99/02		41.10634				
650	SV	03/09							41.10593	650	SV	03/09		41.10635				
650	SV S	03/09							41.10593	650	SV S	03/09		41.10635				
650	SV ABS	07/09							41.10593	650	SV ABS	07/09		41.10635				
650	SV S ABS	07/09							41.10593	650	SV S ABS	07/09		41.10635				
650	XF Freewind	97/01							41.10298	650	XF Freewind	97/01						
700	GS E	85							41.10296	700	GS E	85	41.10318	41.10628				
700	GV GL Madura	85							41.10296	700	GV GL Madura	85						
700	VS GLEF Intruder	86/87							41.10296	700	VS GLEF Intruder	86/87	41.10318	41.10628				
700	VS GLF Intruder	86/87							41.10296	700	VS GLF Intruder	86/87	41.10318	41.10628				
750	GS E	77/79							41.10302	750	GS E	77/79		41.10625				
750	GS E	80/82							41.10296	750	GS E	80/82		41.10625				
750	GS E	83							41.10296	750	GS E	83	41.10318	41.10628				
750	GS ES	83							41.10296	750	GS ES	83	41.10318	41.10628				
750	GS S Katana	83							41.10296	750	GS S Katana	83						
750	GS T	83							41.10296	750	GS T	83		41.10625				

		A		B		C	D	E			F	G	H	I	L			
<i>Applicazioni cc</i>	<i>marca/modello</i>	<i>anno</i>	<i>kit cuscinetti ruota ant.</i>	<i>kit cuscinetti ruota post.</i>	<i>kit distanziali ruota ant.</i>	<i>kit distanziali ruota post.</i>	<i>kit cuscinetti albero motore</i>	<i>kit tenuta albero secondario</i>	<i>kit cuscinetti e parapolvere sterzo</i>	<i>Applicazioni cc</i>	<i>marca/modello</i>	<i>anno</i>	<i>Kit paraolio e parapolvere forcella</i>	<i>Kit paraolio forcella</i>	<i>Kit cuscinetti forcellone</i>	<i>Kit revisione leveraggi</i>	<i>Kit cuscinetti mono inf.</i>	<i>Kit cuscinetti mono sup.</i>
750	GSX F (GR78A)	89/06							41.10296	750	GSX F (GR78A)	89/06		41.10635				
750	GSX R	86/87							41.10296	750	GSX R	86/87		41.10634				
750	GSX R	88/90							41.10296	750	GSX R	88/90		41.10637				
750	GSX R	91/95							41.10296	750	GSX R	91/95		41.10635				
750	GSX R	96/05							41.10593	750	GSX R	96/05		41.10636				
750	GSX R	06/12							41.10593	750	GSX R	06/12		41.10635				
750	GT (3 Cyl; 2T,Lc)	72	41.10001						41.10302	750	GT (3 Cyl; 2T,Lc)	72		41.10625				
750	GT (3 Cyl; 2T,Lc)	73/77							41.10302	750	GT (3 Cyl; 2T,Lc)	73/77		41.10625				
750	VS GLP Intruder	88/91							41.10296	750	VS GLP Intruder	88/91		41.10630				
800	DR Big	90							41.10296	800	DR Big	90		41.10634				
800	DR Big	91/97							41.10296	800	DR Big	91/97		41.10638				
800	VL Intruder Volusia	01/06							41.10296	800	VL Intruder Volusia	01/06		41.10635				
800	VL Intruder C800	06/12							41.10296	800	VL Intruder C800	06/12		41.10635				
800	VS GL Intruder	92/09							41.10296	800	VS GL Intruder	92/09		41.10630				
800	VX	90/93							41.10296	800	VX	90/93		41.10634				
800	VZ Intruder M800	97/09							41.10296	800	VZ Intruder M800	97/09		41.10634				
850	GS G	79/83							41.10296	850	GS G	79/83						
900	RF R	94/98							41.10296	900	RF R	94/98		41.10636				
1000	DL V Strom	02/09							41.10593	1000	DL V Strom	02/09		41.10636				
1000	GS C	78							41.10296	1000	GS C	78						
1000	GS E (C/N/T)	78/80							41.10296	1000	GS E (C/N/T)	78/80						
1000	GS GL (T/X)	80/81							41.10296	1000	GS GL (T/X)	80/81						
1000	GS G (T/X)	80/81							41.10296	1000	GS G (T/X)	80/81						
1000	GS L (N)	79							41.10296	1000	GS L (N)	79						
1000	GS N	79							41.10296	1000	GS N	79						
1000	GS S (N/T)	79/80							41.10296	1000	GS S (N/T)	79/80						
1000	GS S (Z)	82							41.10296	1000	GS S (Z)	82						
1000	GSX R	01/08							41.10593	1000	GSX R	01/08		41.10639				
1000	GSX R	09/12							41.10593	1000	GSX R	09/12		41.10636				
1000	SV	03/07							41.10593	1000	SV	03/07		41.10641				
1000	SV S	03/07							41.10593	1000	SV S	03/07		41.10641				
1000	TL R	98/03							41.10593	1000	TL R	98/03		41.10639				
1000	TL S	97/01							41.10593	1000	TL S	97/01		41.10638				
1100	GS	82/84							41.10296	1100	GS	82/84						
1100	GS E (D/E/F/G)	83							41.10296	1100	GS E (D/E/F/G)	83						
1100	GSX E (D/E/F/G)	83							41.10296	1100	GSX E (D/E/F/G)	83						
1100	GS ES (D/E/F/G)	83							41.10296	1100	GS ES (D/E/F/G)	83						
1100	GSX ES (D/E/F/G)	83							41.10296	1100	GSX ES (D/E/F/G)	83						
1100	GS E (T/X/Z)	80/82							41.10296	1100	GS E (T/X/Z)	80/82						
1100	GSX E (T/X/Z)	80/82							41.10296	1100	GSX E (T/X/Z)	80/82						
1100	GS L (T)	80							41.10296	1100	GS L (T)	80						
1100	GSX L (T)	80							41.10296	1100	GSX L (T)	80						
1100	GS S (D)	83							41.10296	1100	GS S (D)	83						
1100	GSX S (D)	83							41.10296	1100	GSX S (D)	83						
1100	GSX F	88/93							41.10296	1100	GSX F	88/93		41.10635				
1100	GSX G (M/N/P/R)	91/93							41.10296	1100	GSX G (M/N/P/R)	91/93		41.10638				
1100	GSX R	86/88							41.10296	1100	GSX R	86/88		41.10634				
1100	GSX R	89/96							41.10296	1100	GSX R	89/96		41.10638				
1150	GS EF (E/F/G)	84/86							41.10296	1150	GS EF (E/F/G)	84/86						
1150	GS ES (E/F/G)	84/86							41.10296	1150	GS ES (E/F/G)	84/86						
1200	GSF Bandit	96/05							41.10296	1200	GSF Bandit	96/05		41.10636				
1200	GSF Bandit S	96/05							41.10296	1200	GSF Bandit S	96/05		41.10636				
1200	GSX Inazuma	99/01							41.10296	1200	GSX Inazuma	99/01		41.10636				
1200	GV GL Madura	85/86							41.10296	1200	GV GL Madura	85/86		41.10634				

Applicazioni cc marca/modello	anno	A		B		C	D	E	Applicazioni cc marca/modello	anno	F Kit paraolio e parapolvere forcella	G Kit paraolio forcella	H Kit cuscinetti forcellone	I Kit revisione leveraggi	L	
		kit cuscinetti ruota ant.	kit cuscinetti ruota post.	kit distanziali ruota ant.	kit distanziali ruota post.	kit cuscinetti albero motore	kit tenuta albero secondario	kit cuscinetti e parapolvere sterzo							Kit cuscinetti mono inf.	Kit cuscinetti mono sup.
1250 GSF N Bandit	07/09							41.10296	1250 GSF N Bandit	07/09		41.10636				
1250 GSF S Bandit Abs	07/09							41.10296	1250 GSF S Bandit Abs	07/09		41.10636				
1250 GSX F	10/12							41.10296	1250 GSX F	10/12		41.10636				
1340 GSX B King	08/09							41.10593	1340 GSX B King	08/09		41.10639				
1300 GSX R Hayabusa	99/07							41.10593	1300 GSX R Hayabusa	99/07		41.10639				
1340 GSX R Hayabusa	08/12							41.10593	1340 GSX R Hayabusa	08/12		41.10639				
1400 GSX	02/07							41.10296	1400 GSX	02/07		41.10641				
1400 GV GD Cavalcade LX	86/88							41.10296	1400 GV GD Cavalcade LX	86/88		41.10634				
1400 VS - VS GL Intruder	87/09							41.10296	1400 VS - VS GL Intruder	87/09		41.10635				
1500 VL Intruder	98/09							41.10296	1500 VL Intruder	98/09		41.10635				
1600 VZ Marauder	05	41.10079						41.10602	1600 VZ Marauder	05		41.10636				
1800 VLR C R Intruder	09							41.10296	1800 VLR C R Intruder	09						
1800 VZR M R Intruder	06/12							41.10296	1800 VZR M R Intruder	06/12		41.10641				

TRIUMPH

600 Daytona (T806LW)	04							41.10609	600 Daytona (T806LW)	04						
600 Speed Four (T801/811-T806LB)	03/05							41.10297	600 Speed Four (T801/811-T806LB)	03/05		41.10639				
600 TT (T800)	00/03							41.10609	600 TT (T800)	00/03		41.10639				
650 Daytona (T385-T806LX)	05							41.10609	650 Daytona (T385-T806LX)	05		41.10639				
675 Daytona (TD10)	06/12							41.10593	675 Daytona (TD10)	06/12						
675 Street Triple	07/12							41.10593	675 Street Triple	07/12						
750 Daytona	91/92							41.10608	750 Daytona	91/92		41.10638				
750 Thunderbird	95							41.10608	750 Thunderbird	95		41.10638				
750 Trident	91/93							41.10608	750 Trident	91/93		41.10638				
750 Trident	96							41.10608	750 Trident	96		41.10638				
790 America	03/06							41.10599	790 America	03/06		41.10634				
790 Bonneville (908MD)	01/06							41.10599	790 Bonneville (908MD)	01/06		41.10634				
790 Speedmaster (908ML)	03/04							41.10599	790 Speedmaster (908ML)	03/04		41.10634				
790 Bonneville T100	02/03							41.10599	790 Bonneville T100	02/03		41.10634				
800 Tiger	11/12							41.10593	800 Tiger	11/12		41.10636				
900 Tiger (T409EN)	00							41.10608	900 Tiger (T409EN)	00						
865 America	07/09							41.10599	865 America	07/09		41.10634				
680 America	11/12							41.10599	680 America	11/12		41.10634				
865 Bonneville T100	05/12							41.10599	865 Bonneville T100	05/12		41.10634				
865 Scrambler	06/12							41.10599	865 Scrambler	06/12		41.10634				
865 Speedmaster	05/12							41.10599	865 Speedmaster	05/12		41.10634				
865 Thruxton (T914)	04/12							41.10599	865 Thruxton (T914)	04/12		41.10634				
885 Speed Triple Carb. (T301)	94/96							41.10608	885 Speed Triple Carb. (T301)	94/96		41.10638				
900 Legend TT (T309RT)	99/01							41.10608	900 Legend TT (T309RT)	99/01						
885 Speed Triple (T509)	98							41.10608	885 Speed Triple (T509)	98		41.10640				
900 Thunderbird (T309RT)	95/98							41.10608	900 Thunderbird (T309RT)	95/98						
900 Thunderbird (T309RT)	00/03							41.10608	900 Thunderbird (T309RT)	00/03						
900 Thunderbird Sport (T309RD)	99/00							41.10608	900 Thunderbird Sport (T309RD)	99/00		41.10639				
900 Thunderbird Sport (T309RD)	03/04							41.10608	900 Thunderbird Sport (T309RD)	03/04		41.10639				
900 Adventurer (T309RC)	96/98							41.10608	900 Adventurer (T309RC)	96/98		41.10638				
900 Adventurer (T309RC)	00/01							41.10608	900 Adventurer (T309RC)	00/01						
900 Daytona (T309)	95/96							41.10608	900 Daytona (T309)	95/96		41.10638				
900 Daytona Super 3 (T311/312/313)	95							41.10608	900 Daytona Super 3 (T311/312/313)	95		41.10638				
900 Sprint Carb. (T388)	95/97							41.10608	900 Sprint Carb. (T388)	95/97		41.10638				
900 Sprint Sport Carb. (T388)	98							41.10608	900 Sprint Sport Carb. (T388)	98		41.10638				
900 Thunderbird (T309RT)	95/98							41.10608	900 Thunderbird (T309RT)	95/98		41.10638				
900 Thunderbird Sport (T309RD)	98							41.10608	900 Thunderbird Sport (T309RD)	98		41.10638				
900 Tiger (T409EN)	95/99							41.10608	900 Tiger (T409EN)	95/99		41.10638				

		A		B		C	D	E			F	G	H	I	L			
Applicazioni cc	marca/modello	anno	kit cuscinetti ruota ant.	kit cuscinetti ruota post.	kit distanziali ruota ant.	kit distanziali ruota post.	kit cuscinetti albero motore	kit tenuta albero secondario	kit cuscinetti e parapolvere sterzo	Applicazioni cc	marca/modello	anno	Kit paraolio e parapolvere forcella	Kit paraolio forcella	Kit cuscinetti forcellone	Kit revisione leveraggi	Kit cuscinetti mono inf.	Kit cuscinetti mono sup.
900	Trident (T309R)	91/92							41.10608	900	Trident (T309R)	91/92		41.10638				
900	Trident (T309R)	95/98							41.10608	900	Trident (T309R)	95/98		41.10638				
900	Trophy (T309ST)	91/92							41.10608	900	Trophy (T309ST)	91/92		41.10638				
900	Trophy (T309ST)	95/00							41.10608	900	Trophy (T309ST)	95/00		41.10638				
955	Daytona IE (T502/T595) (Monobraccio)	99/00							41.10608	955	Daytona IE (T502/T595) (Monobraccio)	99/00		41.10640				
955	Daytona IE (T502/T595) (Bibraccio)	01/06							41.10608	955	Daytona IE (T502/T595) (Bibraccio)	01/06		41.10640				
955	Speed Triple (T508/T551/T566)	99/03							41.10608	955	Speed Triple (T508/T551/T566)	99/03		41.10640				
955	Daytona IE (T502/T595) (Bibraccio)	04	41.10061						41.10608	955	Daytona IE (T502/T595) (Bibraccio)	04		41.10640				
955	Sprint RS IE (T625)	00/03							41.10608	955	Sprint RS IE (T625)	00/03						
955	Sprint ST	99/04							41.10608	955	Sprint ST	99/04		41.10636				
955	Sprint ST	05/06	41.10061						41.10593	955	Sprint ST	05/06		41.10636				
955	Daytona (T502/T595)	97							41.10608	955	Daytona (T502/T595)	97		41.10638				
955	Daytona (T502/T595)	98							41.10608	955	Daytona (T502/T595)	98		41.10640				
955	Tiger (T720)	01/06							41.10608	955	Tiger (T720)	01/06		41.10639				
1000	Daytona	91/92							41.10608	1000	Daytona	91/92		41.10638				
1050	Speed Triple / ABS	05/06	41.10061						41.10608	1050	Speed Triple / ABS	05/06						
1050	Speed Triple / ABS	07/10	41.10061						41.10608	1050	Speed Triple / ABS	07/10		41.10636				
1050	Speed Triple / ABS	11/12							41.10593	1050	Speed Triple / ABS	11/12		41.10636				
1050	Sprint ST	07/12	41.10061						41.10593	1050	Sprint ST	07/12		41.10636				
1050	Tiger / Tiger SE ABS	07/12	41.10061						41.10593	1050	Tiger / Tiger SE ABS	07/12		41.10636				
1200	Trophy	91/98							41.10608	1200	Trophy	91/98		41.10638				
1200	Trophy	99/03							41.10608	1200	Trophy	99/03						
1600	Thunderbird / SE	09/12							41.10608	1600	Thunderbird / SE	09/12	41.10330	41.10643				
2300	Rocket 3	05/12							41.10608	2300	Rocket 3	05/12		41.10639				

TM

85	MX Cross 2T	06	41.10005						41.10288	85	MX Cross 2T	06						
85	MX Cross 2T	08/09	41.10005						41.10288	85	MX Cross 2T	08/09						
125	EN Enduro 2T	96/97	41.10005						41.10288	125	EN Enduro 2T	96/97	41.10310	41.10651				
125	EN Enduro 2T	98/01	41.10005						41.10593	125	EN Enduro 2T	98/01	41.10310	41.10651				
125	EN Enduro 2T	02/04	41.10005						41.10286	125	EN Enduro 2T	02/04	41.10310	41.10651				
125	EN Enduro 2T	05/08							41.10286	125	EN Enduro 2T	05/08						
125	EN Enduro 2T	09/11							41.10286	125	EN Enduro 2T	09/11	41.10334	41.10646				
125	MX Cross 2T	96/97	41.10005						41.10288	125	MX Cross 2T	96/97	41.10310	41.10651				
125	MX Cross 2T	98/01	41.10005						41.10593	125	MX Cross 2T	98/01	41.10310	41.10651				
125	MX Cross 2T	02/04	41.10005						41.10286	125	MX Cross 2T	02/04	41.10310	41.10651				
125	MX Cross 2T	05/08							41.10286	125	MX Cross 2T	05/08						
125	MX Cross 2T	09/11							41.10286	125	MX Cross 2T	09/11	41.10334	41.10646				
125	SMR 2T	09							41.10286	125	SMR 2T	09	41.10334	41.10646				
125	SMR 2T	05/08							41.10286	125	SMR 2T	05/08						
144	MX Cross 2T	08							41.10286	144	MX Cross 2T	08						
144	MX Cross 2T	09/11							41.10286	144	MX Cross 2T	09/11	41.10334	41.10646				
250	EN Enduro 2T	96/97	41.10005						41.10288	250	EN Enduro 2T	96/97	41.10310	41.10651				
250	EN Enduro 2T	98/01	41.10005						41.10593	250	EN Enduro 2T	98/01	41.10310	41.10651				
250	EN Enduro 2T	02/04	41.10005						41.10286	250	EN Enduro 2T	02/04	41.10310	41.10651				
250	EN Enduro 2T	05/08							41.10286	250	EN Enduro 2T	05/08						
250	EN Enduro 2T	09/11							41.10286	250	EN Enduro 2T	09/11	41.10334	41.10646				
250	EN F Enduro 4T	02/04	41.10005						41.10286	250	EN F Enduro 4T	02/04	41.10310	41.10651				
250	EN F Enduro 4T	05/08							41.10286	250	EN F Enduro 4T	05/08						
250	EN F Enduro 4T	09/11							41.10286	250	EN F Enduro 4T	09/11	41.10334	41.10646				
250	MX Cross 2T	96/97	41.10005						41.10288	250	MX Cross 2T	96/97	41.10310	41.10651				
250	MX Cross 2T	98/01	41.10005						41.10593	250	MX Cross 2T	98/01	41.10310	41.10651				
250	MX Cross 2T	02/04	41.10005						41.10286	250	MX Cross 2T	02/04	41.10310	41.10651				

		A		B		C	D	E			F	G	H	I	L			
<i>Applicazioni cc</i>	<i>marca/modello</i>	<i>anno</i>	<i>kit cuscinetti ruota ant.</i>	<i>kit cuscinetti ruota post.</i>	<i>kit distanziali ruota ant.</i>	<i>kit distanziali ruota post.</i>	<i>kit cuscinetti albero motore</i>	<i>kit tenuta albero secondario</i>	<i>kit cuscinetti e parapolvere sterzo</i>	<i>Applicazioni cc</i>	<i>marca/modello</i>	<i>anno</i>	<i>Kit paraolio e parapolvere forcella</i>	<i>Kit paraolio forcella</i>	<i>Kit cuscinetti forcellone</i>	<i>Kit revisione leveraggi</i>	<i>Kit cuscinetti mono inf.</i>	<i>Kit cuscinetti mono sup.</i>
250	MX Cross 2T	05/08							41.10286	250	MX Cross 2T	05/08						
250	MX Cross 2T	09/11							41.10286	250	MX Cross 2T	09/11	41.10334	41.10646				
250	MX F Cross 4T	02/04	41.10005						41.10286	250	MX F Cross 4T	02/04	41.10310	41.10651				
250	MX F Cross 4T	05/08							41.10286	250	MX F Cross 4T	05/08						
250	MX F Cross 4T	09/11							41.10286	250	MX F Cross 4T	09/11	41.10334	41.10646				
300	EN Enduro 2T	97	41.10005						41.10288	300	EN Enduro 2T	97	41.10310	41.10651				
300	EN Enduro 2T	98/01	41.10005						41.10593	300	EN Enduro 2T	98/01	41.10310	41.10651				
300	EN Enduro 2T	02/04	41.10005						41.10286	300	EN Enduro 2T	02/04	41.10310	41.10651				
300	EN Enduro 2T	05/08							41.10286	300	EN Enduro 2T	05/08						
300	EN Enduro 2T	09/11							41.10286	300	EN Enduro 2T	09/11	41.10334	41.10646				
300	MX Cross 2T	97	41.10005						41.10288	300	MX Cross 2T	97	41.10310	41.10651				
300	MX Cross 2T	98/01	41.10005						41.10593	300	MX Cross 2T	98/01	41.10310	41.10651				
300	MX Cross 2T	02/04	41.10005						41.10286	300	MX Cross 2T	02/04	41.10310	41.10651				
300	MX Cross 2T	05/08							41.10286	300	MX Cross 2T	05/08						
300	MX Cross 2T	09/11							41.10286	300	MX Cross 2T	09/11	41.10334	41.10646				
400	EN F Enduro 4T	02/03	41.10005						41.10286	400	EN F Enduro 4T	02/03	41.10310	41.10651				
400	MX F Cross 4T	02/03	41.10005						41.10286	400	MX F Cross 4T	02/03	41.10310	41.10651				
450	EN F Enduro 4T	04	41.10005						41.10286	450	EN F Enduro 4T	04	41.10310	41.10651				
450	EN F Enduro 4T	05/08							41.10286	450	EN F Enduro 4T	05/08						
450	EN F Enduro 4T	09/11							41.10286	450	EN F Enduro 4T	09/11	41.10334	41.10646				
450	MX F Cross 4T	04	41.10005						41.10286	450	MX F Cross 4T	04	41.10310	41.10651				
450	MX F Cross 4T	05/08							41.10286	450	MX F Cross 4T	05/08						
450	MX F Cross 4T	09/11							41.10286	450	MX F Cross 4T	09/11	41.10334	41.10646				
450	SMR F 4T	08/09							41.10286	450	SMR F 4T	08/09						
450	SMX F 4T	05/07							41.10286	450	SMX F 4T	05/07						
530	EN F Enduro 4T	02/04	41.10005						41.10286	530	EN F Enduro 4T	02/04	41.10310	41.10651				
530	EN F Enduro 4T	05/08							41.10286	530	EN F Enduro 4T	05/08						
530	EN F Enduro 4T	09/11							41.10286	530	EN F Enduro 4T	09/11	41.10334	41.10646				
530	MX F Cross 4T	02/04	41.10005						41.10286	530	MX F Cross 4T	02/04	41.10310	41.10651				
530	MX F Cross 4T	05/08							41.10286	530	MX F Cross 4T	05/08						
530	MX F Cross 4T	09/11							41.10286	530	MX F Cross 4T	09/11	41.10334	41.10646				
530	SMR F 4T	08/09							41.10286	530	SMR F 4T	08/09						
660	SMX F 4T	05/09							41.10286	660	SMX F 4T	05/09						

VICTORY

1507	92 Classic Cruiser	03							41.10291	1507	92 Classic Cruiser	03	41.10310	41.10651				
1507	92 Deluxe Cruiser	01/02							41.10291	1507	92 Deluxe Cruiser	01/02	41.10310	41.10651				
1507	92 Deluxe Touring Cruiser	02							41.10291	1507	92 Deluxe Touring Cruiser	02	41.10310	41.10651				
1507	92 Kingpin	04							41.10296	1507	92 Kingpin	04		41.10636				
1507	92 Special Edition	00							41.10291	1507	92 Special Edition	00						
1507	92 Sport Cruiser	00/01							41.10291	1507	92 Sport Cruiser	00/01		41.10646				
1507	92 Standard Cruiser	99							41.10291	1507	92 Standard Cruiser	99	41.10310	41.10651				
1507	92 Standard Cruiser	00/02							41.10291	1507	92 Standard Cruiser	00/02						
1507	92 Touring Cruiser	02/04							41.10291	1507	92 Touring Cruiser	02/04	41.10310	41.10651				
1507	92 Vegas	03/05							41.10296	1507	92 Vegas	03/05		41.10639				
1634	100 Hammer	05/07							41.10296	1634	100 Hammer	05/07		41.10636				
1634	100 Jackpot	06/07							41.10296	1634	100 Jackpot	06/07		41.10639				
1634	100 Kingpin	05/07							41.10296	1634	100 Kingpin	05/07		41.10636				
1634	100 Touring Cruiser	05/06							41.10291	1634	100 Touring Cruiser	05/06	41.10310	41.10651				
1634	100 Vegas 8 Ball	06/07							41.10296	1634	100 Vegas 8 Ball	06/07		41.10639				
1731	106 Boardwalk	13							41.10611	1731	106 Boardwalk	13		41.10639				
1731	106 Cross Country/Cross Roads	10/13							41.10611	1731	106 Cross Country/Cross Roads	10/13						
1731	106 Hammer	08							41.10296	1731	106 Hammer	08		41.10636				

Applicazioni cc marca/modello		anno	A		B		C	D	E	Applicazioni cc marca/modello		anno	F	G	H	I	L	
			kit cuscinetti ruota ant.	kit cuscinetti ruota post.	kit distanziali ruota ant.	kit distanziali ruota post.	kit cuscinetti albero motore	kit tenuta albero secondario	kit cuscinetti e parapolvere sterzo				Kit paraolio e parapolvere forcella	Kit paraolio forcella	Kit cuscinetti forcellone	Kit revisione leveraggi	Kit cuscinetti mono inf.	Kit cuscinetti mono sup.
1731 106 Hammer	09/13								41.10611	1731 106 Hammer	09/13							
1731 106 Highball	12/13								41.10611	1731 106 Highball	12/13		41.10639					
1731 106 Jackpot	08/13								41.10611	1731 106 Jackpot	08/13		41.10639					
1731 106 Judge	13								41.10611	1731 106 Judge	13		41.10639					
1731 106 Kingpin	08								41.10296	1731 106 Kingpin	08		41.10636					
1731 106 Kingpin	09/12								41.10611	1731 106 Kingpin	09/12							
1731 106 Vegas 8 Ball	08/13								41.10611	1731 106 Vegas 8 Ball	08/13		41.10639					
1731 106 Vision	08								41.10611	1731 106 Vision	08	41.10310	41.10651					
1731 106 Vision	09/13								41.10611	1731 106 Vision	09/13							

YAMAHA

50 DT Enduro	88/89								41.10308	50 DT Enduro	88/89		41.10620					
50 PW	81/09								41.10614	50 PW	81/09							
50 QT	81/09								41.10614	50 QT	81/09							
50 TT R	06/09	41.10048	41.10048						41.10308	50 TT R	06/09							
50 TT R	12/13	41.10048	41.10048						41.10308	50 TT R	12/13							
50 YSR	87/92								41.10308	50 YSR	87/92		41.10619					
50 YZ	80								41.10308	50 YZ	80		41.10618					
60 RD	73/75								41.10308	60 RD	73/75							
60 YZ	81/83								41.10308	60 YZ	81/83		41.10618					
80 BW	86/90	41.10043							41.10308	80 BW	86/90		41.10618					
80 DT	81/83								41.10308	80 DT	81/83							
80 GT	73/80								41.10308	80 GT	73/80							
80 LB	76/78								41.10308	80 LB	76/78							
80 MX	80/82								41.10308	80 MX	80/82		41.10618					
80 PW	83/06								41.10308	80 PW	83/06		41.10618					
80 TY	74/75								41.10308	80 TY	74/75							
80 YZ	74/78	41.10043							41.10308	80 YZ	74/78		41.10619					
80 YZ	79/80	41.10043							41.10308	80 YZ	79/80		41.10621					
80 YZ RA	81/82	41.10043							41.10308	80 YZ RA	81/82		41.10621					
80 YZ RA	83	41.10043							41.10308	80 YZ RA	83		41.10623					
80 YZ RA	84/92	41.10043							41.10309	80 YZ RA	84/92		41.10623					
80 YZ RA	93/98	41.10048	41.10104	41.10155	41.10197	41.10241			41.10288	80 YZ RA	93/98	41.10338	41.10627					
80 YZ RA	99/01	41.10048	41.10104	41.10155	41.10197	41.10241			41.10288	80 YZ RA	99/01	41.10338	41.10627	41.10410				
80 YZ RB	81/82	41.10043							41.10308	80 YZ RB	81/82		41.10621					
80 YZ RB	83	41.10043							41.10308	80 YZ RB	83		41.10623					
80 YZ RB	84/92	41.10043							41.10309	80 YZ RB	84/92		41.10623					
80 YZ RB	93/98	41.10048	41.10104	41.10155	41.10197	41.10241			41.10288	80 YZ RB	93/98	41.10338	41.10627					
80 YZ RB	99/01	41.10048	41.10104	41.10155	41.10197	41.10241			41.10288	80 YZ RB	99/01	41.10338	41.10627	41.10410				
85 YZ RA	02	41.10048	41.10104	41.10155	41.10197	41.10241	41.10273		41.10288	85 YZ RA	02	41.10338	41.10627	41.10410				
85 YZ RA	03/13	41.10048	41.10104	41.10155	41.10197	41.10241	41.10273		41.10288	85 YZ RA	03/13	41.10338	41.10627	41.10410	41.10507	41.10560		
85 YZ RB	02	41.10048	41.10104	41.10155	41.10197	41.10241	41.10273		41.10288	85 YZ RB	02	41.10338	41.10627	41.10410				
85 YZ RB	03/13	41.10048	41.10104	41.10155	41.10197	41.10241	41.10273		41.10288	85 YZ RB	03/13	41.10338	41.10627	41.10410	41.10507	41.10560		
90 TT R/RE	00/07								41.10308	90 TT R/RE	00/07		41.10618					
100 DT	74/76								41.10308	100 DT	74/76		41.10620					
100 DT	77/83								41.10308	100 DT	77/83		41.10619					
100 MX	74/75								41.10308	100 MX	74/75		41.10620					
100 MX	79/83								41.10308	100 MX	79/83		41.10619					
100 RS	75/76								41.10308	100 RS	75/76		41.10619					
100 RT	90/00								41.10308	100 RT	90/00		41.10619					
100 YZ	76/77								41.10308	100 YZ	76/77		41.10649					
100 YZ	78/79								41.10308	100 YZ	78/79							
100 YZ	80/81								41.10308	100 YZ	80/81		41.10625					
100 YZ	82/83								41.10296	100 YZ	82/83		41.10626					

Applicazioni cc	marca/modello	anno	A		B		C	D	E	Applicazioni cc	marca/modello	anno	F	G	H	I	L		
			kit cuscinetti ruota ant.	kit cuscinetti ruota post.	kit distanziali ruota ant.	kit distanziali ruota post.	kit cuscinetti albero motore	kit tenuta albero secondario	kit cuscinetti e parapolvere sterzo				Kit paraolio e parapolvere forcella	Kit paraolio forcella	Kit cuscinetti forcellone	Kit revisione leveraggi	Kit cuscinetti mono inf.	Kit cuscinetti mono sup.	
110	TT R	08/12							41.10309	110	TT R	08/12		41.10622					
125	DT X Supermotard (2C81/2C82)	05/06							41.10296	125	DT X Supermotard (2C81/2C82)	05/06							
125	DT	74/76							41.10308	125	DT	74/76		41.10620					
125	DT	77							41.10308	125	DT	77							
125	DT	78/81							41.10308	125	DT	78/81		41.10622					
125	DT RE (1D0/1D04)	05/06							41.10296	125	DT RE (1D0/1D04)	05/06							
125	IT	80							41.10308	125	IT	80							
125	IT	81							41.10308	125	IT	81		41.10625					
125	MX	74/75							41.10308	125	MX	74/75		41.10620					
125	MX	76							41.10308	125	MX	76		41.10649					
125	SR / SR SE	99/00							41.10308	125	SR / SR SE	99/00		41.10621					
125	TDR R (4GW/4GX)	93/03							41.10600	125	TDR R (4GW/4GX)	93/03		41.10652					
125	TT	00							41.10309	125	TT	00		41.10620					
125	TT R	00/07							41.10309	125	TT R	00/07		41.10620					
125	TT R	08/09							41.10309	125	TT R	08/09		41.10622					
125	TT R L	00/07							41.10309	125	TT R L	00/07		41.10620					
125	TT R L	08/12							41.10309	125	TT R L	08/12		41.10622					
125	XT	82/83							41.10308	125	XT	82/83							
125	YZ	74/75							41.10308	125	YZ	74/75		41.10620					
125	YZ	75							41.10308	125	YZ	75		41.10649					
125	YZ	77/80							41.10296	125	YZ	77/80		41.10626					
125	YZ	81/83							41.10296	125	YZ	81/83		41.10629					
125	YZ	84/85							41.10296	125	YZ	84/85		41.10636					
125	YZ	86							41.10296	125	YZ	86		41.10638					
125	YZ	87/88						41.10273	41.10299	125	YZ	87/88		41.10638					
125	YZ	89/95						41.10273	41.10299	125	YZ	89/95		41.10634					
125	YZ	96/97						41.10273	41.10305	125	YZ	96/97	41.10325	41.10642					
125	YZ	98	41.10059					41.10273	41.10305	125	YZ	98	41.10325	41.10642					41.10576
125	YZ	99/00	41.10059	41.10120				41.10273	41.10305	125	YZ	99/00	41.10325	41.10642					41.10576
125	YZ	01	41.10059	41.10120			41.10245	41.10273	41.10305	125	YZ	01	41.10325	41.10642			41.10560	41.10576	
125	YZ	02/03	41.10059	41.10120	41.10162	41.10202	41.10245	41.10273	41.10305	125	YZ	02/03	41.10325	41.10642	41.10421	41.10514	41.10560	41.10576	
125	YZ	04	41.10059	41.10120	41.10162	41.10202	41.10245	41.10273	41.10305	125	YZ	04	41.10331	41.10648	41.10421	41.10514	41.10560	41.10576	
125	YZ	05	41.10059	41.10120	41.10162	41.10202	41.10246	41.10274	41.10305	125	YZ	05	41.10331	41.10648	41.10422	41.10515	41.10560	41.10576	
125	YZ	06/07	41.10059	41.10120	41.10162	41.10202	41.10246	41.10274	41.10305	125	YZ	06/07	41.10331	41.10648	41.10423	41.10516	41.10560	41.10576	
125	YZ	08/13	41.10059	41.10120	41.10163	41.10202	41.10246	41.10274	41.10305	125	YZ	08/13	41.10331	41.10648	41.10423	41.10516	41.10560	41.10576	
175	CT	72								175	CT	72		41.10620					
175	DT	74/76							41.10308	175	DT	74/76		41.10620					
175	DT	78							41.10308	175	DT	78		41.10622					
175	DT	79/81							41.10308	175	DT	79/81							
175	IT	77/81	41.10001						41.10296	175	IT	77/81		41.10626					
175	IT	82	41.10001						41.10296	175	IT	82		41.10652					
175	IT	83	41.10001						41.10296	175	IT	83		41.10629					
175	MX	74/75							41.10308	175	MX	74/75		41.10620					
175	MX	79/81							41.10308	175	MX	79/81							
175	TY	75/76							41.10308	175	TY	75/76		41.10620					
175	YZ	76							41.10308	175	YZ	76		41.10626					
180	RT	90/93							41.10308	180	RT	90/93		41.10625					
180	RT	95/98							41.10308	180	RT	95/98		41.10625					
185	SR	81/82							41.10308	185	SR	81/82							
200	AG	84/06							41.10308	200	AG	84/06							
200	BW	85/88							41.10308	200	BW	85/88		41.10623					
200	IT	84/86							41.10296	200	IT	84/86		41.10638					
200	RD	74/76							41.10303	200	RD	74/76		41.10620					
200	TW	87/13							41.10308	200	TW	87/13		41.10623					
200	WR	92							41.10299	200	WR	92		41.10634					

Applicazioni		anno	A		B		C	D	E	Applicazioni		anno	F	G	H	I	L		
cc	marca/modello		kit cuscinetti ruota ant.	kit cuscinetti ruota post.	kit distanziali ruota ant.	kit distanziali ruota post.	kit cuscinetti albero motore	kit tenuta albero secondario	kit cuscinetti e parapolvere sterzo	cc	marca/modello		Kit paraolio e parapolvere forcella	Kit paraolio forcella	Kit cuscinetti forcellone	Kit revisione leveraggi	Kit cuscinetti mono inf.	Kit cuscinetti mono sup.	
200	XT	82/83							41.10308	200	XT	82/83		41.10625					
225	TT	86/87							41.10600	225	TT	86/87		41.10626					
225	TT R	99/04							41.10600	225	TT R	99/04		41.10626					
225	XT	92/07							41.10600	225	XT	92/07		41.10626					
230	TT R	05/12							41.10296	230	TT R	05/12		41.10626					
250	CP X Morphous	06/08							41.10593	250	CP X Morphous	06/08							
250	DT	75/78							41.10308	250	DT	75/78		41.10649					
250	DT	79							41.10308	250	DT	79		41.10626					
250	IT	77/80	41.10001						41.10296	250	IT	77/80		41.10626					
250	IT	81/82	41.10001						41.10296	250	IT	81/82		41.10629					
250	IT	83	41.10001						41.10296	250	IT	83		41.10638					
250	MX	73/75							41.10308	250	MX	73/75							
250	RD	73/75							41.10303	250	RD	73/75		41.10649					
250	SR Exciter	80/82							41.10303	250	SR Exciter	80/82							
250	SRX	87							41.10303	250	SRX	87							
250	TT	80/82							41.10308	250	TT	80/82		41.10626					
250	TT R	99/06							41.10299	250	TT R	99/06		41.10638					
250	TY	74/77							41.10308	250	TY	74/77		41.10649					
250	TZ	72/74	41.10001						41.10303	250	TZ	72/74		41.10649					
250	TZ	75/77	41.10001						41.10303	250	TZ	75/77							
250	TZ	78	41.10001						41.10303	250	TZ	78		41.10625					
250	TZ	80/82	41.10001						41.10303	250	TZ	80/82		41.10627					
250	WR R 2T	91/97							41.10299	250	WR R 2T	91/97		41.10638					
250	WR F	01	41.10060	41.10120				41.10276	41.10305	250	WR F	01	41.10325	41.10642				41.10560	41.10576
250	WR F	02/04	41.10060	41.10120	41.10165	41.10202		41.10276	41.10305	250	WR F	02/04	41.10325	41.10642	41.10421	41.10514	41.10560	41.10576	
250	WR F	05	41.10060	41.10120	41.10166	41.10202		41.10276	41.10305	250	WR F	05	41.10331	41.10648	41.10421	41.10517	41.10560	41.10576	
250	WR F	06	41.10060	41.10120	41.10166	41.10202		41.10276	41.10305	250	WR F	06	41.10331	41.10648	41.10425	41.10518	41.10560	41.10576	
250	WR F	07/13	41.10060	41.10120	41.10166	41.10202		41.10276	41.10305	250	WR F	07/13	41.10331	41.10648	41.10425	41.10519	41.10560	41.10576	
250	WR R 4T (DG201)	08/13		41.10120					41.10305	250	WR R 4T (DG201)	08/13	41.10325	41.10642					
250	WR X 4T (DG202)	08/12		41.10120					41.10305	250	WR X 4T (DG202)	08/12	41.10325	41.10642					
250	XT	80/83							41.10308	250	XT	80/83		41.10625					
250	XT	84							41.10296	250	XT	84		41.10626					
250	XT	08/13							41.10288	250	XT	08/13							
250	XV Virago (3LV,3LS,VG01)	95/07							41.10303	250	XV Virago (3LV,3LS,VG01)	95/07							
250	XV Virago (3LV,3LS,VG01)	09/11							41.10303	250	XV Virago (3LV,3LS,VG01)	09/11							
250	XV Virago / Route 66	88/90							41.10303	250	XV Virago / Route 66	88/90							
250	YZ	74/75							41.10308	250	YZ	74/75		41.10649					
250	YZ	76							41.10308	250	YZ	76		41.10626					
250	YZ	77/80							41.10296	250	YZ	77/80		41.10629					
250	YZ	81/87							41.10296	250	YZ	81/87		41.10638					
250	YZ	88							41.10299	250	YZ	88		41.10638					
250	YZ	89/95							41.10299	250	YZ	89/95		41.10634					
250	YZ	96/97							41.10305	250	YZ	96/97	41.10325	41.10642					
250	YZ	98	41.10059						41.10305	250	YZ	98	41.10325	41.10642					41.10576
250	YZ	99/00	41.10059	41.10120				41.10277	41.10305	250	YZ	99/00	41.10325	41.10642					41.10576
250	YZ	01	41.10059	41.10120			41.10250	41.10277	41.10305	250	YZ	01	41.10325	41.10642			41.10560	41.10576	
250	YZ	02/03	41.10059	41.10120	41.10162	41.10202	41.10250	41.10277	41.10305	250	YZ	02/03	41.10325	41.10642	41.10421	41.10514	41.10560	41.10576	
250	YZ	04	41.10059	41.10120	41.10162	41.10202	41.10250	41.10277	41.10305	250	YZ	04	41.10331	41.10648	41.10421	41.10514	41.10560	41.10576	
250	YZ	05	41.10059	41.10120	41.10162	41.10202	41.10250	41.10277	41.10305	250	YZ	05	41.10331	41.10648	41.10421	41.10515	41.10560	41.10576	
250	YZ	06/07	41.10059	41.10120	41.10162	41.10202	41.10250	41.10277	41.10305	250	YZ	06/07	41.10331	41.10648	41.10425	41.10516	41.10560	41.10576	
250	YZ	08/12	41.10059	41.10120	41.10163	41.10202	41.10250	41.10277	41.10305	250	YZ	08/12	41.10331	41.10648	41.10425	41.10516	41.10560	41.10576	
250	YZ F	01	41.10059	41.10120				41.10276	41.10305	250	YZ F	01	41.10325	41.10642			41.10560	41.10576	
250	YZ F	02/03	41.10059	41.10120	41.10162	41.10202		41.10276	41.10305	250	YZ F	02/03	41.10325	41.10642	41.10421	41.10514	41.10560	41.10576	
250	YZ F	04	41.10059	41.10120	41.10162	41.10202		41.10276	41.10305	250	YZ F	04	41.10331	41.10648	41.10421	41.10514	41.10560	41.10576	
250	YZ F	05	41.10059	41.10120	41.10162	41.10202		41.10276	41.10305	250	YZ F	05	41.10331	41.10648	41.10421	41.10517	41.10560	41.10576	

Applicazioni		A					B		C	D	E	Applicazioni		F	G	H	I	L	
cc	marca/modello	anno	kit cuscinetti ruota ant.	kit cuscinetti ruota post.	kit distanziali ruota ant.	kit distanziali ruota post.	kit cuscinetti albero motore	kit tenuta albero secondario	kit cuscinetti e parapolvere sterzo	anno	cc	marca/modello	Kit paraolio e parapolvere forcilla	Kit paraolio forcilla	Kit cuscinetti forcellone	Kit revisione leveraggi	Kit cuscinetti mono inf.	Kit cuscinetti mono sup.	
250	YZ F	06	41.10059	41.10120	41.10162	41.10202		41.10276	41.10305	250	YZ F	06	41.10331	41.10648	41.10425	41.10519	41.10560	41.10576	
250	YZ F	07	41.10059	41.10120	41.10163	41.10202		41.10276	41.10305	250	YZ F	07	41.10331	41.10648	41.10425	41.10515	41.10560	41.10576	
250	YZ F	08	41.10059	41.10120	41.10163	41.10202		41.10276	41.10305	250	YZ F	08	41.10331	41.10648	41.10425	41.10519	41.10560	41.10576	
250	YZ F	09	41.10059	41.10045	41.10163	41.10203		41.10276	41.10305	250	YZ F	09	41.10331	41.10648	41.10425	41.10520	41.10560	41.10576	
250	YZ F	10/13	41.10059	41.10045	41.10163	41.10203		41.10276	41.10305	250	YZ F	10/13	41.10331	41.10648	41.10425	41.10521	41.10560	41.10576	
350	BW	87/88							41.10600	350	BW	87/88							
350	RD (RD1/4130)	73/75							41.10303	350	RD (RD1/4130)	73/75		41.10649					
350	RZ	84/85							41.10303	350	RZ	84/85		41.10625					
350	TT	86/87							41.10296	350	TT	86/87		41.10635					
350	TY	85/86	41.10001						41.10288	350	TY	85/86		41.10626					
350	XT	85/00							41.10296	350	XT	85/00		41.10626					
360	MX	74							41.10308	360	MX	74		41.10649					
360	RT	70/73							41.10308	360	RT	70/73		41.10649					
360	XS	76/77							41.10303	360	XS	76/77		41.10624					
400	DT	75/78							41.10308	400	DT	75/78		41.10649					
400	FZR	88/90							41.10296	400	FZR	88/90		41.10652					
400	IT	76	41.10001						41.10308	400	IT	76		41.10626					
400	IT	79	41.10001						41.10296	400	IT	79		41.10626					
400	MX	75							41.10308	400	MX	75		41.10649					
400	RD	76/78							41.10303	400	RD	76/78		41.10649					
400	RD	79							41.10303	400	RD	79		41.10625					
400	WR F	98	41.10060					41.10278	41.10305	400	WR F	98	41.10325	41.10642				41.10576	
400	WR F	99/00	41.10060	41.10120				41.10278	41.10305	400	WR F	99/00	41.10325	41.10642				41.10576	
400	YP Majesty	05/06								400	YP Majesty	05/06		41.10634					
400	YP Majesty (5RUJ/5RUH/5RUG/5RUX/5RUY)	07/10								400	YP Majesty (5RUJ/5RUH/5RUG/5RUX/5RUY)	07/10		41.10634					
400	XS	77/81							41.10303	400	XS	77/81		41.10624					
400	XS Maxime	82/83							41.10303	400	XS Maxime	82/83		41.10625					
400	YZ	76							41.10308	400	YZ	76		41.10626					
400	YZ	77/79							41.10296	400	YZ	77/79		41.10629					
400	YZ F	98	41.10059					41.10278	41.10305	400	YZ F	98	41.10325	41.10642				41.10576	
400	YZ F	99	41.10059	41.10120				41.10278	41.10305	400	YZ F	99	41.10325	41.10642				41.10576	
425	IT	80	41.10001						41.10296	425	IT	80		41.10626					
426	WR F	01	41.10060	41.10120				41.10278	41.10305	426	WR F	01	41.10325	41.10642			41.10560	41.10576	
426	WR F	02	41.10060	41.10120	41.10165	41.10202		41.10278	41.10305	426	WR F	02	41.10325	41.10642	41.10421	41.10514	41.10560	41.10576	
426	YZ F	00	41.10059	41.10120				41.10278	41.10305	426	YZ F	00	41.10325	41.10642				41.10576	
426	YZ F	01	41.10059	41.10120				41.10278	41.10305	426	YZ F	01	41.10325	41.10642			41.10560	41.10576	
426	YZ F	02	41.10059	41.10120	41.10162	41.10202		41.10278	41.10305	426	YZ F	02	41.10325	41.10642	41.10421	41.10514	41.10560	41.10576	
450	WR F	03/04	41.10060	41.10120	41.10165	41.10202		41.10278	41.10305	450	WR F	03/04	41.10325	41.10642	41.10421	41.10514	41.10560	41.10576	
450	WR F	05	41.10060	41.10120	41.10166	41.10202		41.10278	41.10305	450	WR F	05	41.10331	41.10648	41.10421	41.10517	41.10560	41.10576	
450	WR F	06	41.10060	41.10120	41.10166	41.10202		41.10278	41.10305	450	WR F	06	41.10331	41.10648	41.10425	41.10518	41.10560	41.10576	
450	WR F	07/12	41.10060	41.10120	41.10166	41.10202		41.10278	41.10305	450	WR F	07/12	41.10331	41.10648	41.10425	41.10519	41.10560	41.10576	
450	YZ F	03	41.10059	41.10120	41.10162	41.10202		41.10278	41.10305	450	YZ F	03	41.10325	41.10642	41.10421	41.10514	41.10560	41.10576	
450	YZ F	04	41.10059	41.10120	41.10162	41.10202		41.10278	41.10305	450	YZ F	04	41.10331	41.10648	41.10421	41.10514	41.10560	41.10576	
450	YZ F	05	41.10059	41.10120	41.10162	41.10202		41.10278	41.10305	450	YZ F	05	41.10331	41.10648	41.10421	41.10517	41.10560	41.10576	
450	YZ F	06/07	41.10059	41.10120	41.10162	41.10202		41.10278	41.10305	450	YZ F	06/07	41.10331	41.10648	41.10425	41.10519	41.10560	41.10576	
450	YZ F	08	41.10059	41.10120	41.10163	41.10202		41.10278	41.10305	450	YZ F	08	41.10331	41.10648	41.10425	41.10519	41.10560	41.10576	
450	YZ F	09	41.10059	41.10045	41.10163	41.10203		41.10278	41.10305	450	YZ F	09	41.10331	41.10648	41.10425	41.10520	41.10560	41.10576	
450	YZ F	10/13	41.10059	41.10045	41.10163	41.10203		41.10278	41.10305	450	YZ F	10/13	41.10331	41.10648	41.10431	41.10520	41.10560	41.10576	
465	IT	81/82	41.10001						41.10296	465	IT	81/82		41.10629					
465	YZ	80							41.10296	465	YZ	80		41.10629					
465	YZ	81							41.10296	465	YZ	81		41.10638					
490	IT	83/84	41.10001						41.10296	490	IT	83/84		41.10638					
490	YZ	82/90							41.10296	490	YZ	82/90		41.10638					
500	RZ	84							41.10296	500	RZ	84							
500	SC	73/74							41.10308	500	SC	73/74							

ALL BALLS

ALL BALLS

		A		B		C	D	E				F	G	H	I	L		
Applicazioni cc	marca/modello	anno	kit cuscinetti ruota ant.	kit cuscinetti ruota post.	kit distanziali ruota ant.	kit distanziali ruota post.	kit cuscinetti albero motore	kit tenuta albero secondario	kit cuscinetti e parapolvere sterzo	Applicazioni cc	marca/modello	anno	Kit paraolio e parapolvere forcella	Kit paraolio forcella	Kit cuscinetti forcellone	Kit revisione leveraggi	Kit cuscinetti mono inf.	Kit cuscinetti mono sup.
500	SR	78/81							41.10308	500	SR	78/81		41.10625				
500	XP T-Max	09/10							41.10610	500	XP T-Max	09/10		41.10639				
500	TT	76/81							41.10308	500	TT	76/81		41.10626				
500	TX	73/75							41.10598	500	TX	73/75		41.10649				
500	WR R 2T	92/93							41.10299	500	WR R 2T	92/93		41.10638				
500	XS	76/78							41.10598	500	XS	76/78		41.10625				
500	XT	76/81							41.10308	500	XT	76/81		41.10626				
500	XV SE/Virago	83							41.10303	500	XV SE/Virago	83	41.10338	41.10627				
535	XV Virago	87/88							41.10303	535	XV Virago	87/88	41.10338	41.10627				
535	XV Virago	90							41.10303	535	XV Virago	90	41.10338	41.10627				
535	XV Virago	93/99							41.10303	535	XV Virago	93/99	41.10338	41.10627				
550	XJ Maxim	81/83							41.10303	550	XJ Maxim	81/83						
550	XJ R Seca	81/83							41.10303	550	XJ R Seca	81/83						
550	XT	82/83							41.10296	550	XT	82/83		41.10629				
550	XZ R Vision	82/83							41.10598	550	XZ R Vision	82/83						
550	XZ S	82/83							41.10598	550	XZ S	82/83						
600	FJ	84/85							41.10303	600	FJ	84/85	41.10338	41.10627				
600	FZ (3BX)	86/88							41.10598	600	FZ (3BX)	86/88	41.10338	41.10627				
600	XJ 6 N/S/F (20S/36C/1CW)	09/12							41.10296	600	XJ 6 N/S/F (20S/36C/1CW)	09/12		41.10633				
600	FZ6 R	12							41.10296	600	FZ6 R	12		41.10633				
600	FZ6 Fazer, Abs, S2 (RJ07)	04/08							41.10296	600	FZ6 Fazer, Abs, S2 (RJ07)	04/08		41.10638				
600	FZ6 N,NS,S2(RJ07)	04/08							41.10296	600	FZ6 N,NS,S2(RJ07)	04/08		41.10638				
600	FZR (3RG/3RH/3HE)	89/95							41.10296	600	FZR (3RG/3RH/3HE)	89/95		41.10652				
600	SRX (1XM/1XN)	86							41.10598	600	SRX (1XM/1XN)	86	41.10338	41.10627				
600	TT	83/84	41.10001						41.10296	600	TT	83/84		41.10638				
600	TT	85/86							41.10296	600	TT	85/86		41.10638				
600	XJ N	92/98							41.10296	600	XJ N	92/98		41.10652				
600	XJ S Diversion	95/02							41.10296	600	XJ S Diversion	95/02						
600	XT (43F/47N)	84/86							41.10296	600	XT (43F/47N)	84/86		41.10633				
600	XT (2KF)	87/89							41.10296	600	XT (2KF)	87/89		41.10633				
600	XT K (3TB)	91/93							41.10296	600	XT K (3TB)	91/93		41.10633				
600	XT E (3UW/3TB/4PT)	96/02							41.10296	600	XT E (3UW/3TB/4PT)	96/02						
600	XY Radian	86/90							41.10303	600	XY Radian	86/90	41.10338	41.10627				
600	YZF Thundercat (4TV/4WD)	95/06							41.10296	600	YZF Thundercat (4TV/4WD)	95/06		41.10634				
600	YZF R6 (RJ03/RJ05/RJ09)	99/04							41.10593	600	YZF R6 (RJ03/RJ05/RJ09)	99/04		41.10639				
600	YZF R6 (RJ03/RJ05/RJ09)	05							41.10593	600	YZF R6 (RJ03/RJ05/RJ09)	05		41.10634				
600	YZF R6 R (RJ11)	06/12							41.10610	600	YZF R6 R (RJ11)	06/12		41.10633				
600	YZF R6 S	06							41.10593	600	YZF R6 S	06		41.10639				
650	TX	70/76							41.10598	650	TX	70/76		41.10649				
650	XJ	80/83							41.10598	650	XJ	80/83	41.10338	41.10627				
650	XS	70/72							41.10598	650	XS	70/72		41.10649				
650	XS	75/76							41.10598	650	XS	75/76		41.10649				
650	XS	77/83							41.10598	650	XS	77/83		41.10625				
650	XVS Drag Star (4XR/4VR)	98/02							41.10296	650	XVS Drag Star (4XR/4VR)	98/02		41.10634				
650	XVS Drag Star (4XR/4VR)	03/11							41.10296	650	XVS Drag Star (4XR/4VR)	03/11		41.10634				
650	XVS Drag Star (4XR/4VR)	13							41.10296	650	XVS Drag Star (4XR/4VR)	13		41.10634				
660	XT Z Ténéré (DM021/DM025/DM041)	08/09							41.10296	660	XT Z Ténéré (DM021/DM025/DM041)	08/09		41.10638				
660	XTZ Ténéré	94/96							41.10296	660	XTZ Ténéré	94/96						
700	FZ Genesis	87							41.10296	700	FZ Genesis	87						
700	FZX Fazer	86/87							41.10296	700	FZX Fazer	86/87		41.10629				
700	XJ Maxim	85/86							41.10296	700	XJ Maxim	85/86		41.10652				
700	XV Virago	84/87							41.10296	700	XV Virago	84/87		41.10652				
750	FZ	85/86							41.10296	750	FZ	85/86						
750	FZR R Genesis	87/88							41.10296	750	FZR R Genesis	87/88		41.10634				
750	TX	73/74							41.10598	750	TX	73/74		41.10627				

Applicazioni cc marca/modello	anno	A		B		C	D	E	Applicazioni cc marca/modello	anno	F Kit paraolio e parapolvere forcella	G Kit paraolio forcella	H Kit cuscinetti forcellone	I Kit revisione leveraggi	L	
		kit cuscinetti ruota ant.	kit cuscinetti ruota post.	kit distanziali ruota ant.	kit distanziali ruota post.	kit cuscinetti albero motore	kit tenuta albero secondario	kit cuscinetti e parapolvere sterzo							Kit cuscinetti mono inf.	Kit cuscinetti mono sup.
750 XJ	81/83							41.10598	750 XJ	81/83	41.10338	41.10627				
750 XS	77							41.10296	750 XS	77		41.10625				
750 XS	78/79							41.10296	750 XS	78/79		41.10626				
750 XTZ Super Ténéré	95							41.10296	750 XTZ Super Ténéré	95						
750 XV Virago	81/83							41.10598	750 XV Virago	81/83	41.10338	41.10627				
750 XV Virago	88/97							41.10296	750 XV Virago	88/97		41.10652				
750 YZF R	94							41.10296	750 YZF R	94		41.10634				
750 YZF R	96/98							41.10296	750 YZF R	96/98		41.10634				
800 FZ8-Fazer	12							41.10610	800 FZ8-Fazer	12		41.10639				
800 FZ8-N	12							41.10610	800 FZ8-N	12		41.10639				
850 TDM	92/01							41.10296	850 TDM	92/01						
850 TRX	96/97							41.10296	850 TRX	96/97						
850 XS	80/81							41.10296	850 XS	80/81		41.10626				
850 XS SG	80							41.10296	850 XS SG	80		41.10625				
900 TDM	02/06							41.10593	900 TDM	02/06						
900 XJ R Seca	83							41.10296	900 XJ R Seca	83						
900 XJ S Diversion	95/96							41.10296	900 XJ S Diversion	95/96						
900 XJ S Diversion	98/01							41.10296	900 XJ S Diversion	98/01						
920 XV Virago	82/83							41.10598	920 XV Virago	82/83	41.10338	41.10627				
920 XV R Virago	81/82							41.10598	920 XV R Virago	81/82						
950 XVS Midnight Star	11/12							41.10296	950 XVS Midnight Star	11/12		41.10634				
1000 FZS Fazer (RN06)	01/05							41.10296	1000 FZS Fazer (RN06)	01/05		41.10638				
1000 FZ1-N/NA	06/12							41.10610	1000 FZ1-N/NA	06/12		41.10639				
1000 FZ1-S Fazer / Fazer Abs	06/12							41.10610	1000 FZ1-S Fazer / Fazer Abs	06/12		41.10639				
1000 FZR	87/88							41.10296	1000 FZR	87/88		41.10634				
1000 FZR	89/95							41.10296	1000 FZR	89/95		41.10638				
1000 XV SE Virago	84/85							41.10296	1000 XV SE Virago	84/85		41.10652				
1000 YZF Thunderace (4VD)	97							41.10296	1000 YZF Thunderace (4VD)	97						
1000 YZF R1	98/01							41.10593	1000 YZF R1	98/01		41.10634				
1000 YZF R1	02/05							41.10593	1000 YZF R1	02/05		41.10639				
1000 YZF R1	07/08							41.10610	1000 YZF R1	07/08		41.10639				
1000 YZF R1	09/12							41.10610	1000 YZF R1	09/12		41.10638				
1000 YZF R1S	06							41.10593	1000 YZF R1S	06		41.10638				
1100 FJ (47E)	84/85							41.10296	1100 FJ (47E)	84/85		41.10634				
1100 XJ Maxim	82							41.10296	1100 XJ Maxim	82		41.10629				
1100 XS	78/81							41.10296	1100 XS	78/81						
1100 XV Virago	86/99							41.10296	1100 XV Virago	86/99		41.10652				
1100 XVS Drag Star / V Star Classic	99/09							41.10296	1100 XVS Drag Star / V Star Classic	99/09		41.10634				
1200 FJ Fairing	86/93							41.10296	1200 FJ Fairing	86/93		41.10634				
1200 V Max	85/92							41.10296	1200 V Max	85/92		41.10653				
1200 V Max	93/98							41.10296	1200 V Max	93/98		41.10638				
1200 V Max	99/07							41.10296	1200 V Max	99/07		41.10639				
1200 XJR	95/97							41.10296	1200 XJR	95/97						
1200 XTZ Superténéré	12							41.10305	1200 XTZ Superténéré	12		41.10638				
1200 XVZ 12TD Venture Royale	83/85							41.10296	1200 XVZ 12TD Venture Royale	83/85		41.10653				
1300 FJR	03/05							41.10593	1300 FJR	03/05		41.10654				
1300 FJR A - FJR AS	06/12							41.10593	1300 FJR A - FJR AS	06/12		41.10654				
1300 XJR	99/06							41.10296	1300 XJR	99/06						
1300 XVS A Midnight Star (11C1)	08/12							41.10296	1300 XVS A Midnight Star (11C1)	08/12		41.10634				
1300 XVZ Royal Star (4NK/4YP)	96/00							41.10296	1300 XVZ Royal Star (4NK/4YP)	96/00		41.10636				
1300 XVZ 13TD Venture Royale (3JT)	86/93							41.10296	1300 XVZ 13TD Venture Royale (3JT)	86/93		41.10653				
1600 XV Road Star Silverado	99/03							41.10296	1600 XV Road Star Silverado	99/03		41.10636				
1700 VMX V-MAX	09/12							41.10297	1700 VMX V-MAX	09/12						
1700 XV Road Star	08							41.10296	1700 XV Road Star	08		41.10636				
1700 XV PC Road Star Warrior	02/10							41.10607	1700 XV PC Road Star Warrior	02/10		41.10634				

Tabella paraoli per misura e profilo

<i>Cod. SGR</i>	<i>Ø interno</i>	<i>Ø esterno</i>	<i>larghezza</i>	<i>tipo</i>	<i>marca</i>
41.10618	26	37	10,5	DRD2	ALL-BALLS
41.10619	27	39	10,5	DRD2	ALL-BALLS
41.10620	30	40,5	10.5/12	DRD2	ALL-BALLS
41.10621	30	42	11	DRD2	ALL-BALLS
41.10622	31	43	10	DRD2	ALL-BALLS
44.0804	31,5	45	7,1	-	-
41.10632	32	42	6.5/9	DRD2	ALL-BALLS
44.0253	32	43	12,5	DR3	VESRAH
41.10623	33	45	10,5	DRD2	ALL-BALLS
44.1130	33	45	8/9,5	DR2	VESRAH
41.10624	33	46	11	DRD2	ALL-BALLS
44.0027	33	46	11	DRD2	VESRAH
41.10649	34	46	10,5	DRD2	ALL-BALLS
44.0039	34	46	10,5	DR3	VESRAH
41.10644	35	47	10	DRD2	ALL-BALLS
41.10625	35	48	11	DRD2	ALL-BALLS
44.0040	35	48	11	DRD2	VESRAH
41.10627	36	48	8	DRD2	ALL-BALLS
44.0038	36	48	10,5	DR3	VESRAH
44.0350	36	48	11	DRD2	VESRAH
41.10626	36	48	10.5/11.5	DRD2	ALL-BALLS
44.0304	36	48	8/9,5	DR2	VESRAH
44.0821	36	49	11	-	-
44.0308	37	49	8/10	DRD2	VESRAH
41.10628	37	50	11	DRD2	ALL-BALLS
44.0300	37	50	11	DRD2	VESRAH
44.1030	38	50	9,5	DR2	VESRAH
41.10629	38	50	10,5	DRD2	ALL-BALLS
44.0266	38	50	10,5	DR3	VESRAH
44.0301	38	50	8/10,5	DR2	VESRAH
41.10652	38	50	8/10.25	DRD2	ALL-BALLS
44.1020	38	52	11	DRD2	VESRAH
44.0347	39	51	8/10,5	DR2	VESRAH
41.10630	39	52	11	DRD2	ALL-BALLS
44.0241	39	52	11	DRD2	VESRAH
41.10653	40	52	8/10	DRD2	ALL-BALLS
44.0303	40	52	8/9,5	DR2	VESRAH
41.10633	41	53	10,5	DRD2	ALL-BALLS
44.0345	41	53	10,5	DR3	VESRAH
44.0302	41	53	8/10,5	DR2	VESRAH
44.1140	41	53	8/10,5	DRD2	VESRAH
41.10634	41	53	8/10.5	DRD2	ALL-BALLS
44.1040	41	53	8/9,5	DR2	VESRAH
44.1050	41	53	8/9,5	DR3	VESRAH
41.10635	41	54	11	DRD2	ALL-BALLS
44.0314	41	54	11	DRD2	VESRAH
41.10631	43	53	9,5	DRD2	ALL-BALLS
41.10636	43	54	11	DRD2	ALL-BALLS
44.0243	43	54	11	DRD2	VESRAH
41.10637	43	54	9.5/10.5	DRD2	ALL-BALLS
44.0351	43	55	10,5	DR3	VESRAH

<i>Cod. SGR</i>	<i>Ø interno</i>	<i>Ø esterno</i>	<i>larghezza</i>	<i>tipo</i>	<i>marca</i>
44.1070	43	55	10,5/12	DR3	VESRAH
41.10638	43	55	10.5/12	DRD2	ALL-BALLS
44.1060	43	55	9,5/10,5	DR3	VESRAH
44.1150	43	55	9,5/10,5	DRD2	VESRAH
41.10639	43	55	9.5/10	DRD2	ALL-BALLS
41.10640	45	57	11	DRD2	ALL-BALLS
44.1080	45	57	11	DRD2	VESRAH
41.10651	45	58	10.5	DRD2	ALL-BALLS
41.10641	46	58	10.5	DRD2	ALL-BALLS
41.10642	46	58	10.25	DRD2	ALL-BALLS
44.1160	46	58	10,5	DRD2	VESRAH
44.1090	46	58	10,5/11	DR3	VESRAH
44.1100	46	58	9,5/11,5	DRD2	VESRAH
44.1110	47	58	10	DR3	VESRAH
41.10643	47	58	10/11	DRD2	ALL-BALLS
41.10648	48	58	8.5/9.8	DRD2	ALL-BALLS
41.10647	48	58	9.5/11.5	DRD2	ALL-BALLS
44.1170	48	58,1	8,5/10,5	DRD2	VESRAH
41.10654	48	61	11	DRD2	ALL-BALLS
41.10645	49	60	10	DRD2	ALL-BALLS
44.1120	49	60	10	DR3	VESRAH
41.10650	50	60	10,5	DRD2	ALL-BALLS
41.10646	50	63	10.5	DRD2	ALL-BALLS

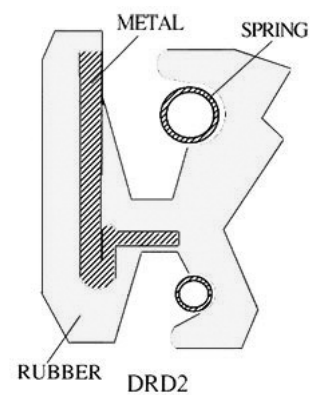
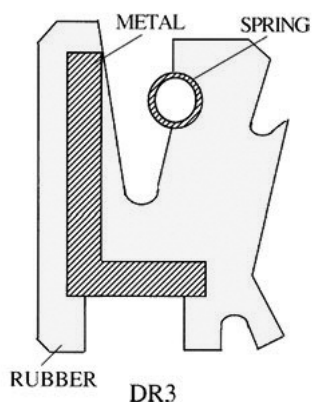
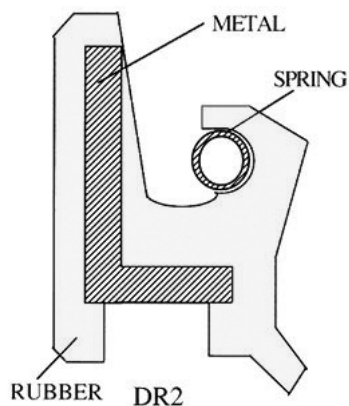

Cuscinetti "NTN" e "Nachi"



PREFISSI E SUFFISSI

<i>NTN</i>	<i>Nachi</i>	<i>SKF</i>	<i>Descrizione</i>
C1	C1	C1	gioco radiale inferiore a C2
C2	C2	C2	gioco radiale inferiore al normale
(CN)	nessun suffisso		gioco radiale normale
C3	C3	C3	gioco radiale superiore al normale
C4	C4	C4	gioco radiale superiore a C3
C5	C5	C5	gioco radiale superiore a C4
CS			gioco radiale speciale per moto
LU	NSE	RS1	tenuta in gomma sintetica (di tipo a contatto) da un lato
LLU	2NSE	2RS1	tenuta in gomma sintetica (di tipo a contatto) da entrambi i lati
Z	Z	Z	schermatura in acciaio da un lato
ZZ	ZZ	2Z	schermatura in acciaio da entrambi i lati
4T-X	E-J	K-X	cuscinetti a rulli conici
JR2			gabbia rivettata in acciaio speciale per moto
PX1			indice di precisione speciale per moto
SC			cuscinetto radiale a sfera con dimensioni speciali per moto
SF			cuscinetto obliquo a sfera con dimensioni speciali per moto
3TM			cuscinetti con trattamento termico speciale per moto
TM			cuscinetti con trattamento termico speciale (SUJ3)
TMB			cuscinetti a lunga durata con trattamento termico speciale per moto

<i>Cod. SGR NTN</i>	<i>Sigla NTN</i>	<i>Cod. SGR Nachi</i>	<i>Sigla Nachi</i>	<i>Misure</i>	<i>Sigla SKF</i>	<i>Utilizzo</i>
41.560000	6000		6000	10 x 26 x 8	6000	pompa acqua
41.562003	6200 C3/5K		6200 C3	10 x 30 x 9	6200 C3	trasmissione
41.563007	6300 LLU		6300 2NSE	10 x 35 x 11	6300 2RS1	ruota-trasmissione
41.562010	6201		6201	12 x 32 x 10	6201	ruota-motore
41.562016	6201 LU		6201 NSE	12 x 32 x 10	6201 RS1	trasmissione
41.562017	6201 LLU	41.62017	6201 2NSE	12 x 32 x 10	6201 2RS1	ruota
41.562018	6201 Z		6201 Z	12 x 32 x 10	6201 Z	carter

<i>Cod. SGR NTN</i>	<i>Sigla NTN</i>	<i>Cod. SGR Nachi</i>	<i>Sigla Nachi</i>	<i>Misure</i>	<i>Sigla SKF</i>	<i>Utilizzo</i>
41.563017	6301 LLU		6301 2NSE	12 x 37 x 12	6301 2RS1	ruota
41.53012	TMB301JR2			12 x 37 x 12		trasmissione
41.560026	6002 LU	41.60026	6002 NSE	15 x 32 x 9	6002 RS1	motore-trasmissione
41.560027	6002 LLU		6002 2NSE	15 x 32 x 9	6002 2RS1	motore
41.560029	6002 ZZ		6002 ZZ	15 x 32 x 9	6002 2Z	motore
41.562020	6202		6202	15 x 35 x 11	6202	motore-trasmissione
41.562023	6202 C3	41.62023	6202 C3	15 x 35 x 11	6202 C3	ruota trasmissione
41.562027	6202 LLU		6202 2NSE	15 x 35 x 11	6202 2RS1	ruota
41.563020	6302		6302	15 x 42 x 13	6302	trasmissione
41.563027	6302 LLU		6302 2NSE	15 x 42 x 13	6302 2RS1	ruota-trasmissione
41.53023	TMB302BC3			15 x 42 x 13		trasmissione
41.560030	6003	41.60030	6003	17 x 35 x 10	6003	trasmissione
41.560037	6003 LLU	41.60037	6003 2NSE	17 x 35 x 10	6003 2RS1	motore
41.562030	6203	41.62030	6203	17 x 40 x 12	6203	ruota-dinamotore
41.562033	6203 C3	41.62033	6203 C3	17 x 40 x 12	6203 C3	motore-trasmissione
41.562036	6203 LUN C3	41.62036	6203 NSE C3	17 x 40 x 12	6203 RS1 C3	motore
41.562037	6203 LLU	41.62037	6203 2NSE	17 x 40 x 12	6203 2RS1	ruota - motore
41.50339	TM-SC03A39CS20			17 x 42 x 13		albero motore
41.563030	6303	41.63030	6303	17 x 47 x 14	6303	motore-trasmissione
41.563033	6303 C3		6303 C3	17 x 47 x 14	6303 C3	motore-trasmissione
41.563037	6303 LLU		6303 2NSE	17 x 47 x 14	6303 2RS1	ruota-trasmissione
41.560040	6004		6004	20 x 42 x 12	6004	ruota-trasmissione
41.560047	6004 LLU		6004 2NSE	20 x 42 x 12	6004 2RS1	ruota
41.562043	6204 C3		6204 C3	20 x 47 x 14	6204 C3	motore
41.562044	6204 JR2 C4	41.62044	6204 C4	20 x 47 x 14	6204 C4	albero motore
41.562047	6204 LLU		6204 2NSE	20 x 47 x 14	6204 2RS1	ruota-trasmissione
41.52042	TMB204CCS24-1			20 x 47 x 14		trasmissione
41.50447	SC04A47CS29PX1			20 x 52 x 12		albero motore
41.563040	6304		6304	20 x 52 x 15	6304	trasmissione-cambio
41.50419	SC04B19CS30PX1			20 x 56 x 12		albero motore
41.52221	TMB2/22CCS15			22 x 50 x 14		trasmissione
41.560050	6005		6005	25 x 47 x 12	6005	frizione
41.5250515	SC05A51CS24PX1/2AQF	41.250515	2BC-05-S15	25 x 52 x 13		albero motore
41.562057	6205 LLU	41.62057	6205 2NSE	25 x 52 x 15	6205 2RS1	ruota
41.50561	SC05B61CS35PX1/2AS			25 x 56 x 12		albero motore
41.50531	3TM-SC05B31CS37			25 x 68 x 12		albero motore
41.53282	TMB3/28JR2C4			28 x 68 x 18		albero motore-carter
41.562060	6206 C3		6206 C3	30 x 62 x 16	6206 C3	motore
41.50787	TM-SC07A87CS32PX11			35 x 72 x 15		albero motore
41.52074	TMB207X46JR2CS32#01			35 x 72 x 17		albero motore
41.532005	4T-32005XPX4	41.32005	E-32005-J	25 x 47 x 15	32005-X	sterzo
		41.32028	E-320/28J	28 x 52 x 16,5		sterzo
41.532006	4T-32006X	41.32006	E-32006-J	30 x 55 x 17	32006-X	sterzo
41.50722	SF07A22PX1			35 x 55 x 14,5		sterzo

Tabella applicazioni trasmissioni flessibili gas-starter-freno-contakm.-contagiri



Applicazioni marca, c.c., modello, anno	Gas	Starter	Freno ant.	Freno post.	Contakm. (** contagiri)
APRILIA SCOOTER					
50 Amico (91/92) (Tamburo/Tamburo)	08.9140 (manop./carb.) AP8214069		08.9141 AP8214111	08.9142 AP8214064	08.3163 AP8214070
50 Amico LX/Sport/Cat (92/93) 50 Amico (94 - Tamburo/Tamburo)	08.9130 (manop./carb.) AP8214109	08.9139 (leva) AP8214108		08.9131 AP8214104	08.3205 AP8214110
50 Amico Sport (94/95)	08.9130 (manop./carb.) AP8214109	08.9139 (leva) AP8214108		08.9131 AP8214104	08.3193 AP8214142
50 Amico/Sport (96/98) (Tamburo/Tamburo - Disco/Tamburo)	08.9130 (manop./carb.) AP8214109	08.9139 (leva) AP8214108		08.9131 AP8214104	08.3313 AP8214169
50 Amico GL/GLE (93/95) (Tamburo/Tamburo)	08.9130 (manop./carb.) AP8214109	08.9139 (leva) AP8214108		08.9131 AP8214104	08.3313 AP8214169
50 Amico GL/GLE (93/95) (Disco/Tamburo)	08.9130 (manop./carb.) AP8214109	08.9139 (leva) AP8214108		08.9131 AP8214104	08.3205 AP8214110
50 Area 51 (98/>)	08.9351 (completa) AP8214176				
50 Gulliver Air/H2O (94/>)				08.9132 AP8214131	08.3193 AP8214142
50 Habana (99/03)					08.4114 AP8214210
50 Habana Custom (99/03)					08.4113 AP8114472
50 Mojito Retro' (99/03)					08.4114 AP8214210
50 Mojito Custom (99/03)					08.4113 AP8114472
50 Mojito 2T (04/10 - Mot.Piaggio)					08.4113 AP8114472
50 Rally Air (95/03)				08.9132 AP8214131	08.3263 AP8214158
50 Rally LC (96/00)	08.9143 (manop./sdopp.) AP8214167	08.9129 (leva) AP8214166		08.9144 AP8214170	08.3317 AP8214165
50 Scarabeo/Street (93/05 - mot.Minarelli) (disco/tamburo - disco/disco)	08.9135 (manop./carb.) AP8214125	08.9137 (leva) AP8214124		08.9136 (disco/tamburo) AP8214123	08.3214 AP8214126
50 Scarabeo 2T Street/Rst (06/09-mot.Piaggio)					08.3214 AP8214126

<i>Applicazioni marca, c.c., modello, anno</i>	<i>Gas</i>	<i>Starter</i>	<i>Freno ant.</i>	<i>Freno post.</i>	<i>Contakm. (** contagiri)</i>
50 Sonic Air/GP (96/08)	08.91491 (completa) AP8214172	08.9149 (completa) AP8214171			08.4107 AP8214173
50 SR Air (Cil.Verticale - 93/96)	08.9130 (manop./carb.) AP8214109	08.9139 (leva) AP8214108		08.9132 AP8214131	08.3205 AP82141130
50 SR Air/LC Urban/Viper/ Replica (94/96) (Cil. Orizzontale)	08.9130 (manop./carb.) AP8214109	08.9139 (leva) AP8214108		08.9132 AP8214131	08.3193 AP8214142
50 SR WWW/Netscaper (97/02)	08.9134 (manop./carb.) AP8214162			08.9132 AP8214131	08.3316 AP8214163
50 SR Racing/Stealth (97/99 - mot. Minarelli)	08.9134 (manop./carb.) AP8214162				08.3316 AP8214163
50 SR Racing/Sport (00/03 - mot. Aprilia)					08.3316 AP8214163
50 SR Di-Tech/Euro 2 (00/03)					08.3316 AP8214163
50 SR Street/IE (03/13 - mot. Piaggio)					08.3316 AP8214163
100 Scarabeo 2T (00/>)				08.9357 AP8114395	
125/200 Atlantic/Euro 3 (03/13)					08.4125 AP8114460
125 Habana (99/01)					08.4114 AP8214210
125 Habana Custom (99/01)					08.4113 AP8114472
125/150 Leonardo (96/98)	08.9145 (completa) AP8114299				08.3338 (97/98) AP8114357
125/150 Leonardo/ST (99/04)					08.3338 AP8114357
125 Mojito Retro' (99/01)					08.4114 AP8214210
125 Mojito Custom (99/01)					08.4113 AP8114472
125/150 Mojito (03/07)					08.4113 AP8114472
125 Mojito (08/09)					08.4113 AP8114472
125/150/200 Scarabeo (99/03 - Mot. Rotax)	08.9148 (completa) AP8114453				08.3338 AP8114357
125/200 Scarabeo (03/07 - Mot. Piaggio)					08.3338 AP8114357
125/150 SR (99/>)	08.9146 (manop./sdopp.) 08.91461 (sdopp./carb.) AP8114380			08.9147 AP8114401	08.3316 AP8214163
250/300 Atlantic/Euro 3 (03/13)					08.4125 AP8114460
250/300 Leonardo/ST (99/04)	08.9356 (completa) AP8114368				08.4109 AP8114379
250 Scarabeo (04/06)					08.3338 AP8114357
400/500 Atlantic Sprint (05/09)					08.4125 AP8114460

Applicazioni marca, c.c., modello, anno	Gas	Starter	Freno ant.	Freno post.	Contakm. (** contagiri)
APRILIA CICLOMOTORI E MOTO					
50 Classic (92/99)					08.3208 AP8214100
50 MX Motard (95/03)					08.3122 AP8214054
50 Red Rose (88/91)					08.3088 AP8214042
50 RX Enduro (89/04)					08.3122 AP8214054
125 RS/Extrema (95/05)					08.3336 AP8114334
BENELLI					
50 491 Racing/Sport/GT/RR/SP/ ST (98/02)					08.3870 R53410011A0
50 491 Morini RR/ST (03/04)					08.3325 R53410021A0
50/100 K2 Air/LC (98/02)					08.3325 R53410021A0
BETAMOTOR					
50 Ark Air (96/13)				08.9202 2914170052	08.3292 2914220052
50 Ark LC (96/03)				08.9202 (DT-ruota a raggi) 2914170052	08.3292 2914220052
50 Ark LC /LC K (04/13)					08.3292 2914220052
50 Eikon (99/03)	08.9220 (completa) 2914233052				
50 Quadra/Chrono 502 (>/95)				08.9200 2914020052	
50 Tempo 13"/16" (94/95)					
50 Quadra/Chrono 502 (96/99)				08.9202 2914170052	
50 Tempo 13"/16" (96/99)					
125/150 Eikon (00/02)					08.4116 2914222052
BSV					
50 GP Dio/SP Dio					08.3227 44830GZ0000
CAGIVA					
50 City					08.3189 Y00FA0016
125 Mito/Racing (</94)					08.3157 800066491
125 Mito EV SP (99/03)					08.3158 ** (** contagiri) 8A0066492
125 Mito EV/EU2/EU3/SP525 (94/10)					08.3158 800070130
350/500 T4-E (avv.elettrico)					08.3033 800045025
350/650/750 Elefant (</92) (monofaro)					08.3033 800045025

T R A S M I S S I O N I

Applicazioni marca, c.c., modello, anno	Gas	Starter	Freno ant.	Freno post.	Contakm. (** contagiri)
DERBI					
50 Boulevard 2T/4T (09/13) 100 Boulevard 4T (10/13)					08.4144 600315
125 Boulevard (08/13) 150 Boulevard (10/13)					08.4144 600315
DUCATI					
400 Monster (95/03)					08.3216 40310081/82/83A
400 Super Sport (93/97)					08.3217 40310041A
600 Monster (93/01)					08.3216 40310081/82/83A
600 SuperSport (91/97)					08.3217 40310041A
748 Biposto/R/S/SP/SPS/ Testastretta (95/01)					08.3158 40310071A
750 Monster (96/01)					08.3216 40310081/82/83A
750 Super Sport (91/97)					08.3217 40310041A
900 Monster/IE (93/01)					08.3216 40310083A
900 Super Sport/Super Light (91/97)					08.3217 40310041A
900 Super Sport F.E. (98)/CR USA (98)					08.3217 40310041A
916 Monster S4 (01)					08.3216 40310081/82/83A
916/SP/SPS/Biposto (94/98)					08.3158 40310071A
996/SPS/II/III (99/01)					08.3158 40310071A
998 S Bayliss USA (02)					08.3158 40310071A
GILERA					
50 Easy Moving (95/96)	08.9007 (manop./sdopp.) 271612/268435 08.9002 (sdopp./carb.) 268402			08.9003 271853	08.3195 272340
50 Runner (Disco/Tamburo - 97/01)	08.9310 (manop./sdopp.) 562583 08.9307 (sdopp./carb.) 581173			08.9303 562424	08.3315 561710
50 Runner/SP (Disco/Disco - 97/01)	08.9321 (manop./sdopp.) 563878 08.9307 (sdopp./carb.) 581173				08.3315 561710
50 Runner SP/Poggiali (02/04) 50 Runner Purejet (02/04)	08.9321 (manop./sdopp.) 563878 08.9307 (sdopp./carb.) 581173				08.4132 581848
50 Stalker/Spec.Edition (97/13)				08.9309 (modello DT) 561151	08.3314 561152

<i>Applicazioni marca, c.c., modello, anno</i>	<i>Gas</i>	<i>Starter</i>	<i>Freno ant.</i>	<i>Freno post.</i>	<i>Contakm. (** contagiri)</i>
50 Storm (94/95)	08.9010 (manop./sdopp.) 270995 08.9011 (sdopp./misc.) 272290 08.9012 (sdopp./carb.) 272289			08.9013 270993	08.3194 (1994) 272353/270977 08.3288 (1995) 563621/298746
50 Storm Euro 2 (07/09)				08.9013 270993	
50 Typhoon (94/95)	08.9010 (manop./sdopp.) 270995 08.9011 (sdopp./misc.) 272290 08.9012 (sdopp./carb.) 272289			08.9013 270993	08.3194 272353/270977
50 Typhoon/X/XR (96/00)	08.9010 (manop./sdopp.) 270995 08.9011 (sdopp./misc.) 272290 08.9012 (sdopp./carb.) 272289			08.9013 270993	08.3288 563621/298746
80 Typhoon (estero)	08.9010 (manop./sdopp.) 270995 08.9011 (sdopp./misc.) 272290			08.9013 270993	08.3194 272353/270977
125 Typhoon/X/XR (94/00)	08.9010 (manop./sdopp.) 270995 08.9322 (sdopp./misc.) 560001 08.9012 (sdopp./carb.) 272290			08.9315 560711	08.3194 (94/95) 272353/270977 08.3288 (96/00) 563621/298746
125/180 Runner FX/FXR 2T (DD/DT - 97/98)	08.9310 (manop./sdopp.) 562583 08.9318 (sdopp./carb.) (carb. Mikuni) 562602 08.9319 (sdopp./carb.) (carb. Dell'Orto) 563213			08.9316 (modello DT) 563753	08.4100 563412
125/180 Runner FX/FXR/SP 2T (DD/DT - 99/02)	08.9321 (manop./sdopp.) 563878 08.9318 (sdopp./carb.) (carb. Mikuni) 562602 08.9319 (sdopp./carb.) (carb. Dell'Orto) 563213			08.9316 (modello DT) 563753	08.4100 (1999/2001) 563412 08.4133 (2002) 582413
125/180/200 Runner VX/ VXR 4T (00/04)					08.4133 582413

Applicazioni marca, c.c., modello, anno	Gas	Starter	Freno ant.	Freno post.	Contakm. (** contagiri)
HONDA					
50/80 NH Lead (87/95)	08.3959 17910GC8020		08.3961 45450GC8010	08.3962 43450GC8010	08.3960 44830GC8000
50/100 Bali SJ/EX (93/00)				08.9152 43450GAV701	08.3226 44830GAV700
50 Dio GP/SP/SC01 (91/>)					08.3227 44830GZ0000
50 Dio SR/ZX (SK50M - 92/00)					08.3228 44830GAH000
50 SFX S/SV (95/01)					08.3322 44830GBM750
50 SXR W (97/>)					08.3323 44830GCG930
50 SGX Sky/De Luxe (97/02)					08.3326 44830GCM900
50 SZX X8R-S/X (98/02)					08.3326 44830GCM900
50/75 SH (91/95)	08.9153 (completa) 17910GJ4760		08.9150 45450GJ4760	08.9151 43450GJ4760	08.3960 44830GC8000
50/100 SH (96/02)					08.3189 44830GBY910
125/150 SH (01/04)	08.9358 (completa) 17910KGF900				08.4127 44830KPR900
125/150 SH i (DT - 05/09)					08.4127 44830KPR900
125/150 SH i (DD - 09/12)					08.4127 44830KPR900
125/150 @ Chiocciola (00/06)	08.9358 (completa) 17910KGF900			08.9359 43450KGF900	08.4126 44830KGF900
125/150 Dylan (02/06)				08.9359 43450KGF900	
125/150 Pantheon 2T (98/02)	08.9167 (completa) 17910KEY900			08.9168 43450KEY900	08.3340 44830KEY900
125/150 PS i (06/13)					08.4126 44830KGF900
250 CN Helix/Spazio (90/99)					08.4160 44830KS4010
250 Foresight (97/05)	08.9165 (apertura) 17920KFG000 08.9164 (chiusura) 17910KFG000			08.9166 (DT - 97/00) 43450KFG000	08.3340 44830KFG000 44830KEY900
250 Jazz/ABS (01/04)					08.4160 44830KS4010
600 XL LM/RM (83/87)					08.3861 44830MK5000
650 NX Dominator (88/91)					08.3861 44830MN9000
650 NX Dominator (92/95)					08.3861 44830MY2620
1000 CBR F Dual CBS (SC24 - 93/99)					08.3960 44830GC8000
INNOCENTI					
125/150 Lambretta LI III serie (61/67)					08.3080 00611075
125/150 Lambretta LI Special (63/69)					08.3080 00611075
125/150/200 Lambretta DL (GP - 69/71)					08.3080 00611125

Applicazioni marca, c.c., modello, anno	Gas	Starter	Freno ant.	Freno post.	Contakm. (** contagiri)
150/200 Lambretta SX (66/69)					08.3080 00611075
175 Lambretta TV III serie (62/67)					08.3080 00611075
200 Lambretta TV (GT200 - 63/65)					08.3080 00611075

ITALJET

50 Formula/LC (94/00)					08.3266 3380060
50 Pista 1-2 • Yankee • Scoop 2-3					08.3198 3322304
125 Formula (97/99)					08.3266 3380060

KYMCO

50 Agility 4T R10/Basic (05/13)					08.4156 44830-LEB9-B50 00151100
50 Agility 4T R12/One/MMC (05/13) 50 Agility Carry 4T (11/13)					08.4157 44830-LDC8-E10 00151080
50 Agility 4T R16 (Agility City - 08/13) 50 Agility 2T R16 (10/13)					08.4158 44830-LCD3-E00 00151323
50 Bet & Win/Euro 2 (02/07)					08.4119 44830-KHD8-900 00151913
50 Dink 2T/Classic/Euro 2 (99/07)					08.3329 44830-KEBE-900 00151914
50 Dink 4T (06/13)					08.4153 44830-KGBG-900 00151615
50 DJX/DJY/DJW (91/00)	08.9340 (completa) 00152001 17910-GS7-9500		08.9341 4545A-GS7-900 00152012	08.9342 4345A-GS7-900 00152010	08.3259 44830-GS7-900 00151017
50 DJ W Refined (04/08)					08.4155 44830-GHC8-000 00151170
50 Fever ZX/Euro 2 (99/04)					08.4152 44830-KXCX-901 00151821
50 Filly (TT - 98/00)	08.9344 (completa) 17910-KGBG-900 00152620		08.9345 45450-KBG-900 00153660	08.9346 43450-KBG-900 00153671	08.4153 44830-KGBG-900 00151615
50 Filly LX (DT - 01/02)					08.3228 44830-KBN-9510 00151603
50 Gran Dink/S 2T (05/09)					08.4150 44830-KKC4-900 00151171
50 Heroism (95/97)					08.3301 44830-KLF-9010 00151720
50 KB - 50 K12 (95/00)					08.4152 44830-KXCX-901 00151821
50 Like 2T/4T (09/13)					08.4157 44830-LDC8-E10 00151080

<i>Applicazioni marca, c.c., modello, anno</i>	<i>Gas</i>	<i>Starter</i>	<i>Freno ant.</i>	<i>Freno post.</i>	<i>Contakm. (** contagiri)</i>
50 People 2T/Euro 2 (99/13)					08.4120 44830-KFA6-900 00151303
50 People S 2T/4T (05/13)					08.4158 44830-LCD3-E00 00151323
50 Sniper DT/DD (93/96)					08.3228 44830-KBN-900 00151603
50 Super 9/Sport 2T (00/09)					08.4155 44830-GHC8-000 00151170
50 Super 8 4T (08/13) 50 Super 8 2T (09/13)					08.4158 44830-LCD3-E00 00151323
50/100 Top Boy On/Off (Cobra)					08.4154 44830-KEB7-000 00151517
125 Agility/Euro 3/One/ MMC (R12 - 06/09) 125 Agility Carry 4T (11/13)					08.4157 44830-LDC8-E10 00151080
125/150 Agility R16 (Agility City - 08/13) 200 Agility R16 IE (10/13)					08.4158 44830-LCD3-E00 00151323
125/150 Bet & Win/Euro 2 (00/07)	08.9349 (completa) 17910-KEBE-900 00152924				08.4119 44830-KHD8-900 00151913
125/150 Dink (Ruota 10" - 97/98) 125/150 Dink LX (Ruota 12" - 98/07) 125/150/200 Dink Classic/ Euro 2 (02/07)	08.9349 (completa) 17910-KEBE-900 00152924				08.3329 44830-KEBE-900 00151914
125/200 Dink Euro 3/IE (06/13)					08.4153 44830-KGBG-900 00151615
125/150 Gran Dink/Euro 2/ Euro 3 (01/09)					08.4150 44830-KKC4-900 00151171
125/150 Heroism (95/97)					08.3301 44830-KLF-9010 00151720
125/200 Like/IE/LX (09/13)					08.4157 44830-LDC8-E10 00151080
125/150 People/Euro 2/Euro 3 (99/13)				08.9058 43450-KHB4-900 00152673	08.4120 44830-KFA6-900 00151303
125/200 People S/Euro3/DD/ IE (05/13)					08.4158 44830-LCD3-E00 00151323
125 Movie (99/00)	08.9347 (completa) 17910-KUDU-900 00152132			08.9348 43450-KUDU-900 00152134	08.4121 44830-KUDU-900 00151117
125/150 Movie XL/Euro 2 (01/05) 125/150 Movie Euro 3 (06/09)	08.9347 (completa) 17910-KUDU-900 00152132				08.4152 44830-KXCX-901 00151821
125/150 Super 8 (08/13)					08.4158 44830-LCD3-E00 00151323
125/150 Vivio (00)	08.9347 (completa) 17910-KUDU-900 00152132			08.9348 43450-KUDU-900 00152134	08.4121 44830-KUDU-900 00151117

Applicazioni marca, c.c., modello, anno	Gas	Starter	Freno ant.	Freno post.	Contakm. (** contagiri)
250 Bet & Win/Euro 2 (00/07)	08.9374 (apertura) 17910-KHE7-900 00152944 08.9375 (chiusura) 17911-KHE7-900 00152948				08.4119 44830-KHD8-900 00151913
250 Gran Dink/Euro 2/Euro 3 (01/09)	08.9370 (apertura) 17910-KKC4-900 00152946				08.4150 44830-KKC4-900 00151171
250/300 People S/IE (06/10)					08.4159 44830-LDH1-E00 00156398
250 Yup (03/>)	08.9374 (apertura) 17910-KHE7-900 00152944				08.4119 44830-KHD8-900 00151913

MALAGUTI

50 Centro Base (93/94)					08.3196 17808600
50 Centro SL/Kat. (94/00)					08.3197 17808900
50 Ciak/Mono Euro 2 (99/03)	08.9107 (completa) 03408803			08.9108 04803303	08.4110 17814400
50 Ciak Twin Disk (00/02)	08.9107 (completa) 03408803				08.4110 17814400
50 Ciak Mono Euro 2.3 (03)/ Master (04/05)	08.9110 (manop./sdopp.) 03407803			08.9108 04803303	08.4110 17814400
50 Ciak Master Euro 2 (06/10)	08.9107 (completa) 03408803			08.9108 04803303	08.4110 17814400
50 Ciak Master 4T (05/10)					08.4110 17814400
50 Crosser CR1 (95/98)					08.3253 17810700
50 Enduro Dune (mot.MR4)					08.3064 17800800 (L=980)
50 Enduro MDX Gold (mot.MR4)					08.3064 17800800 (L=980)
50 Enduro MEX/MLX (mot.RV/4 Automix)					08.3064 17800800 (L=980)
50 Enduro MGX/N.L. (mot.GS)					08.3064 17800800 (L=980)
50 Enduro MRX 4M					08.3064 17800800 (L=980)
50 F10 Jetline (92/94)	08.9100 (manop./sdopp.) 03406903				08.3190 17808100
50 F10 Jetline (95/96)	08.9125 (completa) 03408003				08.3190 17808100
50 F10 Jetline/Kat/Rst Euro 1/ Euro 2 (97/03)	08.9125 (completa) 03408003				08.3286 17811600
50 F10 Rst Euro 2.3 (03/05)					08.3286 17811600
50 F10 Rst Euro 2 (06/07)	08.9125 (completa) 03408003				08.3286 17811600
50 F10 AC (08/10)					08.3286 17811600

<i>Applicazioni marca, c.c., modello, anno</i>	<i>Gas</i>	<i>Starter</i>	<i>Freno ant.</i>	<i>Freno post.</i>	<i>Contakm. (** contagiri)</i>
50 F12 Phantom Air/LC (94/95)	08.9110 (manop./sdopp.) 03407803 08.9111 (sdopp./carb.) 03407903			08.9112 04802903	08.3207 17809400
50 F12 Phantom Air/LC (96/98)	08.9125 (completa) 03408003			08.9112 04802903	08.3207 17809400
50 F12 Phantom LC Twin Disk (98)	08.9125 (completa) 03408003				08.3207 17809400
50 F12 Phantom Air Euro1/Rst/ Eu 2 (99/02)	08.9125 (completa) 03408003			08.9112 04802930	08.3343 17813300
50 F12 Phantom Air Rst Euro 2.3 (03/05)	08.9110 (manop./sdopp.) 03407803			08.9112 04802930	08.3343 17813300
50 F12 Restyling Air Euro 2 (06)	08.9125 (completa) 03408003			08.9112 04802930	08.3343 17813300
50 F12 Phantom LC Euro 1 (99/00)	08.9125 (completa) 03408003				08.3343 17813300
50 F12 Phantom LC Euro1 Foggy/ Spectrum (99/00)	08.9125 (completa) 03408003				
50 F12 Phantom LC Rst Euro 1 (01/02)	08.9125 (completa) 03408003				
50 F12 Phantom LC Rst Euro 2/ 2.3 (02/05)	08.9110 (manop./sdopp.) 03407803				
50 F12 LC Restyling Euro 2 (06)	08.9125 (completa) 03408003				
50 F15 Firefox (96/98) 50 F15 Firefox Twin Disk/ Special (98/99)	08.9125 (completa) 03408003				08.3287 17811400
50 F15 Firefox Twin Disk Digit Kat. (98/00)	08.9125 (completa) 03408003				
50 F15 Firefox LC Twin Disk Rst Euro 1 (01)	08.9125 (completa) 03408003				
50 F15 Firefox Euro 2 (02/03)	08.9110 (manop./sdopp.) 03407803				
50 F15 Firefox Rst Euro 2.3 (03/04)	08.9110 (manop./sdopp.) 03407803				
50 F15 Firefox LC Rst Euro 2 (04/05)	08.9125 (completa) 03408003				
50 F15 Firefox Air Euro 2 (05/08)	08.9125 (completa) 03408003				08.3343 17813300
50 Yesterday (97/00)	08.9125 (completa) 03408003				
100 Ciak (99/00)					08.4110 17814400
100 F12 Phantom (99/00)					08.3343 17813300

Applicazioni marca, c.c., modello, anno	Gas	Starter	Freno ant.	Freno post.	Contakm. (** contagiri)
125 Runner YLC (mot.DT125)					08.3064 17800800 (L=980)
125/150/200 Ciak/Rst/Master/ Eu2/Eu3 (00/10)					08.4110 17814400
125/150 Madison/T/R Rst/ Euro 2 (99/05 - mot.Minarelli)	08.9105 (completa) 03408503				08.4111 17814300
250 S Madison (99/03 - mot. Yamaha)	08.9104 (apertura) 03408603 08.9103 (chiusura) 03408703				

MBK

50 Booster (90/94)	08.9030 (manop./sdopp.) 3VLF63110100 08.9031 (sdopp./carb.) 3VLF63120100	08.9033 (sdopp./carb.) 3VLF63340200		08.9035 3VLF63510000	08.3232 3VLH35500000
50 Booster Road (94/95) 50 Booster Spirit/Cat. (96/00)	08.9030 (manop./sdopp.) 3VLF63110100 08.9031 (sdopp./carb.) 3VLF63120100	08.9033 (sdopp./carb.) 3VLF63340200		08.9035 3VLF63510000	08.3229 4PAH35500100
50 Booster (01/02) 50 Booster L (01/03) 50 Booster Spirit/SPEuro 2/L (02/03)	08.9030 (manop./sdopp.) 3VLF63110100 08.9031 (sdopp./carb.) 3VLF63120100	08.9033 (sdopp./carb.) 3VLF63340200		08.9036 5JHF63510000	08.3229 4PAH35500200
50 Booster (04)	08.9030 (manop./sdopp.) 3VLF63110100				08.4171 5WWH35500000
50 Booster NG/Cat. (95/03) 50 Booster Rocket (97/98)	08.9030 (manop./sdopp.) 3VLF63110100 08.9031 (sdopp./carb.) 3VLF63120100	08.9038 (leva/sdopp.) 4SBF63310000 08.9033 (sdopp./carb.) 3VLF63340200		08.9037 (95/00) 4SBF63510000	08.3262 4SBH35500300
50 Booster Track (97/98)	08.9030 (manop./sdopp.) 3VLF63110100 08.9031 (sdopp./carb.) 3VLF63120100	08.9038 (leva/sdopp.) 4SBF63310000 08.9033 (sdopp./carb.) 3VLF63340200		08.9037 4SBF63510000	08.3278 4YBH35500100
50 CR Z Target (91/95)	08.9050 (manop./sdopp.) 3GFF63110000 08.9051 (sdopp./carb.) 3GFF63120000				08.3198 3GFH35500000
50 CT S/SS Sorriso (91/95)	08.9041 (sdopp./carb.) 1NTF63120000		08.9042 1NTF63410000		08.3167 1INTH35500000
50 Evolis (92/95)	08.9060 (manop./sdopp.) 4CUF63111000			08.9062 4CUF63510000	08.3229 4CUH35500000
50 Fizz (94/95)	08.9060 (manop./sdopp.) 4CUF63111000			08.9062 4CUF63510000	08.3229 4PAH35500000

<i>Applicazioni marca, c.c., modello, anno</i>	<i>Gas</i>	<i>Starter</i>	<i>Freno ant.</i>	<i>Freno post.</i>	<i>Contakm. (** contagiri)</i>
50 Flipper/Cat. (98/04)	08.9161 (manop./sdopp.) 5EUF63110000 08.9162 (sdopp./carb.) 4UYF63120000			08.9163 5EUF63510100	08.3341 5EUH35500000
50 Forte (94/96)	08.9064 (sdopp./carb.) 3WGF6312C0				08.3257 4PCH35500000
50 Ovetto (97/04)	08.9330 (manop./sdopp.) 5ADF63110100 08.9331 (sdopp./carb.) 5ADF63120000	08.9333 (leva/sdopp.) 5ADF63310000 08.9334 (sdopp./carb.) 3VLF63340200		08.9332 5ADF63510000	08.3281 (97/01) 5ADH35500000
50 Nitro/Cat. (97/01)	08.9335 (manop./sdopp.) 5BRF63110000 08.9031 (sdopp./carb.) 3VLF63120100	08.9337 (leva/sdopp.) 5BRF63310000 08.9033 (sdopp./carb.) 3ADF63340000			08.3298 5BRH35500200
50 Nitro/Cat. (02/04)	08.9335 (manop./sdopp.) 5BRF63110000 08.9031 (sdopp./carb.) 3VLF63120100	08.9337 (leva/sdopp.) 5BRF63310000 08.9033 (sdopp./carb.) 3VLF63340200			08.4170 5PUH35500100
50 Stunt (00/03)	08.9338 (manop./sdopp.) 4UYF63110000 08.9162 (sdopp./carb.) 4UYF63120000	08.9038 (leva/sdopp.) 4SBF63310000 08.9033 (sdopp./carb.) 3VLF63340200		08.9036 5JHF63510000	08.3262 4SBH35500200
100 Booster (99/01)					08.3875 4VPH35500100
100 Ovetto (00/02)		08.9333 (leva/sdopp.) 5ADF63310000 08.9334 (sdopp./carb.) 5ADF63340000		08.9332 5ADF63510000	08.3281 5ADH35500100
100 Nitro (00/02)		08.9337 (leva/sdopp.) 5BRF63310000			08.3298 5BRH35500200
125/150 Skyliner (DT - 98/00) 125/150 Skyliner (DD - 01/02)	08.9159 (completa) 5DSF63110000			08.9160 5DSF63510000 (modello DT)	08.4103 5DSH35500000 (98/00)
125 XC T Flame (95/99)					08.3280 4KCH35500000
250 Skyliner (00/01)	08.9066 (apertura) 5GM263110000 08.9067 (chiusura) 5GM263120000				

MOTO GUZZI

750 Nevada (02/03)					08.4128 GU31760483
1100 California Stone/Metal (02/05)					08.4130 GU03760451
1100 California EV/EV Touring/ EVPI (02/05)					08.4129 GU03760465
1100 California Special Sport/ Aluminium (02/03)					08.4129 GU03760465

Applicazioni marca, c.c., modello, anno	Gas	Starter	Freno ant.	Freno post.	Contakm. (**contagiri)
1100 California Aluminium/ Titanium (04/05)					08.4129 GU03760465
1100 California Aquila Nera (09/12)					08.4129 GU03760465
1100 California Classic/Touring (06/08)					08.4129 GU03760465
1100 California Vintage (06/13)					08.4129 GU03760465
1100 V11 Le Mans (02)					08.4131 GU01760490

PEUGEOT

50 Buxy (94/97)				08.9083 730828	08.3255 732615/736673
50 Buxy RS (94/97)				08.9083 730828	08.3282
50 Elyseo (99/>)					08.3332 740993
50 Ludix 10" Trand/Snake (04/>)					08.4146 762744
50 Ludix 14" Elegant (04/>)					08.4146 762744
50 Ludix 10" SP Blaster (05/>)					08.4146 762744
50 Ludix 12" RS Blaster (05/>)					08.4147 762745
50 Ludix 14" Classic (04/>)					08.4146 762744
50 Ludix 10" One (04/>)					08.4146 762744
50 Ludix 14" Pro/R 2T/4T 09/>)					08.4146 762744
50 Fox (94/98)			08.9411 728411	08.9412 728412	
50 SC Metropolis LI/LM/SXLM (91/>)	08.3959 705222		08.3961 705218	08.3962 705219	08.3960 705609
50 Speedake (95/97)				08.9083 730828	08.3255 732615/736673
50 Speedfight Air/Cat./LC (97/04)					08.3283 736610
50 Speedfight 2 Air /R/R-Cup (05/09)					08.3283 736610
50 Speedfight 2 LC WRC/Silversport (05/08)					08.3283 736610
50 Speedfight 2 LR Iron-X/Ultimate (08/10)					08.3283 736610
50 Squab (95/97)				08.9083 730828	08.3333 734683/736721
50 Trekker / TKR P/WRC (98/>)					08.3333 734683/736721
50 TRK 2 WRC/Rally Victories (04/09)					08.3333 736721
50 SV Geo T/RG/Sport (disco/tamb. - 91/95)					08.3199 724335
50 Vivacity/Cat./2 Compact (99/>)					08.4112 739602
50 Zenith L (94/96)					08.3254 (ruota Grimeca) 732614
50 Zenith (estero)					08.3270 731107
50 X-Fight (00/>)					08.3283 736610
50 X-Race (03/>)					08.3283 736610
100 Elyseo (99/>)					08.3332 740993
100 Speedfight/2 (97/>)					08.3283 736610

Applicazioni marca, c.c., modello, anno	Gas	Starter	Freno ant.	Freno post.	Contakm. (** contagiri)
100 SV L Geo (98)					08.3199 724335
100 Trekker (98/>)					08.3333 734683/736721
100 Vivacity/2 (99/>)					08.4112 739602
100 X-Fight (00/>)					08.3283 736610
125 SV Geo (91/95)					08.3199 724335
SV 250 (01/>)	08.9165 (apertura) 754923 08.9164 (chiusura) 754924				08.3340 755139

PIAGGIO SCOOTER

50 Fly 2T (05/07)	08.9314 (manop./sdopp.) 581539			08.9191 564474	08.4144 600315
50 Fly 2T (08/11)	08.9314 (manop./sdopp.) 581539				08.4144 600315
50 Fly 4T-2V (05/11)				08.9191 564474	08.4144 600315
50 Free (92/94)	08.9024 (manop./sdopp.) 268598/581132			08.9028 269002	08.3206 272352
50 Free FL/FL2 (95/00)	08.9024 (manop./sdopp.) 268598/581132			08.9029 560006	08.3206 272352
50 Free Delivery (00/02)	08.9024 (manop./sdopp.) 268598/581132			08.9029 560006	
50 Liberty 2T (97)	08.9007 (manop./sdopp.) 268435 08.9306 (sdopp./misc) 561154/560448 08.9307 (sdopp./carb.) 957297/581173			08.9029 560006/597383	08.3297 560973
50 Liberty 2T (98/01)	08.9306 (sdopp./misc) 561154/560448 08.9307 (sdopp./carb.) 957297/581173			08.9029 560006/597383	08.3297 560973
50 Liberty 2T (02/05)	08.9307 (sdopp./carb.) 957297/581173			08.9029 560006/597383	08.3297 560973
50 Liberty PPTT Euro 2 (04/05)				08.9029 597383	
50 Liberty 2T Rst (04)				08.9029 597383	08.4143 600540/647804
50 Liberty 2T (05/08)					08.4143 600540/56456R
50 Liberty 2T MOC/ELLE (09/13)					08.4143 600540/56456R
50 Liberty 4T (00/03)				08.9029 597383	08.3297 560973

Applicazioni marca, c.c., modello, anno	Gas	Starter	Freno ant.	Freno post.	Contakm. (** contagiri)
50 Liberty 4T Rst (04)				08.9327 564217	08.4143 600540/56456R
50 Liberty 4T (05/08)					08.4143 600540/647804
50 Liberty 4T MOC/ELLE (09/13)					08.4143 600540/647804
50 Liberty 4T Delivery Single (10/12)					08.4143 600540/647804
50 Liberty PPTT (07/08 - Germania)					08.4142 600281/647803
50 NRG (94/96) - 50 NTT (95/96)	08.9010 (manop./sdopp.) 270995 08.9011 (sdopp./misc.) 272290 08.9012 (sdopp./carb.) 272289			08.9013 270993	08.3194 (94/95) 272353/270977 08.3288 (96) 563621/298746
50 NRG MC2 (disco/tamburo - 96/98)	08.9304 (sdopp./misc.) 957298 08.9307 (sdopp./carb.) 957297/581173			08.9013 270993	08.3288 563621/298746
50 NRG MC2 (disco/disco - 96/98)	08.9313 (manop./sdopp.) 563902 08.9304 (sdopp./misc.) 957298/583808 08.9307 (sdopp./carb.) 957297/581173				08.3288 563621/298746
50 NRG Extreme (disco/tamburo - 99/00)	08.9314 (manop./sdopp.) 581539 08.9002 (sdopp./carb.) 268402 08.9306 (sdopp./misc.) 561154/560448			08.9315 560711	08.4101 581287
50 NRG Extreme (disco/disco - 99/00)	08.9314 (manop./sdopp.) 581539 08.9304 (sdopp./misc.) 957298/583808 08.9307 (sdopp./carb.) 957297/581173				08.4101 581287
50 NRG MC3 Aria (disco/tamburo - 01/02)	08.9314 (manop./sdopp.) 581539 08.9304 (sdopp./misc.) 957298/583808 08.9307 (sdopp./carb.) 957297/581173			08.9315 560711	08.4101 581287
50 NRG MC3 Acqua (disco/disco - 01/02)	08.9314 (manop./sdopp.) 581539 08.9306 (sdopp./misc.) 561154/560448				08.4101 581287

Applicazioni marca, c.c., modello, anno	Gas	Starter	Freno ant.	Freno post.	Contakm. (** contagiri)
50 NRG Purejet (02/04)	08.9314 (manop./sdopp.) 581539				08.4101 581287
50 NRG Power Purejet (06/09)	08.9314 (manop./sdopp.) 581539				
50 NRG Power DD/Serie Spec. (06/11)	08.9314 (manop./sdopp.) 581539				
50 NRG Power DT/Serie Spec. (06/11)	08.9314 (manop./sdopp.) 581539			08.9327 564217	
50 Quartz (92/96)	08.9007 (manop./sdopp.) 268435 08.9002 (sdopp./carb.) 268402			08.9018 266213	08.3582 (completa) 268263 08.3583 (flessibile interno) 268264
50 Sfera Base (91/93)	08.5420 (manop./sdopp.) 267981 08.5421 (flessibile interno) 267982			08.9018 266213	08.3587 266848
50 Sfera Maquillage 2 (94)	08.5421 (fless.man./sdopp.) 267982			08.9018 266213	08.3587 266848
50 Sfera FL (Rst - 95/97)	08.9007 (manop./sdopp.) 268435 08.9002 (sdopp./carb.) 268402 08.9306 (sdopp./misc.) 560448/561154			08.9181 (95/96) 273666 08.9303 (97) 562424	08.3275 273667/562403
50 Typhoon (01/04)	08.9306 (sdopp./misc.) 560448			08.9013 270993	08.3288 563621/298746
50 Typhoon (05/11)	08.9314 (manop./sdopp.) 581539			08.9013 270993	
50 Vespa ET2 (Carburatore - 97/05)	08.9300 (manop./sdopp.) 562407/581883 08.9301 (sdopp./misc.) 562408 08.9302 (sdopp./carb.) 563227/582908			08.9303 562424	08.3296 561805/581693 56116R
50 Vespa ET2 Iniezione (97/00)	08.9300 (manop./sdopp.) 562407/581883 08.9301 (sdopp./misc.) 562408			08.9303 562424	08.3296 561805/581693 56116R
50 Vespa ET4 4T (00/05)				08.9327 564217	08.3296 561805/581693 56116R
50 Vespa LX 2T (05/09)				08.9303 562424	08.4135 56307R
50 Vespa LX 4T (05/09)				08.9327 564217	08.4135 56307R
50 Vespa S Special 2T (07/09)				08.9303 562424	

Applicazioni marca, c.c., modello, anno	Gas	Starter	Freno ant.	Freno post.	Contakm. (** contagiri)
50 Vespa S Special 4T-4V (07/09)				08.9303 562424	
50 Velofax (96/99)					08.3277 273835
50 Zip Base (tamburo/tamburo - 92/94)			08.9022 269657	08.9023 269656	08.3594 269062
50 Zip Fast Rider (93/94)	08.9007 (manop./sdopp.) 271612/268435 08.9001 (sdopp./misc.) 271829 08.9002 (sdopp./carb.) 268402			08.9003 271853	08.3195 272340/574331
50 Zip (tamburo/tamburo - 95/96)			08.9022 269657	08.9023 269656	08.3195 272340/574331
50 Zip&Zip Bimodale (tamb./tamb. - 94/97)					
50 Zip (disco/tamburo - 95/96)	08.9007 (manop./sdopp.) 271612/268435			08.9003 271853	08.3195 272340/574331
50 Zip Rst (tamburo/tamburo - 96/99)				08.9312 560781	08.3276 563090/581682
50 Zip Rst (disco/tamburo - 96/99)	08.9007 (manop./sdopp.) 271612/268435			08.9312 560781	08.3276 563090/581682
50 Zip Fast Rider Rst (96/97)	08.9306 (sdopp./misc.) 551154/560448 08.9002 (sdopp./carb.) 468402				
50 Zip SP (96/00)	08.9007 (manop./sdopp.) 271612/268435 08.9306 (sdopp./misc.) 551154/560448 08.9002 (sdopp./carb.) 468402			08.9312 560781	08.3295 561997/582507
50 Zip SP/Euro 2 (01/13)	08.9306 (sdopp./misc.) 560448				08.3295 582507/649335
50 Zip 2T Kat Euro 2 (00/13)	08.9306 (sdopp./misc.) 561154/560448			08.9312 (00/01) 560781	08.4136 581321
50 Zip 4T (00/13)				08.9193 597141	08.4136 581321
80 Quartz (estero)	08.9007 (manop./sdopp.) 268435			08.9018 266213	08.3582 268263 08.3583 (flessibile interno) 268264
80 Sfera (estero)	08.5420 (manop./sdopp.) 267981			08.9018 266213	08.3587 266848
80 Sfera RST (estero)	08.9306 (sdopp./misc.) 560448/561154			08.9181 273666	08.3275 273667/562403
80 SKR City (99/>)					08.3587 266848
100 Fly 4T (06/09)					08.4144 600315

<i>Applicazioni marca, c.c., modello, anno</i>	<i>Gas</i>	<i>Starter</i>	<i>Freno ant.</i>	<i>Freno post.</i>	<i>Contakm. (** contagiri)</i>
100 Free 4T (02/>)	08.9024 (manop./sdopp.) 268598/581132			08.9029 597383	
100 Zip 4T (06/09)				08.9193 597141	08.4136 581321
125 Beverly Rst/Euro 3/ Sport/MIC (04/08)					08.4141 646588/648992
125 Beverly Tourer Euro 3 (07/10)					08.4141 646588/648992
125 Carnaby (07/13)					08.4138 648929
125 Fly/Euro 3 (05/11)				08.9327 564217	08.4144 600315
125 Hexagon 2T (94/97)	08.9170 (manop./sdopp.) 271463 08.9172 (sdopp./carb.) 271480			08.9317 273207/564107	08.3256 273456/274643
125 Hexagon LX4 4T (98/99)				08.9317 273207/564107	08.4105 561279
125 Hexagon LX 2T (98/99)	08.9170 (manop./sdopp.) 271463 08.9172 (sdopp./carb.) 271480			08.9317 273207/564107	08.4105 561279
125 Hexagon GTX 4T (ruote 11" - 00)	08.9196 (completa) CM065901				08.4105 561279
125 SuperHexagon GTX 4T (ruote 12" - 01/02)	08.9196 (completa) CM065901				
125 Liberty (98)	08.9305 (completa) 561804			08.9325 563960/597320	08.3297 560973
125 Liberty (99/00)	08.9324 (completa) 563601/CM065903			08.9325 563960/597320	08.3297 560973
125 Liberty (Mot. Leader - 00/01)	08.9194 (completa) 581906/CM065904			08.9195 564847	08.3297 560973
125 Liberty (02/03)	08.9194 (completa) 581906/CM065904			08.9327 564217	08.3297 560973
125 Liberty Rst (04/05)				08.9327 564217	08.4142 600281/647803
125 Liberty 4T/Euro 3 (06/08)					08.4142 600281/647803
125 Liberty Rst PPTT (05/11)					08.4142 600281/647803
125 Liberty 4T Delivery/TNT (07/12)					08.4142 600281/647803
125 Sfera FL Rst 4T (95/97)	08.9305 (completa) (561804 - 7-96/>)			08.9188 560665	08.3275 273667/562403
125 Skipper 2T (94/97)	08.9007 (manop./sdopp.) 268435			08.9018 266213	08.3582 (completa) 268263 08.3583 (flessibile interno) 268264

<i>Applicazioni marca, c.c., modello, anno</i>	<i>Gas</i>	<i>Starter</i>	<i>Freno ant.</i>	<i>Freno post.</i>	<i>Contakm. (**contagiri)</i>
125 Skipper LX 2T (98/99)	08.9185 (manop./sdopp.) 564023 08.9186 (sdopp./carb.) 271623 08.9187 (sdopp./misc.) 564052			08.9188 560660	08.4106 560243
125 Skipper ST 4T (00/>)					08.4106 560243
125 Vespa ET4 (96/8-98)	08.9305 (completa) 561804			08.9303 562424	08.3296 561805/581693 56116R
125 Vespa ET4 (9-98/00)	08.9324 (completa) 563601/CM065903			08.9303 562424	08.3296 561805/581693 56116R
125 Vespa ET4 (Mot. Leader - 00/05)	08.9326 (completa) 581212/CM065907			08.9327 564217	08.3296 561805/581693 56116R
125 Vespa LX/Euro3/FL/IE/3V/ Touring (05/13)				08.9327 564217 (fino a 30/04/10)	08.4135 56307R/649347
125 Vespa GranTurismo/Euro 3 (03/08)					08.4140 599350/651072
125 Vespa GTS Euro 3 (07/12)					08.4140 599350/651072
125 Vespa S Special/IE/College (07/11)				08.9327 564217	
125 X 8/Premium/Street/ Euro 3 (04/08)					08.4139 648572
125 Zip 4T (00/02)	08.9192 (completa) CM065909			08.9193 597141	08.3295 561997/582507
150 Fly/Euro 3 (05/11)				08.9327 564217	08.4144 600315
150 Hexagon 2T (94/97)	08.9170 (manop./sdopp.) 271463 08.9172 (sdopp./carb.) 271480			08.9317 273207/564107	08.3256 273456/274643
150 Liberty (00/01)	08.9194 (completa) 581906/CM065904			08.9195 564847	08.3297 560973
150 Liberty (02/03)	08.9194 (completa) 581906/CM065904			08.9327 564217	08.3297 560973
150 Liberty 4T Euro 3 (08/09)					08.4142 600281/647803
150 Skipper 2T (94/97)	08.9007 (manop./sdopp.) 268435			08.9018 266213	08.3582 (completa) 268263 08.3583 (flessibile interno) 268264
150 Skipper LX 2T (98/99)	08.9185 (manop./sdopp.) 564023 08.9186 (sdopp./carb.) 271623 08.9187 (sdopp./misc.) 564052			08.9188 560665	08.4106 560243

<i>Applicazioni marca, c.c., modello, anno</i>	<i>Gas</i>	<i>Starter</i>	<i>Freno ant.</i>	<i>Freno post.</i>	<i>Contakm. (** contagiri)</i>
150 Skipper ST 4T (00/>)					08.4106 560243
150 Vespa ET4 (99/05)	08.9326 (completa) 581212/CM065907			08.9327 564217	08.3296 561805/581693 56116R
150 Vespa LX/Euro3/FL/IE/3V/ Touring (05/13)				08.9327 564217 (fino a 30/04/10)	08.4135 56307R/649347
150 Vespa S Special/IE/College (08/12)				08.9327 564217	
150 X 8 Street (06/08)					08.4139 648572
180 Hexagon LXT 2T (98/99)	08.9170 (manop./sdopp.) 271463 08.9172 (sdopp./carb.) 271480			08.9317 273207/564107	08.4105 561279
180 Hexagon GTX 4T (ruote 11" - 00)	08.9196 (completa) CM065901				08.4105 561279
180 Super Hexagon GTX 4T (ruote 12" - 01/02)	08.9196 (completa) CM065901				
200 Carnaby (07/09)					08.4138 648929
200 Liberty Rst (04)				08.9327 564217	08.4142 600281/647803
200 Liberty Rst (05/09)					08.4142 600281/647803
200 Vespa GranTurismo/Euro 3 (03/07)					08.4140 599350/651072
200 X 8 (04/07)					08.4139 648572
250 Beverly Rst/Euro 3/IE/Sport/ MIC (04/08)					08.4141 646588/648992
250 Carnaby (08/09)					08.4138 648929
250 Hexagon GT/GTX (98/02)	08.9169 (apertura) 580951 08.91691 (chiusura) 580952			08.9317 (modello GT) 273207/564107	08.4105 561279
250 X 8 Euro 3 (05/08)					08.4139 648572
250 X 9 (00/03 - mot. Honda)	08.9197 (apertura) 581312 08.9198 (chiusura) 581313				
400 Beverly i.e. Euro 3 (fino a </06-06)					08.4137 599685
400 Beverly i.e. Euro 3 (da 07-06/>)					08.4141 646588/648992
400 Beverly Tourer (08/09)					08.4137 599685
400 X 8 Euro 3 (06/08)					08.4139 648572
500 Beverly/Euro 3 (02/09)					08.4137 599685

Applicazioni marca, c.c., modello, anno	Gas	Starter	Freno ant.	Freno post.	Contakm. (** contagiri)
PIAGGIO VESPA - COSA					
50 Vespa L/R/S (63/83)	08.5421 (fless.int. - 070981)				08.3460 071059
50 Vespa Elestart (70/76)	08.5421 (fless.int. - 070981)				08.3460 071059
50 Vespa Special (70/83)	08.5421 (fless.int. - 070981)				08.3460 071059
50 Vespa SS/Sprinter (66/73)	08.5421 (fless.int. - 070981)				08.3460 071059
50 Vespa PK/S/SS/XL/XL Rush/ N (82/90)					08.3400 195407
50 Vespa PK N Speedmatic (90)					08.3400 195407
50 Vespa PK Automatica (90)					08.3410 266321
50 Vespa PK/FL/FL2 HP (90/97)					08.3410 266321
90 Vespa/SS/Racer (63/73)	08.5421 (fless.int. - 070981)				08.3460 071059
125/150/200 Cosa CL/CLX/ Cosa 2 (88/97)					08.3160 229358
125 Vespa Primavera (67/79)	08.5421 (fless.int. - 070981)				08.3460 071059
125 Vespa Primavera (80/83)	08.5421 (fless.int. - 070981)				08.3100 183582/213467
125 Vespa ET3 (76/79)	08.5421 (fless.int. - 070981)				08.3460 071059
125 Vespa ET3 (80/83)	08.5421 (fless.int. - 070981)				08.3100 183582/213467
125 Vespa PK/S/XL (82/89)					08.3400 195407
125 Vespa PK FL (89/91)					08.3410 266321
125 Vespa P-X (77/82)/PX-E (81/82) 150 Vespa P-X (78/81)/PX-E (81/82)					08.3090 174161
200 Vespa P-E (77/82)/PX-E (82)					08.3091 (flessibile interno) 174160 (1035mm)
125/150/200 Vespa PX-E Arcobaleno (81/97)					08.3150/08.3160 179271/229358
125 Vespa PX T5 (85/89)					08.3151 (fless.Int. 08.3150) 179272 (1038mm)
125 Vespa ETS (84/85)					
125/150/200 Vespa PX (fr. disco - 98/01)					08.4102 563796/601105
125 Vespa PX Euro 2/ PX 30 Anni (01/08)					08.4102 563796/601105
125/150 Vespa PX (11/13)					08.4102 563796/601105
125 Vespa GT/GTR (66/78)					08.3560 099011
125 Vespa Super (66/68)					08.3560 099011
125 Vespa TS (75/78)					08.3560 099011
150 Vespa Super (66/78)					08.3560 099011
150 Vespa Sprint (65/74)					08.3560 099011
150 Vespa Sprint Veloce (69/79)					08.3560 099011
180/200 Vespa Rally (68/79)					08.3560 099011

Applicazioni marca, c.c., modello, anno	Gas	Starter	Freno ant.	Freno post.	Contakm. (** contagiri)
PIAGGIO APE					
50 Ape P (80/85)		08.5401 (completa) 118456			08.3586 188636
50 Ape TM P (85/89)/FL/FL2/ FL3 (89/99)					08.3586 188636
50 Ape Rst Mix/Euro2/Cross/ Top (99/13)	08.4013 (manop./sdopp.) 567102/658205 B007701				08.3586 188636 B026174
125/150/175 Ape 350400/500 (67)					08.3560 099011
190 Ape MP 500 (MPR1 - 70/78)					08.3592 125500
190 Ape MP P501 (MPR2 I/II Serie - 78/83)					08.3592 125500
190 Ape MP/MPV 600 (70/78)					08.3580 125300
220 Ape MP P 601/V (I Serie - 78/82)		08.5455 (completa) 142538			08.3580 P 601 V (Volante) 125300
220 Ape MP P 601/V (II Serie - 82/96)	08.5497 (misc./carb.) 224979	08.5455 (completa) 142538			08.3580 P 601 V (Volante) 125300
220 Ape Car P2/P3 (78/85)	08.5480 (ped./misc.) (P2/AF3T - 82/85) 133440 08.5497 (misc./carb.) 224979				
220 Ape TM P 602 (82/83) 220 Ape TM P 703/FL/FL2 (84/04)	08.5496 (manubrio/misc.) 177128 08.5497 (misc./carb.) 224979				
420 Ape Car Diesel (86/88)	08.5016 (completa) 227909				
420 Ape Max Diesel (88/96)	08.5014 (completa) 225083				
420 Ape Poker Benzina (88/96)	08.5017 (completa) 266495				
PIAGGIO MINIVETTURE					
500 Ligier Nova (00/04)					08.4134 133013L
500 Ligier Ambra 162 (98/00)					08.4134 133013L
RIZZATO					
50 Hacker AT12/Racing/LC					08.3247 1231481000

Applicazioni marca, c.c., modello, anno	Gas	Starter	Freno ant.	Freno post.	Contakm. (** contagiri)
SUZUKI					
50 AH Address (92/95)					08.3269 34910-09E10-000
50 AP R/T (94/97)					08.3265 34910-09EF0-000
50 AY/AYW Katana/LC (97/04)					08.3305 34910-35E00-000
50 AY Katana IE (05/06)					08.3305 34910-35E00-000
125/150 AN (95/00)					08.3306 34910-20E00-000
125/150 Epicuro (99/01)					08.4122 34910-21F00-000
250 AN Burgman (98/02)	08.9178 (chiusura) 58300-14F10-000			08.9174 (fr. stazionamento) (98/00) 58810-14F00-000	
400 AN Burgman (99/02)	08.9175 (apertura) 58300-14F30-000			08.9174 (fr. stazionamento) (99/00) 58810-14F00-000	
600 DR S (85/89) - 600 DR R (86)					08.3306 34910-20E00-000
SYM					
50 DD/Euro 2 (02/08)					08.4162 44830T47000
50 Jungle (99/00)					08.4165 44830H6C000
50 Mio (06/09)					08.4162 44830T47000
50 Red Devil (99)					08.4165 44830H6C000
50 Jet / Euro X Euro 2 (99/07)					08.4165 44830H6C000
50 Jet 4 4T (09/10)					08.4169 44830ABA000
50 Jet 4R 2T (11/13)					08.4165 44830H6C000
50 Mask/Euro 2 (00/04)					08.4169 44830ABA000
50 Symply (07/08)					08.4161 44830H09000
50 Symply II (09/13)					08.4169 44830ABA000
50 Super Fancy (98/00)					08.4161 44830H09000
50 X-Pro (13/14)					08.4169 44830ABA000
100 Jet (99/00)					08.4165 44830H6C000
100 Mio/Euro 2/Euro 3 (05/08)					08.4162 44830T47000
125/150 Attila (99/01)					08.4165 44830H6C000
125/150 Euro MX/Euro 2 (02/04)					08.4167 44830H3A600
125 Fiddle II (08)					08.4169 44830ABA000
125 Jet 4 (09/10)					08.4169 44830ABA000
125 HD Euro 2 (03/04)					08.4163 44830M96000
125 HD Euro 3 (07/08)					08.4166 44830HHA000

<i>Applicazioni marca, c.c., modello, anno</i>	<i>Gas</i>	<i>Starter</i>	<i>Freno ant.</i>	<i>Freno post.</i>	<i>Contakm. (** contagiri)</i>
125 HD EVO/Euro 3 (05/13)					08.4166 44830HHA000
125 Joy Ride/EU 2 (01/04)					08.4168 44830H9A007
125 Megalo (06/08)					08.4165 44830H6C000
125 New Duke (00/01)					08.4165 44830H6C000
125/150 VS/Euro 3 (06/09)					08.4164 44830VS1100
125 Symply (07/09)					08.4169 44830ABA000
125 Symply II (09/13)					08.4161 44830H09000
125 Super Duke (99/02)					08.4169 44830ABA000
125 X-Pro (13/14)					08.4169 44830ABA000
150 Fiddle II (10/13)					08.4168 44830H9A007
150 Joy Ride (01/02)					08.4167 44830H3A600
150 Shark (00/01)					08.4165 44830H6C000
200 HD (03/04)					08.4166 44830HHA000
200 HD Euro 3 i (07/08)					08.4166 44830HHA000
200 HD EVO/Euro 2/Euro 3 i (04/13)					08.4168 44830H9A007
200 Joy Ride/EU 2 (03/04)					08.4168 44830H9A007

TGB

50 101 R (BH1-C)					08.4148 402127
50 104 T - 50 Hawk					08.4148 402127
50 303/R/RS (BR-1)					08.4148 402127
50 Akros TEC (GE5)					08.4149 GE5160003
50 Ergon - 50 101 A - 50 202 T					08.3328 401660
50 Delivery (BK1-C - 04/09)					08.3328 401661
50 Laser (04/05)					08.4148 402127
50 Laser R5/R5i (BR1-D - 06/09)					08.4148 402127
50 Sunset (BK1-U - 07/08)					08.3328 401661
150 Laser (04/05)					08.4148 402127
150 Laser R9/R9i (BR9-D - 06/09)					08.4148 402127
150 Sunset (BK9-U - 07/08)					08.3328 401661

T R A S M I S S I O N I

Applicazioni marca, c.c., modello, anno	Gas	Starter	Freno ant.	Freno post.	Contakm. (** contagiri)
YAMAHA SCOOTER					
50 Aerox (97/01)	08.9335 (manop./sdopp.) 5BRF63110000 08.9031 (sdopp./carb.) 3VLF63120100	08.9337 (leva/sdopp.) 5BRF63310000 08.9033 (sdopp./carb.) 3VLF63340200			08.3298 5BRH35500200
50 Aerox (02/08)	08.9335 (manop./sdopp.) 5BRF63110000 08.9031 (sdopp./carb.) 3VLF63120100	08.9337 (leva/sdopp.) 5BRF63310000 08.9033 (sdopp./carb.) 3VLF63340200			08.4170 5PUH33500100
50 Aerox (09/12)	08.9030 (manop./sdopp.) 3VLF63110200 08.9031 (sdopp./carb.) 3VLF63120100				08.4170 5PUH33500100
50 Axis S/T (94/96)	08.9064 (sdopp./carb.) 3WGF6312C000				08.3257 4PCH35500000
50 Breeze (94/95)	08.9060 (manop./sdopp.) 4CUF63111000			08.9062 4CUF63510000	08.3229 4PAH35500100
50 BW'S Bump (97/98)	08.9030 (manop./sdopp.) 3VLF63110100 08.9031 (sdopp./carb.) 3VLF63120100	08.9038 (leva/sdopp.) 4SBF63310000 08.9033 (sdopp./carb.) 3VLF63340200		08.9037 4SBF63510000	08.3278 4YBH35500100
50 BW'S Next Generation (97/06)	08.9030 (manop./sdopp.) 3VLF63110100 08.9031 (sdopp./carb.) 3VLF63120100	08.9038 (leva/sdopp.) 4SBF63310000 08.9033 (sdopp./carb.) 3VLF63340200		08.9037 (97/00) 4SBF63510000	08.3262 4SBH35500300
50 BW'S Original (97/00)	08.9030 (manop./sdopp.) 3VLF63110100 08.9031 (sdopp./carb.) 3VLF63120100	08.9033 (sdopp./carb.) 3VLF63340200		08.9035 3VLF63510000	08.3229 4PAH35500200
50 BW'S Original/Euro 2 (01/03) 50 CW BW'S Original/SP (02) 50 BW'S R (01)	08.9030 (manop./sdopp.) 3VLF63110100 08.9031 (sdopp./carb.) 3VLF63120100	08.9033 (sdopp./carb.) 3VLF63340200		08.9036 5JHF63510100	08.3229 4PAH35500200
50 BW'S Naked (03)	08.9030 (manop./sdopp.) 3VLF63110100 08.9031 (sdopp./carb.) 3VLF63120100	08.9033 (sdopp./carb.) 3VLF63340200			
50 BW'S (04/09)	08.9030 (manop./sdopp.) 3VLF63110100				08.4171 5WVH355000
50 BW'S (10/13)					08.4171 5WVH355000
50 CW RS Spy (95/98)	08.9030 (manop./sdopp.) 3VLF63110100 08.9031 (sdopp./carb.) 3VLF63120100	08.9038 (leva/sdopp.) 4SBF63310000 08.9033 (sdopp./carb.) 3VLF63340200		08.9037 4SBF63510000	08.3262 4SBH35500200

<i>Applicazioni marca, c.c., modello, anno</i>	<i>Gas</i>	<i>Starter</i>	<i>Freno ant.</i>	<i>Freno post.</i>	<i>Contakm. (** contagiri)</i>
50 CW L BW'S (03)	08.9030 (manop./sdopp.) 3VLF63110100 08.9031 (sdopp./carb.) 3VLF63120100	08.9033 (sdopp./carb.) 3VLF63340200		08.9036 5JHF63510100	08.3229 4PAH35500200
50 CW L BW'S (04)	08.9030 (manop./sdopp.) 3VLF63110100 08.9031 (sdopp./carb.) 3VLF63120100	08.9033 (sdopp./carb.) 3VLF63340200		08.9036 5JHF63510100	08.4171 5WWH35500000
50 CR Z (91/95)	08.9050 (manop./sdopp.) 3GFF63110000 08.9051 (sdopp./carb.) 3GFF63120000				08.3198 3GFH35500000
50 CT S/SS (90/95)	08.9041 (sdopp./carb.) 1NTF63120000		08.9042 1NTF63410000		08.3167 1NTH35500000
50 Neo's (97/06)	08.9330 (manop./sdopp.) 5ADF63110100 08.9331 (sdopp./carb.) 5RNF63122000	08.9333 (leva/sdopp.) 5ADF63310000 08.9334 (sdopp./carb.) 5ADF63340000		08.9332 5ADF63510000	08.3281 (97/01) 5ADH35500100
50 Slider (00/>)	08.9338 (manop./sdopp.) 4UYF63110000 08.9162 (sdopp./carb.) 4UYF63120000	08.9038 (leva/sdopp.) 4SBF63310000 08.9033 (sdopp./carb.) 3VLF63340200		08.9036 5JHF63510200	08.3262 4SBH35500200
50 Why/Cat. (98/06)	08.9161 (manop./sdopp.) 5EUF63110000 08.9162 (sdopp./carb.) 4UYF63120000			08.9163 5EUF63510100	08.3341 5EUH35500000
100 BW'S (99/01)					08.3875 4VPH35500100
100 Neo's (99/02)		08.9333 (leva/sdopp.) 5ADF63310000 08.9334 (sdopp./carb.) 5ADF63340000		08.9332 5ADF63510000	08.3281 5ADH35500100
100 Aerox (00/02)		08.9337 (leva/sdopp.) 5BRF63310000			08.3298 5BRH35500200
125/150 Majesty (DT - 98/02)	08.9159 (completa) 5DSF63110000			08.9160 5DSF63510000	08.4103 5DSH35500000
125/150 Majesty (DD - 01/02)	08.9159 (completa) 5DSF63110000				
125 XC T Cygnus (95/98)					08.3280 4KCH35500000
125 NXC Cygnus X (04/05)					08.4172 5MLH35500000
125 NXC Cygnus X (06)					08.4173 5MLH35501000
250 Majesty (96/98)/DX (98/00)					08.3229 5HC835500000
250 Majesty (00/01)	08.9066 (apertura) 5GM263110000 08.9067 (chiusura) 5GM263120000				

Applicazioni marca, c.c., modello, anno	Gas	Starter	Freno ant.	Freno post.	Contakm. (** contagiri)
YAMAHA MOTO					
125 XV Virago (97/00)					08.4108 16M835500100
250 XV/S Virago (95/99)					08.4108 16M835500100
350 XT (85/00)					08.4108 48Y835500300
400 XS R (82/83)					08.4108 16M835500100
500 SR (78/87)					08.4108 16M835500100
500 TT (80/81)					08.4108 16M835500100
500 TX / A (73/74)					08.4108 16M835500100
500 XS (75/77)					08.4108 16M835500100
535 XV Virago/SE/DX (87/99)					08.4108 16M835500100
550 XJ (81/83)					08.4108 16M835500100
550 XZ R (82/83)					08.4108 16M835500100
600 FZR (91/93)					08.4108 16M835500100
600 TT R (98/02)					08.4104 5CHH35501000
600 XT (84/89)					08.4108 16M835500100
600 XT E/K (90/02)					08.4108 16M835500100
600 XT Z Ténéré (83/87)					08.4108 16M835500100
600 XT Z Ténéré (88/90)					08.3235 3AJ835500300
600 XT Z Ténéré (88/90)					08.3234 ** (** contagiri) 3AJ835600100
600 XY Radian (86/90)					08.4108 16M835500100
650 TX / A (73/74)					08.4108 16M835500100
650 XS1 / XS1B / XS2 (70/72)					08.4108 16M835500100
650 XS /XS-S (75/83)					08.4108 16M835500100
750 FZX (86/88)					08.4108 16M835500100
750 TX (73/74)					08.4108 16M835500100
750 XS (77/79)					08.4108 16M835500100
850 XS (80/81)					08.4108 16M835500100
900 XJ R Seca (83 - 31A)					08.4108 16M835500100
900 XJ (89/92 - 3NG/4BB)					08.4108 16M835500100
1100 FJ L/LC (84/85)					08.4108 16M835500100
1100 XS (79/81)					08.4108 16M835500100
1200 FJ / S / ABS (86/93)					08.4108 16M835500100

Trasmissioni freno a mano, frizione, cambio, retromarcia, avviamento, adattabili "Piaggio Vespa-Ape"

Trasmissioni freno a mano

<i>Applicazione</i>	<i>Cod. SGR</i>	<i>Rif. orig.</i>
Ape P50 (80/85) • Ape TM P50 (85/89)	08.5410	117675
Ape 50 FL/FL2 (89/95)	08.5410	117675
Ape 50 FL3 Europa (95/99)	08.5410	117675
Ape 50 Mix RST (99/08)/Euro 2 (09/13)	08.5410	117675
Ape MP P 601/P 601 V (1ª Serie - 78/82)	08.5457	119094
Ape MP P 601/P 601 V (2ª Serie modifica - 82/96)	08.5470	140247
Ape Max Diesel • Ape Car Diesel	08.5015	226714
Ape Car/P2/P3	08.5478	128510
Ape Poker Benzina/Diesel	08.5012	265285



Trasmissioni frizione

<i>Applicazione</i>	<i>Cod. SGR</i>	<i>Rif. orig.</i>
Ape TM P 602 (82/83)	08.5492	177150
Ape TM P 703/FL/FL2 (manubrio - 84/05)	08.5492	177150
Cosa 2 125/150/200 (91/97 - flessibile interno)	08.5506	267192
Vespa 50 PK FL/HP (flessibile interno)	08.5506	267192
Vespa 125 PK FL (flessibile interno)	08.5506	267192

Trasmissioni cambio

<i>Applicazione</i>	<i>Cod. SGR</i>	<i>Rif. orig.</i>
Vespa PK 50/125/XL/S/N (flessibile interno)	08.5511	195397

Trasmissioni retromarcia

<i>Applicazione</i>	<i>Cod. SGR</i>	<i>Rif. orig.</i>
Ape P 50 (80/85)/TMP 50 (85/89)	08.5409	117309
Ape Car/Ape Car P2/P3 (78/85)	08.5477	128935
Ape MP 550/600 • MPV 600 • MP P 601/V	08.5459	159693-109426
Ape MP P 501	08.5469	159423-116576
Ape TM P 703/V/FL/FL2 (84/05)	08.5499	266596

Trasmissioni comando avviamento

<i>Applicazione</i>	<i>Cod. SGR</i>	<i>Rif. orig.</i>
Ape P 50 (80/85) • Ape TM P 50 (85/89) Ape 50 FL/FL2/ FL3 Europa (89/99)	08.5402	116311

Tappi al serbatoio

25.0080 tappo serbatoio olio



Di primo equipaggiamento su:

Cagiva City 50

Honda SFX 50 S • SH 50 Fifty (96/>) • X8RS • X8RX • BSV GP 50 Dio • SP 50 Dio Bali 100 • Pantheon 125/150 (98/02) • SH 100 • Sky 50 • SJ 50 Bali (97/>)

Peugeot scooter 50/100 tutti • SV 125 Geo • Elyseo 125 (99/00)

Rif. Cagiva: Y00FA0215

Rif. Honda: 55105-GBM-750

Rif. Peugeot: 721750

25.0081 tappo serbatoio olio



Di primo equipaggiamento su:

Betamotor 50 Quadra • 50 Tempo 13" 50 Tempo 16" • 50 Chrono 502

Rif. orig.: 2900530052

25.0083 tappo serbatoio olio



Per:

Honda SA 50/75 Vision • SK 50 Dio (92/00) • NE 50 NH 90 • SRX 50/90 Shadow • SJ 50 Bali (93/96)

NSR 50/75 R • NSR 125 R/F • CRM 125 R (90/99)

Kymco 50 DJW/DJX/DJY • 50 CX/Super • 50 KB 50 K12 • 50 Heroism • 50 Fever ZX/Euro 2 (99/04)

Rif. Honda: 55105-GK8-000

Rif. Kymco: 55105-GHK8-000 • 00161006

25.12308 tappo serbatoio benzina ventilato con chiave completo di ghiera fissaggio - Ø 33/48



Per:

Piaggio Ape P/TMP 50 (c/serbatoio in metallo)

Piaggio Ciao • Boxer • Bravo • Si/FL2/Mix • Boss e universale per ciclomotori in genere

Rif. orig.: 298988

25.12312 tappo serbatoio benzina ventilato - con chiave completo di ghiera fissaggio - Ø 28/39



Per:

Piaggio Ciao P/PV/PX/PXV (80/88) • Ciao Tre (71/99) • Grillo 50

Piaggio Ape 50 P/TMP (80/89 - con serbatoio in plastica)

Ape 50/FL/FL2/FL3 (89/99 - con serbatoio in plastica)

Rif. orig.: 2705865 • 2570835

25.15308 tappo serbatoio benzina ventilato - con chiave



Per:

Piaggio Ape MP/MPV • Ape MP500/ME600 • Ape MP P501/P601 Apecar P2/P3 • Ape TMP 602 • Ape TMP 703/V/FL2/Diesel

Rif. orig.: 190621 • 262324 • 193627

25.12250 tappo serbatoio benzina "ZADI" (Q536) - Ø testata 50 mm. - Ø bocchettone 28,7 colore nero - c/chiavi Zadi



Per:

Puch Maxi

Indice codice articolo

08.3033202	08.3586221	08.5477227	08.9186218	28.007077,79
08.3064208,210	08.3587215,216	08.5478227	08.9187218	28.007276,79
08.3080205,206	08.3592221	08.5480221	08.9188217,218	28.007376,79
08.3088202	08.3594216	08.5492227	08.9191213	28.007469,70,74,79
08.3090220	08.3861205	08.5496221	08.9192218	28.007670,72,73,77,79
08.3091220	08.3870202	08.5497221	08.9193216,217,218	28.0076172,73,77,79
08.3100220	08.3875211,225	08.5499227	08.9194217,218	28.007770,71,72,77,79
08.3122202	08.3959205,212	08.5506227	08.9195217,218	28.007870,71,72,79
08.3150220	08.3960205,212	08.5511227	08.9196217,219	28.008870,74,79
08.3151220	08.3961205,212	08.9001216	08.9197219	28.009377,80
08.3157202	08.3962205,212	08.9002203,214,215,216	08.9198219	28.010171,80
08.3158202,203	08.4013221	08.9003203,216	08.9200202	28.010872,74,75,80
08.3160220	08.4100204	08.9007203,213,215,216,217,218	08.9202202	28.010969,70,74,79
08.3163200	08.4101214,215	08.9010204,214	08.9220202	28.011072,74,75,80
08.3167210,225	08.4102220	08.9011204,214	08.9300215	28.011170,75,80
08.3189202,205	08.4103211,225	08.9012204,214	08.9301215	28.011270,80
08.3190208	08.4104226	08.9013204,214,215	08.9302215	28.012077,80
08.3193200,201	08.4105217,219	08.9018215,216,217,218	08.9303203,215,216,218	28.012470,80
08.3194204,214	08.4106218,219	08.9022216	08.9304214	28.013270,80
08.3195203,216	08.4107201	08.9023216	08.9305217,218	28.013573,80
08.3196208	08.4108226	08.9024213,217	08.9306213,214,215,216	28.013772,80
08.3197208	08.4109201	08.9028213	08.9307203,213,214	28.013871,80
08.3198206,210,225	08.4110208,209,210	08.9029213,217	08.9309203	28.014471,76,80
08.3199212,213	08.4111210	08.9030210,224,225	08.9310203,204	28.022670,71,72,73,77,81
08.3205200,201	08.4112212,213	08.9031210,211,224,225	08.9312216	28.023674,75,81
08.3206213	08.4113200,201	08.9033210,211,224,225	08.9313214	28.023876,81
08.3207209	08.4114200,201	08.9035210,224	08.9314213,214,215	28.023970,71,72,73,77,81
08.3208202	08.4116202	08.9036210,211,224,225	08.9315204,214	28.024174,75,81
08.3214200	08.4119206,207,208	08.9037210,224	08.9316204	28.024773,81
08.3216203	08.4120207	08.9038210,211,224,225	08.9317217,218,219	28.026773,81
08.3217203	08.4121207	08.9041210,225	08.9318204	28.030572,83
08.3226205	08.4122222	08.9042210,225	08.9319204	28.031375,83
08.3227202,205	08.4125201	08.9050210,225	08.9321203,204	28.031771,76,83
08.3228205,206,207	08.4126205	08.9051210,225	08.9322204	28.040473
08.3229210,224,225	08.4127205	08.9058207	08.9324217,218	28.040669,83
08.3232210	08.4128211	08.9060210,224	08.9325217	28.051269,70,71,72,73
08.3234226	08.4129211,212	08.9062210,224	08.9326218,219	28.051474,75,76,77,81
08.3235226	08.4130211	08.9064211,224	08.9327214,215,217,218,219	28.051569,72,73,77,81
08.3247221	08.4131212	08.9066211,225	08.9330211,225	28.052175,81
08.3253208	08.4132203	08.9067211,225	08.9331211,225	28.052369,76,81
08.3254212	08.4133204	08.9083212	08.9332211,225	28.053075,81
08.3255212	08.4134221	08.9100208	08.9333211,225	28.053671,72,73,74,76,77,81
08.3256217,218	08.4135215,218,219	08.9103210	08.9334211,225	28.053771,72,76,82
08.3257211,224	08.4136216,217	08.9104210	08.9335211,224	28.053872,82
08.3259206	08.4137219	08.9105210	08.9337211,224,225	28.053975,82
08.3262210,211,224,225	08.4138217,219	08.9107208	08.9338211,225	28.054075,82
08.3263200	08.4139218,219	08.9108208	08.9340206	28.054175,82
08.3265222	08.4140218,219	08.9110208,209	08.9341206	28.054275,82
08.3266206	08.4141217,219	08.9111209	08.9342206	28.054471,82
08.3269222	08.4142214,217,218,219	08.9112209	08.9344206	28.060475,82
08.3270212	08.4143213,214	08.9125208,209	08.9345206	28.060877,82
08.3275215,216,217	08.4144203,213,216,217,218	08.9129200	08.9346206		
08.3276216	08.4146212	08.9130200,201	08.9347207	29.3581615,30
08.3277216	08.4147212	08.9131200	08.9348207	29.3581715,16,18,23,30
08.3278210,224	08.4148223	08.9132200,201	08.9349207	29.3581815,16,18,23,30
08.3280211,225	08.4149223	08.9134201	08.9351200	29.3581915,30
08.3281211,225	08.4150206,207,208	08.9135200	08.9356201	29.3582615,17,18,30
08.3282212	08.4152206,207	08.9136200	08.9357201	29.3583212,13,14,16,17,18,23,24,30
08.3283212,213	08.4153206,207	08.9137200	08.9358205	29.3583415,20,21,31
08.3286208	08.4154207	08.9139200,201	08.9359205	29.3583813,14
08.3287209	08.4155206,207	08.9140200	08.9370208	29.35838113,14
08.3288204,214,215	08.4156206	08.9141200	08.9374208	29.3584112,30
08.3292202	08.4157206,207	08.9142200	08.9375208	29.3584221,22,30
08.3295216,218	08.4158206,207	08.9143200	08.9411212	29.35842121,22,30
08.3296215,218,219	08.4159208	08.9144200	08.9412212	29.3584615
08.3297213,217,218	08.4160205	08.9145201			29.3584818,24,30
08.3298211,224,225	08.4161222,223	08.9146201	09.281869,83	29.3585714,16,18,30
08.3301206,207	08.4162222	08.91461201	09.281969,83	29.3589015,30
08.3305222	08.4163222	08.9147201	09.282569,83	29.3593115,30
08.3306222	08.4164223	08.9148201			29.3593219
08.3313200	08.4165222,223	08.9149201	25.0080228	29.3593621,31
08.3314203	08.4166222,223	08.91491201	25.0081228	29.3593919
08.3315203	08.4167222,223	08.9150205	25.0083228	29.3594319,20
08.3316201	08.4168223	08.9151205	25.12250228	29.3594514,18,19,23,24,30
08.3317200	08.4169222,223	08.9152205	25.12308228	29.3594714,16,18,19,20,23,24,30
08.3322205	08.4170211,224	08.9153205	25.12312228	29.3595615,30
08.3323205	08.4171210,224,225	08.9159211,225	25.15308228	29.3595720,30
08.3325202	08.4172225	08.9160211,225			29.3595819,30
08.3326205	08.4173225	08.9161211,225	28.000170,73,74,77,78	29.3596117,30
08.3328223	08.5012227	08.9162211,225	28.002270,71,74,78	29.3596614,16,20,21,31
08.3329206,207	08.5014221	08.9163211,225	28.0025170,71,73,77,78	29.3599317,19,24,30
08.3332212	08.5015227	08.9164205,213	28.003372,78	29.35993117,19,24,30
08.3333212,213	08.5016221	08.9165205,213	28.0033172,78	29.3692813,30
08.3336202	08.5017221	08.9166205	28.0038170,71,73,74,75,77,78	29.3693113,30
08.3338201	08.5401221	08.9167205	28.004074,78	29.3693415,31
08.3340205,213	08.5402227	08.9168205	28.004170,74,78	29.3693614,16,20,21,31
08.3341211,225	08.5409227	08.9169219	28.005072,78	29.3693822,30
08.3343209	08.5410227	08.91691219	28.0050172,78	29.36938122,30
08.3400220	08.5420215,216	08.9170217,218,219	28.005272,78	29.3694314,18,20,30
08.3410220	08.5421215,220	08.9172217,218,219	28.005876,78	29.36943114,18,20,30
08.3460220	08.5455221	08.9174222	28.005976,78	29.3694523
08.3560220,221	08.5457227	08.9175222	28.006370,78	29.36945123
08.3580221	08.5459227	08.9178222	28.006470,73,75,79	29.3694816,19,24,30
08.3582215,216,217,218	08.5469227	08.9181215,216	28.006670,71,77,79	29.36948116,19,24,30
08.3583215,216,217,218	08.5470227	08.9185218	28.006777,79	29.3695015,31

29.3695121,22,30	29.40210417,23,26	29.463500235,45	41.10032140,142,166	41.10282116,118,120,122
29.3695221	29.40210513,16,17,19,24,26	29.463500636,45	41.10043152,184	41.10283118,120,122, 124,126,128,164
29.3695319,24,30	29.40210623,24,26	29.463501935,37,38,45	41.10044132,152,154,154, 156,158,160,162	41.10284118,120,122
29.36953119,24,30	29.40210713,26	29.463502036,45	41.10045108,110,142,144, 152,154,170,190	41.10285118,120,122,124,128
29.3695417,19,24,30	29.40210817,26	29.463602134,37,38,39,45	41.10048166,184	41.10286118,120,122,124,180,182
29.3695519,20,24,30	29.40210915,16,17,26	29.463652036,37,45	41.10051168,170	41.10287120,122
29.36955119,20,24,30	29.40211015,27	29.59266	41.10053170,172	41.10288120,130,140,142,144, 166,180,182,184,188,190
29.3695718,21,22,30	29.40211121,22,27	29.645317,9	41.10059186,188,190	41.10289122,124
29.3695823	29.40211213,14,27	29.64568,9,10	41.10060188,190	41.10290124
29.36958123	29.40211416,17,26	29.64599,10	41.10061110,180	41.10291112,130,132,134, 136,138,140,182
29.3695921,22,30	29.40211615,17,26	29.64608,10	41.10063114,116	41.10292130,132,154,156, 158,160,162,164
29.3696013,17,19,24,30	29.40211718,21,22,27	29.646317,8,10	41.10071120,122,124,170,172	41.10293132,134,136,138,140
29.36960113,17,19,24,30	29.40211821,22,27	29.64659,10	41.10079112,130,132,146,148, 150,152,154,156,158,160,162,178	41.10294140,142,166,168
29.3696222,30	29.40211914,23,24,26	29.64669,10	41.10086132,134,136,138,140	41.10295142,166,168
29.3696330	29.40212124,27	29.655117,8,10	41.10091140,142,166	41.10296142,144,146,150,168, 170,172,174,176,178,182, 184,186,188,190,192,194
29.36963130	29.40220115,16,18,23,26	29.655317,10	41.10093142,144,146,152	41.10297142,144,150,170,178,194
29.3696520,22,30	29.40220217,26	29.655919,10	41.10104166,184	41.10298144,168,170,172,174
29.3696617,19,24,30	29.40220316,19,24,26	29.655929,10	41.10109168,170	41.10299110,112,140,166,168, 170,186,188,192
29.36966117,19,24,30	29.40220417,23,26	29.656117,8,10	41.10120186,188,190	41.10300166,168,170
29.3696821	29.40220513,17,26	29.65648,9,10	41.10128120,122,124	41.10301166
29.3697023,30	29.40220623,24,26	29.65668,10	41.10131122,124	41.10302166,168,170,172,174,176
29.3697123,30	29.40220713,26	29.74045,6	41.10133130,132,154,156, 158,160,162,164	41.10303166,168,170,172, 186,188,190,192
29.3697224,30	29.40220915,16,17,26	29.74625,6,9	41.10142144	41.10304168,170,172,174
29.36972124,30	29.40221015,27	29.753214,16,18,19,20,23,24,25	41.10143152,154	41.10305168,170,186,188,190,194
29.3697314,30	29.40221121,22,27	29.754015,25	41.10147154,156,158,160,162	41.10306168,170,172
29.36973130	29.40221213,14,27	29.754512,25	41.10151168,170	41.10307170,172
29.40100111,26	29.40221315,16,26	29.755013,25	41.10152170,172	41.10308184,186,188,190,192
29.4010027,9,11,12,26	29.40221416,17,26	29.76015	41.10155184	41.10309184,186
29.40100311,12,26	29.40221516,26	29.77005,6	41.10162186,188,190	41.10310110,112,116,132,134, 136,138,140,154,156,158, 160,162,164,180,182,184
29.40100411,26	29.40221617,26	29.77015	41.10163188,190	41.10317118,120,122,140,166
29.40100511,26	29.40221718,21,22,27	29.78035,6	41.10165188,190	41.10318112,118,120,122,124,126, 128,142,146,166,170,172,174
29.40100611,12,26	29.40221821,22,27	29.78095,6	41.10166188,190	41.10325120,122,124,142,144, 146,170,186,188,190
29.4010077,9,26	29.40222020,23,26	29.78095,6	41.10174120,122,124	41.10330112,122,124,144, 168,170,172,180
29.40100811,26	29.40222124,27	29.8230034,35,37,38,39, 41,42,43,44,47	41.10178130,132,152,154, 156,158,160,162	41.10331122,124,134,136,138, 142,144,170,186,188,190
29.40110114,16,18,19,24,26	29.40230115,16,18,23,26	29.8231032,33,34,35,36, 39,40,41,42,44,47	41.10196170,172	41.10333130,132,154,156, 158,160,162,164
29.40110214,15,16,17,18, 19,20,23,24,26	29.40230417,23,26	29.8232032,33,34,35,36,37, 38,39,40,41,42,44,47	41.10197184	41.10334132,134,136,138, 156,158,180,182
29.40110312,14,15,16, 17,19,20,23,26	29.40230517,26	29.8233032,33,34,35,36,37, 38,39,40,41,42,43,44,47	41.10202186,188,190	41.10338140,142,146,148, 166,184,192,194
29.40110414,15,17,18, 19,20,23,24,26	29.40231015,27	29.8234040,41,42,43,44,47	41.10203190	41.10343152
29.40110512,13,14,15,16, 17,18,23,24,26	29.40231213,14,27	29.8235035,37,38,39,47	41.10212130,156,158	41.10344152
29.40110617,18,19,20,26	29.40231315,16,26	29.8236034,37,38,39,41,44,47	41.10214132,152	41.10345152
29.40110712,14,17,19,23,24,26	29.40231416,17,26	29.8240035,36,39,40,42,47	41.10217140,142,166	41.10346152,154,156, 158,160,162,164
29.40110814,15,16,18,26	29.40231617,26	29.8322047	41.10222144,170	41.10349114,116
29.40110921,26	29.40231718,21,22,27	29.8326032,39,42,47	41.10226152	41.10367122,124
29.40111014,16,21,22,26	29.40231821,22,27	29.8328034,35,39,41,42,47	41.10227154	41.10369122
29.40111114,15,20,21,26	29.40231914,23,24,26	29.8330032,34,39,41,47	41.10228156,158,160,162	41.10370122,124
29.40111220,26	29.40232124,27	29.8332039,42,47	41.10229156	41.10371124
29.40111321,22,26	29.41180024,26	29.8336032,39,42,47	41.10231166	41.10374130,132,154, 156,158,160,162
29.40111413,26	29.422650632,35,46	29.8338034,35,39,41,42,47	41.10241170	41.10375132,156,160,162
29.40111512,16,26	29.422800632,46	29.8340032,34,39,41,47	41.10245186	41.10378132,152
29.40111615,16,20,26	29.422801144,46	29.8332039,42,47	41.10246186	41.10379132,134,136,138
29.40111716,26	29.422900134,46	29.8635048	41.10250188	41.10380132,134,136,138
29.40111816,20,21,22,26	29.423050137,46	29.8635148	41.10252120,122	41.10381140,142,166
29.40112112,13,14,18,26	29.423050237,46	29.8640048	41.10253122,124	41.10390142,144
29.40120214,15,16,17,18, 19,20,23,24,26	29.423500133,46	29.8643148	41.10254130,132,154, 156,158,160,162	41.10391144,170
29.40120312,14,15,16, 17,19,20,23,26	29.423650533,46	29.864507,8,10	41.10255130,156,158	41.10392144
29.40120414,15,17,18, 19,20,23,24,26	29.432900642,46	29.864519,10	41.10256140,142	41.10393144,168,170,172
29.40120512,13,14,15,16, 17,18,23,24,26	29.434100633,46	29.864537,10	41.10257140,142	41.10394152,154,156, 158,160,162,164
29.40120617,18,19,20,26	29.442650336,46	29.864627,8,10	41.10258140,142	41.10400166
29.40120712,14,17,19,23,24,26	29.443000336,46	29.864637,8,10	41.10259142,144	41.10401184
29.40120814,16,18,26	29.443050236,46	29.864647,10	41.10260144,170	41.10402186
29.40120921,26	29.443050442,46	29.865517,8,10	41.10261144	41.10421186,188,190
29.40121014,16,21,22,26	29.443052343,46	29.865537,10	41.10262144	41.10422186
29.40121114,15,20,21,26	29.443102043,46	29.865599,10	41.10263152	41.10423186
29.40121220,26	29.443102232,46	29.865627,8,10	41.10264152	41.10425122,124
29.40121321,22,26	29.443102535,46	29.87135132,39,47	41.10266166	41.10426188,190
29.40121426	29.443152632,37,43,46	29.8740315,25	41.10267168	41.10431190
29.40121512,16,26	29.443201337,46	29.8740614,16,18,19,20,23,24,25	41.10268170	41.10432114,116
29.40121615,16,20,26	29.443251643,46	29.8741612,13,14,16,17,18,23,24,25	41.10269172	41.10433120,122,124
29.40121716,26	29.443301637,46	29.8742815,20,21,25	41.10270184	41.10434122,124
29.40121816,20,21,22,26	29.443350232,46	29.8743014,20,21,25	41.10271186	41.10435132,134,136
29.4012207,8,9,26	29.443700238,46	29.8743521,22,25	41.10272188	41.10436140,142,166
29.40130214,15,16,17,18, 19,20,23,24,26	29.443750236,37,46	29.874427,8,10	41.10273172	41.10437142,144
29.40130312,14,15,16,17, 19,20,23,26	29.443800334,46	29.8744814,18,20,25	41.10274172	41.10438144,170
29.40130414,15,18,19,20,23,24,26	29.443850133,46	29.8745220,25	41.10275184,186	41.10439144
29.40130512,13,14,15,16, 17,18,23,24,26	29.444100144,46	29.8745915,25	41.10276186	41.10448154,156,158,160
29.40130617,18,19,20,26	29.453100932,33,34,35, 36,39,40,41,45	29.8746111,12,25	41.10277188,190	41.10490166
29.40130712,14,17,19,23,24,26	29.453201932,33,34,35,37,42,45	29.8746912,14,17,19,23,24,25	41.10278188	41.10491166
29.40130921,26	29.453303432,33,34,42,43,45	29.8747912,14,17,19,23,24,25	41.10279190	41.10501168,170
29.40131114,15,20,21,26	29.462700132,35,36,37,45	29.8753611,12,25	41.10280		

41.10502168,170,172	41.10635110,112,114,122,124, 126,128,130,146,148,150, 152,170,174,176,178,190,196	41.62033199	48.205251,64	48.514949
41.10503170,172			41.62036199	48.205552,64	48.515251
41.10504170,172			41.62037199	48.205852,64	48.515551,51,52
41.10507184	41.10636108,112,114,120,122, 124,126,128,130,150,152, 164,170,172,174,176,178, 180,182,184,186,194,196	41.62044199	48.206157,64	48.515851,52
41.10514186,188,190			41.62057199	48.206457,64	48.516151
41.10515186,188,190			41.63030199	48.206757,64	48.516452
41.10516186,188	41.10637118,122,124,176,196	44.002786,87,88,89,92, 95,97,98,100,196	48.207057,64	48.516752
41.10517188,190	41.10638120,122,124,142,144,146, 168,170,172,174,176,178, 180,186,188,190,192,194,197	44.003884,87,92,93,94,97, 98,100,101,102,196	48.207357,64	48.517052
41.10518188,190			44.003992,101,196	48.300149,64	48.517351
41.10519188,190	41.10639118,120,122,124,130, 142,144,146,148,150,152, 168,170,174,176,178,180, 182,184,192,194,197	44.004084,85,86,87,88,89,90,91, 96,97,98,99,101,102,103,196	48.300449,64	48.517651
41.10520190			44.024187,88,89,90,91, 97,98,99,196	48.300749,64	48.517951
41.10521190	41.10640120,122,124,126,128, 130,168,170,174,178,180,197	44.024385,86,88,89,90,91, 94,95,97,99,100,103,196	48.301049,64	48.518252
41.10522114,116	41.10641128,142,144,146,148, 166,168,176,178,197	44.025392,97,101,196	48.301349,64	48.518552
41.10532120,122,124,128,166	41.10642120,122,124,142,144, 146,170,186,188,190,197	44.026684,85,86,87,92,96, 97,100,101,102,196	48.301649,64	48.518852
41.10537130,132,154, 156,158,160,162	41.10643112,122,124,144, 168,170,172,180,197	44.030086,87,88,89,90,92, 93,97,98,99,196	48.301949,64	48.519152
41.10539132,134,136,138,140	41.10644152,196	44.030192,93,94,98,102,196	48.302250,64	48.519352
41.10540132,134,136,138	41.10645144,152,168,170,172,197	44.030288,98,99,196	48.302551,64	48.519652
41.10541140,142,144,166,170	41.10646132,134,136,138, 156,158,180,182,197	44.030384,85,94,103,196	48.302851,64	48.519952
41.10542140,142,144,146,166,170	41.10647130,132,154,156, 158,160,162,164,197	44.030492,93,94,96,97, 100,101,102,103,196	48.303151,52,65	48.520252
41.10546152	41.10648122,124,134,136,138, 142,144,170,186,188,190,197	44.030892,93,94,97,98,99, 101,102,103,196	48.303454,65	48.520552
41.10547152	41.10649184,186,188,190,192,196	44.031485,86,87,88,89,90, 91,92,93,94,95,97,98, 99,100,101,102,196	48.303754,65	48.520853
41.10548130,132,152,154, 156,158,160,162	41.10650154,156,158, 160,162,164,197	44.034587,196	48.304057,65	48.521152,53
41.10550154,156,158,160	41.10651110,112,116,132,134, 136,138,140,154,156,158, 160,162,164,180,182,184,197	44.034789,196	48.304354,55,65	48.522953,57
41.10551166,168,170,172	41.10652108,110,146,148,150,164, 166,174,186,190,192,194,196	44.035084,85,86,92,93, 94,96,100,196	48.304654,55,55,65	48.523253,57
41.10553166	41.10653148,150,164,194,196	44.035188,98,100,101,102,103,196	48.304955,56,65	48.523553,57
41.10558170,172	41.10654194,197	44.080485,196	48.305254,65	48.523853,57
41.10560184,186,188,190	41.250515199	44.081196	48.305556,65	48.524157
41.10567120,122,124	41.32005199	44.082184,196	48.305853,57,65	48.524750,55
41.10569154,156,158,160	41.32006199	44.102093,94,196	48.306153,57,65	48.525355
41.10573168,170,172	41.32028199	44.103085,86,93,102,103,196	48.306453,57,65	48.525656
41.10576186,188,190	41.50339199	44.104097,98,99,100,196	48.306753,57,65	48.525951,54,55
41.10588122,124,126	41.50419199	44.105090,92,93,97,100, 101,102,103,196	48.307053,57,65	48.526250
41.10589120,122	41.50447199	44.106087,92,93,94,97,99, 100,101,102,103,197	48.307353,57,65	48.526550,51,54
41.10590122,124	41.50531199	44.107087,92,97,98,99, 100,101,102,197	48.307653,57,65	48.526854,55
41.10591124	41.50561199	44.108085,87,89,90,91,97,98,197	48.307953,57,65	48.527155
41.10593150,164,170,174,176, 178,180,182,188,192,194	41.50722199	44.109090,92,97,197	48.308249,65	48.527450,54
41.10594142,144,146,148,150,152	41.50787199	44.110087,89,92,93,97,101,197	48.308549,65	48.527750
41.10595120,122,124,126,128,130	41.52042199	44.111088,97,98,197	48.308849,65	48.528054
41.10596144,146,148	41.52074199	44.112092,95,97,98,197	48.310049,66	48.528354
41.10597142,146,148,150	41.52221199	44.1130100,101,196	48.310649,66	48.528655,56
41.10598192,194	41.5250515199	44.114084,86,88,89,90,91, 92,93,94,95,96,97,98, 99,100,101,102,103,199	48.310949,66	48.528955
41.10599122,124,126,128,130,178	41.53012199	44.114084,86,88,89,90,91, 92,93,94,95,96,97,98, 99,100,101,102,103,199	48.529249	48.529249
41.10600186,188,190	41.53023199	44.115094,95,98,99, 100,102,103,197	48.312450,66	48.529550,54,55,56
41.10601120,122,122,126	41.532005199	44.116093,94,99,100,103,197	48.313050,66	48.529855,56
41.10602148,150,152,178	41.532006199	44.117088,92,101,197	48.313350,66	48.529956
41.10603126,130	41.53282199	48.101349	48.313650,66	48.530156
41.10604146,148,150	41.560000198	48.102249	48.313950,66	48.530455
41.10605108,112,114,124,128, 130,144,146,148,150,152,164	41.560026199	48.103149	48.314250,66	48.530755,56
41.10606108	41.560027199	48.103453,57	48.314550,66	48.531055,56
41.10607194	41.560029199	48.103757	48.314850,66	48.531656
41.10608178,180	41.560030199	48.104352	48.315149,50,66	48.531950
41.10609178	41.560037199	48.104653,57	48.316050,66	48.533450
41.10610192,194	41.560040199	48.104949	48.316351,66	48.533750
41.10611182,184	41.560047199	48.105249	48.316651,66	48.534049
41.10612112,114	41.560050199	48.105549	48.316951,66	48.911051,52
41.10613142	41.562003198	48.112154	48.317251,66	48.911351,52
41.10614184	41.562006198	48.112454	48.317851,66	48.911651
41.10615120,122,122,124	41.562010198	48.112754	48.318151,66	48.911952
41.10616108	41.562016198	48.113054	48.318451,67	48.912252
41.10617110,112,116	41.562017198	48.113354	48.318751,67	48.912552
41.10618166,184,196	41.562018198	48.115154	48.319051,67	48.912851
41.10619116,118,140, 166,168,184,196	41.562020199	48.117554	48.319351,67	48.913151
41.10620140,166,168, 170,184,186,196	41.562023199	48.119956	48.319951,67	48.913451
41.10621118,140,142,166, 168,184,186,196	41.562027199	48.120857	48.320251,67	48.913752
41.10622118,120,122, 142,144,186,196	41.562030199	48.121157	48.320551,52,67	48.914052
41.10623140,184,186,196	41.562033199	48.121457	48.321453,67	48.914352
41.10624118,120,122,124,126, 140,142,144,166,170,172,190,196	41.562036199	48.121757	48.321754,67	48.914652
41.10625116,118,120,122,124, 126,128,130,140,142,146, 166,168,170,172,174,176, 184,186,188,190,192,194,196	41.562043199	48.122057	48.322054,67	48.914952
41.10626120,122,130,142,144, 146,148,150,184,186, 188,190,192,194,196	41.562047199	48.201049,63	48.322654,67	48.915252
41.10627140,142,146,148, 166,168,170,172,184, 188,192,194,196	41.562057199	48.201350,63	48.323254,67	48.915552
41.10628112,118,120,122,124, 126,128,142,146,166, 170,172,174,196	41.562060199	48.201656,63	48.323554,67	48.915852,53
41.10629112,114,118,120,122,140, 142,144,146,150,168,170, 172,186,188,190,192,194,196	41.563007198	48.201957,63	48.323854,67	48.916153,57
41.10630124,126,128,130, 164,168,174,176,196	41.563017199	48.202257,63	48.324156,67	48.916453,57
41.10631152,154,156,158, 160,162,164,196	41.563020199	48.202557,63	48.324456,67	48.917053,57
41.10632152,196	41.563027199	48.202857,63	48.324757,67	48.917357
41.10633122,124,142,192,196	41.563030199	48.203157,63	48.325057,67	48.917649,55,56
41.10634122,126,128,130,142, 144,146,148,150,168,170, 172,174,176,178,186,188, 190,192,194,196	41.563033199	48.203457,63	48.325357,67	48.917950,55
		41.563037199	48.203757,63	48.325657,68	48.918250,51,54,55
		41.563040199	48.204057,63	48.326257,68	48.918550
		41.60026199	48.204357,63	48.326554,55,68	48.918854,55
		41.60030199	48.204651,64	48.326856,68	48.919155
		41.60037199	48.204951,64	48.327154,55,68	48.919449
		41.62017</							



WD-40 é 5 prodotti in 1

*Con i suoi 2.000 e più impieghi WD-40 é il lubrificante multiuso piú usato al mondo.
Indispensabile in tutte le officine, garage e abitazioni.*

Grazie alla sua formula esclusiva WD-40 é 5 prodotti in 1:

- **Idrorepellente:** L'elevata aderenza di WD-40 al metallo permette la formazione di una barriera perfetta contro l'umidità. WD-40 si infila sotto l'umidità e ricopre completamente qualsiasi superficie, anche quelle che presentano micro irregolarità. É così che WD-40 elimina rapidamente i corto circuiti dall'umidità
- **Anticorrosivo:** La pellicola formata da WD-40 garantisce una protezione contro acqua, umidità, gelo e relativi effetti corrosivi. WD-40 protegge dall'ossidazione e da qualunque forma di corrosione anche nelle condizioni piú critiche. Questa sua azione é duratura e preventiva.
- **Lubrificante:** Uno dei principali componenti di WD-40 é un lubrificante attivo e permanente. WD-40 non contiene silicone, lanolina o additivi che possano attirare polvere o sporcizia. I meccanismi vengono perfettamente lubrificati in modo pulito.
- **Detergente:** WD-40 elimina facilmente macchie di grasso, catrame, colla, ecc. da qualunque superficie non porosa. WD-40 penetra sotto la sporcizia eliminandola, senza lasciare residui di agenti corrosivi. WD-40 può essere utilizzato su tutte le superfici metalliche e in plastica.
- **Sbloccante:** WD-40 sblocca le parti gruppate e i meccanismi arrugginiti, bloccati o congelati. L'aderenza al metallo di WD-40 gli permette di penetrare molto rapidamente per capillarità nelle minime porosità del metallo, attraversando così ruggine e strato corrosivo. Le proprietà lubrificanti di WD-40 garantiscono poi il funzionamento costante delle parti sbloccate.



Cod. 050010

**WD-40 250 ml. con doppio spray
(expo banco da 30 pz.)**



Cod. 050020

**WD-40 500 ml. con doppio spray
(expo banco da 24 pz.)**



Cod. 050021

**WD-40 500 ml. con doppio spray
(cartone da 6 pz.)**

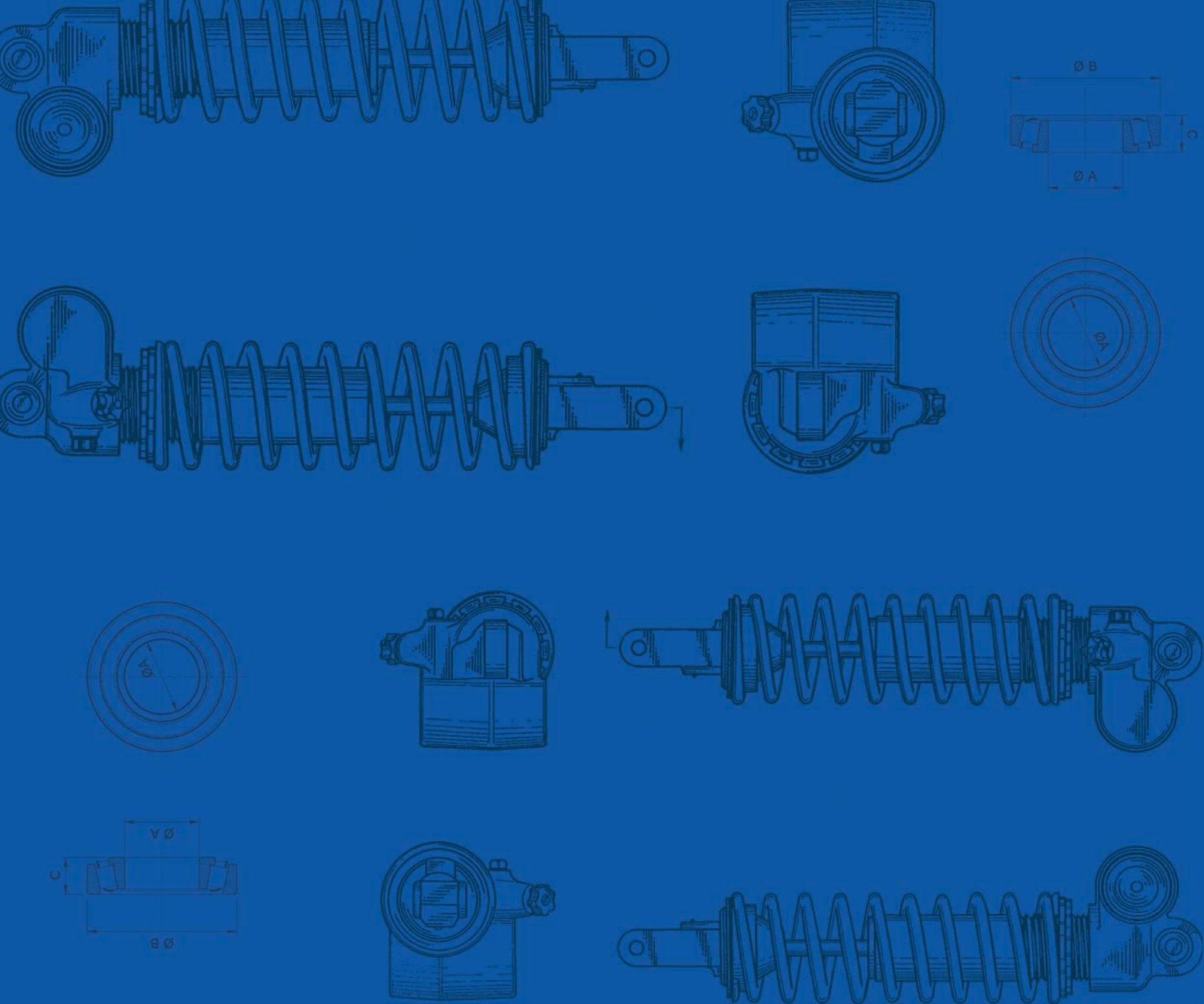

Società Generale Ricambi (Europa) p.A.

SEDE DI BOLOGNA:

40012 CALDERARA DI RENO · Via Armaroli 10/12
Tel: +39.051722557 · Fax: +39.051720376

MAGAZZINO DI MILANO:

20129 MILANO · Via Pasquale Sottocorno 52
Tel: +39.027382368 - 0276110273 · Fax: +39.0270106598

<http://www.sgr-it.com> · e-mail: infosgr@sgr-it.com