

CATALOGO
BATTERIE
E CARICABATTERIE
2017



YUASA

Batterie Standard/Yumicron YUASA 12V per Motocicli e Scooter.....	4
Batterie YUASA 12V, senza manutenzione, a limitata autoscarica c/elettrolita a corredo per Scooter, Motocicli, ATV, Jet Sky, Snowmobile.....	6
Batterie YUASA 12V sigillate, tipo MF, precaricate a bassissima autoscarica per Scooter e Motocicli.....	7
Batterie YUASA 12V, tipo MF High Performance, senza manutenzione (c/alto spunto) per Motocicli, ATV, Jet Sky, Snowmobile.....	8
Tabella di corrispondenza batterie YUASA e batterie Yuasa High Performance.....	8
Batterie standard YUASA 6V per Motocicli e Scooter.....	9
Batterie standard 6V per Moto d'Epoca.....	9

BATTERIE ENERGYSAFE

Batterie Standard ENERGYSAFE 12V per Motocicli e Scooter.....	10
Batterie 12V ENERGYSAFE , senza manutenzione, a limitata autoscarica c/elettrolita a corredo per Scooter, Motocicli, ATV, Jet Sky, Snowmobile.....	11
Batterie 12V ENERGYSAFE sigillate, tipo MF, precaricate a bassissima autoscarica per Scooter e Motocicli.....	12
Batterie 12V ENERGYSAFE , tipo MF High Performance, senza manutenzione (c/alto spunto) per Motocicli, ATV, Jet Sky, Snowmobile.....	12

BATTERIE FURUKAWA

Batterie 12V FURUKAWA , senza manutenzione, a limitata autoscarica c/elettrolita a corredo per Scooter, Motocicli, ATV, Jet Sky, Snowmobile.....	12
Batterie 12V FURUKAWA sigillate, tipo MF, precaricate a bassissima autoscarica per Scooter e Motocicli.....	12

ELETTROLITA PER BATTERIE.....13

PRODOTTI PER SICUREZZA.....13

BATTERIE AL LITIO

Tabella di Conversione Batteria al Litio / Batteria Piombo Acido.....	14
---	----

NORME BATTERIE.....16

TABELLA APPLICAZIONI.....18

ADLY.....18	E-TON.....54	MALANCA.....117
AEON.....19	ERING.....54	MBK.....117
AERMACCHI.....19	FANTIC MOTOR.....54	MOTO GUZZI.....119
APRILIA.....20	GARELLI.....55	MOTO MORINI.....123
ARCTIC CAT.....27	GAS GAS.....56	MOTRON.....124
ASPES.....28	GILERA.....56	MV AGUSTA.....125
BAJAJ.....28	HARLEY DAVIDSON.....60	PEUGEOT.....126
BAOTIAN.....29	HM.....74	PGO.....129
BENELLI.....29	HONDA.....75	PIAGGIO.....129
BENZHOUE.....31	HUSABERG.....91	POLARIS.....140
BETAMOTOR.....31	HUSQVARNA.....92	PULSE.....143
BIMOTA.....32	HYOSUNG.....94	QUADRO.....143
BMW.....32	INDIAN.....95	RIEJU.....143
BOMBARDIER.....38	INNOCENTI.....95	RIZZATO.....143
BOMB.-CAN AM.....38	ITALJET.....95	SEP.....143
BUELL.....40	KAWASAKI.....96	SUZUKI.....143
BUFFALO.....41	KEEWAY.....107	SYM.....151
CAGIVA.....41	KL-SHELUNG.....107	TGB.....153
CPI.....43	KTM.....107	TM.....154
DAELIM.....43	KYMCO.....110	TRIUMPH.....154
DAZON.....44	LAVERDA.....114	VALPADANA.....157
DERBI.....44	LEM.....115	YAMAHA.....158
DUCATI.....48	MALAGUTI.....115	

TECMATE PRO.....171

TECMATE CONSUMER.....184

ACCESSORI TECMATE.....195

Batterie Standard/Yumicron

YUASA 12V per Motocicli e Scooter

Modello		Caratteristiche		Dimensioni (±2mm)				Tabella Comparativa		
Cod.	Rif. YUASA	Ah (10HR)	Poli/Posiz.	Lung.	Larg.	Alt.	Conf. da n.	GS	FB	Fiamm
0650334	YB3L-A*	3		98	56	110	10	GM3-3A CB3L-A	FB3L-A	6D2P
0650335	YB3L-B*	3		98	56	110	10	GM3-3B CB3L-B	FB3L-B	6D2PS
06504340	YB4L-B*	4		120	70	92	10	GM4-3B CB4L-B	FB4L-B	6I2P FB4L-B
065043410	YB4L-B■*	4		120	70	92	10	con flacone di acido a corredo		
0650533	12N5-3B	5		120	60	130	10	12N5-3B	12N5-3B	6L2P 12N5-3B
0650534	YB5L-B*	5		120	60	130	10	GM5Z-3B CB5L-B	FB5L-B	6L2P
0650633	12N5.5-4B	6		138	61	131	10	12N5.5-4B	12N5.5-4B	6K3P
0650634	12N5.5-3B	6		138	61	131	10	12N5.5-3B	12N5.5-3B	6K3PS 12N5.5-3B
0650636	12N5.5-4A	6		138	61	131	10	12N5.5-4A	12N5.5-4A	—
0650733	12N7-4A	7		135	75	133	5	12N7-4A	12N7-4A	6MP3
0650734	12N7-3B	7		135	75	133	5	12N7-3B	12N7-3B	—
0650735	12N7-4B	7		135	75	133	5	12N7-4B	12N7-4B	6M3P
0650736	YB7-A*	8		133	75	133	5	GM7Z-4A CB7-A	FB7-A	6B3P FB7-A
0650737	YB7L-B*	8		135	75	133	5	GM7-3B-1 CB7L-B	FB7L-B	6B3PS FB7L-B
0650738	YB7C-A*	8		130	90	114	5	GM7CZ-3D CB7C-A	—	—
0650739	YB7L-B2*	8		135	75	133	5	—	—	—
0650933	12N9-3B	9		135	75	139	5	12N9-3B	12N9-3B	6H2PS
06509350	YB9-B*	9		135	75	139	5	GM9Z-4B CB9-B	FB9-B	6C3P FB9-B
0650936	YB9L-A2*	9		135	75	139	5	CB9L-A2	FB9L-A2	6G3P FB92-A2
0651033	12N10-3B	10		136	91	146	5	12N10-3B	12N10-3B	6D3PS 12N10-3B
0651134	YB10L-A2*	11		135	90	145	5	GM10Z-3A CB10L-A2	FB10L-A2	6D3P
0651135	YB10L-B*	11		135	90	145	5	GM10Z-3B-2 CB10L-B	FB10L-B	6D3PS/PSP FB10L-B
0651137	YB10L-B2*	11		135	90	145	5	GM10Z-3B-2 CB10L-B2	FB10L-B2	—
0651231	YB10L-BP*	12		135	90	145	5	—	—	—
0651233	12N12A-4A-1	12		134	80	160	5	12N12A-4A-1	12N12A-4A-1	6S3P
0651234	YB12A-A*	12		134	80	160	5	GM12AZ-4A-1 CB12A-A	FB12A-A	6Y3P FB12A-A
06512360	YB12AL-A*	12		134	80	160	5	GM12AZ-3A-1 CB12AL-A	FB12AL-A	6Y3PS FB12AL-A
0651238	YB12B-B2*	12		160	90	130	5	GM12B-4B CB12B-B2	FB12B-B2	6L3P
0651239	YB12A-B*	12		134	80	160	5	GM12AZ-4B-2	—	FB12A-B
06512400	YB12AL-A2*	12		134	80	160	5	GM12AZ-3A-2	FB12AL-A2	—

▲ - Factory Sealed /
Attivata dalla Fabbrica

■ - con Acido a corredo

◇ - Non di produzione YUASA
a completamento gamma

* - Serie Yumicron
ad elevato spunto

+ - Batteria con sensore
per check control panel

Modello		Caratteristiche		Dimensioni (±2mm)			Tabella Comparativa			
Cod.	Rif. YUASA	Ah (10HR)	Poli/Posiz.	Lung.	Larg.	Alt.	Conf. da n.	GS	FB	Fiamm
0651431	YB14A-A2*	14	+	134	89	176	1	CB14A-A2	—	—
0651432	YB14L-A*	14	-	134	89	166	5	GM14AZ-4A	—	6Y5PS
0651433	12N14-3A	14	-	136	91	168	5	12N14-3A	12N14-3A	6H3P
0651434	YB14L-A2*	14	-	134	89	166	5	GM14Z-3A CB14L-A2	FB14L-A2	6Y4PS FB14L-A2
0651435	YB14L-A1*	14	-	134	89	166	5	GM14Z-3A-1 CB14L-A1	—	—
0651436	SYB14L-A2* +	14	-	134	89	166	5	GM14Z-3A(S) SCB14L-A2	FB14L-A2(S)	—
0651437	YB14-A2*	14	+	134	89	166	5	GM14Z-4A CB14-A2	FB14-A2	6Y4P FB14-A2
0651438	YB14-B2*	14	+	134	89	166	5	CB14-B2	—	—
0651439	YB14L-B2*	14	-	134	89	166	5	GM14Z-3B CB14L-B2	FB14L-B2	6Y4PS FB14L-B2
06516340	YB16AL-A2*	16	-	207	72	164	5	GM16A-3A CB16AL-A2	FB16AL-A2	6G4P FB16AL-A2
0651636	YB16L-B*	19	-	175	100	155	4	GM16Z-3B CB16L-B	FB16L-B	—
0651637	YB16B-A*	16	+	160	90	161	5	GM16B-4A	—	6M4P FB16B-A
0651638	YB16-B*	19	+	175	100	155	4	GM16Z-4B CB16-B	FB16-B	6B4P FB16-B
0651639	HYB16A-AB*	16	+	151	91	180	5	GM16-T HCB16A-A	HFB16A-A	—
0651640	YB16CL-B*	19	-	175	100	175	4	CB16CL-B	FB16CL-B	FB16CL-B
0651833	12N18-3	18	-	205	90	162	5	—	12N18-3	6D5P
0651834	YB18L-A*	18	-	180	90	162	4	GM18A-3A CB18L-A	FB18L-A	6M5PS
0651835	YB18-A*	18	+	180	90	162	4	GM18A-4A CB18-A	FB18-A	6M5P
0651913	51913	19	-	186	82	171	4	—	—	—
0652015	52015	20	-	186	82	171	4	—	—	—
0652034	Y50-N18L-A*	20	-	205	90	162	4	GM18Z-3A	FB50-N18L-A	605P F50N18L-A
0652035	SY50-N18L-AT* +	20	-	205	90	162	4	GM18Z-3A(S)	FB50-N18L-A(S)	—
0652433	12N24-3A	24	-	184	124	175	4	12N24-3A	12N24-3A	—
0652515	52515	25	-	185	130	171	4	—	—	61F130 52515
0652711	6MC4 ◇	27	-	183	126	165	1	—	—	61F130P
0652434	Y60-N24-A*	28	+	184	124	175	1	Y60N24-A	—	61F130
0653030	53030	30	-	186	130	171	1	—	—	61F200 53030
0653036	YB30L-B*	30	-	168	132	176	1	CB30L-B	—	—
0653040	YB30CL-B*	30	-	168	132	192,2	1	—	—	—
0653211	6MK5 ◇	32	-	230	126	165	1	—	—	61F5 53211
0654310	54310 ◇	43	-	175	175	190	1	—	—	—
0654511	54511 ◇	45	-	215	135	200	1	—	—	—
0655275	55275 ◇	55	-	205	175	190	1	—	—	—

▲ - Factory Sealed /
Attivata dalla Fabbrica

■ - con Acido a corredo

◇ - Non di produzione YUASA
a completamento gamma

* - Serie Yumicron
ad elevato spunto

+ - Batteria con sensore per
check control panel

Batterie YUASA 12V, senza manutenzione, a limitata autoscarica c/elettrolita a corredo per Scooter, Motocicli, ATV, Jet Sky, Snowmobile



Modello		Caratteristiche		Dimensioni (±2mm)				Tabella Comparativa		
Cod.	Rif. YUASA	Ah (10HR)	Poli/Posiz.	Lung.	Larg.	Alt.	Conf. da n.	GS	FB	Fiamm
065029	YTR4A-BS■	2,3	+	114	49	86	6	YTR4A-BS	FTR4A-BS	FTR4A-12B FTR4A-BS
065030	YT4B-BS■	2,3	+	114	39	86	6	GT4B-5	FT4B-5	—
0650390	YTX4L-BS■	3	- +	114	71	86	6	GTX4L-BS	FTH4L-BS	6E4 FTX4L-BS
065049	YTX5L-BS■	4	- +	114	71	106	6	GTX5L-BS	FTX5L-BS	6E5 FTX5L-BS
0650690	YTX7L-BS■	6	- +	114	71	131	4	GTX7L-BS	FTX7L-BS	6E7 FTX7L-BS
0650700	YTX7A-BS■	6	+ -	152	88	94	4	GTX7A-BS	FTX7A-BS	FTX7A-BS
0650710	YT7B-BS■	6,5	+ -	150	65	93	4	GT7B-4	—	FT7-12B FT7-BS
065081	YT9B-BS▲	8	+ -	150	70	105	8	GT9B-4	FT9-B4	FT9-BS
0650811	YT9B-BS■	8	+ -	150	70	105	6	—	—	—
0650990	YTX9-BS■	8	+ -	152	88	106	6	GTX9-BS	FTX9-BS	6E9 FTX9-BS
0651090	YTX12-BS■	10	+ -	152	88	131	4	GTX12-BS	FTX12-BS	6E12 F1212LB
0651100	YT12B-BS■	10	+ -	152	70	131	4	GT12B-4	—	F1212B FT12B-BS
0651110	YT12A-BS■	10	+ -	150	87	105	6	GT12A-BS	FT12A-BS	FT12A-BS
065129	YTX14-BS■	12	+ -	150	87	145	4	GTX14-BS	FTX14-BS	6E14 FTX14-BS
065130	YT14B-BS▲	12	+ -	152	70	145	6	GT14B-4	—	—
065128	YTX14L-BS■	12	- +	150	87	145	1	—	—	—
065139	YTX15L-BS■	13	- +	175	87	130	1	—	—	—
065168	YTX16-BS■	14	+ -	150	87	161	3	GTX16-BS	FTH16-BS	FTX16-BS
065169	YTX16-BS-1■	14	+ -	150	87	161	3	GTX16-BS-1	FTH16-BS-1	—
065188	YT19BL-BS■	18	- +	185	81	170	1	—	—	—
065209	YTX20L-BS■	18	- +	177	88	156	4	GTX20L-BS	FTX20L-BS	FTX20L-BS
065275	YIX30L▲	30	- +	166	126	175	1	YGIX30	—	—

▲ - Factory Sealed /
Attivata dalla Fabbrica

■ - con Acido a corredo

◇ - Non di produzione YUASA
a completamento gamma

* - Serie Yumicron
ad elevato spunto

+ - Batteria con sensore
per check control panel

Batterie YUASA 12V sigillate, tipo MF, precaricate a bassissima autoscarica per Scooter e Motocicli

								ALTERNATIVA A MODELLO YTZ-S		
Modello		Caratteristiche		Dimensioni (±2mm)				Modello		
Cod.	Rif. YUASA	Ah (10HR)	Poli/Posiz.	Lung.	Larg.	Alt.	Conf. da n.	Cod.	Rif. YUASA	Conf. da n.
065005	YTZ5S▲	3,5	— +	113	70	85	10	—		
065007	YTZ7S▲	6	— +	113	70	105	10	065907	TTZ7S▲	10
065010	YTZ10S▲	8,6	+ —	150	87	93	5	065910	TTZ10S-BS■	6
065012	YTZ12S▲	11	+ —	150	87	110	5	065912	TTZ12S-BS■	6
065014	YTZ14S▲	11,2	+ —	150	87	110	5	065914	TTZ14S-BS■	4
0650061	YTZ6V■	5	— +	113	70	105	5	—		
0650071	YTZ7V▲	6,4	— +	113	70	120	5	—		
0650081	YTZ8V▲	7	— +	113	70	130	10	—		

Vedere le specifiche applicazioni

Angolo di montaggio YTZ

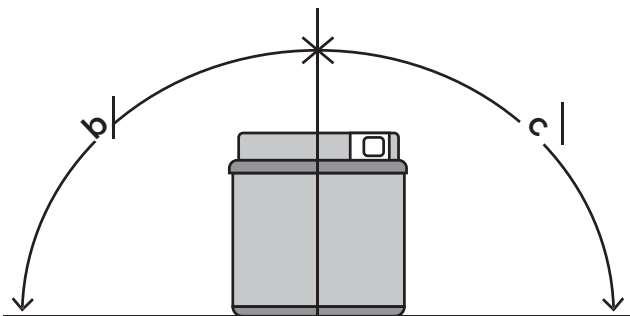
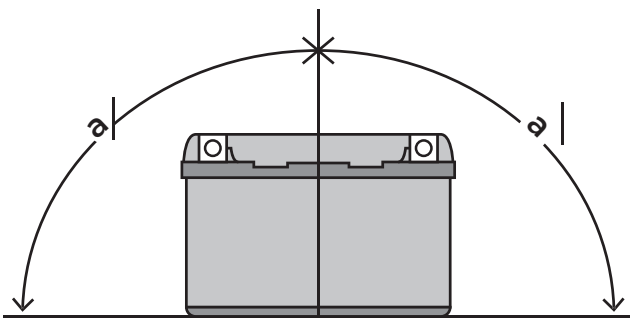

Angolazioni di Montaggio

a°	b°	c°
40	90	15

Angolo di montaggio YTTZ

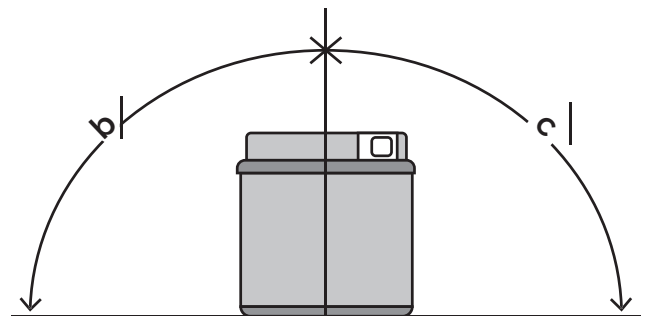
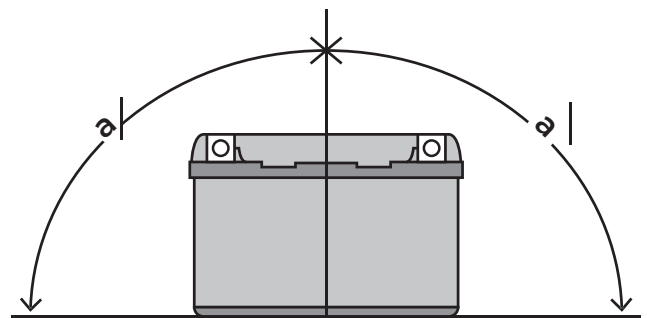

Angolazioni di Montaggio

a°	b°	c°
30	20	20

Gli angoli indicati si riferiscono alla batteria nel suo alloggiamento.

Le batterie della serie YTZ grazie alla loro particolare e unica conformazione interna possono essere installate con particolari varietà di angolature, come illustrato sopra.

Le batterie della serie TTZ, invece, non possono essere montate con le stesse angolature delle batterie YTZ.

Il montaggio delle batterie TTZ è limitato agli angoli sopra indicati.

▲ - Factory Sealed /
Attivata dalla Fabbrica

■ - con Acido a corredo

◇ - Non di produzione YUASA
a completamento gamma

* - Serie Yumicron
ad elevato spunto

+ - Batteria con sensore per
check control panel

Batterie YUASA 12V, tipo MF High Performance, senza manutenzione (c/alto spunto) per Motocicli, ATV, Jet Sky, Snowmobile

Cod.	Modello Rif. YUASA	Caratteristiche		Dimensioni (±2mm)				Tabella Comparativa		
		Ah (10HR)	Poli/Posiz.	Lung.	Larg.	Alt.	Conf. da n.	GS	FB	Fiamm
065122	YTX14AH-BS■	12	+	134	89	166	1	GTX14AH-BS	—	—
065124	YTX14H-BS■	12	+	150	87	145	1	—	—	—
065123	YTX14AHL-BS■	12	-	134	89	166	1	GTX14AHL-BS	—	—
065184	YTX20H-BS■	18	+	175	87	155	1	GT16-BS	—	—
065187	YTX20CH-BS■	18	+	150	87	161	1	—	FTZ16BS	FTX20CH-BS
065185	YTX20HL-BS■	18	-	175	87	155	1	GT16L-BS	—	—
065186	YTX20HL-BS-PW■●	18	-	175	87	175	1	—	—	—
065215	YTX24HL-BS■	21	-	205	87	162	1	GTX18L-BS	—	—
0650201	GYZ20H▲	20	+	175	87	155	1	—	—	—
0650202	GYZ20HL▲	20	-	175	87	155	1	—	—	—

● - Sottofondo in plastica 20mm.

Tabella di corrispondenza batterie Yuasa e batterie Yuasa High Performance

Cod. SGR	Rif. YUASA	Spunto avv.to C.C.A.	Cod. SGR	Rif. YUASA	Spunto avv.to C.C.A.	Cod. SGR	Batteria High Performance	Spunto avv.to C.C.A.
			065129	YTX14-BS■	200A	065124	YTX14H-BS■	240A
0651433	12N14-3A	128A	0651434	YB14L-A2*	190A	065123	YTX14AHL-BS■	210A
			0651437	YB14-A2*	190A	065122	YTX14AH-BS■	210A
			0651438	YB14-B2*	190A	065122	YTX14AH-BS■	210A
			0651439	YB14L-B2*	190A	065123	YTX14AHL-BS■	210A
			0651636	YB16L-B*	240A	065185	YTX20HL-BS■	310A
			0651638	YB16-B*	240A	065184	YTX20H-BS■	310A
			0651640	YB16CL-B*	240A	065186	YTX20HL-BS-PW■●	310A
			0651834	YB18L-A*	235A	065185	YTX20HL-BS■	310A
			0651835	YB18-A*	235A	065184	YTX20H-BS■	310A
0651913	51913	100A	065188	YT19BL-BS■	170A			
			0652034	Y50-N18L-A*	260A	065215	YTX24HL-BS■	350A
			0652035	SY50-N18L-AT*+	260A	065215	YTX24HL-BS	350A
			065209	YTX20L-BS■	270A	065185	YTX20HL-BS■	310A
			065184	YTX20H-BS■	310A	0650201	GYZ20H▲	310A
			065185	YTX20HL-BS■	310A	0650202	GYZ20HL▲	310A

● - Sottofondo in plastica 20mm.

Il C.C.A. indicato in tabella è stato rilevato dalla Yuasa alla temperatura di -18° celsius, variando la temperatura varia anche il C.C.A.

Es.: YTX14AH-BS -18° celsius C.C.A. 210A / 0° celsius C.C.A. 225A

▲ - Factory Sealed /
Attivata dalla Fabbrica

■ - con Acido a corredo

◇ - Non di produzione YUASA
a completamente gamma

* - Serie Yumicron
ad elevato spunto

+ - Batteria con sensore
per check control panel

Batterie standard YUASA 6V per Motocicli e Scooter

Cod.	Modello Rif. YUASA	Caratteristiche		Dimensioni (±2mm)			Conf. da n.	Tabella Comparativa		
		Ah (10HR)	Poli/ Posiz.	Lung.	Larg.	Alt.		GS	FB	Fiamm
0600211	6N2-2A-1	2	[- +]	70	47	96	20	6N2-2A	6N2-2A	—
0600412	6N4B-2A	4	[+ -]	102	48	96	20	6N4B-2A	6N4B-2A	—
0600413	6N4-2A-4	4	[- +]	71	71	96	20	6N4-2A-4	6N4-2A-4	3S2P
0600633	6N6-3B	6	[- +]	99	57	111	20	6N6-3B	6N6-3B	3B3P
0600634	6N6-3B-1	6	[- +]	99	57	111	20	6N6-3B-1	6N6-3B-1	—
0600715	B39-6	7	[- +]	126	48	126	10	B39-6	—	3S3P
0600833	B49-6	8	[+ -]	91	83	161	5	B49-6	B49-6	3R2PP
0601112	6N11A-1B	11	[- +]	122	62	131	10	6N11A-1B	6N11A-1B	3S4P
0601113	6N11A-3A	11	[- +]	122	62	131	10	6N11A-3A	6N11A-3A	—
0601433	B38-6A	13	[- +]	119	83	161	5	B38-6A	B38-6A	3R3P

Valvola di Sicurezza Arresta Fiamma
riduce l'eccesso di pressione.

Costruzione a "Partizione Diretta"

offre un percorso più breve alla corrente e minore resistenza rispetto alle batterie costruite in modo tradizionale - avrai maggiore energia proprio quando ne avrai bisogno!

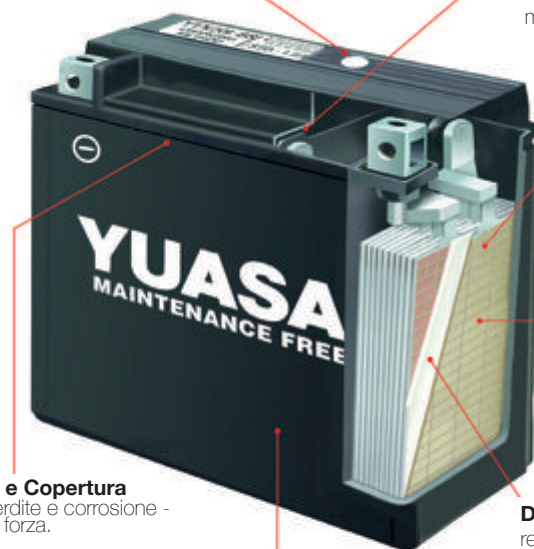

Materiale Speciale Attivo

creato ad hoc per resistere alle vibrazioni, prolungare la durata della batteria ed aumentarne l'affidabilità.

Griglia Speciale

resiste a forti vibrazioni, assicura la massima conduttività.

Sigillatura a Caldo tra Box e Copertura

protegge contro infiltrazioni, perdite e corrosione - la sigillatura fornisce maggiore forza.

Copertura e Contenitore in Polipropilene

assicurano la conservazione ottimale degli elettroliti, permettendo alla batteria di funzionare a temperature più basse.

Divisori Speciali

rendono la batteria a prova di perdita. Il design della valvola elimina la perdita d'acqua e la necessità di ricaricare con l'acido.

Batterie standard 6V per Moto d'Epoca

Cod.	Modello Rif. YUASA	Caratteristiche		Dimensioni (±2mm)			Conf. da n.
		Ah (10HR)	Poli/ Posiz.	Lung.	Larg.	Alt.	
0660510	3S2 ◊▲	5	[- +]	125	32	125	1
0660715	3S3 ◊▲	7	[- +]	125	48	125	1
0660810	3S4 ◊▲	8	[- +]	125	60	125	1
0660933	3R2 ◊▲	9	[+ -]	90	80	160	1
0661433	3R3 ◊▲	14	[- +]	120	90	160	1

▲ - Factory Sealed /
Attivata dalla Fabbrica

■ - con Acido a corredo

◊ - Non di produzione YUASA
a completamento gamma

* - Serie Yumicron
ad elevato spunto

+ - Batteria con sensore per
check control panel

Batterie Standard ENERGYSAFE 12V per Motocicli e Scooter

Cod.	Modello Rif. EnergySafe	Caratteristiche		Dimensioni (±2mm)				Tabella Comparativa		
		Ah (10HR)	Poli/ Posiz.	Lung.	Larg.	Alt.	Conf. da n.	GS	FB	Fiamm
0680334	ESB3L-A■	3		98	56	110	4	GM3-3A CB3L-A	FB3L-A	6D2P
0680335	ESB3L-B■	3		98	56	110	4	GM3-3B CB3L-B	FB3L-B	6D2PS
0680434	ESB4L-B■	4		120	70	92	4	GM4-3B CB4L-B	FB4L-B	6I2P FB4L-B
0680534	ESB5L-B■	5		120	60	130	4	GM5Z-3B CB5L-B	FB5L-B	6L2P
0680634	ES12N5.5-3B■	6		138	61	131	4	12N5.5-3B	12N5.5-3B	6K3PS 12N5.5-3B
0680733	ES12N7-4A■	7		135	75	133	4	12N7-4A	12N7-4A	6MP3
0680734	ES12N7-3B■	7		135	75	133	4	12N7-3B	12N7-3B	—
0680736	ESB7-A■	8		133	75	133	4	GM7Z-4A CB7-A	FB7-A	6B3P FB7-A
0680737	ESB7L-B■	8		135	75	133	4	GM7-3B-1 CB7L-B	FB7L-B	6B3PS FB7L-B
0680738	ESB7C-A■	8		130	90	114	4	GM7CZ-3D CB7C-A	—	—
0680739	ESB7L-B2■	8		135	75	133	4	—	—	—
0680933	ES12N9-3B■	9		135	75	139	4	12N9-3B	12N9-3B	6H2PS
0680935	ESB9-B■	9		135	75	139	4	GM9Z-4B CB9-B	FB9-B	6C3P FB9-B
0680936	ESB9L-A2■	9		135	75	139	4	CB9L-A2	FB9L-A2	6G3P FB92-A2
0681134	ESB10L-A2■	11		135	90	145	4	GM10Z-3A CB10L-A2	FB10L-A2	6D3P
0681135	ESB10L-B■	11		135	90	145	4	GM10Z-3B-2 CB10L-B	FB10L-B	6D3PS/PSP FB10L-B
0681137	ESB10L-B2■	11		135	90	145	4	GM10Z-3B-2 CB10L-B2	FB10L-B2	—
0681233	ES12N12A-4A-1■	12		134	80	160	4	12N12A-4A-1	12N12A-4A-1	6S3P
0681234	ESB12A-A■	12		134	80	160	4	GM12AZ-4A-1 CB12A-A	FB12A-A	6Y3P FB12A-A
0681236	ESB12AL-A■	12		134	80	160	4	GM12AZ-3A-1 CB12AL-A	FB12AL-A	6Y3PS FB12AL-A
0681239	ESB12A-B■	12		134	80	160	4	GM12AZ-4B-2	—	FB12A-B
0681240	ESB12AL-A2■	12		134	80	160	4	GM12AZ-3A-2	FB12AL-A2	—
0681431	ESB14A-A2■	14		134	89	176	4	CB14A-A2	—	—
0681434	ESB14L-A2■	14		134	89	166	4	GM14Z-3A CB14L-A2	FB14L-A2	6Y4PS FB14L-A2
0681437	ESB14-A2■	14		134	89	166	4	GM14Z-4A CB14-A2	FB14-A2	6Y4P FB14-A2
0681438	ESB14-B2■	14		134	89	166	4	CB14-B2	—	—
0681439	ESB14L-B2■	14		134	89	166	4	GM14Z-3B CB14L-B2	FB14L-B2	6Y4PS FB14L-B2
0681634	ESB16AL-A2■	16		207	72	164	2	GM16A-3A CB16AL-A2	FB16AL-A2	6G4P FB16AL-A2
0681636	ESB16L-B■	19		175	100	155	2	GM16Z-3B CB16L-B	FB16L-B	—
0681637	ESB16B-A■	16		160	90	161	2	GM16B-4A	—	6M4P FB16B-A

▲ - Factory Sealed / Attivata dalla Fabbrica ■ - con Acido a corredo

Cod.	Modello Rif. EnergySafe	Caratteristiche		Dimensioni (±2mm)				Tabella Comparativa		
		Ah (10HR)	Poli/ Posiz.	Lung.	Larg.	Alt.	Conf. da n.	GS	FB	Fiamm
0681638	ESB16-B■	19	+	175	100	155	2	GM16Z-4B CB16-B	FB16-B	6B4P FB16-B
0681640	ESB16CL-B■	19	-	175	100	175	2	CB16CL-B	FB16CL-B	FB16CL-B
0681834	ESB18L-A■	18	-	180	90	162	2	GM18A-3A CB18L-A	FB18L-A	6M5PS
06851913	ES12C16A-3A(51913)■	19	-	186	82	171	2	-	-	-
0682034	ES50-N18L-A■	20	-	205	90	162	2	GM18Z-3A	FB50-N18L-A	605P F50N18L-A
06853030	ES60-N30L-B(53030)■	30	-	186	130	171	2	-	-	6IF200 53030
0683036	ESB30L-B■	30	-	168	132	176	2	CB30L-B	-	-

Batterie 12V ENERGYSAFE, senza manutenzione, a limitata autoscarica c/elettrolita a corredo per Scooter, Motocicli, ATV, Jet Sky, Snowmobile

Cod.	Modello Rif. EnergySafe	Caratteristiche		Dimensioni (±2mm)				Tabella Comparativa		
		Ah (10HR)	Poli/ Posiz.	Lung.	Larg.	Alt.	Conf. da n.	GS	FB	Fiamm
068029	ESTR4A-BS■	2,3	+	114	49	86	6	YTR4A-BS	FTR4A-BS	FTR4A-12B FTR4A-BS
068039	ESTX4L-BS■	3	-	114	71	86	6	GTX4L-BS	FTH4L-BS	6E4 FTX4L-BS
068049	ESTX5L-BS■	4	-	114	71	106	6	GTX5L-BS	FTX5L-BS	6E5 FTX5L-BS
068069	ESTX7L-BS■	6	-	114	71	131	6	GTX7L-BS	FTX7L-BS	6E7 FTX7L-BS
068070	ESTX7A-BS■	6	+	152	88	94	6	GTX7A-BS	FTX7A-BS	FTX7A-BS
068071	EST7B-BS■	6,5	+	150	65	93	6	GT7B-4	-	FT7-12B FT7-BS
068081	EST9B-BS■	8	+	150	70	105	6	GT9B-4	FT9-B4	FT9-BS
068099	ESTX9-BS■	8	+	152	88	106	6	GTX9-BS	FTX9-BS	6E9 FTX9-BS
0681090	ESTX12-BS■	10	+	152	88	131	4	GTX12-BS	FTX12-BS	6E12 F1212LB
0681100	EST12B-BS■	10	+	152	70	131	4	GT12B-4	-	F1212B FT12B-BS
0681110	EST12A-BS■	10	+	150	87	105	4	GT12A-BS	FT12A-BS	FT12A-BS
068129	ESTX14-BS■	12	+	150	87	145	4	GTX14-BS	FTX14-BS	6E14 FTX14-BS
068130	EST14B-BS■	12	+	152	70	145	4	GT14B-4	-	-
068139	ESTX15L-BS■	13	-	175	87	130	4	-	-	-
068168	ESTX16-BS■	14	+	150	87	161	4	GTX16-BS	FTH16-BS	FTX16-BS
068169	ESTX16-BS-1■	14	+	150	87	161	4	GTX16-BS-1	FTH16-BS-1	-
068209	ESTX20L-BS■	18	-	177	88	156	4	GTX20L-BS	FTX20L-BS	FTX20L-BS
0681815	ESTX20-B4	18	-	175	72	165	N/D	GTX20L-BS	FTX20L-BS	FTX20L-BS

▲ - Factory Sealed / Attivata dalla Fabbrica ■ - con Acido a corredo

Batterie 12V ENERGYSAFE sigillate, tipo MF, precaricate a bassissima autoscarica per Scooter e Motocicli

Modello		Caratteristiche		Dimensioni (±2mm)				Conf. da n.
Cod.	Rif. Energy Safe	Ah (10HR)	Poli/Posiz.	Lung.	Larg.	Alt.		
—								
—								
—								
—								
0680081	ESTZ8V▲	7	— +	113	70	130	N/D	

ALTERNATIVA A MODELLO YTZ-S

Modello		Conf. da n.
Cod.	Rif. YUASA	
068907	ESTTZ7S-BS■	N/D
068910	ESTTZ10S-BS■	N/D
068912	ESTTZ12S-BS■	N/D
068914	ESTTZ14S-BS■	N/D
—		

Vedere le specifiche applicazioni

Batterie 12V ENERGYSAFE, tipo MF High Performance, senza manutenzione (c/alto spunto) per Motocicli, ATV, Jet Sky, Snowmobile

Modello		Caratteristiche		Dimensioni (±2mm)				Conf. da n.	Tabella Comparativa		
Cod.	Rif. EnergySafe	Ah (10HR)	Poli/Posiz.	Lung.	Larg.	Alt.	GS		FB	Fiamm	
068122	ESTX14AH-BS■	12	+ -	134	89	166	4	GTX14AH-BS	—	—	

Batterie 12V FURUKAWA, senza manutenzione, a limitata autoscarica c/elettrolita a corredo per Scooter, Motocicli, ATV, Jet Sky, Snowmobile

Modello		Caratteristiche		Dimensioni (±2mm)				Conf. da n.	Tabella Comparativa		
Cod.	Rif. YUASA	Ah (10HR)	Poli/Posiz.	Lung.	Larg.	Alt.	GS		FB	Fiamm	
063049	YTX5L-BS■	4	— +	114	71	106	6	GTX5L-BS	FTX5L-BS	6E5 FTX5L-BS	
0630690	YTX7L-BS■	6	— +	114	71	131	6	GTX7L-BS	FTX7L-BS	6E7 FTX7L-BS	
0630990	YTX9-BS■	8	+ -	152	88	106	6	GTX9-BS	FTX9-BS	6E9 FTX9-BS	
0631090	YTX12-BS■	10	+ -	152	88	131	6	GTX12-BS	FTX12-BS	6E12 FI212LB	

Batterie 12V FURUKAWA sigillate, tipo MF, precaricate a bassissima autoscarica per Scooter e Motocicli

Modello		Caratteristiche		Dimensioni (±2mm)				Conf. da n.
Cod.	Rif. FURUKAWA	Ah (10HR)	Poli/Posiz.	Lung.	Larg.	Alt.		
063007	FTZ7S▲	6	— +	113	70	105	6	
063010	FTZ10S▲	8,6	+ -	150	87	93	6	
063012	FTZ12S▲	11	+ -	150	87	110	6	

ALTERNATIVA A MODELLO YTZ-S

Modello		Conf. da n.
Cod.	Rif. YUASA	
065007	YTZ7S▲	10
065010	YTZ10S▲	5
065012	YTZ12S▲	5

Vedere le specifiche applicazioni

Elettrolita per Batterie



06888888

Elettrolita batterie **Lt. 1**
(Confezione **12 pezzi**)



06888889

Elettrolita batterie **Lt. 5**
(Confezione **4 pezzi**)

Prodotti per Sicurezza



06888881

Solvente per acido.
(Confezione **Kg. 5**)

Solfonet cod. DUS351

Polvere assorbente neutralizzante per acido solforico.
Assorbe inglobando totalmente l'acido solforico delle batterie versato senza mai più rilasciarlo.
La superficie rimane pulita, asciutta e calpestabile.

Grazie al contenuto di una miscela di polveri speciali che danno una reazione esotermica (calore di neutralizzazione) che dura circa 3-4 minuti, **Solfonet** neutralizza l'acido solforico assorbito.

650 gr. di **Solfonet** assorbono 1 lt. di acido solforico.



06888882

Solvente per acido
(Confezione **Kg. 10**)

Polvere assorbente neutralizzante per acido solforico.
Assorbe inglobando totalmente l'acido solforico delle batterie versato senza mai più rilasciarlo.

La superficie rimane pulita, asciutta e calpestabile.

Grazie al contenuto di una miscela di polveri speciali che danno una reazione esotermica (calore di neutralizzazione) che dura circa 3-4 minuti, neutralizza l'acido solforico assorbito.

540 gr. di questo solvente assorbono 1 lt. di acido solforico.

Tabella di Conversione Batteria al Litio / Batteria Piombo Acido

COD. SGR	RIF. BATTERIA	SOSTITUISCE LE BATTERIE AL PIOMBO TIPO	Lung.	Larg.	Alt.	Peso	Spunto avv. C. C. A.
0675005	HJTZ5SFP	YTX4L-BS	113	70	85	0,5	120
		YTX5L-BS					
		YB4L-A YB4L-B					
		YB5L-B					
		12N4-3B					
		12N5-3B 12N5.5-3B					
0675001	LFP01	KTM	92	52	90	0,4	105
0675010	PTL-3	YTZ10S	150	97	93	0,9	240
0675014	PTL4/3	YTZ12S	150	97	93	0,9	270
		YTZ14S					
06750144	LFP14	GYZ16H	134	65	92	0,8	240
		YT12B-4					
		YT14B-BS					
		YTX12-BS YTX12A-BS					
		YX14AH-BS					
		YTX14-BS YTX14H-BS					
		YTX16-BS YTX16-BS-1					
		YTX20CH-BS					
		HVT-8					
		CB10A-A2					
		CB12A-A CB12A-B CB12B-B2 CB12C-A					
		CB14-A2 CB14-B2 CB14A-A1 CB14A-A2					
		CB16B-A CB16B-A1					
		HCB16A-AB					
0675014L	LFP14L	YTX14AHL-BS YTX14L-BS	134	65	92	0,8	240
		HVT-3					
		CB10L-A2 CB10L-B CB10L-B2 CB10L-BP					
		CB12AL-A CB12AL-A2					
		CB14L-A1 CB14L-A2 CB14L-B2					
		SCB14L-A2 SCB14L-B2					
		CB16AL-A2					
		12N10-3A-2					
		12N11-3A-1					
		12N12A-4A-1					
		12N14-3A					
0675016	LFP16	CB16-B CB16-B-CX CB16C-BCB18-A	165	86	130	1,1	300

COD. SGR	RIF. BATTERIA	SOSTITUISCE LE BATTERIE AL PIOMBO TIPO	Lung.	Larg.	Alt.	Peso	Spunto avv. C. C. A.
06750166	LFP16L	YTX15L-BS	165	86	130	1,1	300
		YTX18L-BS					
		CB16CL-B CB16L-B CB16AL-A2 CB16HL-A-CX					
		SCB16L-B					
		CB18L-A CB18L-A2					
06750200	LFP20L	GYZ20HL GYZ20L	165	86	130	1,3	330
		YTX20L-BS YTX20HL-BS					
		YTX24HL-BS					
		C50-N18L-A-CX C50-N18L-A C50N18L-A2 C50N18L-A3					
		SC50-N18L-AT					
0675029	LFP20	GYZ20H	165	86	130	1,3	330
		YTX20-BS YTX20H-BS					
		C50-N18A-A					
0675033	LFP30L	YIX30L	165	86	130	1,6	420
		YX30L-BS					
		YB30L-B YB30CL-B					
		YHD-12H					
		Y60N24-A Y60N24AL-B					
		12N24-3A 12N24-3					
		52515					
		53030					
53034							
0675070	LFP7L	YTZ5S	107	56	85	0,5	120
		YTX7L-BS					
		YB7-A YB7B-B YB7C-A YB7C-A YB7L-B					
		YB6.5L-B					
		12N7-3B 12N7-4A 12N7-4B 12N7A-3A 12N7A-4B 12N7CZ-3D 12N7D-3B					
0675077	LFP7Z	YTZ7S	107	56	85	0,5	144
		YTX7A-BS					
		YB9L-A2 YB9L-B YB9A-A YB9-B					
		12N9-4B-1 12N9-3A 12N9-3B					
		HVT-9					
0675081	LFP9	YTR9-BS	150	65	90	0,6	180
		YT7B-BS					
		YT9B-BS					
0675099	PTL-7	YTX9-BS	150	87	105	0,6	190

Norme per la corretta preparazione e manutenzione delle batterie

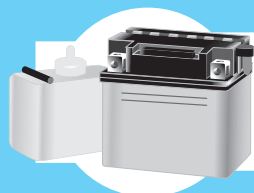

BATTERIE STANDARD

1 PREPARAZIONE DELLA BATTERIA

Collocare la batteria su una superficie piana in un'area ben ventilata.

{a} Rimuovere il tappo di sfiato rosso e gettarlo.

AVVERTENZA

Non rimontare il tappo rosso dopo aver riempito la batteria con acido!

{b} Rimuovere i cappucci di sfiato in plastica e conservarli.

2 ISTRUZIONI PER IL RIEMPIMENTO

Riempire la batteria con acido fino al livello massimo (a). Lasciare la batteria a riposo per 60 minuti prima di caricarla. Muovere delicatamente la batteria da un lato all'altro per far fuoriuscire eventuali bolle d'aria tra le piastre.

Se l'acido è al di sotto del livello richiesto, rabboccare fino al livello massimo.

NOTA: questa è l'ultima volta che deve essere aggiunto elettrolito(acido.)

Restituire l'acido inutilizzato alla struttura presso la quale è stata acquistata la batteria o neutralizzare l'acido con una pari quantità di bicarbonato di sodio.

3 ISTRUZIONI PER LA CARICA

Prima di mettere in servizio la batteria è necessaria una carica iniziale.

Per ottenere risultati ottimali e la massima durata, utilizzare un caricatore di compensazione da 0,5 o 0,75Amp (vedere la tabella per il tempo di carica adeguato per la batteria, presente nel foglio delle istruzioni).

Per evitare la fuoriuscita accidentale di acido durante la carica, collocare i cappucci sopra i fori di accesso senza serrarli.

Caricare per il periodo di tempo indicato nella tabella. Al termine del tempo di carica, la batteria deve essere priva di gas e deve avere un peso specifico di 1,282 per batterie da 12 o 6 Volt. Serrare i cappucci, pulire eventuali fuoriuscite di acido con acqua e asciugare la batteria.

Controllare la tensione della batteria al termine del tempo di carica adeguato e lasciarla a riposo per 1-2 ore. La tensione deve essere di 12,70 su una batteria da 12 Volt o 6,35 su una batteria da 6 Volt. Se la tensione è inferiore al valore specificato, continuare la carica per un tempo pari al 40% del totale.

(Esempio: 40% di una carica originale di 10 ore = 4 ore di carica aggiuntiva)

NOTA: se si utilizza un caricatore da 2 Amp o da 6 Amp, utilizzare l'impostazione automatica e caricare fino a quando il caricatore non indica

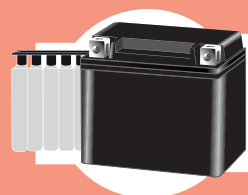

BATTERIE SENZA MANUTENZIONE CON ACIDO A CORREDO

1 PREPARAZIONE DELLA BATTERIA

Collocare la batteria su una superficie piana.

Staccare la guarnizione in alluminio.

2 PREPARAZIONE DELL'ELETTROLITO

Estrarre il flacone di elettrolito dal cartone.

Rimuovere e conservare i tappi a tenuta per poterli utilizzare dopo.

NOTA: non scrostare o forare le aree a tenuta.

3 PROCEDURA PER RIEMPIRE LA BATTERIA CON ACIDO

Collocare il contenitore di elettrolito capovolto con le sei aree sigillate allineate ai sei fori di riempimento della batteria.

Premere il contenitore esercitando una pressione sufficiente a rompere i sigilli.

L'elettrolito dovrebbe ora scorrere all'interno della batteria.

NOTA: non inclinare il contenitore altrimenti il flusso di elettrolito si potrebbe bloccare e non scorrere più all'interno della batteria .

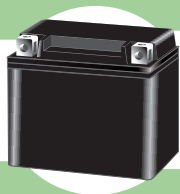

BATTERIE SIGILLATE (FACTORY SEALED / ATTIVATA DALLA FABBRICA)

1 PREPARAZIONE DELLA BATTERIA

Questa batteria è del tipo sigillato con valvola di sfiato.

Si prega di fare attenzione a non causare, con utensili metallici, un corto-circuito tra il polo positivo ed il negativo.

La batteria non richiede alcuna verifica del livello dell'elettrolito.

Non aprire MAI i tappi che sigillano la batteria.

Non ostruire mai l'apertura di sfiato.

2 MANUTENZIONE

Le batterie sigillate, essendo piene, non richiedono alcuna manutenzione riguardo all'aggiunta d'acqua. Perciò non provare mai ad aprirle.

Mantenere puliti sia i collegamenti che la superficie della batteria. Stringere i poli della batteria e ricoprirli con un sottile strato di grasso.

Controllare la carica della batteria verificando il voltaggio. Ricaricarla se necessario (vedere capitolo "Carica").

che la carica è completa o fino a quando la batteria non è priva di gas e il peso specifico corrisponde a 1,282 per batterie da 12Volt o da 6 Volt. La tensione deve essere di 12,70 o 6,35 Volt. Rimontare i cappucci di sfiato e serrarli, pulire eventuali fuoriuscite di acido con acqua e asciugare la batteria.

Al termine della carica, collegare un tubo di sfiato trasparente. Accertarsi che il tubo non sia piegato o ostruito.

AVVERTENZA!
Non superare i valori delle linee guida di carica elencati nella tabella nel foglio delle istruzioni.

Cariche prolungate o uso di caricatori a corrente continua possono accorciare la durata della batteria.

4 RIMOZIONE/MONTAGGIO

Rimuovere la vecchia batteria. Contrassegnare il cavo collegato al polo Positivo (+) e quello collegato al polo Negativo (-).

Pulire i morsetti dei cavi con una spazzola metallica o con carta vetrata per eliminare eventuali ossidazioni. Collocare la nuova batteria sul rispettivo ripiano, collegare il tubo di sfiato trasparente alla batteria, verificare che non siano presenti graffiature, piegature o ostruzioni. Sostituire il sistema di fissaggio.

⊕ Cavo rosso positivo (+) dal blocchetto di accensione al polo positivo.

⊖ Cavo nero negativo(-) dal motore o dal telaio al polo negativo.

5 MANUTENZIONE

Controllare il livello dell'elettrolito una volta al mese. Aggiungere solo acqua distillata (non acida) e riempire fino al livello massimo. NON far scendere il livello dell'elettrolito al di sotto del minimo.

NOTA: si consiglia di ricaricare la batteria ogni volta che viene aggiunta acqua.

6 STOCCAGGIO INVERNALE

Conservare le batterie completamente cariche in un luogo fresco e asciutto (NON nei pressi di un forno o di altre fonti di calore).

Controllare la batteria ogni 45-60 giorni e mantenere una tensione di 12,45 Volt o superiore.

4 CONTROLLARE IL FLUSSO DI ELETTROLITO

Accertarsi che ci siano bolle d'aria in uscita dai sei fori di riempimento. Lasciare il contenitore in quella posizione per almeno 20 minuti.

NOTA: se non si notano bolle d'aria in uscita da un foro di riempimento, battere sul fondo del flacone due o tre volte. Non rimuovere mai il contenitore dalla batteria.

5 ESTRAZIONE DEL CONTENITORE

Accertarsi che tutto l'elettrolito sia entrato nella batteria.

Battere sul fondo del contenitore come al passo 4, se nel contenitore c'è ancora elettrolito residuo.

A questo punto estrarre delicatamente il contenitore dalla batteria.

6 CHIUSURA A TENUTA DELLA BATTERIA

Tappare con decisione i fori di riempimento con la striscia di cappucci. Accertarsi che la striscia sia allineata al lato superiore della batteria.

La procedura di riempimento è stata completata. Non rimuovere mai la striscia di cappucci e non aggiungere acqua né elettrolito.

3 CONTROLLO DELLA BATTERIA

Usare il voltmetro per misurare il voltaggio.

Se il voltaggio rilevato è superiore a 12.4 volt, la batteria può essere utilizzata immediatamente.

Se il voltaggio rilevato è inferiore, ricaricare la batteria (vedere capitolo "Carica")

4 CARICA



Caricare la batteria con la corrente e per il tempo indicato sulla medesima.

In mancanza di voltmetro, caricare la batteria con la corrente ed il tempo indicati e determinare lo stato di carica in base alla facilità d'avviamento del motore.

Se è indispensabile una carica rapida, seguire strettamente le indicazioni concernenti la corrente di carica massima e il tempo di ricarica.

In caso di mancato avviamento del motore, procedere ad una nuova carica della stessa intensità e dello stesso tempo.

L'intensità di corrente ed il tempo di carica devono essere mantenuti, durante la carica, come specificato. La carica rapida e/o la sovraccarica potrebbe causare la diminuzione del livello dell'elettrolito con conseguente esclusione di possibilità d'impiego della batteria.

Marca / Cilindrata / Modello / Anno		Cod. SGR		Cod. SGR		Cod. SGR	
ADLY							
50	AT City Bird 2T	1998/2003	06504340	YB4L-B	—	—	—
50	AT City Bird 2T	1998/2003	065043410	YB4L-B■	0680434	ESB4L-B■	—
50	AT RS City Bird 2T	1998/2003	06504340	YB4L-B	—	—	—
50	AT RS City Bird 2T	1998/2003	065043410	YB4L-B■	0680434	ESB4L-B■	—
50	Cat 2T	1997/>	0650390	YTX4L-BS■	068039	ESTX4L-BS■	—
50	Fox 2T	1998/2002	0650390	YTX4L-BS■	068039	ESTX4L-BS■	—
50	G-Shock 2T	1997/1998	0650390	YTX4L-BS■	068039	ESTX4L-BS■	—
50	Jet 2T	1997/1999	0650390	YTX4L-BS■	068039	ESTX4L-BS■	—
50	Jet E1 2T	1999/2003	0650390	YTX4L-BS■	068039	ESTX4L-BS■	—
50	Noble 2T	2006/>	0650390	YTX4L-BS■	068039	ESTX4L-BS■	—
50	Panther 2T	2002/2009	0650390	YTX4L-BS■	068039	ESTX4L-BS■	—
50	PT Pista 2T	1997/1999	06504340	YB4L-B	—	—	—
50	PT Pista 2T	1997/1999	065043410	YB4L-B■	0680434	ESB4L-B■	—
50	RS Supersonic ATV	2006/2008	065049	YTX5L-BS■	068049	ESTX5L-BS■	063049
50	RS Supersonic ATV 2T	2005/2007	0650390	YTX4L-BS■	068039	ESTX4L-BS■	—
50	RT Road Tracer 2T	2002/>	0650390	YTX4L-BS■	068039	ESTX4L-BS■	—
50	SF Silver Fox 2T	2006/>	0650390	YTX4L-BS■	068039	ESTX4L-BS■	—
50	SS Supersonic 2T	2004/>	0650390	YTX4L-BS■	068039	ESTX4L-BS■	—
50	TB Thunder Bike 2T	TUTTI	0650390	YTX4L-BS■	068039	ESTX4L-BS■	—
100	Cat 2T	1997/1998	0650390	YTX4L-BS■	068039	ESTX4L-BS■	—
100	Jet 2T	1999/2003	0650390	YTX4L-BS■	068039	ESTX4L-BS■	—
100	Noble 2T	TUTTI	0650390	YTX4L-BS■	068039	ESTX4L-BS■	—
100	Panther 2T	2001/2006	0650390	YTX4L-BS■	068039	ESTX4L-BS■	—
100	Predator 2T	1997/2000	0650390	YTX4L-BS■	068039	ESTX4L-BS■	—
100	Predator2 2T	2001/2003	0650390	YTX4L-BS■	068039	ESTX4L-BS■	—
100	RT Road Tracer 2T	2002/>	0650390	YTX4L-BS■	068039	ESTX4L-BS■	—
100	SS Supersonic 2T	2001/2006	0650390	YTX4L-BS■	068039	ESTX4L-BS■	—
100	Z1	TUTTI	0650390	YTX4L-BS■	068039	ESTX4L-BS■	—
125	Activator	TUTTI	0650700	YTX7A-BS■	068070	ESTX7A-BS■	—
125	Cat 4T	2006/>	0650700	YTX7A-BS■	068070	ESTX7A-BS■	—
125	Noble 4T	2006/>	0650700	YTX7A-BS■	068070	ESTX7A-BS■	—
125	Thunder Bike 4T	2000/2006	0650700	YTX7A-BS■	068070	ESTX7A-BS■	—
150	Cross X Over	2007/2008	0651090	YTX12-BS■	0681090	ESTX12-BS■	063109
150	Cross X Road	2007/2008	0651090	YTX12-BS■	0681090	ESTX12-BS■	063109
150	Crusader 4T	2009/>	0651090	YTX12-BS■	0681090	ESTX12-BS■	063109
150	Interceptor 4T	2005/2008	0651090	YTX12-BS■	0681090	ESTX12-BS■	063109
150	S Sport ATV 4T	2004/>	0650990	YTX9-BS■	068099	ESTX9-BS■	063099
220	Sentinel 4T	2007/>	065122	YTX14AH-BS■	068122	ESTX14AH-BS■	—
220	Sentinel 4T	2007/>	0651431	YB14A-A2	0681431	ESB14A-A2■	—
300	Cross X Over	2007/2008	0651090	YTX12-BS■	0681090	ESTX12-BS■	063109
300	Cross X Road	2007/2008	0651090	YTX12-BS■	0681090	ESTX12-BS■	063109



▲ - Factory Sealed / Attivata dalla Fabbrica ■ - con Acido a corredo ◇ - Non di produzione YUASA a completamento gamma

Marca / Cilindrata / Modello / Anno			Cod. SGR		Cod. SGR		Cod. SGR		
ADLY									
300	Interceptor	2005/2008	0650990	YTX9-BS■	068099	ESTX9-BS■	063099	FTX9-BS■	
300	Quad Crusader	2009/>	0651090	YTX12-BS■	0681090	ESTX12-BS■	063109	FTX12-BS■	
300	RS	2007/2008	0650990	YTX9-BS■	068099	ESTX9-BS■	063099	FTX9-BS■	
300	Sport	2007/>	0650990	YTX9-BS■	068099	ESTX9-BS■	063099	FTX9-BS■	
300	Tatanka	TUTTI	0650990	YTX9-BS■	068099	ESTX9-BS■	063099	FTX9-BS■	
300	Utility	TUTTI	0650990	YTX9-BS■	068099	ESTX9-BS■	063099	FTX9-BS■	
300	XS Hurricane 4V	2007/2008	0650990	YTX9-BS■	068099	ESTX9-BS■	063099	FTX9-BS■	
320	S	2007/>	0651090	YTX12-BS■	0681090	ESTX12-BS■	063109	FTX12-BS■	
320	U	2007/>	0651090	YTX12-BS■	0681090	ESTX12-BS■	063109	FTX12-BS■	
500	S Hurricane	2008/>	0651090	YTX12-BS■	0681090	ESTX12-BS■	063109	FTX12-BS■	
AEON									
50	Cobra	TUTTI	0650390	YTX4L-BS■	068039	ESTX4L-BS■	—	—	
90	Cobra	TUTTI	0650390	YTX4L-BS■	068039	ESTX4L-BS■	—	—	
125	Cobra RS / Cobra Utility	2000/2004	0650990	YTX9-BS■	068099	ESTX9-BS■	063099	FTX9-BS■	
125	Elite	2012/2013	0650990	YTX9-BS■	068099	ESTX9-BS■	063099	FTX9-BS■	
125	Overland	2002/2008	0650990	YTX9-BS■	068099	ESTX9-BS■	063099	FTX9-BS■	
125	Urban	2011/2013	0650990	YTX9-BS■	068099	ESTX9-BS■	063099	FTX9-BS■	
180	Cobra RS / Cobra Utility	TUTTI	0650990	YTX9-BS■	068099	ESTX9-BS■	063099	FTX9-BS■	
180	Overland	2002/2008	0650990	YTX9-BS■	068099	ESTX9-BS■	063099	FTX9-BS■	
220	Cobra	2004/2007	0651090	YTX12-BS■	0681090	ESTX12-BS■	063109	FTX12-BS■	
300	Crossland LC 4T	TUTTI	0651090	YTX12-BS■	0681090	ESTX12-BS■	063109	FTX12-BS■	
320	Cobra	2007/2008	0651090	YTX12-BS■	0681090	ESTX12-BS■	063109	FTX12-BS■	
350	Cobra	2009/2010	0651090	YTX12-BS■	0681090	ESTX12-BS■	063109	FTX12-BS■	
350	Crossland 4X4	2009/2010	0651090	YTX12-BS■	0681090	ESTX12-BS■	063109	FTX12-BS■	
350	Elite	2012/2013	0651090	YTX12-BS■	0681090	ESTX12-BS■	063109	FTX12-BS■	
350	Urban	2011/2013	0651090	YTX12-BS■	0681090	ESTX12-BS■	063109	FTX12-BS■	
AERMACCHI									
125	SX 2T	1974/1974	0650734	12N7-3B	0680734	ES12N7-3B■	—	—	
175	Ala Bianca	1957/1964	0600715	B39-6	—	—	—	—	
175	Ala Rossa	1957/1964	0600715	B39-6	—	—	—	—	
175	Chimera	1956/1961	0600715	B39-6	—	—	—	—	
175	SX 2T	1974/1978	0650734	12N7-3B	0680734	ES12N7-3B■	—	—	
250	Ala Azzurra	1958/1964	0601112	6N11A-1B	—	—	—	—	
250	Ala Bianca	1958/1964	0601112	6N11A-1B	—	—	—	—	
250	Ala Blu GT	1967/1972	0601112	6N11A-1B	—	—	—	—	
250	Ala Oro	1959/1968	0601112	6N11A-1B	—	—	—	—	
250	Ala Rossa	1959/1968	0601112	6N11A-1B	—	—	—	—	
250	Ala Verde	1959/1972	0601112	6N11A-1B	—	—	—	—	
250	Chimera	1958/1964	0600715	B39-6	—	—	—	—	
250	SX	1975/1978	0650734	12N7-3B	0680734	ES12N7-3B■	—	—	
350	Ala Azzurra/ Ala Bianca	1985/>	0601112	6N11A-1B	—	—	—	—	



▲ - Factory Sealed / Attivata dalla Fabbrica ■ - con Acido a corredo ◇ - Non di produzione YUASA a completamento gamma

Marca / Cilindrata / Modello / Anno		Cod. SGR		Cod. SGR		Cod. SGR	
AERMACCHI							
350	Ala Oro/ Ala Rossa	1960/1968	0601112	6N11A-1B	—	—	—
350	SST	1981/>	0601112	6N11A-1B	—	—	—
350	SX	1981/>	0601112	6N11A-1B	—	—	—
APRILIA							
50	AF1 Europa	1990/1992	06504340	YB4L-B	—	—	—
50	AF1 Europa	1990/1992	065043410	YB4L-B■	0680434	ESB4L-B■	—
50	AF1 Futura	1990/1992	06504340	YB4L-B	—	—	—
50	AF1 Futura	1990/1992	065043410	YB4L-B■	0680434	ESB4L-B■	—
50	Amico LK/ LX/ GL DT	1992/1998	06504340	YB4L-B	—	—	—
50	Amico LK/ LX/ GL DT	1992/1998	065043410	YB4L-B■	0680434	ESB4L-B■	—
50	Amico LK/ LX/ GL TT	1992/1998	06504340	YB4L-B	—	—	—
50	Amico LK/ LX/ GL TT	1992/1998	065043410	YB4L-B■	0680434	ESB4L-B■	—
50	Amico Sport DT	1992/1998	06504340	YB4L-B	—	—	—
50	Amico Sport DT	1992/1998	065043410	YB4L-B■	0680434	ESB4L-B■	—
50	Area 51	1998/2000	06504340	YB4L-B	—	—	—
50	Area 51	1998/2000	065043410	YB4L-B■	0680434	ESB4L-B■	—
50	Classic	1992/1999	06504340	YB4L-B	—	—	—
50	Classic	1992/1999	065043410	YB4L-B■	0680434	ESB4L-B■	—
50	ET	1984/1986	06504340	YB4L-B	—	—	—
50	ET	1984/1986	065043410	YB4L-B■	0680434	ESB4L-B■	—
50	ET AE	1987/>	06504340	YB4L-B	—	—	—
50	ET AE	1987/>	065043410	YB4L-B■	0680434	ESB4L-B■	—
50	ETX	1987/>	06504340	YB4L-B	—	—	—
50	ETX	1987/>	065043410	YB4L-B■	0680434	ESB4L-B■	—
50	Gulliver Air	1995/2000	06504340	YB4L-B	—	—	—
50	Gulliver Air	1995/2000	065043410	YB4L-B■	0680434	ESB4L-B■	—
50	Gulliver Lc	1995/2000	06504340	YB4L-B	—	—	—
50	Gulliver Lc	1995/2000	065043410	YB4L-B■	0680434	ESB4L-B■	—
50	Habana	1999/2003	06504340	YB4L-B	—	—	—
50	Habana	1999/2003	065043410	YB4L-B■	0680434	ESB4L-B■	—
50	Habana Custom	1999/2003	06504340	YB4L-B	—	—	—
50	Habana Custom	1999/2003	065043410	YB4L-B■	0680434	ESB4L-B■	—
50	Mc Gulliver	1999/2000	06504340	YB4L-B	—	—	—
50	Mc Gulliver	1999/2000	065043410	YB4L-B■	0680434	ESB4L-B■	—
50	Mojito 2T Hiper2	2004/2008	06504340	YB4L-B	—	—	—
50	Mojito 2T Hiper2	2004/2008	065043410	YB4L-B■	0680434	ESB4L-B■	—
50	Mojito Custom 2T	1999/2003	06504340	YB4L-B	—	—	—
50	Mojito Custom 2T	1999/2003	065043410	YB4L-B■	0680434	ESB4L-B■	—
50	Mojito Retrò 2T	1999/2003	06504340	YB4L-B	—	—	—
50	Mojito Retrò 2T	1999/2003	065043410	YB4L-B■	0680434	ESB4L-B■	—
50	Pegaso	1992/1997	06504340	YB4L-B	—	—	—



▲ - Factory Sealed / Attivata dalla Fabbrica ■ - con Acido a corredo ◇ - Non di produzione YUASA a completamento gamma

Marca / Cilindrata / Modello / Anno			Cod. SGR		Cod. SGR		Cod. SGR		
APRILIA									
50	Pegaso	1992/1997	065043410	YB4L-B■	0680434	ESB4L-B■	—	—	
50	Rally Air DT	1995/1999	06504340	YB4L-B	—	—	—	—	
50	Rally Air DT	1995/1999	065043410	YB4L-B■	0680434	ESB4L-B■	—	—	
50	Rally Lc DD	1996/2000	06504340	YB4L-B	—	—	—	—	
50	Rally Lc DD	1996/2000	065043410	YB4L-B■	0680434	ESB4L-B■	—	—	
50	Rally Lc DT	1996/2000	06504340	YB4L-B	—	—	—	—	
50	Rally Lc DT	1996/2000	065043410	YB4L-B■	0680434	ESB4L-B■	—	—	
50	Red Rose	1988/1992	06504340	YB4L-B	—	—	—	—	
50	Red Rose	1988/1992	065043410	YB4L-B■	0680434	ESB4L-B■	—	—	
50	Red Rose AE	1988/1992	06504340	YB4L-B	—	—	—	—	
50	Red Rose AE	1988/1992	065043410	YB4L-B■	0680434	ESB4L-B■	—	—	
50	RS	2006/2013	065049	YTX5L-BS■	068049	ESTX5L-BS■	063049	FTX5L-BS■	
50	RS Extrema, Replica	1993/2005	06504340	YB4L-B	—	—	—	—	
50	RS Extrema, Replica	1993/2005	065043410	YB4L-B■	0680434	ESB4L-B■	—	—	
50	RS4	2011/2016	065049	YTX5L-BS■	068049	ESTX5L-BS■	063049	FTX5L-BS■	
50	RX	1989/2006	06504340	YB4L-B	—	—	—	—	
50	RX	1989/2006	065043410	YB4L-B■	0680434	ESB4L-B■	—	—	
50	RX (PV00/ PVA00)	2006/2016	06504340	YB4L-B	—	—	—	—	
50	RX (PV00/ PVA00)	2006/2016	065043410	YB4L-B■	0680434	ESB4L-B■	—	—	
50	RX AE	1989/1990	06504340	YB4L-B	—	—	—	—	
50	RX AE	1989/1990	065043410	YB4L-B■	0680434	ESB4L-B■	—	—	
50	Scarabeo 2T DD (PF010/ PFG10)	1998/1999	06504340	YB4L-B	—	—	—	—	
50	Scarabeo 2T DD (PF010/ PFG10)	1998/1999	065043410	YB4L-B■	0680434	ESB4L-B■	—	—	
50	Scarabeo 2T DT (LE/ T/ PF00/ PFG00)	1993/1999	06504340	YB4L-B	—	—	—	—	
50	Scarabeo 2T DT (LE/ T/ PF00/ PFG00)	1993/1999	065043410	YB4L-B■	0680434	ESB4L-B■	—	—	
50	Scarabeo 2T Hiper2 (THG00)	2010/2010	06504340	YB4L-B	—	—	—	—	
50	Scarabeo 2T Hiper2 (THG00)	2010/2010	065043410	YB4L-B■	0680434	ESB4L-B■	—	—	
50	Scarabeo 2T Hiper2 Net / Street (THG00)	2010/2015	06504340	YB4L-B	—	—	—	—	
50	Scarabeo 2T Hiper2 Net / Street (THG00)	2010/2015	065043410	YB4L-B■	0680434	ESB4L-B■	—	—	
50	Scarabeo 2T TT HS	1993/1997	06504340	YB4L-B	—	—	—	—	
50	Scarabeo 2T TT HS	1993/1997	065043410	YB4L-B■	0680434	ESB4L-B■	—	—	
50	Scarabeo 4T / Rst 4T (TGA00/ TGA00/ TGB00)	2003/2010	06509350	YB9-B	0680935	ESB9-B■	—	—	
50	Scarabeo 4T 4V (TGE00)	2009/2015	06509350	YB9-B	0680935	ESB9-B■	—	—	
50	Scarabeo 4T 4V Net (TGE00)	2010/2013	06509350	YB9-B	0680935	ESB9-B■	—	—	
50	Scarabeo Ditech (SCA00)	2001/2006	065049	YTX5L-BS■	068049	ESTX5L-BS■	063049	FTX5L-BS■	
50	Scarabeo Street 2T DD (PFG10)	2000/2005	06504340	YB4L-B	—	—	—	—	
50	Scarabeo Street 2T DD (PFG10)	2000/2005	065043410	YB4L-B■	0680434	ESB4L-B■	—	—	
50	Scarabeo Street 2T DT (PFG00/ TH00)	2000/2005	06504340	YB4L-B	—	—	—	—	
50	Scarabeo Street 2T DT (PFG00/ TH00)	2000/2005	065043410	YB4L-B■	0680434	ESB4L-B■	—	—	
50	Scarabeo Street 2T Hiper2 (THE00)	2005/2006	06504340	YB4L-B	—	—	—	—	
50	Scarabeo Street 2T Hiper2 (THE00)	2005/2006	065043410	YB4L-B■	0680434	ESB4L-B■	—	—	

▲ - Factory Sealed / Attivata dalla Fabbrica ■ - con Acido a corredo ◇ - Non di produzione YUASA a completamento gamma

Marca / Cilindrata / Modello / Anno		Cod. SGR		Cod. SGR		Cod. SGR	
APRILIA							
50	Scarabeo Street Rst 2T Hiper2 (THG00)	2006/2009	06504340	YB4L-B	—	—	—
50	Scarabeo Street Rst 2T Hiper2 (THG00)	2006/2009	065043410	YB4L-B■	0680434	ESB4L-B■	—
50	Sonic / Sonic GP LC	1998/2000	06504340	YB4L-B	—	—	—
50	Sonic / Sonic GP LC	1998/2000	065043410	YB4L-B■	0680434	ESB4L-B■	—
50	Sportcity One 4T (SB00/ SBC00)	2008/2012	06509350	YB9-B	0680935	ESB9-B■	—
50	Sportcity One 4T 4V	2011/2014	06509350	YB9-B	0680935	ESB9-B■	—
50	Sportcity One Street 2T (SBA00)	2008/2012	06509350	YB9-B	0680935	ESB9-B■	—
50	SR Air	1993/1996	06504340	YB4L-B	—	—	—
50	SR Air	1993/1996	065043410	YB4L-B■	0680434	ESB4L-B■	—
50	SR Ditech (RLB1/ RLD1)	2000/2003	065049	YTX5L-BS■	068049	ESTX5L-BS■	063049
50	SR H2O Racing/ Sport (RLA1)	2000/2004	06504340	YB4L-B	—	—	—
50	SR H2O Racing/ Sport (RLA1)	2000/2004	065043410	YB4L-B■	0680434	ESB4L-B■	—
50	SR LC	1993/1996	06504340	YB4L-B	—	—	—
50	SR LC	1993/1996	065043410	YB4L-B■	0680434	ESB4L-B■	—
50	SR Motard (LBMC)	2012/2015	06509350	YB9-B	0680935	ESB9-B■	—
50	SR Netscaper	1997/1999	06504340	YB4L-B	—	—	—
50	SR Netscaper	1997/1999	065043410	YB4L-B■	0680434	ESB4L-B■	—
50	SR R Factory Ditech (VFA00)	2005/2006	06509350	YB9-B	0680935	ESB9-B■	—
50	SR R Factory Hiper2 (VFD)	2005/2012	06509350	YB9-B	0680935	ESB9-B■	—
50	SR R Factory IE Purejet (VFB)	2005/2015	06509350	YB9-B	0680935	ESB9-B■	—
50	SR R Hiper2 (VFD)	2005/2015	06509350	YB9-B	0680935	ESB9-B■	—
50	SR Racing	1997/2000	06504340	YB4L-B	—	—	—
50	SR Racing	1997/2000	065043410	YB4L-B■	0680434	ESB4L-B■	—
50	SR Sport	1997/2000	06504340	YB4L-B	—	—	—
50	SR Sport	1997/2000	065043410	YB4L-B■	0680434	ESB4L-B■	—
50	SR Stealth	1997/1999	06504340	YB4L-B	—	—	—
50	SR Stealth	1997/1999	065043410	YB4L-B■	0680434	ESB4L-B■	—
50	SR Street H2O Hiper2 (TEA00)	2003/2015	06504340	YB4L-B	—	—	—
50	SR Street H2O Hiper2 (TEA00)	2003/2015	065043410	YB4L-B■	0680434	ESB4L-B■	—
50	SR Street Purejet (TE000)	2003/2015	065049	YTX5L-BS■	068049	ESTX5L-BS■	063049
50	SR WWW	1997/2000	06504340	YB4L-B	—	—	—
50	SR WWW	1997/2000	065043410	YB4L-B■	0680434	ESB4L-B■	—
50	SX (PV00/ PVA00)	2006/2016	06504340	YB4L-B	—	—	—
50	SX (PV00/ PVA00)	2006/2016	065043410	YB4L-B■	0680434	ESB4L-B■	—
50	Tuareg Rally AE	1990/1992	06504340	YB4L-B	—	—	—
50	Tuareg Rally AE	1990/1992	065043410	YB4L-B■	0680434	ESB4L-B■	—
50	Tuareg Wind	1986/1989	06504340	YB4L-B	—	—	—
50	Tuareg Wind	1986/1989	065043410	YB4L-B■	0680434	ESB4L-B■	—
50	Tuareg Wind AE	1986/1989	06504340	YB4L-B	—	—	—
50	Tuareg Wind AE	1986/1989	065043410	YB4L-B■	0680434	ESB4L-B■	—
50	Tuono	2003/2007	06504340	YB4L-B	—	—	—



▲ - Factory Sealed / Attivata dalla Fabbrica ■ - con Acido a corredo ◇ - Non di produzione YUASA a completamento gamma

Marca / Cilindrata / Modello / Anno			Cod. SGR		Cod. SGR		Cod. SGR	
APRILIA								
50	Tuono	2003/2007	065043410	YB4L-B■	0680434	ESB4L-B■	—	—
100	Scarabeo 2T	2000/2001	065049	YTX5L-BS■	068049	ESTX5L-BS■	063049	FTX5L-BS■
100	Scarabeo 4T / Rst 4T / Net 4T (VAA00/ VAC00)	2001/2009	06509350	YB9-B	0680935	ESB9-B■	—	—
100	Scarabeo 4T E3 (VAC00/ VAA00)	2010/2015	06509350	YB9-B	0680935	ESB9-B■	—	—
100	Scarabeo 4T Net E3 (ZD4VAC/ ZD4VAA)	2010/2013	06509350	YB9-B	0680935	ESB9-B■	—	—
125	AF1 Europa	1990/1991	06509350	YB9-B	0680935	ESB9-B■	—	—
125	AF1 Futura	1990/1991	06509350	YB9-B	0680935	ESB9-B■	—	—
125	AF1 Replica	1989/1990	06509350	YB9-B	0680935	ESB9-B■	—	—
125	AF1 Sintesi	1989/1991	06509350	YB9-B	0680935	ESB9-B■	—	—
125	AF1 Sport	1991/1991	06509350	YB9-B	0680935	ESB9-B■	—	—
125	AF1 Sport Production	1991/1992	06509350	YB9-B	0680935	ESB9-B■	—	—
125	AS R	1985/1986	0650634	12N5.5-3B	0680634	ES12N5.5-3B■	—	—
125	Atlantic / Atlantic E3 (SPD)	2003/2014	06512360	YB12AL-A	0681236	ESB12AL-A■	—	—
125	Atlantic / Atlantic E3 (SPD)	2003/2014	06512400	YB12AL-A2	0681240	ESB12AL-A2■	—	—
125	Classic	1995/1999	06509350	YB9-B	0680935	ESB9-B■	—	—
125	ETX	1984/1985	0650634	12N5.5-3B	0680634	ES12N5.5-3B■	—	—
125	ETX	1986/1990	06504340	YB4L-B	—	—	—	—
125	ETX	1986/1990	065043410	YB4L-B■	0680434	ESB4L-B■	—	—
125	Habana Custom	1999/2002	0650990	YTX9-BS■	068099	ESTX9-BS■	063099	FTX9-BS■
125	Habana Retrò	1999/2002	0650990	YTX9-BS■	068099	ESTX9-BS■	063099	FTX9-BS■
125	Leonardo	1996/1998	06512360	YB12AL-A	0681236	ESB12AL-A■	—	—
125	Leonardo	1996/1998	06512400	YB12AL-A2	0681240	ESB12AL-A2■	—	—
125	Leonardo ST	1999/2004	06512360	YB12AL-A	0681236	ESB12AL-A■	—	—
125	Leonardo ST	1999/2004	06512400	YB12AL-A2	0681240	ESB12AL-A2■	—	—
125	MX SM (11K)	2004/2006	06504340	YB4L-B	—	—	—	—
125	MX SM (11K)	2004/2006	065043410	YB4L-B■	0680434	ESB4L-B■	—	—
125	MX SM (25K)	2004/2006	06504340	YB4L-B	—	—	—	—
125	MX SM (25K)	2004/2006	065043410	YB4L-B■	0680434	ESB4L-B■	—	—
125	Pegaso/ Kat	1989/1996	06509350	YB9-B	0680935	ESB9-B■	—	—
125	Red Rose	1987/1994	06509350	YB9-B	0680935	ESB9-B■	—	—
125	RS, RS Extrema, RS Pista	1992/2013	06509350	YB9-B	0680935	ESB9-B■	—	—
125	RS4 (TW000)	2011/2016	0650690	YTX7L-BS■	068069	ESTX7L-BS■	063069	FTX7L-BS■
125	RX (GF/ HT/ MT)	1989/1990	0650634	12N5.5-3B	0680634	ES12N5.5-3B■	—	—
125	RX (GF/ HT/ MT)	1991/2000	06504340	YB4L-B	—	—	—	—
125	RX (GF/ HT/ MT)	1991/2000	065043410	YB4L-B■	0680434	ESB4L-B■	—	—
125	RX (RV00)	2008/2013	06504340	YB4L-B	—	—	—	—
125	RX (RV00)	2008/2013	065043410	YB4L-B■	0680434	ESB4L-B■	—	—
125	Scarabeo 4T Rotax	1999/2002	06512360	YB12AL-A	0681236	ESB12AL-A■	—	—
125	Scarabeo 4T Rotax	1999/2002	06512400	YB12AL-A2	0681240	ESB12AL-A2■	—	—
125	Scarabeo GT 4T Piaggio (TD000/ TD002/ TDA01/ TDB01)	2003/2006	06512360	YB12AL-A	0681236	ESB12AL-A■	—	—
125	Scarabeo GT 4T Piaggio (TD000/ TD002/ TDA01/ TDB01)	2003/2006	06512400	YB12AL-A2	0681240	ESB12AL-A2■	—	—



▲ - Factory Sealed / Attivata dalla Fabbrica ■ - con Acido a corredo ◇ - Non di produzione YUASA a completamento gamma

Marca / Cilindrata / Modello / Anno			Cod. SGR		Cod. SGR		Cod. SGR	
APRILIA								
125	Scarabeo GT E3 4T Piaggio (TD005/ TDA03)	2006/2007	06512360	YB12AL-A	0681236	ESB12AL-A■	—	—
125	Scarabeo GT E3 4T Piaggio (TD005/ TDA03)	2006/2007	06512400	YB12AL-A2	0681240	ESB12AL-A2■	—	—
125	Scarabeo Light 4T (RB000/ RBA00)	2007/2008	0651090	YTX12-BS■	0681090	ESTX12-BS■	063109	FTX12-BS■
125	Scarabeo Light IE 4T (RBG00/ RBH00)	2009/2011	0651090	YTX12-BS■	0681090	ESTX12-BS■	063109	FTX12-BS■
125	Scarabeo NET IE 4T (RBG00)	2010/2015	0651090	YTX12-BS■	0681090	ESTX12-BS■	063109	FTX12-BS■
125	Sportcity / Sportcity E3	2004/2009	0651100	YT12B-BS■	0681100	EST12B-BS■	—	—
125	Sportcity Cube/ Street	2008/2014	0651090	YTX12-BS■	0681090	ESTX12-BS■	063109	FTX12-BS■
125	Sportcity One	2008/2014	06509350	YB9-B	0680935	ESB9-B■	—	—
125	SR	1999/2002	0650690	YTX7L-BS■	068069	ESTX7L-BS■	063069	FTX7L-BS■
125	SR MAX	2011/2015	065124	YTX14H-BS■	—	—	—	—
125	SR MAX	2011/2015	065129	YTX14-BS■	068129	ESTX14-BS■	—	—
125	SR Motard (LBMM7)	2011/2016	06509350	YB9-B	0680935	ESB9-B■	—	—
125	ST / STX	1982/1985	0650634	12N5.5-3B	0680634	ES12N5.5-3B■	—	—
125	SX (RVA00)	2008/2013	06504340	YB4L-B	—	—	—	—
125	SX (RVA00)	2008/2013	065043410	YB4L-B■	0680434	ESB4L-B■	—	—
125	Tuareg	1986/1990	06509350	YB9-B	0680935	ESB9-B■	—	—
125	Tuareg Rally	1986/1986	0600413	6N4-2A-4	—	—	—	—
125	Tuareg Rally	1989/1994	06509350	YB9-B	0680935	ESB9-B■	—	—
125	Tuareg Wind	1988/1988	06509350	YB9-B	0680935	ESB9-B■	—	—
125	Tuono	2003/2004	06509350	YB9-B	0680935	ESB9-B■	—	—
150	Leonardo	1996/1998	06512360	YB12AL-A	0681236	ESB12AL-A■	—	—
150	Leonardo	1996/1998	06512400	YB12AL-A2	0681240	ESB12AL-A2■	—	—
150	Leonardo ST	1999/2004	06512360	YB12AL-A	0681236	ESB12AL-A■	—	—
150	Leonardo ST	1999/2004	06512400	YB12AL-A2	0681240	ESB12AL-A2■	—	—
150	Mojito	2003/2008	0650690	YTX7L-BS■	068069	ESTX7L-BS■	063069	FTX7L-BS■
150	Scarabeo 4T Rotax	1999/2002	06512360	YB12AL-A	0681236	ESB12AL-A■	—	—
150	Scarabeo 4T Rotax	1999/2002	06512400	YB12AL-A2	0681240	ESB12AL-A2■	—	—
150	SR	1999/2002	0650690	YTX7L-BS■	068069	ESTX7L-BS■	063069	FTX7L-BS■
200	Atlantic	2003/2008	06512360	YB12AL-A	0681236	ESB12AL-A■	—	—
200	Atlantic	2003/2008	06512400	YB12AL-A2	0681240	ESB12AL-A2■	—	—
200	Scarabeo 4T Rotax	1999/2002	06512360	YB12AL-A	0681236	ESB12AL-A■	—	—
200	Scarabeo 4T Rotax	1999/2002	06512400	YB12AL-A2	0681240	ESB12AL-A2■	—	—
200	Scarabeo GT / GT E3 4T Piaggio	2003/2007	06512360	YB12AL-A	0681236	ESB12AL-A■	—	—
200	Scarabeo GT / GT E3 4T Piaggio	2003/2007	06512400	YB12AL-A2	0681240	ESB12AL-A2■	—	—
200	Scarabeo Light 4T (RBA00)	2007/2009	0651090	YTX12-BS■	0681090	ESTX12-BS■	063109	FTX12-BS■
200	Scarabeo Light/ Net IE 4T (RBL00/ RBM00)	2009/2015	0651090	YTX12-BS■	0681090	ESTX12-BS■	063109	FTX12-BS■
200	Sportcity / Sportcity E3 (VBA00/ VBA01)	2004/2009	0651100	YT12B-BS■	0681100	EST12B-BS■	—	—
200	Sportcity Cube (VBG00)	2008/2012	0651090	YTX12-BS■	0681090	ESTX12-BS■	063109	FTX12-BS■
250	Atlantic	2004/2006	06512360	YB12AL-A	0681236	ESB12AL-A■	—	—
250	Atlantic	2004/2006	06512400	YB12AL-A2	0681240	ESB12AL-A2■	—	—
250	Atlantic IE / Atlantic IE E3	2006/2009	06512360	YB12AL-A	0681236	ESB12AL-A■	—	—

▲ - Factory Sealed / Attivata dalla Fabbrica ■ - con Acido a corredo ◇ - Non di produzione YUASA a completamento gamma

Marca / Cilindrata / Modello / Anno			Cod. SGR		Cod. SGR		Cod. SGR		
APRILIA									
250	Atlantic IE / Atlantic IE E3	2006/2009	06512400	YB12AL-A2	0681240	ESB12AL-A2■	—	—	
250	Leonardo / Leonardo ST	1999/2001	06512360	YB12AL-A	0681236	ESB12AL-A■	—	—	
250	Leonardo / Leonardo ST	1999/2001	06512400	YB12AL-A2	0681240	ESB12AL-A2■	—	—	
250	RS	1995/2003	06504340	YB4L-B	—	—	—	—	
250	RS	1995/2003	065043410	YB4L-B■	0680434	ESB4L-B■	—	—	
250	Scarabeo / Scarabeo GT	2004/2006	06512360	YB12AL-A	0681236	ESB12AL-A■	—	—	
250	Scarabeo / Scarabeo GT	2004/2006	06512400	YB12AL-A2	0681240	ESB12AL-A2■	—	—	
250	Scarabeo Light IE / E3	2006/2011	06512360	YB12AL-A	0681236	ESB12AL-A■	—	—	
250	Scarabeo Light IE / E3	2006/2011	06512400	YB12AL-A2	0681240	ESB12AL-A2■	—	—	
250	Sportcity Cube	2008/2010	0651090	YTX12-BS■	0681090	ESTX12-BS■	063109	FTX12-BS■	
250	Sportcity IE	2006/2008	0651100	YT12B-BS■	0681100	EST12B-BS■	—	—	
300	Atlantic (SPG00)	2010/2014	06512360	YB12AL-A	0681236	ESB12AL-A■	—	—	
300	Atlantic (SPG00)	2010/2014	06512400	YB12AL-A2	0681240	ESB12AL-A2■	—	—	
300	Leonardo ST	2004/2005	06512360	YB12AL-A	0681236	ESB12AL-A■	—	—	
300	Leonardo ST	2004/2005	06512400	YB12AL-A2	0681240	ESB12AL-A2■	—	—	
300	Scarabeo Light / Special	2009/2013	0651090	YTX12-BS■	0681090	ESTX12-BS■	063109	FTX12-BS■	
300	Sportcity Cube/ Street	2008/2013	0651090	YTX12-BS■	0681090	ESTX12-BS■	063109	FTX12-BS■	
300	SR MAX	2011/2016	0651090	YTX12-BS■	0681090	ESTX12-BS■	063109	FTX12-BS■	
350	ETX	1986/1992	0650634	12N5.5-3B	0680634	ES12N5.5-3B■	—	—	
350	ETX	1986/1992	065123	YTX14AHL-BS■	—	—	—	—	
350	ETX	1986/1992	0651434	YB14L-A2	0681434	ESB14L-A2■	—	—	
350	ETX Tuareg	1986/1992	0650634	12N5.5-3B	0680634	ES12N5.5-3B■	—	—	
350	ETX Tuareg	1986/1992	065123	YTX14AHL-BS■	—	—	—	—	
350	ETX Tuareg	1986/1992	0651434	YB14L-A2	0681434	ESB14L-A2■	—	—	
350	Tuareg Wind	1987/1992	065123	YTX14AHL-BS■	—	—	—	—	
350	Tuareg Wind	1987/1992	0651434	YB14L-A2	0681434	ESB14L-A2■	—	—	
400	Atlantic Sprint	2005/2008	0651090	YTX12-BS■	0681090	ESTX12-BS■	063109	FTX12-BS■	
400	Scarabeo Light	2006/2008	0651090	YTX12-BS■	0681090	ESTX12-BS■	063109	FTX12-BS■	
450	RXV	2005/2007	065010	YTZ10S▲	—	—	063010	FTZ10S▲	
450	RXV	2005/2007	065910	TTZ10S-BS	068910	ESTTZ10S-BS■	—	—	
450	RXV	2005/2014	0650700	YTX7A-BS■	068070	ESTX7A-BS■	—	—	
450	SXV	2005/2007	065010	YTZ10S▲	—	—	063010	FTZ10S▲	
450	SXV	2005/2007	065910	TTZ10S-BS	068910	ESTTZ10S-BS■	—	—	
450	SXV	2005/2014	0650700	YTX7A-BS■	068070	ESTX7A-BS■	—	—	
450	SXV VDB Replica	2008/2008	065010	YTZ10S▲	—	—	063010	FTZ10S▲	
450	SXV VDB Replica	2008/2008	065910	TTZ10S-BS	068910	ESTTZ10S-BS■	—	—	
500	Atlantic	2001/2004	065123	YTX14AHL-BS■	—	—	—	—	
500	Atlantic	2001/2004	0651434	YB14L-A2	0681434	ESB14L-A2■	—	—	
500	Atlantic Sprint	2005/2008	0651090	YTX12-BS■	0681090	ESTX12-BS■	063109	FTX12-BS■	
500	Scarabeo	2002/2006	065123	YTX14AHL-BS■	—	—	—	—	
500	Scarabeo	2002/2006	0651434	YB14L-A2	0681434	ESB14L-A2■	—	—	

▲ - Factory Sealed / Attivata dalla Fabbrica ■ - con Acido a corredo ◇ - Non di produzione YUASA a completamento gamma

Marca / Cilindrata / Modello / Anno		Cod. SGR		Cod. SGR		Cod. SGR		
APRILIA								
500	Scarabeo IE Light	2006/2013	0651090	YTX12-BS■	0681090	ESTX12-BS■	063109	FTX12-BS■
550	RXV	2005/2007	065010	YTZ10S▲	—	—	063010	FTZ10S▲
550	RXV	2005/2007	065910	TTZ10S-BS	068910	ESTTZ10S-BS■	—	—
550	RXV	2005/2014	0650700	YTX7A-BS■	068070	ESTX7A-BS■	—	—
550	SXV	2005/2007	065010	YTZ10S▲	—	—	063010	FTZ10S▲
550	SXV	2005/2007	065910	TTZ10S-BS	068910	ESTTZ10S-BS■	—	—
550	SXV	2005/2014	0650700	YTX7A-BS■	068070	ESTX7A-BS■	—	—
550	SXV VDB Replica	2008/2008	065010	YTZ10S▲	—	—	063010	FTZ10S▲
550	SXV VDB Replica	2008/2008	065910	TTZ10S-BS	068910	ESTTZ10S-BS■	—	—
600	ETX Tuareg	1986/1992	0650634	12N5.5-3B	0680634	ES12N5.5-3B■	—	—
600	ETX Tuareg	1986/1992	065123	YTX14AHL-BS■	—	—	—	—
600	ETX Tuareg	1986/1992	0651434	YB14L-A2	0681434	ESB14L-A2■	—	—
600	Pegaso	1990/1992	065123	YTX14AHL-BS■	—	—	—	—
600	Pegaso	1990/1992	0651434	YB14L-A2	0681434	ESB14L-A2■	—	—
600	Tuareg Wind	1987/1992	065123	YTX14AHL-BS■	—	—	—	—
600	Tuareg Wind	1987/1992	0651434	YB14L-A2	0681434	ESB14L-A2■	—	—
650	Pegaso / Cube / IE	1992/1996	065123	YTX14AHL-BS■	—	—	—	—
650	Pegaso / Cube / IE	1992/1996	0651434	YB14L-A2	0681434	ESB14L-A2■	—	—
650	Pegaso / Cube / IE	1997/2004	06512360	YB12AL-A	0681236	ESB12AL-A■	—	—
650	Pegaso / Cube / IE	1997/2004	06512400	YB12AL-A2	0681240	ESB12AL-A2■	—	—
650	Stark / Moto 6,5	1995/2000	065123	YTX14AHL-BS■	—	—	—	—
650	Stark / Moto 6,5	1995/2000	0651434	YB14L-A2	0681434	ESB14L-A2■	—	—
660	Pegaso Factory	2007/2011	0651090	YTX12-BS■	0681090	ESTX12-BS■	063109	FTX12-BS■
660	Pegaso Strada	2005/2011	0651090	YTX12-BS■	0681090	ESTX12-BS■	063109	FTX12-BS■
660	Pegaso Trail	2005/2008	0651090	YTX12-BS■	0681090	ESTX12-BS■	063109	FTX12-BS■
750	Dorsoduro (SMC00/ SM000/ SMA00)	2008/2016	065124	YTX14H-BS■	—	—	—	—
750	Dorsoduro (SMC00/ SM000/ SMA00)	2008/2016	065129	YTX14-BS■	068129	ESTX14-BS■	—	—
750	Dorsoduro Factory (SMB00)	2010/2013	065124	YTX14H-BS■	—	—	—	—
750	Dorsoduro Factory (SMB00)	2010/2013	065129	YTX14-BS■	068129	ESTX14-BS■	—	—
750	Dorsoduro Factory ABS (SMB01)	2010/2013	0651090	YTX12-BS■	0681090	ESTX12-BS■	063109	FTX12-BS■
750	Shiver (RA000/ RAC00/ RAE00/ RAG00)	2007/2009	065124	YTX14H-BS■	—	—	—	—
750	Shiver (RA000/ RAC00/ RAE00/ RAG00)	2007/2009	065129	YTX14-BS■	068129	ESTX14-BS■	—	—
750	Shiver (RA000/ RAC00/ RAE00/ RAG00)	2010/2016	0651090	YTX12-BS■	0681090	ESTX12-BS■	063109	FTX12-BS■
750	Shiver GT (RAB00/ RAD00)	2009/2009	0651090	YTX12-BS■	0681090	ESTX12-BS■	063109	FTX12-BS■
850	Mana / Mana GT	2007/2016	065124	YTX14H-BS■	—	—	—	—
850	Mana / Mana GT	2007/2016	065129	YTX14-BS■	068129	ESTX14-BS■	—	—
850	SRV / SRV ATC ABS (M55103/ M55104)	2012/2016	065124	YTX14H-BS■	—	—	—	—
850	SRV / SRV ATC ABS (M55103/ M55104)	2012/2016	065129	YTX14-BS■	068129	ESTX14-BS■	—	—
1000	ETV Caponord / ABS	2001/2011	065124	YTX14H-BS■	—	—	—	—
1000	ETV Caponord / ABS	2001/2011	065129	YTX14-BS■	068129	ESTX14-BS■	—	—
1000	ETV Caponord Rally Raid	2003/2008	065124	YTX14H-BS■	—	—	—	—

▲ - Factory Sealed / Attivata dalla Fabbrica ■ - con Acido a corredo ◇ - Non di produzione YUASA a completamento gamma

Marca / Cilindrata / Modello / Anno			Cod. SGR		Cod. SGR		Cod. SGR		
APRILIA									
1000	ETV Caponord Rally Raid	2003/2008	065129	YTX14-BS■	068129	ESTX14-BS■	—	—	
1000	RST Futura	2001/2004	0651090	YTX12-BS■	0681090	ESTX12-BS■	063109	FTX12-BS■	
1000	RSV (ME00/ RP00/ RP12)	1998/2000	065124	YTX14H-BS■	—	—	—	—	
1000	RSV (ME00/ RP00/ RP12)	1998/2000	065129	YTX14-BS■	068129	ESTX14-BS■	—	—	
1000	RSV (ME00/ RP00/ RP12)	2001/2003	0651090	YTX12-BS■	0681090	ESTX12-BS■	063109	FTX12-BS■	
1000	RSV 4 R (RKA00)	2009/2010	0651110	YT12A-BS■	0681110	EST12A-BS■	—	—	
1000	RSV 4 R APRC (RKE00/ RKE01/ RKH)	2011/2014	0651110	YT12A-BS■	0681110	EST12A-BS■	—	—	
1000	RSV 4 R Factory (RK000/ RK001/ RKC00)	2009/2010	0651110	YT12A-BS■	0681110	EST12A-BS■	—	—	
1000	RSV 4 R Factory APRC (RKB00/ RKB01/ RKG)	2011/2014	0651110	YT12A-BS■	0681110	EST12A-BS■	—	—	
1000	RSV 4 RF (RKL00)	2015/2016	0651110	YT12A-BS■	0681110	EST12A-BS■	—	—	
1000	RSV 4 RR	2015/2016	0651110	YT12A-BS■	0681110	EST12A-BS■	—	—	
1000	RSV R (MEA00/ RPA0/ RP012)	2000/2000	065124	YTX14H-BS■	—	—	—	—	
1000	RSV R (MEA00/ RPA0/ RP012)	2000/2000	065129	YTX14-BS■	068129	ESTX14-BS■	—	—	
1000	RSV R (MEA00/ RPA0/ RP012)	2001/2003	0651090	YTX12-BS■	0681090	ESTX12-BS■	063109	FTX12-BS■	
1000	RSV R (RR00)	2004/2009	0651090	YTX12-BS■	0681090	ESTX12-BS■	063109	FTX12-BS■	
1000	RSV R Factory (RRK0)	2004/2009	0651090	YTX12-BS■	0681090	ESTX12-BS■	063109	FTX12-BS■	
1000	RSV R Tuono (RPB00)	2002/2005	0651090	YTX12-BS■	0681090	ESTX12-BS■	063109	FTX12-BS■	
1000	RSV R Tuono (RRL00)	2006/2011	0651090	YTX12-BS■	0681090	ESTX12-BS■	063109	FTX12-BS■	
1000	RSV R Tuono Factory (RRM00)	2006/2011	0651090	YTX12-BS■	0681090	ESTX12-BS■	063109	FTX12-BS■	
1000	RSV R Tuono Racing / Factory (RPB06/ RPB09)	2003/2005	0651090	YTX12-BS■	0681090	ESTX12-BS■	063109	FTX12-BS■	
1000	RSV SP (MED0)	1999/2000	0651090	YTX12-BS■	0681090	ESTX12-BS■	063109	FTX12-BS■	
1000	SL Falco	1998/2003	065124	YTX14H-BS■	—	—	—	—	
1000	SL Falco	1998/2003	065129	YTX14-BS■	068129	ESTX14-BS■	—	—	
1000	Tuono V4 R - APRC	2011/2014	0651110	YT12A-BS■	0681110	EST12A-BS■	—	—	
1100	Tuono V4 Factory (TYH00)	2015/2016	0651110	YT12A-BS■	0681110	EST12A-BS■	—	—	
1100	Tuono V4 RR (TYG00)	2015/2016	0651110	YT12A-BS■	0681110	EST12A-BS■	—	—	
1200	Caponord / ABS (ZD4VK/ ZD4VKA)	2013/2016	065124	YTX14H-BS■	—	—	—	—	
1200	Caponord / ABS (ZD4VK/ ZD4VKA)	2013/2016	065129	YTX14-BS■	068129	ESTX14-BS■	—	—	
1200	Caponord Rally (VKB000/ VKB001)	2015/2016	065124	YTX14H-BS■	—	—	—	—	
1200	Caponord Rally (VKB000/ VKB001)	2015/2016	065129	YTX14-BS■	068129	ESTX14-BS■	—	—	
1200	Dorsoduro / ABS (TV000/ TV001/ TVA00/ TVA01)	2011/2016	065124	YTX14H-BS■	—	—	—	—	
1200	Dorsoduro / ABS (TV000/ TV001/ TVA00/ TVA01)	2011/2016	065129	YTX14-BS■	068129	ESTX14-BS■	—	—	
ARCTIC CAT									
250	2x4	1999/2005	065123	YTX14AHL-BS■	—	—	—	—	
250	4x4	1999/2005	065123	YTX14AHL-BS■	—	—	—	—	
250	DVX	2006/2009	0651090	YTX12-BS■	0681090	ESTX12-BS■	063109	FTX12-BS■	
300	2x4	1998/2003	065123	YTX14AHL-BS■	—	—	—	—	
300	4x4	1998/2005	065123	YTX14AHL-BS■	—	—	—	—	
300	DVX	2009/2009	065123	YTX14AHL-BS■	—	—	—	—	
366	4X4 Automatic/ FIS	2008/2009	065122	YTX14AH-BS■	068122	ESTX14AH-BS■	—	—	
400	4x4	2004/2008	065122	YTX14AH-BS■	068122	ESTX14AH-BS■	—	—	

▲ - Factory Sealed / Attivata dalla Fabbrica ■ - con Acido a corredo ◇ - Non di produzione YUASA a completamento gamma

Marca / Cilindrata / Modello / Anno

Cod.
SGR



Cod.
SGR



Cod.
SGR



ARCTIC CAT

400	Ai 2x4 (FIS)	2002/>	065122	YTX14AH-BS■	068122	ESTX14AH-BS■	—	—
400	Bear Cat 2x4	1998/2004	065122	YTX14AH-BS■	068122	ESTX14AH-BS■	—	—
400	Bear Cat 4x4	1998/2004	065122	YTX14AH-BS■	068122	ESTX14AH-BS■	—	—
400	DVX	2004/2008	0650990	YTX9-BS■	068099	ESTX9-BS■	063099	FTX9-BS■
400	DVX TS	2006/2007	0650990	YTX9-BS■	068099	ESTX9-BS■	063099	FTX9-BS■
400	TBX 4x4	2004/2006	065122	YTX14AH-BS■	068122	ESTX14AH-BS■	—	—
400	TRV 4x4	2009/2010	065122	YTX14AH-BS■	068122	ESTX14AH-BS■	—	—
500	2x4	1999/2003	065122	YTX14AH-BS■	068122	ESTX14AH-BS■	—	—
500	4x4	1999/2009	065122	YTX14AH-BS■	068122	ESTX14AH-BS■	—	—
500	Ai 2x4 (FIS)	2002/2003	065122	YTX14AH-BS■	068122	ESTX14AH-BS■	—	—
500	Ai 4x4 (FIS)	2002/2003	065122	YTX14AH-BS■	068122	ESTX14AH-BS■	—	—
500	TBX iA 4x4	2002/2006	065122	YTX14AH-BS■	068122	ESTX14AH-BS■	—	—
550	XT Prowler 4x4	2010/2010	065215	YTX24HL-BS■	—	—	—	—
650	H1 4X4	2005/2010	065122	YTX14AH-BS■	068122	ESTX14AH-BS■	—	—
650	TBX	2010/2010	065122	YTX14AH-BS■	068122	ESTX14AH-BS■	—	—
650	V2 4X4 Aut.	2005/2005	065122	YTX14AH-BS■	068122	ESTX14AH-BS■	—	—
650	XT Prowler 4x4	2006/2010	065215	YTX24HL-BS■	—	—	—	—
700	H1 EFI 4x4	2008/2009	065122	YTX14AH-BS■	068122	ESTX14AH-BS■	—	—
700	H1 EFI Automatic	2008/2009	065122	YTX14AH-BS■	068122	ESTX14AH-BS■	—	—
700	H1 EFI Automatic MUD PRO	2009/2009	065122	YTX14AH-BS■	068122	ESTX14AH-BS■	—	—
700	H1 EFI LE	2008/2009	065122	YTX14AH-BS■	068122	ESTX14AH-BS■	—	—
700	H1 EFI M4	2008/2009	065122	YTX14AH-BS■	068122	ESTX14AH-BS■	—	—
700	H1 EFI SE	2008/2009	065122	YTX14AH-BS■	068122	ESTX14AH-BS■	—	—
700	TRV Cruiser	2009/2010	065122	YTX14AH-BS■	068122	ESTX14AH-BS■	—	—
700	XT Prowler 4x4	2010/2010	065215	YTX24HL-BS■	—	—	—	—
700	XTX Prowler 4x4	2010/2010	065215	YTX24HL-BS■	—	—	—	—
700	XTX Prowler H1 Automatic 4x4	2010/2010	065215	YTX24HL-BS■	—	—	—	—
1000	ATV TRV / Cruiser	2009/2009	065215	YTX24HL-BS■	—	—	—	—
1000	Thundercat	2010/2010	065122	YTX14AH-BS■	068122	ESTX14AH-BS■	—	—
1000	XT Prowler 4x4	2010/2010	065275	YIX30L▲	—	—	—	—
-	Tutti i modelli di Carburatore 500cc & Oltre	1991/2001	0650201	GYZ20H▲	—	—	—	—
-	Tutti i modelli di Carburatore 500cc & Oltre	1991/2001	065184	YTX20H-BS■	—	—	—	—
-	Tutti i modelli di EFI 500cc & Oltre	1991/2001	065215	YTX24HL-BS■	—	—	—	—
-	Tutti i modelli di EFI 500cc & Oltre senza Electric Start	1991/1993	065123	YTX14AHL-BS■	—	—	—	—
-	Tutti i modelli inferiori ai 500cc	1993/1993	065123	YTX14AHL-BS■	—	—	—	—

ASPES

125	Yuma	1976/>	0650735	12N7-4B	—	—	—	—
-----	------	--------	----------------	---------	---	---	---	---

BAJAJ

200	Pulsar NS	2012/2013	0650990	YTX9-BS■	068099	ESTX9-BS■	063099	FTX9-BS■
-----	-----------	-----------	----------------	----------	---------------	-----------	---------------	----------

▲ - Factory Sealed / Attivata dalla Fabbrica ■ - con Acido a corredo ◇ - Non di produzione YUASA a completamento gamma

BAOTIAN								
50	BT49QT-11 Tommy (Retro')	TUTTI	0650700	YTX7A-BS ■	068070	ESTX7A-BS ■	—	—
50	BT49QT-12C1 Rebel 4T R12	2006/2008	0650700	YTX7A-BS ■	068070	ESTX7A-BS ■	—	—
50	BT49QT-12D1 Hero 4T R12	2006/2008	0650700	YTX7A-BS ■	068070	ESTX7A-BS ■	—	—
50	BT49QT-12E/ 1/ 2/ 3 Rocky 4T R12	2006/2008	0650700	YTX7A-BS ■	068070	ESTX7A-BS ■	—	—
50	BT49QT-12F1 Tanco 4T R12	2007/2008	0650700	YTX7A-BS ■	068070	ESTX7A-BS ■	—	—
50	BT49QT-2 Big Panther 4T R10	2006/2007	0650700	YTX7A-BS ■	068070	ESTX7A-BS ■	—	—
50	BT49QT-2 Big Panther 4T R12	2006/2007	0650700	YTX7A-BS ■	068070	ESTX7A-BS ■	—	—
50	BT49QT-7 A1 Smart Rider 4T	2005/2007	0650700	YTX7A-BS ■	068070	ESTX7A-BS ■	—	—
50	BT49QT-7 Chase (A1)	2005/2007	0650700	YTX7A-BS ■	068070	ESTX7A-BS ■	—	—
50	BT49QT-7A1/ B1 4T R10/ 12	TUTTI	0650700	YTX7A-BS ■	068070	ESTX7A-BS ■	—	—
50	BT49QT-7A2/ A3 4T R12	TUTTI	065049	YTX5L-BS ■	068049	ESTX5L-BS ■	063049	FTX5L-BS ■
50	BT49QT-7B2/ B3 4T R12	TUTTI	065049	YTX5L-BS ■	068049	ESTX5L-BS ■	063049	FTX5L-BS ■
50	BT49QT-9 Scout 4T R12	TUTTI	0650534	YB5L-B	0680534	ESB5L-B ■	—	—
50	BT49QT-9D1/ D2 4T R10	TUTTI	065049	YTX5L-BS ■	068049	ESTX5L-BS ■	063049	FTX5L-BS ■
50	BT50QT-11 4T (GY6139QMB) [139QMB]	TUTTI	065049	YTX5L-BS ■	068049	ESTX5L-BS ■	063049	FTX5L-BS ■
50	BT50QT-11 4T Tommy	TUTTI	065049	YTX5L-BS ■	068049	ESTX5L-BS ■	063049	FTX5L-BS ■
50	BT50QT-12 4T Rebel	TUTTI	065049	YTX5L-BS ■	068049	ESTX5L-BS ■	063049	FTX5L-BS ■
50	BT50QT-12 4T Tanco	TUTTI	065049	YTX5L-BS ■	068049	ESTX5L-BS ■	063049	FTX5L-BS ■
50	BT50QT-7 4T	2007/2007	065049	YTX5L-BS ■	068049	ESTX5L-BS ■	063049	FTX5L-BS ■
50	BT50QT-7 4T (Chase)	TUTTI	065049	YTX5L-BS ■	068049	ESTX5L-BS ■	063049	FTX5L-BS ■
50	BT50QT-9 4T Scout R10	2006/2008	0650534	YB5L-B	0680534	ESB5L-B ■	—	—
125	BT125T-2 Glow	TUTTI	0650700	YTX7A-BS ■	068070	ESTX7A-BS ■	—	—
125	BT125T-7 Hawk	TUTTI	0650700	YTX7A-BS ■	068070	ESTX7A-BS ■	—	—



BENELLI								
50	491 GT/ Ssport/ Racing	1997/1999	06504340	YB4L-B	—	—	—	—
50	491 GT/ Ssport/ Racing	1997/1999	065043410	YB4L-B ■	0680434	ESB4L-B ■	—	—
50	49X	2007/2008	06504340	YB4L-B	—	—	—	—
50	49X	2007/2008	065043410	YB4L-B ■	0680434	ESB4L-B ■	—	—
50	Devil	1992/1992	06504340	YB4L-B	—	—	—	—
50	Devil	1992/1992	065043410	YB4L-B ■	0680434	ESB4L-B ■	—	—
50	K2/ K2 Lc	1998/1999	06504340	YB4L-B	—	—	—	—
50	K2/ K2 Lc	1998/1999	065043410	YB4L-B ■	0680434	ESB4L-B ■	—	—
50	KBX Race	TUTTI	06504340	YB4L-B	—	—	—	—
50	KBX Race	TUTTI	065043410	YB4L-B ■	0680434	ESB4L-B ■	—	—
50	Pepe / Pepe LX	1999/2000	06504340	YB4L-B	—	—	—	—
50	Pepe / Pepe LX	1999/2000	065043410	YB4L-B ■	0680434	ESB4L-B ■	—	—
50	Scooty LX/ DLX	TUTTI	06504340	YB4L-B	—	—	—	—
50	Scooty LX/ DLX	TUTTI	065043410	YB4L-B ■	0680434	ESB4L-B ■	—	—
100	K2	1999/2001	0650534	YB5L-B	0680534	ESB5L-B ■	—	—
125	2C 2T	1976/1978	0601112	6N11A-1B	—	—	—	—
125	2C Sport 2T	1976/>	0601112	6N11A-1B	—	—	—	—

▲ - Factory Sealed / Attivata dalla Fabbrica ■ - con Acido a corredo ◇ - Non di produzione YUASA a completamento gamma



BENELLI



125	Adiva	2001/2002	065124	YTX14H-BS■	—	—	—	—
125	Adiva	2001/2002	065129	YTX14-BS■	068129	ESTX14-BS■	—	—
125	Cross	1972/1972	0601112	6N11A-1B	—	—	—	—
125	Custom	1985/1985	0650636	12N5.5-4A	—	—	—	—
125	Macis	2010/2011	06509350	YB9-B	0680935	ESB9-B■	—	—
125	Macis	2012/2013	0650990	YTX9-BS■	068099	ESTX9-BS■	063099	FTX9-BS■
125	Velvet/ Velvet Touring	1999/2012	0650990	YTX9-BS■	068099	ESTX9-BS■	063099	FTX9-BS■
150	Adiva	2001/2002	065124	YTX14H-BS■	—	—	—	—
150	Adiva	2001/2002	065129	YTX14-BS■	068129	ESTX14-BS■	—	—
150	Macis	2012/2013	06509350	YB9-B	0680935	ESB9-B■	—	—
150	Macis	2012/2013	0650990	YTX9-BS■	068099	ESTX9-BS■	063099	FTX9-BS■
150	Velvet/ Velvet Touring	1999/2012	0650990	YTX9-BS■	068099	ESTX9-BS■	063099	FTX9-BS■
250	Caffè Nero	2008/2012	0650990	YTX9-BS■	068099	ESTX9-BS■	063099	FTX9-BS■
250	Caffè Nero	2013/2014	065014	YTZ14S▲	—	—	—	—
250	Caffè Nero	2013/2014	065914	TTZ14S-BS	068914	ESTTZ14S-BS■	—	—
250	Velvet/ Velvet Touring	1999/2003	0651090	YTX12-BS■	0681090	ESTX12-BS■	063109	FTX12-BS■
300	BN302	2014/2016	065014	YTZ14S▲	—	—	—	—
300	BN302	2014/2016	065914	TTZ14S-BS	068914	ESTTZ14S-BS■	—	—
350	Zenzero	2012/2013	0651090	YTX12-BS■	0681090	ESTX12-BS■	063109	FTX12-BS■
600	B	2014/2016	065014	YTZ14S▲	—	—	—	—
600	B	2014/2016	065914	TTZ14S-BS	068914	ESTTZ14S-BS■	—	—
600	B GT	2015/2016	065014	YTZ14S▲	—	—	—	—
600	B GT	2015/2016	065914	TTZ14S-BS	068914	ESTTZ14S-BS■	—	—
600	B R	2014/2014	065014	YTZ14S▲	—	—	—	—
600	B R	2014/2014	065914	TTZ14S-BS	068914	ESTTZ14S-BS■	—	—
899	Century Racer	2010/2011	065014	YTZ14S▲	—	—	—	—
899	Century Racer	2010/2011	065914	TTZ14S-BS	068914	ESTTZ14S-BS■	—	—
899	TNT	2007/2011	065014	YTZ14S▲	—	—	—	—
899	TNT	2007/2011	065914	TTZ14S-BS	068914	ESTTZ14S-BS■	—	—
899	Tre K	2007/2011	065014	YTZ14S▲	—	—	—	—
899	Tre K	2007/2011	065914	TTZ14S-BS	068914	ESTTZ14S-BS■	—	—
900	Tornado Tre LE, RS	2000/2003	0651110	YT12A-BS■	0681110	EST12A-BS■	—	—
1130	TNT	2005/2006	065014	YTZ14S▲	—	—	—	—
1130	TNT	2005/2006	065914	TTZ14S-BS	068914	ESTTZ14S-BS■	—	—
1130	TNT Cafè racer	2005/2008	065014	YTZ14S▲	—	—	—	—
1130	TNT Cafè racer	2005/2008	065914	TTZ14S-BS	068914	ESTTZ14S-BS■	—	—
1130	TNT Sport	2005/2008	065014	YTZ14S▲	—	—	—	—
1130	TNT Sport	2005/2008	065914	TTZ14S-BS	068914	ESTTZ14S-BS■	—	—
1130	TNT Titanium	2005/2008	065014	YTZ14S▲	—	—	—	—
1130	TNT Titanium	2005/2008	065914	TTZ14S-BS	068914	ESTTZ14S-BS■	—	—
1130	Tornado Tre	2007/2008	065014	YTZ14S▲	—	—	—	—

Marca / Cilindrata / Modello / Anno			Cod. SGR		Cod. SGR		Cod. SGR		
BENELLI									
1130	Tornado Tre	2007/2008	065914	TTZ14S-BS	068914	ESTTZ14S-BS■	—	—	
1130	Tre K	2006/2011	065014	YTZ14S▲	—	—	—	—	
1130	Tre K	2006/2011	065914	TTZ14S-BS	068914	ESTTZ14S-BS■	—	—	
1130	Tre K Amazonas	2007/2011	065014	YTZ14S▲	—	—	—	—	
1130	Tre K Amazonas	2007/2011	065914	TTZ14S-BS	068914	ESTTZ14S-BS■	—	—	
BENZHO									
50	YY50QT 4T	2007/2008	0650390	YTX4L-BS■	068039	ESTX4L-BS■	—	—	
50	YY50QT-6A 4T	2007/2008	0650390	YTX4L-BS■	068039	ESTX4L-BS■	—	—	
BETAMOTOR									
50	Adventure	TUTTI	06504340	YB4L-B	—	—	—	—	
50	Adventure	TUTTI	065043410	YB4L-B■	0680434	ESB4L-B■	—	—	
50	ARK/ ARK LC DD/ DT	1996/1999	06504340	YB4L-B	—	—	—	—	
50	ARK/ ARK LC DD/ DT	1996/1999	065043410	YB4L-B■	0680434	ESB4L-B■	—	—	
50	Chrono	1996/1999	06504340	YB4L-B	—	—	—	—	
50	Chrono	1996/1999	065043410	YB4L-B■	0680434	ESB4L-B■	—	—	
50	Eikon	1999/2003	06504340	YB4L-B	—	—	—	—	
50	Eikon	1999/2003	065043410	YB4L-B■	0680434	ESB4L-B■	—	—	
50	Quadra	1996/1999	06504340	YB4L-B	—	—	—	—	
50	Quadra	1996/1999	065043410	YB4L-B■	0680434	ESB4L-B■	—	—	
50	Tempo 13	1994/1995	06504340	YB4L-B	—	—	—	—	
50	Tempo 13	1994/1995	065043410	YB4L-B■	0680434	ESB4L-B■	—	—	
50	Tempo 16	1996/1999	06504340	YB4L-B	—	—	—	—	
50	Tempo 16	1996/1999	065043410	YB4L-B■	0680434	ESB4L-B■	—	—	
125	Alp 4T	2008/2010	065049	YTX5L-BS■	068049	ESTX5L-BS■	063049	FTX5L-BS■	
125	Eikon	2000/2002	0650990	YTX9-BS■	068099	ESTX9-BS■	063099	FTX9-BS■	
125	RR 4T	2006/2010	065049	YTX5L-BS■	068049	ESTX5L-BS■	063049	FTX5L-BS■	
125	RR 4T SM	2006/2010	065049	YTX5L-BS■	068049	ESTX5L-BS■	063049	FTX5L-BS■	
125	Urban 4T	2008/2010	065049	YTX5L-BS■	068049	ESTX5L-BS■	063049	FTX5L-BS■	
150	Eikon	2000/2002	0650990	YTX9-BS■	068099	ESTX9-BS■	063099	FTX9-BS■	
200	Alp 4T	2003/2007	0650690	YTX7L-BS■	068069	ESTX7L-BS■	063069	FTX7L-BS■	
200	Alp 4T	2008/2010	065049	YTX5L-BS■	068049	ESTX5L-BS■	063049	FTX5L-BS■	
200	Urban 4T	2008/2009	065049	YTX5L-BS■	068049	ESTX5L-BS■	063049	FTX5L-BS■	
250	RR EN (Mot.KTM)	2005/2007	065049	YTX5L-BS■	068049	ESTX5L-BS■	063049	FTX5L-BS■	
250	RR Enduro 2T (Mot.BETA)	2013/2015	065049	YTX5L-BS■	068049	ESTX5L-BS■	063049	FTX5L-BS■	
250	RR SM (Mot.KTM)	2005/2007	065049	YTX5L-BS■	068049	ESTX5L-BS■	063049	FTX5L-BS■	
300	RR Enduro 2T (Mot.BETA)	2013/2015	065049	YTX5L-BS■	068049	ESTX5L-BS■	063049	FTX5L-BS■	
350	ALP 4.0 4T	2003/2008	0650690	YTX7L-BS■	068069	ESTX7L-BS■	063069	FTX7L-BS■	
350	Euro	2001/2002	0650990	YTX9-BS■	068099	ESTX9-BS■	063099	FTX9-BS■	
350	Jonathan	2001/2002	0650990	YTX9-BS■	068099	ESTX9-BS■	063099	FTX9-BS■	
350	M4 4T	2003/2008	0650690	YTX7L-BS■	068069	ESTX7L-BS■	063069	FTX7L-BS■	
350	RR Enduro (Mot.BETA)	2011/2014	065049	YTX5L-BS■	068049	ESTX5L-BS■	063049	FTX5L-BS■	



▲ - Factory Sealed / Attivata dalla Fabbrica ■ - con Acido a corredo ◇ - Non di produzione YUASA a completamento gamma

Marca / Cilindrata / Modello / Anno			Cod. SGR		Cod. SGR		Cod. SGR		
BETAMOTOR									
400 RR EN (Mot.KTM)	2005/2010	065049	YTX5L-BS■	068049	ESTX5L-BS■	063049	FTX5L-BS■		
400 RR Enduro (Mot.BETA)	2010/2014	065049	YTX5L-BS■	068049	ESTX5L-BS■	063049	FTX5L-BS■		
400 RR SM (Mot.KTM)	2005/2010	065049	YTX5L-BS■	068049	ESTX5L-BS■	063049	FTX5L-BS■		
450 RR EN (Mot.KTM)	2005/2010	065049	YTX5L-BS■	068049	ESTX5L-BS■	063049	FTX5L-BS■		
450 RR Enduro (Mot.BETA)	2010/2014	065049	YTX5L-BS■	068049	ESTX5L-BS■	063049	FTX5L-BS■		
450 RR SM (Mot.KTM)	2005/2010	065049	YTX5L-BS■	068049	ESTX5L-BS■	063049	FTX5L-BS■		
498 RR Enduro (Mot.BETA)	2012/2014	065049	YTX5L-BS■	068049	ESTX5L-BS■	063049	FTX5L-BS■		
520 RR Enduro (Mot.BETA)	2010/2011	065049	YTX5L-BS■	068049	ESTX5L-BS■	063049	FTX5L-BS■		
525 RR EN (Mot.KTM)	2005/2010	065049	YTX5L-BS■	068049	ESTX5L-BS■	063049	FTX5L-BS■		
525 RR SM (Mot.KTM)	2005/2010	065049	YTX5L-BS■	068049	ESTX5L-BS■	063049	FTX5L-BS■		
BIMOTA									
1000 SB8R	1999/2000	0651090	YTX12-BS■	0681090	ESTX12-BS■	063109	FTX12-BS■		
1000 YB11	1996/1999	0651090	YTX12-BS■	0681090	ESTX12-BS■	063109	FTX12-BS■		
BMW									
125 C1	2000/2003	065123	YTX14AHL-BS■	—	—	—	—		
125 C1	2000/2003	0651434	YB14L-A2	0681434	ESB14L-A2■	—	—		
200 C1	2000/2003	065123	YTX14AHL-BS■	—	—	—	—		
200 C1	2000/2003	0651434	YB14L-A2	0681434	ESB14L-A2■	—	—		
250 R 25/ 2	1951/1954	0600833	B49-6	—	—	—	—		
250 R 27	1960/1966	0660810	3S4 ◇▲	—	—	—	—		
260 R 26	1956/1960	0600715	B39-6	—	—	—	—		
310 G GS	2017/2017	0650990	YTX9-BS■	068099	ESTX9-BS■	063099	FTX9-BS■		
310 G R (K03)	2017/2017	0650990	YTX9-BS■	068099	ESTX9-BS■	063099	FTX9-BS■		
450 G SMR	2009/2010	065007	YTZ7S▲	—	—	063007	FTZ7S▲		
450 G SMR	2009/2010	065907	TTZ7S▲	068907	ESTTZ7S-BS■	—	—		
450 G X	2008/2012	065007	YTZ7S▲	—	—	063007	FTZ7S▲		
450 G X	2008/2012	065907	TTZ7S▲	068907	ESTTZ7S-BS■	—	—		
450 R 45-20kw / R 45-26kw N/ T	1975/1985	0652015	52015	—	—	—	—		
500 R 50	1955/1960	0660810	3S4 ◇▲	—	—	—	—		
500 R 50	1955/1960	0652015	52015	—	—	—	—		
500 R 50 S	1960/1962	0652015	52015	—	—	—	—		
500 R 50/ 2	1961/1969	0652015	52015	—	—	—	—		
500 R 50/ 5	1969/1973	0652015	52015	—	—	—	—		
500 R 51	1938/1940	0600833	B49-6	—	—	—	—		
500 R 51/ 2	1950/1950	0600833	B49-6	—	—	—	—		
500 R 51/ 3	1950/1954	0600833	B49-6	—	—	—	—		
600 C Sport (K18)	2012/2015	065124	YTX14H-BS■	—	—	—	—		
600 C Sport (K18)	2012/2015	065129	YTX14-BS■	068129	ESTX14-BS■	—	—		
600 C Sport (K18)	2012/2012	065014	YTZ14S▲	—	—	—	—		
600 C Sport (K18)	2012/2012	065914	TTZ14S-BS	068914	ESTTZ14S-BS■	—	—		
600 R 60 LS	TUTTI	0652015	52015	—	—	—	—		



▲ - Factory Sealed / Attivata dalla Fabbrica ■ - con Acido a corredo ◇ - Non di produzione YUASA a completamento gamma

Marca / Cilindrata / Modello / Anno			Cod. SGR		Cod. SGR		Cod. SGR		
BMW									
600	R 60 R / R 60 S	TUTTI	0601433	B38-6A	—	—	—	—	
600	R 60 R / R 60 S	TUTTI	0661433	3R3 ◇▲	—	—	—	—	
600	R 60 / 5	1969/1973	0652015	52015	—	—	—	—	
600	R 60 / 6	1973/1976	0652015	52015	—	—	—	—	
600	R 60 / 7	1977/1978	0652015	52015	—	—	—	—	
650	C GT (K19)	2012/2015	065124	YTX14H-BS■	—	—	—	—	
650	C GT (K19)	2012/2015	065129	YTX14-BS■	068129	ESTX14-BS■	—	—	
650	F / ST strada / Funduro (E169)	1993/2000	06512360	YB12AL-A	0681236	ESB12AL-A■	—	—	
650	F / ST strada / Funduro (E169)	1993/2000	06512400	YB12AL-A2	0681240	ESB12AL-A2■	—	—	
650	F CS Scarver (K14)	2002/2005	06512360	YB12AL-A	0681236	ESB12AL-A■	—	—	
650	F CS Scarver (K14)	2002/2005	06512400	YB12AL-A2	0681240	ESB12AL-A2■	—	—	
650	F GS (K72)	2009/2012	065124	YTX14H-BS■	—	—	—	—	
650	F GS (K72)	2009/2012	065129	YTX14-BS■	068129	ESTX14-BS■	—	—	
650	F GS (K72)	2008/2008	065124	YTX14H-BS■	—	—	—	—	
650	F GS (K72)	2008/2008	065129	YTX14-BS■	068129	ESTX14-BS■	—	—	
650	F GS / Dakar (R13)	2001/2007	06512360	YB12AL-A	0681236	ESB12AL-A■	—	—	
650	F GS / Dakar (R13)	2001/2007	06512400	YB12AL-A2	0681240	ESB12AL-A2■	—	—	
650	G GS / Sertão (R13)	2008/2015	06512360	YB12AL-A	0681236	ESB12AL-A■	—	—	
650	G GS / Sertão (R13)	2008/2015	06512400	YB12AL-A2	0681240	ESB12AL-A2■	—	—	
650	G Xchallenge (K15)	2007/2011	065010	YTZ10S▲	—	—	063010	FTZ10S▲	
650	G Xchallenge (K15)	2007/2011	065910	TTZ10S-BS	068910	ESTTZ10S-BS■	—	—	
650	G Xcountry (K15)	2007/2011	065010	YTZ10S▲	—	—	063010	FTZ10S▲	
650	G Xcountry (K15)	2007/2011	065910	TTZ10S-BS	068910	ESTTZ10S-BS■	—	—	
650	G Xmoto (K15)	2007/2011	065010	YTZ10S▲	—	—	063010	FTZ10S▲	
650	G Xmoto (K15)	2007/2011	065910	TTZ10S-BS	068910	ESTTZ10S-BS■	—	—	
650	R 65	1978/1991	0652015	52015	—	—	—	—	
650	R 65 GS	1986/1991	0652015	52015	—	—	—	—	
650	R 65 LS	1982/1985	0652015	52015	—	—	—	—	
650	R 65 / 1	1986/1991	0652015	52015	—	—	—	—	
700	F GS (K70)	2012/2017	065124	YTX14H-BS■	—	—	—	—	
700	F GS (K70)	2012/2017	065129	YTX14-BS■	068129	ESTX14-BS■	—	—	
750	K 75	1983/1996	0652515	52515	—	—	—	—	
750	K 75 C	1985/1988	0652515	52515	—	—	—	—	
750	K 75 RT	1985/>	0652515	52515	—	—	—	—	
750	K 75 S	1986/1997	0652515	52515	—	—	—	—	
750	R 75 / 5	1971/1974	0652015	52015	—	—	—	—	
750	R 75 / 6	1974/1975	0653030	53030	06853030	ES60-N30L-B (53030)■	—	—	
750	R 75 / 7	1976/1977	0653030	53030	06853030	ES60-N30L-B (53030)■	—	—	
800	F GS (K72)	2009/2015	065124	YTX14H-BS■	—	—	—	—	
800	F GS (K72)	2009/2015	065129	YTX14-BS■	068129	ESTX14-BS■	—	—	
800	F GS (K72)	2006/2008	065124	YTX14H-BS■	—	—	—	—	



▲ - Factory Sealed / Attivata dalla Fabbrica ■ - con Acido a corredo ◇ - Non di produzione YUASA a completamento gamma

Marca / Cilindrata / Modello / Anno			Cod. SGR		Cod. SGR		Cod. SGR		
BMW									
800	F GS (K72)	2006/2008	065129	YTX14-BS■	068129	ESTX14-BS■	—	—	
800	F GS Adventure (K72)	2013/2017	065124	YTX14H-BS■	—	—	—	—	
800	F GS Adventure (K72)	2013/2017	065129	YTX14-BS■	068129	ESTX14-BS■	—	—	
800	F GT (K71)	2013/2017	065124	YTX14H-BS■	—	—	—	—	
800	F GT (K71)	2013/2017	065129	YTX14-BS■	068129	ESTX14-BS■	—	—	
800	F R (K73)	2009/2017	065124	YTX14H-BS■	—	—	—	—	
800	F R (K73)	2009/2017	065129	YTX14-BS■	068129	ESTX14-BS■	—	—	
800	F S / F ST (K71)	2006/2012	065124	YTX14H-BS■	—	—	—	—	
800	F S / F ST (K71)	2006/2012	065129	YTX14-BS■	068129	ESTX14-BS■	—	—	
800	R 80 ET	TUTTI	0653030	53030	06853030	ES60-N30L-B (53030)■	—	—	
800	R 80 GS	1977/1979	0652015	52015	—	—	—	—	
800	R 80 GS	1980/1987	0652015	52015	—	—	—	—	
800	R 80 GS Mystic	1991/1995	0652015	52015	—	—	—	—	
800	R 80 GS Paris Dakar	1988/1995	0652015	52015	—	—	—	—	
800	R 80 R	1980/>	0652515	52515	—	—	—	—	
800	R 80 RT	1977/1984	0653030	53030	06853030	ES60-N30L-B (53030)■	—	—	
800	R 80 ST	1980/1986	0652015	52015	—	—	—	—	
800	R 80 / 7	1977/1984	0653030	53030	06853030	ES60-N30L-B (53030)■	—	—	
850	R C Avantgarde	1999/2001	—	—	0681815	ESTX20-B4	—	—	
850	R C Avantgarde	1999/2001	065188	YT19BL-BS■	—	—	—	—	
850	R C Avantgarde	1999/2001	0651913	51913	06851913	ES12C16A-3A (51913)■	—	—	
850	R C Classic	1999/2001	—	—	0681815	ESTX20-B4	—	—	
850	R C Classic	1999/2001	065188	YT19BL-BS■	—	—	—	—	
850	R C Classic	1999/2001	0651913	51913	06851913	ES12C16A-3A (51913)■	—	—	
850	R C Independent	1999/2001	—	—	0681815	ESTX20-B4	—	—	
850	R C Independent	1999/2001	065188	YT19BL-BS■	—	—	—	—	
850	R C Independent	1999/2001	0651913	51913	06851913	ES12C16A-3A (51913)■	—	—	
850	R GS	1996/2002	—	—	0681815	ESTX20-B4	—	—	
850	R GS	1996/2002	065188	YT19BL-BS■	—	—	—	—	
850	R GS	1996/2002	0651913	51913	06851913	ES12C16A-3A (51913)■	—	—	
850	R R	1995/2007	—	—	0681815	ESTX20-B4	—	—	
850	R R	1995/2007	065188	YT19BL-BS■	—	—	—	—	
850	R R	1995/2007	0651913	51913	06851913	ES12C16A-3A (51913)■	—	—	
850	R RT	1998/2003	—	—	0681815	ESTX20-B4	—	—	
850	R RT	1998/2003	065188	YT19BL-BS■	—	—	—	—	
850	R RT	1998/2003	0651913	51913	06851913	ES12C16A-3A (51913)■	—	—	
900	R 90	1973/1976	0653030	53030	06853030	ES60-N30L-B (53030)■	—	—	
900	R 90 S	1973/1976	0653030	53030	06853030	ES60-N30L-B (53030)■	—	—	
900	R 90 ST	1973/1976	0652015	52015	—	—	—	—	
1000	HP4 (K42)	2012/2015	065007	YTZ7S▲	—	—	063007	FTZ7S▲	
1000	HP4 (K42)	2012/2015	065010	YTZ10S▲	—	—	063010	FTZ10S▲	



▲ - Factory Sealed / Attivata dalla Fabbrica ■ - con Acido a corredo ◇ - Non di produzione YUASA a completamento gamma

Marca / Cilindrata / Modello / Anno			Cod. SGR		Cod. SGR		Cod. SGR		
BMW									
1000	HP4 (K42)	2012/2015	065907	TTZ7S▲	068907	ESTTZ7S-BS■	—	—	
1000	HP4 (K42)	2012/2015	065910	TTZ10S-BS	068910	ESTTZ10S-BS■	—	—	
1000	K 100	1982/1990	0653030	53030	06853030	ES60-N30L-B (53030)■	—	—	
1000	K 100 LT	1983/1992	0653030	53030	06853030	ES60-N30L-B (53030)■	—	—	
1000	K 100 RS	1983/1992	0653030	53030	06853030	ES60-N30L-B (53030)■	—	—	
1000	K 100 RT	1983/1992	0653030	53030	06853030	ES60-N30L-B (53030)■	—	—	
1000	K1	1989/1995	0652015	52015	—	—	—	—	
1000	R 100 CS	1980/1985	0653030	53030	06853030	ES60-N30L-B (53030)■	—	—	
1000	R 100 GS / R 100 GS Parigi Dakar	1987/1996	0652015	52015	—	—	—	—	
1000	R 100 R (247)	1991/1995	—	—	0681815	ESTX20-B4	—	—	
1000	R 100 R (247)	1991/1995	065188	YT19BL-BS■	—	—	—	—	
1000	R 100 R (247)	1991/1995	0651913	51913	06851913	ES12C16A-3A (51913)■	—	—	
1000	R 100 RS	1984/1985	0653030	53030	06853030	ES60-N30L-B (53030)■	—	—	
1000	S R (K47)	2014/2017	0650990	YTX9-BS■	068099	ESTX9-BS■	063099	FTX9-BS■	
1000	S RR (K46)	2009/2010	065012	YTZ12S▲	—	—	063012	FTZ12S▲	
1000	S RR (K46)	2009/2010	065912	TTZ12S-BS	068912	ESTTZ12S-BS■	—	—	
1000	S RR (K46)	2009/2015	065010	YTZ10S▲	—	—	063010	FTZ10S▲	
1000	S RR (K46)	2009/2015	065910	TTZ10S-BS	068910	ESTTZ10S-BS■	—	—	
1000	S RR (K46)	2016/2017	0650990	YTX9-BS■	068099	ESTX9-BS■	063099	FTX9-BS■	
1000	S XR (K49)	2015/2017	0650990	YTX9-BS■	068099	ESTX9-BS■	063099	FTX9-BS■	
1100	K LT / LT SE (K589)	1992/1999	—	—	0681815	ESTX20-B4	—	—	
1100	K LT / LT SE (K589)	1992/1999	065188	YT19BL-BS■	—	—	—	—	
1100	K LT / LT SE (K589)	1992/1999	0651913	51913	06851913	ES12C16A-3A (51913)■	—	—	
1100	K LT / LT SE ABS (K589)	1992/1999	—	—	0681815	ESTX20-B4	—	—	
1100	K LT / LT SE ABS (K589)	1992/1999	065188	YT19BL-BS■	—	—	—	—	
1100	K LT / LT SE ABS (K589)	1992/1999	0651913	51913	06851913	ES12C16A-3A (51913)■	—	—	
1100	K RS (K589)	1992/1997	0653030	53030	06853030	ES60-N30L-B (53030)■	—	—	
1100	R GS	1994/1999	—	—	0681815	ESTX20-B4	—	—	
1100	R GS	1994/1999	065188	YT19BL-BS■	—	—	—	—	
1100	R GS	1994/1999	0651913	51913	06851913	ES12C16A-3A (51913)■	—	—	
1100	R R	1993/2001	—	—	0681815	ESTX20-B4	—	—	
1100	R R	1993/2001	065188	YT19BL-BS■	—	—	—	—	
1100	R R	1993/2001	0651913	51913	06851913	ES12C16A-3A (51913)■	—	—	
1100	R RS	1994/2001	—	—	0681815	ESTX20-B4	—	—	
1100	R RS	1994/2001	065188	YT19BL-BS■	—	—	—	—	
1100	R RS	1994/2001	0651913	51913	06851913	ES12C16A-3A (51913)■	—	—	
1100	R RT	1993/2001	—	—	0681815	ESTX20-B4	—	—	
1100	R RT	1993/2001	065188	YT19BL-BS■	—	—	—	—	
1100	R RT	1993/2001	0651913	51913	06851913	ES12C16A-3A (51913)■	—	—	
1100	R S	1996/2006	—	—	0681815	ESTX20-B4	—	—	
1100	R S	1996/2006	065188	YT19BL-BS■	—	—	—	—	



▲ - Factory Sealed / Attivata dalla Fabbrica ■ - con Acido a corredo ◇ - Non di produzione YUASA a completamento gamma

Marca / Cilindrata / Modello / Anno			Cod. SGR		Cod. SGR		Cod. SGR		
BMW									
1100 R S	1996/2006	0651913	51913	06851913	ES12C16A-3A (51913)■	—	—	—	
1100 R S ABS	2001/2006	—	—	0681815	ESTX20-B4	—	—	—	
1100 R S ABS	2001/2006	065188	YT19BL-BS■	—	—	—	—	—	
1100 R S ABS	2001/2006	0651913	51913	06851913	ES12C16A-3A (51913)■	—	—	—	
1150 R GS / R GS Adventure	1999/2005	—	—	0681815	ESTX20-B4	—	—	—	
1150 R GS / R GS Adventure	1999/2005	065188	YT19BL-BS■	—	—	—	—	—	
1150 R R (K82)	2001/2003	—	—	0681815	ESTX20-B4	—	—	—	
1150 R R (K82)	2001/2003	065188	YT19BL-BS■	—	—	—	—	—	
1150 R R (K82)	2001/2003	0651913	51913	06851913	ES12C16A-3A (51913)■	—	—	—	
1150 R RS (K87)	2001/2003	—	—	0681815	ESTX20-B4	—	—	—	
1150 R RS (K87)	2001/2003	065188	YT19BL-BS■	—	—	—	—	—	
1150 R RS (K87)	2001/2003	0651913	51913	06851913	ES12C16A-3A (51913)■	—	—	—	
1150 R RT (K81)	2001/2005	—	—	0681815	ESTX20-B4	—	—	—	
1150 R RT (K81)	2001/2005	065188	YT19BL-BS■	—	—	—	—	—	
1150 R RT (K81)	2001/2005	0651913	51913	06851913	ES12C16A-3A (51913)■	—	—	—	
1200 HP2 (K25)	2006/2009	065012	YTZ12S▲	—	—	063012	FTZ12S▲	—	
1200 HP2 (K25)	2006/2009	065912	TTZ12S-BS	068912	ESTTZ12S-BS■	—	—	—	
1200 HP2 Megamoto (K25)	2007/2011	065012	YTZ12S▲	—	—	063012	FTZ12S▲	—	
1200 HP2 Megamoto (K25)	2007/2011	065912	TTZ12S-BS	068912	ESTTZ12S-BS■	—	—	—	
1200 HP2 Sport (K29)	2008/2012	065012	YTZ12S▲	—	—	063012	FTZ12S▲	—	
1200 HP2 Sport (K29)	2008/2012	065912	TTZ12S-BS	068912	ESTTZ12S-BS■	—	—	—	
1200 K GT (K41)	2002/2005	0651913	51913	06851913	ES12C16A-3A (51913)■	—	—	—	
1200 K GT (K44)	2006/2008	—	—	0681815	ESTX20-B4	—	—	—	
1200 K GT (K44)	2006/2008	065188	YT19BL-BS■	—	—	—	—	—	
1200 K GT ABS (K44)	2006/2008	—	—	0681815	ESTX20-B4	—	—	—	
1200 K GT ABS (K44)	2006/2008	065188	YT19BL-BS■	—	—	—	—	—	
1200 K LT/ M (K76)	1999/2010	—	—	0681815	ESTX20-B4	—	—	—	
1200 K LT/ M (K76)	1999/2010	065188	YT19BL-BS■	—	—	—	—	—	
1200 K LT/ M (K76)	1999/2010	0651913	51913	06851913	ES12C16A-3A (51913)■	—	—	—	
1200 K R (K43)	2005/2008	065124	YTX14H-BS■	—	—	—	—	—	
1200 K R (K43)	2005/2008	065129	YTX14-BS■	068129	ESTX14-BS■	—	—	—	
1200 K R Sport (K43)	2005/2008	065124	YTX14H-BS■	—	—	—	—	—	
1200 K R Sport (K43)	2005/2008	065129	YTX14-BS■	068129	ESTX14-BS■	—	—	—	
1200 K RS (K13)	1996/2000	—	—	0681815	ESTX20-B4	—	—	—	
1200 K RS (K13)	1996/2000	065188	YT19BL-BS■	—	—	—	—	—	
1200 K RS (K13)	1996/2000	0651913	51913	06851913	ES12C16A-3A (51913)■	—	—	—	
1200 K RS (K41)	2001/2005	—	—	0681815	ESTX20-B4	—	—	—	
1200 K RS (K41)	2001/2005	065188	YT19BL-BS■	—	—	—	—	—	
1200 K RS (K41)	2001/2005	0651913	51913	06851913	ES12C16A-3A (51913)■	—	—	—	
1200 K S (K40)	2005/2008	065124	YTX14H-BS■	—	—	—	—	—	
1200 K S (K40)	2005/2008	065129	YTX14-BS■	068129	ESTX14-BS■	—	—	—	



▲ - Factory Sealed / Attivata dalla Fabbrica ■ - con Acido a corredo ◇ - Non di produzione YUASA a completamento gamma

Marca / Cilindrata / Modello / Anno			Cod. SGR		Cod. SGR		Cod. SGR		
BMW									
1200	R C Avantgarde (K74)	1996/2005	—	—	0681815	ESTX20-B4	—	—	
1200	R C Avantgarde (K74)	1996/2005	065188	YT19BL-BS■	—	—	—	—	
1200	R C Avantgarde (K74)	1996/2005	0651913	51913	06851913	ES12C16A-3A (51913)■	—	—	
1200	R C Classic (K74)	1996/2005	—	—	0681815	ESTX20-B4	—	—	
1200	R C Classic (K74)	1996/2005	065188	YT19BL-BS■	—	—	—	—	
1200	R C Classic (K74)	1996/2005	0651913	51913	06851913	ES12C16A-3A (51913)■	—	—	
1200	R C Cruiser (K74)	1996/2005	—	—	0681815	ESTX20-B4	—	—	
1200	R C Cruiser (K74)	1996/2005	065188	YT19BL-BS■	—	—	—	—	
1200	R C Cruiser (K74)	1996/2005	0651913	51913	06851913	ES12C16A-3A (51913)■	—	—	
1200	R C Indipendent (K84)	2000/2006	—	—	0681815	ESTX20-B4	—	—	
1200	R C Indipendent (K84)	2000/2006	065188	YT19BL-BS■	—	—	—	—	
1200	R C Indipendent (K84)	2000/2006	0651913	51913	06851913	ES12C16A-3A (51913)■	—	—	
1200	R C Montauk (K91)	2000/2006	—	—	0681815	ESTX20-B4	—	—	
1200	R C Montauk (K91)	2000/2006	065188	YT19BL-BS■	—	—	—	—	
1200	R C Montauk (K91)	2000/2006	0651913	51913	06851913	ES12C16A-3A (51913)■	—	—	
1200	R CL Confortline (K30)	2001/2004	—	—	0681815	ESTX20-B4	—	—	
1200	R CL Confortline (K30)	2001/2004	065188	YT19BL-BS■	—	—	—	—	
1200	R CL Confortline (K30)	2001/2004	0651913	51913	06851913	ES12C16A-3A (51913)■	—	—	
1200	R GS (K25)	2003/2012	065124	YTX14H-BS■	—	—	—	—	
1200	R GS (K25)	2003/2012	065129	YTX14-BS■	068129	ESTX14-BS■	—	—	
1200	R GS (K50)	2013/2017	065124	YTX14H-BS■	—	—	—	—	
1200	R GS (K50)	2013/2017	065129	YTX14-BS■	068129	ESTX14-BS■	—	—	
1200	R GS (K50)	2013/2013	065014	YTZ14S▲	—	—	—	—	
1200	R GS (K50)	2013/2013	065914	TTZ14S-BS	068914	ESTTZ14S-BS■	—	—	
1200	R GS Adventure (K255)	2006/2009	065124	YTX14H-BS■	—	—	—	—	
1200	R GS Adventure (K255)	2006/2009	065129	YTX14-BS■	068129	ESTX14-BS■	—	—	
1200	R GS Adventure (K255)	2010/2015	065014	YTZ14S▲	—	—	—	—	
1200	R GS Adventure (K255)	2010/2015	065914	TTZ14S-BS	068914	ESTTZ14S-BS■	—	—	
1200	R GS Adventure (K51)	2014/2017	065124	YTX14H-BS■	—	—	—	—	
1200	R GS Adventure (K51)	2014/2017	065129	YTX14-BS■	068129	ESTX14-BS■	—	—	
1200	R NINE T (K21)	2014/2017	065124	YTX14H-BS■	—	—	—	—	
1200	R NINE T (K21)	2014/2017	065129	YTX14-BS■	068129	ESTX14-BS■	—	—	
1200	R NINE T PURE (K22)	2017/2017	065124	YTX14H-BS■	—	—	—	—	
1200	R NINE T PURE (K22)	2017/2017	065129	YTX14-BS■	068129	ESTX14-BS■	—	—	
1200	R NINE T RACER (K32)	2017/2017	065124	YTX14H-BS■	—	—	—	—	
1200	R NINE T RACER (K32)	2017/2017	065129	YTX14-BS■	068129	ESTX14-BS■	—	—	
1200	R NINE T SCRAMBLER (K23)	2017/2017	065124	YTX14H-BS■	—	—	—	—	
1200	R NINE T SCRAMBLER (K23)	2017/2017	065129	YTX14-BS■	068129	ESTX14-BS■	—	—	
1200	R NINE T URBAN G/ S (K33)	2017/2017	065124	YTX14H-BS■	—	—	—	—	
1200	R NINE T URBAN G/ S (K33)	2017/2017	065129	YTX14-BS■	068129	ESTX14-BS■	—	—	
1200	R R (K27)	2006/2014	065124	YTX14H-BS■	—	—	—	—	



▲ - Factory Sealed / Attivata dalla Fabbrica ■ - con Acido a corredo ◇ - Non di produzione YUASA a completamento gamma

Marca / Cilindrata / Modello / Anno		Cod. SGR		Cod. SGR		Cod. SGR		
BMW								
1200 R R (K27)	2006/2014	065129	YTX14-BS■	068129	ESTX14-BS■	—	—	
1200 R R LC (K53)	2015/2017	065124	YTX14H-BS■	—	—	—	—	
1200 R R LC (K53)	2015/2017	065129	YTX14-BS■	068129	ESTX14-BS■	—	—	
1200 R RS LC (K54)	2015/2017	065124	YTX14H-BS■	—	—	—	—	
1200 R RS LC (K54)	2015/2017	065129	YTX14-BS■	068129	ESTX14-BS■	—	—	
1200 R RT (K26)	2005/2013	—	—	0681815	ESTX20-B4	—	—	
1200 R RT (K26)	2005/2013	065188	YT19BL-BS■	—	—	—	—	
1200 R RT (K26)	2005/2013	0651913	51913	06851913	ES12C16A-3A (51913)■	—	—	
1200 R S (K29)	2005/2009	065124	YTX14H-BS■	—	—	—	—	
1200 R S (K29)	2005/2009	065129	YTX14-BS■	068129	ESTX14-BS■	—	—	
1200 R ST (K28)	2005/2008	065124	YTX14H-BS■	—	—	—	—	
1200 R ST (K28)	2005/2008	065129	YTX14-BS■	068129	ESTX14-BS■	—	—	
1300 K GT (K44)	2009/2010	—	—	0681815	ESTX20-B4	—	—	
1300 K GT (K44)	2009/2010	065188	YT19BL-BS■	—	—	—	—	
1300 K GT (K44)	2009/2010	0651913	51913	06851913	ES12C16A-3A (51913)■	—	—	
1300 K R (K43)	2009/2015	065124	YTX14H-BS■	—	—	—	—	
1300 K R (K43)	2009/2015	065129	YTX14-BS■	068129	ESTX14-BS■	—	—	
1300 K S (K40)	2009/2015	065124	YTX14H-BS■	—	—	—	—	
1300 K S (K40)	2009/2015	065129	YTX14-BS■	068129	ESTX14-BS■	—	—	
1600 K GT/ GTL	2010/2015	—	—	0681815	ESTX20-B4	—	—	
1600 K GT/ GTL	2010/2015	065188	YT19BL-BS■	—	—	—	—	
BOMBARDIER								
650 GTX	1994/2005	065186	YTX20HL-BS-PW■	—	—	—	—	
650 SPX	1994/2005	065186	YTX20HL-BS-PW■	—	—	—	—	
718 GSI	1997/2005	065186	YTX20HL-BS-PW■	—	—	—	—	
718 GTI	1995/2005	065186	YTX20HL-BS-PW■	—	—	—	—	
782 GTX	1996/2005	065186	YTX20HL-BS-PW■	—	—	—	—	
782 SPX	1997/2005	065186	YTX20HL-BS-PW■	—	—	—	—	
951 GSX	1997/2005	065186	YTX20HL-BS-PW■	—	—	—	—	
951 RX	2000/2005	065186	YTX20HL-BS-PW■	—	—	—	—	
1500 Tutti i Modelli	1988/1993	0650202	GYZ20HL▲	—	—	—	—	
1500 Tutti i Modelli	1988/1993	065185	YTX20HL-BS■	—	—	—	—	
1500 GTX 4-Tec	2002/2005	0653040	YB30CL-B	—	—	—	—	
- Tutti i Modelli 4stroke	2003/2003	065215	YTX24HL-BS■	—	—	—	—	
- CJ4 types	1999/2003	065215	YTX24HL-BS■	—	—	—	—	
- ZX types	1999/2001	065139	YTX15L-BS■	068139	ESTX15L-BS■	—	—	
- ZX types	2002/2003	0650202	GYZ20HL▲	—	—	—	—	
- ZX types	2002/2003	065185	YTX20HL-BS■	—	—	—	—	
BOMBARDIER-CAN AM								
50 DS Mini	2003/2006	0650390	YTX4L-BS■	068039	ESTX4L-BS■	—	—	
50 Quest	2003/2006	0650390	YTX4L-BS■	068039	ESTX4L-BS■	—	—	



▲ - Factory Sealed / Attivata dalla Fabbrica ■ - con Acido a corredo ◇ - Non di produzione YUASA a completamento gamma

Marca / Cilindrata / Modello / Anno		Cod. SGR		Cod. SGR		Cod. SGR	
BOMBARDIER-CAN AM							
90 DS Mini	2003/2010	0650390	YTX4L-BS■	068039	ESTX4L-BS■	—	—
90 Quest	2003/2006	0650390	YTX4L-BS■	068039	ESTX4L-BS■	—	—
200 Rally	2003/2006	065122	YTX14AH-BS■	068122	ESTX14AH-BS■	—	—
250 DS	2006/2010	0651090	YTX12-BS■	0681090	ESTX12-BS■	063109	FTX12-BS■
330 Outlander	2003/2005	065139	YTX15L-BS■	068139	ESTX15L-BS■	—	—
330 Outlander	2004/2005	0650202	GYZ20HL▲	—	—	—	—
330 Outlander	2004/2005	065185	YTX20HL-BS■	—	—	—	—
330 Outlander	2004/2005	065209	YTX20L-BS■	068209	ESTX20L-BS■	—	—
400 Outlander	2003/2005	065139	YTX15L-BS■	068139	ESTX15L-BS■	—	—
400 Outlander	2004/2006	0650202	GYZ20HL▲	—	—	—	—
400 Outlander	2004/2006	065185	YTX20HL-BS■	—	—	—	—
400 Outlander	2004/2006	065209	YTX20L-BS■	068209	ESTX20L-BS■	—	—
400 Outlander H.O. Efi	2007/2008	0650202	GYZ20HL▲	—	—	—	—
400 Outlander H.O. Efi	2007/2008	065185	YTX20HL-BS■	—	—	—	—
400 Outlander H.O. Efi	2007/2008	065209	YTX20L-BS■	068209	ESTX20L-BS■	—	—
400 Outlander MAX H.O. Efi	2007/2008	0650202	GYZ20HL▲	—	—	—	—
400 Outlander MAX H.O. Efi	2007/2008	065185	YTX20HL-BS■	—	—	—	—
400 Outlander MAX H.O. Efi	2007/2008	065209	YTX20L-BS■	068209	ESTX20L-BS■	—	—
400 Outlander MAX XT H.O. Efi	2007/2008	0650202	GYZ20HL▲	—	—	—	—
400 Outlander MAX XT H.O. Efi	2007/2008	065185	YTX20HL-BS■	—	—	—	—
400 Outlander MAX XT H.O. Efi	2007/2008	065209	YTX20L-BS■	068209	ESTX20L-BS■	—	—
400 Outlander XT H.O. Efi	2007/2010	0650202	GYZ20HL▲	—	—	—	—
400 Outlander XT H.O. Efi	2007/2010	065185	YTX20HL-BS■	—	—	—	—
400 Outlander XT H.O. Efi	2007/2010	065209	YTX20L-BS■	068209	ESTX20L-BS■	—	—
500 Renegade	2008/2010	0650202	GYZ20HL▲	—	—	—	—
500 Renegade	2008/2010	065185	YTX20HL-BS■	—	—	—	—
500 Renegade	2008/2010	065209	YTX20L-BS■	068209	ESTX20L-BS■	—	—
500 XT Quest	1999/2005	065186	YTX20HL-BS-PW■	—	—	—	—
500 XT Traxter	1999/2002	065186	YTX20HL-BS-PW■	—	—	—	—
500 XT Traxter	2002/2005	065215	YTX24HL-BS■	—	—	—	—
650 DS X	2007/2008	065139	YTX15L-BS■	068139	ESTX15L-BS■	—	—
650 DS, DS Baja, DS X	2000/2006	065139	YTX15L-BS■	068139	ESTX15L-BS■	—	—
650 Outlander H.O. Efi	2006/2008	0650202	GYZ20HL▲	—	—	—	—
650 Outlander H.O. Efi	2006/2008	065185	YTX20HL-BS■	—	—	—	—
650 Outlander H.O. Efi	2006/2008	065209	YTX20L-BS■	068209	ESTX20L-BS■	—	—
650 Outlander MAX H.O. Efi	2006/2008	0650202	GYZ20HL▲	—	—	—	—
650 Outlander MAX H.O. Efi	2006/2008	065185	YTX20HL-BS■	—	—	—	—
650 Outlander MAX H.O. Efi	2006/2008	065209	YTX20L-BS■	068209	ESTX20L-BS■	—	—
650 Outlander MAX XT H.O. Efi	2006/2008	0650202	GYZ20HL▲	—	—	—	—
650 Outlander MAX XT H.O. Efi	2006/2008	065185	YTX20HL-BS■	—	—	—	—
650 Outlander MAX XT H.O. Efi	2006/2008	065209	YTX20L-BS■	068209	ESTX20L-BS■	—	—



▲ - Factory Sealed / Attivata dalla Fabbrica ■ - con Acido a corredo ◇ - Non di produzione YUASA a completamento gamma

Marca / Cilindrata / Modello / Anno			Cod. SGR		Cod. SGR		Cod. SGR	
BOMBARDIER-CAN AM								
650	Outlander XT H.O. Efi	2006/2008	0650202	GYZ20HL▲	—	—	—	—
650	Outlander XT H.O. Efi	2006/2008	065185	YTX20HL-BS■	—	—	—	—
650	Outlander XT H.O. Efi	2006/2008	065209	YTX20L-BS■	068209	ESTX20L-BS■	—	—
650	Quest / Quest XT	2002/2004	065186	YTX20HL-BS-PW■	—	—	—	—
650	Quest / Quest XT (Opt)	2002/2004	065215	YTX24HL-BS■	—	—	—	—
650	Quest MAX	2004/2004	065186	YTX20HL-BS-PW■	—	—	—	—
650	Quest MAX (opt)	2004/2004	065215	YTX24HL-BS■	—	—	—	—
650	Traxter MAX XT	2003/2005	065215	YTX24HL-BS■	—	—	—	—
650	Traxter XT	2005/2005	065215	YTX24HL-BS■	—	—	—	—
800	Outlander H.O. Efi	2006/2008	0650202	GYZ20HL▲	—	—	—	—
800	Outlander H.O. Efi	2006/2008	065185	YTX20HL-BS■	—	—	—	—
800	Outlander H.O. Efi	2006/2008	065209	YTX20L-BS■	068209	ESTX20L-BS■	—	—
800	Outlander MAX H.O. Efi	2006/2008	0650202	GYZ20HL▲	—	—	—	—
800	Outlander MAX H.O. Efi	2006/2008	065185	YTX20HL-BS■	—	—	—	—
800	Outlander MAX H.O. Efi	2006/2008	065209	YTX20L-BS■	068209	ESTX20L-BS■	—	—
800	Outlander MAX XT H.O. Efi	2006/2008	0650202	GYZ20HL▲	—	—	—	—
800	Outlander MAX XT H.O. Efi	2006/2008	065185	YTX20HL-BS■	—	—	—	—
800	Outlander MAX XT H.O. Efi	2006/2008	065209	YTX20L-BS■	068209	ESTX20L-BS■	—	—
800	Outlander XT H.O. Efi	2006/2008	0650202	GYZ20HL▲	—	—	—	—
800	Outlander XT H.O. Efi	2006/2008	065185	YTX20HL-BS■	—	—	—	—
800	Outlander XT H.O. Efi	2006/2008	065209	YTX20L-BS■	068209	ESTX20L-BS■	—	—
800	Renegade	2007/2010	0650202	GYZ20HL▲	—	—	—	—
800	Renegade	2007/2010	065185	YTX20HL-BS■	—	—	—	—
800	Renegade	2007/2010	065209	YTX20L-BS■	068209	ESTX20L-BS■	—	—
800	Renegade X	2007/2010	0650202	GYZ20HL▲	—	—	—	—
800	Renegade X	2007/2010	065185	YTX20HL-BS■	—	—	—	—
800	Renegade X	2007/2010	065209	YTX20L-BS■	068209	ESTX20L-BS■	—	—
990	GS Spider Roaster SE5 Transmission	2009/2009	065215	YTX24HL-BS■	—	—	—	—
990	GS Spyder 5 speed	2008/2008	065215	YTX24HL-BS■	—	—	—	—
990	GS Spyder Roadster SM5 Trasmission	2009/2010	065215	YTX24HL-BS■	—	—	—	—
990	GS Spyder Semi-Automatic (motore)	2008/2008	065215	YTX24HL-BS■	—	—	—	—
990	RT Spider Roaster SE5 Transmission	2010/2010	065215	YTX24HL-BS■	—	—	—	—
BUELL								
900	XB9R Firebolt	2002/2007	065124	YTX14H-BS■	—	—	—	—
900	XB9R Firebolt	2002/2007	065129	YTX14-BS■	068129	ESTX14-BS■	—	—
900	XB9S Lightning	2003/2004	065124	YTX14H-BS■	—	—	—	—
900	XB9S Lightning	2003/2004	065129	YTX14-BS■	068129	ESTX14-BS■	—	—
1000	RR	1987/1987	0650201	GYZ20H▲	—	—	—	—
1000	RR	1987/1987	065184	YTX20H-BS■	—	—	—	—
1200	M2 Cyclone	1997/2002	0650202	GYZ20HL▲	—	—	—	—
1200	M2 Cyclone	1997/2002	065185	YTX20HL-BS■	—	—	—	—

▲ - Factory Sealed / Attivata dalla Fabbrica ■ - con Acido a corredo ◇ - Non di produzione YUASA a completamento gamma

Marca / Cilindrata / Modello / Anno			Cod. SGR		Cod. SGR		Cod. SGR		
BUELL									
1200 RR	1988/1990	0650201	GYZ20H▲	—	—	—	—	—	
1200 RR	1988/1990	065184	YTX20H-BS■	—	—	—	—	—	
1200 RS	1989/1993	0650201	GYZ20H▲	—	—	—	—	—	
1200 RS	1989/1993	065184	YTX20H-BS■	—	—	—	—	—	
1200 RSS	1991/1993	0650201	GYZ20H▲	—	—	—	—	—	
1200 RSS	1991/1993	065184	YTX20H-BS■	—	—	—	—	—	
1200 S1 Lightning	1996/1999	065124	YTX14H-BS■	—	—	—	—	—	
1200 S1 Lightning	1996/1999	065129	YTX14-BS■	068129	ESTX14-BS■	—	—	—	
1200 S2 Thunderbolt	1994/1996	0650201	GYZ20H▲	—	—	—	—	—	
1200 S2 Thunderbolt	1994/1996	065184	YTX20H-BS■	—	—	—	—	—	
1200 S3 Thunderbolt	1997/2002	0650202	GYZ20HL▲	—	—	—	—	—	
1200 S3 Thunderbolt	1997/2002	065185	YTX20HL-BS■	—	—	—	—	—	
1200 X1 Lightning	1999/2002	0650202	GYZ20HL▲	—	—	—	—	—	
1200 X1 Lightning	1999/2002	065185	YTX20HL-BS■	—	—	—	—	—	
1200 XB12R Firebolt	2004/2005	065124	YTX14H-BS■	—	—	—	—	—	
1200 XB12R Firebolt	2004/2005	065129	YTX14-BS■	068129	ESTX14-BS■	—	—	—	
1200 XB12S Lightning	2004/2010	065124	YTX14H-BS■	—	—	—	—	—	
1200 XB12S Lightning	2004/2010	065129	YTX14-BS■	068129	ESTX14-BS■	—	—	—	
1200 XB12SCG Lightning	2005/2010	065124	YTX14H-BS■	—	—	—	—	—	
1200 XB12SCG Lightning	2005/2010	065129	YTX14-BS■	068129	ESTX14-BS■	—	—	—	
1200 XB12SS Lightning Long	2006/2010	065124	YTX14H-BS■	—	—	—	—	—	
1200 XB12SS Lightning Long	2006/2010	065129	YTX14-BS■	068129	ESTX14-BS■	—	—	—	
1200 XB12X Ulysses	2006/2010	065124	YTX14H-BS■	—	—	—	—	—	
1200 XB12X Ulysses	2006/2010	065129	YTX14-BS■	068129	ESTX14-BS■	—	—	—	
BUFFALO									
50 BT49QT-12C1 Warrior 4T R12	2007/2008	0650700	YTX7A-BS■	068070	ESTX7A-BS■	—	—	—	
50 BT49QT-12D1 Hero 4T R12	2007/2008	0650700	YTX7A-BS■	068070	ESTX7A-BS■	—	—	—	
50 BT49QT-12E/1/2/3 Rocky 4T R12	2007/2008	0650700	YTX7A-BS■	068070	ESTX7A-BS■	—	—	—	
50 BT49QT-12F1 Tanco 4T R12	2007/2008	0650700	YTX7A-BS■	068070	ESTX7A-BS■	—	—	—	
CAGIVA									
50 Cocis	1988/1991	06504340	YB4L-B	—	—	—	—	—	
50 Cocis	1988/1991	065043410	YB4L-B■	0680434	ESB4L-B■	—	—	—	
50 Cucciolo	1997/>	06504340	YB4L-B	—	—	—	—	—	
50 Cucciolo	1997/>	065043410	YB4L-B■	0680434	ESB4L-B■	—	—	—	
50 K3	1991/1992	06504340	YB4L-B	—	—	—	—	—	
50 K3	1991/1992	065043410	YB4L-B■	0680434	ESB4L-B■	—	—	—	
50 Mito	1999/>	06504340	YB4L-B	—	—	—	—	—	
50 Mito	1999/>	065043410	YB4L-B■	0680434	ESB4L-B■	—	—	—	
50 Prima	1992/1994	065043410	YB4L-B■	0680434	ESB4L-B■	—	—	—	
50 Supercity	1991/1994	065043410	YB4L-B■	0680434	ESB4L-B■	—	—	—	
50 W4	1992/1992	06504340	YB4L-B	—	—	—	—	—	

▲ - Factory Sealed / Attivata dalla Fabbrica ■ - con Acido a corredo ◇ - Non di produzione YUASA a completamento gamma

Marca / Cilindrata / Modello / Anno			Cod. SGR		Cod. SGR		Cod. SGR		
CAGIVA									
50	W4	1992/1992	065043410	YB4L-B■	0680434	ESB4L-B■	—	—	
125	Aletta Oro S1/ S2	1985/1987	0650636	12N5.5-4A	—	—	—	—	
125	Aletta Oro S1/ S2	1985/1987	0651234	YB12A-A	0681234	ESB12A-A■	—	—	
125	Blues	1987/>	0651234	YB12A-A	0681234	ESB12A-A■	—	—	
125	Cruiser	1987/1988	06509350	YB9-B	0680935	ESB9-B■	—	—	
125	Cucciolo	1998/2000	06509350	YB9-B	0680935	ESB9-B■	—	—	
125	Elefant / Elefant 2	1984/1986	0650636	12N5.5-4A	—	—	—	—	
125	Elefantre	1987/1988	0651234	YB12A-A	0681234	ESB12A-A■	—	—	
125	Freccia C10 R	1988/1988	06509350	YB9-B	0680935	ESB9-B■	—	—	
125	Freccia C12 R	1989/1989	06509350	YB9-B	0680935	ESB9-B■	—	—	
125	Freccia C9	1987/1987	06509350	YB9-B	0680935	ESB9-B■	—	—	
125	K7	1990/1993	06504340	YB4L-B	—	—	—	—	
125	K7	1990/1993	065043410	YB4L-B■	0680434	ESB4L-B■	—	—	
125	Mito	1990/2010	06509350	YB9-B	0680935	ESB9-B■	—	—	
125	N 90	1989/>	06509350	YB9-B	0680935	ESB9-B■	—	—	
125	Nuvola	2001/2002	06509350	YB9-B	0680935	ESB9-B■	—	—	
125	Passing	1994/>	065049	YTX5L-BS■	068049	ESTX5L-BS■	063049	FTX5L-BS■	
125	Planet	1997/2002	06509350	YB9-B	0680935	ESB9-B■	—	—	
125	Raptor	2003/2004	06509350	YB9-B	0680935	ESB9-B■	—	—	
125	Roadster	1994/2001	0650636	12N5.5-4A	—	—	—	—	
125	SST 2T	1981/>	0650636	12N5.5-4A	—	—	—	—	
125	SST Aletta Electra 2T	1983/>	0651234	YB12A-A	0681234	ESB12A-A■	—	—	
125	Supercity	1992/>	06509350	YB9-B	0680935	ESB9-B■	—	—	
125	SXT Aletta Rossa	1982/>	0650634	12N5.5-3B	0680634	ES12N5.5-3B■	—	—	
125	SXT Aletta Rossa	1983/>	0650636	12N5.5-4A	—	—	—	—	
125	Tamanaco	1989/1989	06509350	YB9-B	0680935	ESB9-B■	—	—	
125	W8	1991/>	06504340	YB4L-B	—	—	—	—	
125	W8	1991/>	065043410	YB4L-B■	0680434	ESB4L-B■	—	—	
200	Elefant	1985/1986	0650636	12N5.5-4A	—	—	—	—	
250	SX	1982/>	0650734	12N7-3B	0680734	ES12N7-3B■	—	—	
350	Elefant	1989/>	065123	YTX14AHL-BS■	—	—	—	—	
350	Elefant	1989/>	0651434	YB14L-A2	0681434	ESB14L-A2■	—	—	
350	SX	1982/>	0650734	12N7-3B	0680734	ES12N7-3B■	—	—	
350	SXT Ala Rossa 4T	1983/>	0650636	12N5.5-4A	—	—	—	—	
350	T4E	1987/1994	065123	YTX14AHL-BS■	—	—	—	—	
350	T4E	1987/1994	0651434	YB14L-A2	0681434	ESB14L-A2■	—	—	
350	T4R	1987/1994	0650334	YB3L-A	0680334	ESB3L-A■	—	—	
350	W12	1992/>	065123	YTX14AHL-BS■	—	—	—	—	
350	W12	1992/>	0651434	YB14L-A2	0681434	ESB14L-A2■	—	—	
500	T4E	1987/1994	065123	YTX14AHL-BS■	—	—	—	—	
500	T4E	1987/1994	0651434	YB14L-A2	0681434	ESB14L-A2■	—	—	



▲ - Factory Sealed / Attivata dalla Fabbrica ■ - con Acido a corredo ◇ - Non di produzione YUASA a completamento gamma

Marca / Cilindrata / Modello / Anno			Cod. SGR		Cod. SGR		Cod. SGR		
CAGIVA									
600 Canyon	1995/1998	065124	YTX14H-BS■	—	—	—	—	—	
600 Canyon	1995/1998	065129	YTX14-BS■	068129	ESTX14-BS■	—	—	—	
600 River	1995/1999	065124	YTX14H-BS■	—	—	—	—	—	
600 River	1995/1999	065129	YTX14-BS■	068129	ESTX14-BS■	—	—	—	
600 W16	1994/1996	065123	YTX14AHL-BS■	—	—	—	—	—	
600 W16	1994/1996	0651434	YB14L-A2	0681434	ESB14L-A2■	—	—	—	
650 Elefant	1985/1989	065123	YTX14AHL-BS■	—	—	—	—	—	
650 Elefant	1985/1989	0651434	YB14L-A2	0681434	ESB14L-A2■	—	—	—	
650 Raptor	2000/2007	0650990	YTX9-BS■	068099	ESTX9-BS■	063099	FTX9-BS■	—	
650 V Raptor	2000/2002	0650990	YTX9-BS■	068099	ESTX9-BS■	063099	FTX9-BS■	—	
750 Elefant AC (6B)	1993/1997	065124	YTX14H-BS■	—	—	—	—	—	
750 Elefant AC (6B)	1993/1997	065129	YTX14-BS■	068129	ESTX14-BS■	—	—	—	
750 Elefant E (Monofaro)	1987/1987	065124	YTX14H-BS■	—	—	—	—	—	
750 Elefant E (Monofaro)	1987/1987	065129	YTX14-BS■	068129	ESTX14-BS■	—	—	—	
750 Elefant E (Monofaro)	1987/1987	0651637	YB16B-A	0681637	ESB16B-A■	—	—	—	
750 Elefant LE (Bifaro)	1988/1990	065124	YTX14H-BS■	—	—	—	—	—	
750 Elefant LE (Bifaro)	1988/1990	065129	YTX14-BS■	068129	ESTX14-BS■	—	—	—	
750 Elefant LE (Bifaro)	1988/1990	0651637	YB16B-A	0681637	ESB16B-A■	—	—	—	
900 Elefant / Elefant I.E.	1991/1997	065124	YTX14H-BS■	—	—	—	—	—	
900 Elefant / Elefant I.E.	1991/1997	065129	YTX14-BS■	068129	ESTX14-BS■	—	—	—	
900 Elefant / Elefant I.E.	1991/1997	0651637	YB16B-A	0681637	ESB16B-A■	—	—	—	
900 Gran Canyon	1998/2003	—	—	0681815	ESTX20-B4	—	—	—	
1000 Navigator	2000/2005	0651100	YT12B-BS■	0681100	EST12B-BS■	—	—	—	
1000 Raptor / V Raptor	2000/2005	0650990	YTX9-BS■	068099	ESTX9-BS■	063099	FTX9-BS■	—	
1000 X-TRA Raptor	2001/2005	0650990	YTX9-BS■	068099	ESTX9-BS■	063099	FTX9-BS■	—	
CPI									
50 Aragon GP/ Paddock/ Club	2007/2008	065049	YTX5L-BS■	068049	ESTX5L-BS■	063049	FTX5L-BS■	—	
50 Bingo FL	2002/2002	065049	YTX5L-BS■	068049	ESTX5L-BS■	063049	FTX5L-BS■	—	
50 Crab	2000/2000	0650390	YTX4L-BS■	068039	ESTX4L-BS■	—	—	—	
50 Formula R AC	2008/2008	065049	YTX5L-BS■	068049	ESTX5L-BS■	063049	FTX5L-BS■	—	
50 Hussar	2000/2000	0650390	YTX4L-BS■	068039	ESTX4L-BS■	—	—	—	
50 Hussar/ SL/ FL/ Euro 2	2001/2005	065049	YTX5L-BS■	068049	ESTX5L-BS■	063049	FTX5L-BS■	—	
50 Oliver/ City/ Sport	2003/2007	065049	YTX5L-BS■	068049	ESTX5L-BS■	063049	FTX5L-BS■	—	
50 Popcorn	2000/2000	0650390	YTX4L-BS■	068039	ESTX4L-BS■	—	—	—	
50 Popcorn/ SL/ FL/ Euro 2	2001/2004	065049	YTX5L-BS■	068049	ESTX5L-BS■	063049	FTX5L-BS■	—	
50 Tenesse	2001/2001	065049	YTX5L-BS■	068049	ESTX5L-BS■	063049	FTX5L-BS■	—	
100 Crab	TUTTI	0650390	YTX4L-BS■	068039	ESTX4L-BS■	—	—	—	
125 Aragon GP/ Paddock/ Club	2007/2008	065049	YTX5L-BS■	068049	ESTX5L-BS■	063049	FTX5L-BS■	—	
DAELIM									
50 A-Four (SJ50R)	2006/2013	0650390	YTX4L-BS■	068039	ESTX4L-BS■	—	—	—	
50 Bonita (SE50C)	2009/2012	0650390	YTX4L-BS■	068039	ESTX4L-BS■	—	—	—	



▲ - Factory Sealed / Attivata dalla Fabbrica ■ - con Acido a caldo ◇ - Non di produzione YUASA a completamento gamma

Marca / Cilindrata / Modello / Anno			Cod. SGR		Cod. SGR		Cod. SGR		
DAELIM									
50	Cordi 2T (SE50R)	2004/2012	0650390	YTX4L-BS ■	068039	ESTX4L-BS ■	—	—	
50	E-Five (SJ50A)	2003/2009	0650390	YTX4L-BS ■	068039	ESTX4L-BS ■	—	—	
50	Message 2T (GZ)	1998/2002	0650390	YTX4L-BS ■	068039	ESTX4L-BS ■	—	—	
50	S-Five (SJ50)	2001/2013	0650390	YTX4L-BS ■	068039	ESTX4L-BS ■	—	—	
50	S4 4T (ES50)	2009/2013	0650990	YTX9-BS ■	068099	ESTX9-BS ■	063099	FTX9-BS ■	
50	Tapo 2T (GZ50G)	1999/2000	0650390	YTX4L-BS ■	068039	ESTX4L-BS ■	—	—	
100	Delfino (SH100)	1999/2006	0650390	YTX4L-BS ■	068039	ESTX4L-BS ■	—	—	
125	NS I	1997/1998	0650700	YTX7A-BS ■	068070	ESTX7A-BS ■	—	—	
125	NS II Otello	1999/1999	0650700	YTX7A-BS ■	068070	ESTX7A-BS ■	—	—	
125	NS III Otello	2000/2001	0650700	YTX7A-BS ■	068070	ESTX7A-BS ■	—	—	
125	NS III Otello DLX	2002/2003	0650700	YTX7A-BS ■	068070	ESTX7A-BS ■	—	—	
125	NS III Otello Eco Euro 2	2004/2005	0650990	YTX9-BS ■	068099	ESTX9-BS ■	063099	FTX9-BS ■	
125	NS III Otello SE	2006/2006	0650990	YTX9-BS ■	068099	ESTX9-BS ■	063099	FTX9-BS ■	
125	S3 SV Sport / Touring	2010/2013	0651090	YTX12-BS ■	0681090	ESTX12-BS ■	063109	FTX12-BS ■	
125	SC Besbi	2008/2012	0650990	YTX9-BS ■	068099	ESTX9-BS ■	063099	FTX9-BS ■	
125	SL History	2001/2008	0650990	YTX9-BS ■	068099	ESTX9-BS ■	063099	FTX9-BS ■	
125	SL S1 Otello FI	2007/2012	0651090	YTX12-BS ■	0681090	ESTX12-BS ■	063109	FTX12-BS ■	
125	SQ S2 Freewing	2006/2008	0651090	YTX12-BS ■	0681090	ESTX12-BS ■	063109	FTX12-BS ■	
125	SQ S2 Freewing FI	2007/2009	0651090	YTX12-BS ■	0681090	ESTX12-BS ■	063109	FTX12-BS ■	
125	SU Delfino	2007/2012	0650990	YTX9-BS ■	068099	ESTX9-BS ■	063099	FTX9-BS ■	
125	VJ Roadwin	2004/2007	0651090	YTX12-BS ■	0681090	ESTX12-BS ■	063109	FTX12-BS ■	
125	VJ Roadwin FI	2008/2012	0651090	YTX12-BS ■	0681090	ESTX12-BS ■	063109	FTX12-BS ■	
125	VL Daystar FI	2008/2009	0651090	YTX12-BS ■	0681090	ESTX12-BS ■	063109	FTX12-BS ■	
125	VS	1999/2006	—	—	—	—	—	—	
125	VT/ Evolution/ Evo	1997/2005	—	—	—	—	—	—	
250	S2 SQ Freewing	2006/>	0651090	YTX12-BS ■	0681090	ESTX12-BS ■	063109	FTX12-BS ■	
DAZON									
50	Stinger	2002/2004	0650736	YB7-A	0680736	ESB7-A ■	—	—	
150	Raider Classic S/ D Buggy	TUTTI	0650990	YTX9-BS ■	068099	ESTX9-BS ■	063099	FTX9-BS ■	
150	Raider Max	TUTTI	0650990	YTX9-BS ■	068099	ESTX9-BS ■	063099	FTX9-BS ■	
DERBI									
50	Atlantis O2 Air	2002/2006	06504340	YB4L-B	—	—	—	—	
50	Atlantis O2 Air	2002/2006	065043410	YB4L-B ■	0680434	ESB4L-B ■	—	—	
50	Atlantis 2T Air E2	2007/2008	06504340	YB4L-B	—	—	—	—	
50	Atlantis 2T Air E2	2007/2008	065043410	YB4L-B ■	0680434	ESB4L-B ■	—	—	
50	Atlantis 4T	2004/2012	06504340	YB4L-B	—	—	—	—	
50	Atlantis 4T	2004/2012	065043410	YB4L-B ■	0680434	ESB4L-B ■	—	—	
50	Atlantis Air	1999/2001	06504340	YB4L-B	—	—	—	—	
50	Atlantis Air	1999/2002	065043410	YB4L-B ■	0680434	ESB4L-B ■	—	—	
50	Atlantis Lc	1999/2001	06504340	YB4L-B	—	—	—	—	
50	Atlantis Lc	1999/2001	065043410	YB4L-B ■	0680434	ESB4L-B ■	—	—	

▲ - Factory Sealed / Attivata dalla Fabbrica ■ - con Acido a corredo ◇ - Non di produzione YUASA a completamento gamma

Marca / Cilindrata / Modello / Anno			Cod. SGR		Cod. SGR		Cod. SGR	
DERBI								
50	Boulevard 2T	2009/2010	06504340	YB4L-B	—	—	—	—
50	Boulevard 2T	2009/2010	065043410	YB4L-B■	0680434	ESB4L-B■	—	—
50	Boulevard 4T	2009/2012	06509350	YB9-B	0680935	ESB9-B■	—	—
50	GP1 / E2	2005/2007	0650690	YTX7L-BS■	068069	ESTX7L-BS■	063069	FTX7L-BS■
50	GP1 / E2	2006/2009	06504340	YB4L-B	—	—	—	—
50	GP1 / E2	2006/2009	065043410	YB4L-B■	0680434	ESB4L-B■	—	—
50	GPR / GPR E2	2002/2003	06504340	YB4L-B	—	—	—	—
50	GPR / GPR E2	2002/2003	065043410	YB4L-B■	0680434	ESB4L-B■	—	—
50	GPR / GPR E2	2004/2009	065049	YTX5L-BS■	068049	ESTX5L-BS■	063049	FTX5L-BS■
50	GPR Nude/ Sport/ Tuning	2004/2009	065049	YTX5L-BS■	068049	ESTX5L-BS■	063049	FTX5L-BS■
50	GPR Racing / GPR Racing E2	2002/2003	06504340	YB4L-B	—	—	—	—
50	GPR Racing / GPR Racing E2	2002/2003	065043410	YB4L-B■	0680434	ESB4L-B■	—	—
50	GPR Racing / GPR Racing E2	2004/2009	065049	YTX5L-BS■	068049	ESTX5L-BS■	063049	FTX5L-BS■
50	GPR Replica / GPR Replica E2	2002/2003	06504340	YB4L-B	—	—	—	—
50	GPR Replica / GPR Replica E2	2002/2003	065043410	YB4L-B■	0680434	ESB4L-B■	—	—
50	GPR Replica / GPR Replica E2	2004/2009	065049	YTX5L-BS■	068049	ESTX5L-BS■	063049	FTX5L-BS■
50	Predator LC	1998/2001	06504340	YB4L-B	—	—	—	—
50	Predator LC	1998/2001	065043410	YB4L-B■	0680434	ESB4L-B■	—	—
50	Predator O2 Air	1998/2001	06504340	YB4L-B	—	—	—	—
50	Predator O2 Air	1998/2001	065043410	YB4L-B■	0680434	ESB4L-B■	—	—
50	Senda R	1999/2001	06504340	YB4L-B	—	—	—	—
50	Senda R	1999/2001	065043410	YB4L-B■	0680434	ESB4L-B■	—	—
50	Senda R DRD E1 E1R (SDR1GB)	2002/2003	06504340	YB4L-B	—	—	—	—
50	Senda R DRD E1 E1R (SDR1GB)	2002/2003	065043410	YB4L-B■	0680434	ESB4L-B■	—	—
50	Senda R DRD PRO E2 (SA1A1A)	2005/2012	065049	YTX5L-BS■	068049	ESTX5L-BS■	063049	FTX5L-BS■
50	Senda R DRD Racing (SR1A2B)	2004/2005	06504340	YB4L-B	—	—	—	—
50	Senda R DRD Racing (SR1A2B)	2004/2005	065043410	YB4L-B■	0680434	ESB4L-B■	—	—
50	Senda R DRD Racing E2 (SR1D2B)	2005/2008	06504340	YB4L-B	—	—	—	—
50	Senda R DRD Racing E2 (SR1D2B)	2005/2008	065043410	YB4L-B■	0680434	ESB4L-B■	—	—
50	Senda R DRD Racing LTD (SR1A2B)	2005/2005	06504340	YB4L-B	—	—	—	—
50	Senda R DRD Racing LTD (SR1A2B)	2005/2005	065043410	YB4L-B■	0680434	ESB4L-B■	—	—
50	Senda R Racer (SENDGB)	2003/2003	06504340	YB4L-B	—	—	—	—
50	Senda R Racer (SENDGB)	2003/2003	065043410	YB4L-B■	0680434	ESB4L-B■	—	—
50	Senda R X Race (SR1A1A)	2004/2005	06504340	YB4L-B	—	—	—	—
50	Senda R X Race E2	2006/2011	06504340	YB4L-B	—	—	—	—
50	Senda R X Race E2	2006/2011	065043410	YB4L-B■	0680434	ESB4L-B■	—	—
50	Senda R X Treme (SDR1EB)	2003/2003	06504340	YB4L-B	—	—	—	—
50	Senda R X Treme (SDR1EB)	2003/2003	065043410	YB4L-B■	0680434	ESB4L-B■	—	—
50	Senda R X Treme E2 (SR1A1A)	2004/2004	06504340	YB4L-B	—	—	—	—
50	Senda R X Treme E2 (SR1A1A)	2004/2004	065043410	YB4L-B■	0680434	ESB4L-B■	—	—
50	Senda R X Treme E2 (SR1D1A)	2005/2012	06504340	YB4L-B	—	—	—	—



▲ - Factory Sealed / Attivata dalla Fabbrica ■ - con Acido a corredo ◇ - Non di produzione YUASA a completamento gamma

Marca / Cilindrata / Modello / Anno			Cod. SGR		Cod. SGR		Cod. SGR		
DERBI									
50	Senda R X Treme E2 (SR1D1A)	2005/2012	065043410	YB4L-B■	0680434	ESB4L-B■	—	—	
50	Senda SM	2000/2002	06504340	YB4L-B	—	—	—	—	
50	Senda SM	2000/2002	065043410	YB4L-B■	0680434	ESB4L-B■	—	—	
50	Senda SM Black Edition (SR3A1A)	2003/2003	06504340	YB4L-B	—	—	—	—	
50	Senda SM Black Edition (SR3A1A)	2003/2003	065043410	YB4L-B■	0680434	ESB4L-B■	—	—	
50	Senda SM DRD Black Edition (SR3A1A)	2005/2005	06504340	YB4L-B	—	—	—	—	
50	Senda SM DRD Black Edition (SR3A1A)	2005/2005	065043410	YB4L-B■	0680434	ESB4L-B■	—	—	
50	Senda SM DRD E1 (SDR1DB) LEONELLI	2002/2002	06504340	YB4L-B	—	—	—	—	
50	Senda SM DRD E1 (SDR1DB) LEONELLI	2002/2002	065043410	YB4L-B■	0680434	ESB4L-B■	—	—	
50	Senda SM DRD E1R (SDR1HB) DUCATI	2003/2003	06504340	YB4L-B	—	—	—	—	
50	Senda SM DRD E1R (SDR1HB) DUCATI	2003/2003	065043410	YB4L-B■	0680434	ESB4L-B■	—	—	
50	Senda SM DRD PRO E2 (SA2A1A)	2005/2013	065049	YTX5L-BS■	068049	ESTX5L-BS■	063049	FTX5L-BS■	
50	Senda SM DRD Racing (SR2A2B)	2004/2005	06504340	YB4L-B	—	—	—	—	
50	Senda SM DRD Racing (SR2A2B)	2004/2005	065043410	YB4L-B■	0680434	ESB4L-B■	—	—	
50	Senda SM DRD Racing E2 (PABBO)	2010/2013	06504340	YB4L-B	—	—	—	—	
50	Senda SM DRD Racing E2 (PABBO)	2010/2013	065043410	YB4L-B■	0680434	ESB4L-B■	—	—	
50	Senda SM DRD Racing E2 (SR2D2B)	2005/2009	06504340	YB4L-B	—	—	—	—	
50	Senda SM DRD Racing E2 (SR2D2B)	2005/2009	065043410	YB4L-B■	0680434	ESB4L-B■	—	—	
50	Senda SM DRD Racing LTD (SR2A2B)	2004/2005	06504340	YB4L-B	—	—	—	—	
50	Senda SM DRD Racing LTD (SR2A2B)	2004/2005	065043410	YB4L-B■	0680434	ESB4L-B■	—	—	
50	Senda SM DRD Racing LTD E2 (SR2D2B)	2006/2007	06504340	YB4L-B	—	—	—	—	
50	Senda SM DRD Racing LTD E2 (SR2D2B)	2006/2007	065043410	YB4L-B■	0680434	ESB4L-B■	—	—	
50	Senda SM X Race (SR2A1A)	2004/2005	06504340	YB4L-B	—	—	—	—	
50	Senda SM X Race (SR2A1A)	2004/2005	065043410	YB4L-B■	0680434	ESB4L-B■	—	—	
50	Senda SM X Race E2 (SR2D1A)	2010/2010	06504340	YB4L-B	—	—	—	—	
50	Senda SM X Race E2 (SR2D1A)	2010/2010	065043410	YB4L-B■	0680434	ESB4L-B■	—	—	
50	Senda SM X Race E2 (SR2E1A)	2006/2009	06504340	YB4L-B	—	—	—	—	
50	Senda SM X Race E2 (SR2E1A)	2006/2009	065043410	YB4L-B■	0680434	ESB4L-B■	—	—	
50	Senda SM X Treme (SDR1FB) DUCATI	2003/2003	06504340	YB4L-B	—	—	—	—	
50	Senda SM X Treme (SDR1FB) DUCATI	2003/2003	065043410	YB4L-B■	0680434	ESB4L-B■	—	—	
50	Senda SM X Treme (SDR1FB) LEONELLI	2003/2003	06504340	YB4L-B	—	—	—	—	
50	Senda SM X Treme (SDR1FB) LEONELLI	2003/2003	065043410	YB4L-B■	0680434	ESB4L-B■	—	—	
50	Senda SM X Treme (SR1BB/ SDRBB)	2002/2002	06504340	YB4L-B	—	—	—	—	
50	Senda SM X Treme (SR1BB/ SDRBB)	2002/2002	065043410	YB4L-B■	0680434	ESB4L-B■	—	—	
50	Senda SM X Treme E2 (SR2A1A)	2004/2004	06504340	YB4L-B	—	—	—	—	
50	Senda SM X Treme E2 (SR2A1A)	2004/2004	065043410	YB4L-B■	0680434	ESB4L-B■	—	—	
50	Senda SM X Treme E2 (SR2B1A)	2005/2007	06504340	YB4L-B	—	—	—	—	
50	Senda SM X Treme E2 (SR2B1A)	2005/2007	065043410	YB4L-B■	0680434	ESB4L-B■	—	—	
50	Senda SM X Treme E2 (SR2D1A)	2008/2009	06504340	YB4L-B	—	—	—	—	
50	Senda SM X Treme E2 (SR2D1A)	2008/2009	065043410	YB4L-B■	0680434	ESB4L-B■	—	—	
50	Senda SM X Treme E2 (SR2D1A)	2010/2012	06504340	YB4L-B	—	—	—	—	



▲ - Factory Sealed / Attivata dalla Fabbrica ■ - con Acido a corredo ◇ - Non di produzione YUASA a completamento gamma

Marca / Cilindrata / Modello / Anno			Cod. SGR		Cod. SGR		Cod. SGR		
DERBI									
50	Senda SM X Treme E2 (SR2D1A)	2010/2012	065043410	YB4L-B■	0680434	ESB4L-B■	—	—	
50	Vamos	1992/>	06504340	YB4L-B	—	—	—	—	
50	Vamos	1992/>	065043410	YB4L-B■	0680434	ESB4L-B■	—	—	
100	Atlantis 2T	2000/2001	06504340	YB4L-B	—	—	—	—	
100	Atlantis 2T	2000/2001	065043410	YB4L-B■	0680434	ESB4L-B■	—	—	
100	Boulevard 4T	2010/2012	06509350	YB9-B	0680935	ESB9-B■	—	—	
125	Boulevard / Boulevard E3	2003/2012	06509350	YB9-B	0680935	ESB9-B■	—	—	
125	Cross City (SCID1B)	2007/2008	0650690	YTX7L-BS■	068069	ESTX7L-BS■	063069	FTX7L-BS■	
125	Cross City (SC2D1B/ SC2E1B)	2007/2012	0650690	YTX7L-BS■	068069	ESTX7L-BS■	063069	FTX7L-BS■	
125	GP1 E2 / Low Seat E3	2006/2008	0651231	YB10L-BP	—	—	—	—	
125	GPR (GS1A1A)	2004/2006	065049	YTX5L-BS■	068049	ESTX5L-BS■	063049	FTX5L-BS■	
125	GPR 4T (RG1A1A)	2009/2013	0650690	YTX7L-BS■	068069	ESTX7L-BS■	063069	FTX7L-BS■	
125	GPR Nude (GS1A1B)	2004/2006	065049	YTX5L-BS■	068049	ESTX5L-BS■	063049	FTX5L-BS■	
125	Mulhacen 4T (MS1A1A)	2007/2007	0650690	YTX7L-BS■	068069	ESTX7L-BS■	063069	FTX7L-BS■	
125	Mulhacen 4T (MS2A2A)	2008/2012	0650690	YTX7L-BS■	068069	ESTX7L-BS■	063069	FTX7L-BS■	
125	Mulhacen Café 4T (MS2A2A)	2008/2012	0650690	YTX7L-BS■	068069	ESTX7L-BS■	063069	FTX7L-BS■	
125	Rambla	2008/2012	0651090	YTX12-BS■	0681090	ESTX12-BS■	063109	FTX12-BS■	
125	Senda R 4T (SC1A1A)	2004/2004	0650690	YTX7L-BS■	068069	ESTX7L-BS■	063069	FTX7L-BS■	
125	Senda R 4T (SC1B1A)	2004/2007	0650690	YTX7L-BS■	068069	ESTX7L-BS■	063069	FTX7L-BS■	
125	Senda R Baja 4T (SC1C1A)	2006/2006	0650690	YTX7L-BS■	068069	ESTX7L-BS■	063069	FTX7L-BS■	
125	Senda R Baja 4T (SC1D1A)	2006/2009	0650690	YTX7L-BS■	068069	ESTX7L-BS■	063069	FTX7L-BS■	
125	Senda R Baja 4T (SC1E1A)	2010/2013	0650690	YTX7L-BS■	068069	ESTX7L-BS■	063069	FTX7L-BS■	
125	Senda R DRD 4T 4V (DR1A1A)	2010/2013	0650690	YTX7L-BS■	068069	ESTX7L-BS■	063069	FTX7L-BS■	
125	Senda SM 4T (SC2A1A)	2004/2004	0650690	YTX7L-BS■	068069	ESTX7L-BS■	063069	FTX7L-BS■	
125	Senda SM 4T (SC2B1A)	2004/2007	0650690	YTX7L-BS■	068069	ESTX7L-BS■	063069	FTX7L-BS■	
125	Senda SM Baja 4T (SC2C1A/ SC2D1A)	2006/2009	0650690	YTX7L-BS■	068069	ESTX7L-BS■	063069	FTX7L-BS■	
125	Senda SM Baja 4T (SC2E1A)	2010/2013	0650690	YTX7L-BS■	068069	ESTX7L-BS■	063069	FTX7L-BS■	
125	Senda SM DRD 4T 4V (DR2A1A)	2010/2013	0650690	YTX7L-BS■	068069	ESTX7L-BS■	063069	FTX7L-BS■	
125	Sonar	2009/2012	0651090	YTX12-BS■	0681090	ESTX12-BS■	063109	FTX12-BS■	
125	Terra 4T (TS1A1A)	2007/2012	0650690	YTX7L-BS■	068069	ESTX7L-BS■	063069	FTX7L-BS■	
125	Terra 4T Adventure (TS1A2B)	2007/2012	0650690	YTX7L-BS■	068069	ESTX7L-BS■	063069	FTX7L-BS■	
125	Variant Sport 4T E3 (SG000)	2012/2013	06509350	YB9-B	0680935	ESB9-B■	—	—	
150	Boulevard / Boulevard E3	2003/2012	06509350	YB9-B	0680935	ESB9-B■	—	—	
150	Sonar	2009/2012	0651090	YTX12-BS■	0681090	ESTX12-BS■	063109	FTX12-BS■	
200	Boulevard	2004/2008	06509350	YB9-B	0680935	ESB9-B■	—	—	
250	GP1	2005/2007	0651231	YB10L-BP	—	—	—	—	
250	GP1 E3 Low Seat	2007/2012	0651231	YB10L-BP	—	—	—	—	
250	Rambla	2008/2012	0651090	YTX12-BS■	0681090	ESTX12-BS■	063109	FTX12-BS■	
300	Rambla IE	2010/2013	0651090	YTX12-BS■	0681090	ESTX12-BS■	063109	FTX12-BS■	
660	Mulhacen	2006/2012	065014	YTZ14S▲	—	—	—	—	
660	Mulhacen	2006/2012	065914	TTZ14S-BS	068914	ESTTZ14S-BS■	—	—	



▲ - Factory Sealed / Attivata dalla Fabbrica ■ - con Acido a corredo ◇ - Non di produzione YUASA a completamento gamma

Marca / Cilindrata / Modello / Anno			Cod. SGR		Cod. SGR		Cod. SGR		
DUCATI									
125	Cross	1958/1960	0601433	B38-6A	—	—	—	—	
125	Cross	1958/1960	0661433	3R3 ◇▲	—	—	—	—	
125	Six Days 2T	1978/1978	0600413	6N4-2A-4	—	—	—	—	
175	Cross	1958/1960	0601433	B38-6A	—	—	—	—	
175	Cross	1958/1960	0661433	3R3 ◇▲	—	—	—	—	
200	Motocarro	TUTTI	0652433	12N24-3A	—	—	—	—	
200	Motocarro	TUTTI	0652711	6MC4 ◇	—	—	—	—	
250	Mark 3D	1967/>	0601433	B38-6A	—	—	—	—	
250	Mark 3D	1967/>	0661433	3R3 ◇▲	—	—	—	—	
250	Motocross Scrambler	1964/1966	0601433	B38-6A	—	—	—	—	
250	Motocross Scrambler	1964/1966	0661433	3R3 ◇▲	—	—	—	—	
250	Scrambler	1967/1976	0601433	B38-6A	—	—	—	—	
250	Scrambler	1967/1976	0661433	3R3 ◇▲	—	—	—	—	
350	F3 Desmo	1985/1987	065123	YTX14AHL-BS■	—	—	—	—	
350	F3 Desmo	1985/1987	0651434	YB14L-A2	0681434	ESB14L-A2■	—	—	
350	GTL Twin Parallelo	1976/1977	0651833	12N18-3	—	—	—	—	
350	GTL Twin Parallelo	1976/1977	0652034	Y50-N18L-A	0682034	ES50-N18L-A■	—	—	
350	GTL Twin Parallelo	1976/1977	065215	YTX24HL-BS■	—	—	—	—	
350	GTV Twin Parallelo Desmo	1978/1979	0651833	12N18-3	—	—	—	—	
350	GTV Twin Parallelo Desmo	1978/1979	0652034	Y50-N18L-A	0682034	ES50-N18L-A■	—	—	
350	GTV Twin Parallelo Desmo	1978/1979	065215	YTX24HL-BS■	—	—	—	—	
350	Indiana	1986/1986	065123	YTX14AHL-BS■	—	—	—	—	
350	Indiana	1986/1986	0651434	YB14L-A2	0681434	ESB14L-A2■	—	—	
350	Mark 3	1970/1976	0601433	B38-6A	—	—	—	—	
350	Mark 3	1970/1976	0661433	3R3 ◇▲	—	—	—	—	
350	Scrambler	1967/>	0601433	B38-6A	—	—	—	—	
350	Scrambler	1967/>	0661433	3R3 ◇▲	—	—	—	—	
350	SL Pantah	1983/>	065123	YTX14AHL-BS■	—	—	—	—	
350	SL Pantah	1983/>	0651434	YB14L-A2	0681434	ESB14L-A2■	—	—	
350	Sport Desmo Twin Parallelo	1977/1978	0651833	12N18-3	—	—	—	—	
350	Sport Desmo Twin Parallelo	1977/1978	0652034	Y50-N18L-A	0682034	ES50-N18L-A■	—	—	
350	Sport Desmo Twin Parallelo	1977/1978	065215	YTX24HL-BS■	—	—	—	—	
350	TL Pantah	1982/1984	065123	YTX14AHL-BS■	—	—	—	—	
350	TL Pantah	1982/1984	0651434	YB14L-A2	0681434	ESB14L-A2■	—	—	
350	XL Pantah	1982/1984	065123	YTX14AHL-BS■	—	—	—	—	
350	XL Pantah	1982/1984	0651434	YB14L-A2	0681434	ESB14L-A2■	—	—	
400	Monster	1996/2000	—	—	0681815	ESTX20-B4	—	—	
400	Monster	1996/2000	06516340	YB16AL-A2	0681634	ESB16AL-A2■	—	—	
400	Monster	2001/2003	0651100	YT12B-BS■	0681100	EST12B-BS■	—	—	
400	Scrambler Sixty2	2016/2016	0651100	YT12B-BS■	0681100	EST12B-BS■	—	—	
400	TS	TUTTI	0601433	B38-6A	—	—	—	—	



▲ - Factory Sealed / Attivata dalla Fabbrica ■ - con Acido a corredo ◇ - Non di produzione YUASA a completamento gamma

Marca / Cilindrata / Modello / Anno		Cod. SGR		Cod. SGR		Cod. SGR	
DUCATI							
400 TS	TUTTI	0661433	3R3 ◇▲	—	—	—	—
500 GTL Twin Parallelo	1976/1977	065123	YTX14AHL-BS■	—	—	—	—
500 GTL Twin Parallelo	1976/1977	0651434	YB14L-A2	0681434	ESB14L-A2■	—	—
500 GTL Twin Parallelo Desmo	1978/1979	0652034	Y50-N18L-A	0682034	ES50-N18L-A■	—	—
500 GTL Twin Parallelo Desmo	1978/1979	065215	YTX24HL-BS■	—	—	—	—
500 GTV Twin Parallelo Desmo	1978/1979	0651833	I2N18-3	—	—	—	—
500 GTV Twin Parallelo Desmo	1978/1979	0652034	Y50-N18L-A	0682034	ES50-N18L-A■	—	—
500 GTV Twin Parallelo Desmo	1978/1979	065215	YTX24HL-BS■	—	—	—	—
500 L Pantah	1979/1983	065123	YTX14AHL-BS■	—	—	—	—
500 L Pantah	1979/1983	0651434	YB14L-A2	0681434	ESB14L-A2■	—	—
500 SL Pantah	1983/1983	065123	YTX14AHL-BS■	—	—	—	—
500 SL Pantah	1983/1983	0651434	YB14L-A2	0681434	ESB14L-A2■	—	—
500 Sport Desmo Twin Parallelo	1977/1979	0652034	Y50-N18L-A	0682034	ES50-N18L-A■	—	—
500 Sport Desmo Twin Parallelo	1977/1979	065215	YTX24HL-BS■	—	—	—	—
600 L Pantah	1981/1982	065123	YTX14AHL-BS■	—	—	—	—
600 L Pantah	1981/1982	0651434	YB14L-A2	0681434	ESB14L-A2■	—	—
600 Monster	1994/1999	—	—	0681815	ESTX20-B4	—	—
600 Monster	1994/1999	06516340	YB16AL-A2	0681634	ESB16AL-A2■	—	—
600 Monster	2000/2001	0651100	YT12B-BS■	0681100	EST12B-BS■	—	—
600 Monster Vigili Urbani	1994/2001	0652015	52015	—	—	—	—
600 SL Pantah	1983/1984	065123	YTX14AHL-BS■	—	—	—	—
600 SL Pantah	1983/1984	0651434	YB14L-A2	0681434	ESB14L-A2■	—	—
600 Supersport	1991/1999	—	—	0681815	ESTX20-B4	—	—
600 Supersport	1991/1999	06516340	YB16AL-A2	0681634	ESB16AL-A2■	—	—
600 TL Pantah	1982/1983	065123	YTX14AHL-BS■	—	—	—	—
600 TL Pantah	1982/1983	0651434	YB14L-A2	0681434	ESB14L-A2■	—	—
620 Monster (M400AA/ M403AC)	2002/2004	0651100	YT12B-BS■	0681100	EST12B-BS■	—	—
620 Monster (M408AA/ M403AC)	2005/2006	0651100	YT12B-BS■	0681100	EST12B-BS■	—	—
620 Monster Dark	2002/2006	0651100	YT12B-BS■	0681100	EST12B-BS■	—	—
620 Multistrada	2005/2006	0651100	YT12B-BS■	0681100	EST12B-BS■	—	—
620 Sport / Sport H.F.	2003/2004	0651100	YT12B-BS■	0681100	EST12B-BS■	—	—
650 Indiana	1986/1990	065123	YTX14AHL-BS■	—	—	—	—
650 Indiana	1986/1990	0651434	YB14L-A2	0681434	ESB14L-A2■	—	—
695 Monster	2006/2008	0651100	YT12B-BS■	0681100	EST12B-BS■	—	—
696 Monster / ABS	2008/2014	0651100	YT12B-BS■	0681100	EST12B-BS■	—	—
748 748 BIP	1995/2000	—	—	0681815	ESTX20-B4	—	—
748 748 BIP	1995/2000	06516340	YB16AL-A2	0681634	ESB16AL-A2■	—	—
748 748 BIP	2001/2002	0651100	YT12B-BS■	0681100	EST12B-BS■	—	—
748 748 R	2000/2000	—	—	0681815	ESTX20-B4	—	—
748 748 R	2000/2000	06516340	YB16AL-A2	0681634	ESB16AL-A2■	—	—
748 748 R	2001/2002	0651100	YT12B-BS■	0681100	EST12B-BS■	—	—



▲ - Factory Sealed / Attivata dalla Fabbrica ■ - con Acido a corredo ◇ - Non di produzione YUASA a completamento gamma

Marca / Cilindrata / Modello / Anno			Cod. SGR		Cod. SGR		Cod. SGR		
DUCATI									
748	748 Racing	1998/1999	—	—	0681815	ESTX20-B4	—	—	
748	748 Racing	1998/1999	06516340	YB16AL-A2	0681634	ESB16AL-A2■	—	—	
748	748 RS	2000/2001	0651100	YT12B-BS■	0681100	EST12B-BS■	—	—	
748	748 S	2000/2000	—	—	0681815	ESTX20-B4	—	—	
748	748 S	2000/2000	06516340	YB16AL-A2	0681634	ESB16AL-A2■	—	—	
748	748 S	2001/2002	0651100	YT12B-BS■	0681100	EST12B-BS■	—	—	
748	748 SP	1995/1997	—	—	0681815	ESTX20-B4	—	—	
748	748 SP	1995/1997	06516340	YB16AL-A2	0681634	ESB16AL-A2■	—	—	
748	748 SPS	1998/1999	—	—	0681815	ESTX20-B4	—	—	
748	748 SPS	1998/1999	06516340	YB16AL-A2	0681634	ESB16AL-A2■	—	—	
748	749 / Dark	2003/2006	0651100	YT12B-BS■	0681100	EST12B-BS■	—	—	
748	749 R	2003/2006	0651100	YT12B-BS■	0681100	EST12B-BS■	—	—	
748	749 S	2003/2006	0651100	YT12B-BS■	0681100	EST12B-BS■	—	—	
750	F1	1985/1988	065123	YTX14AHL-BS■	—	—	—	—	
750	F1	1985/1988	0651434	YB14L-A2	0681434	ESB14L-A2■	—	—	
750	F1 Laguna Seca	1987/1987	065123	YTX14AHL-BS■	—	—	—	—	
750	F1 Laguna Seca	1987/1987	0651434	YB14L-A2	0681434	ESB14L-A2■	—	—	
750	F1 Montjuich	1986/1986	065123	YTX14AHL-BS■	—	—	—	—	
750	F1 Montjuich	1986/1986	0651434	YB14L-A2	0681434	ESB14L-A2■	—	—	
750	F1 Santamonica	1988/1988	065123	YTX14AHL-BS■	—	—	—	—	
750	F1 Santamonica	1988/1988	0651434	YB14L-A2	0681434	ESB14L-A2■	—	—	
750	GT	1971/1974	0651233	12N12A-4A-1	0681233	ES12N12A-4A-1■	—	—	
750	GT (avv.Elettrico)	1974/1974	0652433	12N24-3A	—	—	—	—	
750	GT (avv.Elettrico)	1974/1974	0652711	6MC4 ◇	—	—	—	—	
750	Indiana	1986/1991	065123	YTX14AHL-BS■	—	—	—	—	
750	Indiana	1986/1991	0651434	YB14L-A2	0681434	ESB14L-A2■	—	—	
750	Monster (M100AA)	1996/1999	—	—	0681815	ESTX20-B4	—	—	
750	Monster (M100AA)	1996/1999	06516340	YB16AL-A2	0681634	ESB16AL-A2■	—	—	
750	Monster (M100AA)	2000/2001	0651100	YT12B-BS■	0681100	EST12B-BS■	—	—	
750	Monster IE (M400AA)	2002/2002	0651100	YT12B-BS■	0681100	EST12B-BS■	—	—	
750	Paso	1986/1988	065123	YTX14AHL-BS■	—	—	—	—	
750	Paso	1986/1988	0651434	YB14L-A2	0681434	ESB14L-A2■	—	—	
750	Sport Desmo	1971/1974	0651233	12N12A-4A-1	0681233	ES12N12A-4A-1■	—	—	
750	Sport Desmo (avv.Elettrico)	1974/1974	0652433	12N24-3A	—	—	—	—	
750	Sport Desmo (avv.Elettrico)	1974/1974	0652711	6MC4 ◇	—	—	—	—	
750	Supersport (750SC)	1991/1997	—	—	0681815	ESTX20-B4	—	—	
750	Supersport (750SC)	1991/1997	06516340	YB16AL-A2	0681634	ESB16AL-A2■	—	—	
750	Supersport IE (V200AA)	1999/2000	—	—	0681815	ESTX20-B4	—	—	
750	Supersport IE (V200AA)	1999/2000	06516340	YB16AL-A2	0681634	ESB16AL-A2■	—	—	
750	Supersport IE (V200AA)	2001/2002	0651100	YT12B-BS■	0681100	EST12B-BS■	—	—	
796	Hypermotard	2009/2012	0651100	YT12B-BS■	0681100	EST12B-BS■	—	—	



▲ - Factory Sealed / Attivata dalla Fabbrica ■ - con Acido a corredo ◇ - Non di produzione YUASA a completamento gamma

Marca / Cilindrata / Modello / Anno			Cod. SGR		Cod. SGR		Cod. SGR	
DUCATI								
796	Monster / ABS	2010/2014	0651100	YT12B-BS■	0681100	EST12B-BS■	—	—
800	Monster IE / Dark IE	2003/2005	0651100	YT12B-BS■	0681100	EST12B-BS■	—	—
800	Monster S2R	2005/2007	0651100	YT12B-BS■	0681100	EST12B-BS■	—	—
800	Scrambler Icon/ Full Throttle	2015/2016	0651100	YT12B-BS■	0681100	EST12B-BS■	—	—
800	Scrambler Urban Enduro/ Classic	2015/2016	0651100	YT12B-BS■	0681100	EST12B-BS■	—	—
800	Sport	2003/2005	0651100	YT12B-BS■	0681100	EST12B-BS■	—	—
800	Supersport	2003/2005	0651100	YT12B-BS■	0681100	EST12B-BS■	—	—
803	Monster 797	2017/2017	0651100	YT12B-BS■	0681100	EST12B-BS■	—	—
821	Hypermotard	2013/2015	0651100	YT12B-BS■	0681100	EST12B-BS■	—	—
821	Hypermotard SP	2013/2015	0651100	YT12B-BS■	0681100	EST12B-BS■	—	—
821	Hyperstrada	2013/2015	0651100	YT12B-BS■	0681100	EST12B-BS■	—	—
821	Monster	2015/2016	0651100	YT12B-BS■	0681100	EST12B-BS■	—	—
848	848 / S	2008/2012	0651100	YT12B-BS■	0681100	EST12B-BS■	—	—
848	848 EVO	2010/2013	0651100	YT12B-BS■	0681100	EST12B-BS■	—	—
848	Streetfighter / S	2011/2015	0651100	YT12B-BS■	0681100	EST12B-BS■	—	—
851	851 SBK Biposto / Strada	1988/1992	—	—	0681815	ESTX20-B4	—	—
851	851 SBK Biposto / Strada	1988/1992	06516340	YB16AL-A2	0681634	ESB16AL-A2■	—	—
851	851 SBK SP	1988/1989	—	—	0681815	ESTX20-B4	—	—
851	851 SBK SP	1988/1989	06516340	YB16AL-A2	0681634	ESB16AL-A2■	—	—
860	GT	1975/1980	0651233	12N12A-4A-1	0681233	ES12N12A-4A-1■	—	—
860	GT	1975/1980	0652433	12N24-3A	—	—	—	—
860	GT	1975/1980	0652711	6MC4 ◇	—	—	—	—
888	851 SBK SP2	1990/1990	—	—	0681815	ESTX20-B4	—	—
888	851 SBK SP2	1990/1990	06516340	YB16AL-A2	0681634	ESB16AL-A2■	—	—
888	851 SBK SP3	1991/1991	—	—	0681815	ESTX20-B4	—	—
888	851 SBK SP3	1991/1991	06516340	YB16AL-A2	0681634	ESB16AL-A2■	—	—
899	Panigale	2014/2015	0650710	YT7B-BS■	068071	EST7B-BS■	—	—
900	GTS	1975/1979	0652434	Y60-N24-A	—	—	—	—
900	GTS	1975/1979	0652434	Y60-N24-A	—	—	—	—
900	Monster	1995/1999	06516340	YB16AL-A2	0681634	ESB16AL-A2■	—	—
900	Monster IE	2000/2002	0651100	YT12B-BS■	0681100	EST12B-BS■	—	—
900	Sport IE (V100AA)	2002/2002	0651100	YT12B-BS■	0681100	EST12B-BS■	—	—
900	SS Desmo	1978/1981	0651233	12N12A-4A-1	0681233	ES12N12A-4A-1■	—	—
900	SS Desmo Darmah	1980/1985	0652434	Y60-N24-A	—	—	—	—
900	SS Desmo Darmah	1980/1985	0652434	Y60-N24-A	—	—	—	—
900	Superlight	1991/1997	—	—	0681815	ESTX20-B4	—	—
900	Superlight	1991/1997	06516340	YB16AL-A2	0681634	ESB16AL-A2■	—	—
900	Supersport	1991/1997	06516340	YB16AL-A2	0681634	ESB16AL-A2■	—	—
900	Supersport	1991/1999	—	—	0681815	ESTX20-B4	—	—
900	SuperSport FE	1998/1998	—	—	0681815	ESTX20-B4	—	—
900	SuperSport FE	1998/1998	06516340	YB16AL-A2	0681634	ESB16AL-A2■	—	—



▲ - Factory Sealed / Attivata dalla Fabbrica ■ - con Acido a corredo ◇ - Non di produzione YUASA a completamento gamma

Marca / Cilindrata / Modello / Anno			Cod. SGR		Cod. SGR		Cod. SGR	
DUCATI								
900	SuperSport IE (V100AA)	2000/2000	—	—	0681815	ESTX20-B4	—	—
900	SuperSport IE (V100AA)	2000/2000	06516340	YB16AL-A2	0681634	ESB16AL-A2■	—	—
900	SuperSport IE (V100AA)	2001/2002	0651100	YT12B-BS■	0681100	EST12B-BS■	—	—
906	Paso	1988/1989	0650201	GYZ20H▲	—	—	—	—
906	Paso	1988/1989	0651638	YB16-B	0681638	ESB16-B■	—	—
906	Paso	1988/1989	065184	YTX20H-BS■	—	—	—	—
907	907 IE	1990/1992	0650201	GYZ20H▲	—	—	—	—
907	907 IE	1990/1992	0651638	YB16-B	0681638	ESB16-B■	—	—
907	907 IE	1990/1992	065184	YTX20H-BS■	—	—	—	—
916	916 S Senna I/ II/ III	1994/1998	—	—	0681815	ESTX20-B4	—	—
916	916 S Senna I/ II/ III	1994/1998	06516340	YB16AL-A2	0681634	ESB16AL-A2■	—	—
916	916 SP / SP3	1994/1996	—	—	0681815	ESTX20-B4	—	—
916	916 SP / SP3	1994/1996	06516340	YB16AL-A2	0681634	ESB16AL-A2■	—	—
916	916 Strada / Biposto	1994/1998	—	—	0681815	ESTX20-B4	—	—
916	916 Strada / Biposto	1994/1998	06516340	YB16AL-A2	0681634	ESB16AL-A2■	—	—
916	Monster S4	2001/2002	0651100	YT12B-BS■	0681100	EST12B-BS■	—	—
916	ST4	1998/2000	—	—	0681815	ESTX20-B4	—	—
916	ST4	1998/2000	06516340	YB16AL-A2	0681634	ESB16AL-A2■	—	—
916	ST4	2000/2003	0651100	YT12B-BS■	0681100	EST12B-BS■	—	—
937	Hypermotard 939	2016/2017	0651100	YT12B-BS■	0681100	EST12B-BS■	—	—
937	Multistrada 950	2017/2017	0651100	YT12B-BS■	0681100	EST12B-BS■	—	—
944	ST2	1997/2000	—	—	0681815	ESTX20-B4	—	—
944	ST2	1997/2000	06516340	YB16AL-A2	0681634	ESB16AL-A2■	—	—
944	ST2	2001/2003	0651100	YT12B-BS■	0681100	EST12B-BS■	—	—
955	Panigale 959	2016/2017	0650710	YT7B-BS■	068071	EST7B-BS■	—	—
992	ST3	2004/2007	0651100	YT12B-BS■	0681100	EST12B-BS■	—	—
996	916 SPS	1997/1998	—	—	0681815	ESTX20-B4	—	—
996	916 SPS	1997/1998	06516340	YB16AL-A2	0681634	ESB16AL-A2■	—	—
996	996 S	2001/2001	0651100	YT12B-BS■	0681100	EST12B-BS■	—	—
996	996 SPS II	1999/1999	—	—	0681815	ESTX20-B4	—	—
996	996 SPS II	1999/1999	06516340	YB16AL-A2	0681634	ESB16AL-A2■	—	—
996	996 SPS III	2000/2000	0651100	YT12B-BS■	0681100	EST12B-BS■	—	—
996	Monster S4 R	2003/2006	0651100	YT12B-BS■	0681100	EST12B-BS■	—	—
996	ST4 S	2001/2006	0651100	YT12B-BS■	0681100	EST12B-BS■	—	—
996	ST4 S abs	2003/2006	0651100	YT12B-BS■	0681100	EST12B-BS■	—	—
998	996 R testastretta	2001/2002	0651100	YT12B-BS■	0681100	EST12B-BS■	—	—
998	998	2002/2003	0651100	YT12B-BS■	0681100	EST12B-BS■	—	—
998	998 BIP Matrix	2004/2004	0651100	YT12B-BS■	0681100	EST12B-BS■	—	—
998	998 R	2002/2002	0651100	YT12B-BS■	0681100	EST12B-BS■	—	—
998	998 S Final Edition	2004/2004	0651100	YT12B-BS■	0681100	EST12B-BS■	—	—
998	998 S, Bayliss / Bostrom	2002/2003	0651100	YT12B-BS■	0681100	EST12B-BS■	—	—



▲ - Factory Sealed / Attivata dalla Fabbrica ■ - con Acido a corredo ◇ - Non di produzione YUASA a completamento gamma

Marca / Cilindrata / Modello / Anno			Cod. SGR		Cod. SGR		Cod. SGR	
DUCATI								
998 999	2003/2006	0651100	YT12B-BS■	0681100	EST12B-BS■	—	—	—
998 999 R	2003/2006	0651100	YT12B-BS■	0681100	EST12B-BS■	—	—	—
998 999 S	2003/2006	0651100	YT12B-BS■	0681100	EST12B-BS■	—	—	—
998 Monster S4 R	2007/2008	0651100	YT12B-BS■	0681100	EST12B-BS■	—	—	—
998 Monster S4 RS	2006/2008	0651100	YT12B-BS■	0681100	EST12B-BS■	—	—	—
1000 Desmosedici RR	2007/2008	0651100	YT12B-BS■	0681100	EST12B-BS■	—	—	—
1000 MHR Replica/ S2	1985/1985	0651233	12N12A-4A-1	0681233	EST12N12A-4A-1■	—	—	—
1000 Monster S	2003/2005	0651100	YT12B-BS■	0681100	EST12B-BS■	—	—	—
1000 Monster S2R	2006/2008	0651100	YT12B-BS■	0681100	EST12B-BS■	—	—	—
1000 Multistrada, DS	2003/2006	0651100	YT12B-BS■	0681100	EST12B-BS■	—	—	—
1000 Sport Classic GT	2007/2010	0651100	YT12B-BS■	0681100	EST12B-BS■	—	—	—
1000 Sport Classic Paul Smart LE	2006/2006	0651100	YT12B-BS■	0681100	EST12B-BS■	—	—	—
1000 Sport Classic S	2007/2009	0651100	YT12B-BS■	0681100	EST12B-BS■	—	—	—
1000 Sport Classic Single-SE	2006/2007	0651100	YT12B-BS■	0681100	EST12B-BS■	—	—	—
1000 Sport Classic Sport	2007/2008	0651100	YT12B-BS■	0681100	EST12B-BS■	—	—	—
1000 Supersport DS	2003/2006	0651100	YT12B-BS■	0681100	EST12B-BS■	—	—	—
1098 1098	2007/2008	0651100	YT12B-BS■	0681100	EST12B-BS■	—	—	—
1098 1098 S	2007/2008	0651100	YT12B-BS■	0681100	EST12B-BS■	—	—	—
1100 Hypermotard	2008/2009	0651100	YT12B-BS■	0681100	EST12B-BS■	—	—	—
1100 Hypermotard EVO	2010/2012	0651100	YT12B-BS■	0681100	EST12B-BS■	—	—	—
1100 Hypermotard EVO SP	2010/2012	0651100	YT12B-BS■	0681100	EST12B-BS■	—	—	—
1100 Hypermotard S	2008/2009	0651100	YT12B-BS■	0681100	EST12B-BS■	—	—	—
1100 Monster	2008/2010	0651100	YT12B-BS■	0681100	EST12B-BS■	—	—	—
1100 Monster EVO	2011/2013	0651100	YT12B-BS■	0681100	EST12B-BS■	—	—	—
1100 Monster S	2008/2010	0651100	YT12B-BS■	0681100	EST12B-BS■	—	—	—
1100 Multistrada	2007/2009	0651100	YT12B-BS■	0681100	EST12B-BS■	—	—	—
1100 Multistrada S	2007/2009	0651100	YT12B-BS■	0681100	EST12B-BS■	—	—	—
1100 Streetfighter / S	2009/2013	0651100	YT12B-BS■	0681100	EST12B-BS■	—	—	—
1198 1098 R	2008/2009	0651100	YT12B-BS■	0681100	EST12B-BS■	—	—	—
1198 1198	2009/2012	0651100	YT12B-BS■	0681100	EST12B-BS■	—	—	—
1198 1198 R	2010/2012	0651100	YT12B-BS■	0681100	EST12B-BS■	—	—	—
1198 1198 S	2009/2011	0651100	YT12B-BS■	0681100	EST12B-BS■	—	—	—
1198 1198 SP	2011/2011	0651100	YT12B-BS■	0681100	EST12B-BS■	—	—	—
1199 Panigale / S / ABS	2011/2015	0650710	YT7B-BS■	068071	EST7B-BS■	—	—	—
1199 Panigale R	2013/2013	0650710	YT7B-BS■	068071	EST7B-BS■	—	—	—
1199 Panigale Superleggera	2014/2014	—	—	—	—	—	—	—
1200 Diavel / Diavel Carbon	2011/2017	0651100	YT12B-BS■	0681100	EST12B-BS■	—	—	—
1200 Monster	2014/2017	0651100	YT12B-BS■	0681100	EST12B-BS■	—	—	—
1200 Monster R	2016/2017	0651100	YT12B-BS■	0681100	EST12B-BS■	—	—	—
1200 Monster S	2014/2017	0651100	YT12B-BS■	0681100	EST12B-BS■	—	—	—
1200 Multistrada	2010/2017	0651100	YT12B-BS■	0681100	EST12B-BS■	—	—	—

▲ - Factory Sealed / Attivata dalla Fabbrica ■ - con Acido a corredo ◇ - Non di produzione YUASA a completamento gamma

Marca / Cilindrata / Modello / Anno			Cod. SGR		Cod. SGR		Cod. SGR		
DUCATI									
1200	Multistrada Enduro	2016/2017	0651100	YT12B-BS■	0681100	EST12B-BS■	—	—	
1200	Multistrada S	2010/2017	0651100	YT12B-BS■	0681100	EST12B-BS■	—	—	
1262	XDiavel	2016/2017	0651100	YT12B-BS■	0681100	EST12B-BS■	—	—	
1262	XDiavel S	2016/2017	0651100	YT12B-BS■	0681100	EST12B-BS■	—	—	
1299	Panigale / S / ABS	2015/2017	0650710	YT7B-BS■	068071	EST7B-BS■	—	—	
1299	Panigale 90 Anniversario	2017/2017	—	—	—	—	—	—	
E-TON									
50	AXL / NXL / TXL Lightning/ D 2T	1999/2001	0650390	YTX4L-BS■	068039	ESTX4L-BS■	—	—	
50	Beamer 2T (PN2)	2000/2004	065049	YTX5L-BS■	068049	ESTX5L-BS■	063049	FTX5L-BS■	
50	Beamer II 2T (PN2B)	2005/2006	065049	YTX5L-BS■	068049	ESTX5L-BS■	063049	FTX5L-BS■	
50	Beamer III 2T (PN2D)	2007/2009	065049	YTX5L-BS■	068049	ESTX5L-BS■	063049	FTX5L-BS■	
50	Beamer Matrix 2T (PN2C)	2005/2006	065049	YTX5L-BS■	068049	ESTX5L-BS■	063049	FTX5L-BS■	
50	Beamer Matrix II 2T (PN2E)	2007/2008	065049	YTX5L-BS■	068049	ESTX5L-BS■	063049	FTX5L-BS■	
50	RXL Viper/ M 2T	2002/2005	0650390	YTX4L-BS■	068039	ESTX4L-BS■	—	—	
50	TXL Impuls 2T	TUTTI	0650390	YTX4L-BS■	068039	ESTX4L-BS■	—	—	
90	AXL Lightning 2T	TUTTI	065049	YTX5L-BS■	068049	ESTX5L-BS■	063049	FTX5L-BS■	
90	AXL / NXL / TXL Thunder/ D 2T	1999/2001	065049	YTX5L-BS■	068049	ESTX5L-BS■	063049	FTX5L-BS■	
90	DXL Sierra/ U 2T	2000/2003	0650390	YTX4L-BS■	068039	ESTX4L-BS■	—	—	
90	RXL Viper/ R 2T	2002/2006	065049	YTX5L-BS■	068049	ESTX5L-BS■	063049	FTX5L-BS■	
90	TXL Impuls 2T	TUTTI	065049	YTX5L-BS■	068049	ESTX5L-BS■	063049	FTX5L-BS■	
150	CXL Yukon II 4T	2002/2010	0650990	YTX9-BS■	068099	ESTX9-BS■	063099	FTX9-BS■	
150	EXL Yukon ST 4T	2000/2003	0650990	YTX9-BS■	068099	ESTX9-BS■	063099	FTX9-BS■	
150	RXL-4S Viper 4T	TUTTI	0650990	YTX9-BS■	068099	ESTX9-BS■	063099	FTX9-BS■	
150	RXL-R Viper R 4T	2005/2009	0650990	YTX9-BS■	068099	ESTX9-BS■	063099	FTX9-BS■	
150	YXL Yukon 4T	2000/2001	0650990	YTX9-BS■	068099	ESTX9-BS■	063099	FTX9-BS■	
250	VXL Vector ST	2010/2010	0651090	YTX12-BS■	0681090	ESTX12-BS■	063109	FTX12-BS■	
ERING									
50	BT49QT-12C1 Warrior 4T R12	2006/2008	0650700	YTX7A-BS■	068070	ESTX7A-BS■	—	—	
50	BT49QT-12D1 Hero 4T R12	2007/2008	0650700	YTX7A-BS■	068070	ESTX7A-BS■	—	—	
50	BT49QT-12E/ 1/ 2/ 3 Rocky 4T R12	2007/2008	0650700	YTX7A-BS■	068070	ESTX7A-BS■	—	—	
50	BT49QT-12F1 Tanco 4T R12	2007/2008	0650700	YTX7A-BS■	068070	ESTX7A-BS■	—	—	
50	BT49QT-2 Big Panther 4T	2006/2007	0650700	YTX7A-BS■	068070	ESTX7A-BS■	—	—	
50	BT49QT-7 AI Smart Rider 4T	2005/2008	0650700	YTX7A-BS■	068070	ESTX7A-BS■	—	—	
FANTIC MOTOR									
50	HP 1	TUTTI	06504340	YB4L-B	—	—	—	—	
50	HP 1	TUTTI	065043410	YB4L-B■	0680434	ESB4L-B■	—	—	
50	Koala	1987/>	06504340	YB4L-B	—	—	—	—	
50	Koala	1987/>	065043410	YB4L-B■	0680434	ESB4L-B■	—	—	
50	Oasis	1990/>	06504340	YB4L-B	—	—	—	—	
50	Oasis	1990/>	065043410	YB4L-B■	0680434	ESB4L-B■	—	—	
50	Oasis EPV	1990/>	0650634	12N5.5-3B	0680634	ES12N5.5-3B■	—	—	



▲ - Factory Sealed / Attivata dalla Fabbrica ■ - con Acido a corredo ◇ - Non di produzione YUASA a completamento gamma

Marca / Cilindrata / Modello / Anno		Cod. SGR		Cod. SGR		Cod. SGR	
FANTIC MOTOR							
50 TX 220	TUTTI	0600715	B39-6	—	—	—	—
125 Raider LC	1985/>	0650334	YB3L-A	0680334	ESB3L-A■	—	—
125 Sport HP1	1985/1985	0600412	6N4B-2A	—	—	—	—
125 Strada LC	1985/1985	0600412	6N4B-2A	—	—	—	—
250 Raider LC	1985/>	0650334	YB3L-A	0680334	ESB3L-A■	—	—
GARELLI							
50 Big Wheel	TUTTI	06504340	YB4L-B	—	—	—	—
50 Big Wheel	TUTTI	065043410	YB4L-B■	0680434	ESB4L-B■	—	—
50 BT49QT-12 Vip 4T	2006/2006	0650690	YTX7L-BS■	068069	ESTX7L-BS■	063069	FTX7L-BS■
50 BT49QT-12A Vip 4T	2007/2008	0650690	YTX7L-BS■	068069	ESTX7L-BS■	063069	FTX7L-BS■
50 BT50QT-11 Capri LX 4T	2006/2007	0650690	YTX7L-BS■	068069	ESTX7L-BS■	063069	FTX7L-BS■
50 BT50QT-9 Ciclone 4T	2006/2006	0650690	YTX7L-BS■	068069	ESTX7L-BS■	063069	FTX7L-BS■
50 DF50QT-7 Capri 4T	2006/2006	0650690	YTX7L-BS■	068069	ESTX7L-BS■	063069	FTX7L-BS■
50 GFM50QT-3 Tiesse 4T	2008/2009	0650990	YTX9-BS■	068099	ESTX9-BS■	063099	FTX9-BS■
50 GFM50QT2 Tiesse 2T/ Spec.Ed.	2008/2009	0650990	YTX9-BS■	068099	ESTX9-BS■	063099	FTX9-BS■
50 GFM50QT2.2 Rider 2T	2008/2009	0650990	YTX9-BS■	068099	ESTX9-BS■	063099	FTX9-BS■
50 GFM50QT2.R Tiesse R 2T	2008/2009	0650990	YTX9-BS■	068099	ESTX9-BS■	063099	FTX9-BS■
50 Grinta	1996/>	06504340	YB4L-B	—	—	—	—
50 Grinta	1996/>	065043410	YB4L-B■	0680434	ESB4L-B■	—	—
50 HN50QT-K/ R Flexi 4T	2008/2009	0650990	YTX9-BS■	068099	ESTX9-BS■	063099	FTX9-BS■
50 Noi	1985/1992	06504340	YB4L-B	—	—	—	—
50 Noi	1985/1992	065043410	YB4L-B■	0680434	ESB4L-B■	—	—
50 Pony/ Pony SR	1995/>	06504340	YB4L-B	—	—	—	—
50 Pony/ Pony SR	1995/>	065043410	YB4L-B■	0680434	ESB4L-B■	—	—
50 Queenie	1996/>	06504340	YB4L-B	—	—	—	—
50 Queenie	1996/>	065043410	YB4L-B■	0680434	ESB4L-B■	—	—
50 Racing	TUTTI	06504340	YB4L-B	—	—	—	—
50 Racing	TUTTI	065043410	YB4L-B■	0680434	ESB4L-B■	—	—
50 Sahel	1991/>	06504340	YB4L-B	—	—	—	—
50 Sahel	1991/>	065043410	YB4L-B■	0680434	ESB4L-B■	—	—
50 Team	TUTTI	06504340	YB4L-B	—	—	—	—
50 Team	TUTTI	065043410	YB4L-B■	0680434	ESB4L-B■	—	—
50 Tiger XLE	1986/>	06504340	YB4L-B	—	—	—	—
50 Tiger XLE	1986/>	065043410	YB4L-B■	0680434	ESB4L-B■	—	—
50 TM50QT-10 Capri LX 4T	2008/2009	0650990	YTX9-BS■	068099	ESTX9-BS■	063099	FTX9-BS■
50 TM50QT-3 Ciclone 4T	2008/2008	0650690	YTX7L-BS■	068069	ESTX7L-BS■	063069	FTX7L-BS■
50 TM50QTA GSP LC 2T E2	2009/2009	0650990	YTX9-BS■	068099	ESTX9-BS■	063099	FTX9-BS■
50 Urka	1991/>	06504340	YB4L-B	—	—	—	—
50 Urka	1991/>	065043410	YB4L-B■	0680434	ESB4L-B■	—	—
125 BT125T-2 Tiger	2007/2008	0650690	YTX7L-BS■	068069	ESTX7L-BS■	063069	FTX7L-BS■
125 BT125T-7 Comfort	2007/2008	0650690	YTX7L-BS■	068069	ESTX7L-BS■	063069	FTX7L-BS■
125 GTA	1985/1987	0650534	YB5L-B	0680534	ESB5L-B■	—	—



▲ - Factory Sealed / Attivata dalla Fabbrica ■ - con Acido a corredo ◇ - Non di produzione YUASA a completamento gamma

Marca / Cilindrata / Modello / Anno			Cod. SGR		Cod. SGR		Cod. SGR		
GARELLI									
125	GTA	1985/1987	06509350	YB9-B	0680935	ESB9-B■	—	—	
125	Tiger XLE	1986/>	0650533	12N5-3B	—	—	—	—	
125	Tiger XLE	1986/>	06509350	YB9-B	0680935	ESB9-B■	—	—	
125	TM125T-28A Noi	2008/2009	0650990	YTX9-BS■	068099	ESTX9-BS■	063099	FTX9-BS■	
125	TM125T-28X XO'	2009/2010	0650990	YTX9-BS■	068099	ESTX9-BS■	063099	FTX9-BS■	
125	TM125T-29A Tiesse	2008/2009	0650990	YTX9-BS■	068099	ESTX9-BS■	063099	FTX9-BS■	
125	TSR	TUTTI	0650735	12N7-4B	—	—	—	—	
150	BT150T-1 King	2007/2008	0650690	YTX7L-BS■	068069	ESTX7L-BS■	063069	FTX7L-BS■	
150	TM150T-28X XO'	2009/2010	0650990	YTX9-BS■	068099	ESTX9-BS■	063099	FTX9-BS■	
150	TM152T-28A Noi	2008/2009	0650990	YTX9-BS■	068099	ESTX9-BS■	063099	FTX9-BS■	
150	TM152T-29A Tiesse	2008/2009	0650990	YTX9-BS■	068099	ESTX9-BS■	063099	FTX9-BS■	
GAS GAS									
200	EC 2T	2014/2015	065007	YTZ7S▲	—	—	063007	FTZ7S▲	
250	EC / EC F 4T	2010/2015	065007	YTZ7S▲	—	—	063007	FTZ7S▲	
250	EC 2T	2014/2015	065007	YTZ7S▲	—	—	063007	FTZ7S▲	
300	EC 2T	2014/2015	065007	YTZ7S▲	—	—	063007	FTZ7S▲	
300	EC F 4T	2012/2015	065007	YTZ7S▲	—	—	063007	FTZ7S▲	
400	FSE EC	2003/2009	065007	YTZ7S▲	—	—	063007	FTZ7S▲	
450	EC F 4T	2012/2015	065007	YTZ7S▲	—	—	063007	FTZ7S▲	
450	FSE EC	2002/2012	065007	YTZ7S▲	—	—	063007	FTZ7S▲	
450	FSE SM	2003/2009	065007	YTZ7S▲	—	—	063007	FTZ7S▲	
450	FSR EC	2008/2009	065007	YTZ7S▲	—	—	063007	FTZ7S▲	
450	FSR SM	2008/2009	065007	YTZ7S▲	—	—	063007	FTZ7S▲	
450	Pampera	2007/2008	065007	YTZ7S▲	—	—	063007	FTZ7S▲	
450	Wild H.P.	2003/2006	065007	YTZ7S▲	—	—	063007	FTZ7S▲	
515	FSR EC	2008/2009	065007	YTZ7S▲	—	—	063007	FTZ7S▲	
515	FSR SM	2008/2009	065007	YTZ7S▲	—	—	063007	FTZ7S▲	
GILERA									
50	503	1991/>	06504340	YB4L-B	—	—	—	—	
50	503	1991/>	065043410	YB4L-B■	0680434	ESB4L-B■	—	—	
50	Bullit	1990/>	06504340	YB4L-B	—	—	—	—	
50	Bullit	1990/>	065043410	YB4L-B■	0680434	ESB4L-B■	—	—	
50	DNA	2000/2007	0650390	YTX4L-BS■	068039	ESTX4L-BS■	—	—	
50	Eaglet	1996/>	06504340	YB4L-B	—	—	—	—	
50	Eaglet	1996/>	065043410	YB4L-B■	0680434	ESB4L-B■	—	—	
50	Easy Moving	1995/1996	06504340	YB4L-B	—	—	—	—	
50	Easy Moving	1995/1996	065043410	YB4L-B■	0680434	ESB4L-B■	—	—	
50	GSA	1982/>	06504340	YB4L-B	—	—	—	—	
50	GSA	1982/>	065043410	YB4L-B■	0680434	ESB4L-B■	—	—	
50	ICE	2001/2005	0650390	YTX4L-BS■	068039	ESTX4L-BS■	—	—	
50	RC Top Rally	1990/1990	06504340	YB4L-B	—	—	—	—	



▲ - Factory Sealed / Attivata dalla Fabbrica ■ - con Acido a corredo ◇ - Non di produzione YUASA a completamento gamma

Marca / Cilindrata / Modello / Anno			Cod. SGR		Cod. SGR		Cod. SGR	
GILERA								
50	RC Top Rally	1990/1990	065043410	YB4L-B■	0680434	ESB4L-B■	—	—
50	Runner DD/ DT	1997/1998	06504340	YB4L-B	—	—	—	—
50	Runner DD/ DT	1997/1998	065043410	YB4L-B■	0680434	ESB4L-B■	—	—
50	Runner FL (C36200)	2002/2002	06509350	YB9-B	0680935	ESB9-B■	—	—
50	Runner Poggiali (C36200)	2002/2002	0650390	YTX4L-BS■	068039	ESTX4L-BS■	—	—
50	Runner Purejet / Race (C36100)	2002/2004	06509350	YB9-B	0680935	ESB9-B■	—	—
50	Runner Purejet / Race (C46200)	2005/2012	06509350	YB9-B	0680935	ESB9-B■	—	—
50	Runner Purejet ST (C46200)	2008/2010	06509350	YB9-B	0680935	ESB9-B■	—	—
50	Runner SP DD/ DT	1999/2000	06504340	YB4L-B	—	—	—	—
50	Runner SP DD/ DT	1999/2000	065043410	YB4L-B■	0680434	ESB4L-B■	—	—
50	Runner SP Race (C46100)	2005/2008	06509350	YB9-B	0680935	ESB9-B■	—	—
50	Runner SP Special Edition (C46100)	2007/2007	06509350	YB9-B	0680935	ESB9-B■	—	—
50	Runner SP ST (C46100)	2008/2013	06509350	YB9-B	0680935	ESB9-B■	—	—
50	Sioux	1992/1992	06504340	YB4L-B	—	—	—	—
50	Sioux	1992/1992	065043410	YB4L-B■	0680434	ESB4L-B■	—	—
50	Stalker DD/ DT	1997/2002	0650390	YTX4L-BS■	068039	ESTX4L-BS■	—	—
50	Stalker DD/ DT	1997/2002	06504340	YB4L-B	—	—	—	—
50	Stalker DD/ DT	1997/2002	065043410	YB4L-B■	0680434	ESB4L-B■	—	—
50	Stalker Hiper2	2003/2008	06504340	YB4L-B	—	—	—	—
50	Stalker Hiper2	2003/2008	065043410	YB4L-B■	0680434	ESB4L-B■	—	—
50	Stalker Naked	2008/2008	06504340	YB4L-B	—	—	—	—
50	Stalker Naked	2008/2008	065043410	YB4L-B■	0680434	ESB4L-B■	—	—
50	Stalker Special Edition	2007/2008	06504340	YB4L-B	—	—	—	—
50	Stalker Special Edition	2007/2008	065043410	YB4L-B■	0680434	ESB4L-B■	—	—
50	Storm	1993/1996	06504340	YB4L-B	—	—	—	—
50	Storm	1993/1996	065043410	YB4L-B■	0680434	ESB4L-B■	—	—
50	Storm E2	2007/2008	06509350	YB9-B	0680935	ESB9-B■	—	—
50	Typhoon	1994/1997	06504340	YB4L-B	—	—	—	—
50	Typhoon	1994/1997	065043410	YB4L-B■	0680434	ESB4L-B■	—	—
50	Typhoon E2	2001/2010	0650390	YTX4L-BS■	068039	ESTX4L-BS■	—	—
50	Typhoon E2	2001/2010	06504340	YB4L-B	—	—	—	—
50	Typhoon E2	2001/2010	065043410	YB4L-B■	0680434	ESB4L-B■	—	—
50	Typhoon X	1998/1999	06504340	YB4L-B	—	—	—	—
50	Typhoon X	1998/1999	065043410	YB4L-B■	0680434	ESB4L-B■	—	—
50	Typhoon XR	2000/2000	0650390	YTX4L-BS■	068039	ESTX4L-BS■	—	—
50	Typhoon XR	2000/2000	06504340	YB4L-B	—	—	—	—
50	Typhoon XR	2000/2000	065043410	YB4L-B■	0680434	ESB4L-B■	—	—
125	Apache	1991/>	0650634	12N5.5-3B	0680634	ES12N5.5-3B■	—	—
125	Crono	1987/1989	0650634	12N5.5-3B	0680634	ES12N5.5-3B■	—	—
125	Crono	1992/>	06509350	YB9-B	0680935	ESB9-B■	—	—
125	CX	1991/>	0650634	12N5.5-3B	0680634	ES12N5.5-3B■	—	—

▲ - Factory Sealed / Attivata dalla Fabbrica ■ - con Acido a corredo ◇ - Non di produzione YUASA a completamento gamma

Marca / Cilindrata / Modello / Anno		Cod. SGR		Cod. SGR		Cod. SGR	
GILERA							
125 CX	1991/>	06509350	YB9-B	0680935	ESB9-B■	—	—
125 DNA	2001/>	0651135	YB10L-B	0681135	ESB10L-B■	—	—
125 Fast Bike	1986/1988	0650634	12N5.5-3B	0680634	ES12N5.5-3B■	—	—
125 Fast Bike	1987/1989	06509350	YB9-B	0680935	ESB9-B■	—	—
125 Freestyle	1986/1987	0650634	12N5.5-3B	0680634	ES12N5.5-3B■	—	—
125 Freestyle	1992/>	06509350	YB9-B	0680935	ESB9-B■	—	—
125 GFR	1986/>	0650634	12N5.5-3B	0680634	ES12N5.5-3B■	—	—
125 GFR	1986/>	06509350	YB9-B	0680935	ESB9-B■	—	—
125 GRI	1976/1982	0601113	6N11A-3A	—	—	—	—
125 KK	1986/1989	0650634	12N5.5-3B	0680634	ES12N5.5-3B■	—	—
125 KK	1986/1989	06509350	YB9-B	0680935	ESB9-B■	—	—
125 KZ	1986/1989	0650634	12N5.5-3B	0680634	ES12N5.5-3B■	—	—
125 KZ	1986/1989	06509350	YB9-B	0680935	ESB9-B■	—	—
125 MX1	1989/1990	0650634	12N5.5-3B	0680634	ES12N5.5-3B■	—	—
125 MX1	1989/1990	06509350	YB9-B	0680935	ESB9-B■	—	—
125 MXR	1990/>	0650634	12N5.5-3B	0680634	ES12N5.5-3B■	—	—
125 MXR	1990/>	06509350	YB9-B	0680935	ESB9-B■	—	—
125 Nexus	2007/2008	0651090	YTX12-BS■	0681090	ESTX12-BS■	063109	FTX12-BS■
125 Nexus IE E3	2008/2012	065124	YTX14H-BS■	—	—	—	—
125 Nexus IE E3	2008/2012	065129	YTX14-BS■	068129	ESTX14-BS■	—	—
125 RI/ RIS	1989/>	0650634	12N5.5-3B	0680634	ES12N5.5-3B■	—	—
125 RI/ RIS	1989/>	06509350	YB9-B	0680935	ESB9-B■	—	—
125 RC Top Rally	1985/1987	0650634	12N5.5-3B	0680634	ES12N5.5-3B■	—	—
125 RC Top Rally	1990/>	06509350	YB9-B	0680935	ESB9-B■	—	—
125 RRT Nebraska	1986/1988	0650634	12N5.5-3B	0680634	ES12N5.5-3B■	—	—
125 RRT Nebraska	1986/1988	06509350	YB9-B	0680935	ESB9-B■	—	—
125 RTX	1986/1987	0650634	12N5.5-3B	0680634	ES12N5.5-3B■	—	—
125 RTX	1986/1987	06509350	YB9-B	0680935	ESB9-B■	—	—
125 Runner FX	1997/2002	06509350	YB9-B	0680935	ESB9-B■	—	—
125 Runner SP	1997/2002	06509350	YB9-B	0680935	ESB9-B■	—	—
125 Runner VX 4T	2000/2001	0651090	YTX12-BS■	0681090	ESTX12-BS■	063109	FTX12-BS■
125 Runner VX 4T	2002/2004	06509350	YB9-B	0680935	ESB9-B■	—	—
125 Runner VX SC / Race / ST 4T (46100/M46301)	2005/2007	06509350	YB9-B	0680935	ESB9-B■	—	—
125 Runner VX SC / Race / ST 4T (46100/M46301)	2008/2014	0651090	YTX12-BS■	0681090	ESTX12-BS■	063109	FTX12-BS■
125 RV	1984/1987	0650634	12N5.5-3B	0680634	ES12N5.5-3B■	—	—
125 RV	1984/1987	06509350	YB9-B	0680935	ESB9-B■	—	—
125 RX	1984/1986	0650634	12N5.5-3B	0680634	ES12N5.5-3B■	—	—
125 RX	1984/1986	06509350	YB9-B	0680935	ESB9-B■	—	—
125 RX Arizona	1986/>	06509350	YB9-B	0680935	ESB9-B■	—	—
125 RX Arizona	1992/>	0650634	12N5.5-3B	0680634	ES12N5.5-3B■	—	—
125 SC	2006/2006	065049	YTX5L-BS■	068049	ESTX5L-BS■	063049	FTX5L-BS■

▲ - Factory Sealed / Attivata dalla Fabbrica ■ - con Acido a corredo ◇ - Non di produzione YUASA a completamento gamma

Marca / Cilindrata / Modello / Anno		Cod. SGR		Cod. SGR		Cod. SGR	
GILERA							
125 SP 01	1990/>	06509350	YB9-B	0680935	ESB9-B■	—	—
125 SP 02	1990/>	06509350	YB9-B	0680935	ESB9-B■	—	—
125 TG1	1976/1982	0601113	6N11A-3A	—	—	—	—
125 Typhoon	1995/1998	0650736	YB7-A	0680736	ESB7-A■	—	—
125 Typhoon X	1995/>	06509350	YB9-B	0680935	ESB9-B■	—	—
125 XR1	1988/>	0650634	12N5.5-3B	0680634	ES12N5.5-3B■	—	—
125 XR1	1988/>	06509350	YB9-B	0680935	ESB9-B■	—	—
125 XR2	1988/>	0650634	12N5.5-3B	0680634	ES12N5.5-3B■	—	—
125 XR2	1988/>	06509350	YB9-B	0680935	ESB9-B■	—	—
180 DNA 4T	2001/>	0651135	YB10L-B	0681135	ESB10L-B■	—	—
180 Runner FXR	1997/2002	0651135	YB10L-B	0681135	ESB10L-B■	—	—
180 Runner SP	1999/2002	0651135	YB10L-B	0681135	ESB10L-B■	—	—
180 Runner VXR 4T	2000/2001	0651090	YTX12-BS■	0681090	ESTX12-BS■	063109	FTX12-BS■
200 Fast Bike	1985/1987	06509350	YB9-B	0680935	ESB9-B■	—	—
200 Fast Bike	1990/>	0650634	12N5.5-3B	0680634	ES12N5.5-3B■	—	—
200 Motocarro	TUTTI	0601433	B38-6A	—	—	—	—
200 Motocarro	TUTTI	0661433	3R3 ◇▲	—	—	—	—
200 RTX	1985/1987	0650634	12N5.5-3B	0680634	ES12N5.5-3B■	—	—
200 RTX	1985/1987	06509350	YB9-B	0680935	ESB9-B■	—	—
200 Runner VXR 4T	2002/2006	0651135	YB10L-B	0681135	ESB10L-B■	—	—
200 Runner VXR Race / ST 4T E3	2006/2007	0651135	YB10L-B	0681135	ESB10L-B■	—	—
200 Runner VXR Race / ST 4T E3	2008/2013	0651090	YTX12-BS■	0681090	ESTX12-BS■	063109	FTX12-BS■
200 RV	1985/1987	0650634	12N5.5-3B	0680634	ES12N5.5-3B■	—	—
200 RX Arizona	1984/1986	0650634	12N5.5-3B	0680634	ES12N5.5-3B■	—	—
200 RX Arizona	1985/1987	06509350	YB9-B	0680935	ESB9-B■	—	—
200 T4	1979/1984	0650634	12N5.5-3B	0680634	ES12N5.5-3B■	—	—
250 Arizona Rally	TUTTI	0651135	YB10L-B	0681135	ESB10L-B■	—	—
250 Nexus IE E3 (M35300)	2006/2006	065123	YTX14AHL-BS■	—	—	—	—
250 Nexus IE E3 (M35300)	2006/2006	0651434	YB14L-A2	0681434	ESB14L-A2■	—	—
250 Nexus IE E3 (M35400)	2007/2008	065124	YTX14H-BS■	—	—	—	—
250 Nexus IE E3 (M35400)	2007/2008	065129	YTX14-BS■	068129	ESTX14-BS■	—	—
250 Nexus SP IE E3 (M35300)	2006/2007	065123	YTX14AHL-BS■	—	—	—	—
250 Nexus SP IE E3 (M35300)	2006/2007	0651434	YB14L-A2	0681434	ESB14L-A2■	—	—
250 RV NGR	1986/>	0650634	12N5.5-3B	0680634	ES12N5.5-3B■	—	—
250 RV NGR	1986/>	0651135	YB10L-B	0681135	ESB10L-B■	—	—
300 Nexus IE E3	2008/2008	065124	YTX14H-BS■	—	—	—	—
300 Nexus IE E3	2008/2008	065129	YTX14-BS■	068129	ESTX14-BS■	—	—
300 Nexus IE E3	2009/2013	0651090	YTX12-BS■	0681090	ESTX12-BS■	063109	FTX12-BS■
350 Dakota	1986/>	0650634	12N5.5-3B	0680634	ES12N5.5-3B■	—	—
350 Dakota	1986/>	0651134	YB10L-A2	0681134	ESB10L-A2■	—	—
350 ER	1987/>	0650634	12N5.5-3B	0680634	ES12N5.5-3B■	—	—

▲ - Factory Sealed / Attivata dalla Fabbrica ■ - con Acido a corredo ◇ - Non di produzione YUASA a completamento gamma

Marca / Cilindrata / Modello / Anno	Cod. SGR		Cod. SGR		Cod. SGR	
--	-----------------	--	-----------------	--	-----------------	--



GILERA

350 ER	1987/>	0651134	YB10L-A2	0681134	ESB10L-A2 ■	—	—
350 XRT	1988/>	065123	YTX14AHL-BS ■	—	—	—	—
350 XRT	1988/>	0651434	YB14L-A2	0681434	ESB14L-A2 ■	—	—
500 Dakota	1985/>	0650634	12N5.5-3B	0680634	ES12N5.5-3B ■	—	—
500 Dakota	1985/>	0651134	YB10L-A2	0681134	ESB10L-A2 ■	—	—
500 ER	1987/>	0650634	12N5.5-3B	0680634	ES12N5.5-3B ■	—	—
500 ER	1987/>	0651134	YB10L-A2	0681134	ESB10L-A2 ■	—	—
500 Fuoco IE (M61100)	2010/2013	065124	YTX14H-BS ■	—	—	—	—
500 Fuoco IE (M61100)	2010/2013	065129	YTX14-BS ■	068129	ESTX14-BS ■	—	—
500 Fuoco IE (M61100)	2007/2011	065168	YTX16-BS ■	068168	ESTX16-BS ■	—	—
500 Nexus / Nexus E3 / Nexus SP E3	2003/2012	065123	YTX14AHL-BS ■	—	—	—	—
500 Nexus / Nexus E3 / Nexus SP E3	2003/2012	0651434	YB14L-A2	0681434	ESB14L-A2 ■	—	—
600 Northwest	1993/1993	065123	YTX14AHL-BS ■	—	—	—	—
600 Northwest	1993/1993	0651434	YB14L-A2	0681434	ESB14L-A2 ■	—	—
600 RC C	1993/1993	065123	YTX14AHL-BS ■	—	—	—	—
600 RC C	1993/1993	0651434	YB14L-A2	0681434	ESB14L-A2 ■	—	—
600 RC Top Rally	1990/>	065123	YTX14AHL-BS ■	—	—	—	—
600 RC Top Rally	1990/>	0651434	YB14L-A2	0681434	ESB14L-A2 ■	—	—
600 XRT	1989/1989	065123	YTX14AHL-BS ■	—	—	—	—
600 XRT	1989/1989	0651434	YB14L-A2	0681434	ESB14L-A2 ■	—	—
800 GP	2008/2009	065168	YTX16-BS ■	068168	ESTX16-BS ■	—	—
800 GP	2009/2013	065124	YTX14H-BS ■	—	—	—	—
800 GP	2009/2013	065129	YTX14-BS ■	068129	ESTX14-BS ■	—	—



HARLEY DAVIDSON

500 Mt500 (Military)	2000/2000	065123	YTX14AHL-BS ■	—	—	—	—
883 XL Sportster	1997/2003	0650202	GYZ20HL ▲	—	—	—	—
883 XL Sportster	1997/2003	065185	YTX20HL-BS ■	—	—	—	—
883 XL Sportster	1997/2003	065209	YTX20L-BS ■	068209	ESTX20L-BS ■	—	—
883 XL Sportster	2004/2009	065128	YTX14L-BS ■	—	—	—	—
883 XL/ XLH Sportster Hugger	1988/1996	0650201	GYZ20H ▲	—	—	—	—
883 XL/ XLH Sportster Hugger	1988/1996	0651638	YB16-B	0681638	ESB16-B ■	—	—
883 XL/ XLH Sportster Hugger	1988/1996	065184	YTX20H-BS ■	—	—	—	—
883 XL/ XLH Sportster Hugger	1997/2003	0650202	GYZ20HL ▲	—	—	—	—
883 XL/ XLH Sportster Hugger	1997/2003	065185	YTX20HL-BS ■	—	—	—	—
883 XL/ XLH Sportster Hugger	1997/2003	065209	YTX20L-BS ■	068209	ESTX20L-BS ■	—	—
883 XL53C Sportster Custom	2000/2003	0650202	GYZ20HL ▲	—	—	—	—
883 XL53C Sportster Custom	2000/2003	065185	YTX20HL-BS ■	—	—	—	—
883 XL53C Sportster Custom	2000/2003	065209	YTX20L-BS ■	068209	ESTX20L-BS ■	—	—
883 XLC Sportster Custom	2004/2010	065128	YTX14L-BS ■	—	—	—	—
883 XLH Sportster	1986/1996	0650201	GYZ20H ▲	—	—	—	—
883 XLH Sportster	1986/1996	0651638	YB16-B	0681638	ESB16-B ■	—	—



▲ - Factory Sealed / Attivata dalla Fabbrica ■ - con Acido a corredo ◇ - Non di produzione YUASA a completamento gamma

Marca / Cilindrata / Modello / Anno			Cod. SGR		Cod. SGR		Cod. SGR	
HARLEY DAVIDSON								
883	XLH Sportster	1986/1996	065184	YTX20H-BS■	—	—	—	—
883	XLH Sportster	1997/2003	0650202	GYZ20H▲	—	—	—	—
883	XLH Sportster	1997/2003	065185	YTX20HL-BS■	—	—	—	—
883	XLH Sportster	1997/2003	065209	YTX20L-BS■	068209	ESTX20L-BS■	—	—
883	XLH Sportster Custom	1999/2003	0650202	GYZ20H▲	—	—	—	—
883	XLH Sportster Custom	1999/2003	065185	YTX20HL-BS■	—	—	—	—
883	XLH Sportster Custom	1999/2003	065209	YTX20L-BS■	068209	ESTX20L-BS■	—	—
883	XLH Sportster Deluxe	1986/1995	0651638	YB16-B	0681638	ESB16-B■	—	—
883	XLL Sportster Low	2005/2013	065128	YTX14L-BS■	—	—	—	—
883	XLL Super Low	2012/2013	065128	YTX14L-BS■	—	—	—	—
883	XLN Iron	2010/2013	065128	YTX14L-BS■	—	—	—	—
883	XLR Sportster	2002/2003	0650202	GYZ20H▲	—	—	—	—
883	XLR Sportster	2002/2003	065185	YTX20HL-BS■	—	—	—	—
883	XLR Sportster	2002/2003	065209	YTX20L-BS■	068209	ESTX20L-BS■	—	—
883	XLR Sportster	2004/2010	065128	YTX14L-BS■	—	—	—	—
883	XLR Sportster Roadster	2011/2013	065128	YTX14L-BS■	—	—	—	—
1000	XL Sportster	1979/1985	0650201	GYZ20H▲	—	—	—	—
1000	XL Sportster	1979/1985	065184	YTX20H-BS■	—	—	—	—
1000	XLCH	1970/1978	0650733	12N7-4A	0680733	ES12N7-4A■	—	—
1000	XLCR Cafe Racer	1977/1978	0650201	GYZ20H▲	—	—	—	—
1000	XLCR Cafe Racer	1977/1978	0651638	YB16-B	0681638	ESB16-B■	—	—
1000	XLCR Cafe Racer	1977/1978	065184	YTX20H-BS■	—	—	—	—
1000	XLH Sportster	1975/1985	0650201	GYZ20H▲	—	—	—	—
1000	XLH Sportster	1975/1985	0651638	YB16-B	0681638	ESB16-B■	—	—
1000	XLH Sportster	1975/1985	065184	YTX20H-BS■	—	—	—	—
1000	XLH Sportster	1979/1986	0650201	GYZ20H▲	—	—	—	—
1000	XLH Sportster	1979/1986	065184	YTX20H-BS■	—	—	—	—
1000	XLX 61 Sportster	1983/1985	0650201	GYZ20H▲	—	—	—	—
1000	XLX 61 Sportster	1983/1985	0651638	YB16-B	0681638	ESB16-B■	—	—
1000	XLX 61 Sportster	1983/1985	065184	YTX20H-BS■	—	—	—	—
1000	XR	1983/1985	0650201	GYZ20H▲	—	—	—	—
1000	XR	1983/1985	0651638	YB16-B	0681638	ESB16-B■	—	—
1000	XR	1983/1985	065184	YTX20H-BS■	—	—	—	—
1100	XI	TUTTI	0650736	YB7-A	0680736	ESB7-A■	—	—
1100	XI Series (Sportster)	1987/1993	0650201	GYZ20H▲	—	—	—	—
1100	XI Series (Sportster)	1987/1993	065184	YTX20H-BS■	—	—	—	—
1100	XLH Sportster	TUTTI	0650201	GYZ20H▲	—	—	—	—
1100	XLH Sportster	TUTTI	0651638	YB16-B	0681638	ESB16-B■	—	—
1100	XLH Sportster	TUTTI	065184	YTX20H-BS■	—	—	—	—
1200	FX 74ci Models (Avv.Pedale)	1970/1974	0650733	12N7-4A	0680733	ES12N7-4A■	—	—
1200	FX 74ci Models (Electric Start)	1970/1974	0650201	GYZ20H▲	—	—	—	—



▲ - Factory Sealed / Attivata dalla Fabbrica ■ - con Acido a corredo ◇ - Non di produzione YUASA a completamento gamma

Marca / Cilindrata / Modello / Anno			Cod. SGR		Cod. SGR		Cod. SGR		
HARLEY DAVIDSON									
1200	FX 74ci Models (Electric Start)	1970/1974	065184	YTX20H-BS■	—	—	—	—	
1200	FX Series (Avv.Pedale)	1970/1978	0650733	12N7-4A	0680733	ES12N7-4A■	—	—	
1200	FX Series (Electric Start)	1971/1978	0650201	GYZ20H▲	—	—	—	—	
1200	FX Series (Electric Start)	1971/1978	065184	YTX20H-BS■	—	—	—	—	
1200	FX Super Glide (Avv.Pedale)	1971/1978	0650733	12N7-4A	0680733	ES12N7-4A■	—	—	
1200	FX Super Glide (Electric Start)	1971/1978	0650201	GYZ20H▲	—	—	—	—	
1200	FX Super Glide (Electric Start)	1971/1978	065184	YTX20H-BS■	—	—	—	—	
1200	XL Sportster	2004/2008	065128	YTX14L-BS■	—	—	—	—	
1200	XL50 50Th Anniversary Sportster	2007/2007	065128	YTX14L-BS■	—	—	—	—	
1200	XLC Sportster Custom	1997/2002	0650202	GYZ20HL▲	—	—	—	—	
1200	XLC Sportster Custom	1997/2002	065185	YTX20HL-BS■	—	—	—	—	
1200	XLC Sportster Custom	1997/2002	065209	YTX20L-BS■	068209	ESTX20L-BS■	—	—	
1200	XLC Sportster Custom	2004/2013	065128	YTX14L-BS■	—	—	—	—	
1200	XLH Sportster	1987/1996	0650201	GYZ20H▲	—	—	—	—	
1200	XLH Sportster	1987/1996	0651638	YB16-B	0681638	ESB16-B■	—	—	
1200	XLH Sportster	1987/1996	065184	YTX20H-BS■	—	—	—	—	
1200	XLH Sportster	1997/2003	0650202	GYZ20HL▲	—	—	—	—	
1200	XLH Sportster	1997/2003	065185	YTX20HL-BS■	—	—	—	—	
1200	XLH Sportster	1997/2003	065209	YTX20L-BS■	068209	ESTX20L-BS■	—	—	
1200	XLH Sportster Annv.	1993/1993	0650201	GYZ20H▲	—	—	—	—	
1200	XLH Sportster Annv.	1993/1993	0651638	YB16-B	0681638	ESB16-B■	—	—	
1200	XLH Sportster Annv.	1993/1993	065184	YTX20H-BS■	—	—	—	—	
1200	XLL Sportster Low	2006/2010	065128	YTX14L-BS■	—	—	—	—	
1200	XLN Sportster Nighter	2007/2012	065128	YTX14L-BS■	—	—	—	—	
1200	XLR Sportster Roadster	2004/2009	065128	YTX14L-BS■	—	—	—	—	
1200	XLV Seventy Two	2012/2013	065128	YTX14L-BS■	—	—	—	—	
1200	XLX Forty Eight	2011/2013	065128	YTX14L-BS■	—	—	—	—	
1250	VRSCAW V-Rod	2008/2009	0650202	GYZ20HL▲	—	—	—	—	
1250	VRSCAW V-Rod	2008/2009	065185	YTX20HL-BS■	—	—	—	—	
1250	VRSCAW V-Rod	2008/2009	065209	YTX20L-BS■	068209	ESTX20L-BS■	—	—	
1250	VRSCD Night-Rod	2008/2009	0650202	GYZ20HL▲	—	—	—	—	
1250	VRSCD Night-Rod	2008/2009	065185	YTX20HL-BS■	—	—	—	—	
1250	VRSCD Night-Rod	2008/2009	065209	YTX20L-BS■	068209	ESTX20L-BS■	—	—	
1250	VRSCDX Night-Rod Special	2008/2013	0650202	GYZ20HL▲	—	—	—	—	
1250	VRSCDX Night-Rod Special	2008/2013	065185	YTX20HL-BS■	—	—	—	—	
1250	VRSCDX Night-Rod Special	2008/2013	065209	YTX20L-BS■	068209	ESTX20L-BS■	—	—	
1250	VRSCF V-Rod Muscle	2009/2013	0650202	GYZ20HL▲	—	—	—	—	
1250	VRSCF V-Rod Muscle	2009/2013	065185	YTX20HL-BS■	—	—	—	—	
1250	VRSCF V-Rod Muscle	2009/2013	065209	YTX20L-BS■	068209	ESTX20L-BS■	—	—	
1250	VRSCX V-Rod	2007/2007	0650202	GYZ20HL▲	—	—	—	—	
1250	VRSCX V-Rod	2007/2007	065185	YTX20HL-BS■	—	—	—	—	



▲ - Factory Sealed / Attivata dalla Fabbrica ■ - con Acido a corredo ◇ - Non di produzione YUASA a completamento gamma

Marca / Cilindrata / Modello / Anno			Cod. SGR		Cod. SGR		Cod. SGR		
HARLEY DAVIDSON									
1250	VRSCX V-Rod	2007/2007	065209	YTX20L-BS■	068209	ESTX20L-BS■	—	—	
1340	FI, Flh Series (Touring)	1980/1996	065215	YTX24HL-BS■	—	—	—	—	
1340	FI, Flh Series (Touring)	1997/1998	065275	YIX30L▲	—	—	—	—	
1340	FI, Flh Series (Touring)	1997/1998	0653036	YB30L-B	0683036	ESB30L-B■	—	—	
1340	FLH	1980/1996	0652034	Y50-N18L-A	0682034	ES50-N18L-A■	—	—	
1340	FLH	1980/1996	065215	YTX24HL-BS■	—	—	—	—	
1340	FLH 80 Electra Glide	1980/1983	0652034	Y50-N18L-A	0682034	ES50-N18L-A■	—	—	
1340	FLH 80 Electra Glide	1980/1983	065215	YTX24HL-BS■	—	—	—	—	
1340	FLH Classic	1982/1983	0652034	Y50-N18L-A	0682034	ES50-N18L-A■	—	—	
1340	FLH Classic	1982/1983	065215	YTX24HL-BS■	—	—	—	—	
1340	FLH Electra Glide	1982/1984	0652034	Y50-N18L-A	0682034	ES50-N18L-A■	—	—	
1340	FLH Electra Glide	1982/1984	065215	YTX24HL-BS■	—	—	—	—	
1340	FLH Electra Glide Classic	1980/1980	0652034	Y50-N18L-A	0682034	ES50-N18L-A■	—	—	
1340	FLH Electra Glide Classic	1980/1980	065215	YTX24HL-BS■	—	—	—	—	
1340	FLH Electra Glide Special	1984/>	0652034	Y50-N18L-A	0682034	ES50-N18L-A■	—	—	
1340	FLH Electra Glide Special	1984/>	065215	YTX24HL-BS■	—	—	—	—	
1340	FLH Heritage	1981/>	0652034	Y50-N18L-A	0682034	ES50-N18L-A■	—	—	
1340	FLH Heritage	1981/>	065215	YTX24HL-BS■	—	—	—	—	
1340	FLHC Electra Glide Classic	1981/1982	0652034	Y50-N18L-A	0682034	ES50-N18L-A■	—	—	
1340	FLHC Electra Glide Classic	1981/1982	065215	YTX24HL-BS■	—	—	—	—	
1340	FLHF Sport Glide II	1982/1982	0652034	Y50-N18L-A	0682034	ES50-N18L-A■	—	—	
1340	FLHF Sport Glide II	1982/1982	065215	YTX24HL-BS■	—	—	—	—	
1340	FLHR Electra Glide Road King	1994/1996	0652034	Y50-N18L-A	0682034	ES50-N18L-A■	—	—	
1340	FLHR Electra Glide Road King	1994/1996	065215	YTX24HL-BS■	—	—	—	—	
1340	FLHR Electra Glide Road King	1997/1998	065275	YIX30L▲	—	—	—	—	
1340	FLHR Electra Glide Road King	1997/1998	0653036	YB30L-B	0683036	ESB30L-B■	—	—	
1340	FLHRI Electra Glide Road King F.I.	1996/1998	065275	YIX30L▲	—	—	—	—	
1340	FLHRI Electra Glide Road King F.I.	1996/1998	0653036	YB30L-B	0683036	ESB30L-B■	—	—	
1340	FLHS Electra Glide Sport	1987/1993	0652034	Y50-N18L-A	0682034	ES50-N18L-A■	—	—	
1340	FLHS Electra Glide Sport	1987/1993	065215	YTX24HL-BS■	—	—	—	—	
1340	FLHS Sport Glide	1982/1982	0652034	Y50-N18L-A	0682034	ES50-N18L-A■	—	—	
1340	FLHS Sport Glide	1982/1982	065215	YTX24HL-BS■	—	—	—	—	
1340	FLHT Electra Glide	1983/1996	0652034	Y50-N18L-A	0682034	ES50-N18L-A■	—	—	
1340	FLHT Electra Glide	1983/1996	065215	YTX24HL-BS■	—	—	—	—	
1340	FLHT Electra Glide	1997/1998	065275	YIX30L▲	—	—	—	—	
1340	FLHT Electra Glide	1997/1998	0653036	YB30L-B	0683036	ESB30L-B■	—	—	
1340	FLHT Electra Glide Standard	1995/1996	0652034	Y50-N18L-A	0682034	ES50-N18L-A■	—	—	
1340	FLHT Electra Glide Standard	1995/1996	065215	YTX24HL-BS■	—	—	—	—	
1340	FLHT Electra Glide Standard	1997/1998	065275	YIX30L▲	—	—	—	—	
1340	FLHT Electra Glide Standard	1997/1998	0653036	YB30L-B	0683036	ESB30L-B■	—	—	
1340	FLHT Touring (NonUs)	1995/1996	0652034	Y50-N18L-A	0682034	ES50-N18L-A■	—	—	



▲ - Factory Sealed / Attivata dalla Fabbrica ■ - con Acido a corredo ◇ - Non di produzione YUASA a completamento gamma

Marca / Cilindrata / Modello / Anno			Cod. SGR		Cod. SGR		Cod. SGR		
HARLEY DAVIDSON									
1340	FLHT Touring (NonUs)	1995/1996	065215	YTX24HL-BS■	—	—	—	—	
1340	FLHT Touring (NonUs)	1997/1998	065275	YIX30L▲	—	—	—	—	
1340	FLHT Touring (NonUs)	1997/1998	0653036	YB30L-B	0683036	ESB30L-B■	—	—	
1340	FLHTC Chrome	1988/1988	0652034	Y50-N18L-A	0682034	ES50-N18L-A■	—	—	
1340	FLHTC Chrome	1988/1988	065215	YTX24HL-BS■	—	—	—	—	
1340	FLHTC Chrome TT	1987/1987	0652034	Y50-N18L-A	0682034	ES50-N18L-A■	—	—	
1340	FLHTC Chrome TT	1987/1987	065215	YTX24HL-BS■	—	—	—	—	
1340	FLHTC Classic Anniversary	1993/1993	0652034	Y50-N18L-A	0682034	ES50-N18L-A■	—	—	
1340	FLHTC Classic Anniversary	1993/1993	065215	YTX24HL-BS■	—	—	—	—	
1340	FLHTC Electra Glide Classic	1983/1996	0652034	Y50-N18L-A	0682034	ES50-N18L-A■	—	—	
1340	FLHTC Electra Glide Classic	1983/1996	065215	YTX24HL-BS■	—	—	—	—	
1340	FLHTC Electra Glide Classic	1997/1998	065275	YIX30L▲	—	—	—	—	
1340	FLHTC Electra Glide Classic	1997/1998	0653036	YB30L-B	0683036	ESB30L-B■	—	—	
1340	FLHTC Liberty	1986/1986	0652034	Y50-N18L-A	0682034	ES50-N18L-A■	—	—	
1340	FLHTC Liberty	1986/1986	065215	YTX24HL-BS■	—	—	—	—	
1340	FLHTC Touring (NonUs)	1995/1996	0652034	Y50-N18L-A	0682034	ES50-N18L-A■	—	—	
1340	FLHTC Touring (NonUs)	1995/1996	065215	YTX24HL-BS■	—	—	—	—	
1340	FLHTC Touring (NonUs)	1997/1998	065275	YIX30L▲	—	—	—	—	
1340	FLHTC Touring (NonUs)	1997/1998	0653036	YB30L-B	0683036	ESB30L-B■	—	—	
1340	FLHTCI Electra Glide Classic F.I.	1996/1996	0652034	Y50-N18L-A	0682034	ES50-N18L-A■	—	—	
1340	FLHTCI Electra Glide Classic F.I.	1996/1996	065215	YTX24HL-BS■	—	—	—	—	
1340	FLHTCI Electra Glide Classic F.I.	1997/1998	065275	YIX30L▲	—	—	—	—	
1340	FLHTCI Electra Glide Classic F.I.	1997/1998	0653036	YB30L-B	0683036	ESB30L-B■	—	—	
1340	FLHTCU Electra Glide Ultra Classic	1980/1996	0652034	Y50-N18L-A	0682034	ES50-N18L-A■	—	—	
1340	FLHTCU Electra Glide Ultra Classic	1980/1996	065215	YTX24HL-BS■	—	—	—	—	
1340	FLHTCU Electra Glide Ultra Classic	1997/1998	065275	YIX30L▲	—	—	—	—	
1340	FLHTCU Electra Glide Ultra Classic	1997/1998	0653036	YB30L-B	0683036	ESB30L-B■	—	—	
1340	FLHTCU Electra Glide Ultra Classic Anniv.	1993/1993	0652034	Y50-N18L-A	0682034	ES50-N18L-A■	—	—	
1340	FLHTCU Electra Glide Ultra Classic Anniv.	1993/1993	065215	YTX24HL-BS■	—	—	—	—	
1340	FLHTCU Touring (NonUs)	1995/1996	0652034	Y50-N18L-A	0682034	ES50-N18L-A■	—	—	
1340	FLHTCU Touring (NonUs)	1995/1996	065215	YTX24HL-BS■	—	—	—	—	
1340	FLHTCU Touring (NonUs)	1997/1998	065275	YIX30L▲	—	—	—	—	
1340	FLHTCU Touring (NonUs)	1997/1998	0653036	YB30L-B	0683036	ESB30L-B■	—	—	
1340	FLHTCUI Ultra Classic Electra Glide F.I.	1996/1996	0652034	Y50-N18L-A	0682034	ES50-N18L-A■	—	—	
1340	FLHTCUI Ultra Classic Electra Glide F/I	1996/1996	065215	YTX24HL-BS■	—	—	—	—	
1340	FLHTCUI Ultra Classic Electra Glide F/I	1997/1998	065275	YIX30L▲	—	—	—	—	
1340	FLHTCUI Ultra Classic Electra Glide F/I	1997/1998	0653036	YB30L-B	0683036	ESB30L-B■	—	—	
1340	FLST Heritage Softail	1984/1990	0650201	GYZ20H▲	—	—	—	—	
1340	FLST Heritage Softail	1984/1990	065184	YTX20H-BS■	—	—	—	—	
1340	FLST Heritage Softail	1991/1999	0650202	GYZ20HL▲	—	—	—	—	
1340	FLST Heritage Softail	1991/1999	065185	YTX20HL-BS■	—	—	—	—	



▲ - Factory Sealed / Attivata dalla Fabbrica ■ - con Acido a corredo ◇ - Non di produzione YUASA a completamento gamma

Marca / Cilindrata / Modello / Anno			Cod. SGR		Cod. SGR		Cod. SGR		
HARLEY DAVIDSON									
1340	FLST Heritage Softail	1991/1999	065209	YTX20L-BS■	068209	ESTX20L-BS■	—	—	
1340	FLSTC Heritage Softail Classic	1988/1990	0650201	GYZ20H▲	—	—	—	—	
1340	FLSTC Heritage Softail Classic	1988/1990	065184	YTX20H-BS■	—	—	—	—	
1340	FLSTC Heritage Softail Classic	1991/1999	0650202	GYZ20HL▲	—	—	—	—	
1340	FLSTC Heritage Softail Classic	1991/1999	065185	YTX20HL-BS■	—	—	—	—	
1340	FLSTC Heritage Softail Classic	1991/1999	065209	YTX20L-BS■	068209	ESTX20L-BS■	—	—	
1340	FLSTC Heritage Softail Classic (NonUs)	1995/1999	0650202	GYZ20HL▲	—	—	—	—	
1340	FLSTC Heritage Softail Classic (NonUs)	1995/1999	065185	YTX20HL-BS■	—	—	—	—	
1340	FLSTC Heritage Softail Classic (NonUs)	1995/1999	065209	YTX20L-BS■	068209	ESTX20L-BS■	—	—	
1340	FLSTF Fat Boy	1990/1990	0650201	GYZ20H▲	—	—	—	—	
1340	FLSTF Fat Boy	1990/1990	065184	YTX20H-BS■	—	—	—	—	
1340	FLSTF Fat Boy	1991/1999	0650202	GYZ20HL▲	—	—	—	—	
1340	FLSTF Fat Boy	1991/1999	065185	YTX20HL-BS■	—	—	—	—	
1340	FLSTF Fat Boy	1991/1999	065209	YTX20L-BS■	068209	ESTX20L-BS■	—	—	
1340	FLSTF Fat Boy (NonUs)	1995/1999	0650202	GYZ20HL▲	—	—	—	—	
1340	FLSTF Fat Boy (NonUs)	1995/1999	065185	YTX20HL-BS■	—	—	—	—	
1340	FLSTF Fat Boy (NonUs)	1995/1999	065209	YTX20L-BS■	068209	ESTX20L-BS■	—	—	
1340	FLSTN Heritage Softail Nostalgia	1993/1995	0650202	GYZ20HL▲	—	—	—	—	
1340	FLSTN Heritage Softail Nostalgia	1993/1995	065185	YTX20HL-BS■	—	—	—	—	
1340	FLSTN Heritage Softail Nostalgia	1993/1995	065209	YTX20L-BS■	068209	ESTX20L-BS■	—	—	
1340	FLSTN Heritage Softail Special	1993/1999	0650202	GYZ20HL▲	—	—	—	—	
1340	FLSTN Heritage Softail Special	1993/1999	065185	YTX20HL-BS■	—	—	—	—	
1340	FLSTN Heritage Softail Special	1993/1999	065209	YTX20L-BS■	068209	ESTX20L-BS■	—	—	
1340	FLSTN Heritage Softail Special (NonUs)	1995/1996	0650202	GYZ20HL▲	—	—	—	—	
1340	FLSTN Heritage Softail Special (NonUs)	1995/1996	065185	YTX20HL-BS■	—	—	—	—	
1340	FLSTN Heritage Softail Special (NonUs)	1995/1996	065209	YTX20L-BS■	068209	ESTX20L-BS■	—	—	
1340	FLSTS Heritage Springer	1997/1999	0650202	GYZ20HL▲	—	—	—	—	
1340	FLSTS Heritage Springer	1997/1999	065185	YTX20HL-BS■	—	—	—	—	
1340	FLSTS Heritage Springer	1997/1999	065209	YTX20L-BS■	068209	ESTX20L-BS■	—	—	
1340	FLSTS Heritage Springer (NonUs)	1997/1999	0650202	GYZ20HL▲	—	—	—	—	
1340	FLSTS Heritage Springer (NonUs)	1997/1999	065185	YTX20HL-BS■	—	—	—	—	
1340	FLSTS Heritage Springer (NonUs)	1997/1999	065209	YTX20L-BS■	068209	ESTX20L-BS■	—	—	
1340	FLT	1980/1996	0652034	Y50-N18L-A	0682034	ES50-N18L-A■	—	—	
1340	FLT	1980/1996	065215	YTX24HL-BS■	—	—	—	—	
1340	FLT	1997/1998	065275	Y1X30L▲	—	—	—	—	
1340	FLT	1997/1998	0653036	YB30L-B	0683036	ESB30L-B■	—	—	
1340	FLT 80	1980/1981	0652034	Y50-N18L-A	0682034	ES50-N18L-A■	—	—	
1340	FLT 80	1980/1981	065215	YTX24HL-BS■	—	—	—	—	
1340	FLT 80 Classic	1981/>	0652034	Y50-N18L-A	0682034	ES50-N18L-A■	—	—	
1340	FLT 80 Classic	1981/>	065215	YTX24HL-BS■	—	—	—	—	
1340	FLT 80 Tour Glide	1980/1983	0652034	Y50-N18L-A	0682034	ES50-N18L-A■	—	—	



▲ - Factory Sealed / Attivata dalla Fabbrica ■ - con Acido a corredo ◇ - Non di produzione YUASA a completamento gamma

Marca / Cilindrata / Modello / Anno			Cod. SGR		Cod. SGR		Cod. SGR		
HARLEY DAVIDSON									
1340	FLT 80 Tour Glide	1980/1983	065215	YTX24HL-BS■	—	—	—	—	
1340	FLT Classic	1982/>	0652034	Y50-N18L-A	0682034	ES50-N18L-A■	—	—	
1340	FLT Classic	1982/>	065215	YTX24HL-BS■	—	—	—	—	
1340	FLTC Chrome	1988/1988	0652034	Y50-N18L-A	0682034	ES50-N18L-A■	—	—	
1340	FLTC Chrome	1988/1988	065215	YTX24HL-BS■	—	—	—	—	
1340	FLTC Chrome TT	1987/1987	0652034	Y50-N18L-A	0682034	ES50-N18L-A■	—	—	
1340	FLTC Chrome TT	1987/1987	065215	YTX24HL-BS■	—	—	—	—	
1340	FLTC Tour Glide Classic	1980/1992	0652034	Y50-N18L-A	0682034	ES50-N18L-A■	—	—	
1340	FLTC Tour Glide Classic	1980/1992	065215	YTX24HL-BS■	—	—	—	—	
1340	FLTCU Ultra Tour Glide Annv.	1993/1993	0652034	Y50-N18L-A	0682034	ES50-N18L-A■	—	—	
1340	FLTCU Ultra Tour Glide Annv.	1993/1993	065215	YTX24HL-BS■	—	—	—	—	
1340	FLTCU Ultra Tour Glide Classic	1987/1995	0652034	Y50-N18L-A	0682034	ES50-N18L-A■	—	—	
1340	FLTCU Ultra Tour Glide Classic	1987/1995	065215	YTX24HL-BS■	—	—	—	—	
1340	FLTCUI Ultra Tour Glide Classic F.I.	1996/1996	0652034	Y50-N18L-A	0682034	ES50-N18L-A■	—	—	
1340	FLTCUI Ultra Tour Glide Classic F.I.	1996/1996	065215	YTX24HL-BS■	—	—	—	—	
1340	FLTR Road Glide	1998/1998	065275	YIX30L▲	—	—	—	—	
1340	FLTR Road Glide	1998/1998	0653036	YB30L-B	0683036	ESB30L-B■	—	—	
1340	FLTRI Road Glide F.I.	1998/1998	065275	YIX30L▲	—	—	—	—	
1340	FLTRI Road Glide F.I.	1998/1998	0653036	YB30L-B	0683036	ESB30L-B■	—	—	
1340	FLXR Low Rider Custom Annv.	1993/1993	0652034	Y50-N18L-A	0682034	ES50-N18L-A■	—	—	
1340	FLXR Low Rider Custom Annv.	1993/1993	065215	YTX24HL-BS■	—	—	—	—	
1340	FXB Sturgis	1980/1982	0650201	GYZ20H▲	—	—	—	—	
1340	FXB Sturgis	1980/1982	0651638	YB16-B	0681638	ESB16-B■	—	—	
1340	FXB Sturgis	1980/1982	065184	YTX20H-BS■	—	—	—	—	
1340	FXD Dyna (NonUs)	1995/1998	0650202	GYZ20HL▲	—	—	—	—	
1340	FXD Dyna (NonUs)	1995/1998	065185	YTX20HL-BS■	—	—	—	—	
1340	FXD Dyna (NonUs)	1995/1998	065209	YTX20L-BS■	068209	ESTX20L-BS■	—	—	
1340	FXD Dyna Super Glide	1995/1998	0650202	GYZ20HL▲	—	—	—	—	
1340	FXD Dyna Super Glide	1995/1998	065185	YTX20HL-BS■	—	—	—	—	
1340	FXD Dyna Super Glide	1995/1998	065209	YTX20L-BS■	068209	ESTX20L-BS■	—	—	
1340	FXDB Dyna Glide Daytona	1992/1992	0650202	GYZ20HL▲	—	—	—	—	
1340	FXDB Dyna Glide Daytona	1992/1992	065185	YTX20HL-BS■	—	—	—	—	
1340	FXDB Dyna Glide Daytona	1992/1992	065209	YTX20L-BS■	068209	ESTX20L-BS■	—	—	
1340	FXDB Dyna Glide Sturgis	1991/1991	0650202	GYZ20HL▲	—	—	—	—	
1340	FXDB Dyna Glide Sturgis	1991/1991	065185	YTX20HL-BS■	—	—	—	—	
1340	FXDB Dyna Glide Sturgis	1991/1991	065209	YTX20L-BS■	068209	ESTX20L-BS■	—	—	
1340	FXDC Dyna Glide Custom	1992/1992	0650202	GYZ20HL▲	—	—	—	—	
1340	FXDC Dyna Glide Custom	1992/1992	065185	YTX20HL-BS■	—	—	—	—	
1340	FXDC Dyna Glide Custom	1992/1992	065209	YTX20L-BS■	068209	ESTX20L-BS■	—	—	
1340	FXDL Dyna (NonUs)	1995/1998	0650202	GYZ20HL▲	—	—	—	—	
1340	FXDL Dyna (NonUs)	1995/1998	065185	YTX20HL-BS■	—	—	—	—	



▲ - Factory Sealed / Attivata dalla Fabbrica ■ - con Acido a corredo ◇ - Non di produzione YUASA a completamento gamma

Marca / Cilindrata / Modello / Anno			Cod. SGR		Cod. SGR		Cod. SGR	
HARLEY DAVIDSON								
1340	FXDL Dyna (NonUs)	1995/1998	065209	YTX20L-BS■	068209	ESTX20L-BS■	—	—
1340	FXDL Dyna Low Rider	1993/1998	0650202	GYZ20HL▲	—	—	—	—
1340	FXDL Dyna Low Rider	1993/1998	065185	YTX20HL-BS■	—	—	—	—
1340	FXDL Dyna Low Rider	1993/1998	065209	YTX20L-BS■	068209	ESTX20L-BS■	—	—
1340	FXDS Dyna (NonUs)	1995/1998	0650202	GYZ20HL▲	—	—	—	—
1340	FXDS Dyna (NonUs)	1995/1998	065185	YTX20HL-BS■	—	—	—	—
1340	FXDS Dyna (NonUs)	1995/1998	065209	YTX20L-BS■	068209	ESTX20L-BS■	—	—
1340	FXDS Dyna Convertible	1996/1998	0650202	GYZ20HL▲	—	—	—	—
1340	FXDS Dyna Convertible	1996/1998	065185	YTX20HL-BS■	—	—	—	—
1340	FXDS Dyna Convertible	1996/1998	065209	YTX20L-BS■	068209	ESTX20L-BS■	—	—
1340	FXDS Dyna Low Rider Convertible	1994/1995	0650202	GYZ20HL▲	—	—	—	—
1340	FXDS Dyna Low Rider Convertible	1994/1995	065185	YTX20HL-BS■	—	—	—	—
1340	FXDS Dyna Low Rider Convertible	1994/1995	065209	YTX20L-BS■	068209	ESTX20L-BS■	—	—
1340	FXDWG Dyna (NonUs)	1995/1998	0650202	GYZ20HL▲	—	—	—	—
1340	FXDWG Dyna (NonUs)	1995/1998	065185	YTX20HL-BS■	—	—	—	—
1340	FXDWG Dyna (NonUs)	1995/1998	065209	YTX20L-BS■	068209	ESTX20L-BS■	—	—
1340	FXDWG Dyna Wide Glide	1993/1998	0650202	GYZ20HL▲	—	—	—	—
1340	FXDWG Dyna Wide Glide	1993/1998	065185	YTX20HL-BS■	—	—	—	—
1340	FXDWG Dyna Wide Glide	1993/1998	065209	YTX20L-BS■	068209	ESTX20L-BS■	—	—
1340	FXE Super Glide	1981/1986	0650201	GYZ20H▲	—	—	—	—
1340	FXE Super Glide	1981/1986	0651638	YB16-B	0681638	ESB16-B■	—	—
1340	FXE Super Glide	1981/1986	065184	YTX20H-BS■	—	—	—	—
1340	FXEF Fat Bob	1979/1981	0650201	GYZ20H▲	—	—	—	—
1340	FXEF Fat Bob	1979/1981	0651638	YB16-B	0681638	ESB16-B■	—	—
1340	FXEF Fat Bob	1979/1981	065184	YTX20H-BS■	—	—	—	—
1340	FXEF Super Glide Fat Bob	1984/1985	0650201	GYZ20H▲	—	—	—	—
1340	FXEF Super Glide Fat Bob	1984/1985	0651638	YB16-B	0681638	ESB16-B■	—	—
1340	FXEF Super Glide Fat Bob	1984/1985	065184	YTX20H-BS■	—	—	—	—
1340	FXH Electra Glide	1980/1981	0650201	GYZ20H▲	—	—	—	—
1340	FXH Electra Glide	1980/1981	0651638	YB16-B	0681638	ESB16-B■	—	—
1340	FXH Electra Glide	1980/1981	065184	YTX20H-BS■	—	—	—	—
1340	FXLR Low Rider Custom	1987/1994	0650201	GYZ20H▲	—	—	—	—
1340	FXLR Low Rider Custom	1987/1994	0651638	YB16-B	0681638	ESB16-B■	—	—
1340	FXLR Low Rider Custom	1987/1994	065184	YTX20H-BS■	—	—	—	—
1340	FXLR Low Rider Custom Anniversary	1993/1993	0650201	GYZ20H▲	—	—	—	—
1340	FXLR Low Rider Custom Anniversary	1993/1993	0651638	YB16-B	0681638	ESB16-B■	—	—
1340	FXLR Low Rider Custom Anniversary	1993/1993	065184	YTX20H-BS■	—	—	—	—
1340	FXR Super Glide	1986/1994	0650201	GYZ20H▲	—	—	—	—
1340	FXR Super Glide	1986/1994	0651638	YB16-B	0681638	ESB16-B■	—	—
1340	FXR Super Glide	1986/1994	065184	YTX20H-BS■	—	—	—	—
1340	FXR Super Glide II	1982/1983	0650201	GYZ20H▲	—	—	—	—



▲ - Factory Sealed / Attivata dalla Fabbrica ■ - con Acido a corredo ◇ - Non di produzione YUASA a completamento gamma

Marca / Cilindrata / Modello / Anno			Cod. SGR		Cod. SGR		Cod. SGR		
HARLEY DAVIDSON									
1340	FXR Super Glide II	1982/1983	0651638	YB16-B	0681638	ESB16-B■	—	—	
1340	FXR Super Glide II	1982/1983	065184	YTX20H-BS■	—	—	—	—	
1340	FXRC Low Glide Custom	1985/1987	0650201	GYZ20H▲	—	—	—	—	
1340	FXRC Low Glide Custom	1985/1987	0651638	YB16-B	0681638	ESB16-B■	—	—	
1340	FXRC Low Glide Custom	1985/1987	065184	YTX20H-BS■	—	—	—	—	
1340	FXRD GT / Sport Glide GTE	1986/1986	0650201	GYZ20H▲	—	—	—	—	
1340	FXRD GT / Sport Glide GTE	1986/1986	0651638	YB16-B	0681638	ESB16-B■	—	—	
1340	FXRD GT / Sport Glide GTE	1986/1986	065184	YTX20H-BS■	—	—	—	—	
1340	FXRS Low Glide	1984/1985	0650201	GYZ20H▲	—	—	—	—	
1340	FXRS Low Glide	1984/1985	0651638	YB16-B	0681638	ESB16-B■	—	—	
1340	FXRS Low Glide	1984/1985	065184	YTX20H-BS■	—	—	—	—	
1340	FXRS Low Rider Convertible	1989/1994	0650201	GYZ20H▲	—	—	—	—	
1340	FXRS Low Rider Convertible	1989/1994	0651638	YB16-B	0681638	ESB16-B■	—	—	
1340	FXRS Low Rider Convertible	1989/1994	065184	YTX20H-BS■	—	—	—	—	
1340	FXRS Low Rider Liberty	1986/1986	0650201	GYZ20H▲	—	—	—	—	
1340	FXRS Low Rider Liberty	1986/1986	0651638	YB16-B	0681638	ESB16-B■	—	—	
1340	FXRS Low Rider Liberty	1986/1986	065184	YTX20H-BS■	—	—	—	—	
1340	FXRS Low Rider Sport	1986/1988	0650201	GYZ20H▲	—	—	—	—	
1340	FXRS Low Rider Sport	1986/1988	0651638	YB16-B	0681638	ESB16-B■	—	—	
1340	FXRS Low Rider Sport	1986/1988	065184	YTX20H-BS■	—	—	—	—	
1340	FXRS Super Glide II	1982/1983	0650201	GYZ20H▲	—	—	—	—	
1340	FXRS Super Glide II	1982/1983	0651638	YB16-B	0681638	ESB16-B■	—	—	
1340	FXRS Super Glide II	1982/1983	065184	YTX20H-BS■	—	—	—	—	
1340	FXRS-SP Low Rider Sport	1989/1993	0650201	GYZ20H▲	—	—	—	—	
1340	FXRS-SP Low Rider Sport	1989/1993	0651638	YB16-B	0681638	ESB16-B■	—	—	
1340	FXRS-SP Low Rider Sport	1989/1993	065184	YTX20H-BS■	—	—	—	—	
1340	FXRT Sport Glide	1983/1992	0650201	GYZ20H▲	—	—	—	—	
1340	FXRT Sport Glide	1983/1992	0651638	YB16-B	0681638	ESB16-B■	—	—	
1340	FXRT Sport Glide	1983/1992	065184	YTX20H-BS■	—	—	—	—	
1340	FXST Softtail	1984/1990	0650201	GYZ20H▲	—	—	—	—	
1340	FXST Softtail	1984/1990	065184	YTX20H-BS■	—	—	—	—	
1340	FXST Softtail (NonUs)	1999/1999	0650202	GYZ20HL▲	—	—	—	—	
1340	FXST Softtail (NonUs)	1999/1999	065185	YTX20HL-BS■	—	—	—	—	
1340	FXST Softtail (NonUs)	1999/1999	065209	YTX20L-BS■	068209	ESTX20L-BS■	—	—	
1340	FXST Softtail Standard	1999/1999	0650202	GYZ20HL▲	—	—	—	—	
1340	FXST Softtail Standard	1999/1999	065185	YTX20HL-BS■	—	—	—	—	
1340	FXST Softtail Standard	1999/1999	065209	YTX20L-BS■	068209	ESTX20L-BS■	—	—	
1340	FXSTB Night Train	1999/1999	0650202	GYZ20HL▲	—	—	—	—	
1340	FXSTB Night Train	1999/1999	065185	YTX20HL-BS■	—	—	—	—	
1340	FXSTB Night Train	1999/1999	065209	YTX20L-BS■	068209	ESTX20L-BS■	—	—	
1340	FXSTB Softtail (NonUs)	1999/1999	0650202	GYZ20HL▲	—	—	—	—	



▲ - Factory Sealed / Attivata dalla Fabbrica ■ - con Acido a corredo ◇ - Non di produzione YUASA a completamento gamma

Marca / Cilindrata / Modello / Anno			Cod. SGR		Cod. SGR		Cod. SGR		
HARLEY DAVIDSON									
1340	FXSTB Softail (NonUs)	1999/1999	065185	YTX20HL-BS■	—	—	—	—	
1340	FXSTB Softail (NonUs)	1999/1999	065209	YTX20L-BS■	068209	ESTX20L-BS■	—	—	
1450	FI, Flh Series (Touring)	1999/1999	0653036	YB30L-B	0683036	ESB30L-B■	—	—	
1450	FI, Flh Series (Touring)	1999/2004	065275	YIX30L▲	—	—	—	—	
1450	FLHR Road King	2000/2006	065275	YIX30L▲	—	—	—	—	
1450	FLHRCI Road King Classic F/ I	2000/>	065275	YIX30L▲	—	—	—	—	
1450	FLHRI Road King F/ I	2001/2006	065275	YIX30L▲	—	—	—	—	
1450	FLHRS Road King Custom	2004/2006	065275	YIX30L▲	—	—	—	—	
1450	FLHRSI Road King Custom F.I.	2004/2006	065275	YIX30L▲	—	—	—	—	
1450	FLHT Electra Glide Standard	2000/2006	065275	YIX30L▲	—	—	—	—	
1450	FLHTC Electra Glide Classic	2000/2005	065275	YIX30L▲	—	—	—	—	
1450	FLHTCI Electra Glide Classic F/ I	2000/2006	065275	YIX30L▲	—	—	—	—	
1450	FLHTCUI Ultra Classic Electra Glide F/ I	2000/2006	065275	YIX30L▲	—	—	—	—	
1450	FLHTI Electra Glide Standard F/ I	2003/2006	065275	YIX30L▲	—	—	—	—	
1450	FLHX Street Glide	2006/2006	065275	YIX30L▲	—	—	—	—	
1450	FLHXI Street Glide F/ I	2006/2006	065275	YIX30L▲	—	—	—	—	
1450	FLSTC Heritage Softail Classic	2000/2004	0650202	GYZ20HL▲	—	—	—	—	
1450	FLSTC Heritage Softail Classic	2000/2004	065185	YTX20HL-BS■	—	—	—	—	
1450	FLSTC Heritage Softail Classic	2000/2004	065209	YTX20L-BS■	068209	ESTX20L-BS■	—	—	
1450	FLSTCI Heritage Softail Classic F/ I	2000/2004	0650202	GYZ20HL▲	—	—	—	—	
1450	FLSTCI Heritage Softail Classic F/ I	2000/2004	065185	YTX20HL-BS■	—	—	—	—	
1450	FLSTCI Heritage Softail Classic F/ I	2000/2004	065209	YTX20L-BS■	068209	ESTX20L-BS■	—	—	
1450	FLSTF Fat Boy	2000/2006	0650202	GYZ20HL▲	—	—	—	—	
1450	FLSTF Fat Boy	2000/2006	065185	YTX20HL-BS■	—	—	—	—	
1450	FLSTF Fat Boy	2000/2006	065209	YTX20L-BS■	068209	ESTX20L-BS■	—	—	
1450	FLSTFI Fat Boy F/ I	2000/2006	0650202	GYZ20HL▲	—	—	—	—	
1450	FLSTFI Fat Boy F/ I	2000/2006	065185	YTX20HL-BS■	—	—	—	—	
1450	FLSTFI Fat Boy F/ I	2000/2006	065209	YTX20L-BS■	068209	ESTX20L-BS■	—	—	
1450	FLSTI Heritage Softail	2006/2006	0650202	GYZ20HL▲	—	—	—	—	
1450	FLSTI Heritage Softail	2006/2006	065185	YTX20HL-BS■	—	—	—	—	
1450	FLSTI Heritage Softail	2006/2006	065209	YTX20L-BS■	068209	ESTX20L-BS■	—	—	
1450	FLSTI Heritage Softail F/ I	2006/2006	0650202	GYZ20HL▲	—	—	—	—	
1450	FLSTI Heritage Softail F/ I	2006/2006	065185	YTX20HL-BS■	—	—	—	—	
1450	FLSTI Heritage Softail F/ I	2006/2006	065209	YTX20L-BS■	068209	ESTX20L-BS■	—	—	
1450	FLSTN Softail Deluxe	2005/2006	0650202	GYZ20HL▲	—	—	—	—	
1450	FLSTN Softail Deluxe	2005/2006	065185	YTX20HL-BS■	—	—	—	—	
1450	FLSTN Softail Deluxe	2005/2006	065209	YTX20L-BS■	068209	ESTX20L-BS■	—	—	
1450	FLSTNI Softail Deluxe F/ I	2005/2006	0650202	GYZ20HL▲	—	—	—	—	
1450	FLSTNI Softail Deluxe F/ I	2005/2006	065185	YTX20HL-BS■	—	—	—	—	
1450	FLSTNI Softail Deluxe F/ I	2005/2006	065209	YTX20L-BS■	068209	ESTX20L-BS■	—	—	
1450	FLSTS Heritage Spriger	2000/2003	0650202	GYZ20HL▲	—	—	—	—	



▲ - Factory Sealed / Attivata dalla Fabbrica ■ - con Acido a corredo ◇ - Non di produzione YUASA a completamento gamma

Marca / Cilindrata / Modello / Anno			Cod. SGR		Cod. SGR		Cod. SGR	
HARLEY DAVIDSON								
1450	FLSTS Heritage Spriger	2000/2003	065185	YTX20HL-BS■	—	—	—	—
1450	FLSTS Heritage Spriger	2000/2003	065209	YTX20L-BS■	068209	ESTX20L-BS■	—	—
1450	FLSTSC Softail Springer Classic	2005/2006	0650202	GYZ20HL▲	—	—	—	—
1450	FLSTSC Softail Springer Classic	2005/2006	065185	YTX20HL-BS■	—	—	—	—
1450	FLSTSC Softail Springer Classic	2005/2006	065209	YTX20L-BS■	068209	ESTX20L-BS■	—	—
1450	FLSTSCI Softail Springer Classic F/I	2005/2006	0650202	GYZ20HL▲	—	—	—	—
1450	FLSTSCI Softail Springer Classic F/I	2005/2006	065185	YTX20HL-BS■	—	—	—	—
1450	FLSTSCI Softail Springer Classic F/I	2005/2006	065209	YTX20L-BS■	068209	ESTX20L-BS■	—	—
1450	FLSTSI Heritage Spriger F/I	2001/2003	0650202	GYZ20HL▲	—	—	—	—
1450	FLSTSI Heritage Spriger F/I	2001/2003	065185	YTX20HL-BS■	—	—	—	—
1450	FLSTSI Heritage Spriger F/I	2001/2003	065209	YTX20L-BS■	068209	ESTX20L-BS■	—	—
1450	FLTR Road Glide	1999/2002	065275	YIX30L▲	—	—	—	—
1450	FLTRI Road Glide F/I	1999/2006	065275	YIX30L▲	—	—	—	—
1450	FXD Dyna Super Glide	1999/2006	0650202	GYZ20HL▲	—	—	—	—
1450	FXD Dyna Super Glide	1999/2006	065185	YTX20HL-BS■	—	—	—	—
1450	FXD Dyna Super Glide	1999/2006	065209	YTX20L-BS■	068209	ESTX20L-BS■	—	—
1450	FXDB Dyna Street Bob	2006/2006	0650202	GYZ20HL▲	—	—	—	—
1450	FXDB Dyna Street Bob	2006/2006	065185	YTX20HL-BS■	—	—	—	—
1450	FXDB Dyna Street Bob	2006/2006	065209	YTX20L-BS■	068209	ESTX20L-BS■	—	—
1450	FXDBI Dyna Street Bob F/I	2006/2006	0650202	GYZ20HL▲	—	—	—	—
1450	FXDBI Dyna Street Bob F/I	2006/2006	065185	YTX20HL-BS■	—	—	—	—
1450	FXDBI Dyna Street Bob F/I	2006/2006	065209	YTX20L-BS■	068209	ESTX20L-BS■	—	—
1450	FXDC Dyna Super Glide Custom	2005/2005	0650202	GYZ20HL▲	—	—	—	—
1450	FXDC Dyna Super Glide Custom	2005/2005	065185	YTX20HL-BS■	—	—	—	—
1450	FXDC Dyna Super Glide Custom	2005/2005	065209	YTX20L-BS■	068209	ESTX20L-BS■	—	—
1450	FXDCI Dyna Super Glide Custom F/I	2005/2006	0650202	GYZ20HL▲	—	—	—	—
1450	FXDCI Dyna Super Glide Custom F/I	2005/2006	065185	YTX20HL-BS■	—	—	—	—
1450	FXDCI Dyna Super Glide Custom F/I	2005/2006	065209	YTX20L-BS■	068209	ESTX20L-BS■	—	—
1450	FXDI Dyna Super Glide	1998/2003	0650202	GYZ20HL▲	—	—	—	—
1450	FXDI Dyna Super Glide	1998/2003	065185	YTX20HL-BS■	—	—	—	—
1450	FXDI Dyna Super Glide	1998/2003	065209	YTX20L-BS■	068209	ESTX20L-BS■	—	—
1450	FXDI35 Th Anniv. Super Glide F/I	2004/2006	0650202	GYZ20HL▲	—	—	—	—
1450	FXDI35 Th Anniv. Super Glide F/I	2004/2006	065185	YTX20HL-BS■	—	—	—	—
1450	FXDI35 Th Anniv. Super Glide F/I	2004/2006	065209	YTX20L-BS■	068209	ESTX20L-BS■	—	—
1450	FXDL Dyna Low Rider	1999/2005	0650202	GYZ20HL▲	—	—	—	—
1450	FXDL Dyna Low Rider	1999/2005	065185	YTX20HL-BS■	—	—	—	—
1450	FXDL Dyna Low Rider	1999/2005	065209	YTX20L-BS■	068209	ESTX20L-BS■	—	—
1450	FXDLI Dyna Low Rider F/I	2004/2006	0650202	GYZ20HL▲	—	—	—	—
1450	FXDLI Dyna Low Rider F/I	2004/2006	065185	YTX20HL-BS■	—	—	—	—
1450	FXDLI Dyna Low Rider F/I	2004/2006	065209	YTX20L-BS■	068209	ESTX20L-BS■	—	—
1450	FXDS Dyna Convertible	1999/2000	0650202	GYZ20HL▲	—	—	—	—



▲ - Factory Sealed / Attivata dalla Fabbrica ■ - con Acido a corredo ◇ - Non di produzione YUASA a completamento gamma

Marca / Cilindrata / Modello / Anno			Cod. SGR		Cod. SGR		Cod. SGR	
HARLEY DAVIDSON								
1450	FXDS Dyna Convertible	1999/2000	065185	YTX20HL-BS■	—	—	—	—
1450	FXDS Dyna Convertible	1999/2000	065209	YTX20L-BS■	068209	ESTX20L-BS■	—	—
1450	FXDWG Dyna Wide Glide	2000/2005	0650202	GYZ20HL▲	—	—	—	—
1450	FXDWG Dyna Wide Glide	2000/2005	065185	YTX20HL-BS■	—	—	—	—
1450	FXDWG Dyna Wide Glide	2000/2005	065209	YTX20L-BS■	068209	ESTX20L-BS■	—	—
1450	FXDWGI Dyna Wide Glide F/ I	2004/2006	0650202	GYZ20HL▲	—	—	—	—
1450	FXDWGI Dyna Wide Glide F/ I	2004/2006	065185	YTX20HL-BS■	—	—	—	—
1450	FXDWGI Dyna Wide Glide F/ I	2004/2006	065209	YTX20L-BS■	068209	ESTX20L-BS■	—	—
1450	FXDX Dyna Super Glide Sport	1999/2003	0650202	GYZ20HL▲	—	—	—	—
1450	FXDX Dyna Super Glide Sport	1999/2003	065185	YTX20HL-BS■	—	—	—	—
1450	FXDX Dyna Super Glide Sport	1999/2003	065209	YTX20L-BS■	068209	ESTX20L-BS■	—	—
1450	FXDXI Dyna Super Glide Sport F.I.	2004/2005	0650202	GYZ20HL▲	—	—	—	—
1450	FXDXI Dyna Super Glide Sport F.I.	2004/2005	065185	YTX20HL-BS■	—	—	—	—
1450	FXDXI Dyna Super Glide Sport F.I.	2004/2005	065209	YTX20L-BS■	068209	ESTX20L-BS■	—	—
1450	FXDXT Dyna Super Glide T-Sport	2001/2003	0650202	GYZ20HL▲	—	—	—	—
1450	FXDXT Dyna Super Glide T-Sport	2001/2003	065185	YTX20HL-BS■	—	—	—	—
1450	FXDXT Dyna Super Glide T-Sport	2001/2003	065209	YTX20L-BS■	068209	ESTX20L-BS■	—	—
1450	FXST Softail Standard	2000/2003	0650202	GYZ20HL▲	—	—	—	—
1450	FXST Softail Standard	2000/2003	065185	YTX20HL-BS■	—	—	—	—
1450	FXST Softail Standard	2000/2003	065209	YTX20L-BS■	068209	ESTX20L-BS■	—	—
1450	FXSTB Night Train	2000/2006	0650202	GYZ20HL▲	—	—	—	—
1450	FXSTB Night Train	2000/2006	065185	YTX20HL-BS■	—	—	—	—
1450	FXSTB Night Train	2000/2006	065209	YTX20L-BS■	068209	ESTX20L-BS■	—	—
1450	FXSTBI Night Train F.I.	2001/2006	0650202	GYZ20HL▲	—	—	—	—
1450	FXSTBI Night Train F.I.	2001/2006	065185	YTX20HL-BS■	—	—	—	—
1450	FXSTBI Night Train F.I.	2001/2006	065209	YTX20L-BS■	068209	ESTX20L-BS■	—	—
1450	FXSTD Softail Deuce	2000/2006	0650202	GYZ20HL▲	—	—	—	—
1450	FXSTD Softail Deuce	2000/2006	065185	YTX20HL-BS■	—	—	—	—
1450	FXSTD Softail Deuce	2000/2006	065209	YTX20L-BS■	068209	ESTX20L-BS■	—	—
1450	FXSTDI Softail Deuce F.I.	2001/2006	0650202	GYZ20HL▲	—	—	—	—
1450	FXSTDI Softail Deuce F.I.	2001/2006	065185	YTX20HL-BS■	—	—	—	—
1450	FXSTDI Softail Deuce F.I.	2001/2006	065209	YTX20L-BS■	068209	ESTX20L-BS■	—	—
1450	FXSTI Softail Standard F.I.	2000/2006	0650202	GYZ20HL▲	—	—	—	—
1450	FXSTI Softail Standard F.I.	2000/2006	065185	YTX20HL-BS■	—	—	—	—
1450	FXSTI Softail Standard F.I.	2000/2006	065209	YTX20L-BS■	068209	ESTX20L-BS■	—	—
1450	FXSTS Springer Softail	2000/2006	0650202	GYZ20HL▲	—	—	—	—
1450	FXSTS Springer Softail	2000/2006	065185	YTX20HL-BS■	—	—	—	—
1450	FXSTS Springer Softail	2000/2006	065209	YTX20L-BS■	068209	ESTX20L-BS■	—	—
1450	FXSTSI Springer Softail F.I.	2001/2006	0650202	GYZ20HL▲	—	—	—	—
1450	FXSTSI Springer Softail F.I.	2001/2006	065185	YTX20HL-BS■	—	—	—	—
1450	FXSTSI Springer Softail F.I.	2001/2006	065209	YTX20L-BS■	068209	ESTX20L-BS■	—	—

▲ - Factory Sealed / Attivata dalla Fabbrica ■ - con Acido a corredo ◇ - Non di produzione YUASA a completamento gamma

Marca / Cilindrata / Modello / Anno			Cod. SGR		Cod. SGR		Cod. SGR		
HARLEY DAVIDSON									
1584	FLHR Road King	2007/2010	065275	YIX30L▲	—	—	—	—	
1584	FLHRC Road King Classic	2007/2010	065275	YIX30L▲	—	—	—	—	
1584	FLHRS Road King Custom	2007/2008	065275	YIX30L▲	—	—	—	—	
1584	FLHT Electra Glide Standard	2007/2010	065275	YIX30L▲	—	—	—	—	
1584	FLHTC Electra Glide Classic	2007/2012	065275	YIX30L▲	—	—	—	—	
1584	FLHTCU Ultra Classic Electra Glide	2007/2012	065275	YIX30L▲	—	—	—	—	
1584	FLHTCUTG Tri-Glide Ultra Classic	2010/2012	065275	YIX30L▲	—	—	—	—	
1584	FLHTRX Road Glide Custom	2010/2010	065275	YIX30L▲	—	—	—	—	
1584	FLHX Street Glide	2007/2012	065275	YIX30L▲	—	—	—	—	
1584	FLHXXX Street Glide Trike	2010/2010	065275	YIX30L▲	—	—	—	—	
1584	FLSTC Heritage Softail Classic	2007/2012	0650202	GYZ20HL▲	—	—	—	—	
1584	FLSTC Heritage Softail Classic	2007/2012	065185	YTX20HL-BS■	—	—	—	—	
1584	FLSTC Heritage Softail Classic	2007/2012	065209	YTX20L-BS■	068209	ESTX20L-BS■	—	—	
1584	FLSTF Fat Boy	2007/2012	0650202	GYZ20HL▲	—	—	—	—	
1584	FLSTF Fat Boy	2007/2012	065185	YTX20HL-BS■	—	—	—	—	
1584	FLSTF Fat Boy	2007/2012	065209	YTX20L-BS■	068209	ESTX20L-BS■	—	—	
1584	FLSTFB Softail Fat Boy Lo	2010/2012	0650202	GYZ20HL▲	—	—	—	—	
1584	FLSTFB Softail Fat Boy Lo	2010/2012	065185	YTX20HL-BS■	—	—	—	—	
1584	FLSTFB Softail Fat Boy Lo	2010/2012	065209	YTX20L-BS■	068209	ESTX20L-BS■	—	—	
1584	FLSTN Softail Deluxe	2007/2012	0650202	GYZ20HL▲	—	—	—	—	
1584	FLSTN Softail Deluxe	2007/2012	065185	YTX20HL-BS■	—	—	—	—	
1584	FLSTN Softail Deluxe	2007/2012	065209	YTX20L-BS■	068209	ESTX20L-BS■	—	—	
1584	FLSTSB Cross Bones	2008/2011	0650202	GYZ20HL▲	—	—	—	—	
1584	FLSTSB Cross Bones	2008/2011	065185	YTX20HL-BS■	—	—	—	—	
1584	FLSTSB Cross Bones	2008/2011	065209	YTX20L-BS■	068209	ESTX20L-BS■	—	—	
1584	FLSTSC Softail Springer	2007/2007	0650202	GYZ20HL▲	—	—	—	—	
1584	FLSTSC Softail Springer	2007/2007	065185	YTX20HL-BS■	—	—	—	—	
1584	FLSTSC Softail Springer	2007/2007	065209	YTX20L-BS■	068209	ESTX20L-BS■	—	—	
1584	FLTR Road Glide	2007/2010	065275	YIX30L▲	—	—	—	—	
1584	FLTRX Road Glide Custom	2010/2010	065275	YIX30L▲	—	—	—	—	
1584	FXD Dyna Super Glide	2007/2010	0650202	GYZ20HL▲	—	—	—	—	
1584	FXD Dyna Super Glide	2007/2010	065185	YTX20HL-BS■	—	—	—	—	
1584	FXD Dyna Super Glide	2007/2010	065209	YTX20L-BS■	068209	ESTX20L-BS■	—	—	
1584	FXDB Dyna Street Bob	2007/2013	0650202	GYZ20HL▲	—	—	—	—	
1584	FXDB Dyna Street Bob	2007/2013	065185	YTX20HL-BS■	—	—	—	—	
1584	FXDB Dyna Street Bob	2007/2013	065209	YTX20L-BS■	068209	ESTX20L-BS■	—	—	
1584	FXDC Dyna Super Glide Custom	2007/2013	0650202	GYZ20HL▲	—	—	—	—	
1584	FXDC Dyna Super Glide Custom	2007/2013	065185	YTX20HL-BS■	—	—	—	—	
1584	FXDC Dyna Super Glide Custom	2007/2013	065209	YTX20L-BS■	068209	ESTX20L-BS■	—	—	
1584	FXDF Fat Bob	2008/2012	0650202	GYZ20HL▲	—	—	—	—	
1584	FXDF Fat Bob	2008/2012	065185	YTX20HL-BS■	—	—	—	—	

▲ - Factory Sealed / Attivata dalla Fabbrica ■ - con Acido a corredo ◇ - Non di produzione YUASA a completamento gamma

Marca / Cilindrata / Modello / Anno			Cod. SGR		Cod. SGR		Cod. SGR	
HARLEY DAVIDSON								
1584	FXDF Fat Bob	2008/2012	065209	YTX20L-BS■	068209	ESTX20L-BS■	—	—
1584	FXDL Dyna Low Rider	2007/2007	0650202	GYZ20HL▲	—	—	—	—
1584	FXDL Dyna Low Rider	2007/2007	065185	YTX20HL-BS■	—	—	—	—
1584	FXDL Dyna Low Rider	2007/2007	065209	YTX20L-BS■	068209	ESTX20L-BS■	—	—
1584	FXDWG Dyna Wide Glide	2007/2012	0650202	GYZ20HL▲	—	—	—	—
1584	FXDWG Dyna Wide Glide	2007/2012	065185	YTX20HL-BS■	—	—	—	—
1584	FXDWG Dyna Wide Glide	2007/2012	065209	YTX20L-BS■	068209	ESTX20L-BS■	—	—
1584	FXS Softail Blackline	2011/2012	0650202	GYZ20HL▲	—	—	—	—
1584	FXS Softail Blackline	2011/2012	065185	YTX20HL-BS■	—	—	—	—
1584	FXS Softail Blackline	2011/2012	065209	YTX20L-BS■	068209	ESTX20L-BS■	—	—
1584	FXST Softail Standard	2007/2007	0650202	GYZ20HL▲	—	—	—	—
1584	FXST Softail Standard	2007/2007	065185	YTX20HL-BS■	—	—	—	—
1584	FXST Softail Standard	2007/2007	065209	YTX20L-BS■	068209	ESTX20L-BS■	—	—
1584	FXSTB Night Train	2007/2009	0650202	GYZ20HL▲	—	—	—	—
1584	FXSTB Night Train	2007/2009	065185	YTX20HL-BS■	—	—	—	—
1584	FXSTB Night Train	2007/2009	065209	YTX20L-BS■	068209	ESTX20L-BS■	—	—
1584	FXSTC Softail Custom	2007/2010	0650202	GYZ20HL▲	—	—	—	—
1584	FXSTC Softail Custom	2007/2010	065185	YTX20HL-BS■	—	—	—	—
1584	FXSTC Softail Custom	2007/2010	065209	YTX20L-BS■	068209	ESTX20L-BS■	—	—
1690	FLD Dyna Switchback	2012/2013	0650202	GYZ20HL▲	—	—	—	—
1690	FLD Dyna Switchback	2012/2013	065185	YTX20HL-BS■	—	—	—	—
1690	FLD Dyna Switchback	2012/2013	065209	YTX20L-BS■	068209	ESTX20L-BS■	—	—
1690	FLS Softail Slim	2013/2013	0650202	GYZ20HL▲	—	—	—	—
1690	FLS Softail Slim	2013/2013	065185	YTX20HL-BS■	—	—	—	—
1690	FLS Softail Slim	2013/2013	065209	YTX20L-BS■	068209	ESTX20L-BS■	—	—
1690	FLSTC Heritage Softail Classic	2013/2013	0650202	GYZ20HL▲	—	—	—	—
1690	FLSTC Heritage Softail Classic	2013/2013	065185	YTX20HL-BS■	—	—	—	—
1690	FLSTC Heritage Softail Classic	2013/2013	065209	YTX20L-BS■	068209	ESTX20L-BS■	—	—
1690	FLSTF Fat Boy	2013/2013	0650202	GYZ20HL▲	—	—	—	—
1690	FLSTF Fat Boy	2013/2013	065185	YTX20HL-BS■	—	—	—	—
1690	FLSTF Fat Boy	2013/2013	065209	YTX20L-BS■	068209	ESTX20L-BS■	—	—
1690	FLSTFB Softail Fat Boy Lo Special	2013/2013	0650202	GYZ20HL▲	—	—	—	—
1690	FLSTFB Softail Fat Boy Lo Special	2013/2013	065185	YTX20HL-BS■	—	—	—	—
1690	FLSTFB Softail Fat Boy Lo Special	2013/2013	065209	YTX20L-BS■	068209	ESTX20L-BS■	—	—
1690	FLSTN Softail Deluxe	2013/2013	0650202	GYZ20HL▲	—	—	—	—
1690	FLSTN Softail Deluxe	2013/2013	065185	YTX20HL-BS■	—	—	—	—
1690	FLSTN Softail Deluxe	2013/2013	065209	YTX20L-BS■	068209	ESTX20L-BS■	—	—
1690	FXDF Fat Bob	2013/2013	0650202	GYZ20HL▲	—	—	—	—
1690	FXDF Fat Bob	2013/2013	065185	YTX20HL-BS■	—	—	—	—
1690	FXDF Fat Bob	2013/2013	065209	YTX20L-BS■	068209	ESTX20L-BS■	—	—
1690	FXDWG Dyna Wide Glide	2013/2013	0650202	GYZ20HL▲	—	—	—	—



▲ - Factory Sealed / Attivata dalla Fabbrica ■ - con Acido a corredo ◇ - Non di produzione YUASA a completamento gamma

Marca / Cilindrata / Modello / Anno			Cod. SGR		Cod. SGR		Cod. SGR		
HARLEY DAVIDSON									
1690	FXDWG Dyna Wide Glide	2013/2013	065185	YTX20HL-BS■	—	—	—	—	
1690	FXDWG Dyna Wide Glide	2013/2013	065209	YTX20L-BS■	068209	ESTX20L-BS■	—	—	
1690	FXSB Breakout	2013/2013	0650202	GYZ20HL▲	—	—	—	—	
1690	FXSB Breakout	2013/2013	065185	YTX20HL-BS■	—	—	—	—	
1690	FXSB Breakout	2013/2013	065209	YTX20L-BS■	068209	ESTX20L-BS■	—	—	
1800	FLTRSE3 CVO Road Glide	2009/2009	0650202	GYZ20HL▲	—	—	—	—	
1800	FLTRSE3 CVO Road Glide	2009/2009	065185	YTX20HL-BS■	—	—	—	—	
1800	FLTRSE3 CVO Road Glide	2009/2009	065209	YTX20L-BS■	068209	ESTX20L-BS■	—	—	
1800	FXDFSE CVO Fat Bob	2009/2009	0650202	GYZ20HL▲	—	—	—	—	
1800	FXDFSE CVO Fat Bob	2009/2009	065185	YTX20HL-BS■	—	—	—	—	
1800	FXDFSE CVO Fat Bob	2009/2009	065209	YTX20L-BS■	068209	ESTX20L-BS■	—	—	
HM									
125	CRE B 2T Rotax (B125)	2011/2013	065007	YTZ7S▲	—	—	063007	FTZ7S▲	
125	CRE B 2T Rotax (B125)	2011/2013	065907	TTZ7S▲	068907	ESTTZ7S-BS■	—	—	
125	CRE F X 4T (Yamaha)	2008/2010	065007	YTZ7S▲	—	—	063007	FTZ7S▲	
125	CRE F X 4T (Yamaha)	2008/2010	065907	TTZ7S▲	068907	ESTTZ7S-BS■	—	—	
125	CRE F X Baja 4T (Yamaha)	2010/2012	065007	YTZ7S▲	—	—	063007	FTZ7S▲	
125	CRE F X Baja 4T (Yamaha)	2010/2012	065907	TTZ7S▲	068907	ESTTZ7S-BS■	—	—	
125	CRE F X Baja RR 4T (Yamaha)	2010/2012	065007	YTZ7S▲	—	—	063007	FTZ7S▲	
125	CRE F X Baja RR 4T (Yamaha)	2010/2012	065907	TTZ7S▲	068907	ESTTZ7S-BS■	—	—	
125	CRE F X SIX 4T (Yamaha)	2010/2011	065007	YTZ7S▲	—	—	063007	FTZ7S▲	
125	CRE F X SIX 4T (Yamaha)	2010/2011	065907	TTZ7S▲	068907	ESTTZ7S-BS■	—	—	
125	CRM F X 4T (Yamaha)	2008/2010	065007	YTZ7S▲	—	—	063007	FTZ7S▲	
125	CRM F X 4T (Yamaha)	2008/2010	065907	TTZ7S▲	068907	ESTTZ7S-BS■	—	—	
125	CRM F X Derapage 4T (Yamaha)	2010/2012	065007	YTZ7S▲	—	—	063007	FTZ7S▲	
125	CRM F X Derapage 4T (Yamaha)	2010/2012	065907	TTZ7S▲	068907	ESTTZ7S-BS■	—	—	
125	CRM F X Derapage Competition 4T (Yamaha)	2010/2011	065007	YTZ7S▲	—	—	063007	FTZ7S▲	
125	CRM F X Derapage Competition 4T (Yamaha)	2010/2011	065907	TTZ7S▲	068907	ESTTZ7S-BS■	—	—	
125	CRM F X Derapage RR 4T (Yamaha)	2010/2012	065007	YTZ7S▲	—	—	063007	FTZ7S▲	
125	CRM F X Derapage RR 4T (Yamaha)	2010/2012	065907	TTZ7S▲	068907	ESTTZ7S-BS■	—	—	
125	Scrambler City 4T (Yamaha)	2011/2013	065007	YTZ7S▲	—	—	063007	FTZ7S▲	
125	Scrambler City 4T (Yamaha)	2011/2013	065907	TTZ7S▲	068907	ESTTZ7S-BS■	—	—	
125	Trail Locusta 4T (Yamaha)	2011/2013	065007	YTZ7S▲	—	—	063007	FTZ7S▲	
125	Trail Locusta 4T (Yamaha)	2011/2013	065907	TTZ7S▲	068907	ESTTZ7S-BS■	—	—	
200	Scrambler City 4T (Yamaha)	2011/2013	065007	YTZ7S▲	—	—	063007	FTZ7S▲	
200	Scrambler City 4T (Yamaha)	2011/2013	065907	TTZ7S▲	068907	ESTTZ7S-BS■	—	—	
200	Trail Locusta 4T (Yamaha)	2011/2013	065007	YTZ7S▲	—	—	063007	FTZ7S▲	
200	Trail Locusta 4T (Yamaha)	2011/2013	065907	TTZ7S▲	068907	ESTTZ7S-BS■	—	—	
250	CRE X	2004/2006	065049	YTX5L-BS■	068049	ESTX5L-BS■	063049	FTX5L-BS■	
250	CRE X IE	2007/2009	065049	YTX5L-BS■	068049	ESTX5L-BS■	063049	FTX5L-BS■	
250	CRM FX IE (ZENF25XJMC)	2007/2008	065049	YTX5L-BS■	068049	ESTX5L-BS■	063049	FTX5L-BS■	



▲ - Factory Sealed / Attivata dalla Fabbrica ■ - con Acido a corredo ◇ - Non di produzione YUASA a completamento gamma

Marca / Cilindrata / Modello / Anno			Cod. SGR		Cod. SGR		Cod. SGR		
HM									
290	CRE X IE	2007/2008	065049	YTX5L-BS■	068049	ESTX5L-BS■	063049	FTX5L-BS■	
290	CRM FX IE (ZENF29XJMC)	2007/2008	065049	YTX5L-BS■	068049	ESTX5L-BS■	063049	FTX5L-BS■	
300	CRE F X	2009/2010	065049	YTX5L-BS■	068049	ESTX5L-BS■	063049	FTX5L-BS■	
500	CRE F X	2005/2009	065007	YTZ7S▲	—	—	063007	FTZ7S▲	
500	CRE F X	2005/2009	065907	TTZ7S▲	068907	ESTTZ7S-BS■	—	—	
HONDA									
50	GP Dio	1989/>	0650390	YTX4L-BS■	068039	ESTX4L-BS■	—	—	
50	NH Lead (AF01)	1985/>	06504340	YB4L-B	—	—	—	—	
50	NH Lead (AF01)	1985/>	065043410	YB4L-B■	0680434	ESB4L-B■	—	—	
50	NPS Zoomer	2005/2012	065007	YTZ7S▲	—	—	063007	FTZ7S▲	
50	NPS Zoomer	2005/2012	065907	TTZ7S▲	068907	ESTTZ7S-BS■	—	—	
50	NSC R 4T	2013/2013	0650690	YTX7L-BS■	068069	ESTX7L-BS■	063069	FTX7L-BS■	
50	NSC Vision 4T R14	2012/2013	0650690	YTX7L-BS■	068069	ESTX7L-BS■	063069	FTX7L-BS■	
50	NSC Vision 4T R16	2012/2014	0650690	YTX7L-BS■	068069	ESTX7L-BS■	063069	FTX7L-BS■	
50	PK Wallaroo	1990/2001	0650390	YTX4L-BS■	068039	ESTX4L-BS■	—	—	
50	PX	1980/1990	06504340	YB4L-B	—	—	—	—	
50	PX	1980/1990	065043410	YB4L-B■	0680434	ESB4L-B■	—	—	
50	PXR	1985/>	06504340	YB4L-B	—	—	—	—	
50	PXR	1985/>	065043410	YB4L-B■	0680434	ESB4L-B■	—	—	
50	SA Vision (AF29)	1988/1994	0650390	YTX4L-BS■	068039	ESTX4L-BS■	—	—	
50	SC 01/ SR	1992/>	0650390	YTX4L-BS■	068039	ESTX4L-BS■	—	—	
50	SFXS (AF37)	1996/1996	065029	YTR4A-BS■	068029	ESTR4A-BS■	—	—	
50	SGX Sky	1997/2001	0650390	YTX4L-BS■	068039	ESTX4L-BS■	—	—	
50	SH Fifty (AF40)	1996/2001	065029	YTR4A-BS■	068029	ESTR4A-BS■	—	—	
50	SH H	1991/1995	06504340	YB4L-B	—	—	—	—	
50	SH H	1991/1995	065043410	YB4L-B■	0680434	ESB4L-B■	—	—	
50	SJ Bali (AF32)	1996/1996	065029	YTR4A-BS■	068029	ESTR4A-BS■	—	—	
50	SP Dio DT	1993/>	0650390	YTX4L-BS■	068039	ESTX4L-BS■	—	—	
50	SP Dio TT	1993/>	0650390	YTX4L-BS■	068039	ESTX4L-BS■	—	—	
50	SR Dio	1992/>	0650390	YTX4L-BS■	068039	ESTX4L-BS■	—	—	
50	SRX Shadow (AF20E)	1997/1997	065049	YTX5L-BS■	068049	ESTX5L-BS■	063049	FTX5L-BS■	
50	SXR	1995/>	065029	YTR4A-BS■	068029	ESTR4A-BS■	—	—	
50	X8RS/ X8RX	1999/2001	065029	YTR4A-BS■	068029	ESTR4A-BS■	—	—	
50	ZX Dio	</1993	0650390	YTX4L-BS■	068039	ESTX4L-BS■	—	—	
50	ZX Dio	1994/>	065029	YTR4A-BS■	068029	ESTR4A-BS■	—	—	
90	SRX Shadow (HF09)	1998/>	065049	YTX5L-BS■	068049	ESTX5L-BS■	063049	FTX5L-BS■	
100	CB	1970/1972	0600633	6N6-3B	—	—	—	—	
100	CL S Scrambler	1970/1973	0600633	6N6-3B	—	—	—	—	
100	SCV Lead (JF11)	2003/2007	065049	YTX5L-BS■	068049	ESTX5L-BS■	063049	FTX5L-BS■	
100	SH	1996/1999	065049	YTX5L-BS■	068049	ESTX5L-BS■	063049	FTX5L-BS■	
100	SJ Bali (HF07)	1996/1999	065049	YTX5L-BS■	068049	ESTX5L-BS■	063049	FTX5L-BS■	



▲ - Factory Sealed / Attivata dalla Fabbrica ■ - con Acido a corredo ◇ - Non di produzione YUASA a completamento gamma

Marca / Cilindrata / Modello / Anno		Cod. SGR		Cod. SGR		Cod. SGR	
HONDA							
110 NHX Lead	2008/2011	0650690	YTX7L-BS■	068069	ESTX7L-BS■	063069	FTX7L-BS■
110 NSC Vision 4T R14	2011/2013	0650690	YTX7L-BS■	068069	ESTX7L-BS■	063069	FTX7L-BS■
110 NSC Vision 4T R16	2012/2014	0650690	YTX7L-BS■	068069	ESTX7L-BS■	063069	FTX7L-BS■
125 ANF Innova IE	2003/2012	065049	YTX5L-BS■	068049	ESTX5L-BS■	063049	FTX5L-BS■
125 Ca Rebel (Jc24) (Jc26)	1995/2000	0650690	YTX7L-BS■	068069	ESTX7L-BS■	063069	FTX7L-BS■
125 CB (S2)	1975/1977	0600633	6N6-3B	—	—	—	—
125 CB Italia	1976/1982	0600633	6N6-3B	—	—	—	—
125 CB J	1978/1978	0600633	6N6-3B	—	—	—	—
125 CB N	1976/1979	0600633	6N6-3B	—	—	—	—
125 CB RS	1984/1988	0600633	6N6-3B	—	—	—	—
125 CB S	1976/1982	0600633	6N6-3B	—	—	—	—
125 CB T2/ TA/ TB	1979/1982	0600633	6N6-3B	—	—	—	—
125 CB TD (JC06)	1982/1993	06509350	YB9-B	0680935	ESB9-B■	—	—
125 CB TT (JC06)	1990/1990	06509350	YB9-B	0680935	ESB9-B■	—	—
125 CBF (CBF125M9/ A/ B)	2009/2014	0650690	YTX7L-BS■	068069	ESTX7L-BS■	063069	FTX7L-BS■
125 CBR R (JC34/ J39)	2004/2011	065007	YTZ7S▲	—	—	063007	FTZ7S▲
125 CBR R (JC34/ J39)	2004/2011	065907	TTZ7S▲	068907	ESTTZ7S-BS■	—	—
125 CBR R (JC34/ J39)	2012/2016	0650061	YTZ6V■	—	—	—	—
125 CBX/ Endurance	TUTTI	0600633	6N6-3B	—	—	—	—
125 CH Spacy (JF02/ JF03)	1988/1995	0650990	YTX9-BS■	068099	ESTX9-BS■	063099	FTX9-BS■
125 CLR City Fly (JD18)	1998/2003	065049	YTX5L-BS■	068049	ESTX5L-BS■	063049	FTX5L-BS■
125 CM / CM C (JC5)	1982/1999	—	—	—	—	—	—
125 CMX	1982/1985	0650690	YTX7L-BS■	068069	ESTX7L-BS■	063069	FTX7L-BS■
125 CRM R	1990/1998	0650390	YTX4L-BS■	068039	ESTX4L-BS■	—	—
125 FES Pantheon 2T (JF05)	1998/2002	0651110	YT12A-BS■	0681110	EST12A-BS■	—	—
125 FES Pantheon 4T (JF12)	2003/2006	0650690	YTX7L-BS■	068069	ESTX7L-BS■	063069	FTX7L-BS■
125 FES S Wing	2007/2012	0650690	YTX7L-BS■	068069	ESTX7L-BS■	063069	FTX7L-BS■
125 MSX	2013/2014	065005	YTZ5S■	—	—	—	—
125 MT Elsinore	1974/1976	0600633	6N6-3B	—	—	—	—
125 MTX R (JD05)	1983/1995	0650534	YB5L-B	0680534	ESB5L-B■	—	—
125 NES Chiocciola (JF07)	2000/2006	0650690	YTX7L-BS■	068069	ESTX7L-BS■	063069	FTX7L-BS■
125 NS F	1988/1997	0650534	YB5L-B	0680534	ESB5L-B■	—	—
125 NS R/ R II	1985/1999	0650534	YB5L-B	0680534	ESB5L-B■	—	—
125 NSR F	1990/1992	065049	YTX5L-BS■	068049	ESTX5L-BS■	063049	FTX5L-BS■
125 NSR R/ R II/ Raiden	1990/>	065049	YTX5L-BS■	068049	ESTX5L-BS■	063049	FTX5L-BS■
125 NSS FORZA ADF	2015/2015	0650081	YTZ8V▲	0680081	ESTZ8V▲	—	—
125 NX Italy	1990/>	—	—	—	—	—	—
125 NX Transcity (JD12)	1989/1998	—	—	—	—	—	—
125 PCX (JF2811)	2010/2012	065007	YTZ7S▲	—	—	063007	FTZ7S▲
125 PCX ESP (JF2812/ JF4711/ JF5711)	2012/2014	065007	YTZ7S▲	—	—	063007	FTZ7S▲
125 PCX ESP (JF2812/ JF4711/ JF5711)	2015/2016	0650081	YTZ8V▲	0680081	ESTZ8V▲	—	—



▲ - Factory Sealed / Attivata dalla Fabbrica ■ - con Acido a corredo ◇ - Non di produzione YUASA a completamento gamma

Marca / Cilindrata / Modello / Anno			Cod. SGR		Cod. SGR		Cod. SGR	
HONDA								
125 PES PS i	2006/2012	0650690	YTX7L-BS■	068069	ESTX7L-BS■	063069	FTX7L-BS■	
125 SES Dylan (JF10)	2002/2004	0650690	YTX7L-BS■	068069	ESTX7L-BS■	063069	FTX7L-BS■	
125 SH (JF09)	2001/2004	0650690	YTX7L-BS■	068069	ESTX7L-BS■	063069	FTX7L-BS■	
125 SH i	2017/2017	0650081	YTZ8V▲	0680081	ESTZ8V▲	—	—	
125 SH IE (JF14A/ JF23A/ JF23B)	2005/2010	0650690	YTX7L-BS■	068069	ESTX7L-BS■	063069	FTX7L-BS■	
125 SH IE (JF41E)	2013/2014	065007	YTZ7S▲	—	—	063007	FTZ7S▲	
125 SH IE ABS (JF41E)	2013/2016	065007	YTZ7S▲	—	—	063007	FTZ7S▲	
125 SH IE DD (JF23B)	2009/2012	0650690	YTX7L-BS■	068069	ESTX7L-BS■	063069	FTX7L-BS■	
125 SH MODE (ANC125E-JF51)	2014/2015	065007	YTZ7S▲	—	—	063007	FTZ7S▲	
125 SL Moto Sport	1971/1973	0600633	6N6-3B	—	—	—	—	
125 VT C Shadow	1999/2000	0650690	YTX7L-BS■	068069	ESTX7L-BS■	063069	FTX7L-BS■	
125 VT C Shadow	2001/2003	065007	YTZ7S▲	—	—	063007	FTZ7S▲	
125 VT C Shadow	2001/2003	065907	TTZ7S▲	068907	ESTTZ7S-BS■	—	—	
125 VT C Shadow	2004/2008	0650690	YTX7L-BS■	068069	ESTX7L-BS■	063069	FTX7L-BS■	
125 XL R (C/ F/ H) (JD04)	1985/1987	—	—	—	—	—	—	
125 XL SA/ SA/ SC/ SD	1979/1982	0600413	6N4-2A-4	—	—	—	—	
125 XLV Varadero	2001/2011	065007	YTZ7S▲	—	—	063007	FTZ7S▲	
125 XLV Varadero	2001/2011	065907	TTZ7S▲	068907	ESTTZ7S-BS■	—	—	
125 XR L (JD19A)	2003/2010	065049	YTX5L-BS■	068049	ESTX5L-BS■	063049	FTX5L-BS■	
150 CH Spacy (JF02/ JF03)	1988/1995	0650990	YTX9-BS■	068099	ESTX9-BS■	063099	FTX9-BS■	
150 FES Pantheon 2T (JF05)	1998/2002	0651110	YT12A-BS■	0681110	EST12A-BS■	—	—	
150 FES Pantheon 4T (KF06)	2003/2006	0650690	YTX7L-BS■	068069	ESTX7L-BS■	063069	FTX7L-BS■	
150 FES S Wing	2007/2012	0650690	YTX7L-BS■	068069	ESTX7L-BS■	063069	FTX7L-BS■	
150 NES Chiocciola (KF03)	2000/2006	0650690	YTX7L-BS■	068069	ESTX7L-BS■	063069	FTX7L-BS■	
150 PCX	2012/2014	065007	YTZ7S▲	—	—	063007	FTZ7S▲	
150 PCX	2015/2016	0650081	YTZ8V▲	0680081	ESTZ8V▲	—	—	
150 PES PS i	2006/2012	0650690	YTX7L-BS■	068069	ESTX7L-BS■	063069	FTX7L-BS■	
150 SES Dylan (JF10)	2002/2004	0650690	YTX7L-BS■	068069	ESTX7L-BS■	063069	FTX7L-BS■	
150 SH (KF04)	2001/2004	0650690	YTX7L-BS■	068069	ESTX7L-BS■	063069	FTX7L-BS■	
150 SH i	2017/2017	0650081	YTZ8V▲	0680081	ESTZ8V▲	—	—	
150 SH IE (KF08A)	2005/2010	0650690	YTX7L-BS■	068069	ESTX7L-BS■	063069	FTX7L-BS■	
150 SH IE (KF13E)	2013/2014	065007	YTZ7S▲	—	—	063007	FTZ7S▲	
150 SH IE ABS (KF13E)	2013/2016	065007	YTZ7S▲	—	—	063007	FTZ7S▲	
150 SH IE DD (KF10B)	2009/2012	0650690	YTX7L-BS■	068069	ESTX7L-BS■	063069	FTX7L-BS■	
175 XI	1973/1978	0600633	6N6-3B	—	—	—	—	
200 ATC Big Red	1982/1984	065122	YTX14AH-BS■	068122	ESTX14AH-BS■	—	—	
200 ATC Big Red	1982/1984	0651431	YB14A-A2	0681431	ESB14A-A2■	—	—	
200 ATC M	1984/1985	065122	YTX14AH-BS■	068122	ESTX14AH-BS■	—	—	
200 ATC M	1984/1985	0651431	YB14A-A2	0681431	ESB14A-A2■	—	—	
200 CB	1974/1978	—	—	—	—	—	—	
200 CT Auto AG	1989/1989	—	—	—	—	—	—	



▲ - Factory Sealed / Attivata dalla Fabbrica ■ - con Acido a corredo ◇ - Non di produzione YUASA a completamento gamma

Marca / Cilindrata / Modello / Anno			Cod. SGR		Cod. SGR		Cod. SGR		
HONDA									
200	TRX FourTrax	1984/1984	065122	YTX14AH-BS■	068122	ESTX14AH-BS■	—	—	
200	TRX FourTrax	1984/1984	0651431	YB14A-A2	0681431	ESB14A-A2■	—	—	
200	TRX FourTrax	1990/1997	0651090	YTX12-BS■	0681090	ESTX12-BS■	063109	FTX12-BS■	
200	XL R / Paris Dakar (MD06)	1986/>	—	—	—	—	—	—	
200	XR R	2000/2002	0650690	YTX7L-BS■	068069	ESTX7L-BS■	063069	FTX7L-BS■	
223	FTR	2000/2004	065049	YTX5L-BS■	068049	ESTX5L-BS■	063049	FTX5L-BS■	
230	CRF F (ME09)	2003/2010	065049	YTX5L-BS■	068049	ESTX5L-BS■	063049	FTX5L-BS■	
230	CRF F Easy Motard (ME03)	2003/2006	065049	YTX5L-BS■	068049	ESTX5L-BS■	063049	FTX5L-BS■	
230	SL	1997/2004	065049	YTX5L-BS■	068049	ESTX5L-BS■	063049	FTX5L-BS■	
250	CB F Hornet (MC31)	1996/2007	0650690	YTX7L-BS■	068069	ESTX7L-BS■	063069	FTX7L-BS■	
250	CB N	1979/1982	0651234	YB12A-A	0681234	ESB12A-A■	—	—	
250	CB Nighthawk (MC24)	1991/2008	0650690	YTX7L-BS■	068069	ESTX7L-BS■	063069	FTX7L-BS■	
250	CB T (T1/ T2)	1977/1978	0651234	YB12A-A	0681234	ESB12A-A■	—	—	
250	CB Two Fifty (MC26)	1991/1997	0650690	YTX7L-BS■	068069	ESTX7L-BS■	063069	FTX7L-BS■	
250	CBF (MC35A)	2004/2007	0650690	YTX7L-BS■	068069	ESTX7L-BS■	063069	FTX7L-BS■	
250	CBR R (MC41B)	2011/2014	0650690	YTX7L-BS■	068069	ESTX7L-BS■	063069	FTX7L-BS■	
250	CBR R ABS (MC41B)	2011/2014	0650690	YTX7L-BS■	068069	ESTX7L-BS■	063069	FTX7L-BS■	
250	CBR RR (MC22)	1990/2003	0650690	YTX7L-BS■	068069	ESTX7L-BS■	063069	FTX7L-BS■	
250	CM C (MC06)	1982/1983	06509350	YB9-B	0680935	ESB9-B■	—	—	
250	CMX C Rebel (MC13)	1985/1996	06509350	YB9-B	0680935	ESB9-B■	—	—	
250	CMX C Rebel (MC32)	1997/2007	0650690	YTX7L-BS■	068069	ESTX7L-BS■	063069	FTX7L-BS■	
250	CN Helix/ Spazio (MF02)	1995/1999	0651090	YTX12-BS■	0681090	ESTX12-BS■	063109	FTX12-BS■	
250	CRF L (MD38)	2013/2016	0650690	YTX7L-BS■	068069	ESTX7L-BS■	063069	FTX7L-BS■	
250	CRF L (MD44A)	2017/2017	0650081	YTZ8V▲	0680081	ESTZ8V▲	—	—	
250	CRF M (MD38)	2013/2016	0650690	YTX7L-BS■	068069	ESTX7L-BS■	063069	FTX7L-BS■	
250	CRF X (ME11)	2004/2017	065049	YTX5L-BS■	068049	ESTX5L-BS■	063049	FTX5L-BS■	
250	FES Foresight (MF04/ MF05)	1997/2005	0651090	YTX12-BS■	0681090	ESTX12-BS■	063109	FTX12-BS■	
250	MT Elsinore	1974/1976	0600633	6N6-3B	—	—	—	—	
250	NSS Forza A ABS (MF10)	2008/2012	065012	YTZ12S▲	—	—	063012	FTZ12S▲	
250	NSS Forza A ABS (MF10)	2008/2012	065912	TTZ12S-BS	068912	ESTTZ12S-BS■	—	—	
250	NSS Forza EX (MF08)	2005/2007	065012	YTZ12S▲	—	—	063012	FTZ12S▲	
250	NSS Forza EX (MF08)	2005/2007	065912	TTZ12S-BS	068912	ESTTZ12S-BS■	—	—	
250	NSS Forza S (MF10)	2008/2012	065012	YTZ12S▲	—	—	063012	FTZ12S▲	
250	NSS Forza S (MF10)	2008/2012	065912	TTZ12S-BS	068912	ESTTZ12S-BS■	—	—	
250	NSS Forza X (MF08)	2005/2007	065012	YTZ12S▲	—	—	063012	FTZ12S▲	
250	NSS Forza X (MF08)	2005/2007	065912	TTZ12S-BS	068912	ESTTZ12S-BS■	—	—	
250	NSS Jazz	2001/2004	065012	YTZ12S▲	—	—	063012	FTZ12S▲	
250	NSS Jazz	2001/2004	065912	TTZ12S-BS	068912	ESTTZ12S-BS■	—	—	
250	NSS Jazz ABS	2001/2004	065012	YTZ12S▲	—	—	063012	FTZ12S▲	
250	NSS Jazz ABS	2001/2004	065912	TTZ12S-BS	068912	ESTTZ12S-BS■	—	—	
250	NX AX1 (MD21/ MD25)	1988/1996	0650690	YTX7L-BS■	068069	ESTX7L-BS■	063069	FTX7L-BS■	



▲ - Factory Sealed / Attivata dalla Fabbrica ■ - con Acido a corredo ◇ - Non di produzione YUASA a completamento gamma

Marca / Cilindrata / Modello / Anno			Cod. SGR		Cod. SGR		Cod. SGR		
HONDA									
250	TRX / TRX ES Recon	1997/2007	0651090	YTX12-BS■	0681090	ESTX12-BS■	063109	FTX12-BS■	
250	TRX EX Sportrax	2001/2009	0650990	YTX9-BS■	068099	ESTX9-BS■	063099	FTX9-BS■	
250	TRX TE Fourtrax Recon (TE2/ TEA)	2002/2010	0651090	YTX12-BS■	0681090	ESTX12-BS■	063109	FTX12-BS■	
250	TRX TM Fourtrax Recon (TM2/ TMA)	2002/2010	0651090	YTX12-BS■	0681090	ESTX12-BS■	063109	FTX12-BS■	
250	TRX X / X Fourtrax	1986/1988	0651090	YTX12-BS■	0681090	ESTX12-BS■	063109	FTX12-BS■	
250	TRX X Sportrax (X9/ XA)	2009/2010	0650990	YTX9-BS■	068099	ESTX9-BS■	063099	FTX9-BS■	
250	VT C V Twin Magna (MC29)	1983/1997	0650690	YTX7L-BS■	068069	ESTX7L-BS■	063069	FTX7L-BS■	
250	VT C V Twin Magna S	1996/1997	0650690	YTX7L-BS■	068069	ESTX7L-BS■	063069	FTX7L-BS■	
250	VTR (MC15)	1988/1990	0650990	YTX9-BS■	068099	ESTX9-BS■	063099	FTX9-BS■	
250	VTR (MC33)	1998/2004	0650690	YTX7L-BS■	068069	ESTX7L-BS■	063069	FTX7L-BS■	
250	XL (K0/ K1/ K2/ 76)	1972/1976	0600633	6N6-3B	—	—	—	—	
250	XL S (78/ Z/ A/ B)	1978/1981	0600413	6N4-2A-4	—	—	—	—	
250	XLR (MD11)	1984/1987	0650334	YB3L-A	0680334	ESB3L-A■	—	—	
300	CBF	2015/2015	0650690	YTX7L-BS■	068069	ESTX7L-BS■	063069	FTX7L-BS■	
300	CBR R	2014/2015	0650690	YTX7L-BS■	068069	ESTX7L-BS■	063069	FTX7L-BS■	
300	CBR RA ABS	2014/2015	0650690	YTX7L-BS■	068069	ESTX7L-BS■	063069	FTX7L-BS■	
300	CMX REBEL	2017/2017	0650081	YTZ8V▲	0680081	ESTZ8V▲	—	—	
300	NSS Forza	2013/2015	065012	YTZ12S▲	—	—	063012	FTZ12S▲	
300	NSS Forza	2013/2015	065912	TTZ12S-BS	068912	ESTTZ12S-BS■	—	—	
300	SH	2007/2014	065012	YTZ12S▲	—	—	063012	FTZ12S▲	
300	SH	2007/2014	065912	TTZ12S-BS	068912	ESTTZ12S-BS■	—	—	
300	SH ABS (NF0231/ NF02D)	2011/2014	065012	YTZ12S▲	—	—	063012	FTZ12S▲	
300	SH ABS (NF0231/ NF02D)	2011/2014	065912	TTZ12S-BS	068912	ESTTZ12S-BS■	—	—	
300	SH ABS (NF0511)	2015/2016	065012	YTZ12S▲	—	—	063012	FTZ12S▲	
300	SH ABS (NF0511)	2015/2016	065912	TTZ12S-BS	068912	ESTTZ12S-BS■	—	—	
300	TRX EX Sportrax (EXP/ EX8)	1993/2008	0650990	YTX9-BS■	068099	ESTX9-BS■	063099	FTX9-BS■	
300	TRX Fourtrax 2X4-4X4 (K/ Y)	1989/2000	065124	YTX14H-BS■	—	—	—	—	
300	TRX Fourtrax 2X4-4X4 (K/ Y)	1989/2000	065129	YTX14-BS■	068129	ESTX14-BS■	—	—	
300	TRX FW Fourtrax (FWJ/ FWY)	1993/2001	0650990	YTX9-BS■	068099	ESTX9-BS■	063099	FTX9-BS■	
350	CB F/ F1 Four	1972/1974	0651233	12N12A-4A-1	0681233	ES12N12A-4A-1■	—	—	
350	CB G Super Sport (K5)	1973/1973	0651233	12N12A-4A-1	0681233	ES12N12A-4A-1■	—	—	
350	CB S (G/ J) (NC22)	1986/1987	0651239	YB12A-B	0681239	ESB12A-B■	—	—	
350	CB S (G/ J) (NC22)	1988/1990	065122	YTX14AH-BS■	068122	ESTX14AH-BS■	—	—	
350	CB S (G/ J) (NC22)	1988/1990	0651438	YB14-B2	0681438	ESB14-B2■	—	—	
350	TRX D Fourtrax Foreman 4X4 (H/ J/ K)	1987/1989	065124	YTX14H-BS■	—	—	—	—	
350	TRX D Fourtrax Foreman 4X4 (H/ J/ K)	1987/1989	065129	YTX14-BS■	068129	ESTX14-BS■	—	—	
350	TRX FE Fourtrax Rancher 2X4-4X4 (FEY/ FE6)	2000/2006	065124	YTX14H-BS■	—	—	—	—	
350	TRX FE Fourtrax Rancher 2X4-4X4 (FEY/ FE6)	2000/2006	065129	YTX14-BS■	068129	ESTX14-BS■	—	—	
350	TRX FM Fourtrax Rancher 2X4-4X4 (FMY/ FM6)	2000/2006	065124	YTX14H-BS■	—	—	—	—	
350	TRX FM Fourtrax Rancher 2X4-4X4 (FMY/ FM6)	2000/2006	065129	YTX14-BS■	068129	ESTX14-BS■	—	—	
350	TRX Fourtrax 2X4-4X4 (G/ P)	1986/1993	065124	YTX14H-BS■	—	—	—	—	



▲ - Factory Sealed / Attivata dalla Fabbrica ■ - con Acido a corredo ◇ - Non di produzione YUASA a completamento gamma

Marca / Cilindrata / Modello / Anno			Cod. SGR		Cod. SGR		Cod. SGR		
HONDA									
350	TRX Fourtrax 2X4-4X4 (G/ P)	1986/1993	065129	YTX14-BS■	068129	ESTX14-BS■	—	—	
350	TRX TE Fourtrax Rancher ES 2X4-4X4 (TEY/ TE6)	2000/2006	065124	YTX14H-BS■	—	—	—	—	
350	TRX TE Fourtrax Rancher ES 2X4-4X4 (TEY/ TE6)	2000/2006	065129	YTX14-BS■	068129	ESTX14-BS■	—	—	
350	TRX TM Fourtrax Rancher ES 2X4-4X4 (TMY/ TM6)	2000/2006	065124	YTX14H-BS■	—	—	—	—	
350	TRX TM Fourtrax Rancher ES 2X4-4X4 (TMY/ TM6)	2000/2006	065129	YTX14-BS■	068129	ESTX14-BS■	—	—	
350	XL (K0/ K1/ 76/ 77/ 78)	1974/1978	0600633	6N6-3B	—	—	—	—	
350	XL R (ND03)	1984/1987	0650334	YB3L-A	0680334	ESB3L-A■	—	—	
350	XR R (NE02)	1983/1987	0650334	YB3L-A	0680334	ESB3L-A■	—	—	
400	CB F (F0/ F1/ F2)	1975/1977	0651233	12N12A-4A-1	0681233	ES12N12A-4A-1■	—	—	
400	CB N (A) (2Cil.)	1978/1980	0651234	YB12A-A	0681234	ESB12A-A■	—	—	
400	CB T Hawk (2CIL.)	1978/1981	0651234	YB12A-A	0681234	ESB12A-A■	—	—	
400	CBR R (NC23)	1987/1987	0650690	YTX7L-BS■	068069	ESTX7L-BS■	063069	FTX7L-BS■	
400	CBR RR (NC23)	1988/1989	0650690	YTX7L-BS■	068069	ESTX7L-BS■	063069	FTX7L-BS■	
400	CBX F/ F2 (NC07)	1982/>	0651234	YB12A-A	0681234	ESB12A-A■	—	—	
400	CM A Hondamatic (NC02)	1979/1981	0651234	YB12A-A	0681234	ESB12A-A■	—	—	
400	CM T (Z/ A/ B/ C)(NC01)	1979/1982	0651234	YB12A-A	0681234	ESB12A-A■	—	—	
400	FJS Silver Wing	2006/2008	065012	YTZ12S▲	—	—	063012	FTZ12S▲	
400	FJS Silver Wing T	2009/2014	065012	YTZ12S▲	—	—	063012	FTZ12S▲	
400	NSR (NC19V)	1985/>	065049	YTX5L-BS■	068049	ESTX5L-BS■	063049	FTX5L-BS■	
400	TRX EX SPORTRAX (EXY/ EX8)	1999/2008	0650990	YTX9-BS■	068099	ESTX9-BS■	063099	FTX9-BS■	
400	TRX FA Fourtrax Rancher AT (FA4/ FA7)	2004/2007	065124	YTX14H-BS■	—	—	—	—	
400	TRX FA Fourtrax Rancher AT (FA4/ FA7)	2004/2007	065129	YTX14-BS■	068129	ESTX14-BS■	—	—	
400	TRX FW Fourtrax Foreman 2x4-4x4 (FWS/ FW2)	1995/2002	065124	YTX14H-BS■	—	—	—	—	
400	TRX FW Fourtrax Foreman 2x4-4x4 (FWS/ FW2)	1995/2002	065129	YTX14-BS■	068129	ESTX14-BS■	—	—	
400	TRX X Sportrax (X9)	2009/2009	0650990	YTX9-BS■	068099	ESTX9-BS■	063099	FTX9-BS■	
400	VF F (NC13)	1985/1986	0651234	YB12A-A	0681234	ESB12A-A■	—	—	
400	VFR R (NC30)	1990/1991	0650700	YTX7A-BS■	068070	ESTX7A-BS■	—	—	
420	TRX FA Fourtrax Rancher (FA9/ FAA)	2009/2010	065124	YTX14H-BS■	—	—	—	—	
420	TRX FA Fourtrax Rancher (FA9/ FAA)	2009/2010	065129	YTX14-BS■	068129	ESTX14-BS■	—	—	
420	TRX FE Fourtrax Rancher (FE7/ FEA)	2007/2010	065124	YTX14H-BS■	—	—	—	—	
420	TRX FE Fourtrax Rancher (FE7/ FEA)	2007/2010	065129	YTX14-BS■	068129	ESTX14-BS■	—	—	
420	TRX FM Fourtrax Rancher 4X4 (FM7/ FMA)	2007/2010	065124	YTX14H-BS■	—	—	—	—	
420	TRX FM Fourtrax Rancher 4X4 (FM7/ FMA)	2007/2010	065129	YTX14-BS■	068129	ESTX14-BS■	—	—	
420	TRX FPM Fourtrax Rancher (FPM9/ FPMA)	2009/2010	065124	YTX14H-BS■	—	—	—	—	
420	TRX FPM Fourtrax Rancher (FPM9/ FPMA)	2009/2010	065129	YTX14-BS■	068129	ESTX14-BS■	—	—	
420	TRX TE Fourtrax Rancher (TE7/ TE9)	2007/2009	065124	YTX14H-BS■	—	—	—	—	
420	TRX TE Fourtrax Rancher (TE7/ TE9)	2007/2009	065129	YTX14-BS■	068129	ESTX14-BS■	—	—	
420	TRX TM Fourtrax Rancher (TM7/ TMA)	2007/2010	065124	YTX14H-BS■	—	—	—	—	
420	TRX TM Fourtrax Rancher (TM7/ TMA)	2007/2010	065129	YTX14-BS■	068129	ESTX14-BS■	—	—	
450	CB K1/ K2/ K3/ K4/ K5/ K6/ K7 Super Sport	1967/1974	0651233	12N12A-4A-1	0681233	ES12N12A-4A-1■	—	—	
450	CB N (PC14)	1983/1992	06512360	YB12AL-A	0681236	ESB12AL-A■	—	—	



▲ - Factory Sealed / Attivata dalla Fabbrica ■ - con Acido a corredo ◇ - Non di produzione YUASA a completamento gamma

Marca / Cilindrata / Modello / Anno			Cod. SGR		Cod. SGR		Cod. SGR		
HONDA									
450	CB N (PC14)	1983/1992	06512400	YB12AL-A2	0681240	ESB12AL-A2■	—	—	
450	CB S (PC17) (27CV)	1986/1987	0651239	YB12A-B	0681239	ESB12A-B■	—	—	
450	CB S (PC17) (27CV)	1988/1990	065122	YTX14AH-BS■	068122	ESTX14AH-BS■	—	—	
450	CB S (PC17) (27CV)	1988/1990	0651438	YB14-B2	0681438	ESB14-B2■	—	—	
450	CB S (PC17) (44CV)	1986/1987	0651239	YB12A-B	0681239	ESB12A-B■	—	—	
450	CB S (PC17) (44CV)	1988/1990	065122	YTX14AH-BS■	068122	ESTX14AH-BS■	—	—	
450	CB S (PC17) (44CV)	1988/1990	0651438	YB14-B2	0681438	ESB14-B2■	—	—	
450	CB SC Nighthawk (PC05)	1982/1986	0651234	YB12A-A	0681234	ESB12A-A■	—	—	
450	CB T Hawk (PC05)	1982/1982	0651234	YB12A-A	0681234	ESB12A-A■	—	—	
450	CMX C Rebel (PC170/ PC171/ PC18)	1986/1988	0651234	YB12A-A	0681234	ESB12A-A■	—	—	
450	CRF X (PE06)	2005/2017	065007	YTZ7S▲	—	—	063007	FTZ7S▲	
450	CRF X (PE06)	2005/2017	065907	TTZ7S▲	068907	ESTTZ7S-BS■	—	—	
450	TRX ER Sportrax (ER6/ ER9)	2006/2014	065007	YTZ7S▲	—	—	063007	FTZ7S▲	
450	TRX ER Sportrax (ER6/ ER9)	2006/2014	065907	TTZ7S▲	068907	ESTTZ7S-BS■	—	—	
450	TRX ES Foreman (ESW/ ES1)	1998/2001	065124	YTX14H-BS■	—	—	—	—	
450	TRX ES Foreman (ESW/ ES1)	1998/2001	065129	YTX14-BS■	068129	ESTX14-BS■	—	—	
450	TRX R Sportrax (R4/ R9)	2004/2009	065007	YTZ7S▲	—	—	063007	FTZ7S▲	
450	TRX R Sportrax (R4/ R9)	2004/2009	065907	TTZ7S▲	068907	ESTTZ7S-BS■	—	—	
450	TRX S Foreman (SW/ S1)	1998/2001	065124	YTX14H-BS■	—	—	—	—	
450	TRX S Foreman (SW/ S1)	1998/2001	065129	YTX14-BS■	068129	ESTX14-BS■	—	—	
500	CB F (PC45)	2013/2016	065010	YTZ10S▲	—	—	063010	FTZ10S▲	
500	CB FA ABS (PC45)	2013/2016	065010	YTZ10S▲	—	—	063010	FTZ10S▲	
500	CB Four (K0/ K1/ K2/ K3)	1971/1975	0651233	12N12A-4A-1	0681233	ES12N12A-4A-1■	—	—	
500	CB T TWIN DOHC (T0/ T1)	1975/1977	0651233	12N12A-4A-1	0681233	ES12N12A-4A-1■	—	—	
500	CB X (PC46)	2013/2016	065010	YTZ10S▲	—	—	063010	FTZ10S▲	
500	CB XA ABS (PC46)	2013/2016	065010	YTZ10S▲	—	—	063010	FTZ10S▲	
500	CB/ CB S (PC26/ PC32)	1994/2003	0650990	YTX9-BS■	068099	ESTX9-BS■	063099	FTX9-BS■	
500	CBF (PC39)	2004/2006	065010	YTZ10S▲	—	—	063010	FTZ10S▲	
500	CBF (PC39)	2004/2006	065910	TTZ10S-BS	068910	ESTTZ10S-BS■	—	—	
500	CBF Abs (PC39)	2004/2006	065010	YTZ10S▲	—	—	063010	FTZ10S▲	
500	CBF Abs (PC39)	2004/2006	065910	TTZ10S-BS	068910	ESTTZ10S-BS■	—	—	
500	CBR R (PC44)	2013/2016	065010	YTZ10S▲	—	—	063010	FTZ10S▲	
500	CBR R (PC44)	2013/2016	065910	TTZ10S-BS	068910	ESTTZ10S-BS■	—	—	
500	CBR RA ABS (PC44)	2013/2016	065010	YTZ10S▲	—	—	063010	FTZ10S▲	
500	CBR RA ABS (PC44)	2013/2016	065910	TTZ10S-BS	068910	ESTTZ10S-BS■	—	—	
500	CMX REBEL	2017/2017	0650081	YTZ8V▲	0680081	ESTZ8V▲	—	—	
500	CX (78)	1978/1978	065123	YTX14AHL-BS■	—	—	—	—	
500	CX (78)	1978/1978	0651434	YB14L-A2	0681434	ESB14L-A2■	—	—	
500	CX (Z/ A/ B/ C)	1979/1982	065123	YTX14AHL-BS■	—	—	—	—	
500	CX (Z/ A/ B/ C)	1979/1982	0651434	YB14L-A2	0681434	ESB14L-A2■	—	—	
500	CX C (PC01)	1979/1982	0651234	YB12A-A	0681234	ESB12A-A■	—	—	



▲ - Factory Sealed / Attivata dalla Fabbrica ■ - con Acido a corredo ◇ - Non di produzione YUASA a completamento gamma

Marca / Cilindrata / Modello / Anno		Cod. SGR		Cod. SGR		Cod. SGR		
HONDA								
500	CX D De Luxe (PC01)	1979/1981	0651234	YB12A-A	0681234	ESB12A-A■	—	—
500	CX E (PC06)	1982/1982	065123	YTX14AHL-BS■	—	—	—	—
500	CX E (PC06)	1982/1982	0651434	YB14L-A2	0681434	ESB14L-A2■	—	—
500	CX T Turbo (PC03)	1982/1982	065123	YTX14AHL-BS■	—	—	—	—
500	CX T Turbo (PC03)	1982/1982	0651434	YB14L-A2	0681434	ESB14L-A2■	—	—
500	FT Ascot (PC07)	1982/1983	065123	YTX14AHL-BS■	—	—	—	—
500	FT Ascot (PC07)	1982/1983	0651434	YB14L-A2	0681434	ESB14L-A2■	—	—
500	GL Silver Wing (PC02)	1981/1982	065123	YTX14AHL-BS■	—	—	—	—
500	GL Silver Wing (PC02)	1981/1982	0651434	YB14L-A2	0681434	ESB14L-A2■	—	—
500	TRX FA Fourtrax Foreman Rubicon (FA1/FAA)	2001/2010	065124	YTX14H-BS■	—	—	—	—
500	TRX FA Fourtrax Foreman Rubicon (FA1/FAA)	2001/2010	065129	YTX14-BS■	068129	ESTX14-BS■	—	—
500	TRX FE Fourtrax Foreman Rubicon 4X4 (FE5/FEA)	2005/2016	065124	YTX14H-BS■	—	—	—	—
500	TRX FE Fourtrax Foreman Rubicon 4X4 (FE5/FEA)	2005/2016	065129	YTX14-BS■	068129	ESTX14-BS■	—	—
500	TRX FM Fourtrax Foreman 4X4 (FM5/FMA)	2005/2010	065124	YTX14H-BS■	—	—	—	—
500	TRX FM Fourtrax Foreman 4X4 (FM5/FMA)	2005/2010	065129	YTX14-BS■	068129	ESTX14-BS■	—	—
500	TRX FPE Fourtrax Foreman Power S. 4X4 (FPE8/FPEA)	2008/2013	065124	YTX14H-BS■	—	—	—	—
500	TRX FPE Fourtrax Foreman Power S. 4X4 (FPE8/FPEA)	2008/2013	065129	YTX14-BS■	068129	ESTX14-BS■	—	—
500	TRX TM Fourtrax Foreman (TM5/TM6)	2005/2006	065124	YTX14H-BS■	—	—	—	—
500	TRX TM Fourtrax Foreman (TM5/TM6)	2005/2006	065129	YTX14-BS■	068129	ESTX14-BS■	—	—
500	VF C V30 Magna (PC13)	1984/1985	0651234	YB12A-A	0681234	ESB12A-A■	—	—
500	VF F Interceptor (PC12)	1984/1986	0651234	YB12A-A	0681234	ESB12A-A■	—	—
500	VT C Shadow (PC08)	1983/1986	0651234	YB12A-A	0681234	ESB12A-A■	—	—
500	VT E (PC11)	1983/1988	0651234	YB12A-A	0681234	ESB12A-A■	—	—
500	VT FT (PC10)	1983/1984	0651234	YB12A-A	0681234	ESB12A-A■	—	—
500	XBR S (27CV)	1988/1988	065124	YTX14H-BS■	—	—	—	—
500	XL R (PD02)	1982/1987	0650334	YB3L-A	0680334	ESB3L-A■	—	—
500	XL S (PD01)	1979/1981	0600413	6N4-2A-4	—	—	—	—
550	CB Four (K0/ K1/ K2/ K3/ K4)	1974/1978	0651233	12N12A-4A-1	0681233	ES12N12A-4A-1■	—	—
550	CBX F/ F2 (PC04)	1982/1984	0651234	YB12A-A	0681234	ESB12A-A■	—	—
600	CB F Hornet (PC34)	1998/2001	0650690	YTX7L-BS■	068069	ESTX7L-BS■	063069	FTX7L-BS■
600	CB F Hornet (PC34)	2002/2002	065007	YTZ7S▲	—	—	063007	FTZ7S▲
600	CB F Hornet (PC34)	2002/2002	065907	TTZ7S▲	068907	ESTTZ7S-BS■	—	—
600	CB F Hornet (PC36)	2003/2006	0650690	YTX7L-BS■	068069	ESTX7L-BS■	063069	FTX7L-BS■
600	CB F Hornet (PC41)	2007/2013	065010	YTZ10S▲	—	—	063010	FTZ10S▲
600	CB F Hornet (PC41)	2007/2013	065910	TTZ10S-BS	068910	ESTTZ10S-BS■	—	—
600	CB F Hornet Abs (PC41)	2007/2013	065010	YTZ10S▲	—	—	063010	FTZ10S▲
600	CB F Hornet Abs (PC41)	2007/2013	065910	TTZ10S-BS	068910	ESTTZ10S-BS■	—	—
600	CB F Hornet S (PC34)	2000/2001	0650690	YTX7L-BS■	068069	ESTX7L-BS■	063069	FTX7L-BS■
600	CB F Hornet S (PC34)	2002/2002	065007	YTZ7S▲	—	—	063007	FTZ7S▲
600	CB F Hornet S (PC34)	2002/2002	065907	TTZ7S▲	068907	ESTTZ7S-BS■	—	—
600	CB F Hornet S (PC36)	2003/2006	0650690	YTX7L-BS■	068069	ESTX7L-BS■	063069	FTX7L-BS■



▲ - Factory Sealed / Attivata dalla Fabbrica ■ - con Acido a corredo ◇ - Non di produzione YUASA a completamento gamma

Marca / Cilindrata / Modello / Anno			Cod. SGR		Cod. SGR		Cod. SGR		
HONDA									
600	CBF N (PC38/ PC43)	2004/2007	0650690	YTX7L-BS■	068069	ESTX7L-BS■	063069	FTX7L-BS■	
600	CBF N (PC38/ PC43)	2008/2012	065010	YTZ10S▲	—	—	063010	FTZ10S▲	
600	CBF N (PC38/ PC43)	2008/2012	065910	TTZ10S-BS	068910	ESTTZ10S-BS■	—	—	
600	CBF N ABS (PC38/ PC43)	2004/2007	0650690	YTX7L-BS■	068069	ESTX7L-BS■	063069	FTX7L-BS■	
600	CBF N ABS (PC38/ PC43)	2008/2012	065010	YTZ10S▲	—	—	063010	FTZ10S▲	
600	CBF N ABS (PC38/ PC43)	2008/2012	065910	TTZ10S-BS	068910	ESTTZ10S-BS■	—	—	
600	CBF S (PC38/ PC43)	2004/2007	0650690	YTX7L-BS■	068069	ESTX7L-BS■	063069	FTX7L-BS■	
600	CBF S (PC38/ PC43)	2008/2012	065010	YTZ10S▲	—	—	063010	FTZ10S▲	
600	CBF S (PC38/ PC43)	2008/2012	065910	TTZ10S-BS	068910	ESTTZ10S-BS■	—	—	
600	CBF S ABS (PC38/ PC43)	2004/2007	0650690	YTX7L-BS■	068069	ESTX7L-BS■	063069	FTX7L-BS■	
600	CBF S ABS (PC38/ PC43)	2008/2012	065010	YTZ10S▲	—	—	063010	FTZ10S▲	
600	CBF S ABS (PC38/ PC43)	2008/2012	065910	TTZ10S-BS	068910	ESTTZ10S-BS■	—	—	
600	CBR F (1/ 2/ 3/ 4/ 5/ 6)(PC35E/ PC35F)	2001/2006	065010	YTZ10S▲	—	—	063010	FTZ10S▲	
600	CBR F (1/ 2/ 3/ 4/ 5/ 6)(PC35E/ PC35F)	2001/2006	065910	TTZ10S-BS	068910	ESTTZ10S-BS■	—	—	
600	CBR F (H/ J/ K/ L) (PC19/ PC23)	1987/1990	0650990	YTX9-BS■	068099	ESTX9-BS■	063099	FTX9-BS■	
600	CBR F (M/ N/ P) (PC25)	1991/1994	0650990	YTX9-BS■	068099	ESTX9-BS■	063099	FTX9-BS■	
600	CBR F (PC41J)	2011/2013	065010	YTZ10S▲	—	—	063010	FTZ10S▲	
600	CBR F (T/ V/ W) (PC31/ PC31A)	1995/1998	0650990	YTX9-BS■	068099	ESTX9-BS■	063099	FTX9-BS■	
600	CBR F (X/ Y) (PC35A)	1999/2000	0650990	YTX9-BS■	068099	ESTX9-BS■	063099	FTX9-BS■	
600	CBR FA ABS (PC41K)	2011/2013	065010	YTZ10S▲	—	—	063010	FTZ10S▲	
600	CBR FS/ FR Sport (FS1/ 2/ FR2-PC35G)	2001/2002	065010	YTZ10S▲	—	—	063010	FTZ10S▲	
600	CBR FS/ FR Sport (FS1/ 2/ FR2-PC35G)	2001/2002	065910	TTZ10S-BS	068910	ESTTZ10S-BS■	—	—	
600	CBR RR (PC37A)	2003/2006	065010	YTZ10S▲	—	—	063010	FTZ10S▲	
600	CBR RR (PC37A)	2003/2006	065910	TTZ10S-BS	068910	ESTTZ10S-BS■	—	—	
600	CBR RR / ABS (PC40A/ PC40E/ PC40C/ PC40F)	2007/2015	065010	YTZ10S▲	—	—	063010	FTZ10S▲	
600	CBR RR / ABS (PC40A/ PC40E/ PC40C/ PC40F)	2007/2015	065910	TTZ10S-BS	068910	ESTTZ10S-BS■	—	—	
600	FJS Silver Wing (PF01)	2001/2010	065012	YTZ12S▲	—	—	063012	FTZ12S▲	
600	FJS Silver Wing (PF01)	2001/2010	065912	TTZ12S-BS	068912	ESTTZ12S-BS■	—	—	
600	FJS Silver Wing ABS (PF01)	2003/2010	065012	YTZ12S▲	—	—	063012	FTZ12S▲	
600	FJS Silver Wing ABS (PF01)	2003/2010	065912	TTZ12S-BS	068912	ESTTZ12S-BS■	—	—	
600	FJS Silver Wing SW-T	2011/2014	065012	YTZ12S▲	—	—	063012	FTZ12S▲	
600	FJS Silver Wing SW-T	2011/2014	065912	TTZ12S-BS	068912	ESTTZ12S-BS■	—	—	
600	NTV Revere	1988/1991	0650990	YTX9-BS■	068099	ESTX9-BS■	063099	FTX9-BS■	
600	NV C Steed	1993/1994	0650990	YTX9-BS■	068099	ESTX9-BS■	063099	FTX9-BS■	
600	VT C Shadow / CD Shadow (PC21)	1990/2003	0650990	YTX9-BS■	068099	ESTX9-BS■	063099	FTX9-BS■	
600	VT C Shadow / CD Shadow (PC21)	2004/2005	065010	YTZ10S▲	—	—	063010	FTZ10S▲	
600	VT C Shadow / CD Shadow (PC21)	2004/2005	065910	TTZ10S-BS	068910	ESTTZ10S-BS■	—	—	
600	XL R / Paris Dakar (PD03)	1983/1987	0650334	YB3L-A	0680334	ESB3L-A■	—	—	
600	XL RM/ LM (PD04)	1985/1987	065122	YTX14AH-BS■	068122	ESTX14AH-BS■	—	—	
600	XL RM/ LM (PD04)	1985/1987	0651437	YB14-A2	0681437	ESB14-A2■	—	—	
600	XL V Transalp (PD06/ PD10)	1988/1999	065122	YTX14AH-BS■	068122	ESTX14AH-BS■	—	—	



▲ - Factory Sealed / Attivata dalla Fabbrica ■ - con Acido a corredo ◇ - Non di produzione YUASA a completamento gamma

Marca / Cilindrata / Modello / Anno		Cod. SGR		Cod. SGR		Cod. SGR	
HONDA							
650	CB (Z) (RC03)	1979/1981	0651234	YB12A-A	0681234	ESB12A-A■	— —
650	CB C (A/ B) (RC05)	1980/1981	0651234	YB12A-A	0681234	ESB12A-A■	— —
650	CB F (RC47)	2014/2015	065010	YTZ10S▲	—	—	063010 FTZ10S▲
650	CB FA ABS (RC47)	2014/2015	065010	YTZ10S▲	—	—	063010 FTZ10S▲
650	CB SC Nighthawk (RC08/ RC130)	1982/1983	06512360	YB12AL-A	0681236	ESB12AL-A■	— —
650	CB SC Nighthawk (RC08/ RC130)	1982/1983	06512400	YB12AL-A2	0681240	ESB12AL-A2■	— —
650	CBR F (RC47)	2014/2016	065010	YTZ10S▲	—	—	063010 FTZ10S▲
650	CBR FA ABS (RC47)	2014/2016	065010	YTZ10S▲	—	—	063010 FTZ10S▲
650	CBX E (RC13)	1982/1984	06512400	YB12AL-A2	0681240	ESB12AL-A2■	— —
650	CX C (RC11)	1983/1983	0651122	YTX14AH-BS■	0681122	ESTX14AH-BS■	— —
650	CX C (RC11)	1983/1983	0651437	YB14-A2	0681437	ESB14-A2■	— —
650	CX E Euro (RC12)	1983/1986	0651123	YTX14AHL-BS■	—	—	— —
650	CX E Euro (RC12)	1983/1986	0651434	YB14L-A2	0681434	ESB14L-A2■	— —
650	CX Turbo (RC16)	1983/1983	0651123	YTX14AHL-BS■	—	—	— —
650	CX Turbo (RC16)	1983/1983	0651434	YB14L-A2	0681434	ESB14L-A2■	— —
650	FMX (RD12)	2005/2007	0650990	YTX9-BS■	068099	ESTX9-BS■	063099 FTX9-BS■
650	FX Vigor (RD09)	1999/2000	0650990	YTX9-BS■	068099	ESTX9-BS■	063099 FTX9-BS■
650	GL I Silver Wing Interstate (RC10)	1983/1983	0651123	YTX14AHL-BS■	—	—	— —
650	GL I Silver Wing Interstate (RC10)	1983/1983	0651439	YB14L-B2	0681439	ESB14L-B2■	— —
650	NT V Deauville (RC47)	1996/2002	0651110	YT12A-BS■	0681110	EST12A-BS■	— —
650	NT V Deauville (RC47)	2003/2003	065010	YTZ10S▲	—	—	063010 FTZ10S▲
650	NT V Deauville (RC47)	2003/2003	065910	TTZ10S-BS	068910	ESTTZ10S-BS■	— —
650	NT V Deauville (RC47)	2004/2005	065014	YTZ14S▲	—	—	— —
650	NT V Deauville (RC47)	2004/2005	065914	TTZ14S-BS	068914	ESTTZ14S-BS■	— —
650	NTV Revere (RC33)	1988/1997	0650990	YTX9-BS■	068099	ESTX9-BS■	063099 FTX9-BS■
650	NX Dominator (RD02/ RD08)	1988/2002	0650990	YTX9-BS■	068099	ESTX9-BS■	063099 FTX9-BS■
650	SLR (RD09)	1997/1998	0651110	YT12A-BS■	0681110	EST12A-BS■	— —
650	TRX Rincon FA3/ FA4/ FA5 (opt. cold start)	2003/2005	0650202	GYZ20HL▲	—	—	— —
650	TRX Rincon FA3/ FA4/ FA5 (opt. cold start)	2003/2005	065185	YTX20HL-BS■	—	—	— —
650	TRX Rincon FA3/ FA4/ FA5 (std.)	2003/2005	065124	YTX14H-BS■	—	—	— —
650	TRX Rincon FA3/ FA4/ FA5 (std.)	2003/2005	065129	YTX14-BS■	068129	ESTX14-BS■	— —
650	XL V Transalp (RD10/ RD11)	2000/2007	065012	YTZ12S▲	—	—	063012 FTZ12S▲
650	XL V Transalp (RD10/ RD11)	2000/2007	065912	TTZ12S-BS	068912	ESTTZ12S-BS■	— —
650	XRV Africa Twin (RC03)	1988/1989	0651122	YTX14AH-BS■	0681122	ESTX14AH-BS■	— —
650	XRV Africa Twin (RC03)	1988/1989	0651438	YB14-B2	0681438	ESB14-B2■	— —
680	TRX Rincon FA6/ FA7/ FA8/ FAA	2006/2016	0650202	GYZ20HL▲	—	—	— —
680	TRX Rincon FA6/ FA7/ FA8/ FAA	2006/2016	065185	YTX20HL-BS■	—	—	— —
700	CB SC Nighthawk S	1984/1986	0651435	YB14L-A1	—	—	— —
700	NC DC Integra	2012/2014	065012	YTZ12S▲	—	—	063012 FTZ12S▲
700	NC DC Integra	2012/2014	065912	TTZ12S-BS	068912	ESTTZ12S-BS■	— —
700	NC S	2012/2013	065012	YTZ12S▲	—	—	063012 FTZ12S▲



▲ - Factory Sealed / Attivata dalla Fabbrica ■ - con Acido a corredo ◇ - Non di produzione YUASA a completamento gamma

Marca / Cilindrata / Modello / Anno			Cod. SGR		Cod. SGR		Cod. SGR	
HONDA								
700	NC S	2012/2013	065912	TTZ12S-BS	068912	ESTTZ12S-BS■	—	—
700	NC SA ABS	2012/2013	065012	YTZ12S▲	—	—	063012	FTZ12S▲
700	NC SA ABS	2012/2013	065912	TTZ12S-BS	068912	ESTTZ12S-BS■	—	—
700	NC SD ABS DCT	2012/2013	065012	YTZ12S▲	—	—	063012	FTZ12S▲
700	NC SD ABS DCT	2012/2013	065912	TTZ12S-BS	068912	ESTTZ12S-BS■	—	—
700	NC XAC ABS	2012/2013	065012	YTZ12S▲	—	—	063012	FTZ12S▲
700	NC XAC ABS	2012/2013	065912	TTZ12S-BS	068912	ESTTZ12S-BS■	—	—
700	NC XC	2012/2013	065012	YTZ12S▲	—	—	063012	FTZ12S▲
700	NC XC	2012/2013	065912	TTZ12S-BS	068912	ESTTZ12S-BS■	—	—
700	NC XDC ABS DCT	2012/2013	065012	YTZ12S▲	—	—	063012	FTZ12S▲
700	NC XDC ABS DCT	2012/2013	065912	TTZ12S-BS	068912	ESTTZ12S-BS■	—	—
700	NSA DN-01	2008/2009	065014	YTZ14S▲	—	—	—	—
700	NSA DN-01	2008/2009	065914	TTZ14S-BS	068914	ESTTZ14S-BS■	—	—
700	NT V Deauville ABS	2006/2013	065014	YTZ14S▲	—	—	—	—
700	NT V Deauville ABS	2006/2013	065914	TTZ14S-BS	068914	ESTTZ14S-BS■	—	—
700	TRX Rincon XX	2008/2009	0650990	YTX9-BS■	068099	ESTX9-BS■	063099	FTX9-BS■
700	VF S Sabre	1984/1985	065123	YTX14AHL-BS■	—	—	—	—
700	VF S Sabre	1984/1985	0651439	YB14L-B2	0681439	ESB14L-B2■	—	—
700	XL V Transalp	2008/2013	065014	YTZ14S▲	—	—	—	—
700	XL V Transalp	2008/2013	065914	TTZ14S-BS	068914	ESTTZ14S-BS■	—	—
700	XL V Transalp ABS	2008/2013	065014	YTZ14S▲	—	—	—	—
700	XL V Transalp ABS	2008/2013	065914	TTZ14S-BS	068914	ESTTZ14S-BS■	—	—
750	CB A Hondamatic	1976/1978	065215	YTX24HL-BS■	—	—	—	—
750	CB Custom CA/ CB/ CC (RC01) USA	1980/1982	0651234	YB12A-A	0681234	ESB12A-A■	—	—
750	CB Custom CA/ CB/ CC (RC06)	1980/1983	065123	YTX14AHL-BS■	—	—	—	—
750	CB Custom CA/ CB/ CC (RC06)	1980/1983	0651439	YB14L-B2	0681439	ESB14L-B2■	—	—
750	CB F0 Super Sport	1975/1975	065123	YTX14AHL-BS■	—	—	—	—
750	CB F0 Super Sport	1975/1975	0651439	YB14L-B2	0681439	ESB14L-B2■	—	—
750	CB F1 Super Sport	1976/1976	065123	YTX14AHL-BS■	—	—	—	—
750	CB F1 Super Sport	1976/1976	0651439	YB14L-B2	0681439	ESB14L-B2■	—	—
750	CB F2 Seven Fifty (RC42)	1992/1995	065122	YTX14AH-BS■	068122	ESTX14AH-BS■	—	—
750	CB F2 Seven Fifty (RC42)	1992/1995	0651438	YB14-B2	0681438	ESB14-B2■	—	—
750	CB F2 Super Sport	1977/1977	065123	YTX14AHL-BS■	—	—	—	—
750	CB F2 Super Sport	1977/1977	0651439	YB14L-B2	0681439	ESB14L-B2■	—	—
750	CB F2C Super Sport (RC04)	1982/1982	065123	YTX14AHL-BS■	—	—	—	—
750	CB F2C Super Sport (RC04)	1982/1982	0651433	12N14-3A	—	—	—	—
750	CB F3 Super Sport	1978/1978	065123	YTX14AHL-BS■	—	—	—	—
750	CB F3 Super Sport	1978/1978	0651439	YB14L-B2	0681439	ESB14L-B2■	—	—
750	CB FA Super Sport (RC04)	1980/1980	065123	YTX14AHL-BS■	—	—	—	—
750	CB FA Super Sport (RC04)	1980/1980	0651433	12N14-3A	—	—	—	—
750	CB FB Super Sport (RC04)	1981/1981	065123	YTX14AHL-BS■	—	—	—	—



▲ - Factory Sealed / Attivata dalla Fabbrica ■ - con Acido a corredo ◇ - Non di produzione YUASA a completamento gamma

Marca / Cilindrata / Modello / Anno		Cod. SGR		Cod. SGR		Cod. SGR	
HONDA							
750	CB FB Super Sport (RC04)	1981/1981	0651433	12N14-3A	—	—	—
750	CB FC Super Sport (RC04)	1982/1982	065123	YTX14AHL-BS■	—	—	—
750	CB FC Super Sport (RC04)	1982/1982	0651433	12N14-3A	—	—	—
750	CB FZ Super Sport (RC04)	1979/1979	065123	YTX14AHL-BS■	—	—	—
750	CB FZ Super Sport (RC04)	1979/1979	0651433	12N14-3A	—	—	—
750	CB K Four (K0/ K8)	1969/1978	065123	YTX14AHL-BS■	—	—	—
750	CB K Four (K0/ K8)	1969/1978	0651433	12N14-3A	—	—	—
750	CB K Four Limited L (RC01)	1979/1979	0651234	YB12A-A	0681234	ESB12A-A■	—
750	CB Nighthawk (RC380/ RC381/ RC382)	1991/2003	065122	YTX14AH-BS■	068122	ESTX14AH-BS■	—
750	CB Nighthawk (RC380/ RC381/ RC382)	1991/2003	0651437	YB14-A2	0681437	ESB14-A2■	—
750	CB SC Nighthawk (RC012)	1982/1983	065123	YTX14AHL-BS■	—	—	—
750	CB SC Nighthawk (RC012)	1982/1983	0651439	YB14L-B2	0681439	ESB14L-B2■	—
750	CBX F (RC17)	1984/1986	065122	YTX14AH-BS■	068122	ESTX14AH-BS■	—
750	CBX F (RC17)	1984/1986	0651437	YB14-A2	0681437	ESB14-A2■	—
750	NC DC Integra	2014/2015	065012	YTZ12S▲	—	—	063012 FTZ12S▲
750	NC DC Integra	2014/2015	065912	TTZ12S-BS	068912	ESTTZ12S-BS■	—
750	NC S	2014/2015	065014	YTZ14S▲	—	—	—
750	NC S	2014/2015	065914	TTZ14S-BS	068914	ESTTZ14S-BS■	—
750	NC SA ABS	2014/2015	065014	YTZ14S▲	—	—	—
750	NC SA ABS	2014/2015	065914	TTZ14S-BS	068914	ESTTZ14S-BS■	—
750	NC SD DCT	2014/2015	065014	YTZ14S▲	—	—	—
750	NC SD DCT	2014/2015	065914	TTZ14S-BS	068914	ESTTZ14S-BS■	—
750	NC X	2014/2015	065014	YTZ14S▲	—	—	—
750	NC X	2014/2015	065914	TTZ14S-BS	068914	ESTTZ14S-BS■	—
750	NC XA ABS	2014/2015	065014	YTZ14S▲	—	—	—
750	NC XA ABS	2014/2015	065914	TTZ14S-BS	068914	ESTTZ14S-BS■	—
750	NC XD DCT	2014/2015	065014	YTZ14S▲	—	—	—
750	NC XD DCT	2014/2015	065914	TTZ14S-BS	068914	ESTTZ14S-BS■	—
750	NJ NM4 MVultus (RC82)	2015/2016	065012	YTZ12S▲	—	—	063012 FTZ12S▲
750	NJ NM4 MVultus (RC82)	2015/2016	065912	TTZ12S-BS	068912	ESTTZ12S-BS■	—
750	NR (RC40)	1993/>	0651090	YTX12-BS■	0681090	ESTX12-BS■	063109 FTX12-BS■
750	NV GC Shadow (PC21)	1999/2001	065124	YTX14H-BS■	—	—	—
750	NV GC Shadow (PC21)	1999/2001	065129	YTX14-BS■	068129	ESTX14-BS■	—
750	RVF RR (RC45)	1994/1999	0650990	YTX9-BS■	068099	ESTX9-BS■	063099 FTX9-BS■
750	VF C Shadow / Magna (RC09)	1982/1986	065122	YTX14AH-BS■	068122	ESTX14AH-BS■	—
750	VF C Shadow / Magna (RC09)	1982/1986	0651437	YB14-A2	0681437	ESB14-A2■	—
750	VF C Shadow / Magna CD C2/ (RC43)	1994/1998	0651090	YTX12-BS■	0681090	ESTX12-BS■	063109 FTX12-BS■
750	VF F Interceptor (RC15)	1983/1984	065122	YTX14AH-BS■	068122	ESTX14AH-BS■	—
750	VF F Interceptor (RC15)	1983/1984	0651437	YB14-A2	0681437	ESB14-A2■	—
750	VF S (RC07)	1982/1985	0651436	SYB14L-A2	—	—	—
750	VFR F (RC24/ RC24II/ RC36/ RC36II)	1987/1989	065122	YTX14AH-BS■	068122	ESTX14AH-BS■	—



▲ - Factory Sealed / Attivata dalla Fabbrica ; ■ - con Acido a corredo ; ◇ - Non di produzione YUASA a completamento gamma

Marca / Cilindrata / Modello / Anno			Cod. SGR		Cod. SGR		Cod. SGR		
HONDA									
750	VFR F (RC24/ RC24II/ RC36/ RC36II)	1987/1989	0651438	YB14-B2	0681438	ESB14-B2■	—	—	
750	VFR F (RC24/ RC24II/ RC36/ RC36II)	1990/1997	0651090	YTX12-BS■	0681090	ESTX12-BS■	063109	FTX12-BS■	
750	VFR R (RC30)	1987/1993	0650990	YTX9-BS■	068099	ESTX9-BS■	063099	FTX9-BS■	
750	VT C Shadow (RC14)	1983/1986	0651639	HYB16A-AB	—	—	—	—	
750	VT C Shadow (RC29)	1987/1989	065122	YTX14AH-BS■	068122	ESTX14AH-BS■	—	—	
750	VT C Shadow (RC29)	1987/1989	0651438	YB14-B2	0681438	ESB14-B2■	—	—	
750	VT C Shadow (RC44)	1997/2000	065014	YTZ14S▲	—	—	—	—	
750	VT C Shadow (RC44)	1997/2000	065914	TTZ14S-BS	068914	ESTTZ14S-BS■	—	—	
750	VT C Shadow (RC50)	2004/2007	065012	YTZ12S▲	—	—	063012	FTZ12S▲	
750	VT C Shadow (RC50)	2004/2007	065912	TTZ12S-BS	068912	ESTTZ12S-BS■	—	—	
750	VT C Shadow (RC50)	2008/2009	065014	YTZ14S▲	—	—	—	—	
750	VT C Shadow (RC50)	2008/2009	065914	TTZ14S-BS	068914	ESTTZ14S-BS■	—	—	
750	VT C2 Shadow (RC44)	1997/2001	065124	YTX14H-BS■	—	—	—	—	
750	VT C2 Shadow (RC44)	1997/2001	065129	YTX14-BS■	068129	ESTX14-BS■	—	—	
750	VT C2 Shadow Spirit (RC53A)	2007/2009	065014	YTZ14S▲	—	—	—	—	
750	VT C2 Shadow Spirit (RC53A)	2007/2009	065914	TTZ14S-BS	068914	ESTTZ14S-BS■	—	—	
750	VT C2B Black Spirit (RC53C)	2010/2014	065014	YTZ14S▲	—	—	—	—	
750	VT C2B Black Spirit (RC53C)	2010/2014	065914	TTZ14S-BS	068914	ESTTZ14S-BS■	—	—	
750	VT C2F Shadow Spirit (RC53U)	2009/2009	065014	YTZ14S▲	—	—	—	—	
750	VT C2F Shadow Spirit (RC53U)	2009/2009	065914	TTZ14S-BS	068914	ESTTZ14S-BS■	—	—	
750	VT C2S Shadow Spirit ABS (RC53B)	2010/2014	065014	YTZ14S▲	—	—	—	—	
750	VT C2S Shadow Spirit ABS (RC53B)	2010/2014	065914	TTZ14S-BS	068914	ESTTZ14S-BS■	—	—	
750	VT CA Shadow ABS (RC50)	2006/2007	065012	YTZ12S▲	—	—	063012	FTZ12S▲	
750	VT CA Shadow ABS (RC50)	2006/2007	065912	TTZ12S-BS	068912	ESTTZ12S-BS■	—	—	
750	VT CA Shadow ABS (RC50)	2008/2009	065014	YTZ14S▲	—	—	—	—	
750	VT CA Shadow ABS (RC50)	2008/2009	065914	TTZ14S-BS	068914	ESTTZ14S-BS■	—	—	
750	VT CSA Shadow ABS (RC50C)	2010/2013	065014	YTZ14S▲	—	—	—	—	
750	VT CSA Shadow ABS (RC50C)	2010/2013	065914	TTZ14S-BS	068914	ESTTZ14S-BS■	—	—	
750	VT DC1/ DC2 Black Widow (RC48)	2001/2002	065014	YTZ14S▲	—	—	—	—	
750	VT DC1/ DC2 Black Widow (RC48)	2001/2002	065914	TTZ14S-BS	068914	ESTTZ14S-BS■	—	—	
750	VT S (RC58A)	2010/2013	065014	YTZ14S▲	—	—	—	—	
750	VT S (RC58A)	2010/2013	065914	TTZ14S-BS	068914	ESTTZ14S-BS■	—	—	
750	XLV RD (RD01)	1983/1984	065122	YTX14AH-BS■	068122	ESTX14AH-BS■	—	—	
750	XLV RD (RD01)	1983/1984	0651437	YB14-A2	0681437	ESB14-A2■	—	—	
750	XLV RF (RD01)	1985/1986	065122	YTX14AH-BS■	068122	ESTX14AH-BS■	—	—	
750	XLV RF (RD01)	1985/1986	0651437	YB14-A2	0681437	ESB14-A2■	—	—	
750	XRV Africa Twin (RD04/ RD07)	1990/1992	065122	YTX14AH-BS■	068122	ESTX14AH-BS■	—	—	
750	XRV Africa Twin (RD04/ RD07)	1990/1992	0651438	YB14-B2	0681438	ESB14-B2■	—	—	
750	XRV Africa Twin (RD04/ RD07)	1993/2002	065124	YTX14H-BS■	—	—	—	—	
750	XRV Africa Twin (RD04/ RD07)	1993/2002	065129	YTX14-BS■	068129	ESTX14-BS■	—	—	
800	PC Pacific Coast (RC34)	1989/1998	0651090	YTX12-BS■	0681090	ESTX12-BS■	063109	FTX12-BS■	



▲ - Factory Sealed / Attivata dalla Fabbrica ■ - con Acido a corredo ◇ - Non di produzione YUASA a completamento gamma

Marca / Cilindrata / Modello / Anno			Cod. SGR		Cod. SGR		Cod. SGR		
HONDA									
800	VFR F (RC79)	2014/2015	065012	YTZ12S▲	—	—	063012	FTZ12S▲	
800	VFR F (RC79)	2014/2015	065912	TTZ12S-BS	068912	ESTTZ12S-BS■	—	—	
800	VFR Fi (RC46)	1998/2000	0651090	YTX12-BS■	0681090	ESTX12-BS■	063109	FTX12-BS■	
800	VFR Fi (RC46)	2001/2001	065012	YTZ12S▲	—	—	063012	FTZ12S▲	
800	VFR Fi (RC46)	2001/2001	065912	TTZ12S-BS	068912	ESTTZ12S-BS■	—	—	
800	VFR VTec (RC46II)	2002/2010	065012	YTZ12S▲	—	—	063012	FTZ12S▲	
800	VFR VTec (RC46II)	2002/2010	065912	TTZ12S-BS	068912	ESTTZ12S-BS■	—	—	
800	VFR X Cross Runner	2011/2015	065012	YTZ12S▲	—	—	063012	FTZ12S▲	
800	VFR X Cross Runner	2011/2015	065912	TTZ12S-BS	068912	ESTTZ12S-BS■	—	—	
900	CB C Custom (SC04)	1980/1982	065123	YTX14AHL-BS■	—	—	—	—	
900	CB C Custom (SC04)	1980/1982	0651434	YB14L-A2	0681434	ESB14L-A2■	—	—	
900	CB F Bol d'or (FC/ F2C/ FD/ F2D) (SC09)	1982/1983	065123	YTX14AHL-BS■	—	—	—	—	
900	CB F Bol d'or (FC/ F2C/ FD/ F2D) (SC09)	1982/1983	0651434	YB14L-A2	0681434	ESB14L-A2■	—	—	
900	CB F Bol d'or (FZ/ FA/ FB/ F2B) (SC01)	1979/1981	065123	YTX14AHL-BS■	—	—	—	—	
900	CB F Bol d'or (FZ/ FA/ FB/ F2B) (SC01)	1979/1981	0651434	YB14L-A2	0681434	ESB14L-A2■	—	—	
919	CB F Hornet (SC48)	2002/2007	065010	YTZ10S▲	—	—	063010	FTZ10S▲	
919	CB F Hornet (SC48)	2002/2007	065910	TTZ10S-BS	068910	ESTTZ10S-BS■	—	—	
919	CBR RR Fireblade (SC28/ SC29/ SC33)	1992/1999	0650990	YTX9-BS■	068099	ESTX9-BS■	063099	FTX9-BS■	
929	CBR RR Fireblade (SC44)	2000/2001	065010	YTZ10S▲	—	—	063010	FTZ10S▲	
929	CBR RR Fireblade (SC44)	2000/2001	065910	TTZ10S-BS	068910	ESTTZ10S-BS■	—	—	
954	CBR RR Fireblade (SC50)	2002/2003	065010	YTZ10S▲	—	—	063010	FTZ10S▲	
954	CBR RR Fireblade (SC50)	2002/2003	065910	TTZ10S-BS	068910	ESTTZ10S-BS■	—	—	
1000	CB C Custom	1983/1983	065123	YTX14AHL-BS■	—	—	—	—	
1000	CB C Custom	1983/1983	0651439	YB14L-B2	0681439	ESB14L-B2■	—	—	
1000	CB F Big One Superfour P,R,S,T (SC30)	1993/1996	0651090	YTX12-BS■	0681090	ESTX12-BS■	063109	FTX12-BS■	
1000	CB R	2008/2016	065010	YTZ10S▲	—	—	063010	FTZ10S▲	
1000	CB R ABS	2008/2016	065010	YTZ10S▲	—	—	063010	FTZ10S▲	
1000	CBF	2006/2013	065010	YTZ10S▲	—	—	063010	FTZ10S▲	
1000	CBF	2006/2013	065910	TTZ10S-BS	068910	ESTTZ10S-BS■	—	—	
1000	CBF Abs	2006/2013	065010	YTZ10S▲	—	—	063010	FTZ10S▲	
1000	CBF Abs	2006/2013	065910	TTZ10S-BS	068910	ESTTZ10S-BS■	—	—	
1000	CBR F Hurricane (SC21/ SC24)	1987/1996	065123	YTX14AHL-BS■	—	—	—	—	
1000	CBR F Hurricane (SC21/ SC24)	1987/1996	0651439	YB14L-B2	0681439	ESB14L-B2■	—	—	
1000	CBR RR Fireblade	2017/2017	065007	YTZ7S▲	—	—	063007	FTZ7S▲	
1000	CBR RR Fireblade	2017/2017	065907	TTZ7S▲	068907	ESTTZ7S-BS■	—	—	
1000	CBR RR Fireblade (SC57)	2004/2007	065010	YTZ10S▲	—	—	063010	FTZ10S▲	
1000	CBR RR Fireblade (SC57)	2004/2007	065910	TTZ10S-BS	068910	ESTTZ10S-BS■	—	—	
1000	CBR RR Fireblade (SC59A)	2008/2016	065007	YTZ7S▲	—	—	063007	FTZ7S▲	
1000	CBR RR Fireblade (SC59A)	2008/2016	065907	TTZ7S▲	068907	ESTTZ7S-BS■	—	—	
1000	CBR RR Fireblade ABS (SC59C)	2010/2016	065010	YTZ10S▲	—	—	063010	FTZ10S▲	
1000	CBR RR Fireblade SP (SC59E)	2014/2016	065007	YTZ7S▲	—	—	063007	FTZ7S▲	

▲ - Factory Sealed / Attivata dalla Fabbrica ■ - con Acido a corredo ◇ - Non di produzione YUASA a completamento gamma

Marca / Cilindrata / Modello / Anno			Cod. SGR		Cod. SGR		Cod. SGR		
HONDA									
1000	CBR RR Fireblade SP (SC59E)	2014/2016	065907	TTZ7S▲	068907	ESTZ7S-BS■	—	—	
1000	CBR RR Fireblade SP ABS (SC59G)	2014/2016	065010	YTZ10S▲	—	—	063010	FTZ10S▲	
1000	CBX (6 cil.) (CB1)	1978/1979	0650202	GYZ20HL▲	—	—	—	—	
1000	CBX (6 cil.) (CB1)	1978/1979	0651833	12N18-3	—	—	—	—	
1000	CBX (6 cil.) (CB1)	1978/1979	065185	YTX20HL-BS■	—	—	—	—	
1000	CBX (6 cil.) (CB1)	1978/1979	065209	YTX20L-BS■	068209	ESTX20L-BS■	—	—	
1000	CBX (6 cil.) (SC03)	1980/1980	0650202	GYZ20HL▲	—	—	—	—	
1000	CBX (6 cil.) (SC03)	1980/1980	0651833	12N18-3	—	—	—	—	
1000	CBX (6 cil.) (SC03)	1980/1980	065185	YTX20HL-BS■	—	—	—	—	
1000	CBX (6 cil.) (SC03)	1980/1980	065209	YTX20L-BS■	068209	ESTX20L-BS■	—	—	
1000	CBX Super Sport (6 cil.) (SC06)	1981/1982	0650202	GYZ20HL▲	—	—	—	—	
1000	CBX Super Sport (6 cil.) (SC06)	1981/1982	0651833	12N18-3	—	—	—	—	
1000	CBX Super Sport (6 cil.) (SC06)	1981/1982	065185	YTX20HL-BS■	—	—	—	—	
1000	CBX Super Sport (6 cil.) (SC06)	1981/1982	065209	YTX20L-BS■	068209	ESTX20L-BS■	—	—	
1000	CRF L Africa Twin	2016/2016	065014	YTZ14S▲	—	—	—	—	
1000	GL Gold Wing Ltd,K1,K2,K3,Z (GL1/ GL2)	1975/1979	065215	YTX24HL-BS■	—	—	—	—	
1000	RC213V-S	2016/2016	065049	YTX5L-BS■	068049	ESTX5L-BS■	063049	FTX5L-BS■	
1000	VF F Interceptor (SC15)	1984/1985	0651637	YB16B-A	0681637	ESB16B-A■	—	—	
1000	VF R Interceptor (SC16)	1984/1986	0651637	YB16B-A	0681637	ESB16B-A■	—	—	
1000	VTR F Fire Storm (SC36)	1997/2000	0651090	YTX12-BS■	0681090	ESTX12-BS■	063109	FTX12-BS■	
1000	VTR F Fire Storm (SC36)	2001/2007	065012	YTZ12S▲	—	—	063012	FTZ12S▲	
1000	VTR F Fire Storm (SC36)	2001/2007	065912	TTZ12S-BS	068912	ESTTZ12S-BS■	—	—	
1000	VTR SP1 - VTR SP2 - RC51 (SC45)	2000/2006	065012	YTZ12S▲	—	—	063012	FTZ12S▲	
1000	VTR SP1 - VTR SP2 - RC51 (SC45)	2000/2006	065912	TTZ12S-BS	068912	ESTTZ12S-BS■	—	—	
1000	XLV Varadero (SD01/ SD02)	1999/2002	065124	YTX14H-BS■	—	—	—	—	
1000	XLV Varadero (SD01/ SD02)	1999/2002	065129	YTX14-BS■	068129	ESTX14-BS■	—	—	
1000	XLV Varadero (SD01/ SD02)	2003/2011	065187	YTX20CH-BS■	068187	ESTX20CH-BS■	—	—	
1000	XLV Varadero Abs (SD02)	2004/2010	065187	YTX20CH-BS■	068187	ESTX20CH-BS■	—	—	
1100	CB A AC/ AD ABS	2013/2013	065014	YTZ14S▲	—	—	—	—	
1100	CB AC/ AD	2013/2013	065014	YTZ14S▲	—	—	—	—	
1100	CB AE ABS	2014/2015	065014	YTZ14S▲	—	—	—	—	
1100	CB F Bol D'or (SC11)	1983/1983	065123	YTX14AHL-BS■	—	—	—	—	
1100	CB F Bol D'or (SC11)	1983/1983	0651434	YB14L-A2	0681434	ESB14L-A2■	—	—	
1100	CB R (SC05)	1981/1981	06512360	YB12AL-A	0681236	ESB12AL-A■	—	—	
1100	CB R (SC05)	1981/1981	06512400	YB12AL-A2	0681240	ESB12AL-A2■	—	—	
1100	CB R (SC08)	1982/1983	06512360	YB12AL-A	0681236	ESB12AL-A■	—	—	
1100	CB R (SC08)	1982/1983	06512400	YB12AL-A2	0681240	ESB12AL-A2■	—	—	
1100	CB SF XEleven X11 (SC42)	1999/2001	0651090	YTX12-BS■	0681090	ESTX12-BS■	063109	FTX12-BS■	
1100	CBR XX Superblackbird (SC35)	1996/2000	0651090	YTX12-BS■	0681090	ESTX12-BS■	063109	FTX12-BS■	
1100	CBR XX Superblackbird (SC35)	2001/2006	065012	YTZ12S▲	—	—	063012	FTZ12S▲	
1100	CBR XX Superblackbird (SC35)	2001/2006	065912	TTZ12S-BS	068912	ESTTZ12S-BS■	—	—	

▲ - Factory Sealed / Attivata dalla Fabbrica ■ - con Acido a corredo ◇ - Non di produzione YUASA a completamento gamma

Marca / Cilindrata / Modello / Anno			Cod. SGR		Cod. SGR		Cod. SGR		
HONDA									
1100	GL GoldWing (SC02)	1980/1983	0652034	Y50-N18L-A	0682034	ES50-N18L-A■	—	—	
1100	GL GoldWing (SC02)	1980/1983	065215	YTX24HL-BS■	—	—	—	—	
1100	ST Pan European (SC26)	1990/2001	065124	YTX14H-BS■	—	—	—	—	
1100	ST Pan European (SC26)	1990/2001	065129	YTX14-BS■	068129	ESTX14-BS■	—	—	
1100	ST Pan European ABS (SC26)	1992/2002	065124	YTX14H-BS■	—	—	—	—	
1100	ST Pan European ABS (SC26)	1992/2002	065129	YTX14-BS■	068129	ESTX14-BS■	—	—	
1100	VF C V65 Magna (SC12)	1983/1986	0650201	GYZ20H▲	—	—	—	—	
1100	VF C V65 Magna (SC12)	1983/1986	0651835	YB18-A	—	—	—	—	
1100	VF C V65 Magna (SC12)	1983/1986	065184	YTX20H-BS■	—	—	—	—	
1100	VF S V65 Sabre (SC17)	1984/1985	0650202	GYZ20HL▲	—	—	—	—	
1100	VF S V65 Sabre (SC17)	1984/1985	065185	YTX20HL-BS■	—	—	—	—	
1100	VT C Shadow (SC18/ SC23)	1985/1994	0651639	HYB16A-AB	—	—	—	—	
1100	VT C2 Shadow (SC32/ SC43)	1995/1999	0651639	HYB16A-AB	—	—	—	—	
1100	VT C2 Shadow (SC32/ SC43)	2000/2007	065124	YTX14H-BS■	—	—	—	—	
1100	VT C2 Shadow (SC32/ SC43)	2000/2007	065129	YTX14-BS■	068129	ESTX14-BS■	—	—	
1100	VT C3 Shadow Aero (SC39)	1998/2002	065124	YTX14H-BS■	—	—	—	—	
1100	VT C3 Shadow Aero (SC39)	1998/2002	065129	YTX14-BS■	068129	ESTX14-BS■	—	—	
1100	VT C3 Shadow Aero (SC39)	1998/2002	0651639	HYB16A-AB	—	—	—	—	
1100	VT D2 Shadow (SC32)	1999/1999	0651639	HYB16A-AB	—	—	—	—	
1100	VT T Shadow Tourer (SC37)	1998/2000	0651639	HYB16A-AB	—	—	—	—	
1200	GL Gold Wing (SC14)	1984/1987	0652034	Y50-N18L-A	0682034	ES50-N18L-A■	—	—	
1200	GL Gold Wing (SC14)	1984/1987	065215	YTX24HL-BS■	—	—	—	—	
1200	VFR F AC	2010/2015	065014	YTZ14S▲	—	—	—	—	
1200	VFR F D AC DCT	2010/2015	065014	YTZ14S▲	—	—	—	—	
1200	VFR XC Crosstourer	2012/2015	065014	YTZ14S▲	—	—	—	—	
1200	VFR XDC Crosstourer DCT	2012/2015	065014	YTZ14S▲	—	—	—	—	
1235	AquaTrax F12X,F12	2002/2005	0650202	GYZ20HL▲	—	—	—	—	
1235	AquaTrax F12X,F12	2002/2005	065185	YTX20HL-BS■	—	—	—	—	
1235	AquaTrax R12X, R12	2003/2005	0650202	GYZ20HL▲	—	—	—	—	
1235	AquaTrax R12X, R12	2003/2005	065185	YTX20HL-BS■	—	—	—	—	
1300	CB A Super Four ABS (SC54)	2005/2009	065014	YTZ14S▲	—	—	—	—	
1300	CB F Super Four (SC40)	1998/2001	065124	YTX14H-BS■	—	—	—	—	
1300	CB F Super Four (SC40)	1998/2001	065129	YTX14-BS■	068129	ESTX14-BS■	—	—	
1300	CB F Super Four (SC54)	2003/2004	065014	YTZ14S▲	—	—	—	—	
1300	CB SA Fairing ABS (SC54)	2005/2013	065014	YTZ14S▲	—	—	—	—	
1300	CB Super Four (SC54)	2005/2009	065014	YTZ14S▲	—	—	—	—	
1300	CTX	2014/2014	065014	YTZ14S▲	—	—	—	—	
1300	ST Pan European / ABS (SC51)	2002/2013	065014	YTZ14S▲	—	—	—	—	
1300	ST Pan European / ABS (SC51)	2002/2013	065914	TTZ14S-BS	068914	ESTTZ14S-BS■	—	—	
1300	VTCX Fury	2010/2013	065014	YTZ14S▲	—	—	—	—	
1300	VTCX Fury	2010/2013	065914	TTZ14S-BS	068914	ESTTZ14S-BS■	—	—	



▲ - Factory Sealed / Attivata dalla Fabbrica ■ - con Acido a corredo ◇ - Non di produzione YUASA a completamento gamma

Marca / Cilindrata / Modello / Anno			Cod. SGR		Cod. SGR		Cod. SGR		
HONDA									
1300	VTX C (SC52)	2004/2007	065124	YTX14H-BS■	—	—	—	—	
1300	VTX C (SC52)	2004/2007	065129	YTX14-BS■	068129	ESTX14-BS■	—	—	
1300	VTX S (SC52)	2003/2007	065124	YTX14H-BS■	—	—	—	—	
1300	VTX S (SC52)	2003/2007	065129	YTX14-BS■	068129	ESTX14-BS■	—	—	
1500	GL Gold Wing (SC22)	1988/2000	0652034	Y50-N18L-A	0682034	ES50-N18L-A■	—	—	
1500	GL Gold Wing (SC22)	1988/2000	065215	YTX24HL-BS■	—	—	—	—	
1500	GL Valkirye F6C (SC34)	1997/2001	065124	YTX14H-BS■	—	—	—	—	
1500	GL Valkirye F6C (SC34)	1997/2001	065129	YTX14-BS■	068129	ESTX14-BS■	—	—	
1800	GL Gold Wing (SC47)	2001/2013	065185	YTX20HL-BS■	—	—	—	—	
1800	GL Gold Wing (SC47)	2001/2013	065209	YTX20L-BS■	068209	ESTX20L-BS■	—	—	
1800	GL Gold Wing (SC47)	2001/2014	0650202	GYZ20HL▲	—	—	—	—	
1800	GL Gold Wing F6B	2013/2013	0650202	GYZ20HL▲	—	—	—	—	
1800	GL Gold Wing F6B	2013/2013	065185	YTX20HL-BS■	—	—	—	—	
1800	GL Gold Wing F6B	2013/2013	065209	YTX20L-BS■	068209	ESTX20L-BS■	—	—	
1800	VTX (SC46)	2001/2008	0650202	GYZ20HL▲	—	—	—	—	
1800	VTX (SC46)	2001/2008	065185	YTX20HL-BS■	—	—	—	—	
1800	VTX (SC46)	2001/2008	065209	YTX20L-BS■	068209	ESTX20L-BS■	—	—	
HUSABERG									
125	TE 2T	2011/2013	0650390	YTX4L-BS■	068039	ESTX4L-BS■	—	—	
250	FE 4T	2013/2014	0650390	YTX4L-BS■	068039	ESTX4L-BS■	—	—	
250	TE 2T	2011/2013	0650390	YTX4L-BS■	068039	ESTX4L-BS■	—	—	
300	TE 2T	2011/2013	0650390	YTX4L-BS■	068039	ESTX4L-BS■	—	—	
350	FE 4T	2013/2014	0650390	YTX4L-BS■	068039	ESTX4L-BS■	—	—	
390	FE 70° Engine	2009/2012	065007	YTZ7S▲	—	—	063007	FTZ7S▲	
390	FE 70° Engine	2009/2012	065907	TTZ7S▲	068907	ESTTZ7S-BS■	—	—	
400	FE E	1996/1999	0650990	YTX9-BS■	068099	ESTX9-BS■	063099	FTX9-BS■	
400	FE E	2000/2003	065049	YTX5L-BS■	068049	ESTX5L-BS■	063049	FTX5L-BS■	
400	FSE	2001/2003	065049	YTX5L-BS■	068049	ESTX5L-BS■	063049	FTX5L-BS■	
450	FE	2012/2013	065049	YTX5L-BS■	068049	ESTX5L-BS■	063049	FTX5L-BS■	
450	FE 70° Engine	2009/2011	065007	YTZ7S▲	—	—	063007	FTZ7S▲	
450	FE 70° Engine	2009/2011	065907	TTZ7S▲	068907	ESTTZ7S-BS■	—	—	
450	FE E	2001/2007	065049	YTX5L-BS■	068049	ESTX5L-BS■	063049	FTX5L-BS■	
450	FE E	2008/2008	065007	YTZ7S▲	—	—	063007	FTZ7S▲	
450	FE E	2008/2008	065907	TTZ7S▲	068907	ESTTZ7S-BS■	—	—	
450	FSE	2004/2007	065049	YTX5L-BS■	068049	ESTX5L-BS■	063049	FTX5L-BS■	
450	FX 70° Engine	2010/2011	065007	YTZ7S▲	—	—	063007	FTZ7S▲	
450	FX 70° Engine	2010/2011	065907	TTZ7S▲	068907	ESTTZ7S-BS■	—	—	
501	FE	2013/2014	065049	YTX5L-BS■	068049	ESTX5L-BS■	063049	FTX5L-BS■	
501	FE E	1996/1999	0650990	YTX9-BS■	068099	ESTX9-BS■	063099	FTX9-BS■	
501	FE E	2000/2004	065049	YTX5L-BS■	068049	ESTX5L-BS■	063049	FTX5L-BS■	
550	FE E	2004/2008	065007	YTZ7S▲	—	—	063007	FTZ7S▲	

▲ - Factory Sealed / Attivata dalla Fabbrica ■ - con Acido a corredo ◇ - Non di produzione YUASA a completamento gamma

Marca / Cilindrata / Modello / Anno			Cod. SGR		Cod. SGR		Cod. SGR	
HUSABERG								
550 FE E	2004/2008	065907	TTZ7S▲	068907	ESTTZ7S-BS■	—	—	—
550 FS E	2004/2008	065007	YTZ7S▲	—	—	063007	FTZ7S▲	—
550 FS E	2004/2008	065907	TTZ7S▲	068907	ESTTZ7S-BS■	—	—	—
570 FE 70° Engine	2009/2012	065007	YTZ7S▲	—	—	063007	FTZ7S▲	—
570 FE 70° Engine	2009/2012	065907	TTZ7S▲	068907	ESTTZ7S-BS■	—	—	—
650 FE E	2004/2008	065007	YTZ7S▲	—	—	063007	FTZ7S▲	—
650 FE E	2004/2008	065907	TTZ7S▲	068907	ESTTZ7S-BS■	—	—	—
650 FS C	2005/2008	065007	YTZ7S▲	—	—	063007	FTZ7S▲	—
650 FS C	2005/2008	065907	TTZ7S▲	068907	ESTTZ7S-BS■	—	—	—
650 FS E	2001/2003	065049	YTX5L-BS■	068049	ESTX5L-BS■	063049	FTX5L-BS■	—
650 FS E	2004/2007	065007	YTZ7S▲	—	—	063007	FTZ7S▲	—
650 FS E	2004/2007	065907	TTZ7S▲	068907	ESTTZ7S-BS■	—	—	—
HUSQVARNA								
125 SM	1998/1999	0650390	YTX4L-BS■	068039	ESTX4L-BS■	—	—	—
125 SM S	2000/2012	0650390	YTX4L-BS■	068039	ESTX4L-BS■	—	—	—
125 SMR4	2010/2013	0650390	YTX4L-BS■	068039	ESTX4L-BS■	—	—	—
125 SMS4	2010/2013	0650390	YTX4L-BS■	068039	ESTX4L-BS■	—	—	—
125 TE 4T	2010/2013	0650390	YTX4L-BS■	068039	ESTX4L-BS■	—	—	—
125 WRE	1998/2012	0650390	YTX4L-BS■	068039	ESTX4L-BS■	—	—	—
250 FC 4T	2014/2015	0650390	YTX4L-BS■	068039	ESTX4L-BS■	—	—	—
250 FE 4T	2014/2016	0650390	YTX4L-BS■	068039	ESTX4L-BS■	—	—	—
250 SM R	2005/2007	065007	YTZ7S▲	—	—	063007	FTZ7S▲	—
250 SM R	2005/2007	065907	TTZ7S▲	068907	ESTTZ7S-BS■	—	—	—
250 TE	2002/2013	065007	YTZ7S▲	—	—	063007	FTZ7S▲	—
250 TE	2002/2013	065907	TTZ7S▲	068907	ESTTZ7S-BS■	—	—	—
250 TE 2T	2014/2016	0650390	YTX4L-BS■	068039	ESTX4L-BS■	—	—	—
250 TXC Cross Country	2008/2013	065007	YTZ7S▲	—	—	063007	FTZ7S▲	—
250 TXC Cross Country	2008/2013	065907	TTZ7S▲	068907	ESTTZ7S-BS■	—	—	—
300 TE 2T	2014/2016	0650390	YTX4L-BS■	068039	ESTX4L-BS■	—	—	—
310 TE	2009/2013	065007	YTZ7S▲	—	—	063007	FTZ7S▲	—
310 TE	2009/2013	065907	TTZ7S▲	068907	ESTTZ7S-BS■	—	—	—
310 TXC Cross Country	2012/2013	065007	YTZ7S▲	—	—	063007	FTZ7S▲	—
310 TXC Cross Country	2012/2013	065907	TTZ7S▲	068907	ESTTZ7S-BS■	—	—	—
350 FC 4T	2014/2015	0650390	YTX4L-BS■	068039	ESTX4L-BS■	—	—	—
350 FE 4T	2014/2016	0650390	YTX4L-BS■	068039	ESTX4L-BS■	—	—	—
400 SM R	2002/2002	065007	YTZ7S▲	—	—	063007	FTZ7S▲	—
400 SM R	2002/2002	065907	TTZ7S▲	068907	ESTTZ7S-BS■	—	—	—
410 TE E (H710ACX)	1999/1999	065124	YTX14H-BS■	—	—	—	—	—
410 TE E (H710ACX)	1999/1999	065129	YTX14-BS■	068129	ESTX14-BS■	—	—	—
410 TE E (H710ACY)	2000/2001	065124	YTX14H-BS■	—	—	—	—	—
410 TE E (H710ACY)	2000/2001	065129	YTX14-BS■	068129	ESTX14-BS■	—	—	—

▲ - Factory Sealed / Attivata dalla Fabbrica ■ - con Acido a corredo ◇ - Non di produzione YUASA a completamento gamma

Marca / Cilindrata / Modello / Anno		Cod. SGR		Cod. SGR		Cod. SGR		
HUSQVARNA								
449	SM R	2011/2013	065007	YTZ7S▲	—	—	063007	FTZ7S▲
449	SM R	2011/2013	065907	TTZ7S▲	068907	ESTTZ7S-BS■	—	—
449	TC	2011/2013	0650390	YTX4L-BS■	068039	ESTX4L-BS■	—	—
449	TE	2011/2013	065007	YTZ7S▲	—	—	063007	FTZ7S▲
449	TE	2011/2013	065907	TTZ7S▲	068907	ESTTZ7S-BS■	—	—
449	TXC Cross Country	2011/2012	065007	YTZ7S▲	—	—	063007	FTZ7S▲
449	TXC Cross Country	2011/2012	065907	TTZ7S▲	068907	ESTTZ7S-BS■	—	—
450	FC 4T	2014/2015	0650390	YTX4L-BS■	068039	ESTX4L-BS■	—	—
450	FE 4T	2014/2016	065049	YTX5L-BS■	068049	ESTX5L-BS■	063049	FTX5L-BS■
450	FS 4T	2015/2015	0650390	YTX4L-BS■	068039	ESTX4L-BS■	—	—
450	SM R	2003/2010	065007	YTZ7S▲	—	—	063007	FTZ7S▲
450	SM R	2003/2010	065907	TTZ7S▲	068907	ESTTZ7S-BS■	—	—
450	SM RR (H222AB7V0/ HA222AB8V0/ HA222AB9V)	2006/2010	065007	YTZ7S▲	—	—	063007	FTZ7S▲
450	SM RR (H222AB7V0/ HA222AB8V0/ HA222AB9V)	2006/2010	065907	TTZ7S▲	068907	ESTTZ7S-BS■	—	—
450	TE	2002/2010	065007	YTZ7S▲	—	—	063007	FTZ7S▲
450	TE	2002/2010	065907	TTZ7S▲	068907	ESTTZ7S-BS■	—	—
450	TXC Cross Country	2008/2010	065007	YTZ7S▲	—	—	063007	FTZ7S▲
450	TXC Cross Country	2008/2010	065907	TTZ7S▲	068907	ESTTZ7S-BS■	—	—
501	FE 4T	2014/2016	065049	YTX5L-BS■	068049	ESTX5L-BS■	063049	FTX5L-BS■
510	SM R	2005/2010	065007	YTZ7S▲	—	—	063007	FTZ7S▲
510	SM R	2005/2010	065907	TTZ7S▲	068907	ESTTZ7S-BS■	—	—
510	TC	2009/2010	065007	YTZ7S▲	—	—	063007	FTZ7S▲
510	TC	2009/2010	065907	TTZ7S▲	068907	ESTTZ7S-BS■	—	—
510	TE	2004/2010	065007	YTZ7S▲	—	—	063007	FTZ7S▲
510	TE	2004/2010	065907	TTZ7S▲	068907	ESTTZ7S-BS■	—	—
510	TE R	2004/2004	065007	YTZ7S▲	—	—	063007	FTZ7S▲
510	TE R	2004/2004	065907	TTZ7S▲	068907	ESTTZ7S-BS■	—	—
510	TXC Cross Country	2008/2008	065007	YTZ7S▲	—	—	063007	FTZ7S▲
510	TXC Cross Country	2008/2008	065907	TTZ7S▲	068907	ESTTZ7S-BS■	—	—
511	SM R	2011/2013	065007	YTZ7S▲	—	—	063007	FTZ7S▲
511	SM R	2011/2013	065907	TTZ7S▲	068907	ESTTZ7S-BS■	—	—
511	TE	2011/2013	065007	YTZ7S▲	—	—	063007	FTZ7S▲
511	TE	2011/2013	065907	TTZ7S▲	068907	ESTTZ7S-BS■	—	—
511	TXC Cross Country	2011/2013	065007	YTZ7S▲	—	—	063007	FTZ7S▲
511	TXC Cross Country	2011/2013	065907	TTZ7S▲	068907	ESTTZ7S-BS■	—	—
530	SM RR (HA224AB9V0)	2009/2010	065007	YTZ7S▲	—	—	063007	FTZ7S▲
530	SM RR (HA224AB9V0)	2009/2010	065907	TTZ7S▲	068907	ESTTZ7S-BS■	—	—
610	SM (H701AAWV0)	1998/1999	065124	YTX14H-BS■	—	—	—	—
610	SM (H701AAWV0)	1998/1999	065129	YTX14-BS■	068129	ESTX14-BS■	—	—
610	SM S / SM S IE	2000/2010	065124	YTX14H-BS■	—	—	—	—
610	SM S / SM S IE	2000/2010	065129	YTX14-BS■	068129	ESTX14-BS■	—	—

▲ - Factory Sealed / Attivata dalla Fabbrica ■ - con Acido a corredo ◇ - Non di produzione YUASA a completamento gamma





HUSQVARNA

610 TE E	1998/2010	065124	YTX14H-BS ■	—	—	—	—
610 TE E	1998/2010	065129	YTX14-BS ■	068129	ESTX14-BS ■	—	—
610 TELT	1998/2000	065124	YTX14H-BS ■	—	—	—	—
610 TELT	1998/2000	065129	YTX14-BS ■	068129	ESTX14-BS ■	—	—
630 SMS	2010/2013	065124	YTX14H-BS ■	—	—	—	—
630 SMS	2010/2013	065129	YTX14-BS ■	068129	ESTX14-BS ■	—	—
630 TE	2010/2013	065124	YTX14H-BS ■	—	—	—	—
630 TE	2010/2013	065129	YTX14-BS ■	068129	ESTX14-BS ■	—	—
650 TR Strada	2013/2014	0651090	YTX12-BS ■	0681090	ESTX12-BS ■	063109	FTX12-BS ■
900 Nuda	2012/2013	065124	YTX14H-BS ■	—	—	—	—
900 Nuda	2012/2013	065129	YTX14-BS ■	068129	ESTX14-BS ■	—	—
900 Nuda ABS	2013/2013	065124	YTX14H-BS ■	—	—	—	—
900 Nuda ABS	2013/2013	065129	YTX14-BS ■	068129	ESTX14-BS ■	—	—
900 Nuda R	2012/2013	065124	YTX14H-BS ■	—	—	—	—
900 Nuda R	2012/2013	065129	YTX14-BS ■	068129	ESTX14-BS ■	—	—
900 Nuda R ABS	2013/2013	065124	YTX14H-BS ■	—	—	—	—
900 Nuda R ABS	2013/2013	065129	YTX14-BS ■	068129	ESTX14-BS ■	—	—

HYOSUNG

50 Plus	1995/>	0650390	YTX4L-BS ■	068039	ESTX4L-BS ■	—	—
50 SB M	2007/2008	065049	YTX5L-BS ■	068049	ESTX5L-BS ■	063049	FTX5L-BS ■
50 SD Sense E1	2000/2004	0650390	YTX4L-BS ■	068039	ESTX4L-BS ■	—	—
50 SD Sense E2	2005/2005	0650390	YTX4L-BS ■	068039	ESTX4L-BS ■	—	—
50 SF B Raging	2001/2001	065049	YTX5L-BS ■	068049	ESTX5L-BS ■	063049	FTX5L-BS ■
50 SF Fast	2000/2003	0650390	YTX4L-BS ■	068039	ESTX4L-BS ■	—	—
50 SF Prima	2000/2000	065049	YTX5L-BS ■	068049	ESTX5L-BS ■	063049	FTX5L-BS ■
50 SF Prima E2	2005/2005	0650390	YTX4L-BS ■	068039	ESTX4L-BS ■	—	—
50 Supercab	1995/>	0650390	YTX4L-BS ■	068039	ESTX4L-BS ■	—	—
50 TE	2005/2005	065049	YTX5L-BS ■	068049	ESTX5L-BS ■	063049	FTX5L-BS ■
90 TE	2005/2005	065049	YTX5L-BS ■	068049	ESTX5L-BS ■	063049	FTX5L-BS ■
100 EZ M	2007/2008	065049	YTX5L-BS ■	068049	ESTX5L-BS ■	063049	FTX5L-BS ■
100 TE	2005/2005	065049	YTX5L-BS ■	068049	ESTX5L-BS ■	063049	FTX5L-BS ■
125 GT Comet	2004/2006	065124	YTX14H-BS ■	—	—	—	—
125 GT Comet	2004/2006	065129	YTX14-BS ■	068129	ESTX14-BS ■	—	—
125 GT Comet R / IE (E2/ E3)	2006/2008	065124	YTX14H-BS ■	—	—	—	—
125 GT Comet R / IE (E2/ E3)	2006/2008	065129	YTX14-BS ■	068129	ESTX14-BS ■	—	—
125 GV Aquila	2007/2008	0650990	YTX9-BS ■	068099	ESTX9-BS ■	063099	FTX9-BS ■
125 MS1 Exceed	2005/2005	0650990	YTX9-BS ■	068099	ESTX9-BS ■	063099	FTX9-BS ■
125 MS3 E3	2007/2008	0650990	YTX9-BS ■	068099	ESTX9-BS ■	063099	FTX9-BS ■
125 RT Karion	2004/2007	0650990	YTX9-BS ■	068099	ESTX9-BS ■	063099	FTX9-BS ■
125 RX D Enduro E3	2007/2008	0650990	YTX9-BS ■	068099	ESTX9-BS ■	063099	FTX9-BS ■
125 RX SM Motard E3	2007/2014	0650990	YTX9-BS ■	068099	ESTX9-BS ■	063099	FTX9-BS ■

▲ - Factory Sealed / Attivata dalla Fabbrica ■ - con Acido a corredo ◇ - Non di produzione YUASA a completamento gamma

Marca / Cilindrata / Modello / Anno		Cod. SGR		Cod. SGR		Cod. SGR	
HYOSUNG							
125 XR	1999/2007	0650990	YTX9-BS■	068099	ESTX9-BS■	063099	FTX9-BS■
250 GT Comet	2004/2005	065124	YTX14H-BS■	—	—	—	—
250 GT Comet	2004/2005	065129	YTX14-BS■	068129	ESTX14-BS■	—	—
250 GT Comet R	2006/2008	065124	YTX14H-BS■	—	—	—	—
250 GT Comet R	2006/2008	065129	YTX14-BS■	068129	ESTX14-BS■	—	—
250 GT Comet S	2006/2007	065124	YTX14H-BS■	—	—	—	—
250 GT Comet S	2006/2007	065129	YTX14-BS■	068129	ESTX14-BS■	—	—
250 GV Aquila	2004/2007	0650990	YTX9-BS■	068099	ESTX9-BS■	063099	FTX9-BS■
250 GV Aquila FI/ EI	2008/2009	0650990	YTX9-BS■	068099	ESTX9-BS■	063099	FTX9-BS■
250 MS3 E3	2007/2008	0650990	YTX9-BS■	068099	ESTX9-BS■	063099	FTX9-BS■
450 TE Rapier ATV	2007/2007	0650990	YTX9-BS■	068099	ESTX9-BS■	063099	FTX9-BS■
650 GT Comet	2004/2005	065124	YTX14H-BS■	—	—	—	—
650 GT Comet	2004/2005	065129	YTX14-BS■	068129	ESTX14-BS■	—	—
650 GT Comet R / R TTC	2005/2008	065124	YTX14H-BS■	—	—	—	—
650 GT Comet R / R TTC	2005/2008	065129	YTX14-BS■	068129	ESTX14-BS■	—	—
650 GT Comet S	2005/2008	065124	YTX14H-BS■	—	—	—	—
650 GT Comet S	2005/2008	065129	YTX14-BS■	068129	ESTX14-BS■	—	—
650 GV Aquila	2005/2007	065124	YTX14H-BS■	—	—	—	—
650 GV Aquila	2005/2007	065129	YTX14-BS■	068129	ESTX14-BS■	—	—
INDIAN							
1442 Chief, Scout	1999/2001	0650201	GYZ20H▲	—	—	—	—
1442 Chief, Scout	1999/2001	065184	YTX20H-BS■	—	—	—	—
INNOCENTI							
125 Lambretta DL	1969/1971	0601113	6N11A-3A	—	—	—	—
125 Lambretta LI/ DL	TUTTI	0601113	6N11A-3A	—	—	—	—
150 Lambretta LI/ DL	TUTTI	0601113	6N11A-3A	—	—	—	—
175 Lambretta LI/ DL	TUTTI	0601113	6N11A-3A	—	—	—	—
175 Lambro FLI	1960/>	0652711	6MC4 ◇	—	—	—	—
200 Lambro FLI	1963/>	0652711	6MC4 ◇	—	—	—	—
450 Lambro	TUTTI	0653211	6MK5 ◇	—	—	—	—
550 Lambro	TUTTI	0653211	6MK5 ◇	—	—	—	—
600 Lambro	TUTTI	0653211	6MK5 ◇	—	—	—	—
ITALJET							
50 Adly	TUTTI	0650534	YB5L-B	0680534	ESB5L-B■	—	—
50 Bazooka	1992/>	06504340	YB4L-B	—	—	—	—
50 Bazooka	1992/>	065043410	YB4L-B■	0680434	ESB4L-B■	—	—
50 Bazooka 2	1992/>	06504340	YB4L-B	—	—	—	—
50 Bazooka 2	1992/>	065043410	YB4L-B■	0680434	ESB4L-B■	—	—
50 Dragster	1998/2000	06504340	YB4L-B	—	—	—	—
50 Dragster	1998/2000	065043410	YB4L-B■	0680434	ESB4L-B■	—	—
50 Formula DD/ DT	1994/2000	06504340	YB4L-B	—	—	—	—

▲ - Factory Sealed / Attivata dalla Fabbrica ■ - con Acido a corredo ◇ - Non di produzione YUASA a completamento gamma





ITALJET

50	Formula DD/ DT	1994/2000	065043410	YB4L-B ■	0680434	ESB4L-B ■	—	—
50	Formula Lc / Williams	1994/2000	06504340	YB4L-B	—	—	—	—
50	Formula Lc / Williams	1994/2000	065043410	YB4L-B ■	0680434	ESB4L-B ■	—	—
50	Pista 12	1990/>	06504340	YB4L-B	—	—	—	—
50	Pista 12	1990/>	065043410	YB4L-B ■	0680434	ESB4L-B ■	—	—
50	Reporter	TUTTI	06504340	YB4L-B	—	—	—	—
50	Reporter	TUTTI	065043410	YB4L-B ■	0680434	ESB4L-B ■	—	—
50	Scoop 2/ 3	1990/>	06504340	YB4L-B	—	—	—	—
50	Scoop 2/ 3	1990/>	065043410	YB4L-B ■	0680434	ESB4L-B ■	—	—
50	Torpedo 2T	1997/1999	06504340	YB4L-B	—	—	—	—
50	Torpedo 2T	1997/1999	065043410	YB4L-B ■	0680434	ESB4L-B ■	—	—
50	Torpedo 4T	2001/2003	06509350	YB9-B	0680935	ESB9-B ■	—	—
50	Velocifero	TUTTI	06504340	YB4L-B	—	—	—	—
50	Velocifero	TUTTI	065043410	YB4L-B ■	0680434	ESB4L-B ■	—	—
100	Millenium 2T	2000/2002	0650700	YTX7A-BS ■	068070	ESTX7A-BS ■	—	—
125	Dragster	1999/2000	065124	YTX14H-BS ■	—	—	—	—
125	Dragster	1999/2000	065129	YTX14-BS ■	068129	ESTX14-BS ■	—	—
125	Formula	1997/1999	06509350	YB9-B	0680935	ESB9-B ■	—	—
125	JetSet	2001/2003	06509350	YB9-B	0680935	ESB9-B ■	—	—
125	Jupiter	2001/2002	0650987	YTX9A-BS ◇ ■	—	—	—	—
125	Millenium	2000/2002	0650700	YTX7A-BS ■	068070	ESTX7A-BS ■	—	—
125	Torpedo 4T Aria	1998/2000	06509350	YB9-B	0680935	ESB9-B ■	—	—
125	Torpedo 4T LC	2000/2002	06509350	YB9-B	0680935	ESB9-B ■	—	—
150	JetSet	2001/2003	06509350	YB9-B	0680935	ESB9-B ■	—	—
150	Jupiter	2001/2002	0650987	YTX9A-BS ◇ ■	—	—	—	—
150	Millenium	2000/2002	0650700	YTX7A-BS ■	068070	ESTX7A-BS ■	—	—
150	Torpedo	2000/2002	06509350	YB9-B	0680935	ESB9-B ■	—	—
180	Dragster	1999/2000	065124	YTX14H-BS ■	—	—	—	—
180	Dragster	1999/2000	065129	YTX14-BS ■	068129	ESTX14-BS ■	—	—
250	Jupiter	2001/2002	0650987	YTX9A-BS ◇ ■	—	—	—	—



KAWASAKI

110	KLX	2010/2013	0650390	YTX4L-BS ■	068039	ESTX4L-BS ■	—	—
125	BN Eliminator	1998/2008	06509350	YB9-B	0680935	ESB9-B ■	—	—
125	CH Spacy	TUTTI	0600633	6N6-3B	—	—	—	—
125	KLX (CAF/ CBF/ CCS/ CDF/ CDS/ CEF)	2010/2014	0650700	YTX7A-BS ■	068070	ESTX7A-BS ■	—	—
125	KLX D Traker (DAF/ DBF/ DCF/ DEF)	2010/2014	0650700	YTX7A-BS ■	068070	ESTX7A-BS ■	—	—
125	KS	TUTTI	0600633	6N6-3B	—	—	—	—
200	KDX	1989/1997	0650334	YB3L-A	0680334	ESB3L-A ■	—	—
200	KMX	1988/1992	06504340	YB4L-B	—	—	—	—
200	KMX	1988/1992	065043410	YB4L-B ■	0680434	ESB4L-B ■	—	—
200	Z (KZ200A1/ A1A/ A2/ A3/ A4/ A5/ A6)	1978/1979	0651135	YB10L-B	0681135	ESB10L-B ■	—	—



▲ - Factory Sealed / Attivata dalla Fabbrica : ■ - con Acido a corredo : ◇ - Non di produzione YUASA a completamento gamma

Marca / Cilindrata / Modello / Anno			Cod. SGR		Cod. SGR		Cod. SGR	
KAWASAKI								
250	EL Eliminator (EL250B/ E/ F)	1989/2003	0650690	YTX7L-BS■	068069	ESTX7L-BS■	063069	FTX7L-BS■
250	Estrella (BJ250)	1995/1999	0650990	YTX9-BS■	068099	ESTX9-BS■	063099	FTX9-BS■
250	EX Ninja R (EX250K8F)	2008/2008	0650700	YTX7A-BS■	068070	ESTX7A-BS■	—	—
250	EX Ninja R (EX250K8F)	2009/2012	0650990	YTX9-BS■	068099	ESTX9-BS■	063099	FTX9-BS■
250	GPX R (EX250F)	1988/2006	0650936	YB9L-A2	0680936	ESB9L-A2■	—	—
250	KH Mach1 (A5)	1976/1979	0650636	12N5.5-4A	—	—	—	—
250	KL Super Sherpa (KL250G)	2000/2004	0650690	YTX7L-BS■	068069	ESTX7L-BS■	063069	FTX7L-BS■
250	KL Super Sherpa (KL250G9F)	2009/2010	0650690	YTX7L-BS■	068069	ESTX7L-BS■	063069	FTX7L-BS■
250	KLX S (KLX250H)	2006/2007	0650690	YTX7L-BS■	068069	ESTX7L-BS■	063069	FTX7L-BS■
250	KLX S (LX250SSD)	2009/2014	0650690	YTX7L-BS■	068069	ESTX7L-BS■	063069	FTX7L-BS■
250	S1 Mach1 (S1A/ S1B/ S1C)	1973/1975	0650636	12N5.5-4A	—	—	—	—
250	Z (KZ250D1)	1980/1980	0651134	YB10L-A2	0681134	ESB10L-A2■	—	—
250	Z CSR (KZ250D2 CSR)	1981/1981	0651134	YB10L-A2	0681134	ESB10L-A2■	—	—
250	Z CSR Belt (KZ250L1 CSR Belt)	1982/1982	0651134	YB10L-A2	0681134	ESB10L-A2■	—	—
250	Z LTD Belt (KZ250W1 LTD Belt)	1983/1983	0651134	YB10L-A2	0681134	ESB10L-A2■	—	—
250	ZXR (ZX250A1/ A2/ C1>C5)	1989/1995	0650936	YB9L-A2	0680936	ESB9L-A2■	—	—
250	ZZ R - Ninja R (EX250E/ EX250F)	1986/1995	0650936	YB9L-A2	0680936	ESB9L-A2■	—	—
250	ZZ R - Ninja R (EX250E/ EX250F)	1996/>	0650690	YTX7L-BS■	068069	ESTX7L-BS■	063069	FTX7L-BS■
300	EX Ninja R (EX300AADA/ EX300ABDA)	2013/2016	0650990	YTX9-BS■	068099	ESTX9-BS■	063099	FTX9-BS■
300	J / J ABS (RGSC)(SC300)	2014/2015	0651110	YT12A-BS■	0681110	EST12A-BS■	—	—
300	JS (Jet Ski)	TUTTI	0651640	YB16CL-B	0681640	ESB16CL-B■	—	—
300	JS (Jet Ski)	TUTTI	065186	YTX20HL-BS-PW■	—	—	—	—
300	JS TS, SX	1986/1991	065186	YTX20HL-BS-PW■	—	—	—	—
300	KEF A Lakota	1995/2000	065122	YTX14AH-BS■	068122	ESTX14AH-BS■	—	—
300	KEF A Lakota	1995/2000	0651431	YB14A-A2	0681431	ESB14A-A2■	—	—
300	KEF B Lakota Sport	2001/2002	065122	YTX14AH-BS■	068122	ESTX14AH-BS■	—	—
300	KEF B Lakota Sport	2001/2002	0651431	YB14A-A2	0681431	ESB14A-A2■	—	—
300	KLF A Bayou	1986/1987	0651431	YB14A-A2	0681431	ESB14A-A2■	—	—
300	KLF A Bayou	1986/1987	065186	YTX20HL-BS-PW■	—	—	—	—
300	KLF B Bayou	1988/2004	065122	YTX14AH-BS■	068122	ESTX14AH-BS■	—	—
300	KLF B Bayou	1988/2004	0651431	YB14A-A2	0681431	ESB14A-A2■	—	—
300	KLF B Bayou (CN)	1992/1999	065186	YTX20HL-BS-PW■	—	—	—	—
300	KLF C Bayou 4x4	1989/2005	065122	YTX14AH-BS■	068122	ESTX14AH-BS■	—	—
300	KLF C Bayou 4x4	1989/2005	0651431	YB14A-A2	0681431	ESB14A-A2■	—	—
300	KLF C Bayou 4x4 (CN)	1992/2005	065186	YTX20HL-BS-PW■	—	—	—	—
300	KVF A Prairie 4x4	1999/2002	065122	YTX14AH-BS■	068122	ESTX14AH-BS■	—	—
300	KVF A Prairie 4x4	1999/2002	0651431	YB14A-A2	0681431	ESB14A-A2■	—	—
300	KVF A Prairie 4x4 (CN)	1999/2001	065186	YTX20HL-BS-PW■	—	—	—	—
300	KVF B Prairie 4x4	1999/2002	065122	YTX14AH-BS■	068122	ESTX14AH-BS■	—	—
300	KVF B Prairie 4x4	1999/2002	0651431	YB14A-A2	0681431	ESB14A-A2■	—	—
300	KVF B Prairie 4x4 (CN)	1999/2002	065186	YTX20HL-BS-PW■	—	—	—	—

▲ - Factory Sealed / Attivata dalla Fabbrica ■ - con Acido a corredo ◇ - Non di produzione YUASA a completamento gamma

Marca / Cilindrata / Modello / Anno			Cod. SGR		Cod. SGR		Cod. SGR		
KAWASAKI									
305	GPZ (EX305A)	1983/1983	0650936	YB9L-A2	0680936	ESB9L-A2 ■	—	—	
350	S2 Mach 2 (S2/ S2A)	1972/1973	0650636	12N5.5-4A	—	—	—	—	
360	KVF A Prairie 4x4	2003/2010	065122	YTX14AH-BS ■	068122	ESTX14AH-BS ■	—	—	
360	KVF B Prairie 4x4	2003/2010	065122	YTX14AH-BS ■	068122	ESTX14AH-BS ■	—	—	
360	KVF C Prairie 4X4	2003/2010	065122	YTX14AH-BS ■	068122	ESTX14AH-BS ■	—	—	
400	JS (Jet Ski)	1976/1976	0650202	GYZ20HL ▲	—	—	—	—	
400	JS (Jet Ski)	1976/1976	065185	YTX20HL-BS ■	—	—	—	—	
400	JS (Jet Ski)	TUTTI	0651640	YB16CL-B	0681640	ESB16CL-B ■	—	—	
400	JS (Jet Ski)	TUTTI	065186	YTX20HL-BS-PW ■	—	—	—	—	
400	KFX (KSF)	2003/2006	0650990	YTX9-BS ■	068099	ESTX9-BS ■	063099	FTX9-BS ■	
400	KH (A3/ A4/ A5)	1976/1979	0650636	12N5.5-4A	—	—	—	—	
400	KH S3	1976/1978	0650636	12N5.5-4A	—	—	—	—	
400	KLF B Bayou 4x4	1993/2000	065186	YTX20HL-BS-PW ■	—	—	—	—	
400	KLX R	2003/2004	0650710	YT7B-BS ■	068071	EST7B-BS ■	—	—	
400	KLX SR	2003/2004	0650710	YT7B-BS ■	068071	EST7B-BS ■	—	—	
400	KVF A Prairie 4x4	1997/2000	065122	YTX14AH-BS ■	068122	ESTX14AH-BS ■	—	—	
400	KVF A Prairie 4x4 (CN)	1997/2000	065186	YTX20HL-BS-PW ■	—	—	—	—	
400	KVF B Prairie 4x4	1998/2000	065122	YTX14AH-BS ■	068122	ESTX14AH-BS ■	—	—	
400	KVF B Prairie 4x4 (CN)	1998/2000	065186	YTX20HL-BS-PW ■	—	—	—	—	
400	KVF C Prairie 4X4	1999/2002	065122	YTX14AH-BS ■	068122	ESTX14AH-BS ■	—	—	
400	KVF D Prairie 4x4	1999/2002	065122	YTX14AH-BS ■	068122	ESTX14AH-BS ■	—	—	
400	LTD (KZ400H1)	1979/1979	0651234	YB12A-A	0681234	ESB12A-A ■	—	—	
400	S3 Mach2 (S3/ S3A)	1974/1975	0650636	12N5.5-4A	—	—	—	—	
400	Z (KZ400)	1974/1974	0651233	12N12A-4A-1	0681233	ES12N12A-4A-1 ■	—	—	
400	Z (KZ400A1/ A2)	1977/1978	0651233	12N12A-4A-1	0681233	ES12N12A-4A-1 ■	—	—	
400	Z (KZ400B1/ B2)	1978/1979	0651234	YB12A-A	0681234	ESB12A-A ■	—	—	
400	Z (KZ400C1)	1978/1978	0650636	12N5.5-4A	—	—	—	—	
400	Z (KZ400D1/ D2)	1975/1975	0651233	12N12A-4A-1	0681233	ES12N12A-4A-1 ■	—	—	
400	Z (KZ400D3/ D4)	1976/1977	0651233	12N12A-4A-1	0681233	ES12N12A-4A-1 ■	—	—	
400	Z (KZ400J1/ J2/ J3)	1980/1982	0651234	YB12A-A	0681234	ESB12A-A ■	—	—	
400	Z (KZ400S/ S2/ S3 Special)	1975/1977	0650636	12N5.5-4A	—	—	—	—	
400	ZXR/ ZX4R Ninja (ZX400J/ L/ M)	1991/1995	0650990	YTX9-BS ■	068099	ESTX9-BS ■	063099	FTX9-BS ■	
440	JS	1977/1986	0650202	GYZ20HL ▲	—	—	—	—	
440	JS	1977/1986	065185	YTX20HL-BS ■	—	—	—	—	
440	JS	1987/1992	065186	YTX20HL-BS-PW ■	—	—	—	—	
440	LTD (KZ440A1/ A2/ A3/ A4/ A5)	1980/1983	0651234	YB12A-A	0681234	ESB12A-A ■	—	—	
440	LTD Belt (KZ440D1/ D2/ D3/ D4/ D5/ D6)	1980/1984	0651234	YB12A-A	0681234	ESB12A-A ■	—	—	
440	Z (KZ440B1/ B2)	1980/1981	0651234	YB12A-A	0681234	ESB12A-A ■	—	—	
440	Z (KZ440C1/ C2)	1980/1981	0651234	YB12A-A	0681234	ESB12A-A ■	—	—	
440	Z (KZ440H1/ H2)	1982/1983	0651234	YB12A-A	0681234	ESB12A-A ■	—	—	
440	Z Belt (KZ440G1)	1982/1982	0651234	YB12A-A	0681234	ESB12A-A ■	—	—	

▲ - Factory Sealed / Attivata dalla Fabbrica ■ - con Acido a corredo ◇ - Non di produzione YUASA a completamento gamma

Marca / Cilindrata / Modello / Anno			Cod. SGR		Cod. SGR		Cod. SGR	
KAWASAKI								
450	EN 454 LTD (EN450A1/ A6)	1985/1990	0651234	YB12A-A	0681234	ESB12A-A■	—	—
450	KAF Mule 1000 (B1)	1991/1991	065186	YTX20HL-BS-PW■	—	—	—	—
450	KFX R (KSF450)	2007/2012	0650690	YTX7L-BS■	068069	ESTX7L-BS■	063069	FTX7L-BS■
450	KLX R	2007/2015	065007	YTZ7S▲	—	—	063007	FTZ7S▲
500	EN Vulcan (EN500)	1990/1995	0651234	YB12A-A	0681234	ESB12A-A■	—	—
500	EN Vulcan (EN500)	1996/2005	06512400	YB12AL-A2	0681240	ESB12AL-A2■	—	—
500	ER5 (ER500 A1/ A4-C1/ C5)	1997/2002	0651090	YTX12-BS■	0681090	ESTX12-BS■	063109	FTX12-BS■
500	GPZ S (EX500A/ D)	1987/1993	065123	YTX14AHL-BS■	—	—	—	—
500	GPZ S (EX500A/ D)	1987/1993	0651434	YB14L-A2	0681434	ESB14L-A2■	—	—
500	GPZ S (EX500A/ D)	1994/2005	065123	YTX14AHL-BS■	—	—	—	—
500	GPZ S (EX500A/ D)	1994/2005	0651434	YB14L-A2	0681434	ESB14L-A2■	—	—
500	HI Mach3 (A/ D/ E/ F)	1973/1975	0650735	12N7-4B	—	—	—	—
500	KH 500 (A8)	1976/1976	0650933	12N9-3B	0680933	ES12N9-3B■	—	—
500	KLE (LE500A)	1991/2007	0651090	YTX12-BS■	0681090	ESTX12-BS■	063109	FTX12-BS■
500	Z (KZ500B1/ B2)	1979/1980	0651234	YB12A-A	0681234	ESB12A-A■	—	—
540	KAF Mule 2010	1991/>	065186	YTX20HL-BS-PW■	—	—	—	—
540	KAF Mule 2020	1991/>	065186	YTX20HL-BS-PW■	—	—	—	—
540	KAF Mule 2030	1991/>	065186	YTX20HL-BS-PW■	—	—	—	—
550	GPZ (KZ550GPD1/ H1/ H2)	1981/1983	0651234	YB12A-A	0681234	ESB12A-A■	—	—
550	GPZ (ZX550A1/ A6)	1982/1986	0651234	YB12A-A	0681234	ESB12A-A■	—	—
550	JS	1982/1985	0650202	GYZ20HL▲	—	—	—	—
550	JS	1982/1985	065185	YTX20HL-BS■	—	—	—	—
550	JS, SX	1986/1995	065186	YTX20HL-BS-PW■	—	—	—	—
550	JS (Jet Ski)	TUTTI	0651640	YB16CL-B	0681640	ESB16CL-B■	—	—
550	JS (Jet Ski)	TUTTI	065186	YTX20HL-BS-PW■	—	—	—	—
550	LTD (KZ550LTD C1/ C2/ C3/ C4)	1980/1983	0651234	YB12A-A	0681234	ESB12A-A■	—	—
550	LTD Shaft (KZ550F2)	1984/1984	0651234	YB12A-A	0681234	ESB12A-A■	—	—
550	LTD Shaft (KZ550M1)	1983/1983	0651234	YB12A-A	0681234	ESB12A-A■	—	—
550	Z (KZ550A1/ A2/ A3)	1980/1983	0651234	YB12A-A	0681234	ESB12A-A■	—	—
550	Z (KZ550B1/ B2)	1984/1986	0651234	YB12A-A	0681234	ESB12A-A■	—	—
550	Z GT (KZ GT) (KZ550G1/ G9)	1983/1989	0651234	YB12A-A	0681234	ESB12A-A■	—	—
550	ZR Zephyr (ZR550B1>B9)	1990/1992	0651234	YB12A-A	0681234	ESB12A-A■	—	—
600	GPX R Ninja (ZX600B1/ C1/ C10)	1988/1994	0651234	YB12A-A	0681234	ESB12A-A■	—	—
600	GPZ R Ninja (ZX600A1/ A4)	1985/1988	0651234	YB12A-A	0681234	ESB12A-A■	—	—
600	KLR (KL600A)	1984/1992	06504340	YB4L-B	—	—	—	—
600	KLR (KL600A)	1984/1992	065043410	YB4L-B■	0680434	ESB4L-B■	—	—
600	KLR (KL600B)	1985/1988	065123	YTX14AHL-BS■	—	—	—	—
600	KLR (KL600B)	1985/1988	0651434	YB14L-A2	0681434	ESB14L-A2■	—	—
600	ZL Eliminator (ZL600A/ B)	1986/1987	0651234	YB12A-A	0681234	ESB12A-A■	—	—
600	ZX6R Ninja (ZX600F1/ F2/ F3/ G1/ G2/ J1P/ J2P)	1995/1995	0650990	YTX9-BS■	068099	ESTX9-BS■	063099	FTX9-BS■
600	ZX6R Ninja (ZX600F1/ F2/ F3/ G1/ G2/ J1P/ J2P)	1996/2001	0651090	YTX12-BS■	0681090	ESTX12-BS■	063109	FTX12-BS■

▲ - Factory Sealed / Attivata dalla Fabbrica ■ - con Acido a corredo ◇ - Non di produzione YUASA a completamento gamma

Marca / Cilindrata / Modello / Anno

Cod. SGR



Cod. SGR





Cod. SGR





KAWASAKI

600	ZX6R Ninja (ZX600P7F/ P8F/ R9F/ RAF/ RBF/ RCF)	2007/2016	0650990	YTX9-BS■	068099	ESTX9-BS■	063099	FTX9-BS■
600	ZX6RR Ninja (ZX600K1H/ MIH/ N1H)	2003/2006	0650990	YTX9-BS■	068099	ESTX9-BS■	063099	FTX9-BS■
600	ZZR Ninja (ZX600D/ E/ J)	1990/1992	0651234	YB12A-A	0681234	ESB12A-A■	—	—
600	ZZR Ninja (ZX600D/ E/ J)	1993/2001	0651090	YTX12-BS■	0681090	ESTX12-BS■	063109	FTX12-BS■
620	KAF Mule 2500	1991/>	065186	YTX20HL-BS-PW■	—	—	—	—
620	KAF Mule 2510 4X4	1991/>	065186	YTX20HL-BS-PW■	—	—	—	—
620	KAF Mule 2520	1991/>	065186	YTX20HL-BS-PW■	—	—	—	—
620	KAF Mule 3000	2000/2008	0650202	GYZ20HL▲	—	—	—	—
620	KAF Mule 3000	2000/2008	065185	YTX20HL-BS■	—	—	—	—
620	KAF Mule 3010	2000/2008	0650202	GYZ20HL▲	—	—	—	—
620	KAF Mule 3010	2000/2008	065185	YTX20HL-BS■	—	—	—	—
620	KAF Mule 3020	2000/2003	0650202	GYZ20HL▲	—	—	—	—
620	KAF Mule 3020	2000/2003	065185	YTX20HL-BS■	—	—	—	—
636	ZX6R Ninja (ZX636A1P/ B1H/ B2H/ C1H/ C6F)	2002/2006	0650990	YTX9-BS■	068099	ESTX9-BS■	063099	FTX9-BS■
636	ZX6R Ninja ABS FDF (ZX636EFA)	2013/2014	0650990	YTX9-BS■	068099	ESTX9-BS■	063099	FTX9-BS■
636	ZX6R Ninja EDF (ZX636EEA)	2013/2014	0650990	YTX9-BS■	068099	ESTX9-BS■	063099	FTX9-BS■
650	CSR (KZ650H1/ H2/ H3)	1981/1983	0651234	YB12A-A	0681234	ESB12A-A■	—	—
650	ER6 F (EX650A6F/ EGF)	2006/2011	0651090	YTX12-BS■	0681090	ESTX12-BS■	063109	FTX12-BS■
650	ER6 F (EX650A6F/ EGF)	2012/2014	0651110	YT12A-BS■	0681110	EST12A-BS■	—	—
650	ER6 N	2006/2011	0651090	YTX12-BS■	0681090	ESTX12-BS■	063109	FTX12-BS■
650	ER6 N	2012/2015	0651110	YT12A-BS■	0681110	EST12A-BS■	—	—
650	JF TS	1989/1996	065186	YTX20HL-BS-PW■	—	—	—	—
650	JF X2	1986/1995	065186	YTX20HL-BS-PW■	—	—	—	—
650	JL SC	1991/1995	065186	YTX20HL-BS-PW■	—	—	—	—
650	JS (Jet Ski)	TUTTI	0651640	YB16CL-B	0681640	ESB16CL-B■	—	—
650	JS (Jet Ski)	TUTTI	065186	YTX20HL-BS-PW■	—	—	—	—
650	JS SX	1987/1995	065186	YTX20HL-BS-PW■	—	—	—	—
650	KL Tengai (KL650B)	1989/1991	065123	YTX14AHL-BS■	—	—	—	—
650	KL Tengai (KL650B)	1989/1991	0651434	YB14L-A2	0681434	ESB14L-A2■	—	—
650	KLE Versys (A7F/ A8F/ A9F/ CAF/ CBF/ CCF)	2007/2014	0651090	YTX12-BS■	0681090	ESTX12-BS■	063109	FTX12-BS■
650	KLE Versys (EFF-EGF)	2015/2016	0651090	YTX12-BS■	0681090	ESTX12-BS■	063109	FTX12-BS■
650	KLE Versys (FHF-FHFA)	2017/2017	0651090	YTX12-BS■	0681090	ESTX12-BS■	063109	FTX12-BS■
650	KLE Versys ABS (B7F/ B8F/ B9F/ DAF/ DBF/ DCF)	2007/2014	0651090	YTX12-BS■	0681090	ESTX12-BS■	063109	FTX12-BS■
650	KLE Versys ABS (FFF-FGF)	2015/2016	0651090	YTX12-BS■	0681090	ESTX12-BS■	063109	FTX12-BS■
650	KLR (KL650A1/ A5-KL650C)	1987/2005	065123	YTX14AHL-BS■	—	—	—	—
650	KLR (KL650A1/ A5-KL650C)	1987/2005	0651434	YB14L-A2	0681434	ESB14L-A2■	—	—
650	KLX R (KLX650D)	1993/2002	0650990	YTX9-BS■	068099	ESTX9-BS■	063099	FTX9-BS■
650	KLX S (KLX650C)	1993/1995	0650990	YTX9-BS■	068099	ESTX9-BS■	063099	FTX9-BS■
650	KVF Brute Force 4X4 (KVF650D/ E)	2005/2008	065124	YTX14H-BS■	—	—	—	—
650	KVF Brute Force 4X4 (KVF650D/ E)	2005/2008	065129	YTX14-BS■	068129	ESTX14-BS■	—	—
650	KVF Brute Force 4X4 (KVF650F/ G/ H)	2006/2011	065124	YTX14H-BS■	—	—	—	—



▲ - Factory Sealed / Attivata dalla Fabbrica : ■ - con Acido a corredo : ◇ - Non di produzione YUASA a completamento gamma

Marca / Cilindrata / Modello / Anno			Cod. SGR		Cod. SGR		Cod. SGR	
KAWASAKI								
650	KVF Brute Force 4X4 (KVF650F/ G/ H)	2006/2011	065129	YTX14-BS■	068129	ESTX14-BS■	—	—
650	KVF Prairie 4X4 (KVF650A/ B)	2002/2003	065124	YTX14H-BS■	—	—	—	—
650	KVF Prairie 4X4 (KVF650A/ B)	2002/2003	065129	YTX14-BS■	068129	ESTX14-BS■	—	—
650	LTD (KZ650E1)	1980/1980	0651134	YB10L-A2	0681134	ESB10L-A2■	—	—
650	Ninja ABS (EX650KKDA)	2017/2017	065010	YTZ10S▲	—	—	063010	FTZ10S▲
650	Vulcan S (EN650AADA)	2015/2016	065010	YTZ10S▲	—	—	063010	FTZ10S▲
650	Vulcan S ABS (EN650ABDA)	2015/2016	065010	YTZ10S▲	—	—	063010	FTZ10S▲
650	W (EJ650A/ E4/ 0010)	1999/2004	065124	YTX14H-BS■	—	—	—	—
650	W (EJ650A/ E4/ 0010)	1999/2004	065129	YTX14-BS■	068129	ESTX14-BS■	—	—
650	Z (ER650HHDA)	2017/2017	065010	YTZ10S▲	—	—	063010	FTZ10S▲
650	Z (KZ650B1/ B2/ B3/ B4)	1977/1980	0651134	YB10L-A2	0681134	ESB10L-A2■	—	—
650	Z (KZ650C1/ C2/ C3/ C4)	1977/1979	0651134	YB10L-A2	0681134	ESB10L-A2■	—	—
650	Z (KZ650F1)	1980/1980	0651134	YB10L-A2	0681134	ESB10L-A2■	—	—
650	Z (KZ650F2/ F3/ F4)	1981/1983	0651134	YB10L-A2	0681134	ESB10L-A2■	—	—
650	Z SR (KZ650D1/ D2)	1978/1979	0651134	YB10L-A2	0681134	ESB10L-A2■	—	—
700	KFX V-Force (KSV700A/ B)	2004/2007	065124	YTX14H-BS■	—	—	—	—
700	KFX V-Force (KSV700A/ B)	2004/2007	065129	YTX14-BS■	068129	ESTX14-BS■	—	—
700	KVF Prairie 4X4 (KVF700A)	2004/2006	065124	YTX14H-BS■	—	—	—	—
700	KVF Prairie 4X4 (KVF700A)	2004/2006	065129	YTX14-BS■	068129	ESTX14-BS■	—	—
700	LTD Shaft (ZN700A1/ A2)	1984/1985	065123	YTX14AHL-BS■	—	—	—	—
700	LTD Shaft (ZN700A1/ A2)	1984/1985	0651439	YB14L-B2	0681439	ESB14L-B2■	—	—
700	VN Vulcan	1985/1985	065123	YTX14AHL-BS■	—	—	—	—
700	VN Vulcan	1985/1985	0651439	YB14L-B2	0681439	ESB14L-B2■	—	—
750	CSR Twin (KZ750M1)	1982/1982	0651434	YB14L-A2	0681434	ESB14L-A2■	—	—
750	GPX R (ZX750F1/ F2/ F3)	1987/1989	0651434	YB14L-A2	0681434	ESB14L-A2■	—	—
750	GPZ (KZ750R1)	1982/1982	0651234	YB12A-A	0681234	ESB12A-A■	—	—
750	GPZ (ZX750A1/ A2/ A3/ A4/ A5)	1983/1987	0651436	SYB14L-A2	—	—	—	—
750	GPZ R Ninja (ZX750G2/ G3)	1985/1986	0651434	YB14L-A2	0681434	ESB14L-A2■	—	—
750	GPZ Turbo (ZX750E1/ E2)	1984/1985	0651436	SYB14L-A2	—	—	—	—
750	GT (Z750P1>P9)	1984/1994	0651436	SYB14L-A2	—	—	—	—
750	H2 Mach IV (H2A/ B/ C)	1973/1975	0650633	12N5.5-4B	—	—	—	—
750	JH SS	1992/1997	065186	YTX20HL-BS-PW■	—	—	—	—
750	JH ST	1995/1995	065186	YTX20HL-BS-PW■	—	—	—	—
750	JH ST	1996/1996	0650202	GYZ20HL▲	—	—	—	—
750	JH ST	1996/1996	065185	YTX20HL-BS■	—	—	—	—
750	JH Xi	1993/1999	065186	YTX20HL-BS-PW■	—	—	—	—
750	JH XiR	1994/1994	065186	YTX20HL-BS-PW■	—	—	—	—
750	JH ZXi	1995/1997	0650202	GYZ20HL▲	—	—	—	—
750	JH ZXi	1995/1997	065185	YTX20HL-BS■	—	—	—	—
750	JS (Jet Ski)	TUTTI	0650690	YTX7L-BS■	068069	ESTX7L-BS■	063069	FTX7L-BS■
750	JS SX, ZX	1992/1995	065186	YTX20HL-BS-PW■	—	—	—	—



▲ - Factory Sealed / Attivata dalla Fabbrica ■ - con Acido a corredo ◇ - Non di produzione YUASA a completamento gamma

Marca / Cilindrata / Modello / Anno			Cod. SGR		Cod. SGR		Cod. SGR	
KAWASAKI								
750	JS SXi, SXi Pro	1995/2002	0650202	GYZ20HL▲	—	—	—	—
750	JS SXi, SXi Pro	1995/2002	065185	YTX20HL-BS■	—	—	—	—
750	JT STS, STX	1996/1998	0650202	GYZ20HL▲	—	—	—	—
750	JT STS, STX	1996/1998	065185	YTX20HL-BS■	—	—	—	—
750	JT XiR, ST, STS	1994/1995	065186	YTX20HL-BS-PW■	—	—	—	—
750	KVF Brute Force	2005/2011	065124	YTX14H-BS■	—	—	—	—
750	KVF Brute Force	2005/2011	065129	YTX14-BS■	068129	ESTX14-BS■	—	—
750	LTD (KZ750H1/ H2/ H3/ H4)	1980/1983	0651234	YB12A-A	0681234	ESB12A-A■	—	—
750	LTD Shaft (KZ750F1)	1983/1983	065123	YTX14AHL-BS■	—	—	—	—
750	LTD Shaft (KZ750F1)	1983/1983	0651439	YB14L-B2	0681439	ESB14L-B2■	—	—
750	LTD Twin (KZ750G1)	1980/1980	0651434	YB14L-A2	0681434	ESB14L-A2■	—	—
750	LTD Twin Belt (KZ750K1/ K2)	1983/1984	0651434	YB14L-A2	0681434	ESB14L-A2■	—	—
750	Spectre (KZ750N1/ N2)	1982/1983	065123	YTX14AHL-BS■	—	—	—	—
750	Spectre (KZ750N1/ N2)	1982/1983	0651439	YB14L-B2	0681439	ESB14L-B2■	—	—
750	VN Vulcan A2,A13 (VN750A/ D097)	1986/1994	0651434	YB14L-A2	0681434	ESB14L-A2■	—	—
750	VN Vulcan A2,A13 (VN750A/ D097)	1986/2005	065123	YTX14AHL-BS■	—	—	—	—
750	Z (KZ750B1/ B2/ B3/ B4)	1976/1979	0651434	YB14L-A2	0681434	ESB14L-A2■	—	—
750	Z (KZ750E1/ E2/ E3)	1980/1982	0651234	YB12A-A	0681234	ESB12A-A■	—	—
750	Z (KZ750L1/ L2)	1981/1982	0651233	12N12A-4A-1	0681233	ES12N12A-4A-1■	—	—
750	Z (KZ750L3/ L4)	1983/1984	0651233	12N12A-4A-1	0681233	ES12N12A-4A-1■	—	—
750	Z (ZR750JJA-J1H/ J2H)	2004/2005	0650990	YTX9-BS■	068099	ESTX9-BS■	063099	FTX9-BS■
750	Z (ZR750JJA-J6F)	2006/2006	0650990	YTX9-BS■	068099	ESTX9-BS■	063099	FTX9-BS■
750	Z (ZR750LLA-L7F/ LAF/ LAS/ LBF/ LCF)	2007/2012	0650990	YTX9-BS■	068099	ESTX9-BS■	063099	FTX9-BS■
750	Z ABS (ZR750LMA-M7F/ MAF/ MAS/ MBF/ MCF)	2007/2012	0650990	YTX9-BS■	068099	ESTX9-BS■	063099	FTX9-BS■
750	Z R (ZR750NNA-NBF/ NCF)	2011/2012	0650990	YTX9-BS■	068099	ESTX9-BS■	063099	FTX9-BS■
750	Z R ABS (ZR750NPA-PBF/ PCF)	2011/2012	0650990	YTX9-BS■	068099	ESTX9-BS■	063099	FTX9-BS■
750	Z S (ZR750K1H/ K6F)	2005/2006	0650990	YTX9-BS■	068099	ESTX9-BS■	063099	FTX9-BS■
750	ZR Zephyr (ZR750C/ D)	1991/1999	0651090	YTX12-BS■	0681090	ESTX12-BS■	063109	FTX12-BS■
750	ZR7/ ZR7S (ZR750F)	1999/2003	0651090	YTX12-BS■	0681090	ESTX12-BS■	063109	FTX12-BS■
750	ZX7R Ninja (ZX750P1/ P2/ P3/ P4/ P5/ P6)	1996/2003	0651090	YTX12-BS■	0681090	ESTX12-BS■	063109	FTX12-BS■
750	ZX7RR Ninja (ZX750N1/ N2)	1996/1998	0650990	YTX9-BS■	068099	ESTX9-BS■	063099	FTX9-BS■
750	ZXR (ZX750H1/ H2)	1989/1990	0651434	YB14L-A2	0681434	ESB14L-A2■	—	—
750	ZXR (ZX750J1/ J2)	1991/1992	0650990	YTX9-BS■	068099	ESTX9-BS■	063099	FTX9-BS■
750	ZXR (ZX750L1/ L2/ L3)	1993/1995	0651090	YTX12-BS■	0681090	ESTX12-BS■	063109	FTX12-BS■
750	ZXR R (ZX750K1/ K2)	1991/1992	0650990	YTX9-BS■	068099	ESTX9-BS■	063099	FTX9-BS■
750	ZXR R (ZX750M1/ M2)	1993/1995	0650990	YTX9-BS■	068099	ESTX9-BS■	063099	FTX9-BS■
800	JS SXR	2003/2004	0650202	GYZ20HL▲	—	—	—	—
800	JS SXR	2003/2004	065185	YTX20HL-BS■	—	—	—	—
800	VN Vulcan (VN800A)	1995/1998	065124	YTX14H-BS■	—	—	—	—
800	VN Vulcan (VN800A)	1995/1998	065129	YTX14-BS■	068129	ESTX14-BS■	—	—
800	VN Vulcan Classic (VN800B)	1995/2003	065124	YTX14H-BS■	—	—	—	—



▲ - Factory Sealed / Attivata dalla Fabbrica ■ - con Acido a corredo ◇ - Non di produzione YUASA a completamento gamma

Marca / Cilindrata / Modello / Anno			Cod. SGR		Cod. SGR		Cod. SGR	
KAWASAKI								
800	VN Vulcan Classic (VN800B)	1995/2003	065129	YTX14-BS■	068129	ESTX14-BS■	—	—
800	VN Vulcan Classic (VN800B)	2004/2006	0651090	YTX12-BS■	0681090	ESTX12-BS■	063109	FTX12-BS■
800	VN Vulcan Drifter (VN800C/ E)	1999/2003	065124	YTX14H-BS■	—	—	—	—
800	VN Vulcan Drifter (VN800C/ E)	1999/2003	065129	YTX14-BS■	068129	ESTX14-BS■	—	—
800	VN Vulcan Drifter (VN800C/ E)	2004/2006	0651090	YTX12-BS■	0681090	ESTX12-BS■	063109	FTX12-BS■
800	W (EJ800)	2011/2015	0651090	YTX12-BS■	0681090	ESTX12-BS■	063109	FTX12-BS■
800	Z ABS BDS	2013/2015	0650990	YTX9-BS■	068099	ESTX9-BS■	063099	FTX9-BS■
800	Z ADS	2013/2015	0650990	YTX9-BS■	068099	ESTX9-BS■	063099	FTX9-BS■
800	Z E ABS DDS	2013/2015	0650990	YTX9-BS■	068099	ESTX9-BS■	063099	FTX9-BS■
800	Z E CDS	2013/2015	0650990	YTX9-BS■	068099	ESTX9-BS■	063099	FTX9-BS■
900	GPZ R Ninja (ZX900A1/ A6)	1984/1989	0651434	YB14L-A2	0681434	ESB14L-A2■	—	—
900	GPZ R Ninja (ZX900A7/ A12)	1990/1996	0651434	YB14L-A2	0681434	ESB14L-A2■	—	—
900	JH (Jet Ski)	TUTTI	0650690	YTX7L-BS■	068069	ESTX7L-BS■	063069	FTX7L-BS■
900	JH ZXi	1995/1997	0650202	GYZ20HL▲	—	—	—	—
900	JH ZXi	1995/1997	065185	YTX20HL-BS■	—	—	—	—
900	JT STS, STX	1997/2002	0650202	GYZ20HL▲	—	—	—	—
900	JT STS, STX	1997/2002	065185	YTX20HL-BS■	—	—	—	—
900	LTD (KZ900B1)	1976/1976	0651134	YB10L-A2	0681134	ESB10L-A2■	—	—
900	VN Vulcan Classic (VN900B)	2006/2014	0651090	YTX12-BS■	0681090	ESTX12-BS■	063109	FTX12-BS■
900	VN Vulcan Classic LT (VN900D)	2006/2012	0651090	YTX12-BS■	0681090	ESTX12-BS■	063109	FTX12-BS■
900	VN Vulcan Custom (VN900C)	2007/2014	0651090	YTX12-BS■	0681090	ESTX12-BS■	063109	FTX12-BS■
900	Z (KZ900A4/ A5)	1976/1977	0651134	YB10L-A2	0681134	ESB10L-A2■	—	—
900	Z ABS (BHF)(ZR900BBDA)	2017/2017	0650990	YTX9-BS■	068099	ESTX9-BS■	063099	FTX9-BS■
900	Z1 Series (Z1900A/ Z1900B)	1973/1975	065123	YTX14AHL-BS■	—	—	—	—
900	Z1 Series (Z1900A/ Z1900B)	1973/1975	0651433	12N14-3A	—	—	—	—
900	Z1 Series (Z1900A/ Z1900B)	1973/1975	0651439	YB14L-B2	0681439	ESB14L-B2■	—	—
900	ZL Eliminator (ZL900A)	1985/1986	065123	YTX14AHL-BS■	—	—	—	—
900	ZL Eliminator (ZL900A)	1985/1986	0651439	YB14L-B2	0681439	ESB14L-B2■	—	—
900	ZX9R Ninja (ZX900B/ C/ E)	1994/1997	0651090	YTX12-BS■	0681090	ESTX12-BS■	063109	FTX12-BS■
900	ZX9R Ninja (ZX900B/ C/ E)	1998/2003	0650990	YTX9-BS■	068099	ESTX9-BS■	063099	FTX9-BS■
1000	CSR (KZ1000M1/ M2)	1981/1982	0650202	GYZ20HL▲	—	—	—	—
1000	CSR (KZ1000M1/ M2)	1981/1982	0651834	YB18L-A	0681834	ESB18L-A■	—	—
1000	CSR (KZ1000M1/ M2)	1981/1982	065185	YTX20HL-BS■	—	—	—	—
1000	GPZ RX (ZXT00A A1/ A3)	1986/1988	0651436	SYB14L-A2	—	—	—	—
1000	GTR Concours (ZG/ ZGTA)	1986/2002	0651834	YB18L-A	0681834	ESB18L-A■	—	—
1000	GTR Concours (ZG/ ZGTA)	1986/2005	0650202	GYZ20HL▲	—	—	—	—
1000	GTR Concours (ZG/ ZGTA)	1986/2005	065185	YTX20HL-BS■	—	—	—	—
1000	H2 Ninja	2015/2015	065010	YTZ10S▲	—	—	063010	FTZ10S▲
1000	H2R Ninja	2015/2015	065010	YTZ10S▲	—	—	063010	FTZ10S▲
1000	KLV (A1H>A2H) (JKBS1122)	2004/2005	065124	YTX14H-BS■	—	—	—	—
1000	KLV (A1H>A2H) (JKBS1122)	2004/2005	065129	YTX14-BS■	068129	ESTX14-BS■	—	—



▲ - Factory Sealed / Attivata dalla Fabbrica ■ - con Acido a corredo ◇ - Non di produzione YUASA a completamento gamma

Marca / Cilindrata / Modello / Anno			Cod. SGR		Cod. SGR		Cod. SGR	
KAWASAKI								
1000	KLZ Versys (ACF>ADF) (LZT00AA)	2012/2017	0650990	YTX9-BS■	068099	ESTX9-BS■	063099	FTX9-BS■
1000	LTD (KZ1000B1/ B2/ B3/ B4)	1977/1980	0651434	YB14L-A2	0681434	ESB14L-A2■	—	—
1000	LTD (KZ1000K1/ K2)	1981/1982	0650202	GYZ20HL▲	—	—	—	—
1000	LTD (KZ1000K1/ K2)	1981/1982	0651834	YB18L-A	0681834	ESB18L-A■	—	—
1000	LTD (KZ1000K1/ K2)	1981/1982	065185	YTX20HL-BS■	—	—	—	—
1000	Z (KZ1000A1/ A2/ A3/ A4)	1977/1980	0651434	YB14L-A2	0681434	ESB14L-A2■	—	—
1000	Z (KZ1000J1/ J3)	1981/1983	0650202	GYZ20HL▲	—	—	—	—
1000	Z (KZ1000J1/ J3)	1981/1983	0651834	YB18L-A	0681834	ESB18L-A■	—	—
1000	Z (KZ1000J1/ J3)	1981/1983	065185	YTX20HL-BS■	—	—	—	—
1000	Z (ZRT00AAA-A1H>A3H/ A6F)	2003/2006	0650990	YTX9-BS■	068099	ESTX9-BS■	063099	FTX9-BS■
1000	Z (ZRT00BBA-B7F>B9F)	2007/2009	0650990	YTX9-BS■	068099	ESTX9-BS■	063099	FTX9-BS■
1000	Z (ZRT00DDA-DAF>DDFA)	2010/2013	0650990	YTX9-BS■	068099	ESTX9-BS■	063099	FTX9-BS■
1000	Z (ZRT00DDA-DAF>DDFA)	2014/2016	0651110	YT12A-BS■	0681110	EST12A-BS■	—	—
1000	Z ABS (ZRT00BCA-C7F>C9F)	2007/2009	0650990	YTX9-BS■	068099	ESTX9-BS■	063099	FTX9-BS■
1000	Z ABS (ZRT00DEA-EAF>FEFA)	2010/2013	0650990	YTX9-BS■	068099	ESTX9-BS■	063099	FTX9-BS■
1000	Z ABS (ZRT00DEA-EAF>FEFA)	2014/2016	0651110	YT12A-BS■	0681110	EST12A-BS■	—	—
1000	Z ABS (ZRT00DEA-EAF>FEFA)	2017/2017	0650990	YTX9-BS■	068099	ESTX9-BS■	063099	FTX9-BS■
1000	Z Classic F.I. (1)(KZ1000G)	1980/1980	0651434	YB14L-A2	0681434	ESB14L-A2■	—	—
1000	Z F.I. (1)(KZ1000H)	1980/1980	065123	YTX14AHL-BS■	—	—	—	—
1000	Z F.I. (1)(KZ1000H)	1980/1980	0651433	12N14-3A	—	—	—	—
1000	Z F.I. (1)(KZ1000H)	1980/1980	0651439	YB14L-B2	0681439	ESB14L-B2■	—	—
1000	Z Police (1>24)(KZ1000P)	1978/1981	0651434	YB14L-A2	0681434	ESB14L-A2■	—	—
1000	Z Police (1>24)(KZ1000P)	1982/1986	0650202	GYZ20HL▲	—	—	—	—
1000	Z Police (1>24)(KZ1000P)	1982/1986	0651834	YB18L-A	0681834	ESB18L-A■	—	—
1000	Z Police (1>24)(KZ1000P)	1982/1986	065185	YTX20HL-BS■	—	—	—	—
1000	Z Police (1>24)(KZ1000P)	2002/2005	0650202	GYZ20HL▲	—	—	—	—
1000	Z Police (1>24)(KZ1000P)	2002/2005	065185	YTX20HL-BS■	—	—	—	—
1000	Z R (1/ 2)(KZ1000R)	1982/1983	0650202	GYZ20HL▲	—	—	—	—
1000	Z R (1/ 2)(KZ1000R)	1982/1983	0651834	YB18L-A	0681834	ESB18L-A■	—	—
1000	Z R (1/ 2)(KZ1000R)	1982/1983	065185	YTX20HL-BS■	—	—	—	—
1000	Z R (JHF)(ZRT00HJA)	2017/2017	0650990	YTX9-BS■	068099	ESTX9-BS■	063099	FTX9-BS■
1000	Z ST Shaft (E1/ E2)(KZ1000)	1979/1980	0650202	GYZ20HL▲	—	—	—	—
1000	Z ST Shaft (E1/ E2)(KZ1000)	1979/1980	0651636	YB16L-B	0681636	ESB16L-B■	—	—
1000	Z ST Shaft (E1/ E2)(KZ1000)	1979/1980	065185	YTX20HL-BS■	—	—	—	—
1000	Z SX (GBF/ GCF/ GDF)(ZXT00GGA)	2011/2013	0650990	YTX9-BS■	068099	ESTX9-BS■	063099	FTX9-BS■
1000	Z SX (LEF/ LFF/ LGF)(ZXT00LLA)	2014/2016	0651110	YT12A-BS■	0681110	EST12A-BS■	—	—
1000	Z SX ABS (HBF/ HCF/ HDF)(ZXT00GHA)	2011/2013	0650990	YTX9-BS■	068099	ESTX9-BS■	063099	FTX9-BS■
1000	Z SX ABS (MEF/ MFF/ MGF)(ZXT00LMA)	2014/2016	0651110	YT12A-BS■	0681110	EST12A-BS■	—	—
1000	Z SX ABS (WHF)(ZXT00WWA)	2017/2017	0650990	YTX9-BS■	068099	ESTX9-BS■	063099	FTX9-BS■
1000	Z Z1-R (D1/ D2/ D3)(KZ1000)	1978/1980	0651434	YB14L-A2	0681434	ESB14L-A2■	—	—
1000	ZL Eliminator (A1)(ZL1000)	1987/1987	0651434	YB14L-A2	0681434	ESB14L-A2■	—	—

▲ - Factory Sealed / Attivata dalla Fabbrica ■ - con Acido a corredo ◇ - Non di produzione YUASA a completamento gamma

Marca / Cilindrata / Modello / Anno			Cod. SGR		Cod. SGR		Cod. SGR		
KAWASAKI									
1000	ZX10 Tomcat Ninja (B1/ B2/ B3)(ZX1000)	1988/1990	0651434	YB14L-A2	0681434	ESB14L-A2■	—	—	
1000	ZX10R Ninja (C1H/ C2H) (ZXT00CCA)	2004/2005	0651100	YT12B-BS■	0681100	EST12B-BS■	—	—	
1000	ZX10R Ninja (D6F)(ZXT00DDA)	2006/2006	0651100	YT12B-BS■	0681100	EST12B-BS■	—	—	
1000	ZX10R Ninja (D7F)(ZXT00DDA)	2007/2007	0651100	YT12B-BS■	0681100	EST12B-BS■	—	—	
1000	ZX10R Ninja (E8F/ E9F) (ZXT00DEA)	2008/2009	0651100	YT12B-BS■	0681100	EST12B-BS■	—	—	
1000	ZX10R Ninja (FAF)(ZXT00FFA)	2010/2010	0651100	YT12B-BS■	0681100	EST12B-BS■	—	—	
1000	ZX10R Ninja (JBF>JFF) (ZXT00JJA)	2011/2015	065007	YTZ7S▲	—	—	063007	FTZ7S▲	
1000	ZX10R Ninja ABS (KBF>KFF) (ZXT00JKA)	2011/2015	065010	YTZ10S▲	—	—	063010	FTZ10S▲	
1000	ZX10R Ninja ABS (SHF)(ZXT00SSA)	2016/2017	065010	YTZ10S▲	—	—	063010	FTZ10S▲	
1000	ZX10R Ninja ABS (ZHF)(ZXT00SZA)	2017/2017	065010	YTZ10S▲	—	—	063010	FTZ10S▲	
1100	GPZ (KZ1100B1)	1981/1981	0650202	GYZ20HL▲	—	—	—	—	
1100	GPZ (KZ1100B1)	1981/1981	0651636	YB16L-B	0681636	ESB16L-B■	—	—	
1100	GPZ (KZ1100B1)	1981/1981	065185	YTX20HL-BS■	—	—	—	—	
1100	GPZ (KZ1100B2)	1982/1982	0650202	GYZ20HL▲	—	—	—	—	
1100	GPZ (KZ1100B2)	1982/1982	0651636	YB16L-B	0681636	ESB16L-B■	—	—	
1100	GPZ (KZ1100B2)	1982/1982	065185	YTX20HL-BS■	—	—	—	—	
1100	GPZ (ZX1100A1/ A2/ A3)	1983/1985	0650202	GYZ20HL▲	—	—	—	—	
1100	GPZ (ZX1100A1/ A2/ A3)	1983/1985	0651636	YB16L-B	0681636	ESB16L-B■	—	—	
1100	GPZ (ZX1100A1/ A2/ A3)	1983/1985	065185	YTX20HL-BS■	—	—	—	—	
1100	GPZ (ZX1100E1/ E2/ E3)	1995/1997	065124	YTX14H-BS■	—	—	—	—	
1100	GPZ (ZX1100E1/ E2/ E3)	1995/1997	065129	YTX14-BS■	068129	ESTX14-BS■	—	—	
1100	GPZ ABS (ZX1100F1)	1996/1997	065124	YTX14H-BS■	—	—	—	—	
1100	GPZ ABS (ZX1100F1)	1996/1997	065129	YTX14-BS■	068129	ESTX14-BS■	—	—	
1100	JH B Ultra 130	2001/2004	0650202	GYZ20HL▲	—	—	—	—	
1100	JH B Ultra 130	2001/2004	065185	YTX20HL-BS■	—	—	—	—	
1100	JH ZXi	1996/2002	0650202	GYZ20HL▲	—	—	—	—	
1100	JH ZXi	1996/2002	065185	YTX20HL-BS■	—	—	—	—	
1100	JT STX	1997/2002	0650202	GYZ20HL▲	—	—	—	—	
1100	JT STX	1997/2002	065185	YTX20HL-BS■	—	—	—	—	
1100	LTD Shaft (KZ1100L1)	1983/1983	0650202	GYZ20HL▲	—	—	—	—	
1100	LTD Shaft (KZ1100L1)	1983/1983	0651834	YB18L-A	0681834	ESB18L-A■	—	—	
1100	LTD Shaft (KZ1100L1)	1983/1983	065185	YTX20HL-BS■	—	—	—	—	
1100	LTD Shaft (ZNI100B1/ B2)	1984/1985	065123	YTX14AHL-BS■	—	—	—	—	
1100	LTD Shaft (ZNI100B1/ B2)	1984/1985	0651439	YB14L-B2	0681439	ESB14L-B2■	—	—	
1100	Spectre (KZ1100D1/ D2)	1982/1983	0650202	GYZ20HL▲	—	—	—	—	
1100	Spectre (KZ1100D1/ D2)	1982/1983	0651834	YB18L-A	0681834	ESB18L-A■	—	—	
1100	Spectre (KZ1100D1/ D2)	1982/1983	065185	YTX20HL-BS■	—	—	—	—	
1100	Z R (KZ1100R1/ R2)	1984/1985	0650202	GYZ20HL▲	—	—	—	—	
1100	Z R (KZ1100R1/ R2)	1984/1985	0651834	YB18L-A	0681834	ESB18L-A■	—	—	
1100	Z R (KZ1100R1/ R2)	1984/1985	065185	YTX20HL-BS■	—	—	—	—	
1100	Z Shaft (KZ1100A1/ A2/ A3)	1981/1983	0650202	GYZ20HL▲	—	—	—	—	



▲ - Factory Sealed / Attivata dalla Fabbrica ■ - con Acido a corredo ◇ - Non di produzione YUASA a completamento gamma

Marca / Cilindrata / Modello / Anno			Cod. SGR		Cod. SGR		Cod. SGR	
KAWASAKI								
1100	Z Shaft (KZ1100A1/ A2/ A3)	1981/1983	0651834	YB18L-A	0681834	ESB18L-A■	—	—
1100	Z Shaft (KZ1100A1/ A2/ A3)	1981/1983	065185	YTX20HL-BS■	—	—	—	—
1100	ZR Zephyr (ZR1100A1/ A2/ A3/ A4)	1992/1995	065168	YTX16-BS■	068168	ESTX16-BS■	—	—
1100	ZR Zephyr (ZR1100B1/ B2/ B3)	1996/1998	065168	YTX16-BS■	068168	ESTX16-BS■	—	—
1100	ZRX (ZR_D1/ D3/ C3)	1996/2000	065124	YTX14H-BS■	—	—	—	—
1100	ZRX (ZR_D1/ D3/ C3)	1996/2000	065129	YTX14-BS■	068129	ESTX14-BS■	—	—
1100	ZZR Ninja / ZX11 (ZXT_C/ D)	1990/1992	065123	YTX14AHL-BS■	—	—	—	—
1100	ZZR Ninja / ZX11 (ZXT_C/ D)	1990/1992	0651434	YB14L-A2	0681434	ESB14L-A2■	—	—
1100	ZZR Ninja / ZX11 (ZXT_C/ D)	1993/2001	065124	YTX14H-BS■	—	—	—	—
1100	ZZR Ninja / ZX11 (ZXT_C/ D)	1993/2001	065129	YTX14-BS■	068129	ESTX14-BS■	—	—
1200	JH A Ultra 150	1999/2004	0650202	GYZ20HL▲	—	—	—	—
1200	JH A Ultra 150	1999/2004	065185	YTX20HL-BS■	—	—	—	—
1200	JT A, B STXR, STX12F	2002/2004	0650202	GYZ20HL▲	—	—	—	—
1200	JT A, B STXR, STX12F	2002/2004	065185	YTX20HL-BS■	—	—	—	—
1200	ZG Voyager XIII	1986/2003	0652035	SY50-N18L-AT	—	—	—	—
1200	ZG Voyager XIII	1986/2003	065215	YTX24HL-BS■	—	—	—	—
1200	ZRX	2001/2004	065124	YTX14H-BS■	—	—	—	—
1200	ZRX	2001/2004	065129	YTX14-BS■	068129	ESTX14-BS■	—	—
1200	ZRX R	2001/2006	065124	YTX14H-BS■	—	—	—	—
1200	ZRX R	2001/2006	065129	YTX14-BS■	068129	ESTX14-BS■	—	—
1200	ZRX S	2001/2005	065124	YTX14H-BS■	—	—	—	—
1200	ZRX S	2001/2005	065129	YTX14-BS■	068129	ESTX14-BS■	—	—
1200	ZX12R Ninja	2000/2006	065124	YTX14H-BS■	—	—	—	—
1200	ZX12R Ninja	2000/2006	065129	YTX14-BS■	068129	ESTX14-BS■	—	—
1200	ZZR	2002/2005	065124	YTX14H-BS■	—	—	—	—
1200	ZZR	2002/2005	065129	YTX14-BS■	068129	ESTX14-BS■	—	—
1300	Z KZ A	1978/1979	0651439	YB14L-B2	0681439	ESB14L-B2■	—	—
1300	Z KZ A	1979/1982	0652034	Y50-N18L-A	0682034	ES50-N18L-A■	—	—
1300	Z KZ A	1979/1982	065215	YTX24HL-BS■	—	—	—	—
1300	ZN Voyager	1984/1989	0652034	Y50-N18L-A	0682034	ES50-N18L-A■	—	—
1300	ZN Voyager	1984/1989	065215	YTX24HL-BS■	—	—	—	—
1400	GTR (ZG)	2008/2014	065014	YTZ14S▲	—	—	—	—
1400	GTR (ZG)	2008/2014	065914	TTZ14S-BS	068914	ESTTZ14S-BS■	—	—
1400	ZZR / ZZR ABS (A6F>FDFA)	2006/2014	065014	YTZ14S▲	—	—	—	—
1400	ZZR / ZZR ABS (A6F>FDFA)	2006/2014	065914	TTZ14S-BS	068914	ESTTZ14S-BS■	—	—
1500	JT A, C STX15F	2006/2006	0650202	GYZ20HL▲	—	—	—	—
1500	JT A, C STX15F	2006/2006	065185	YTX20HL-BS■	—	—	—	—
1500	VN Vulcan (A10>A13)	1996/1999	065168	YTX16-BS■	068168	ESTX16-BS■	—	—
1500	VN Vulcan 88 (A1>A9)	1987/1995	0652034	Y50-N18L-A	0682034	ES50-N18L-A■	—	—
1500	VN Vulcan 88 (A1>A9)	1987/1995	065215	YTX24HL-BS■	—	—	—	—
1500	VN Vulcan 88 SE (B1>B4)	1987/1990	0652034	Y50-N18L-A	0682034	ES50-N18L-A■	—	—



▲ - Factory Sealed / Attivata dalla Fabbrica ■ - con Acido a corredo ◇ - Non di produzione YUASA a completamento gamma

Marca / Cilindrata / Modello / Anno			Cod. SGR		Cod. SGR		Cod. SGR	
KAWASAKI								
1500	VN Vulcan 88 SE (B1>B4)	1987/1990	065215	YTX24HL-BS ■	—	—	—	—
1500	VN Vulcan Classic (D1/ D2/ E1/ E2)	1996/1999	065187	YTX20CH-BS ■	068187	ESTX20CH-BS ■	—	—
1500	VN Vulcan Classic FI (N1H>N3H)	2000/2003	065187	YTX20CH-BS ■	068187	ESTX20CH-BS ■	—	—
1500	VN Vulcan Classic Tourer/ FI (G1/ G2/ L1H/ L2H/ L4H)	1998/1999	065187	YTX20CH-BS ■	068187	ESTX20CH-BS ■	—	—
1500	VN Vulcan Drifter/ FI (J1/ J2/ R1>R5)	1999/2005	065187	YTX20CH-BS ■	068187	ESTX20CH-BS ■	—	—
1500	VN Vulcan L (C3/ C4)	1996/1997	0652034	Y50-N18L-A	0682034	ES50-N18L-A ■	—	—
1500	VN Vulcan L (C3/ C4)	1996/1997	065215	YTX24HL-BS ■	—	—	—	—
1500	VN Vulcan Main Streak (P1H>P4H)	2002/2005	065187	YTX20CH-BS ■	068187	ESTX20CH-BS ■	—	—
1500	VN Vulcan Nomad FI	2000/2004	065187	YTX20CH-BS ■	068187	ESTX20CH-BS ■	—	—
1600	VN Vulcan Classic	2003/2008	065187	YTX20CH-BS ■	068187	ESTX20CH-BS ■	—	—
1600	VN Vulcan Mean Streak	2004/2007	065187	YTX20CH-BS ■	068187	ESTX20CH-BS ■	—	—
1600	VN Vulcan Nomad FI	2004/2008	065187	YTX20CH-BS ■	068187	ESTX20CH-BS ■	—	—
1700	VN Voyager Custom	2011/2014	065187	YTX20CH-BS ■	068187	ESTX20CH-BS ■	—	—
1700	VN Vulcan Classic	2009/2013	065187	YTX20CH-BS ■	068187	ESTX20CH-BS ■	—	—
1700	VN Vulcan Classic Tourer	2009/2013	065187	YTX20CH-BS ■	068187	ESTX20CH-BS ■	—	—
1700	VN Vulcan Nomad	2009/2012	065187	YTX20CH-BS ■	068187	ESTX20CH-BS ■	—	—
1700	VN Vulcan Voyager	2009/2013	065187	YTX20CH-BS ■	068187	ESTX20CH-BS ■	—	—
2000	VN Vulcan / Classic (VNW00AAA/ VNW00HHA-A1H/ A2H/ A6F/ H8F/ H9F/ H)	2004/2010	065187	YTX20CH-BS ■	068187	ESTX20CH-BS ■	—	—
KEEWAY								
50	EC2	2006/2006	0650390	YTX4L-BS ■	068039	ESTX4L-BS ■	—	—
50	F-ACT	2007/2008	065049	YTX5L-BS ■	068049	ESTX5L-BS ■	063049	FTX5L-BS ■
50	F-ACT Racing	2008/2008	065049	YTX5L-BS ■	068049	ESTX5L-BS ■	063049	FTX5L-BS ■
50	Focus	2006/2006	065049	YTX5L-BS ■	068049	ESTX5L-BS ■	063049	FTX5L-BS ■
50	Hurricane	2007/2008	065049	YTX5L-BS ■	068049	ESTX5L-BS ■	063049	FTX5L-BS ■
50	Matrix	2006/2008	065049	YTX5L-BS ■	068049	ESTX5L-BS ■	063049	FTX5L-BS ■
50	Off Road	2007/2008	0650390	YTX4L-BS ■	068039	ESTX4L-BS ■	—	—
50	RY8/ SP	2006/2008	065049	YTX5L-BS ■	068049	ESTX5L-BS ■	063049	FTX5L-BS ■
125	ARN	2006/2008	0650700	YTX7A-BS ■	068070	ESTX7A-BS ■	—	—
125	Speed	2006/2007	—	—	—	—	—	—
125	Superlight	2006/2006	0650700	YTX7A-BS ■	068070	ESTX7A-BS ■	—	—
150	ARN	2006/2007	0650700	YTX7A-BS ■	068070	ESTX7A-BS ■	—	—
150	Speed	2006/2006	—	—	—	—	—	—
150	Superlight	2006/2006	0650700	YTX7A-BS ■	068070	ESTX7A-BS ■	—	—
250	Landcruiser	2007/2007	0650700	YTX7A-BS ■	068070	ESTX7A-BS ■	—	—
250	Supershadow (QJ250)	2006/2006	0650700	YTX7A-BS ■	068070	ESTX7A-BS ■	—	—
KL-SHELUNG								
50	Club	TUTTI	0650390	YTX4L-BS ■	068039	ESTX4L-BS ■	—	—
50	Racer	TUTTI	0650390	YTX4L-BS ■	068039	ESTX4L-BS ■	—	—
KTM								
50	Go/ Go Crono	TUTTI	0650390	YTX4L-BS ■	068039	ESTX4L-BS ■	—	—
50	Kross	TUTTI	06504340	YB4L-B	—	—	—	—



▲ - Factory Sealed / Attivata dalla Fabbrica ■ - con Acido a corredo ◇ - Non di produzione YUASA a completamento gamma

Marca / Cilindrata / Modello / Anno			Cod. SGR		Cod. SGR		Cod. SGR	
KTM								
50	Kross	TUTTI	065043410	YB4L-B■	0680434	ESB4L-B■	—	—
80	Chopper	1981/>	—	—	—	—	—	—
80	RLW/ RSL	1980/>	—	—	—	—	—	—
125	Duke 4T	2010/2016	065007	YTZ7S▲	—	—	063007	FTZ7S▲
125	Duke 4T	2010/2016	065907	TTZ7S▲	068907	ESTTZ7S-BS■	—	—
125	LC2	1996/1997	0650390	YTX4L-BS■	068039	ESTX4L-BS■	—	—
125	RC 4T	2013/2016	0650990	YTX9-BS■	068099	ESTX9-BS■	063099	FTX9-BS■
125	Sting	1997/1998	0650390	YTX4L-BS■	068039	ESTX4L-BS■	—	—
200	Duke 4T	2010/2016	0650990	YTX9-BS■	068099	ESTX9-BS■	063099	FTX9-BS■
200	EXC 2T	2013/2016	0650390	YTX4L-BS■	068039	ESTX4L-BS■	—	—
200	RC 4T	2015/2016	0650990	YTX9-BS■	068099	ESTX9-BS■	063099	FTX9-BS■
250	EXC 2T	2008/2016	0650390	YTX4L-BS■	068039	ESTX4L-BS■	—	—
250	EXC F 4T	2007/2016	065049	YTX5L-BS■	068049	ESTX5L-BS■	063049	FTX5L-BS■
250	EXC Racing 4T	2003/2004	065005	YTZ5S■	—	—	—	—
250	EXC Racing 4T	2005/2006	065049	YTX5L-BS■	068049	ESTX5L-BS■	063049	FTX5L-BS■
250	SXF 4T	2012/2015	0650390	YTX4L-BS■	068039	ESTX4L-BS■	—	—
300	EXC 2T	2008/2016	0650390	YTX4L-BS■	068039	ESTX4L-BS■	—	—
350	EXC F 4T	2011/2016	0650390	YTX4L-BS■	068039	ESTX4L-BS■	—	—
350	Freeride	2011/2017	065049	YTX5L-BS■	068049	ESTX5L-BS■	063049	FTX5L-BS■
350	SXF 4T	2010/2015	0650390	YTX4L-BS■	068039	ESTX4L-BS■	—	—
390	Duke 4T	2013/2016	0650990	YTX9-BS■	068099	ESTX9-BS■	063099	FTX9-BS■
390	RC 4T	2015/2016	0650990	YTX9-BS■	068099	ESTX9-BS■	063099	FTX9-BS■
400	EXC R 4T	2009/2011	065049	YTX5L-BS■	068049	ESTX5L-BS■	063049	FTX5L-BS■
400	LC4 EGS 4T	1998/2001	0650990	YTX9-BS■	068099	ESTX9-BS■	063099	FTX9-BS■
400	LC4 EXC Racing 4T	2003/2004	065005	YTZ5S■	—	—	—	—
400	LC4 EXC Racing 4T	2005/2008	065049	YTX5L-BS■	068049	ESTX5L-BS■	063049	FTX5L-BS■
400	LC4 LSE 4T	1997/1997	0650990	YTX9-BS■	068099	ESTX9-BS■	063099	FTX9-BS■
450	EXC 4T	2003/2004	065005	YTZ5S■	—	—	—	—
450	EXC 4T	2005/2007	065049	YTX5L-BS■	068049	ESTX5L-BS■	063049	FTX5L-BS■
450	EXC R 4T	2008/2016	065049	YTX5L-BS■	068049	ESTX5L-BS■	063049	FTX5L-BS■
450	MXC 4T racing	2000/>	065049	YTX5L-BS■	068049	ESTX5L-BS■	063049	FTX5L-BS■
450	MXC 4T racing	2004/2004	065005	YTZ5S■	—	—	—	—
450	SMR 4T	2008/2011	0650390	YTX4L-BS■	068039	ESTX4L-BS■	—	—
450	SMR 4T	2008/2011	065049	YTX5L-BS■	068049	ESTX5L-BS■	063049	FTX5L-BS■
450	SMR 4T	2012/2014	0650390	YTX4L-BS■	068039	ESTX4L-BS■	—	—
450	SXF 4T	2007/2007	0650390	YTX4L-BS■	068039	ESTX4L-BS■	—	—
450	SXF 4T	2007/2010	065049	YTX5L-BS■	068049	ESTX5L-BS■	063049	FTX5L-BS■
450	SXF 4T	2011/2015	0650390	YTX4L-BS■	068039	ESTX4L-BS■	—	—
450	SXF ATV	2009/2012	065049	YTX5L-BS■	068049	ESTX5L-BS■	063049	FTX5L-BS■
450	SXS 4T	2003/2003	065005	YTZ5S■	—	—	—	—
450	SXS 4T	2005/2007	065049	YTX5L-BS■	068049	ESTX5L-BS■	063049	FTX5L-BS■



▲ - Factory Sealed / Attivata dalla Fabbrica ■ - con Acido a corredo ◇ - Non di produzione YUASA a completamento gamma

Marca / Cilindrata / Modello / Anno			Cod. SGR		Cod. SGR		Cod. SGR	
KTM								
450	XC Sport Atv	2008/2009	065049	YTX5L-BS■	068049	ESTX5L-BS■	063049	FTX5L-BS■
500	EXC 4T	2012/2016	065049	YTX5L-BS■	068049	ESTX5L-BS■	063049	FTX5L-BS■
500	K4 4T (Rotax)	1982/1986	06509350	YB9-B	0680935	ESB9-B■	—	—
505	SXF 4T	2007/2009	0650390	YTX4L-BS■	068039	ESTX4L-BS■	—	—
505	SXF 4T	2007/2009	065049	YTX5L-BS■	068049	ESTX5L-BS■	063049	FTX5L-BS■
505	SXF ATV	2009/2012	065049	YTX5L-BS■	068049	ESTX5L-BS■	063049	FTX5L-BS■
520	EXC 4T	2000/2002	065049	YTX5L-BS■	068049	ESTX5L-BS■	063049	FTX5L-BS■
525	EXC 4T	2003/2004	065005	YTZ5S■	—	—	—	—
525	EXC 4T	2005/2007	065049	YTX5L-BS■	068049	ESTX5L-BS■	063049	FTX5L-BS■
525	MXC 4T	2003/2004	065005	YTZ5S■	—	—	—	—
525	SX 4T	2004/2004	065005	YTZ5S■	—	—	—	—
525	XC Sport Atv	2008/2012	065049	YTX5L-BS■	068049	ESTX5L-BS■	063049	FTX5L-BS■
530	EXC R 4T	2008/2010	0650390	YTX4L-BS■	068039	ESTX4L-BS■	—	—
530	EXC R 4T	2008/2010	065049	YTX5L-BS■	068049	ESTX5L-BS■	063049	FTX5L-BS■
540	SXS 4T	2003/2003	065049	YTX5L-BS■	068049	ESTX5L-BS■	063049	FTX5L-BS■
550	LC4	1987/>	—	—	—	—	—	—
620	Duke	1996/1998	0650990	YTX9-BS■	068099	ESTX9-BS■	063099	FTX9-BS■
620	LC4 EGS E Adventure 4T	1997/1998	0650990	YTX9-BS■	068099	ESTX9-BS■	063099	FTX9-BS■
620	LC4 SC 4T Supercompetition	1998/1999	0650990	YTX9-BS■	068099	ESTX9-BS■	063099	FTX9-BS■
620	LC4 Supermoto 4T	1998/1999	0650990	YTX9-BS■	068099	ESTX9-BS■	063099	FTX9-BS■
625	LC4 SC Supermoto 4T	2004/2004	065010	YTZ10S▲	—	—	063010	FTZ10S▲
625	LC4 SC Supermoto 4T	2004/2004	065910	TTZ10S-BS	068910	ESTTZ10S-BS■	—	—
625	LC4 SMC Supermoto 4T	2005/2007	065010	YTZ10S▲	—	—	063010	FTZ10S▲
625	LC4 SMC Supermoto 4T	2005/2007	065910	TTZ10S-BS	068910	ESTTZ10S-BS■	—	—
640	Duke / Duke 2	1999/2006	0650990	YTX9-BS■	068099	ESTX9-BS■	063099	FTX9-BS■
640	LC4 Adventure	1998/2002	0650990	YTX9-BS■	068099	ESTX9-BS■	063099	FTX9-BS■
640	LC4 Adventure	2003/2007	065010	YTZ10S▲	—	—	063010	FTZ10S▲
640	LC4 Adventure	2003/2007	065910	TTZ10S-BS	068910	ESTTZ10S-BS■	—	—
640	LC4 E Enduro	1998/2006	0650990	YTX9-BS■	068099	ESTX9-BS■	063099	FTX9-BS■
640	LC4 E Supermoto	1999/2005	065010	YTZ10S▲	—	—	063010	FTZ10S▲
640	LC4 E Supermoto	1999/2005	065910	TTZ10S-BS	068910	ESTTZ10S-BS■	—	—
690	EXC Enduro / Enduro R 4T	2008/2013	065010	YTZ10S▲	—	—	063010	FTZ10S▲
690	EXC Enduro / Enduro R 4T	2008/2013	065910	TTZ10S-BS	068910	ESTTZ10S-BS■	—	—
690	LC4 Duke	2008/2012	065010	YTZ10S▲	—	—	063010	FTZ10S▲
690	LC4 Duke	2008/2012	065910	TTZ10S-BS	068910	ESTTZ10S-BS■	—	—
690	LC4 Duke	2013/2015	0650990	YTX9-BS■	068099	ESTX9-BS■	063099	FTX9-BS■
690	LC4 Duke R	2010/2012	065010	YTZ10S▲	—	—	063010	FTZ10S▲
690	LC4 Duke R	2010/2012	065910	TTZ10S-BS	068910	ESTTZ10S-BS■	—	—
690	LC4 Duke R	2013/2015	0650990	YTX9-BS■	068099	ESTX9-BS■	063099	FTX9-BS■
690	RFR Rallye Factory Replica	2007/2010	065010	YTZ10S▲	—	—	063010	FTZ10S▲
690	RFR Rallye Factory Replica	2007/2010	065910	TTZ10S-BS	068910	ESTTZ10S-BS■	—	—



▲ - Factory Sealed / Attivata dalla Fabbrica ■ - con Acido a corredo ◇ - Non di produzione YUASA a completamento gamma

Marca / Cilindrata / Modello / Anno			Cod. SGR		Cod. SGR		Cod. SGR		
KTM									
690	SM Supermoto	2007/2009	065010	YTZ10S▲	—	—	063010	FTZ10S▲	
690	SM Supermoto	2007/2009	065910	TTZ10S-BS	068910	ESTTZ10S-BS■	—	—	
690	SMC R 4T	2008/2015	065010	YTZ10S▲	—	—	063010	FTZ10S▲	
690	SMC R 4T	2008/2015	065910	TTZ10S-BS	068910	ESTTZ10S-BS■	—	—	
690	SMR Supermoto	2008/2012	065010	YTZ10S▲	—	—	063010	FTZ10S▲	
690	SMR Supermoto	2008/2012	065910	TTZ10S-BS	068910	ESTTZ10S-BS■	—	—	
950	LC8 Adventure / Adventure S	2002/2006	065014	YTZ14S▲	—	—	—	—	
950	LC8 Adventure / Adventure S	2002/2006	065914	TTZ14S-BS	068914	ESTTZ14S-BS■	—	—	
950	LC8 Rallye	2002/2003	065014	YTZ14S▲	—	—	—	—	
950	LC8 Rallye	2002/2003	065914	TTZ14S-BS	068914	ESTTZ14S-BS■	—	—	
950	LC8 Super Enduro R	2006/2008	065014	YTZ14S▲	—	—	—	—	
950	LC8 Super Enduro R	2006/2008	065914	TTZ14S-BS	068914	ESTTZ14S-BS■	—	—	
950	LC8 Supermoto	2005/2007	065014	YTZ14S▲	—	—	—	—	
950	LC8 Supermoto	2005/2007	065914	TTZ14S-BS	068914	ESTTZ14S-BS■	—	—	
950	LC8 Supermoto R	2007/2008	065014	YTZ14S▲	—	—	—	—	
950	LC8 Supermoto R	2007/2008	065914	TTZ14S-BS	068914	ESTTZ14S-BS■	—	—	
990	Adventure	2006/2013	065014	YTZ14S▲	—	—	—	—	
990	Adventure	2006/2013	065914	TTZ14S-BS	068914	ESTTZ14S-BS■	—	—	
990	Adventure R	2009/2013	065014	YTZ14S▲	—	—	—	—	
990	Adventure R	2009/2013	065914	TTZ14S-BS	068914	ESTTZ14S-BS■	—	—	
990	Adventure S	2006/2008	065014	YTZ14S▲	—	—	—	—	
990	Adventure S	2006/2008	065914	TTZ14S-BS	068914	ESTTZ14S-BS■	—	—	
990	Super Duke / R	2005/2013	065014	YTZ14S▲	—	—	—	—	
990	Super Duke / R	2005/2013	065914	TTZ14S-BS	068914	ESTTZ14S-BS■	—	—	
990	Supermoto / T	2007/2013	065014	YTZ14S▲	—	—	—	—	
990	Supermoto / T	2007/2013	065914	TTZ14S-BS	068914	ESTTZ14S-BS■	—	—	
990	Supermoto R	2008/2014	065014	YTZ14S▲	—	—	—	—	
990	Supermoto R	2008/2014	065914	TTZ14S-BS	068914	ESTTZ14S-BS■	—	—	
1050	Adventure ABS	2015/2016	065014	YTZ14S▲	—	—	—	—	
1190	Adventure ABS	2013/2015	065014	YTZ14S▲	—	—	—	—	
1190	Adventure R ABS	2013/2015	065014	YTZ14S▲	—	—	—	—	
1190	RC8	2008/2011	065014	YTZ14S▲	—	—	—	—	
1190	RC8	2008/2011	065914	TTZ14S-BS	068914	ESTTZ14S-BS■	—	—	
1190	RC8 R	2010/2015	065014	YTZ14S▲	—	—	—	—	
1190	RC8 R	2010/2015	065914	TTZ14S-BS	068914	ESTTZ14S-BS■	—	—	
1290	Super Adventure	2015/2015	065014	YTZ14S▲	—	—	—	—	
1290	Super Duke R	2013/2015	065124	YTX14H-BS■	—	—	—	—	
1290	Super Duke R	2013/2015	065129	YTX14-BS■	068129	ESTX14-BS■	—	—	
KYMCO									
50	Agility 2T R16	2010/2013	0650700	YTX7A-BS■	068070	ESTX7A-BS■	—	—	
50	Agility 2T RS Naked R12	2010/2013	0650700	YTX7A-BS■	068070	ESTX7A-BS■	—	—	



▲ - Factory Sealed / Attivata dalla Fabbrica ■ - con Acido a corredo ◇ - Non di produzione YUASA a completamento gamma

Marca / Cilindrata / Modello / Anno		Cod. SGR		Cod. SGR		Cod. SGR	
KYMCO							
50	Agility 4T Carry	2011/2013	0650700	YTX7A-BS ■	068070	ESTX7A-BS ■	— —
50	Agility 4T R10	2005/2013	065049	YTX5L-BS ■	068049	ESTX5L-BS ■	063049 FTX5L-BS ■
50	Agility 4T R12	2007/2013	065049	YTX5L-BS ■	068049	ESTX5L-BS ■	063049 FTX5L-BS ■
50	Agility 4T R16	2008/2013	0650700	YTX7A-BS ■	068070	ESTX7A-BS ■	— —
50	Agility 4T RS R12	2008/2013	0650700	YTX7A-BS ■	068070	ESTX7A-BS ■	— —
50	Bet & Win / Bet & Win E2	2002/2007	0650390	YTX4L-BS ■	068039	ESTX4L-BS ■	— —
50	CX	1993/1993	0650390	YTX4L-BS ■	068039	ESTX4L-BS ■	— —
50	CX Super	1994/1997	0650390	YTX4L-BS ■	068039	ESTX4L-BS ■	— —
50	Dink 4T	2007/2013	065049	YTX5L-BS ■	068049	ESTX5L-BS ■	063049 FTX5L-BS ■
50	Dink AIR 2T	1999/2002	065049	YTX5L-BS ■	068049	ESTX5L-BS ■	063049 FTX5L-BS ■
50	Dink Classic AIR 2T Euro 2	2003/2007	065049	YTX5L-BS ■	068049	ESTX5L-BS ■	063049 FTX5L-BS ■
50	Dink LC	1999/2002	065049	YTX5L-BS ■	068049	ESTX5L-BS ■	063049 FTX5L-BS ■
50	DJ	1991/2000	0650390	YTX4L-BS ■	068039	ESTX4L-BS ■	— —
50	Fever ZX / E2	2000/2005	065049	YTX5L-BS ■	068049	ESTX5L-BS ■	063049 FTX5L-BS ■
50	Filly 4T TT	1998/2000	065049	YTX5L-BS ■	068049	ESTX5L-BS ■	063049 FTX5L-BS ■
50	Grand Dink 2T	2005/2012	0650390	YTX4L-BS ■	068039	ESTX4L-BS ■	— —
50	Heroism	1995/1997	0650390	YTX4L-BS ■	068039	ESTX4L-BS ■	— —
50	K12	1995/2000	0650390	YTX4L-BS ■	068039	ESTX4L-BS ■	— —
50	KB	1995/2000	0650390	YTX4L-BS ■	068039	ESTX4L-BS ■	— —
50	KXR	2004/>	065049	YTX5L-BS ■	068049	ESTX5L-BS ■	063049 FTX5L-BS ■
50	Like 2T	2009/2013	0650700	YTX7A-BS ■	068070	ESTX7A-BS ■	— —
50	Like 4T	2009/2015	0650700	YTX7A-BS ■	068070	ESTX7A-BS ■	— —
50	MAXXER/ Mongoose	2005/2010	065049	YTX5L-BS ■	068049	ESTX5L-BS ■	063049 FTX5L-BS ■
50	MXER/ Euro 2	2002/2004	065049	YTX5L-BS ■	068049	ESTX5L-BS ■	063049 FTX5L-BS ■
50	MXU	2006/2010	0650990	YTX9-BS ■	068099	ESTX9-BS ■	063099 FTX9-BS ■
50	People 2T	1999/2004	065049	YTX5L-BS ■	068049	ESTX5L-BS ■	063049 FTX5L-BS ■
50	People 2T E2	2003/2015	065049	YTX5L-BS ■	068049	ESTX5L-BS ■	063049 FTX5L-BS ■
50	People S 2T	2005/2014	0650390	YTX4L-BS ■	068039	ESTX4L-BS ■	— —
50	People S 4T	2005/2014	0650700	YTX7A-BS ■	068070	ESTX7A-BS ■	— —
50	Sento / New Sento 4T	2008/2011	065049	YTX5L-BS ■	068049	ESTX5L-BS ■	063049 FTX5L-BS ■
50	Sniper DT/ DD	1993/1996	0650390	YTX4L-BS ■	068039	ESTX4L-BS ■	— —
50	Super 8 2T	2009/2015	0650700	YTX7A-BS ■	068070	ESTX7A-BS ■	— —
50	Super 8 4T	2009/2015	0650700	YTX7A-BS ■	068070	ESTX7A-BS ■	— —
50	Super 9 / Super 9 Sport	2000/2007	065049	YTX5L-BS ■	068049	ESTX5L-BS ■	063049 FTX5L-BS ■
50	Top Boy Off Road	1997/2000	065049	YTX5L-BS ■	068049	ESTX5L-BS ■	063049 FTX5L-BS ■
50	Top Boy On Road	1997/2000	065049	YTX5L-BS ■	068049	ESTX5L-BS ■	063049 FTX5L-BS ■
50	Vitality 2T	2004/2008	0650390	YTX4L-BS ■	068039	ESTX4L-BS ■	— —
50	Vitality 4T	2004/2008	065049	YTX5L-BS ■	068049	ESTX5L-BS ■	063049 FTX5L-BS ■
50	Yup	2002/2007	0650390	YTX4L-BS ■	068039	ESTX4L-BS ■	— —
100	Top Boy	1999/>	0650700	YTX7A-BS ■	068070	ESTX7A-BS ■	— —
125	Agility 4T / E2 R12	2005/2006	0650700	YTX7A-BS ■	068070	ESTX7A-BS ■	— —

▲ - Factory Sealed / Attivata dalla Fabbrica ■ - con Acido a corredo ◇ - Non di produzione YUASA a completamento gamma

Marca / Cilindrata / Modello / Anno			Cod. SGR		Cod. SGR		Cod. SGR	
KYMCO								
125	Agility 4T Carry R12	2009/2015	0650700	YTX7A-BS■	068070	ESTX7A-BS■	—	—
125	Agility 4T E3 R12	2006/2015	0650700	YTX7A-BS■	068070	ESTX7A-BS■	—	—
125	Agility 4T R16 E3 (C20000)	2008/2015	0650700	YTX7A-BS■	068070	ESTX7A-BS■	—	—
125	Agility 4T RS R12	2009/2014	0650700	YTX7A-BS■	068070	ESTX7A-BS■	—	—
125	Bet & Win	2000/2002	0650990	YTX9-BS■	068099	ESTX9-BS■	063099	FTX9-BS■
125	Bet & Win E2	2003/2007	0650990	YTX9-BS■	068099	ESTX9-BS■	063099	FTX9-BS■
125	Dink	1997/1998	0650990	YTX9-BS■	068099	ESTX9-BS■	063099	FTX9-BS■
125	Dink 4T DD E3	2006/2015	0650990	YTX9-BS■	068099	ESTX9-BS■	063099	FTX9-BS■
125	Dink Classic / E2	2002/2006	0650990	YTX9-BS■	068099	ESTX9-BS■	063099	FTX9-BS■
125	Dink LX	1998/2002	0650990	YTX9-BS■	068099	ESTX9-BS■	063099	FTX9-BS■
125	Downtown	2009/2015	0651110	YT12A-BS■	0681110	EST12A-BS■	—	—
125	Grand Dink / Grand Dink E2	2001/2007	0650990	YTX9-BS■	068099	ESTX9-BS■	063099	FTX9-BS■
125	Grand Dink E3	2008/2011	0650990	YTX9-BS■	068099	ESTX9-BS■	063099	FTX9-BS■
125	Grand Dink G-Dink	2012/2015	0650990	YTX9-BS■	068099	ESTX9-BS■	063099	FTX9-BS■
125	Heroism	1995/2000	0650990	YTX9-BS■	068099	ESTX9-BS■	063099	FTX9-BS■
125	K-XCT I	2012/2015	0650990	YTX9-BS■	068099	ESTX9-BS■	063099	FTX9-BS■
125	Like / LX	2009/2015	0650700	YTX7A-BS■	068070	ESTX7A-BS■	—	—
125	Movie	1998/2000	0650990	YTX9-BS■	068099	ESTX9-BS■	063099	FTX9-BS■
125	Movie E3	2006/2009	0650990	YTX9-BS■	068099	ESTX9-BS■	063099	FTX9-BS■
125	Movie XL / E2	2001/2006	0650990	YTX9-BS■	068099	ESTX9-BS■	063099	FTX9-BS■
125	MXER/ Euro 2	2002/2004	0650990	YTX9-BS■	068099	ESTX9-BS■	063099	FTX9-BS■
125	People / E2	1999/2007	0650700	YTX7A-BS■	068070	ESTX7A-BS■	—	—
125	People E3	2007/2015	0650700	YTX7A-BS■	068070	ESTX7A-BS■	—	—
125	People GTI IE	2010/2015	0651110	YT12A-BS■	0681110	EST12A-BS■	—	—
125	People One I	2013/2015	0650700	YTX7A-BS■	068070	ESTX7A-BS■	—	—
125	People S / S DD	2005/2015	0650700	YTX7A-BS■	068070	ESTX7A-BS■	—	—
125	Quannon	2008/2008	0650710	YT7B-BS■	068071	EST7B-BS■	—	—
125	Super 8	2008/2014	0650700	YTX7A-BS■	068070	ESTX7A-BS■	—	—
125	Vivio	2000/2000	0650990	YTX9-BS■	068099	ESTX9-BS■	063099	FTX9-BS■
125	Zing	TUTTI	0650700	YTX7A-BS■	068070	ESTX7A-BS■	—	—
150	Agility R16	2008/2015	0650700	YTX7A-BS■	068070	ESTX7A-BS■	—	—
150	Bet & Win	2000/2002	0650990	YTX9-BS■	068099	ESTX9-BS■	063099	FTX9-BS■
150	Bet & Win E2	2003/2007	0650990	YTX9-BS■	068099	ESTX9-BS■	063099	FTX9-BS■
150	Dink	1997/1998	0650990	YTX9-BS■	068099	ESTX9-BS■	063099	FTX9-BS■
150	Dink Classic / E2	2002/2007	0650990	YTX9-BS■	068099	ESTX9-BS■	063099	FTX9-BS■
150	Dink LX	1998/2002	0650990	YTX9-BS■	068099	ESTX9-BS■	063099	FTX9-BS■
150	Grand Dink / Grand Dink E2	2001/2007	0650990	YTX9-BS■	068099	ESTX9-BS■	063099	FTX9-BS■
150	Heroism	1995/2000	0650990	YTX9-BS■	068099	ESTX9-BS■	063099	FTX9-BS■
150	Movie E3	2006/2009	0650990	YTX9-BS■	068099	ESTX9-BS■	063099	FTX9-BS■
150	Movie XL / E2	2001/2006	0650990	YTX9-BS■	068099	ESTX9-BS■	063099	FTX9-BS■
150	MXER/ Euro 2	2002/2004	0650990	YTX9-BS■	068099	ESTX9-BS■	063099	FTX9-BS■

▲ - Factory Sealed / Attivata dalla Fabbrica ■ - con Acido a corredo ◇ - Non di produzione YUASA a completamento gamma

Marca / Cilindrata / Modello / Anno		Cod. SGR		Cod. SGR		Cod. SGR		
KYMCO								
150	MXU	2005/2010	0650990	YTX9-BS■	068099	ESTX9-BS■	063099	FTX9-BS■
150	People / E2	1999/2006	0650700	YTX7A-BS■	068070	ESTX7A-BS■	—	—
150	Vivio	2000/2000	0650990	YTX9-BS■	068099	ESTX9-BS■	063099	FTX9-BS■
150	Zing	TUTTI	0650700	YTX7A-BS■	068070	ESTX7A-BS■	—	—
200	Agility I R16 (C31000)	2010/2015	0650990	YTX9-BS■	068099	ESTX9-BS■	063099	FTX9-BS■
200	Agility I R16 Plus (C32000)	2010/2015	0650990	YTX9-BS■	068099	ESTX9-BS■	063099	FTX9-BS■
200	Dink Classic	2004/2007	0650990	YTX9-BS■	068099	ESTX9-BS■	063099	FTX9-BS■
200	Dink DD E3	2006/2015	0651110	YT12A-BS■	0681110	EST12A-BS■	—	—
200	Downtown	2010/2015	0651110	YT12A-BS■	0681110	EST12A-BS■	—	—
200	Like I / LX	2009/2015	0650990	YTX9-BS■	068099	ESTX9-BS■	063099	FTX9-BS■
200	People GT1IE	2010/2015	0651110	YT12A-BS■	0681110	EST12A-BS■	—	—
200	People S	2005/2007	0650700	YTX7A-BS■	068070	ESTX7A-BS■	—	—
200	People S IE DD	2007/2015	065010	YTZ10S▲	—	—	063010	FTZ10S▲
200	People S IE DD	2007/2015	065910	TTZ10S-BS	068910	ESTTZ10S-BS■	—	—
250	Bet & Win	2000/2007	0651090	YTX12-BS■	0681090	ESTX12-BS■	063109	FTX12-BS■
250	Dink Sport	2001/>	0651090	YTX12-BS■	0681090	ESTX12-BS■	063109	FTX12-BS■
250	Grand Dink	2001/2009	0651090	YTX12-BS■	0681090	ESTX12-BS■	063109	FTX12-BS■
250	KXR	2004/2004	0651090	YTX12-BS■	0681090	ESTX12-BS■	063109	FTX12-BS■
250	MXU	2005/2006	0651090	YTX12-BS■	0681090	ESTX12-BS■	063109	FTX12-BS■
250	People	2003/2005	0651090	YTX12-BS■	0681090	ESTX12-BS■	063109	FTX12-BS■
250	People S	2006/2008	0651090	YTX12-BS■	0681090	ESTX12-BS■	063109	FTX12-BS■
250	People S IE	2007/2011	0651090	YTX12-BS■	0681090	ESTX12-BS■	063109	FTX12-BS■
250	Venox	2001/>	0650990	YTX9-BS■	068099	ESTX9-BS■	063099	FTX9-BS■
250	Venox E2/ E3	2004/2007	0650990	YTX9-BS■	068099	ESTX9-BS■	063099	FTX9-BS■
250	Xciting (T71000)	2004/2005	0651090	YTX12-BS■	0681090	ESTX12-BS■	063109	FTX12-BS■
250	Xciting I (T71010)	2006/2008	0651090	YTX12-BS■	0681090	ESTX12-BS■	063109	FTX12-BS■
250	Yup	2003/2005	0651090	YTX12-BS■	0681090	ESTX12-BS■	063109	FTX12-BS■
300	Downtown / ABS	2009/2015	0651110	YT12A-BS■	0681110	EST12A-BS■	—	—
300	Grand Dink G-Dink	2012/2015	0651110	YT12A-BS■	0681110	EST12A-BS■	—	—
300	K-XCT I	2012/2015	0651110	YT12A-BS■	0681110	EST12A-BS■	—	—
300	MAXXER/ Mongoose	2005/2012	0651090	YTX12-BS■	0681090	ESTX12-BS■	063109	FTX12-BS■
300	MXU / MXU R	2005/2009	0651090	YTX12-BS■	0681090	ESTX12-BS■	063109	FTX12-BS■
300	MXU / MXU R	2010/2011	0651437	YB14-A2	0681437	ESB14-A2■	—	—
300	People GT1IE / ABS	2010/2015	0651110	YT12A-BS■	0681110	EST12A-BS■	—	—
300	People S I	2008/2012	0651090	YTX12-BS■	0681090	ESTX12-BS■	063109	FTX12-BS■
300	Xciting I	2008/2012	0651090	YTX12-BS■	0681090	ESTX12-BS■	063109	FTX12-BS■
300	Xciting I R	2008/2014	0651090	YTX12-BS■	0681090	ESTX12-BS■	063109	FTX12-BS■
350	Downtown I ABS	2015/2015	0651110	YT12A-BS■	0681110	EST12A-BS■	—	—
400	MXU	2008/2011	0651437	YB14-A2	0681437	ESB14-A2■	—	—
400	Xciting I	2012/2015	065124	YTX14H-BS■	—	—	—	—
400	Xciting I	2012/2015	065129	YTX14-BS■	068129	ESTX14-BS■	—	—



▲ - Factory Sealed / Attivata dalla Fabbrica ■ - con Acido a corredo ◇ - Non di produzione YUASA a completamento gamma

Marca / Cilindrata / Modello / Anno			Cod. SGR		Cod. SGR		Cod. SGR	
KYMCO								
450	MAXXER I	2010/2011	0650202	GYZ20HL▲	—	—	—	—
450	MAXXER I	2010/2011	065185	YTX20HL-BS■	—	—	—	—
450	MAXXER I	2010/2011	065209	YTX20L-BS■	068209	ESTX20L-BS■	—	—
500	MXU 2X4 - 4X4	2005/2010	0650202	GYZ20HL▲	—	—	—	—
500	MXU 2X4 - 4X4	2005/2010	065185	YTX20HL-BS■	—	—	—	—
500	MXU 2X4 - 4X4	2005/2010	065209	YTX20L-BS■	068209	ESTX20L-BS■	—	—
500	MXU IRS	2010/2011	0650202	GYZ20HL▲	—	—	—	—
500	MXU IRS	2010/2011	065185	YTX20HL-BS■	—	—	—	—
500	MXU IRS	2010/2011	065209	YTX20L-BS■	068209	ESTX20L-BS■	—	—
500	UXV	2008/2010	0650202	GYZ20HL▲	—	—	—	—
500	UXV	2008/2010	065185	YTX20HL-BS■	—	—	—	—
500	UXV	2008/2010	065209	YTX20L-BS■	068209	ESTX20L-BS■	—	—
500	UXV I	2010/2011	0650202	GYZ20HL▲	—	—	—	—
500	UXV I	2010/2011	065185	YTX20HL-BS■	—	—	—	—
500	UXV I	2010/2011	065209	YTX20L-BS■	068209	ESTX20L-BS■	—	—
500	Xciting	2005/2006	065124	YTX14H-BS■	—	—	—	—
500	Xciting	2005/2006	065129	YTX14-BS■	068129	ESTX14-BS■	—	—
500	Xciting I	2006/2011	065124	YTX14H-BS■	—	—	—	—
500	Xciting I	2006/2011	065129	YTX14-BS■	068129	ESTX14-BS■	—	—
500	Xciting I R	2007/2014	065124	YTX14H-BS■	—	—	—	—
500	Xciting I R	2007/2014	065129	YTX14-BS■	068129	ESTX14-BS■	—	—
700	MyRoad	2011/2015	065124	YTX14H-BS■	—	—	—	—
700	MyRoad	2011/2015	065129	YTX14-BS■	068129	ESTX14-BS■	—	—
LAVERDA								
125	CU Rider	1984/>	0650634	12N5.5-3B	0680634	ES12N5.5-3B■	—	—
125	GS Lesmo	1986/>	0650634	12N5.5-3B	0680634	ES12N5.5-3B■	—	—
125	LB Strada/ Sport/ Custom	1984/>	0650634	12N5.5-3B	0680634	ES12N5.5-3B■	—	—
125	LZ (motore Zundapp)	TUTTI	0601112	6N11A-1B	—	—	—	—
150	Phoenix	2001/>	0650990	YTX9-BS■	068099	ESTX9-BS■	063099	FTX9-BS■
350	4T	1978/1981	0652015	52015	—	—	—	—
500	4T	1976/1983	0652015	52015	—	—	—	—
650	Ghost	1996/>	0652015	52015	—	—	—	—
650	Sport/ Formula	1995/2001	065123	YTX14AHL-BS■	—	—	—	—
650	Sport/ Formula	1995/2001	0651434	YB14L-A2	0681434	ESB14L-A2■	—	—
650	Strike	1996/>	0652015	52015	—	—	—	—
668	Diamante	1996/>	0652015	52015	—	—	—	—
668	Ghost	1997/>	0652015	52015	—	—	—	—
668	SF/ SFC/ GTL/ GTS	TUTTI	0652433	12N24-3A	—	—	—	—
668	Strike	1997/>	0652015	52015	—	—	—	—
750	Sport/ Formula	1997/2001	065123	YTX14AHL-BS■	—	—	—	—
750	Sport/ Formula	1997/2001	0651434	YB14L-A2	0681434	ESB14L-A2■	—	—
1000	RGS	1983/1986	0653211	6MK5 ◇	—	—	—	—

▲ - Factory Sealed / Attivata dalla Fabbrica ■ - con Acido a corredo ◇ - Non di produzione YUASA a completamento gamma

Marca / Cilindrata / Modello / Anno		Cod. SGR		Cod. SGR		Cod. SGR	
LEM							
50 Flash	TUTTI	06504340	YB4L-B	—	—	—	—
50 Flash	TUTTI	065043410	YB4L-B■	0680434	ESB4L-B■	—	—
50 Ghibli	TUTTI	06504340	YB4L-B	—	—	—	—
50 Ghibli	TUTTI	065043410	YB4L-B■	0680434	ESB4L-B■	—	—
MALAGUTI							
50 Centro	1993/1994	06504340	YB4L-B	—	—	—	—
50 Centro	1993/1994	065043410	YB4L-B■	0680434	ESB4L-B■	—	—
50 Centro 4T	2008/2010	0650990	YTX9-BS■	068099	ESTX9-BS■	063099	FTX9-BS■
50 Centro SL / SL Kat.	1994/1998	06504340	YB4L-B	—	—	—	—
50 Centro SL / SL Kat.	1994/1998	065043410	YB4L-B■	0680434	ESB4L-B■	—	—
50 Centro SL / SL Kat.	1999/2000	0650534	YB5L-B	0680534	ESB5L-B■	—	—
50 Ciak	1999/2002	0650534	YB5L-B	0680534	ESB5L-B■	—	—
50 Ciak TD	2000/2001	0650534	YB5L-B	0680534	ESB5L-B■	—	—
50 Crosser CR	1995/1998	06504340	YB4L-B	—	—	—	—
50 Crosser CR	1995/1998	065043410	YB4L-B■	0680434	ESB4L-B■	—	—
50 Dune ES	1989/>	06504340	YB4L-B	—	—	—	—
50 Dune ES	1989/>	065043410	YB4L-B■	0680434	ESB4L-B■	—	—
50 F10 Jet Line AC	2007/2008	06504340	YB4L-B	—	—	—	—
50 F10 Jet Line AC	2007/2008	065043410	YB4L-B■	0680434	ESB4L-B■	—	—
50 F10 Jet Line AC ECO	2009/2010	06504340	YB4L-B	—	—	—	—
50 F10 Jet Line AC ECO	2009/2010	065043410	YB4L-B■	0680434	ESB4L-B■	—	—
50 F10 Jet Line Rst Euro 2 (ED.2003)	2002/2003	06504340	YB4L-B	—	—	—	—
50 F10 Jet Line Rst Euro 2 (ED.2003)	2002/2003	065043410	YB4L-B■	0680434	ESB4L-B■	—	—
50 F10 Jet Line Rst Euro 2 (ED.2006)	2006/2007	06504340	YB4L-B	—	—	—	—
50 F10 Jet Line Rst Euro 2 (ED.2006)	2006/2007	065043410	YB4L-B■	0680434	ESB4L-B■	—	—
50 F10 Jet Line Rst Euro 2.3	2003/2005	06504340	YB4L-B	—	—	—	—
50 F10 Jet Line Rst Euro 2.3	2003/2005	065043410	YB4L-B■	0680434	ESB4L-B■	—	—
50 F10 Jet Line/ Rst./ E1 / Kat.	1992/2000	06504340	YB4L-B	—	—	—	—
50 F10 Jet Line/ Rst./ E1 / Kat.	1992/2000	065043410	YB4L-B■	0680434	ESB4L-B■	—	—
50 F12 Phantom Air	1994/1998	06504340	YB4L-B	—	—	—	—
50 F12 Phantom Air	1994/1998	065043410	YB4L-B■	0680434	ESB4L-B■	—	—
50 F12 Phantom Air Euro1	1999/2000	06504340	YB4L-B	—	—	—	—
50 F12 Phantom Air Euro1	1999/2000	065043410	YB4L-B■	0680434	ESB4L-B■	—	—
50 F12 Phantom LC	1994/1998	06504340	YB4L-B	—	—	—	—
50 F12 Phantom LC	1994/1998	065043410	YB4L-B■	0680434	ESB4L-B■	—	—
50 F12 Phantom LC Euro1	1999/2000	06504340	YB4L-B	—	—	—	—
50 F12 Phantom LC Euro1	1999/2000	065043410	YB4L-B■	0680434	ESB4L-B■	—	—
50 F12 Phantom LC Twin Disks	1998/1998	06504340	YB4L-B	—	—	—	—
50 F12 Phantom LC Twin Disks	1998/1998	065043410	YB4L-B■	0680434	ESB4L-B■	—	—
50 F12 Phantom R AC	2007/2010	0650534	YB5L-B	0680534	ESB5L-B■	—	—
50 F12 Phantom R LC	2007/2008	0650534	YB5L-B	0680534	ESB5L-B■	—	—



▲ - Factory Sealed / Attivata dalla Fabbrica ■ - con Acido a corredo ◇ - Non di produzione YUASA a completamento gamma

Marca / Cilindrata / Modello / Anno			Cod. SGR		Cod. SGR		Cod. SGR		
MALAGUTI									
50	F12 Phantom Rst Air Euro 2.3	2003/2005	06504340	YB4L-B	—	—	—	—	—
50	F12 Phantom Rst Air Euro 2.3	2003/2005	065043410	YB4L-B■	0680434	ESB4L-B■	—	—	—
50	F12 Phantom Rst LC Euro 2.3	2003/2005	06504340	YB4L-B	—	—	—	—	—
50	F12 Phantom Rst LC Euro 2.3	2003/2005	065043410	YB4L-B■	0680434	ESB4L-B■	—	—	—
50	F12 Phantom Rst LC Euro2	2006/>	06504340	YB4L-B	—	—	—	—	—
50	F12 Phantom Rst LC Euro2	2006/>	065043410	YB4L-B■	0680434	ESB4L-B■	—	—	—
50	F12 Phantom Rst. Air E2 (ZJM46)	2006/>	06504340	YB4L-B	—	—	—	—	—
50	F12 Phantom Rst. Air E2 (ZJM46)	2006/>	065043410	YB4L-B■	0680434	ESB4L-B■	—	—	—
50	F12 Phantom Rst. Air Euro1	2001/2002	06504340	YB4L-B	—	—	—	—	—
50	F12 Phantom Rst. Air Euro1	2001/2002	065043410	YB4L-B■	0680434	ESB4L-B■	—	—	—
50	F12 Phantom Rst. Air Euro2	2002/2002	06504340	YB4L-B	—	—	—	—	—
50	F12 Phantom Rst. Air Euro2	2002/2002	065043410	YB4L-B■	0680434	ESB4L-B■	—	—	—
50	F12 Phantom Rst. LC Euro1 (ZJM47)	2001/2002	06504340	YB4L-B	—	—	—	—	—
50	F12 Phantom Rst. LC Euro1 (ZJM47)	2001/2002	065043410	YB4L-B■	0680434	ESB4L-B■	—	—	—
50	F12 Phantom Rst. LC Euro2 (ZJM48)	2002/2002	06504340	YB4L-B	—	—	—	—	—
50	F12 Phantom Rst. LC Euro2 (ZJM48)	2002/2002	065043410	YB4L-B■	0680434	ESB4L-B■	—	—	—
50	F15 Firefox DD/ DT	1996/1998	06504340	YB4L-B	—	—	—	—	—
50	F15 Firefox DD/ DT	1996/1998	065043410	YB4L-B■	0680434	ESB4L-B■	—	—	—
50	F15 Firefox Twin Disk/ Digit	TUTTI	0650534	YB5L-B	0680534	ESB5L-B■	—	—	—
50	Fifty Colors	1983/>	06504340	YB4L-B	—	—	—	—	—
50	Fifty Colors	1983/>	065043410	YB4L-B■	0680434	ESB4L-B■	—	—	—
50	Fifty Evolution	1990/1993	06504340	YB4L-B	—	—	—	—	—
50	Fifty Evolution	1990/1993	065043410	YB4L-B■	0680434	ESB4L-B■	—	—	—
50	Fifty Mistral	1983/>	06504340	YB4L-B	—	—	—	—	—
50	Fifty Mistral	1983/>	065043410	YB4L-B■	0680434	ESB4L-B■	—	—	—
50	Fifty Top	1991/>	06504340	YB4L-B	—	—	—	—	—
50	Fifty Top	1991/>	065043410	YB4L-B■	0680434	ESB4L-B■	—	—	—
50	New Dribbling	TUTTI	06504340	YB4L-B	—	—	—	—	—
50	New Dribbling	TUTTI	065043410	YB4L-B■	0680434	ESB4L-B■	—	—	—
50	RST Sport	1992/1993	06504340	YB4L-B	—	—	—	—	—
50	RST Sport	1992/1993	065043410	YB4L-B■	0680434	ESB4L-B■	—	—	—
50	XSM	2003/2004	06504340	YB4L-B	—	—	—	—	—
50	XSM	2003/2004	065043410	YB4L-B■	0680434	ESB4L-B■	—	—	—
50	XTM	2003/2004	06504340	YB4L-B	—	—	—	—	—
50	XTM	2003/2004	065043410	YB4L-B■	0680434	ESB4L-B■	—	—	—
50	Yesterday	1997/2000	06504340	YB4L-B	—	—	—	—	—
50	Yesterday	1997/2000	065043410	YB4L-B■	0680434	ESB4L-B■	—	—	—
100	Ciak	1999/>	0650534	YB5L-B	0680534	ESB5L-B■	—	—	—
100	F12 Phantom	1999/>	065049	YTX5L-BS■	068049	ESTX5L-BS■	063049	FTX5L-BS■	—
125	Blog IE	2009/2010	0650690	YTX7L-BS■	068069	ESTX7L-BS■	063069	FTX7L-BS■	—
125	Centro IE	2007/2010	0650990	YTX9-BS■	068099	ESTX9-BS■	063099	FTX9-BS■	—



▲ - Factory Sealed / Attivata dalla Fabbrica ■ - con Acido a corredo ◇ - Non di produzione YUASA a completamento gamma

Marca / Cilindrata / Modello / Anno			Cod. SGR		Cod. SGR		Cod. SGR		
MALAGUTI									
125	Ciak / Ciak Master / Rst E2	2000/2003	06509350	YB9-B	0680935	ESB9-B■	—	—	
125	Ciak / Ciak Master / Rst E2	2004/2005	0650990	YTX9-BS■	068099	ESTX9-BS■	063099	FTX9-BS■	
125	Ciak Master E3	2006/2008	0650990	YTX9-BS■	068099	ESTX9-BS■	063099	FTX9-BS■	
125	CMX	</1986	0600633	6N6-3B	—	—	—	—	
125	F18 Warrior	2000/2002	06509350	YB9-B	0680935	ESB9-B■	—	—	
125	Madison 3	2006/2008	0651090	YTX12-BS■	0681090	ESTX12-BS■	063109	FTX12-BS■	
125	Madison R	1999/2003	06509350	YB9-B	0680935	ESB9-B■	—	—	
125	Runner VS/ Rally	1987/>	0650334	YB3L-A	0680334	ESB3L-A■	—	—	
125	Runner YLC	1985/>	0600633	6N6-3B	—	—	—	—	
125	Runner YPVS Rally	1986/>	0600633	6N6-3B	—	—	—	—	
125	X3M Enduro	2008/>	0650690	YTX7L-BS■	068069	ESTX7L-BS■	063069	FTX7L-BS■	
125	X3M Supermotard	2008/>	0650690	YTX7L-BS■	068069	ESTX7L-BS■	063069	FTX7L-BS■	
150	Ciak / Ciak Master / Rst E2	2000/2003	06509350	YB9-B	0680935	ESB9-B■	—	—	
150	Ciak / Ciak Master / Rst E2	2004/2005	0650990	YTX9-BS■	068099	ESTX9-BS■	063099	FTX9-BS■	
150	F18 Warrior	2000/2002	06509350	YB9-B	0680935	ESB9-B■	—	—	
150	Madison T	1999/2001	06509350	YB9-B	0680935	ESB9-B■	—	—	
160	Blog IE	2009/2010	0650690	YTX7L-BS■	068069	ESTX7L-BS■	063069	FTX7L-BS■	
160	Centro IE	2007/2010	0650990	YTX9-BS■	068099	ESTX9-BS■	063099	FTX9-BS■	
180	Madison R	2001/2002	06509350	YB9-B	0680935	ESB9-B■	—	—	
200	Ciak Master E3	2006/2008	0650990	YTX9-BS■	068099	ESTX9-BS■	063099	FTX9-BS■	
200	Madison S	2002/2003	06509350	YB9-B	0680935	ESB9-B■	—	—	
250	Madison 3	2006/2009	0651090	YTX12-BS■	0681090	ESTX12-BS■	063109	FTX12-BS■	
250	Madison RS	2004/2005	06512360	YB12AL-A	0681236	ESB12AL-A■	—	—	
250	Madison RS	2004/2005	06512400	YB12AL-A2	0681240	ESB12AL-A2■	—	—	
250	Madison S	1999/2003	06509350	YB9-B	0680935	ESB9-B■	—	—	
250	Password / Password E3	2005/2008	0651090	YTX12-BS■	0681090	ESTX12-BS■	063109	FTX12-BS■	
250	Phantom Max	2004/2004	0651090	YTX12-BS■	0681090	ESTX12-BS■	063109	FTX12-BS■	
400	Madison K	2002/2004	06512360	YB12AL-A	0681236	ESB12AL-A■	—	—	
400	Madison K	2002/2004	06512400	YB12AL-A2	0681240	ESB12AL-A2■	—	—	
500	Spidermax GT	2004/2007	065124	YTX14H-BS■	—	—	—	—	
500	Spidermax GT	2004/2007	065129	YTX14-BS■	068129	ESTX14-BS■	—	—	
500	Spidermax RS	2008/2010	065124	YTX14H-BS■	—	—	—	—	
500	Spidermax RS	2008/2010	065129	YTX14-BS■	068129	ESTX14-BS■	—	—	
MALANCA									
125	2 CE	1980/>	0601112	6N11A-1B	—	—	—	—	
150	GT	1974/>	0601112	6N11A-1B	—	—	—	—	
MBK									
50	Active	TUTTI	06504340	YB4L-B	—	—	—	—	
50	Active	TUTTI	065043410	YB4L-B■	0680434	ESB4L-B■	—	—	
50	Booster Rocket	1997/1998	06504340	YB4L-B	—	—	—	—	
50	Booster Rocket	1997/1998	065043410	YB4L-B■	0680434	ESB4L-B■	—	—	



▲ - Factory Sealed / Attivata dalla Fabbrica ■ - con Acido a corredo ◇ - Non di produzione YUASA a completamento gamma

Marca / Cilindrata / Modello / Anno			Cod. SGR		Cod. SGR		Cod. SGR		
MBK									
50	Booster Track	1997/1998	06504340	YB4L-B	—	—	—	—	
50	Booster Track	1997/1998	065043410	YB4L-B■	0680434	ESB4L-B■	—	—	
50	CT S Sorriso	1991/1992	06504340	YB4L-B	—	—	—	—	
50	CT S Sorriso	1991/1992	065043410	YB4L-B■	0680434	ESB4L-B■	—	—	
50	CT SS Sorriso	1993/1995	06504340	YB4L-B	—	—	—	—	
50	CT SS Sorriso	1993/1995	065043410	YB4L-B■	0680434	ESB4L-B■	—	—	
50	CW Booster	1990/1994	06504340	YB4L-B	—	—	—	—	
50	CW Booster	1990/1994	065043410	YB4L-B■	0680434	ESB4L-B■	—	—	
50	CW Booster Spirit	1996/2000	06504340	YB4L-B	—	—	—	—	
50	CW Booster Spirit	1996/2000	065043410	YB4L-B■	0680434	ESB4L-B■	—	—	
50	CW R Booster Road	1994/1995	06504340	YB4L-B	—	—	—	—	
50	CW R Booster Road	1994/1995	065043410	YB4L-B■	0680434	ESB4L-B■	—	—	
50	CW RS Booster N.G.	1995/2000	06504340	YB4L-B	—	—	—	—	
50	CW RS Booster N.G.	1995/2000	065043410	YB4L-B■	0680434	ESB4L-B■	—	—	
50	Evolis	1992/1995	06504340	YB4L-B	—	—	—	—	
50	Evolis	1992/1995	065043410	YB4L-B■	0680434	ESB4L-B■	—	—	
50	EW Stunt	2000/2002	06504340	YB4L-B	—	—	—	—	
50	EW Stunt	2000/2002	065043410	YB4L-B■	0680434	ESB4L-B■	—	—	
50	Fizz	1994/1995	06504340	YB4L-B	—	—	—	—	
50	Fizz	1994/1995	065043410	YB4L-B■	0680434	ESB4L-B■	—	—	
50	Flipper	1998/2002	06504340	YB4L-B	—	—	—	—	
50	Flipper	1998/2002	065043410	YB4L-B■	0680434	ESB4L-B■	—	—	
50	Forte	1994/1996	0650390	YTX4L-BS■	068039	ESTX4L-BS■	—	—	
50	Forte	TUTTI	06504340	YB4L-B	—	—	—	—	
50	Forte	TUTTI	065043410	YB4L-B■	0680434	ESB4L-B■	—	—	
50	Mach G	2002/>	0650390	YTX4L-BS■	068039	ESTX4L-BS■	—	—	
50	New Sorriso	1995/1996	0650390	YTX4L-BS■	068039	ESTX4L-BS■	—	—	
50	New Sorriso	TUTTI	06504340	YB4L-B	—	—	—	—	
50	New Sorriso	TUTTI	065043410	YB4L-B■	0680434	ESB4L-B■	—	—	
50	Nitro	1997/2000	06504340	YB4L-B	—	—	—	—	
50	Nitro	1997/2000	065043410	YB4L-B■	0680434	ESB4L-B■	—	—	
50	Ovetto	1997/2000	06504340	YB4L-B	—	—	—	—	
50	Ovetto	1997/2000	065043410	YB4L-B■	0680434	ESB4L-B■	—	—	
50	Target	1991/1995	06504340	YB4L-B	—	—	—	—	
50	Target	1991/1995	065043410	YB4L-B■	0680434	ESB4L-B■	—	—	
100	Booster	1999/>	065049	YTX5L-BS■	068049	ESTX5L-BS■	063049	FTX5L-BS■	
100	Nitro	2000/>	0650390	YTX4L-BS■	068039	ESTX4L-BS■	—	—	
100	Ovetto	2000/2002	0650390	YTX4L-BS■	068039	ESTX4L-BS■	—	—	
125	Doodo	2000/2002	0650739	YB7L-B2	0680739	ESB7L-B2■	—	—	
125	Skyliner DD	2001/2005	0650739	YB7L-B2	0680739	ESB7L-B2■	—	—	
125	Skyliner DT	1998/2000	0650739	YB7L-B2	0680739	ESB7L-B2■	—	—	



▲ - Factory Sealed / Attivata dalla Fabbrica ■ - con Acido a corredo ◇ - Non di produzione YUASA a completamento gamma

Marca / Cilindrata / Modello / Anno			Cod. SGR		Cod. SGR		Cod. SGR		
MBK									
125	Thunder	2001/2002	0650739	YB7L-B2	0680739	ESB7L-B2■	—	—	
125	Waap	2008/2010	0650700	YTX7A-BS■	068070	ESTX7A-BS■	—	—	
125	X-Over	2010/2010	0650700	YTX7A-BS■	068070	ESTX7A-BS■	—	—	
125	XC Flame	1995/2000	0650700	YTX7A-BS■	068070	ESTX7A-BS■	—	—	
150	Doodo	2000/2002	0650739	YB7L-B2	0680739	ESB7L-B2■	—	—	
150	Skyliner DD	2001/2005	0650739	YB7L-B2	0680739	ESB7L-B2■	—	—	
150	Skyliner DT	1998/2000	0650739	YB7L-B2	0680739	ESB7L-B2■	—	—	
150	Skyliner DT	2001/2005	0650739	YB7L-B2	0680739	ESB7L-B2■	—	—	
150	Thunder	2001/2002	0650739	YB7L-B2	0680739	ESB7L-B2■	—	—	
150	XC Vertex	1997/1997	0650690	YTX7L-BS■	068069	ESTX7L-BS■	063069	FTX7L-BS■	
180	Skyliner DD	2003/2005	0650739	YB7L-B2	0680739	ESB7L-B2■	—	—	
250	Skyliner	2000/2003	0650710	YT7B-BS■	068071	EST7B-BS■	—	—	
300	Kilibre	2003/2003	0650990	YTX9-BS■	068099	ESTX9-BS■	063099	FTX9-BS■	
MOTO GUZZI									
125	Bicilindrico	TUTTI	0601113	6N11A-3A	—	—	—	—	
125	C Custom	1986/>	—	—	—	—	—	—	
125	Stornello Scrambler 1C 4T	1959/1969	0601433	B38-6A	—	—	—	—	
125	Stornello Scrambler 1C 4T	1959/1969	0661433	3R3 ◊▲	—	—	—	—	
125	Stornello Sport 1C 4T	1959/1969	0600715	B39-6	—	—	—	—	
125	TT 2T	1985/1985	0650636	12N5.5-4A	—	—	—	—	
160	Stornello Scrambler	1970/1970	0601433	B38-6A	—	—	—	—	
160	Stornello Scrambler	1970/1970	0661433	3R3 ◊▲	—	—	—	—	
175	Lodola	1957/1962	0600833	B49-6	—	—	—	—	
192	Galletto S/ avv.to Elettrico	TUTTI	0601433	B38-6A	—	—	—	—	
192	Galletto S/ avv.to Elettrico	TUTTI	0661433	3R3 ◊▲	—	—	—	—	
200	Galletto	1954/1961	0652711	6MC4 ◊	—	—	—	—	
200	Motocarro Ercolino	1955/1964	0601433	B38-6A	—	—	—	—	
200	Motocarro Ercolino	1955/1964	0661433	3R3 ◊▲	—	—	—	—	
250	Quattro 4C 4T	1977/>	0651234	YB12A-A	0681234	ESB12A-A■	—	—	
250	TS 2T 2C	1975/1976	0601113	6N11A-3A	—	—	—	—	
350	GTS 4C 4T	1974/1981	0652015	52015	—	—	—	—	
350	Nevada/ Nevada Club	1992/1993	0652711	6MC4 ◊	—	—	—	—	
350	NTX	1986/1990	0652711	6MC4 ◊	—	—	—	—	
350	V35 C	1982/1986	0652711	6MC4 ◊	—	—	—	—	
350	V35 Florida	1986/1990	0652711	6MC4 ◊	—	—	—	—	
350	V35 GT	1990/>	0652711	6MC4 ◊	—	—	—	—	
350	V35 II	1980/1985	0652711	6MC4 ◊	—	—	—	—	
350	V35 Imola	1979/1987	0652711	6MC4 ◊	—	—	—	—	
350	V35 Imola II	1984/1986	0652711	6MC4 ◊	—	—	—	—	
400	GTS 4C	1975/1980	0652015	52015	—	—	—	—	
500	Falcone (prima serie)	1959/1970	0601433	B38-6A	—	—	—	—	

▲ - Factory Sealed / Attivata dalla Fabbrica ◻ - con Acido a corredo ◊ - Non di produzione YUASA a completamento gamma

Marca / Cilindrata / Modello / Anno			Cod. SGR		Cod. SGR		Cod. SGR	
MOTO GUZZI								
500	Falcone (prima serie)	1959/1970	0661433	3R3 ◇▲	—	—	—	—
500	Falcone Nuovo (ultima serie)	1971/1975	0652711	6MC4 ◇	—	—	—	—
500	V50 C	1982/1986	0652711	6MC4 ◇	—	—	—	—
500	V50 Carabinieri/ PA	1992/2001	0653211	6MK5 ◇	—	—	—	—
650	NTX	1989/>	0652711	6MC4 ◇	—	—	—	—
650	V65	1981/1986	0652711	6MC4 ◇	—	—	—	—
650	V65 Florida	1985/1992	0652711	6MC4 ◇	—	—	—	—
750	Breva	2003/2007	065123	YTX14AHL-BS■	—	—	—	—
750	Breva	2003/2007	0651434	YB14L-A2	0681434	ESB14L-A2■	—	—
750	Nevada Classic - Aquila nera (LME00/ LMG00)	2004/2008	065123	YTX14AHL-BS■	—	—	—	—
750	Nevada Classic - Aquila nera (LME00/ LMG00)	2004/2008	0651434	YB14L-A2	0681434	ESB14L-A2■	—	—
750	Nevada Classic - Aquila nera (LME00/ LMG00)	2009/2011	065123	YTX14AHL-BS■	—	—	—	—
750	Nevada Classic - Aquila Nera (LML00)	2012/2016	065124	YTX14H-BS■	—	—	—	—
750	Nevada Classic - Aquila Nera (LML00)	2012/2016	065129	YTX14-BS■	068129	ESTX14-BS■	—	—
750	Nevada S (LMH00)	2010/2011	065124	YTX14H-BS■	—	—	—	—
750	Nevada S (LMH00)	2010/2011	065129	YTX14-BS■	068129	ESTX14-BS■	—	—
750	Nevada S ANNIVERSARIO (LMM00)	2012/2012	065124	YTX14H-BS■	—	—	—	—
750	Nevada S ANNIVERSARIO (LMM00)	2012/2012	065129	YTX14-BS■	068129	ESTX14-BS■	—	—
750	Nevada/ Nevada Club	1991/2003	0652711	6MC4 ◇	—	—	—	—
750	NTX	1992/1993	0652711	6MC4 ◇	—	—	—	—
750	Strada	1993/1995	0652711	6MC4 ◇	—	—	—	—
750	Targa	1990/1992	0652711	6MC4 ◇	—	—	—	—
750	V7 Café Classic (LWA00/ LWC01)	2009/2009	065123	YTX14AHL-BS■	—	—	—	—
750	V7 Classic (LW00/ LWC00/ LWJ00)	2008/2012	065123	YTX14AHL-BS■	—	—	—	—
750	V7 II Racer ABS (LW300/ LWUC2)	2015/2016	065124	YTX14H-BS■	—	—	—	—
750	V7 II Racer ABS (LW300/ LWUC2)	2015/2016	065129	YTX14-BS■	068129	ESTX14-BS■	—	—
750	V7 II Special ABS (LW200/ LWUC1)	2015/2016	065124	YTX14H-BS■	—	—	—	—
750	V7 II Special ABS (LW200/ LWUC1)	2015/2016	065129	YTX14-BS■	068129	ESTX14-BS■	—	—
750	V7 II Stone ABS (LW100/ LWUC0)	2015/2016	065124	YTX14H-BS■	—	—	—	—
750	V7 II Stone ABS (LW100/ LWUC0)	2015/2016	065129	YTX14-BS■	068129	ESTX14-BS■	—	—
750	V7 Racer (LWB00/ LWU02/ LWV01)	2010/2011	065123	YTX14AHL-BS■	—	—	—	—
750	V7 Racer (LWB00/ LWU02/ LWV01)	2012/2014	065124	YTX14H-BS■	—	—	—	—
750	V7 Racer (LWB00/ LWU02/ LWV01)	2012/2014	065129	YTX14-BS■	068129	ESTX14-BS■	—	—
750	V7 Special	1969/1972	0653211	6MK5 ◇	—	—	—	—
750	V7 Special - Stone (LWG00/ LWE00/ LWU00)	2012/2014	065124	YTX14H-BS■	—	—	—	—
750	V7 Special - Stone (LWG00/ LWE00/ LWU00)	2012/2014	065129	YTX14-BS■	068129	ESTX14-BS■	—	—
750	V7 Sport	1971/1973	0653211	6MK5 ◇	—	—	—	—
750	V75	1985/1990	0652711	6MC4 ◇	—	—	—	—
850	Breva ie	2006/2010	065187	YTX20CH-BS■	068187	ESTX20CH-BS■	—	—
850	Griso	2006/2010	065187	YTX20CH-BS■	068187	ESTX20CH-BS■	—	—
850	Le Mans I	1975/1977	0653211	6MK5 ◇	—	—	—	—

▲ - Factory Sealed / Attivata dalla Fabbrica : ■ - con Acido a corredo : ◇ - Non di produzione YUASA a completamento gamma

Marca / Cilindrata / Modello / Anno			Cod. SGR		Cod. SGR		Cod. SGR	
MOTO GUZZI								
850	Le Mans II	1978/1980	0653211	6MK5 ◇	—	—	—	—
850	Le Mans III	1981/1984	0653211	6MK5 ◇	—	—	—	—
850	Norge	2007/2008	065187	YTX20CH-BS■	068187	ESTX20CH-BS■	—	—
850	T3	1979/1982	0652711	6MC4 ◇	—	—	—	—
850	T3 California	1975/1982	0652711	6MC4 ◇	—	—	—	—
850	T4	1980/1985	0652711	6MC4 ◇	—	—	—	—
850	T5	1983/1988	0652711	6MC4 ◇	—	—	—	—
940	Bellagio - Aquila Nera	2007/2013	065187	YTX20CH-BS■	068187	ESTX20CH-BS■	—	—
1000	California II	1983/1986	0652711	6MC4 ◇	—	—	—	—
1000	California III	1987/1993	0652711	6MC4 ◇	—	—	—	—
1000	Daytona / Daytona RS	1994/1995	0651637	YB16B-A	0681637	ESB16B-A■	—	—
1000	Daytona / Daytona RS	1997/2000	065139	YTX15L-BS■	068139	ESTX15L-BS■	—	—
1000	G5/ Convert	1978/1985	0653211	6MK5 ◇	—	—	—	—
1000	GT	1987/1993	0652711	6MC4 ◇	—	—	—	—
1000	Le Mans SP	1979/>	0652711	6MC4 ◇	—	—	—	—
1000	Quota	1992/1995	0652034	Y50-N18L-A	0682034	ES50-N18L-A■	—	—
1000	Quota	1992/1995	065215	YTX24HL-BS■	—	—	—	—
1000	SP	1978/1983	0652711	6MC4 ◇	—	—	—	—
1000	SP II	1984/1987	0652711	6MC4 ◇	—	—	—	—
1000	SP III	1988/1992	0652711	6MC4 ◇	—	—	—	—
1000	Strada	1993/1996	0652711	6MC4 ◇	—	—	—	—
1000	V10 Centauro,GT	1997/1999	065139	YTX15L-BS■	068139	ESTX15L-BS■	—	—
1100	Breva ie	2004/2009	065187	YTX20CH-BS■	068187	ESTX20CH-BS■	—	—
1100	California (KC/ KD)	1994/1997	0650202	GYZ20HL▲	—	—	—	—
1100	California (KC/ KD)	1994/1997	065185	YTX20HL-BS■	—	—	—	—
1100	California (KC/ KD)	1994/1997	065209	YTX20L-BS■	068209	ESTX20L-BS■	—	—
1100	California (KC/ KD)	1994/1997	0653030	53030	06853030	ES60-N30L-B (53030)■	—	—
1100	California Aluminium (KD)	2002/2005	0650202	GYZ20HL▲	—	—	—	—
1100	California Aluminium (KD)	2002/2005	065185	YTX20HL-BS■	—	—	—	—
1100	California Aluminium (KD)	2002/2005	065209	YTX20L-BS■	068209	ESTX20L-BS■	—	—
1100	California Aluminium (KD)	2002/2005	0653030	53030	06853030	ES60-N30L-B (53030)■	—	—
1100	California Aquila Nera	2009/2011	0650201	GYZ20H▲	—	—	—	—
1100	California Aquila Nera	2009/2011	065184	YTX20H-BS■	—	—	—	—
1100	California Classic (KDG)	2006/2011	0650201	GYZ20H▲	—	—	—	—
1100	California Classic (KDG)	2006/2011	065184	YTX20H-BS■	—	—	—	—
1100	California EV - EV Touring (KDG00)	2003/2005	0650202	GYZ20HL▲	—	—	—	—
1100	California EV - EV Touring (KDG00)	2003/2005	065185	YTX20HL-BS■	—	—	—	—
1100	California EV - EV Touring (KDG00)	2003/2005	065209	YTX20L-BS■	068209	ESTX20L-BS■	—	—
1100	California EV - EV Touring (KDG00)	2003/2005	0653030	53030	06853030	ES60-N30L-B (53030)■	—	—
1100	California EV (KD)	1997/2002	0650202	GYZ20HL▲	—	—	—	—
1100	California EV (KD)	1997/2002	065185	YTX20HL-BS■	—	—	—	—

▲ - Factory Sealed / Attivata dalla Fabbrica ■ - con Acido a corredo ◇ - Non di produzione YUASA a completamento gamma



MOTO GUZZI

1100	California EV (KD)	1997/2002	065209	YTX20L-BS■	068209	ESTX20L-BS■	—	—
1100	California EV (KD)	1997/2002	0653030	53030	06853030	ES60-N30L-B (53030)■	—	—
1100	California EV P.I. (KD)	2002/2002	0650202	GYZ20HL▲	—	—	—	—
1100	California EV P.I. (KD)	2002/2002	065185	YTX20HL-BS■	—	—	—	—
1100	California EV P.I. (KD)	2002/2002	065209	YTX20L-BS■	068209	ESTX20L-BS■	—	—
1100	California EV P.I. (KD)	2002/2002	0653030	53030	06853030	ES60-N30L-B (53030)■	—	—
1100	California Jackal (KD)	1999/2001	0650202	GYZ20HL▲	—	—	—	—
1100	California Jackal (KD)	1999/2001	065185	YTX20HL-BS■	—	—	—	—
1100	California Jackal (KD)	1999/2001	065209	YTX20L-BS■	068209	ESTX20L-BS■	—	—
1100	California Jackal (KD)	1999/2001	0653030	53030	06853030	ES60-N30L-B (53030)■	—	—
1100	California Metal (KD)	2002/2003	0650202	GYZ20HL▲	—	—	—	—
1100	California Metal (KD)	2002/2003	065185	YTX20HL-BS■	—	—	—	—
1100	California Metal (KD)	2002/2003	065209	YTX20L-BS■	068209	ESTX20L-BS■	—	—
1100	California Metal (KD)	2002/2003	0653030	53030	06853030	ES60-N30L-B (53030)■	—	—
1100	California Special (KD)	1999/2000	0650202	GYZ20HL▲	—	—	—	—
1100	California Special (KD)	1999/2000	065185	YTX20HL-BS■	—	—	—	—
1100	California Special (KD)	1999/2000	065209	YTX20L-BS■	068209	ESTX20L-BS■	—	—
1100	California Special (KD)	1999/2000	0653030	53030	06853030	ES60-N30L-B (53030)■	—	—
1100	California Special Sport (KD)	2002/2003	0650202	GYZ20HL▲	—	—	—	—
1100	California Special Sport (KD)	2002/2003	065185	YTX20HL-BS■	—	—	—	—
1100	California Special Sport (KD)	2002/2003	065209	YTX20L-BS■	068209	ESTX20L-BS■	—	—
1100	California Special Sport (KD)	2002/2003	0653030	53030	06853030	ES60-N30L-B (53030)■	—	—
1100	California Sport (KD)	2001/2002	0650202	GYZ20HL▲	—	—	—	—
1100	California Sport (KD)	2001/2002	065185	YTX20HL-BS■	—	—	—	—
1100	California Sport (KD)	2001/2002	065209	YTX20L-BS■	068209	ESTX20L-BS■	—	—
1100	California Sport (KD)	2001/2002	0653030	53030	06853030	ES60-N30L-B (53030)■	—	—
1100	California Stone (KD)	2001/2005	0650202	GYZ20HL▲	—	—	—	—
1100	California Stone (KD)	2001/2005	065185	YTX20HL-BS■	—	—	—	—
1100	California Stone (KD)	2001/2005	065209	YTX20L-BS■	068209	ESTX20L-BS■	—	—
1100	California Stone (KD)	2001/2005	0653030	53030	06853030	ES60-N30L-B (53030)■	—	—
1100	California Titanium (KD)	2004/2005	0650202	GYZ20HL▲	—	—	—	—
1100	California Titanium (KD)	2004/2005	065185	YTX20HL-BS■	—	—	—	—
1100	California Titanium (KD)	2004/2005	065209	YTX20L-BS■	068209	ESTX20L-BS■	—	—
1100	California Titanium (KD)	2004/2005	0653030	53030	06853030	ES60-N30L-B (53030)■	—	—
1100	California Tourer (KDE)	2006/2010	0650201	GYZ20H▲	—	—	—	—
1100	California Tourer (KDE)	2006/2010	065184	YTX20H-BS■	—	—	—	—
1100	California Vintage (KDH00)	2006/2012	0650201	GYZ20H▲	—	—	—	—
1100	California Vintage (KDH00)	2006/2012	065184	YTX20H-BS■	—	—	—	—
1100	Griso	2005/2009	065187	YTX20CH-BS■	068187	ESTX20CH-BS■	—	—
1100	Quota ES	1999/2003	065139	YTX15L-BS■	068139	ESTX15L-BS■	—	—
1100	Sport (KE)	1994/1996	065139	YTX15L-BS■	068139	ESTX15L-BS■	—	—



▲ - Factory Sealed / Attivata dalla Fabbrica ■ - con Acido a corredo ◇ - Non di produzione YUASA a completamento gamma

Marca / Cilindrata / Modello / Anno			Cod. SGR		Cod. SGR		Cod. SGR		
MOTO GUZZI									
1100	Sport Corsa (KE)	1998/1999	065139	YTX15L-BS■	068139	ESTX15L-BS■	—	—	
1100	VII Ballabio	2002/2005	065139	YTX15L-BS■	068139	ESTX15L-BS■	—	—	
1100	VII Le Mans	2001/2005	065139	YTX15L-BS■	068139	ESTX15L-BS■	—	—	
1100	VII Naked	2001/2005	065139	YTX15L-BS■	068139	ESTX15L-BS■	—	—	
1100	VII Sport (KR)	1999/2001	065139	YTX15L-BS■	068139	ESTX15L-BS■	—	—	
1100	VII Sport (KT)	2003/2005	065139	YTX15L-BS■	068139	ESTX15L-BS■	—	—	
1200	Breva (LPG00/ LPG01)	2008/2011	065187	YTX20CH-BS■	068187	ESTX20CH-BS■	—	—	
1200	Griso 8V (LSE/ LSE03)	2007/2014	065187	YTX20CH-BS■	068187	ESTX20CH-BS■	—	—	
1200	Griso 8V SE (LSG01)	2015/2016	065187	YTX20CH-BS■	068187	ESTX20CH-BS■	—	—	
1200	Norge (LSE00/ LSE03)	2006/2009	065187	YTX20CH-BS■	068187	ESTX20CH-BS■	—	—	
1200	Norge GT 8V (LPT00/ LPS01/ LPS03)	2010/2016	0650201	GYZ20H▲	—	—	—	—	
1200	Norge GT 8V (LPT00/ LPS01/ LPS03)	2010/2016	065184	YTX20H-BS■	—	—	—	—	
1200	Sport 4V (LPM00/ LPM01)	2006/2008	0650201	GYZ20H▲	—	—	—	—	
1200	Sport 4V (LPM00/ LPM01)	2006/2008	065184	YTX20H-BS■	—	—	—	—	
1200	Sport 8V (LPJ20/ LPR00/ LPR01)	2009/2013	0650201	GYZ20H▲	—	—	—	—	
1200	Sport 8V (LPJ20/ LPR00/ LPR01)	2009/2013	065184	YTX20H-BS■	—	—	—	—	
1200	Sport 8V (LPJ20/ LPR00/ LPR01)	2009/2013	065187	YTX20CH-BS■	068187	ESTX20CH-BS■	—	—	
1200	Stelvio (LZ000)	2008/2009	065187	YTX20CH-BS■	068187	ESTX20CH-BS■	—	—	
1200	Stelvio 8V STD/ NTX (LZE00/ LZG00)	2011/2016	065187	YTX20CH-BS■	068187	ESTX20CH-BS■	—	—	
1200	Stelvio NTX ABS (LZA/ LZB)	2009/2010	065187	YTX20CH-BS■	068187	ESTX20CH-BS■	—	—	
1400	California Audace (LC000)	2015/2016	0650201	GYZ20H▲	—	—	—	—	
1400	California Audace (LC000)	2015/2016	065184	YTX20H-BS■	—	—	—	—	
1400	California Custom ABS (LV002)	2013/2016	0650201	GYZ20H▲	—	—	—	—	
1400	California Custom ABS (LV002)	2013/2016	065184	YTX20H-BS■	—	—	—	—	
1400	California Eldorado (LVB00)	2015/2016	0650201	GYZ20H▲	—	—	—	—	
1400	California Eldorado (LVB00)	2015/2016	065184	YTX20H-BS■	—	—	—	—	
1400	California Touring ABS (LVA02/ LVA03)	2013/2016	0650201	GYZ20H▲	—	—	—	—	
1400	California Touring ABS (LVA02/ LVA03)	2013/2016	065184	YTX20H-BS■	—	—	—	—	
1400	California Touring SE (LVE00)	2015/2016	0650201	GYZ20H▲	—	—	—	—	
1400	California Touring SE (LVE00)	2015/2016	065184	YTX20H-BS■	—	—	—	—	
MOTO MORINI									
125	Corsaro	</1988	0601113	6N11A-3A	—	—	—	—	
125	Country	TUTTI	0601113	6N11A-3A	—	—	—	—	
150	SS	TUTTI	0601113	6N11A-3A	—	—	—	—	
175	Sport	1954/1956	0600833	B49-6	—	—	—	—	
175	Turismo	1954/1956	0600833	B49-6	—	—	—	—	
350	Dart	1988/1994	065123	YTX14AHL-BS■	—	—	—	—	
350	Dart	1988/1994	0651434	YB14L-A2	0681434	ESB14L-A2■	—	—	
350	Excalibur / RLX	1986/>	0650202	GYZ20HL▲	—	—	—	—	
350	Excalibur / RLX	1986/>	0651834	YB18L-A	0681834	ESB18L-A■	—	—	
350	Excalibur / RLX	1986/>	065185	YTX20HL-BS■	—	—	—	—	



▲ - Factory Sealed / Attivata dalla Fabbrica ■ - con Acido a corredo ◇ - Non di produzione YUASA a completamento gamma

Marca / Cilindrata / Modello / Anno		Cod. SGR		Cod. SGR		Cod. SGR	
MOTO MORINI							
350	Kanguro	1988/>	0600211	6N2-2A-1	—	—	—
350	Kanguro	1990/>	0650202	GYZ20HL▲	—	—	—
350	Kanguro	1990/>	0651834	YB18L-A	0681834	ESB18L-A■	—
350	Kanguro	1990/>	065185	YTX20HL-BS■	—	—	—
350	New York	1990/>	0650202	GYZ20HL▲	—	—	—
350	New York	1990/>	0651834	YB18L-A	0681834	ESB18L-A■	—
350	New York	1990/>	065185	YTX20HL-BS■	—	—	—
350	Sport 2C	1973/1982	0650202	GYZ20HL▲	—	—	—
350	Sport 2C	1973/1982	0651834	YB18L-A	0681834	ESB18L-A■	—
350	Sport 2C	1973/1982	065185	YTX20HL-BS■	—	—	—
350	Sport 2C	1973/1982	0652015	52015	—	—	—
350	Sport bicil.	1980/>	0650933	12N9-3B	0680933	ES12N9-3B■	—
500	Enduro	TUTTI	0600211	6N2-2A-1	—	—	—
500	Sport 2C	1979/1987	0652711	6MC4 ◇	—	—	—
501	Camel	1988/1988	0650202	GYZ20HL▲	—	—	—
501	Camel	1988/1988	0651834	YB18L-A	0681834	ESB18L-A■	—
501	Camel	1988/1988	065185	YTX20HL-BS■	—	—	—
501	Coguardo	1989/1989	0650202	GYZ20HL▲	—	—	—
501	Coguardo	1989/1989	0651834	YB18L-A	0681834	ESB18L-A■	—
501	Coguardo	1989/1989	065185	YTX20HL-BS■	—	—	—
501	Excalibur	1990/>	0650202	GYZ20HL▲	—	—	—
501	Excalibur	1990/>	0651834	YB18L-A	0681834	ESB18L-A■	—
501	Excalibur	1990/>	065185	YTX20HL-BS■	—	—	—
501	New York	1989/1989	0650202	GYZ20HL▲	—	—	—
501	New York	1989/1989	0651834	YB18L-A	0681834	ESB18L-A■	—
501	New York	1989/1989	065185	YTX20HL-BS■	—	—	—
1200	9 1/2	2006/2010	065187	YTX20CH-BS■	068187	ESTX20CH-BS■	—
1200	Corsaro	2005/2010	065187	YTX20CH-BS■	068187	ESTX20CH-BS■	—
1200	Granpasso	2008/2010	065187	YTX20CH-BS■	068187	ESTX20CH-BS■	—
1200	Scrambler	2009/2010	065187	YTX20CH-BS■	068187	ESTX20CH-BS■	—
1200	Sport	2008/2010	065187	YTX20CH-BS■	068187	ESTX20CH-BS■	—
MOTRON							
50	Compact Racing RZ1	TUTTI	06504340	YB4L-B	—	—	—
50	Compact Racing RZ1	TUTTI	065043410	YB4L-B■	0680434	ESB4L-B■	—
50	Invader	TUTTI	06504340	YB4L-B	—	—	—
50	Invader	TUTTI	065043410	YB4L-B■	0680434	ESB4L-B■	—
50	Spike	TUTTI	06504340	YB4L-B	—	—	—
50	Spike	TUTTI	065043410	YB4L-B■	0680434	ESB4L-B■	—
50	Sting	TUTTI	06504340	YB4L-B	—	—	—
50	Sting	TUTTI	065043410	YB4L-B■	0680434	ESB4L-B■	—
50	Syncro	TUTTI	06504340	YB4L-B	—	—	—



▲ - Factory Sealed / Attivata dalla Fabbrica ■ - con Acido a corredo ◇ - Non di produzione YUASA a completamento gamma

Marca / Cilindrata / Modello / Anno		Cod. SGR		Cod. SGR		Cod. SGR	
MOTRON							
50 Syncro	TUTTI	065043410	YB4L-B■	0680434	ESB4L-B■	—	—
50 Thunder	TUTTI	06504340	YB4L-B	—	—	—	—
50 Thunder	TUTTI	065043410	YB4L-B■	0680434	ESB4L-B■	—	—
50 XLE	TUTTI	06504340	YB4L-B	—	—	—	—
50 XLE	TUTTI	065043410	YB4L-B■	0680434	ESB4L-B■	—	—
MV AGUSTA							
675 Brutale (B310AA)	2011/2015	065010	YTZ10S▲	—	—	063010	FTZ10S▲
675 Brutale (B310AA)	2011/2015	065910	TTZ10S-BS	068910	ESTTZ10S-BS■	—	—
675 F3 (F310ABCV)	2012/2013	065010	YTZ10S▲	—	—	063010	FTZ10S▲
675 F3 (F310ABCV)	2012/2013	065910	TTZ10S-BS	068910	ESTTZ10S-BS■	—	—
675 F3 ORO (F310ABCV)	2012/2013	065010	YTZ10S▲	—	—	063010	FTZ10S▲
675 F3 ORO (F310ABCV)	2012/2013	065910	TTZ10S-BS	068910	ESTTZ10S-BS■	—	—
750 Brutale / S (F410AA/ F411AA)	2001/2009	065010	YTZ10S▲	—	—	063010	FTZ10S▲
750 Brutale / S (F410AA/ F411AA)	2001/2009	0650990	YTX9-BS■	068099	ESTX9-BS■	063099	FTX9-BS■
750 Brutale / S (F410AA/ F411AA)	2001/2009	065910	TTZ10S-BS	068910	ESTTZ10S-BS■	—	—
750 Brutale ORO	2009/2009	065010	YTZ10S▲	—	—	063010	FTZ10S▲
750 Brutale ORO	2009/2009	0650990	YTX9-BS■	068099	ESTX9-BS■	063099	FTX9-BS■
750 Brutale ORO	2009/2009	065910	TTZ10S-BS	068910	ESTTZ10S-BS■	—	—
750 F4	1999/2006	0650990	YTX9-BS■	068099	ESTX9-BS■	063099	FTX9-BS■
800 Brutale	2012/2015	065010	YTZ10S▲	—	—	063010	FTZ10S▲
800 Brutale	2012/2015	065910	TTZ10S-BS	068910	ESTTZ10S-BS■	—	—
800 Brutale Dragster	2014/2015	065010	YTZ10S▲	—	—	063010	FTZ10S▲
800 Brutale Dragster	2014/2015	065910	TTZ10S-BS	068910	ESTTZ10S-BS■	—	—
800 Brutale Dragster RR	2015/2015	065010	YTZ10S▲	—	—	063010	FTZ10S▲
800 Brutale Dragster RR	2015/2015	065910	TTZ10S-BS	068910	ESTTZ10S-BS■	—	—
800 Brutale RR	2015/2015	065010	YTZ10S▲	—	—	063010	FTZ10S▲
800 Brutale RR	2015/2015	065910	TTZ10S-BS	068910	ESTTZ10S-BS■	—	—
800 F3	2014/2014	065010	YTZ10S▲	—	—	063010	FTZ10S▲
800 F3	2014/2014	065910	TTZ10S-BS	068910	ESTTZ10S-BS■	—	—
800 Rivale (S310AA)	2013/2015	065010	YTZ10S▲	—	—	063010	FTZ10S▲
800 Rivale (S310AA)	2013/2015	065910	TTZ10S-BS	068910	ESTTZ10S-BS■	—	—
800 Stradale (S320BA)	2015/2015	065010	YTZ10S▲	—	—	063010	FTZ10S▲
800 Stradale (S320BA)	2015/2015	065910	TTZ10S-BS	068910	ESTTZ10S-BS■	—	—
910 Brutale R	2006/2011	065010	YTZ10S▲	—	—	063010	FTZ10S▲
910 Brutale R	2006/2011	065910	TTZ10S-BS	068910	ESTTZ10S-BS■	—	—
910 Brutale S	2005/2010	065010	YTZ10S▲	—	—	063010	FTZ10S▲
910 Brutale S	2005/2010	065910	TTZ10S-BS	068910	ESTTZ10S-BS■	—	—
920 Brutale	2011/2012	065010	YTZ10S▲	—	—	063010	FTZ10S▲
920 Brutale	2011/2012	065910	TTZ10S-BS	068910	ESTTZ10S-BS■	—	—
989 Brutale R (F412AA)	2008/2009	065010	YTZ10S▲	—	—	063010	FTZ10S▲
990 Brutale R (B510AA)	2010/2011	065010	YTZ10S▲	—	—	063010	FTZ10S▲

▲ - Factory Sealed / Attivata dalla Fabbrica ■ - con Acido a corredo ◇ - Non di produzione YUASA a completamento gamma

Marca / Cilindrata / Modello / Anno		Cod. SGR		Cod. SGR		Cod. SGR	
MV AGUSTA							
990	Brutale R (B510AA)	2010/2011	065910	TTZ10S-BS	068910	ESTTZ10S-BS■	— —
1000	F4 (F511BB)	2004/2006	065010	YTZ10S▲	—	—	063010 FTZ10S▲
1000	F4 (F511BB)	2004/2006	065910	TTZ10S-BS	068910	ESTTZ10S-BS■	— —
1000	F4 (F630ABDV)	2013/2015	065010	YTZ10S▲	—	—	063010 FTZ10S▲
1000	F4 (F630ABDV)	2013/2015	065910	TTZ10S-BS	068910	ESTTZ10S-BS■	— —
1000	F4 FT (F610AA)	2010/2012	065010	YTZ10S▲	—	—	063010 FTZ10S▲
1000	F4 FT (F610AA)	2010/2012	065910	TTZ10S-BS	068910	ESTTZ10S-BS■	— —
1000	F4 R (F511AB)	2006/2007	065010	YTZ10S▲	—	—	063010 FTZ10S▲
1000	F4 R (F511AB)	2006/2007	065910	TTZ10S-BS	068910	ESTTZ10S-BS■	— —
1000	F4 R (F630ABDV)	2013/2014	065010	YTZ10S▲	—	—	063010 FTZ10S▲
1000	F4 R (F630ABDV)	2013/2014	065910	TTZ10S-BS	068910	ESTTZ10S-BS■	— —
1000	F4 RR (F630ABDV)	2013/2014	065010	YTZ10S▲	—	—	063010 FTZ10S▲
1000	F4 RR (F630ABDV)	2013/2014	065910	TTZ10S-BS	068910	ESTTZ10S-BS■	— —
1000	F4 RR 312R (F511BA/ BB)	2007/2009	065010	YTZ10S▲	—	—	063010 FTZ10S▲
1000	F4 RR 312R (F511BA/ BB)	2007/2009	065910	TTZ10S-BS	068910	ESTTZ10S-BS■	— —
1000	F4 S (F610AA)	2010/2012	065010	YTZ10S▲	—	—	063010 FTZ10S▲
1000	F4 S (F610AA)	2010/2012	065910	TTZ10S-BS	068910	ESTTZ10S-BS■	— —
1000	F4 Veltro	2008/2008	065010	YTZ10S▲	—	—	063010 FTZ10S▲
1000	F4 Veltro	2008/2008	065910	TTZ10S-BS	068910	ESTTZ10S-BS■	— —
1078	Brutale RR (F413AA)	2008/2010	065010	YTZ10S▲	—	—	063010 FTZ10S▲
1078	F4 100CC (F511CB)	2007/2008	065010	YTZ10S▲	—	—	063010 FTZ10S▲
1078	F4 100CC (F511CB)	2007/2008	065910	TTZ10S-BS	068910	ESTTZ10S-BS■	— —
1078	F4 RR 312R (F511DA/ DB)	2007/2011	065010	YTZ10S▲	—	—	063010 FTZ10S▲
1078	F4 RR 312R (F511DA/ DB)	2007/2011	065910	TTZ10S-BS	068910	ESTTZ10S-BS■	— —
1090	Brutale (JDFVU5BV/ B520ABDV)	2013/2013	065010	YTZ10S▲	—	—	063010 FTZ10S▲
1090	Brutale (JDFVU5BV/ B520ABDV)	2013/2013	065910	TTZ10S-BS	068910	ESTTZ10S-BS■	— —
1090	Brutale R (JDFVU5BV/ B520ABDV)	2012/2013	065010	YTZ10S▲	—	—	063010 FTZ10S▲
1090	Brutale R (JDFVU5BV/ B520ABDV)	2012/2013	065910	TTZ10S-BS	068910	ESTTZ10S-BS■	— —
1090	Brutale RR (B520AA/ JDFVU5BV/ B520ABDV)	2010/2013	065010	YTZ10S▲	—	—	063010 FTZ10S▲
1090	Brutale RR (B520AA/ JDFVU5BV/ B520ABDV)	2010/2013	065910	TTZ10S-BS	068910	ESTTZ10S-BS■	— —
PEUGEOT							
50	Buxi	1994/1997	06504340	YB4L-B	—	—	— —
50	Buxi	1994/1997	065043410	YB4L-B■	0680434	ESB4L-B■	— —
50	Buxy RS	1994/1997	06504340	YB4L-B	—	—	— —
50	Buxy RS	1994/1997	065043410	YB4L-B■	0680434	ESB4L-B■	— —
50	Elyseo	1999/2003	06504340	YB4L-B	—	—	— —
50	Elyseo	1999/2003	065043410	YB4L-B■	0680434	ESB4L-B■	— —
50	Elystar TDSI	2003/2005	0650987	YTX9A-BS ◇■	—	—	— —
50	Fox/ Fox L	1994/1998	06504340	YB4L-B	—	—	— —
50	Fox/ Fox L	1994/1998	065043410	YB4L-B■	0680434	ESB4L-B■	— —
50	Jet Force	2003/>	0650739	YB7L-B2	0680739	ESB7L-B2■	— —

▲ - Factory Sealed / Attivata dalla Fabbrica ■ - con Acido a corredo ◇ - Non di produzione YUASA a completamento gamma

Marca / Cilindrata / Modello / Anno			Cod. SGR		Cod. SGR		Cod. SGR	
PEUGEOT								
50	Kisbee/ RS 4T	2010/2013	06504340	YB4L-B	—	—	—	—
50	Kisbee/ RS 4T	2010/2013	065043410	YB4L-B■	0680434	ESB4L-B■	—	—
50	Looxor Carb.	2001/2003	06504340	YB4L-B	—	—	—	—
50	Looxor Carb.	2001/2003	065043410	YB4L-B■	0680434	ESB4L-B■	—	—
50	Looxor TSDI	2002/2002	0650987	YTX9A-BS ◇■	—	—	—	—
50	Ludix 10 SP Blaster	2005/2011	06504340	YB4L-B	—	—	—	—
50	Ludix 10 SP Blaster	2005/2011	065043410	YB4L-B■	0680434	ESB4L-B■	—	—
50	Ludix Blaster RS 12	2008/2013	06504340	YB4L-B	—	—	—	—
50	Ludix Blaster RS 12	2008/2013	065043410	YB4L-B■	0680434	ESB4L-B■	—	—
50	SC LI Metropolis	1991/1991	06504340	YB4L-B	—	—	—	—
50	SC LI Metropolis	1991/1991	065043410	YB4L-B■	0680434	ESB4L-B■	—	—
50	Speedake	1995/1997	06504340	YB4L-B	—	—	—	—
50	Speedake	1995/1997	065043410	YB4L-B■	0680434	ESB4L-B■	—	—
50	Speedfight Air	1997/1998	06504340	YB4L-B	—	—	—	—
50	Speedfight Air	1997/1998	065043410	YB4L-B■	0680434	ESB4L-B■	—	—
50	Speedfight AIR CAT C/ Antifurto	1999/2004	06504340	YB4L-B	—	—	—	—
50	Speedfight AIR CAT C/ Antifurto	1999/2004	065043410	YB4L-B■	0680434	ESB4L-B■	—	—
50	Speedfight AIR CAT S/ Antifurto	1999/2004	06504340	YB4L-B	—	—	—	—
50	Speedfight AIR CAT S/ Antifurto	1999/2004	065043410	YB4L-B■	0680434	ESB4L-B■	—	—
50	Speedfight LC DD	1997/1998	06504340	YB4L-B	—	—	—	—
50	Speedfight LC DD	1997/1998	065043410	YB4L-B■	0680434	ESB4L-B■	—	—
50	Speedfight LC DT	1997/1998	06504340	YB4L-B	—	—	—	—
50	Speedfight LC DT	1997/1998	065043410	YB4L-B■	0680434	ESB4L-B■	—	—
50	Squab	1995/1997	06504340	YB4L-B	—	—	—	—
50	Squab	1995/1997	065043410	YB4L-B■	0680434	ESB4L-B■	—	—
50	ST Rapido/ Rapido 3	1985/1997	06504340	YB4L-B	—	—	—	—
50	ST Rapido/ Rapido 3	1985/1997	065043410	YB4L-B■	0680434	ESB4L-B■	—	—
50	TKR R10 C/ Aantifurto	2004/2012	06504340	YB4L-B	—	—	—	—
50	TKR R10 C/ Aantifurto	2004/2012	065043410	YB4L-B■	0680434	ESB4L-B■	—	—
50	TKR R10 S/ Aantifurto	2004/2012	06504340	YB4L-B	—	—	—	—
50	TKR R10 S/ Aantifurto	2004/2012	065043410	YB4L-B■	0680434	ESB4L-B■	—	—
50	Trekker R10 C/ Antifurto	1998/2003	06504340	YB4L-B	—	—	—	—
50	Trekker R10 C/ Antifurto	1998/2003	065043410	YB4L-B■	0680434	ESB4L-B■	—	—
50	Trekker R10 S/ Antifurto	1998/2003	06504340	YB4L-B	—	—	—	—
50	Trekker R10 S/ Antifurto	1998/2003	065043410	YB4L-B■	0680434	ESB4L-B■	—	—
50	Trekker Road R12 C/ Antifurto	1998/2003	06504340	YB4L-B	—	—	—	—
50	Trekker Road R12 C/ Antifurto	1998/2003	065043410	YB4L-B■	0680434	ESB4L-B■	—	—
50	Trekker Road R12 S/ Antifurto	1998/2003	06504340	YB4L-B	—	—	—	—
50	Trekker Road R12 S/ Antifurto	1998/2003	065043410	YB4L-B■	0680434	ESB4L-B■	—	—
50	Tweet 4T DT (SYM)	2010/2013	06504340	YB4L-B	—	—	—	—
50	Tweet 4T DT (SYM)	2010/2013	065043410	YB4L-B■	0680434	ESB4L-B■	—	—

▲ - Factory Sealed / Attivata dalla Fabbrica ■ - con Acido a corredo ◇ - Non di produzione YUASA a completamento gamma





PEUGEOT



50	Tweet RS 4T DD (SYM)	2010/2013	06504340	YB4L-B	—	—	—	—
50	Tweet RS 4T DD (SYM)	2010/2013	065043410	YB4L-B■	0680434	ESB4L-B■	—	—
50	Vivacity 2T Kokusan	2010/2013	06504340	YB4L-B	—	—	—	—
50	Vivacity 2T Kokusan	2010/2013	065043410	YB4L-B■	0680434	ESB4L-B■	—	—
50	Vivacity C/ Antifurto AJP	1999/2007	06504340	YB4L-B	—	—	—	—
50	Vivacity C/ Antifurto AJP	1999/2007	065043410	YB4L-B■	0680434	ESB4L-B■	—	—
50	Vivacity C/ Antifurto HengTong	1999/2007	06504340	YB4L-B	—	—	—	—
50	Vivacity C/ Antifurto HengTong	1999/2007	065043410	YB4L-B■	0680434	ESB4L-B■	—	—
50	Vivacity New 2T C/ Antifurto	2007/2009	06504340	YB4L-B	—	—	—	—
50	Vivacity New 2T C/ Antifurto	2007/2009	065043410	YB4L-B■	0680434	ESB4L-B■	—	—
50	Vivacity New 2T S/ Antifurto	2007/2009	06504340	YB4L-B	—	—	—	—
50	Vivacity New 2T S/ Antifurto	2007/2009	065043410	YB4L-B■	0680434	ESB4L-B■	—	—
50	Vivacity S/ Antifurto AJP	1999/2007	06504340	YB4L-B	—	—	—	—
50	Vivacity S/ Antifurto AJP	1999/2007	065043410	YB4L-B■	0680434	ESB4L-B■	—	—
50	Vivacity S/ Antifurto HengTong	1999/2007	06504340	YB4L-B	—	—	—	—
50	Vivacity S/ Antifurto HengTong	1999/2007	065043410	YB4L-B■	0680434	ESB4L-B■	—	—
50	X Fight Air	2000/2000	06504340	YB4L-B	—	—	—	—
50	X Fight Air	2000/2000	065043410	YB4L-B■	0680434	ESB4L-B■	—	—
50	X Fight Lc	2000/>	06504340	YB4L-B	—	—	—	—
50	X Fight Lc	2000/>	065043410	YB4L-B■	0680434	ESB4L-B■	—	—
50	Zenith L/ LM	1994/1998	06504340	YB4L-B	—	—	—	—
50	Zenith L/ LM	1994/1998	065043410	YB4L-B■	0680434	ESB4L-B■	—	—
80	SC LI Metropolis	TUTTI	06504340	YB4L-B	—	—	—	—
80	SC LI Metropolis	TUTTI	065043410	YB4L-B■	0680434	ESB4L-B■	—	—
100	Elyseo	1999/1999	0650739	YB7L-B2	0680739	ESB7L-B2■	—	—
100	Elyseo	2000/2001	065049	YTX5L-BS■	068049	ESTX5L-BS■	063049	FTX5L-BS■
100	Looxor	2001/>	065049	YTX5L-BS■	068049	ESTX5L-BS■	063049	FTX5L-BS■
100	Speedfight / Speedfight2	1997/2000	065049	YTX5L-BS■	068049	ESTX5L-BS■	063049	FTX5L-BS■
100	SV Geo	1998/1998	0650739	YB7L-B2	0680739	ESB7L-B2■	—	—
100	Trekker	1998/1998	065049	YTX5L-BS■	068049	ESTX5L-BS■	063049	FTX5L-BS■
100	Vivacity	1999/2000	065049	YTX5L-BS■	068049	ESTX5L-BS■	063049	FTX5L-BS■
100	X Fight	2000/2003	065049	YTX5L-BS■	068049	ESTX5L-BS■	063049	FTX5L-BS■
125	Elyseo	1999/2000	0650736	YB7-A	0680736	ESB7-A■	—	—
125	Elyseo	2001/2002	0650736	YB7-A	0680736	ESB7-A■	—	—
125	Elystar	2002/2004	0650736	YB7-A	0680736	ESB7-A■	—	—
125	Elystar	2005/2006	06512360	YB12AL-A	0681236	ESB12AL-A■	—	—
125	Elystar	2005/2006	06512400	YB12AL-A2	0681240	ESB12AL-A2■	—	—
125	Geopolis Executive/ Premium/ E 4T	2007/>	06512360	YB12AL-A	0681236	ESB12AL-A■	—	—
125	Geopolis Executive/ Premium/ E 4T	2007/>	06512400	YB12AL-A2	0681240	ESB12AL-A2■	—	—
125	Jet Force / Jet Force Abs	2003/2004	0650736	YB7-A	0680736	ESB7-A■	—	—
125	Looxor	2002/2003	06509350	YB9-B	0680935	ESB9-B■	—	—

Marca / Cilindrata / Modello / Anno			Cod. SGR		Cod. SGR		Cod. SGR		
PEUGEOT									
125	Satelis / RS/ Ex./ Pre./ E/ Urban 4T-4V-IE	2006/>	06512360	YB12AL-A	0681236	ESB12AL-A■	—	—	
125	Satelis / RS/ Ex./ Pre./ E/ Urban 4T-4V-IE	2006/>	06512400	YB12AL-A2	0681240	ESB12AL-A2■	—	—	
125	Satelis / RS/ Ex./ Pre./ E/ Urban 4T-4V-IE ABS	2006/2012	06512360	YB12AL-A	0681236	ESB12AL-A■	—	—	
125	Satelis / RS/ Ex./ Pre./ E/ Urban 4T-4V-IE ABS	2006/2012	06512400	YB12AL-A2	0681240	ESB12AL-A2■	—	—	
125	Satelis Compressor BS/ WS (VGAJ2ABAA)	2006/2012	06512360	YB12AL-A	0681236	ESB12AL-A■	—	—	
125	Satelis Compressor BS/ WS (VGAJ2ABAA)	2006/2012	06512400	YB12AL-A2	0681240	ESB12AL-A2■	—	—	
125	SV Geo	1991/1995	0650534	YB5L-B	0680534	ESB5L-B■	—	—	
150	Elyseo	2001/2002	0650736	YB7-A	0680736	ESB7-A■	—	—	
150	Elystar	2002/2004	0650736	YB7-A	0680736	ESB7-A■	—	—	
150	Elystar	2005/2006	06512360	YB12AL-A	0681236	ESB12AL-A■	—	—	
150	Elystar	2005/2006	06512400	YB12AL-A2	0681240	ESB12AL-A2■	—	—	
150	Looxor	2002/2003	06509350	YB9-B	0680935	ESB9-B■	—	—	
250	Geopolis	2006/2008	06512360	YB12AL-A	0681236	ESB12AL-A■	—	—	
250	Geopolis	2006/2008	06512400	YB12AL-A2	0681240	ESB12AL-A2■	—	—	
250	Satelis	2006/2008	06512360	YB12AL-A	0681236	ESB12AL-A■	—	—	
250	Satelis	2006/2008	06512400	YB12AL-A2	0681240	ESB12AL-A2■	—	—	
250	SV	2001/2002	0651090	YTX12-BS■	0681090	ESTX12-BS■	063109	FTX12-BS■	
400	Geopolis	2006/2008	06512360	YB12AL-A	0681236	ESB12AL-A■	—	—	
400	Geopolis	2006/2008	06512400	YB12AL-A2	0681240	ESB12AL-A2■	—	—	
400	Satelis	2006/2008	06512360	YB12AL-A	0681236	ESB12AL-A■	—	—	
400	Satelis	2006/2008	06512400	YB12AL-A2	0681240	ESB12AL-A2■	—	—	
500	Geopolis	2006/2008	06512360	YB12AL-A	0681236	ESB12AL-A■	—	—	
500	Geopolis	2006/2008	06512400	YB12AL-A2	0681240	ESB12AL-A2■	—	—	
500	Satelis	2006/2008	06512360	YB12AL-A	0681236	ESB12AL-A■	—	—	
500	Satelis	2006/2008	06512400	YB12AL-A2	0681240	ESB12AL-A2■	—	—	
PGO									
50	Big Max 2T / Big Max E2 2T	TUTTI	06504340	YB4L-B	—	—	—	—	
50	Big Max 2T / Big Max E2 2T	TUTTI	065043410	YB4L-B■	0680434	ESB4L-B■	—	—	
50	Comet 2T	1992/2003	0650390	YTX4L-BS■	068039	ESTX4L-BS■	—	—	
50	Galaxy 2T	1992/>	0650390	YTX4L-BS■	068039	ESTX4L-BS■	—	—	
50	Star - Star II	TUTTI	06504340	YB4L-B	—	—	—	—	
50	Star - Star II	TUTTI	065043410	YB4L-B■	0680434	ESB4L-B■	—	—	
PIAGGIO									
50	Ape (C8000) Cross Rst/ Cross Cauntry	1999/2003	0653211	6MK5 ◇	—	—	—	—	
50	Ape (C8000) Cross Rst/ Cross Cauntry	2004/2013	0654310	54310 ◇	—	—	—	—	
50	Ape (C8000) MIX/ TOP/ VPC/ VPL/ VF	1999/2013	06509350	YB9-B	0680935	ESB9-B■	—	—	
50	Ape (C8000) MIX/ TOP/ VPC/ VPL/ VF	2009/2013	0654310	54310 ◇	—	—	—	—	
50	Ape FL (TL6T)	1989/1993	0653211	6MK5 ◇	—	—	—	—	
50	Ape FL2 (TL6T)	1994/1995	0653211	6MK5 ◇	—	—	—	—	
50	Ape FL3 (TL5T) Cross	1995/1998	0653211	6MK5 ◇	—	—	—	—	
50	Ape FL3 Europa (TL5T)	1995/1999	06509350	YB9-B	0680935	ESB9-B■	—	—	



▲ - Factory Sealed / Attivata dalla Fabbrica ■ - con Acido a corredo ◇ - Non di produzione YUASA a completamento gamma

Marca / Cilindrata / Modello / Anno		Cod. SGR		Cod. SGR		Cod. SGR	
PIAGGIO							
50	Ape FL3 NU	1995/1999	0654310	54310 ◇	—	—	—
50	Ape P (TL3T) 12V AVV.ELETTRICO	1984/1985	0652711	6MC4 ◇	—	—	—
50	Ape TMP (TL4T) Elestart	1985/1989	0652711	6MC4 ◇	—	—	—
50	Diesis	2002/2004	06504340	YB4L-B	—	—	—
50	Diesis	2002/2004	065043410	YB4L-B■	0680434	ESB4L-B■	—
50	FLY 2T (C44100/ C44700/ RP8C523)	2005/2015	06504340	YB4L-B	—	—	—
50	FLY 2T (C44100/ C44700/ RP8C523)	2005/2015	065043410	YB4L-B■	0680434	ESB4L-B■	—
50	FLY 4T (C44200/ C44500)	2005/2012	06509350	YB9-B	0680935	ESB9-B■	—
50	FLY 4T 2V (RP8C522/ RP8C523)	2012/2015	0650690	YTX7L-BS■	068069	ESTX7L-BS■	063069
50	FLY 4T 4V (RP8C521)	2012/2013	0650690	YTX7L-BS■	068069	ESTX7L-BS■	063069
50	Free base	1992/1994	06504340	YB4L-B	—	—	—
50	Free base	1992/1994	065043410	YB4L-B■	0680434	ESB4L-B■	—
50	Free Delivery	2000/2001	0650390	YTX4L-BS■	068039	ESTX4L-BS■	—
50	Free FL/ FL2	1995/1999	06504340	YB4L-B	—	—	—
50	Free FL/ FL2	1995/1999	065043410	YB4L-B■	0680434	ESB4L-B■	—
50	Liberty 2T (C1500)	1997/2003	0650390	YTX4L-BS■	068039	ESTX4L-BS■	—
50	Liberty 2T (C1500)	1997/2003	06504340	YB4L-B	—	—	—
50	Liberty 2T (C1500)	1997/2003	065043410	YB4L-B■	0680434	ESB4L-B■	—
50	Liberty 2T (C42500)	2007/2008	06509350	YB9-B	0680935	ESB9-B■	—
50	Liberty 2T E2 PTT (C37401)	2004/2007	0650390	YTX4L-BS■	068039	ESTX4L-BS■	—
50	Liberty 2T MOC (C49100)	2009/2015	06509350	YB9-B	0680935	ESB9-B■	—
50	Liberty 2T Rst (C42100)	2004/2006	06504340	YB4L-B	—	—	—
50	Liberty 2T Rst (C42100)	2004/2006	065043410	YB4L-B■	0680434	ESB4L-B■	—
50	Liberty 2T Sport (C42106/ C42501)	2006/2008	06509350	YB9-B	0680935	ESB9-B■	—
50	Liberty 4T (C2800)	2000/2003	06509350	YB9-B	0680935	ESB9-B■	—
50	Liberty 4T (C42400)	2005/2008	06509350	YB9-B	0680935	ESB9-B■	—
50	Liberty 4T Delivery TNT / Single (C42401)	2009/2014	06509350	YB9-B	0680935	ESB9-B■	—
50	Liberty 4T MOC (C49200)	2009/2015	06509350	YB9-B	0680935	ESB9-B■	—
50	Liberty 4T PTT - DOUBLE (C42404)	2009/2012	06509350	YB9-B	0680935	ESB9-B■	—
50	Liberty 4T PTT (DEU) (C42406)	2007/2012	06509350	YB9-B	0680935	ESB9-B■	—
50	Liberty 4T RST (C42200)	2004/2005	06509350	YB9-B	0680935	ESB9-B■	—
50	Liberty 4T Sport (C42405)	2006/2008	06509350	YB9-B	0680935	ESB9-B■	—
50	NRG DD	1994/1996	06504340	YB4L-B	—	—	—
50	NRG DD	1994/1996	065043410	YB4L-B■	0680434	ESB4L-B■	—
50	NRG DT	1994/1996	06504340	YB4L-B	—	—	—
50	NRG DT	1994/1996	065043410	YB4L-B■	0680434	ESB4L-B■	—
50	NRG Extreme DD	1999/2001	0650390	YTX4L-BS■	068039	ESTX4L-BS■	—
50	NRG Extreme DT	1999/2001	0650390	YTX4L-BS■	068039	ESTX4L-BS■	—
50	NRG Extreme MC2 DD	1996/1998	06504340	YB4L-B	—	—	—
50	NRG Extreme MC2 DD	1996/1998	065043410	YB4L-B■	0680434	ESB4L-B■	—
50	NRG Extreme MC2 DT	1996/1998	06504340	YB4L-B	—	—	—



▲ - Factory Sealed / Attivata dalla Fabbrica ■ - con Acido a corredo ◇ - Non di produzione YUASA a completamento gamma

Marca / Cilindrata / Modello / Anno			Cod. SGR		Cod. SGR		Cod. SGR	
PIAGGIO								
50	NRG Extreme MC2 DT	1996/1998	065043410	YB4L-B■	0680434	ESB4L-B■	—	—
50	NRG MC3 DD LC	2001/2004	06504340	YB4L-B	—	—	—	—
50	NRG MC3 DD LC	2001/2004	065043410	YB4L-B■	0680434	ESB4L-B■	—	—
50	NRG MC3 DT Air	2001/2004	06504340	YB4L-B	—	—	—	—
50	NRG MC3 DT Air	2001/2004	065043410	YB4L-B■	0680434	ESB4L-B■	—	—
50	NRG Power DD (C45100)	2012/2015	06504340	YB4L-B	—	—	—	—
50	NRG Power DD (C45100)	2012/2015	065043410	YB4L-B■	0680434	ESB4L-B■	—	—
50	NRG Power DD (C45100)	2005/2006	06504340	YB4L-B	—	—	—	—
50	NRG Power DD (C45100)	2005/2006	065043410	YB4L-B■	0680434	ESB4L-B■	—	—
50	NRG Power DD (C45100)	2007/2012	06509350	YB9-B	0680935	ESB9-B■	—	—
50	NRG Power DT (C45300)	2005/2006	06504340	YB4L-B	—	—	—	—
50	NRG Power DT (C45300)	2005/2006	065043410	YB4L-B■	0680434	ESB4L-B■	—	—
50	NRG Power DT (C45300)	2007/2015	06509350	YB9-B	0680935	ESB9-B■	—	—
50	NRG Power Purejet (C45200)	2004/2012	06509350	YB9-B	0680935	ESB9-B■	—	—
50	NRG Purejet (C32001)	2002/2004	06509350	YB9-B	0680935	ESB9-B■	—	—
50	NRG Purejet (C45200)	2010/2012	06509350	YB9-B	0680935	ESB9-B■	—	—
50	NTT	1995/1996	06504340	YB4L-B	—	—	—	—
50	NTT	1995/1996	065043410	YB4L-B■	0680434	ESB4L-B■	—	—
50	Quartz	1992/1996	06504340	YB4L-B	—	—	—	—
50	Quartz	1992/1996	065043410	YB4L-B■	0680434	ESB4L-B■	—	—
50	Scatto (TVPIIT)	1992/1993	0650534	YB5L-B	0680534	ESB5L-B■	—	—
50	Sfera - Sfera Maquillage 2	1994/1995	06504340	YB4L-B	—	—	—	—
50	Sfera - Sfera Maquillage 2	1994/1995	065043410	YB4L-B■	0680434	ESB4L-B■	—	—
50	Sfera FL Rst	1995/1997	06504340	YB4L-B	—	—	—	—
50	Sfera FL Rst	1995/1997	065043410	YB4L-B■	0680434	ESB4L-B■	—	—
50	Typhoon 2T / E2 (C29000/ C48100)	2001/2004	06504340	YB4L-B	—	—	—	—
50	Typhoon 2T / E2 (C29000/ C48100)	2001/2004	065043410	YB4L-B■	0680434	ESB4L-B■	—	—
50	Typhoon 2T / E2 (C29000/ C48100)	2005/2011	06509350	YB9-B	0680935	ESB9-B■	—	—
50	Typhoon 2T E2 R12 (LBMC501)	2010/2015	06509350	YB9-B	0680935	ESB9-B■	—	—
50	Velofax	1996/1999	06504340	YB4L-B	—	—	—	—
50	Velofax	1996/1999	065043410	YB4L-B■	0680434	ESB4L-B■	—	—
50	Vespa Elestart (V5A3T)	1970/1972	0601113	6N11A-3A	—	—	—	—
50	Vespa Elestart (V5B2T)	1972/1975	0601113	6N11A-3A	—	—	—	—
50	Vespa Elestart (V5B4T)	1975/1976	0601113	6N11A-3A	—	—	—	—
50	Vespa ET2	1997/1999	06504340	YB4L-B	—	—	—	—
50	Vespa ET2	1997/1999	065043410	YB4L-B■	0680434	ESB4L-B■	—	—
50	Vespa ET2 (sigillata)	1997/2005	0650390	YTX4L-BS■	068039	ESTX4L-BS■	—	—
50	Vespa ET2 IE	1997/1999	0650534	YB5L-B	0680534	ESB5L-B■	—	—
50	Vespa ET4 (C26100)	2000/2005	06509350	YB9-B	0680935	ESB9-B■	—	—
50	Vespa FL (V5N1)	1990/1990	0650534	YB5L-B	0680534	ESB5L-B■	—	—
50	Vespa FL2 Automatica (V5P2T)	1990/1991	0650534	YB5L-B	0680534	ESB5L-B■	—	—



▲ - Factory Sealed / Attivata dalla Fabbrica ■ - con Acido a corredo ◇ - Non di produzione YUASA a completamento gamma

Marca / Cilindrata / Modello / Anno			Cod. SGR		Cod. SGR		Cod. SGR		
PIAGGIO									
50	Vespa FL2 HP (V5N2T)	1991/1997	0650736	YB7-A	0680736	ESB7-A■	—	—	
50	Vespa LX 2T (C38101)	2005/2008	06504340	YB4L-B	—	—	—	—	
50	Vespa LX 2T (C38101)	2005/2008	065043410	YB4L-B■	0680434	ESB4L-B■	—	—	
50	Vespa LX 2T (C38101)	2009/2013	06509350	YB9-B	0680935	ESB9-B■	—	—	
50	Vespa LX 2T Touring (C38101)	2010/2013	06509350	YB9-B	0680935	ESB9-B■	—	—	
50	Vespa LX 4T (C38300)	2005/2008	06509350	YB9-B	0680935	ESB9-B■	—	—	
50	Vespa LX 4T 4V (C38700)	2009/2013	06509350	YB9-B	0680935	ESB9-B■	—	—	
50	Vespa LX 4T 4V Touring (C38700)	2010/2013	06509350	YB9-B	0680935	ESB9-B■	—	—	
50	Vespa LXV 2T (C38102)	2006/2010	06509350	YB9-B	0680935	ESB9-B■	—	—	
50	Vespa LXV 2T Navy (C38102)	2008/2009	06509350	YB9-B	0680935	ESB9-B■	—	—	
50	Vespa LXV 4T	2005/2008	06509350	YB9-B	0680935	ESB9-B■	—	—	
50	Vespa N (V5X5T)	1989/1990	0650736	YB7-A	0680736	ESB7-A■	—	—	
50	Vespa N AE (V5X5T)	1989/1990	0650736	YB7-A	0680736	ESB7-A■	—	—	
50	Vespa PK S (V5X2T)	1982/1985	0650534	YB5L-B	0680534	ESB5L-B■	—	—	
50	Vespa PK S Automatica (VA51T)	1984/1989	0650736	YB7-A	0680736	ESB7-A■	—	—	
50	Vespa PK SS (V5S1T)	1983/1985	0650534	YB5L-B	0680534	ESB5L-B■	—	—	
50	Vespa PK XL Rush (V5X4T)	1988/1989	0650736	YB7-A	0680736	ESB7-A■	—	—	
50	Vespa PK XL Rush AE (V5X4T)	1988/1989	0650736	YB7-A	0680736	ESB7-A■	—	—	
50	Vespa Primavera 2T (C53200)	2013/2015	06504340	YB4L-B	—	—	—	—	
50	Vespa Primavera 2T (C53200)	2013/2015	065043410	YB4L-B■	0680434	ESB4L-B■	—	—	
50	Vespa Primavera 4T 4V (C53100)	2013/2015	0650690	YTX7L-BS■	068069	ESTX7L-BS■	063069	FTX7L-BS■	
50	Vespa S 2T (C38103)	2007/2014	06509350	YB9-B	0680935	ESB9-B■	—	—	
50	Vespa S 4T 4V (M38600)	2008/2014	06509350	YB9-B	0680935	ESB9-B■	—	—	
50	Vespa Sprint 2T (C53201)	2014/2015	06504340	YB4L-B	—	—	—	—	
50	Vespa Sprint 2T (C53201)	2014/2015	065043410	YB4L-B■	0680434	ESB4L-B■	—	—	
50	Vespa Sprint 4T 4V (C53101)	2014/2015	0650690	YTX7L-BS■	068069	ESTX7L-BS■	063069	FTX7L-BS■	
50	Zip 2T (C25E0)	2008/2014	06509350	YB9-B	0680935	ESB9-B■	—	—	
50	Zip 2T Cat. (C25000)	2000/2007	0650390	YTX4L-BS■	068039	ESTX4L-BS■	—	—	
50	Zip 4T (C250001/LBMC25C)	2000/2014	0650990	YTX9-BS■	068099	ESTX9-BS■	063099	FTX9-BS■	
50	Zip Base FD DT	1992/1995	06504340	YB4L-B	—	—	—	—	
50	Zip Base FD DT	1992/1995	065043410	YB4L-B■	0680434	ESB4L-B■	—	—	
50	Zip Base TT	1992/1995	06504340	YB4L-B	—	—	—	—	
50	Zip Base TT	1992/1995	065043410	YB4L-B■	0680434	ESB4L-B■	—	—	
50	Zip Fast Rider	1993/1994	06504340	YB4L-B	—	—	—	—	
50	Zip Fast Rider	1993/1994	065043410	YB4L-B■	0680434	ESB4L-B■	—	—	
50	Zip Fast Rider Rst	1996/1997	06504340	YB4L-B	—	—	—	—	
50	Zip Fast Rider Rst	1996/1997	065043410	YB4L-B■	0680434	ESB4L-B■	—	—	
50	Zip Rst - Zip Rst Disco	1996/1999	06504340	YB4L-B	—	—	—	—	
50	Zip Rst - Zip Rst Disco	1996/1999	065043410	YB4L-B■	0680434	ESB4L-B■	—	—	
50	Zip SP (C1100)	1996/2000	06504340	YB4L-B	—	—	—	—	
50	Zip SP (C1100)	1996/2000	065043410	YB4L-B■	0680434	ESB4L-B■	—	—	



▲ - Factory Sealed / Attivata dalla Fabbrica ■ - con Acido a corredo ◇ - Non di produzione YUASA a completamento gamma

Marca / Cilindrata / Modello / Anno			Cod. SGR		Cod. SGR		Cod. SGR	
PIAGGIO								
50	Zip SP / E2 Hiper2 (C250004/ C250009)	2001/2014	06504340	YB4L-B	—	—	—	—
50	Zip SP / E2 Hiper2 (C250004/ C250009)	2001/2014	065043410	YB4L-B■	0680434	ESB4L-B■	—	—
80	Sfera	TUTTI	0650736	YB7-A	0680736	ESB7-A■	—	—
80	Vespa PK S (V8X5T)	1982/1985	0650534	YB5L-B	0680534	ESB5L-B■	—	—
100	FLY 4T (M53100)	2005/2009	06509350	YB9-B	0680935	ESB9-B■	—	—
100	Free 4T (M2910)	2002/2006	0650990	YTX9-BS■	068099	ESTX9-BS■	063099	FTX9-BS■
100	Vespa PK S (V9X1T)	1982/1985	0650534	YB5L-B	0680534	ESB5L-B■	—	—
100	Zip 4T (M25200)	2002/2012	0650990	YTX9-BS■	068099	ESTX9-BS■	063099	FTX9-BS■
125	Beverly (M2810/ M2820)	2001/2003	06509350	YB9-B	0680935	ESB9-B■	—	—
125	Beverly (M2810/ M2820)	2001/2003	0651090	YTX12-BS■	0681090	ESTX12-BS■	063109	FTX12-BS■
125	Beverly Rst E3 4T-4V (M69100)	2010/2015	0651090	YTX12-BS■	0681090	ESTX12-BS■	063109	FTX12-BS■
125	Beverly Rst/ Rst E3/ MIC (M28400/ M28900)	2004/2006	06509350	YB9-B	0680935	ESB9-B■	—	—
125	Beverly Rst/ Rst E3/ MIC (M28400/ M28900)	2007/2009	0651090	YTX12-BS■	0681090	ESTX12-BS■	063109	FTX12-BS■
125	Beverly Sport E3 (M28900)	2007/2009	0651135	YB10L-B	0681135	ESB10L-B■	—	—
125	Beverly Tourer E3 (M28901)	2008/2010	0651135	YB10L-B	0681135	ESB10L-B■	—	—
125	Carnaby	2007/2012	0651135	YB10L-B	0681135	ESB10L-B■	—	—
125	Cosa 1 (VNRIT)	1988/1990	0650736	YB7-A	0680736	ESB7-A■	—	—
125	FLY / FLY E3 (M42100/ M57100/ M57200)	2005/2012	06509350	YB9-B	0680935	ESB9-B■	—	—
125	FLY 4T 3V IE E3 DT	2013/2015	0650690	YTX7L-BS■	068069	ESTX7L-BS■	063069	FTX7L-BS■
125	FLY 4T 3V IE E3 LEM (RP8791)	2012/2014	0651100	YT12B-BS■	0681100	EST12B-BS■	—	—
125	Hexagon	1994/1997	06509350	YB9-B	0680935	ESB9-B■	—	—
125	Hexagon GTX 11 (M2000000)	2000/2000	0651090	YTX12-BS■	0681090	ESTX12-BS■	063109	FTX12-BS■
125	Hexagon GTX 11 (M2000000)	2000/2000	0651135	YB10L-B	0681135	ESB10L-B■	—	—
125	Hexagon LX	1998/1999	06509350	YB9-B	0680935	ESB9-B■	—	—
125	Hexagon LX4	1998/1999	0651090	YTX12-BS■	0681090	ESTX12-BS■	063109	FTX12-BS■
125	Hexagon LX4	1998/1999	0651135	YB10L-B	0681135	ESB10L-B■	—	—
125	Hexagon Super GTX 12 (M2000002)	2001/2002	0651090	YTX12-BS■	0681090	ESTX12-BS■	063109	FTX12-BS■
125	Hexagon Super GTX 12 (M2000002)	2001/2002	0651135	YB10L-B	0681135	ESB10L-B■	—	—
125	Liberty 4T (M1100)	1998/2000	06509350	YB9-B	0680935	ESB9-B■	—	—
125	Liberty 4T 2V IE E3 (M67100)	2009/2012	0651090	YTX12-BS■	0681090	ESTX12-BS■	063109	FTX12-BS■
125	Liberty 4T 3V IE E3 (M73400)	2013/2014	0650690	YTX7L-BS■	068069	ESTX7L-BS■	063069	FTX7L-BS■
125	Liberty 4T E3 (M38600)	2007/2009	0651135	YB10L-B	0681135	ESB10L-B■	—	—
125	Liberty 4T E3 Delivery - SINGLE (M38602)	2007/2015	06509350	YB9-B	0680935	ESB9-B■	—	—
125	Liberty 4T E3 Delivery - SINGLE (M38602)	2007/2015	0651090	YTX12-BS■	0681090	ESTX12-BS■	063109	FTX12-BS■
125	Liberty 4T E3 Delivery -TNT (M38602)	2008/2009	06509350	YB9-B	0680935	ESB9-B■	—	—
125	Liberty 4T Leader (M2200)	2001/2003	06509350	YB9-B	0680935	ESB9-B■	—	—
125	Liberty 4T RST (M38100)	2004/2008	06509350	YB9-B	0680935	ESB9-B■	—	—
125	Liberty 4T RST PTT (M38103)	2005/2011	06509350	YB9-B	0680935	ESB9-B■	—	—
125	Liberty 4T Sport (M38104)	2006/2006	0651135	YB10L-B	0681135	ESB10L-B■	—	—
125	Liberty 4T Sport E3 (M38601)	2006/2011	0651135	YB10L-B	0681135	ESB10L-B■	—	—
125	Liberty 4T-2V IE E3 PTT (M38900)	2012/2013	0651090	YTX12-BS■	0681090	ESTX12-BS■	063109	FTX12-BS■

▲ - Factory Sealed / Attivata dalla Fabbrica ■ - con Acido a corredo ◇ - Non di produzione YUASA a completamento gamma

Marca / Cilindrata / Modello / Anno			Cod. SGR		Cod. SGR		Cod. SGR	
PIAGGIO								
125	Liberty IGET 4T 3V IE (RP8M89100)	2015/2016	0650690	YTX7L-BS■	068069	ESTX7L-BS■	063069	FTX7L-BS■
125	Medley 4T IE (RP8MA0120)	2016/2016	0650690	YTX7L-BS■	068069	ESTX7L-BS■	063069	FTX7L-BS■
125	MP3 (M47300)	2007/2008	065124	YTX14H-BS■	—	—	—	—
125	MP3 (M47300)	2007/2008	065129	YTX14-BS■	068129	ESTX14-BS■	—	—
125	MP3 Hybrid (M65100)	2009/2011	065124	YTX14H-BS■	—	—	—	—
125	MP3 Hybrid (M65100)	2009/2011	065129	YTX14-BS■	068129	ESTX14-BS■	—	—
125	MP3 IE 4T-4V (M63100)	2008/2010	065124	YTX14H-BS■	—	—	—	—
125	MP3 IE 4T-4V (M63100)	2008/2010	065129	YTX14-BS■	068129	ESTX14-BS■	—	—
125	MP3 Touring IE (M63100)	2011/2013	065124	YTX14H-BS■	—	—	—	—
125	MP3 Touring IE (M63100)	2011/2013	065129	YTX14-BS■	068129	ESTX14-BS■	—	—
125	MP3 Yourban ERL (M71200)	2011/2012	065124	YTX14H-BS■	—	—	—	—
125	MP3 Yourban ERL (M71200)	2011/2012	065129	YTX14-BS■	068129	ESTX14-BS■	—	—
125	Sfera FL	1995/1997	06509350	YB9-B	0680935	ESB9-B■	—	—
125	Sfera FL	TUTTI	0650736	YB7-A	0680736	ESB7-A■	—	—
125	Skipper	1993/1997	0650736	YB7-A	0680736	ESB7-A■	—	—
125	Skipper LX	1998/1999	06509350	YB9-B	0680935	ESB9-B■	—	—
125	Skipper ST	2000/2000	06509350	YB9-B	0680935	ESB9-B■	—	—
125	Typhoon 4T 2V E3 (C5010)	2010/2014	06509350	YB9-B	0680935	ESB9-B■	—	—
125	Vespa (VNB1T)	1959/1959	0660715	3S3 ◇▲	—	—	—	—
125	Vespa 946 IE 3V ABS (M80100)	2013/2014	0651100	YTI2B-BS■	0681100	ESTI2B-BS■	—	—
125	Vespa 946 IE 3V ABS ARMANI (M80101)	2015/2015	0651100	YTI2B-BS■	0681100	ESTI2B-BS■	—	—
125	Vespa ET4 (M1900)	1996/1999	06509350	YB9-B	0680935	ESB9-B■	—	—
125	Vespa ET4 (M1900)	1999/2002	06509350	YB9-B	0680935	ESB9-B■	—	—
125	Vespa FL (VMX7T)	1989/1990	0650736	YB7-A	0680736	ESB7-A■	—	—
125	Vespa Granturismo / E3 (M31100/ M31101)	2003/2007	0651135	YB10L-B	0681135	ESB10L-B■	—	—
125	Vespa GTS E3 (M31300)	2007/2012	0651090	YTX12-BS■	0681090	ESTX12-BS■	063109	FTX12-BS■
125	Vespa GTS IE Super 4V (M45300)	2009/2015	065124	YTX14H-BS■	—	—	—	—
125	Vespa GTS IE Super 4V (M45300)	2009/2015	065129	YTX14-BS■	068129	ESTX14-BS■	—	—
125	Vespa GTS IE Super Sport 4V (M45300)	2011/2014	065124	YTX14H-BS■	—	—	—	—
125	Vespa GTS IE Super Sport 4V (M45300)	2011/2014	065129	YTX14-BS■	068129	ESTX14-BS■	—	—
125	Vespa GTV (M31301)	2007/2009	0651090	YTX12-BS■	0681090	ESTX12-BS■	063109	FTX12-BS■
125	Vespa GTV Navy E3 (M31301)	2008/2009	0651090	YTX12-BS■	0681090	ESTX12-BS■	063109	FTX12-BS■
125	Vespa LX (M44100)	2005/2006	06509350	YB9-B	0680935	ESB9-B■	—	—
125	Vespa LX E3 (M44300)	2006/2009	0651090	YTX12-BS■	0681090	ESTX12-BS■	063109	FTX12-BS■
125	Vespa LX FL (M44100)	2009/2011	0651090	YTX12-BS■	0681090	ESTX12-BS■	063109	FTX12-BS■
125	Vespa LX IE E3 3V (M68300)	2012/2013	0651090	YTX12-BS■	0681090	ESTX12-BS■	063109	FTX12-BS■
125	Vespa LX IE E3 3V Touring (M68300)	2012/2013	0651090	YTX12-BS■	0681090	ESTX12-BS■	063109	FTX12-BS■
125	Vespa LX IE E3 4V (M68100)	2009/2011	0651090	YTX12-BS■	0681090	ESTX12-BS■	063109	FTX12-BS■
125	Vespa LX Primavera 4T 3V IE (M81100)	2013/2015	0650690	YTX7L-BS■	068069	ESTX7L-BS■	063069	FTX7L-BS■
125	Vespa LX Touring IE 4V (M68100)	2010/2011	0651090	YTX12-BS■	0681090	ESTX12-BS■	063109	FTX12-BS■
125	Vespa LXV E3 (M44301)	2006/2009	0651135	YB10L-B	0681135	ESB10L-B■	—	—



▲ - Factory Sealed / Attivata dalla Fabbrica ■ - con Acido a corredo ◇ - Non di produzione YUASA a completamento gamma

Marca / Cilindrata / Modello / Anno			Cod. SGR		Cod. SGR		Cod. SGR		
PIAGGIO									
125	Vespa LXV IE E3 / LXV IE E3 Vie Della Moda (P68102)	2010/2013	0651090	YTX12-BS■	0681090	ESTX12-BS■	063109	FTX12-BS■	
125	Vespa LXV Navy E3 (M44301)	2007/2009	0651135	YB10L-B	0681135	ESB10L-B■	—	—	
125	Vespa P ETS (VMSIT)	1984/1985	0650736	YB7-A	0680736	ESB7-A■	—	—	
125	Vespa PK S (VMX5T)	1982/1985	0650534	YB5L-B	0680534	ESB5L-B■	—	—	
125	Vespa PK S Automatica (VAMIT)	1984/1989	0650736	YB7-A	0680736	ESB7-A■	—	—	
125	Vespa PK XL (VMX6T)	1986/1989	0650736	YB7-A	0680736	ESB7-A■	—	—	
125	Vespa PX (M74100)	2011/2015	06509350	YB9-B	0680935	ESB9-B■	—	—	
125	Vespa PX America (VNXIT)	1982/1982	06509350	YB9-B	0680935	ESB9-B■	—	—	
125	Vespa PX E (VNX2T)	1981/1983	06509350	YB9-B	0680935	ESB9-B■	—	—	
125	Vespa PX E Arcobaleno (VNX2T)	1983/1997	06509350	YB9-B	0680935	ESB9-B■	—	—	
125	Vespa PX E Arcobaleno EL. (VNX2T)	1983/1997	06509350	YB9-B	0680935	ESB9-B■	—	—	
125	Vespa PX E DT (VNX2T/ M09302)	1998/2010	06509350	YB9-B	0680935	ESB9-B■	—	—	
125	Vespa PX T5 (VNX5T)	1985/1989	0650534	YB5L-B	0680534	ESB5L-B■	—	—	
125	Vespa PX T5 Avv.El. (VNX5T)	1986/1989	06509350	YB9-B	0680935	ESB9-B■	—	—	
125	Vespa S (M44302)	2007/2008	0651135	YB10L-B	0681135	ESB10L-B■	—	—	
125	Vespa S IE (M68101)	2009/2012	0651090	YTX12-BS■	0681090	ESTX12-BS■	063109	FTX12-BS■	
125	Vespa S IE 3V (M68301)	2012/2013	0651090	YTX12-BS■	0681090	ESTX12-BS■	063109	FTX12-BS■	
125	Vespa Sprint 4T 3V (M81300)	2014/2015	0650690	YTX7L-BS■	068069	ESTX7L-BS■	063069	FTX7L-BS■	
125	Vespa Sprint 4T 3V ABS (M81301)	2014/2015	0650690	YTX7L-BS■	068069	ESTX7L-BS■	063069	FTX7L-BS■	
125	Vespa Super (VNC1T)	1966/1969	0600715	B39-6	—	—	—	—	
125	X Evo (M36601)	2007/2012	065124	YTX14H-BS■	—	—	—	—	
125	X Evo (M36601)	2007/2012	065129	YTX14-BS■	068129	ESTX14-BS■	—	—	
125	X10 IE 4T-4V E3 (M76101)	2012/2013	0651090	YTX12-BS■	0681090	ESTX12-BS■	063109	FTX12-BS■	
125	X10 IE 4T-4V E3 Executive ABS (M76101)	2012/2013	0651090	YTX12-BS■	0681090	ESTX12-BS■	063109	FTX12-BS■	
125	X7 E3 (M62100)	2008/2009	0651135	YB10L-B	0681135	ESB10L-B■	—	—	
125	X7 Evo IE E3 (M62101)	2009/2012	0651090	YTX12-BS■	0681090	ESTX12-BS■	063109	FTX12-BS■	
125	X8 (M36200/ M36300/ M36301)	2003/2004	0651135	YB10L-B	0681135	ESB10L-B■	—	—	
125	X8 (M36200/ M36300/ M36301)	2005/2006	0651231	YB10L-BP	—	—	—	—	
125	X8 Premium E2/ E3 (M36301/ M36600)	2006/2009	0651231	YB10L-BP	—	—	—	—	
125	X8 Premium E2/ E3 (M36301/ M36600)	2006/2009	065124	YTX14H-BS■	—	—	—	—	
125	X8 Premium E2/ E3 (M36301/ M36600)	2006/2009	065129	YTX14-BS■	068129	ESTX14-BS■	—	—	
125	X8 Street E2 (M49100)	2006/2007	0651231	YB10L-BP	—	—	—	—	
125	X9 (M230001)	2001/2002	0651135	YB10L-B	0681135	ESB10L-B■	—	—	
125	X9 Evolution (M23000/ M2300035)	2003/2006	06509350	YB9-B	0680935	ESB9-B■	—	—	
125	X9 Evolution E3 (M48100)	2007/2008	0651135	YB10L-B	0681135	ESB10L-B■	—	—	
125	Zip (M2500)	2000/2008	0650990	YTX9-BS■	068099	ESTX9-BS■	063099	FTX9-BS■	
150	Cosa 1 (VLR1T)	1988/1990	0650736	YB7-A	0680736	ESB7-A■	—	—	
150	Cosa 2 (VLR2T)	1991/1997	0650736	YB7-A	0680736	ESB7-A■	—	—	
150	FLY / FLY E3 (M42200/ M57100)	2005/2008	06509350	YB9-B	0680935	ESB9-B■	—	—	
150	Hexagon	1994/1997	06509350	YB9-B	0680935	ESB9-B■	—	—	
150	Liberty 4T	2000/2003	06509350	YB9-B	0680935	ESB9-B■	—	—	



▲ - Factory Sealed / Attivata dalla Fabbrica ■ - con Acido a corredo ◇ - Non di produzione YUASA a completamento gamma

Marca / Cilindrata / Modello / Anno			Cod. SGR		Cod. SGR		Cod. SGR		
PIAGGIO									
150	Liberty 4T 3V LEM (M73500)	2013/2015	0650690	YTX7L-BS ■	068069	ESTX7L-BS ■	063069	FTX7L-BS ■	
150	Liberty 4T E3 (M38700)	2008/2009	0651135	YB10L-B	0681135	ESB10L-B ■	—	—	
150	Liberty IGET 4T 3V IE (RP8M89200)	2015/2016	0650690	YTX7L-BS ■	068069	ESTX7L-BS ■	063069	FTX7L-BS ■	
150	Liberty MOC 4T (M67200)	2009/2013	0651135	YB10L-B	0681135	ESB10L-B ■	—	—	
150	Liberty Sport 4T E3 (M38701)	2008/2009	0651135	YB10L-B	0681135	ESB10L-B ■	—	—	
150	Medley 4T IE (RP8MA0220)	2016/2016	0650690	YTX7L-BS ■	068069	ESTX7L-BS ■	063069	FTX7L-BS ■	
150	Skipper	1993/1997	0650736	YB7-A	0680736	ESB7-A ■	—	—	
150	Skipper LX	1998/1999	06509350	YB9-B	0680935	ESB9-B ■	—	—	
150	Skipper ST	2000/2002	06509350	YB9-B	0680935	ESB9-B ■	—	—	
150	Vespa (VB1)	1957/1958	0660510	3S2 ◇▲	—	—	—	—	
150	Vespa (VBAIT)	1959/1959	0660715	3S3 ◇▲	—	—	—	—	
150	Vespa (VBBIT)	1960/1960	0660715	3S3 ◇▲	—	—	—	—	
150	Vespa (VLIT)	1954/1954	0660715	3S3 ◇▲	—	—	—	—	
150	Vespa (VL2T)	1955/1955	0660715	3S3 ◇▲	—	—	—	—	
150	Vespa (VL2T)	1956/1956	0660933	3R2 ◇▲	—	—	—	—	
150	Vespa (VL3T)	1956/1956	0660510	3S2 ◇▲	—	—	—	—	
150	Vespa ET4	1999/2004	06509350	YB9-B	0680935	ESB9-B ■	—	—	
150	Vespa GL (VGLIT)	1956/1958	0660715	3S3 ◇▲	—	—	—	—	
150	Vespa GL (VLAIT)	1963/1964	0600715	B39-6	—	—	—	—	
150	Vespa GL (VLAIT)	1963/1964	0660715	3S3 ◇▲	—	—	—	—	
150	Vespa GS (VSIT)	1955/1955	0600833	B49-6	—	—	—	—	
150	Vespa GS (VS2T)	1956/1956	0600833	B49-6	—	—	—	—	
150	Vespa GS (VS3T)	1957/1957	0600833	B49-6	—	—	—	—	
150	Vespa GS (VS4T)	1958/1958	0600833	B49-6	—	—	—	—	
150	Vespa GS (VS5T)	1959/1961	0600833	B49-6	—	—	—	—	
150	Vespa LX (M44200)	2005/2006	06509350	YB9-B	0680935	ESB9-B ■	—	—	
150	Vespa LX E3 (M44400)	2006/2009	0651135	YB10L-B	0681135	ESB10L-B ■	—	—	
150	Vespa LX FL E3 (M44400)	2009/2010	0651090	YTX12-BS ■	0681090	ESTX12-BS ■	063109	FTX12-BS ■	
150	Vespa LX IE (M68200)	2009/2012	0651090	YTX12-BS ■	0681090	ESTX12-BS ■	063109	FTX12-BS ■	
150	Vespa LX IE 3V (M68400)	2012/2013	0651090	YTX12-BS ■	0681090	ESTX12-BS ■	063109	FTX12-BS ■	
150	Vespa LX Touring IE (M68200)	2010/2012	0651090	YTX12-BS ■	0681090	ESTX12-BS ■	063109	FTX12-BS ■	
150	Vespa LX Touring IE 3V (M68400)	2012/2013	0651090	YTX12-BS ■	0681090	ESTX12-BS ■	063109	FTX12-BS ■	
150	Vespa Primavera 4T 3V (M81200)	2013/2015	0650690	YTX7L-BS ■	068069	ESTX7L-BS ■	063069	FTX7L-BS ■	
150	Vespa PX (M74200)	2011/2015	06509350	YB9-B	0680935	ESB9-B ■	—	—	
150	Vespa PX E (VLX1T)	1981/1983	06509350	YB9-B	0680935	ESB9-B ■	—	—	
150	Vespa PX E DT (VLX1T)	1998/2001	06509350	YB9-B	0680935	ESB9-B ■	—	—	
150	Vespa S (M44402)	2008/2009	0651090	YTX12-BS ■	0681090	ESTX12-BS ■	063109	FTX12-BS ■	
150	Vespa S IE (M68201)	2009/2012	0651090	YTX12-BS ■	0681090	ESTX12-BS ■	063109	FTX12-BS ■	
150	Vespa Sprint 4T 3V/ ABS (M81401)	2015/2015	0650690	YTX7L-BS ■	068069	ESTX7L-BS ■	063069	FTX7L-BS ■	
150	X8 Street E2 (M49200)	2006/2008	0651231	YB10L-BP	—	—	—	—	
160	Vespa GS (VSBIT)	1962/1964	0600833	B49-6	—	—	—	—	



▲ - Factory Sealed / Attivata dalla Fabbrica ■ - con Acido a corredo ◇ - Non di produzione YUASA a completamento gamma

Marca / Cilindrata / Modello / Anno			Cod. SGR		Cod. SGR		Cod. SGR		
PIAGGIO									
160	Vespa GS (VSB1T)	1962/1964	0660933	3R2 ◊▲	—	—	—	—	
180	Hexagon GTX 11 (M2000001)	2000/2000	0651090	YTX12-BS■	0681090	ESTX12-BS■	063109	FTX12-BS■	
180	Hexagon GTX 11 (M2000001)	2000/2000	0651135	YB10L-B	0681135	ESB10L-B■	—	—	
180	Hexagon LXT	1998/1999	0651090	YTX12-BS■	0681090	ESTX12-BS■	063109	FTX12-BS■	
180	Hexagon LXT	1998/1999	0651135	YB10L-B	0681135	ESB10L-B■	—	—	
180	Hexagon Super GTX 12 (M2000003)	2001/2002	0651090	YTX12-BS■	0681090	ESTX12-BS■	063109	FTX12-BS■	
180	Hexagon Super GTX 12 (M2000003)	2001/2002	0651135	YB10L-B	0681135	ESB10L-B■	—	—	
180	Vespa SS (VSCIT)	1964/1968	0660933	3R2 ◊▲	—	—	—	—	
180	Vespa SS (VSCIT)	1965/1968	0600833	B49-6	—	—	—	—	
180	X9 Amalfi	2000/2003	0651135	YB10L-B	0681135	ESB10L-B■	—	—	
190	Ape MP 500 (MPR1T)	1969/1978	0653211	6MK5 ◊	—	—	—	—	
190	Ape P 501 (MPR2T)	1978/1996	0652711	6MC4 ◊	—	—	—	—	
190	Ape P 601 (MPMIT)	1978/1996	0652711	6MC4 ◊	—	—	—	—	
200	Beverly	2001/2003	0651090	YTX12-BS■	0681090	ESTX12-BS■	063109	FTX12-BS■	
200	Carnaby	2007/2011	065124	YTX14H-BS■	—	—	—	—	
200	Carnaby	2007/2011	065129	YTX14-BS■	068129	ESTX14-BS■	—	—	
200	Cosa 1 (VSRIT)	1988/1990	0650736	YB7-A	0680736	ESB7-A■	—	—	
200	Liberty Rst / E3 (M3840001/ M38400/ M38500)	2004/2005	0651231	YB10L-BP	—	—	—	—	
200	Liberty Rst / E3 (M3840001/ M38400/ M38500)	2006/2009	0651110	YT12A-BS■	0681110	EST12A-BS■	—	—	
200	Liberty Sport / E3 (M38401/ M38501)	2006/2009	0651135	YB10L-B	0681135	ESB10L-B■	—	—	
200	Vespa Granturismo (M31200)	2003/2007	0651135	YB10L-B	0681135	ESB10L-B■	—	—	
200	Vespa PX E DT (VSX1T)	1998/2001	06509350	YB9-B	0680935	ESB9-B■	—	—	
200	X8 (M36200)	2003/2004	0651135	YB10L-B	0681135	ESB10L-B■	—	—	
200	X8 (M36200)	2005/2007	0651231	YB10L-BP	—	—	—	—	
200	X9	2002/2003	0651135	YB10L-B	0681135	ESB10L-B■	—	—	
200	X9 Evolution	2003/2003	0651135	YB10L-B	0681135	ESB10L-B■	—	—	
220	Ape Car P2 Benzina (AF1T/ AF3T)	1978/1985	0653211	6MK5 ◊	—	—	—	—	
220	Ape Car P3 benzina (AF4T/ AF5T)	1985/>	0653211	6MK5 ◊	—	—	—	—	
220	Ape Car P3 benzina (AF4T/ AF5T)	1985/>	0654310	54310 ◊	—	—	—	—	
220	Ape Car P3 benzina (AF4T/ AF5T)	1985/>	0655275	55275 ◊	—	—	—	—	
220	Ape TM (T10000)	2009/2015	0654310	54310 ◊	—	—	—	—	
220	Ape TM P 602 Benzina (ATMIT)	1982/1983	0653211	6MK5 ◊	—	—	—	—	
220	Ape TM P 602 Benzina (ATMIT)	1982/1983	0655275	55275 ◊	—	—	—	—	
220	Ape TM P703V, FL, FL2 (Benzina) (ATM2T)	1984/2005	0653211	6MK5 ◊	—	—	—	—	
250	Beverly Cruiser (M28802)	2007/2010	065124	YTX14H-BS■	—	—	—	—	
250	Beverly Cruiser (M28802)	2007/2010	065129	YTX14-BS■	068129	ESTX14-BS■	—	—	
250	Beverly E3 MIC (M28800)	2007/2009	065124	YTX14H-BS■	—	—	—	—	
250	Beverly E3 MIC (M28800)	2007/2009	065129	YTX14-BS■	068129	ESTX14-BS■	—	—	
250	Beverly IE E3 (M28800)	2006/2007	0651231	YB10L-BP	—	—	—	—	
250	Beverly IE E3 (M28800)	2006/2007	065124	YTX14H-BS■	—	—	—	—	
250	Beverly IE E3 (M28800)	2008/2009	065129	YTX14-BS■	068129	ESTX14-BS■	—	—	

▲ - Factory Sealed / Attivata dalla Fabbrica ◻ - con Acido a corredo ◊ - Non di produzione YUASA a completamento gamma

Marca / Cilindrata / Modello / Anno			Cod. SGR		Cod. SGR		Cod. SGR		
PIAGGIO									
250	Beverly Rst (M28500)	2004/2007	0651231	YB10L-BP	—	—	—	—	—
250	Beverly Sport (M28800)	2006/2012	0651231	YB10L-BP	—	—	—	—	—
250	Beverly Tourer E3 (ZAPM28801)	2008/2009	065124	YTX14H-BS■	—	—	—	—	—
250	Beverly Tourer E3 (ZAPM28801)	2008/2009	065129	YTX14-BS■	068129	ESTX14-BS■	—	—	—
250	Carnaby (M60300)	2008/2010	065124	YTX14H-BS■	—	—	—	—	—
250	Carnaby (M60300)	2008/2010	065129	YTX14-BS■	068129	ESTX14-BS■	—	—	—
250	Hexagon GT (M1400) Tel.<18417	1998/1999	0651090	YTX12-BS■	0681090	ESTX12-BS■	063109	FTX12-BS■	—
250	Hexagon GT (M1400) Tel.<18417	1998/1999	0651135	YB10L-B	0681135	ESB10L-B■	—	—	—
250	MP3 (ZAPM47201)	2006/2009	065124	YTX14H-BS■	—	—	—	—	—
250	MP3 (ZAPM47201)	2006/2009	065129	YTX14-BS■	068129	ESTX14-BS■	—	—	—
250	MP3 LT (ZAPM64100)	2009/2010	065124	YTX14H-BS■	—	—	—	—	—
250	MP3 LT (ZAPM64100)	2009/2010	065129	YTX14-BS■	068129	ESTX14-BS■	—	—	—
250	MP3 MIC (ZAPM63200)	2008/2009	065124	YTX14H-BS■	—	—	—	—	—
250	MP3 MIC (ZAPM63200)	2008/2009	065129	YTX14-BS■	068129	ESTX14-BS■	—	—	—
250	Superhexagon GTX (M1400) Tel.14818>	2000/2001	0651090	YTX12-BS■	0681090	ESTX12-BS■	063109	FTX12-BS■	—
250	Superhexagon GTX (M1400) Tel.14818>	2000/2001	0651135	YB10L-B	0681135	ESB10L-B■	—	—	—
250	Vespa GT 60 (M45102)	2006/2008	0651231	YB10L-BP	—	—	—	—	—
250	Vespa GTS (M45100)	2005/2014	0651231	YB10L-BP	—	—	—	—	—
250	Vespa GTS (M45100)	2005/2014	065124	YTX14H-BS■	—	—	—	—	—
250	Vespa GTS (M45100)	2005/2014	065129	YTX14-BS■	068129	ESTX14-BS■	—	—	—
250	Vespa GTS ABS (M45101)	2005/2014	0651231	YB10L-BP	—	—	—	—	—
250	Vespa GTS ABS (M45101)	2005/2014	065124	YTX14H-BS■	—	—	—	—	—
250	Vespa GTS ABS (M45101)	2005/2014	065129	YTX14-BS■	068129	ESTX14-BS■	—	—	—
250	Vespa GTV (M45102)	2006/2011	0651231	YB10L-BP	—	—	—	—	—
250	Vespa GTV Navy E3 (M45102)	2008/2011	065124	YTX14H-BS■	—	—	—	—	—
250	Vespa GTV Navy E3 (M45102)	2008/2011	065129	YTX14-BS■	068129	ESTX14-BS■	—	—	—
250	X Evo (M36401)	2007/2013	065124	YTX14H-BS■	—	—	—	—	—
250	X Evo (M36401)	2007/2013	065129	YTX14-BS■	068129	ESTX14-BS■	—	—	—
250	X7 E3 (M62200)	2007/2011	065124	YTX14H-BS■	—	—	—	—	—
250	X7 E3 (M62200)	2007/2011	065129	YTX14-BS■	068129	ESTX14-BS■	—	—	—
250	X8 E3 (M36400)	2005/2008	0651231	YB10L-BP	—	—	—	—	—
250	X8 E3 (M36400)	2005/2008	065124	YTX14H-BS■	—	—	—	—	—
250	X8 E3 (M36400)	2005/2008	065129	YTX14-BS■	068129	ESTX14-BS■	—	—	—
250	X9 (M23000)	2000/2003	0651090	YTX12-BS■	0681090	ESTX12-BS■	063109	FTX12-BS■	—
250	X9 (M23000)	2000/2003	0651135	YB10L-B	0681135	ESB10L-B■	—	—	—
250	X9 Evolution (M2300045)	2004/2007	0651231	YB10L-BP	—	—	—	—	—
300	Beverly Rst 4T 4V IE E3 (M69200)	2010/2015	0651090	YTX12-BS■	0681090	ESTX12-BS■	063109	FTX12-BS■	—
300	Beverly Tourer IE (M28A00)	2009/2011	065124	YTX14H-BS■	—	—	—	—	—
300	Beverly Tourer IE (M28A00)	2009/2011	065129	YTX14-BS■	068129	ESTX14-BS■	—	—	—
300	Carnaby Cruiser (M60400)	2009/2012	0651090	YTX12-BS■	0681090	ESTX12-BS■	063109	FTX12-BS■	—
300	MP3 IE LT Touring / Sport (M64102)	2010/2013	065124	YTX14H-BS■	—	—	—	—	—

▲ - Factory Sealed / Attivata dalla Fabbrica ■ - con Acido a corredo ◇ - Non di produzione YUASA a completamento gamma

Marca / Cilindrata / Modello / Anno			Cod. SGR		Cod. SGR		Cod. SGR		
PIAGGIO									
300	MP3 IE LT Touring / Sport (M64102)	2010/2013	065129	YTX14-BS■	068129	ESTX14-BS■	—	—	
300	MP3 IE MIC (M63301)	2010/2011	065124	YTX14H-BS■	—	—	—	—	
300	MP3 IE MIC (M63301)	2010/2011	065129	YTX14-BS■	068129	ESTX14-BS■	—	—	
300	MP3 IE Touring (M63301)	2011/2012	065124	YTX14H-BS■	—	—	—	—	
300	MP3 IE Touring (M63301)	2011/2012	065129	YTX14-BS■	068129	ESTX14-BS■	—	—	
300	MP3 IE Yourban ERL/ Sport (M71200)	2011/2015	065124	YTX14H-BS■	—	—	—	—	
300	MP3 IE Yourban ERL/ Sport (M71200)	2011/2015	065129	YTX14-BS■	068129	ESTX14-BS■	—	—	
300	MP3 IE Yourban LT ERL/ Sport (M75100)	2011/2013	065124	YTX14H-BS■	—	—	—	—	
300	MP3 IE Yourban LT ERL/ Sport (M75100)	2011/2013	065129	YTX14-BS■	068129	ESTX14-BS■	—	—	
300	MP3 LT 4V E3 Ibrido (M72100)	2010/2015	065124	YTX14H-BS■	—	—	—	—	
300	MP3 LT 4V E3 Ibrido (M72100)	2010/2015	065129	YTX14-BS■	068129	ESTX14-BS■	—	—	
300	Vespa GTS IE (M45200)	2012/2015	0651090	YTX12-BS■	0681090	ESTX12-BS■	063109	FTX12-BS■	
300	Vespa GTS IE Touring (M45200)	2011/2015	0651090	YTX12-BS■	0681090	ESTX12-BS■	063109	FTX12-BS■	
300	Vespa GTS Super (M45200)	2008/2015	0651090	YTX12-BS■	0681090	ESTX12-BS■	063109	FTX12-BS■	
300	Vespa GTS Super (M45200)	2008/2008	065124	YTX14H-BS■	—	—	—	—	
300	Vespa GTS Super (M45200)	2008/2008	065129	YTX14-BS■	068129	ESTX14-BS■	—	—	
300	Vespa GTS Super Sport (M45200)	2010/2015	0651090	YTX12-BS■	0681090	ESTX12-BS■	063109	FTX12-BS■	
300	Vespa GTV 4T 4V IE (M4520)	2010/2013	0651090	YTX12-BS■	0681090	ESTX12-BS■	063109	FTX12-BS■	
300	Vespa GTV 4T 4V IE V.Montenapoleone (M45201)	2010/2011	0651090	YTX12-BS■	0681090	ESTX12-BS■	063109	FTX12-BS■	
300	X7 EVO E3 (M62201)	2009/2012	0651090	YTX12-BS■	0681090	ESTX12-BS■	063109	FTX12-BS■	
350	Beverly IE 4T-4V E3 (M69300)	2011/2015	0651090	YTX12-BS■	0681090	ESTX12-BS■	063109	FTX12-BS■	
350	X10 IE 4T-4V E3 (M76200/ M76201)	2012/2015	0651090	YTX12-BS■	0681090	ESTX12-BS■	063109	FTX12-BS■	
350	X10 IE 4T-4V E3 Executive ABS (M76200/ M76201)	2012/2015	0651090	YTX12-BS■	0681090	ESTX12-BS■	063109	FTX12-BS■	
400	Beverly E3 (M34300)	2006/2007	065124	YTX14H-BS■	—	—	—	—	
400	Beverly E3 (M34300)	2006/2007	065129	YTX14-BS■	068129	ESTX14-BS■	—	—	
400	Beverly Tourer E3 (M34400)	2008/2011	065124	YTX14H-BS■	—	—	—	—	
400	Beverly Tourer E3 (M34400)	2008/2011	065129	YTX14-BS■	068129	ESTX14-BS■	—	—	
400	MP3 (M59100/ M59101)	2007/2008	065168	YTX16-BS■	068168	ESTX16-BS■	—	—	
400	MP3 IE LT (M64200)	2008/2011	065168	YTX16-BS■	068168	ESTX16-BS■	—	—	
400	MP3 IE LT Sport (M64200)	2008/2011	065168	YTX16-BS■	068168	ESTX16-BS■	—	—	
400	MP3 IE LT Touring (M64200)	2011/2011	065168	YTX16-BS■	068168	ESTX16-BS■	—	—	
400	MP3 MIC (M59102)	2008/2011	065168	YTX16-BS■	068168	ESTX16-BS■	—	—	
400	MP3 RL Touring (M59101)	2011/2011	065168	YTX16-BS■	068168	ESTX16-BS■	—	—	
400	X Evo (M52101)	2007/2012	065124	YTX14H-BS■	—	—	—	—	
400	X Evo (M52101)	2007/2012	065129	YTX14-BS■	068129	ESTX14-BS■	—	—	
400	X8 (M52100)	2006/2008	065124	YTX14H-BS■	—	—	—	—	
400	X8 (M52100)	2006/2008	065129	YTX14-BS■	068129	ESTX14-BS■	—	—	
420	Ape Car Diesel (AFDIT)	1986/1996	0655275	55275 ◇	—	—	—	—	
420	Ape Max Diesel (AFD3T)	1988/1996	0655275	55275 ◇	—	—	—	—	
420	Ape Poker Diesel (M4R3T/ M4R4T)	1993/1997	0655275	55275 ◇	—	—	—	—	
420	Ape TM D LCS Diesel	2005/2007	0655275	55275 ◇	—	—	—	—	

▲ - Factory Sealed / Attivata dalla Fabbrica ■ - con Acido a corredo ◇ - Non di produzione YUASA a completamento gamma

Marca / Cilindrata / Modello / Anno	Cod. SGR		Cod. SGR		Cod. SGR	
--	-----------------	--	-----------------	--	-----------------	--



PIAGGIO

420 Ape TM P703, V, FL Diesel (ATD1)	1987/2004	0655275	55275 ◇	—	—	—	—
500 Beverly / Beverly E3 (M34100/ 34200)	2002/2005	0651231	YB10L-BP	—	—	—	—
500 Beverly / Beverly E3 (M34100/ 34200)	2006/2008	065124	YTX14H-BS■	—	—	—	—
500 Beverly / Beverly E3 (M34100/ 34200)	2006/2008	065129	YTX14-BS■	068129	ESTX14-BS■	—	—
500 Beverly Cruiser (ZAP34500)	2007/2012	065124	YTX14H-BS■	—	—	—	—
500 Beverly Cruiser (ZAP34500)	2007/2012	065129	YTX14-BS■	068129	ESTX14-BS■	—	—
500 MP3 LT Sport - Business (M64300)	2011/2013	065124	YTX14H-BS■	—	—	—	—
500 MP3 LT Sport - Business (M64300)	2011/2013	065129	YTX14-BS■	068129	ESTX14-BS■	—	—
500 MP3 LT Sport - Business (M64300)	2011/2013	065168	YTX16-BS■	068168	ESTX16-BS■	—	—
500 MP3 LT Sport - Business ABS (M86100)	2014/2015	065124	YTX14H-BS■	—	—	—	—
500 MP3 LT Sport - Business ABS (M86100)	2014/2015	065129	YTX14-BS■	068129	ESTX14-BS■	—	—
500 MP3 RL Sport - Business (M59200)	2011/2012	065124	YTX14H-BS■	—	—	—	—
500 MP3 RL Sport - Business (M59200)	2011/2012	065129	YTX14-BS■	068129	ESTX14-BS■	—	—
500 X10 4T 4V IE E3 Executive ABS (M76300)	2012/2014	065124	YTX14H-BS■	—	—	—	—
500 X10 4T 4V IE E3 Executive ABS (M76300)	2012/2014	065129	YTX14-BS■	068129	ESTX14-BS■	—	—
500 X9	2001/2003	0651434	YB14L-A2	0681434	ESB14L-A2■	—	—
500 X9 Abs	2006/2008	0651434	YB14L-A2	0681434	ESB14L-A2■	—	—
500 X9 Evolution	2004/2007	0651434	YB14L-A2	0681434	ESB14L-A2■	—	—
500 X9 Evolution Abs	2004/2005	0651434	YB14L-A2	0681434	ESB14L-A2■	—	—
1000 Porter Pick-up Benzina	1992/1998	0655275	55275 ◇	—	—	—	—
1000 Porter Van Benzina	1992/1998	0655275	55275 ◇	—	—	—	—
1300 Porter Benzina 16V Pick-up	1998/2005	0654511	54511 ◇	—	—	—	—
1300 Porter Benzina 16V Van	1998/2000	0654511	54511 ◇	—	—	—	—
Liberty Elettrico PTT AUT	2011/2011	0650690	YTX7L-BS■	068069	ESTX7L-BS■	063069	FTX7L-BS■

POLARIS

200 Phoenix	2005/2015	0651090	YTX12-BS■	0681090	ESTX12-BS■	063109	FTX12-BS■
200 Sawtooth	2006/2007	0651090	YTX12-BS■	0681090	ESTX12-BS■	063109	FTX12-BS■
250 Trail Blazer	1995/2006	065122	YTX14AH-BS■	068122	ESTX14AH-BS■	—	—
250 Trail Boss 2X4	1988/1999	065122	YTX14AH-BS■	068122	ESTX14AH-BS■	—	—
250 Trail Boss 4X4	1988/1992	065122	YTX14AH-BS■	068122	ESTX14AH-BS■	—	—
250 Xplorer 4X4	2000/2002	065122	YTX14AH-BS■	068122	ESTX14AH-BS■	—	—
300 Hawkeye 2X4	2006/2009	0651438	YB14-B2	0681438	ESB14-B2■	—	—
300 Hawkeye 2X4	2006/2010	065122	YTX14AH-BS■	068122	ESTX14AH-BS■	—	—
300 Hawkeye 4X4	2006/2009	0651438	YB14-B2	0681438	ESB14-B2■	—	—
300 Hawkeye 4X4	2006/2010	065122	YTX14AH-BS■	068122	ESTX14AH-BS■	—	—
300 Sportsman 4X4	2008/2008	065122	YTX14AH-BS■	068122	ESTX14AH-BS■	—	—
300 Sportsman 4X4	2008/2008	0651438	YB14-B2	0681438	ESB14-B2■	—	—
300 Sportsman 4X4	2009/2010	065122	YTX14AH-BS■	068122	ESTX14AH-BS■	—	—
325 Magnum 2X4	2000/2002	065122	YTX14AH-BS■	068122	ESTX14AH-BS■	—	—
325 Magnum 2X4	2000/2002	0651431	YB14A-A2	0681431	ESB14A-A2■	—	—
325 Magnum 4X4	2000/2002	065122	YTX14AH-BS■	068122	ESTX14AH-BS■	—	—

▲ - Factory Sealed / Attivata dalla Fabbrica ■ - con Acido a corredo ◇ - Non di produzione YUASA a completamento gamma

Marca / Cilindrata / Modello / Anno			Cod. SGR		Cod. SGR		Cod. SGR	
POLARIS								
325	Magnum 4X4	2000/2002	0651431	YB14A-A2	0681431	ESB14A-A2■	—	—
325	Trail Boss 2X4	2000/2002	065122	YTX14AH-BS■	068122	ESTX14AH-BS■	—	—
325	Trail Boss 2X4	2000/2002	0651431	YB14A-A2	0681431	ESB14A-A2■	—	—
325	Xpedition	2000/2002	065122	YTX14AH-BS■	068122	ESTX14AH-BS■	—	—
325	Xpedition	2000/2002	0651431	YB14A-A2	0681431	ESB14A-A2■	—	—
330	ATP	2004/2006	065122	YTX14AH-BS■	068122	ESTX14AH-BS■	—	—
330	Magnum 2X4	2003/2005	065122	YTX14AH-BS■	068122	ESTX14AH-BS■	—	—
330	Magnum 2X4	2003/2005	0651431	YB14A-A2	0681431	ESB14A-A2■	—	—
330	Magnum 4X4	2003/2006	065122	YTX14AH-BS■	068122	ESTX14AH-BS■	—	—
330	Trail Blazer	2008/2009	065122	YTX14AH-BS■	068122	ESTX14AH-BS■	—	—
330	Trail Blazer	2008/2009	0651431	YB14A-A2	0681431	ESB14A-A2■	—	—
330	Trail Boss	2003/2010	065122	YTX14AH-BS■	068122	ESTX14AH-BS■	—	—
330	Trail Boss	2003/2010	0651431	YB14A-A2	0681431	ESB14A-A2■	—	—
335	Sportsman	1999/2001	065122	YTX14AH-BS■	068122	ESTX14AH-BS■	—	—
400	Big Boss L 6X6	1996/1997	065122	YTX14AH-BS■	068122	ESTX14AH-BS■	—	—
400	L 2X4	1994/1995	065122	YTX14AH-BS■	068122	ESTX14AH-BS■	—	—
400	Scrambler L 2X4	1995/2003	065122	YTX14AH-BS■	068122	ESTX14AH-BS■	—	—
400	Scrambler L 4X4	1995/2003	065122	YTX14AH-BS■	068122	ESTX14AH-BS■	—	—
400	Sport L 2X4	1995/1999	065122	YTX14AH-BS■	068122	ESTX14AH-BS■	—	—
400	Sportsman	2001/2005	065122	YTX14AH-BS■	068122	ESTX14AH-BS■	—	—
400	Sportsman H0	2010/2011	065122	YTX14AH-BS■	068122	ESTX14AH-BS■	—	—
400	Sportsman L 4X4	1994/1997	065122	YTX14AH-BS■	068122	ESTX14AH-BS■	—	—
400	Trail Blazer	2003/2003	065122	YTX14AH-BS■	068122	ESTX14AH-BS■	—	—
400	Trail Boss L 2X4	1990/2000	065122	YTX14AH-BS■	068122	ESTX14AH-BS■	—	—
400	Trail Boss L 2X4	1990/2000	0651431	YB14A-A2	0681431	ESB14A-A2■	—	—
400	Trail Boss L 4X4	1990/1994	065122	YTX14AH-BS■	068122	ESTX14AH-BS■	—	—
400	Trail Boss L 4X4	1990/1994	0651431	YB14A-A2	0681431	ESB14A-A2■	—	—
400	Xplorer L	1995/2003	065122	YTX14AH-BS■	068122	ESTX14AH-BS■	—	—
425	Magnum 2X4	1996/1998	065122	YTX14AH-BS■	068122	ESTX14AH-BS■	—	—
425	Magnum 2X4	1996/1998	0651431	YB14A-A2	0681431	ESB14A-A2■	—	—
425	Magnum 4X4	1995/1998	065122	YTX14AH-BS■	068122	ESTX14AH-BS■	—	—
425	Magnum 4X4	1995/1998	0651431	YB14A-A2	0681431	ESB14A-A2■	—	—
425	Magnum 6X6	1996/1997	065122	YTX14AH-BS■	068122	ESTX14AH-BS■	—	—
425	Magnum 6X6	1996/1997	0651431	YB14A-A2	0681431	ESB14A-A2■	—	—
425	Ranger 2X4	2002/2003	065275	Y1X30L▲	—	—	—	—
425	Ranger 2X4	2002/2003	0653036	YB30L-B	0683036	ESB30L-B■	—	—
425	Workman	1997/2002	065122	YTX14AH-BS■	068122	ESTX14AH-BS■	—	—
425	Xpedition	2000/2002	065122	YTX14AH-BS■	068122	ESTX14AH-BS■	—	—
450	Diesel .445 Liter (primary)	1999/2003	065275	Y1X30L▲	—	—	—	—
450	Diesel .445 Liter (secondary)	1999/2003	065122	YTX14AH-BS■	068122	ESTX14AH-BS■	—	—
450	Diesel Liter (primary)	1999/2003	0653036	YB30L-B	0683036	ESB30L-B■	—	—

▲ - Factory Sealed / Attivata dalla Fabbrica ■ - con Acido a corredo ◇ - Non di produzione YUASA a completamento gamma

Marca / Cilindrata / Modello / Anno

Cod.
SGR



Cod.
SGR



Cod.
SGR



POLARIS

450 Outlaw MXR	2008/2010	0650990	YTX9-BS■	068099	ESTX9-BS■	063099	FTX9-BS■
500 ATP HO	2004/2005	065122	YTX14AH-BS■	068122	ESTX14AH-BS■	—	—
500 Big Boss 6X6	1998/1999	065122	YTX14AH-BS■	068122	ESTX14AH-BS■	—	—
500 Big Boss 6X6	1998/1999	0651431	YB14A-A2	0681431	ESB14A-A2■	—	—
500 Magnum 2X4	2002/2002	065122	YTX14AH-BS■	068122	ESTX14AH-BS■	—	—
500 Magnum 2X4	2002/2002	0651431	YB14A-A2	0681431	ESB14A-A2■	—	—
500 Magnum 4X4	1999/2003	065122	YTX14AH-BS■	068122	ESTX14AH-BS■	—	—
500 Magnum 4X4	1999/2003	0651431	YB14A-A2	0681431	ESB14A-A2■	—	—
500 Outlaw	2006/2007	0650990	YTX9-BS■	068099	ESTX9-BS■	063099	FTX9-BS■
500 Predator	2003/2007	0650990	YTX9-BS■	068099	ESTX9-BS■	063099	FTX9-BS■
500 Ranger 4X4	1998/2003	065275	YIX30L▲	—	—	—	—
500 Ranger 4X4	1998/2003	0653036	YB30L-B	0683036	ESB30L-B■	—	—
500 Ranger 6X6	1998/2003	065275	YIX30L▲	—	—	—	—
500 Ranger 6X6	1998/2003	0653036	YB30L-B	0683036	ESB30L-B■	—	—
500 Scrambler 2X4	2000/2003	065122	YTX14AH-BS■	068122	ESTX14AH-BS■	—	—
500 Scrambler 2X4	2000/2003	0651431	YB14A-A2	0681431	ESB14A-A2■	—	—
500 Scrambler 4X4	1999/2010	065122	YTX14AH-BS■	068122	ESTX14AH-BS■	—	—
500 Scrambler 4X4	1999/2010	0651431	YB14A-A2	0681431	ESB14A-A2■	—	—
500 Scrambler E 4X4	1997/2002	065122	YTX14AH-BS■	068122	ESTX14AH-BS■	—	—
500 Scrambler E 4X4	1997/2002	0651431	YB14A-A2	0681431	ESB14A-A2■	—	—
500 Sportsman 2X4	1999/2002	065275	YIX30L▲	—	—	—	—
500 Sportsman 4X4	1996/1999	065275	YIX30L▲	—	—	—	—
500 Sportsman 6X6	2000/2008	065275	YIX30L▲	—	—	—	—
500 Sportsman EBS 4X4	1998/2002	065122	YTX14AH-BS■	068122	ESTX14AH-BS■	—	—
500 Sportsman HO	2003/2009	065275	YIX30L▲	—	—	—	—
500 Sportsman HO	2010/2010	065122	YTX14AH-BS■	068122	ESTX14AH-BS■	—	—
500 Sportsman HO	2010/2010	0651431	YB14A-A2	0681431	ESB14A-A2■	—	—
500 Sportsman X2 / X2 EFI	2007/2009	065275	YIX30L▲	—	—	—	—
500 Trail Boss	1999/2003	065122	YTX14AH-BS■	068122	ESTX14AH-BS■	—	—
500 Trail Boss	1999/2003	0651431	YB14A-A2	0681431	ESB14A-A2■	—	—
500 Xplorer 4X4	1997/1997	065122	YTX14AH-BS■	068122	ESTX14AH-BS■	—	—
500 Xplorer 4X4	1997/1997	0651431	YB14A-A2	0681431	ESB14A-A2■	—	—
525 Outlaw	2007/2010	0650990	YTX9-BS■	068099	ESTX9-BS■	063099	FTX9-BS■
550 Sportsman	2009/2010	065215	YTX24HL-BS■	—	—	—	—
700 Hurricane	1996/>	065186	YTX20HL-BS-PW■	—	—	—	—
700 Sportsman	2002/2003	065275	YIX30L▲	—	—	—	—
700 Sportsman	2002/2003	0653036	YB30L-B	0683036	ESB30L-B■	—	—
700 Sportsman Mv	2005/2006	065275	YIX30L▲	—	—	—	—
700 Sportsman Mv	2005/2006	0653036	YB30L-B	0683036	ESB30L-B■	—	—
700 Sportsman Twin EFI	2004/2005	065275	YIX30L▲	—	—	—	—
700 Sportsman Twin EFI	2004/2005	0653036	YB30L-B	0683036	ESB30L-B■	—	—

▲ - Factory Sealed / Attivata dalla Fabbrica ■ - con Acido a corredo ◇ - Non di produzione YUASA a completamento gamma



Marca / Cilindrata / Modello / Anno			Cod. SGR		Cod. SGR		Cod. SGR		
POLARIS									
700	Sportsman X2 EFI	2007/2009	065275	YIX30L▲	—	—	—	—	
779	SL, SLX, SLT	1996/>	065186	YTX20HL-BS-PW■	—	—	—	—	
800	Ranger EFI 4X4	2010/2010	0650202	GYZ20HL▲	—	—	—	—	
800	Ranger EFI 4X4	2010/2010	065185	YTX20HL-BS■	—	—	—	—	
800	Ranger EFI 6X6	2010/2010	065215	YTX24HL-BS■	—	—	—	—	
800	Ranger EFI 6X6	2010/2010	065275	YIX30L▲	—	—	—	—	
800	Ranger RZR EFI	2008/2010	0650202	GYZ20HL▲	—	—	—	—	
800	Ranger RZR EFI	2008/2010	065185	YTX20HL-BS■	—	—	—	—	
800	Ranger RZR EFI S	2008/2010	0650202	GYZ20HL▲	—	—	—	—	
800	Ranger RZR EFI S	2008/2010	065185	YTX20HL-BS■	—	—	—	—	
800	Sportsman Twin EFI	2005/2009	065275	YIX30L▲	—	—	—	—	
800	Sportsman Twin EFI	2010/2010	065215	YTX24HL-BS■	—	—	—	—	
1000	SLTX, SLXH, SLT	1996/>	065186	YTX20HL-BS-PW■	—	—	—	—	
1165	SLX	1999/>	065186	YTX20HL-BS-PW■	—	—	—	—	
1507	Victory 8-ball / Harlen Ness	2004/2005	0650202	GYZ20HL▲	—	—	—	—	
1507	Victory 8-ball / Harlen Ness	2004/2005	065185	YTX20HL-BS■	—	—	—	—	
All	Electric Start Kits	1985/1993	065215	YTX24HL-BS■	—	—	—	—	
Indy, Wide	Indy Trail Track	1984/1991 1989/2001	065215	YTX24HL-BS■	—	—	—	—	
PULSE									
50	BT49QT-12F1 Tanco 4T R12	TUTTI	0650700	YTX7A-BS■	068070	ESTX7A-BS■	—	—	
QUADRO									
350	Quadro D - Quadro 3	2012/2015	0651090	YTX12-BS■	0681090	ESTX12-BS■	063109	FTX12-BS■	
RIEJU									
250	Marathon	2009/2010	065007	YTZ7S▲	—	—	063007	FTZ7S▲	
450	Marathon	2009/2010	065007	YTZ7S▲	—	—	063007	FTZ7S▲	
RIZZATO									
50	Byte AT 10	TUTTI	06504340	YB4L-B	—	—	—	—	
50	Byte AT 10	TUTTI	065043410	YB4L-B■	0680434	ESB4L-B■	—	—	
50	Carosello	TUTTI	06504340	YB4L-B	—	—	—	—	
50	Carosello	TUTTI	065043410	YB4L-B■	0680434	ESB4L-B■	—	—	
50	Hacker AT12/ Racing/ LC	TUTTI	06504340	YB4L-B	—	—	—	—	
50	Hacker AT12/ Racing/ LC	TUTTI	065043410	YB4L-B■	0680434	ESB4L-B■	—	—	
SEP									
Motori	agricoli	TUTTI	0652434	Y60-N24-A	—	—	—	—	
SUZUKI									
50	AH Address	1992/1995	0650390	YTX4L-BS■	068039	ESTX4L-BS■	—	—	
50	AJ ZZ	1995/1997	065030	YT4B-BS■	—	—	—	—	
50	AP R/ T R7	1994/1997	0650390	YTX4L-BS■	068039	ESTX4L-BS■	—	—	
50	AY Katana Air/ Lc	1997/1998	0650390	YTX4L-BS■	068039	ESTX4L-BS■	—	—	
50	AY Katana LC	</1998	0650390	YTX4L-BS■	068039	ESTX4L-BS■	—	—	

▲ - Factory Sealed / Attivata dalla Fabbrica ■ - con Acido a corredo ◇ - Non di produzione YUASA a completamento gamma





SUZUKI



50	CC Tune	TUTTI	0650390	YTX4L-BS ■	068039	ESTX4L-BS ■	—	—
50	CP	1991/1994	0650390	YTX4L-BS ■	068039	ESTX4L-BS ■	—	—
50	LT Z Quadspost	2006/2007	065049	YTX5L-BS ■	068049	ESTX5L-BS ■	063049	FTX5L-BS ■
50	Sepia	TUTTI	0650390	YTX4L-BS ■	068039	ESTX4L-BS ■	—	—
50	TR Street Magic	1998/2000	065030	YT4B-BS ■	—	—	—	—
50	UX Zillion	1999/2003	0650390	YTX4L-BS ■	068039	ESTX4L-BS ■	—	—
50	ZZ	1992/>	0650390	YTX4L-BS ■	068039	ESTX4L-BS ■	—	—
80	LT Quadspost	2002/2006	065049	YTX5L-BS ■	068049	ESTX5L-BS ■	063049	FTX5L-BS ■
90	LT Z Quadspost	2006/2010	0650700	YTX7A-BS ■	068070	ESTX7A-BS ■	—	—
100	AH Address	1995/1996	065049	YTX5L-BS ■	068049	ESTX5L-BS ■	063049	FTX5L-BS ■
110	UG Hokuto	2000/2002	065049	YTX5L-BS ■	068049	ESTX5L-BS ■	063049	FTX5L-BS ■
125	AN	1995/2000	0650700	YTX7A-BS ■	068070	ESTX7A-BS ■	—	—
125	DR S (SF42A)	1982/1984	0650390	YTX4L-BS ■	068039	ESTX4L-BS ■	—	—
125	DR SE (SF44A)	1985/2000	0650690	YTX7L-BS ■	068069	ESTX7L-BS ■	063069	FTX7L-BS ■
125	DR SM	2009/2013	0650690	YTX7L-BS ■	068069	ESTX7L-BS ■	063069	FTX7L-BS ■
125	GN E	1991/2000	0650736	YB7-A	0680736	ESB7-A ■	—	—
125	GN Z	1982/1983	0650736	YB7-A	0680736	ESB7-A ■	—	—
125	GZ Marauder	1998/2011	0650690	YTX7L-BS ■	068069	ESTX7L-BS ■	063069	FTX7L-BS ■
125	RG F Gamma (NF41A) N/ R	1992/1995	0650690	YTX7L-BS ■	068069	ESTX7L-BS ■	063069	FTX7L-BS ■
125	RG Gamma	1986/1990	065049	YTX5L-BS ■	068049	ESTX5L-BS ■	063049	FTX5L-BS ■
125	RV Van Van	2003/2013	0650690	YTX7L-BS ■	068069	ESTX7L-BS ■	063069	FTX7L-BS ■
125	TS R	1989/1994	0650390	YTX4L-BS ■	068039	ESTX4L-BS ■	—	—
125	UC Epicuro	1999/2003	0650700	YTX7A-BS ■	068070	ESTX7A-BS ■	—	—
125	UE	2001/2002	0650700	YTX7A-BS ■	068070	ESTX7A-BS ■	—	—
125	UH Burgman	2002/2014	0650990	YTX9-BS ■	068099	ESTX9-BS ■	063099	FTX9-BS ■
125	UX Sixteen	2007/2014	0650690	YTX7L-BS ■	068069	ESTX7L-BS ■	063069	FTX7L-BS ■
125	VL Intruder LC	2000/2007	0650690	YTX7L-BS ■	068069	ESTX7L-BS ■	063069	FTX7L-BS ■
150	AN	1996/2000	0650700	YTX7A-BS ■	068070	ESTX7A-BS ■	—	—
150	UC Epicuro	1999/2003	0650700	YTX7A-BS ■	068070	ESTX7A-BS ■	—	—
150	UE	2001/2002	0650700	YTX7A-BS ■	068070	ESTX7A-BS ■	—	—
150	UH Burgman	2002/2006	0650990	YTX9-BS ■	068099	ESTX9-BS ■	063099	FTX9-BS ■
150	UX Sixteen	2007/2014	0650690	YTX7L-BS ■	068069	ESTX7L-BS ■	063069	FTX7L-BS ■
200	DR SE	1996/2006	0650690	YTX7L-BS ■	068069	ESTX7L-BS ■	063069	FTX7L-BS ■
200	SP	1986/1988	06504340	YB4L-B	—	—	—	—
200	SP	1986/1988	065043410	YB4L-B ■	0680434	ESB4L-B ■	—	—
200	UH Burgman	2007/2014	0650990	YTX9-BS ■	068099	ESTX9-BS ■	063099	FTX9-BS ■
230	LT E Quadrunner	1988/1993	0651090	YTX12-BS ■	0681090	ESTX12-BS ■	063109	FTX12-BS ■
250	AN Burgman	1998/1999	0650700	YTX7A-BS ■	068070	ESTX7A-BS ■	—	—
250	AN Burgman	2000/2002	0650990	YTX9-BS ■	068099	ESTX9-BS ■	063099	FTX9-BS ■
250	AN Burgman	2003/2006	0651110	YT12A-BS ■	0681110	EST12A-BS ■	—	—
250	DR L (L/ M/ N/ P) (DJ42A)	1990/1993	0650390	YTX4L-BS ■	068039	ESTX4L-BS ■	—	—

Marca / Cilindrata / Modello / Anno		Cod. SGR		Cod. SGR		Cod. SGR	
SUZUKI							
250 DR SE (SJ44A)	1993/1999	0650690	YTX7L-BS■	068069	ESTX7L-BS■	063069	FTX7L-BS■
250 DR-Z	2001/2007	065007	YTZ7S▲	—	—	063007	FTZ7S▲
250 GN	1982/1997	0651134	YB10L-A2	0681134	ESB10L-A2■	—	—
250 GST	1979/1981	0651134	YB10L-A2	0681134	ESB10L-A2■	—	—
250 GSF Bandit	1995/>	0650700	YTX7A-BS■	068070	ESTX7A-BS■	—	—
250 GSX (Gs25X/ B803/ 1)	1981/>	0651238	YB12B-B2	—	—	—	—
250 GT Hustler	1973/1977	0650533	12N5-3B	—	—	—	—
250 GW Inazuma	2012/2013	0650990	YTX9-BS■	068099	ESTX9-BS■	063099	FTX9-BS■
250 GZ Marauder	1999/2007	0650690	YTX7L-BS■	068069	ESTX7L-BS■	063069	FTX7L-BS■
250 LT F Ozark (K2/ K9/ L0)	2002/2010	0651090	YTX12-BS■	0681090	ESTX12-BS■	063109	FTX12-BS■
250 LT F Quadrunner 2x4 (J/ K/ L/ M/ N/ P/ R/ S/ T/ V/ W/ X/ Y/ K1)	1988/2001	065122	YTX14AH-BS■	068122	ESTX14AH-BS■	—	—
250 LT F Quadrunner 2x4 (J/ K/ L/ M/ N/ P/ R/ S/ T/ V/ W/ X/ Y/ K1)	1988/2001	0651431	YB14A-A2	0681431	ESB14A-A2■	—	—
250 LT F Quadrunner 4x4 (FX/ FY/ FK1/ FK2)	1999/2002	0651090	YTX12-BS■	0681090	ESTX12-BS■	063109	FTX12-BS■
250 LT F Quadrunner 4x4 (H/ J/ K/ L/ M/ N/ P/ S/ T/ VA/ V)	1987/1998	065122	YTX14AH-BS■	068122	ESTX14AH-BS■	—	—
250 LT F Quadrunner 4x4 (H/ J/ K/ L/ M/ N/ P/ S/ T/ VA/ V)	1987/1998	0651431	YB14A-A2	0681431	ESB14A-A2■	—	—
250 LT Z Quadsport (K4/ K9/ L0)	2004/2010	0650990	YTX9-BS■	068099	ESTX9-BS■	063099	FTX9-BS■
250 RGV Gamma	1991/1992	0650390	YTX4L-BS■	068039	ESTX4L-BS■	—	—
250 TC Scrambler	1969/1969	0650533	12N5-3B	—	—	—	—
250 TU Volty	TUTTI	0651134	YB10L-A2	0681134	ESB10L-A2■	—	—
250 TU X	1997/2012	0651134	YB10L-A2	0681134	ESB10L-A2■	—	—
250 VL Intruder LC	2000/2007	0650690	YTX7L-BS■	068069	ESTX7L-BS■	063069	FTX7L-BS■
280 LT F KingQuad 4X4	1991/1999	065122	YTX14AH-BS■	068122	ESTX14AH-BS■	—	—
300 LT E QuadRunner (H/ J/ K)	1987/1989	065122	YTX14AH-BS■	068122	ESTX14AH-BS■	—	—
300 LT F KingQuad 4X4 (XH/ J/ K/ L/ M/ N/ P/ R/ S/ T/ V/ W/ FX/ FY/ FK1/ FK2)	1987/2002	065122	YTX14AH-BS■	068122	ESTX14AH-BS■	—	—
350 DR S (SK42A) L-P	1990/1993	0650390	YTX4L-BS■	068039	ESTX4L-BS■	—	—
350 DR SE (SK42A) R-W	1994/1998	0650690	YTX7L-BS■	068069	ESTX7L-BS■	063069	FTX7L-BS■
350 DR SE (SK42A) R-W	1997/2001	0650390	YTX4L-BS■	068039	ESTX4L-BS■	—	—
350 DR SE (SK42A) R-W	1997/2001	0650700	YTX7A-BS■	068070	ESTX7A-BS■	—	—
380 GT Sebring	1972/1977	0650733	12N7-4A	0680733	ES12N7-4A■	—	—
400 AN Burgman	1998/2002	0650990	YTX9-BS■	068099	ESTX9-BS■	063099	FTX9-BS■
400 AN Burgman	2003/2006	0651110	YT12A-BS■	0681110	EST12A-BS■	—	—
400 AN Burgman (K7/ K8/ K9/ L0/ L1)	2006/2013	0651110	YT12A-BS■	0681110	EST12A-BS■	—	—
400 DR S (T/ X)	1979/1981	0600412	6N4B-2A	—	—	—	—
400 DR Z E	2000/2008	0650710	YT7B-BS■	068071	EST7B-BS■	—	—
400 DR Z S	2000/2012	0650710	YT7B-BS■	068071	EST7B-BS■	—	—
400 DR Z SM	2005/2010	0650710	YT7B-BS■	068071	EST7B-BS■	—	—
400 GS B	1977/1978	0651134	YB10L-A2	0681134	ESB10L-A2■	—	—
400 GS C	1977/1979	0651134	YB10L-A2	0681134	ESB10L-A2■	—	—
400 GS EC	1978/1978	0651134	YB10L-A2	0681134	ESB10L-A2■	—	—
400 GSF Bandit (GK7AA)	1993/1997	0650990	YTX9-BS■	068099	ESTX9-BS■	063099	FTX9-BS■
400 GSX R	1979/1981	0650700	YTX7A-BS■	068070	ESTX7A-BS■	—	—



▲ - Factory Sealed / Attivata dalla Fabbrica ■ - con Acido a corredo ◇ - Non di produzione YUASA a completamento gamma

Marca / Cilindrata / Modello / Anno			Cod. SGR		Cod. SGR		Cod. SGR		
SUZUKI									
400	LT A Eiger 2X4 (FK2/ FK4)	2002/2004	065124	YTX14H-BS■	—	—	—	—	
400	LT A Eiger 2X4 (FK2/ FK4)	2002/2004	065129	YTX14-BS■	068129	ESTX14-BS■	—	—	
400	LT A Eiger 4x4 (FK2/ FK7)	2002/2007	065124	YTX14H-BS■	—	—	—	—	
400	LT A Eiger 4x4 (FK2/ FK7)	2002/2007	065129	YTX14-BS■	068129	ESTX14-BS■	—	—	
400	LT F Eiger 2X4 (FK2/ FK4)	2002/2004	065124	YTX14H-BS■	—	—	—	—	
400	LT F Eiger 2X4 (FK2/ FK4)	2002/2004	065129	YTX14-BS■	068129	ESTX14-BS■	—	—	
400	LT F Eiger 4X4 (FK2/ FK7)	2002/2007	065124	YTX14H-BS■	—	—	—	—	
400	LT F Eiger 4X4 (FK2/ FK7)	2002/2007	065129	YTX14-BS■	068129	ESTX14-BS■	—	—	
400	LT F KingQuad FS 4X2 (FK8/ L0)	2008/2010	065124	YTX14H-BS■	—	—	—	—	
400	LT F KingQuad FS 4X2 (FK8/ L0)	2008/2010	065129	YTX14-BS■	068129	ESTX14-BS■	—	—	
400	LT F KingQuad FS 4X4 (FK8/ L2)	2008/2012	065124	YTX14H-BS■	—	—	—	—	
400	LT F KingQuad FS 4X4 (FK8/ L2)	2008/2012	065129	YTX14-BS■	068129	ESTX14-BS■	—	—	
400	LT Z QuadSport	2002/2010	0650990	YTX9-BS■	068099	ESTX9-BS■	063099	FTX9-BS■	
400	LTA F KingQuad 4X4 (K8/ L1)	2008/2011	065124	YTX14H-BS■	—	—	—	—	
400	LTA F KingQuad 4X4 (K8/ L1)	2008/2011	065129	YTX14-BS■	068129	ESTX14-BS■	—	—	
400	TS Apache	1989/1989	0650533	12N5-3B	—	—	—	—	
450	GS E	1975/1977	0651238	YB12B-B2	—	—	—	—	
450	GS L	1975/1977	0651238	YB12B-B2	—	—	—	—	
450	LT A X KingQuad	2007/2010	065124	YTX14H-BS■	—	—	—	—	
450	LT A X KingQuad	2007/2010	065129	YTX14-BS■	068129	ESTX14-BS■	—	—	
450	LT R Quadracer	2006/2010	0650700	YTX7A-BS■	068070	ESTX7A-BS■	—	—	
500	DR	1989/1989	0600412	6N4B-2A	—	—	—	—	
500	GS E (GM51A) (2Cil.)	1989/1996	0651137	YB10L-B2	0681137	ESB10L-B2■	—	—	
500	GS K/ H/ FH (BK111/ BK211/ BK221/ BK411) (2Cil.)	2001/2007	0651137	YB10L-B2	0681137	ESB10L-B2■	—	—	
500	GT Titan	1976/1977	0650733	12N7-4A	0680733	ES12N7-4A■	—	—	
500	LT A F Vinson 4X4	2002/2007	065187	YTX20CH-BS■	068187	ESTX20CH-BS■	—	—	
500	LT A KingQuad XP	2009/2010	065187	YTX20CH-BS■	068187	ESTX20CH-BS■	—	—	
500	RG Gamma (HM31A)	1985/1989	065049	YTX5L-BS■	068049	ESTX5L-BS■	063049	FTX5L-BS■	
500	T Titan	1979/1981	0650733	12N7-4A	0680733	ES12N7-4A■	—	—	
550	GS (B/ N) (Tamburo)	1977/1979	0651134	YB10L-A2	0681134	ESB10L-A2■	—	—	
550	GS E (C/ N/ T/ X/ Z)	1978/1982	0651134	YB10L-A2	0681134	ESB10L-A2■	—	—	
550	GS L (N/ T/ X/ F/ G/ CG)	1979/1982	0651134	YB10L-A2	0681134	ESB10L-A2■	—	—	
550	GS L (N/ T/ X/ F/ G/ CG)	1983/1983	0651135	YB10L-B	0681135	ESB10L-B■	—	—	
550	GS M Katana	1982/1982	0651134	YB10L-A2	0681134	ESB10L-A2■	—	—	
550	GS T	1981/1981	0651134	YB10L-A2	0681134	ESB10L-A2■	—	—	
550	GSX E (D/ E/ S/ F/ G/ U)	1983/1983	0651135	YB10L-B	0681135	ESB10L-B■	—	—	
550	GSX ES (D/ E/ F/ G/ H)	1983/1983	0651135	YB10L-B	0681135	ESB10L-B■	—	—	
550	GSX ES (D/ E/ F/ G/ H)	1984/1987	0651134	YB10L-A2	0681134	ESB10L-A2■	—	—	
600	DR R Djebel / Dakar - DR S	1986/1990	0650533	12N5-3B	—	—	—	—	
600	GSF Bandit	1995/2004	0650990	YTX9-BS■	068099	ESTX9-BS■	063099	FTX9-BS■	
600	GSF Bandit S	1998/2004	0650990	YTX9-BS■	068099	ESTX9-BS■	063099	FTX9-BS■	



▲ - Factory Sealed / Attivata dalla Fabbrica ■ - con Acido a corredo ◇ - Non di produzione YUASA a completamento gamma

Marca / Cilindrata / Modello / Anno		Cod. SGR		Cod. SGR		Cod. SGR		
SUZUKI								
600	GSR	2006/2010	0650990	YTX9-BS■	068099	ESTX9-BS■	063099	FTX9-BS■
600	GSX F	1988/1998	0651137	YB10L-B2	0681137	ESB10L-B2■	—	—
600	GSX F	1999/2006	0650990	YTX9-BS■	068099	ESTX9-BS■	063099	FTX9-BS■
600	GSX R (K1/ K2/ K3)	2001/2003	0650990	YTX9-BS■	068099	ESTX9-BS■	063099	FTX9-BS■
600	GSX R (K4/ K5)	2004/2005	0650990	YTX9-BS■	068099	ESTX9-BS■	063099	FTX9-BS■
600	GSX R (K6/ K7)	2006/2007	0650990	YTX9-BS■	068099	ESTX9-BS■	063099	FTX9-BS■
600	GSX R (K8/ K9/ L0)	2008/2010	0650990	YTX9-BS■	068099	ESTX9-BS■	063099	FTX9-BS■
600	GSX R (L1/ L2/ L3/ L4/ L5/ L6/ L7)	2011/2017	0650990	YTX9-BS■	068099	ESTX9-BS■	063099	FTX9-BS■
600	GSX R (N/ P)	1993/1993	0650990	YTX9-BS■	068099	ESTX9-BS■	063099	FTX9-BS■
600	GSX R (R/ S)	1994/1995	0650990	YTX9-BS■	068099	ESTX9-BS■	063099	FTX9-BS■
600	GSX R (T)	1996/1996	0650990	YTX9-BS■	068099	ESTX9-BS■	063099	FTX9-BS■
600	GSX R (V/ W/ Y)	1997/2000	0650990	YTX9-BS■	068099	ESTX9-BS■	063099	FTX9-BS■
600	RF R (GN76A)	1993/1997	0650990	YTX9-BS■	068099	ESTX9-BS■	063099	FTX9-BS■
600	SP	1985/>	0650533	12N5-3B	—	—	—	—
600	VS GL Intruder	1995/>	0651637	YB16B-A	0681637	ESB16B-A■	—	—
620	QUV F	2005/2005	0650202	GYZ20HL▲	—	—	—	—
620	QUV F	2005/2005	065185	YTX20HL-BS■	—	—	—	—
650	AN Burgman	2003/2013	065124	YTX14H-BS■	—	—	—	—
650	AN Burgman	2003/2013	065129	YTX14-BS■	068129	ESTX14-BS■	—	—
650	DL V Strom	2004/2011	0651090	YTX12-BS■	0681090	ESTX12-BS■	063109	FTX12-BS■
650	DL V Strom ABS	2007/2015	0651090	YTX12-BS■	0681090	ESTX12-BS■	063109	FTX12-BS■
650	DL V Strom XT ABS	2015/2015	0651090	YTX12-BS■	0681090	ESTX12-BS■	063109	FTX12-BS■
650	DR R (SP41A)	1990/1991	0650534	YB5L-B	0680534	ESB5L-B■	—	—
650	DR R (SP44A)	1992/1993	0650390	YTX4L-BS■	068039	ESTX4L-BS■	—	—
650	DR RE (SP45A)	1994/1995	0651090	YTX12-BS■	0681090	ESTX12-BS■	063109	FTX12-BS■
650	DR RS (SP42A)	1990/1991	0650533	12N5-3B	—	—	—	—
650	DR RSE (SP43A)	1991/1993	065124	YTX14H-BS■	—	—	—	—
650	DR RSE (SP43A)	1991/1993	065129	YTX14-BS■	068129	ESTX14-BS■	—	—
650	DR SE (SP46A)	1996/2013	0650990	YTX9-BS■	068099	ESTX9-BS■	063099	FTX9-BS■
650	GR Temper	1983/1984	065123	YTX14AHL-BS■	—	—	—	—
650	GR Temper	1983/1984	0651434	YB14L-A2	0681434	ESB14L-A2■	—	—
650	GS E	1981/1982	065123	YTX14AHL-BS■	—	—	—	—
650	GS E	1981/1982	0651434	YB14L-A2	0681434	ESB14L-A2■	—	—
650	GS G Katana (D)	1983/1983	065123	YTX14AHL-BS■	—	—	—	—
650	GS G Katana (D)	1983/1983	0651434	YB14L-A2	0681434	ESB14L-A2■	—	—
650	GS G Katana (X/ Z)	1981/1982	065123	YTX14AHL-BS■	—	—	—	—
650	GS G Katana (X/ Z)	1981/1982	0651434	YB14L-A2	0681434	ESB14L-A2■	—	—
650	GS GL (X/ Z)	1981/1983	065123	YTX14AHL-BS■	—	—	—	—
650	GS GL (X/ Z)	1981/1983	0651434	YB14L-A2	0681434	ESB14L-A2■	—	—
650	GSF N Bandit	2005/2012	0650990	YTX9-BS■	068099	ESTX9-BS■	063099	FTX9-BS■
650	GSF N Bandit Abs	2005/2012	0650990	YTX9-BS■	068099	ESTX9-BS■	063099	FTX9-BS■



▲ - Factory Sealed / Attivata dalla Fabbrica ■ - con Acido a corredo ◇ - Non di produzione YUASA a completamento gamma

Marca / Cilindrata / Modello / Anno			Cod. SGR		Cod. SGR		Cod. SGR	
SUZUKI								
650	GSF S Bandit	2005/2012	0650990	YTX9-BS■	068099	ESTX9-BS■	063099	FTX9-BS■
650	GSF S Bandit Abs	2005/2013	0650990	YTX9-BS■	068099	ESTX9-BS■	063099	FTX9-BS■
650	GSX F / GSX F ABS	2008/2013	0650990	YTX9-BS■	068099	ESTX9-BS■	063099	FTX9-BS■
650	LS	1975/1977	0651439	YB14L-B2	0681439	ESB14L-B2■	—	—
650	LS Savage / S40 Boulevard (LS650)	1986/2005	065123	YTX14AHL-BS■	—	—	—	—
650	LS Savage / S40 Boulevard (LS650)	1986/2005	0651434	YB14L-A2	0681434	ESB14L-A2■	—	—
650	SVF Gladius	2009/2015	0651110	YT12A-BS■	0681110	EST12A-BS■	—	—
650	SV	1999/2002	0651110	YT12A-BS■	0681110	EST12A-BS■	—	—
650	SV	2003/2011	0651090	YTX12-BS■	0681090	ESTX12-BS■	063109	FTX12-BS■
650	SV ABS	2007/2011	0651110	YT12A-BS■	0681110	EST12A-BS■	—	—
650	SV ABS (L7) (CX123/ CX243)	2017/2017	0651110	YT12A-BS■	0681110	EST12A-BS■	—	—
650	SV S	1999/2002	0651110	YT12A-BS■	0681110	EST12A-BS■	—	—
650	SV S	2003/2011	0651090	YTX12-BS■	0681090	ESTX12-BS■	063109	FTX12-BS■
650	SV S ABS	2007/2012	0651110	YT12A-BS■	0681110	EST12A-BS■	—	—
650	XF Freewind	1997/2003	0650990	YTX9-BS■	068099	ESTX9-BS■	063099	FTX9-BS■
650	XN85 Turbo	1983/1983	065123	YTX14AHL-BS■	—	—	—	—
650	XN85 Turbo	1983/1983	0651434	YB14L-A2	0681434	ESB14L-A2■	—	—
700	LT A X KingQuad	2005/2007	065187	YTX20CH-BS■	068187	ESTX20CH-BS■	—	—
700	LT V Twin Peaks 4X4	2002/2005	065124	YTX14H-BS■	—	—	—	—
700	LT V Twin Peaks 4X4	2002/2005	065129	YTX14-BS■	068129	ESTX14-BS■	—	—
750	DR S Big (Sr41B/ E777)	1988/1990	0651439	YB14L-B2	0681439	ESB14L-B2■	—	—
750	GS (A/ B)	1977/1977	065123	YTX14AHL-BS■	—	—	—	—
750	GS (A/ B)	1977/1977	0651434	YB14L-A2	0681434	ESB14L-A2■	—	—
750	GS (B/ C)	1977/1978	065123	YTX14AHL-BS■	—	—	—	—
750	GS (B/ C)	1977/1978	0651434	YB14L-A2	0681434	ESB14L-A2■	—	—
750	GS E (C/ N)	1978/1979	065123	YTX14AHL-BS■	—	—	—	—
750	GS E (C/ N)	1978/1979	0651434	YB14L-A2	0681434	ESB14L-A2■	—	—
750	GS G (T/ X)	1980/1981	065123	YTX14AHL-BS■	—	—	—	—
750	GS G (T/ X)	1980/1981	0651434	YB14L-A2	0681434	ESB14L-A2■	—	—
750	GS GL (X)	1981/1981	065123	YTX14AHL-BS■	—	—	—	—
750	GS GL (X)	1981/1981	0651434	YB14L-A2	0681434	ESB14L-A2■	—	—
750	GS L	1979/1980	065123	YTX14AHL-BS■	—	—	—	—
750	GS L	1979/1980	0651434	YB14L-A2	0681434	ESB14L-A2■	—	—
750	GSR	2011/2016	0651110	YT12A-BS■	0681110	EST12A-BS■	—	—
750	GSR ABS	2011/2016	0651110	YT12A-BS■	0681110	EST12A-BS■	—	—
750	GSX	1998/2002	0650990	YTX9-BS■	068099	ESTX9-BS■	063099	FTX9-BS■
750	GSX E (EE)	1984/1984	0651434	YB14L-A2	0681434	ESB14L-A2■	—	—
750	GSX E (T/ X/ Z)	1980/1982	0651434	YB14L-A2	0681434	ESB14L-A2■	—	—
750	GSX EF (D/ E/ F) (GR72A/ D037)	1983/1986	0651434	YB14L-A2	0681434	ESB14L-A2■	—	—
750	GSX ES (D/ E/ F) (GR72A/ D037)	1983/1985	0651434	YB14L-A2	0681434	ESB14L-A2■	—	—
750	GSX ES (G) (GR72A/ D787)	1986/1987	0651434	YB14L-A2	0681434	ESB14L-A2■	—	—

▲ - Factory Sealed / Attivata dalla Fabbrica ■ - con Acido a corredo ◇ - Non di produzione YUASA a completamento gamma

Marca / Cilindrata / Modello / Anno			Cod. SGR		Cod. SGR		Cod. SGR		
SUZUKI									
750	GSX F (GR78A)	1988/1998	0651439	YB14L-B2	0681439	ESB14L-B2 ■	—	—	
750	GSX F (GR78A)	1999/2006	0650990	YTX9-BS ■	068099	ESTX9-BS ■	063099	FTX9-BS ■	
750	GSX L (T)(GS75X/ B895/ 1/ 2)	1980/1980	0651434	YB14L-A2	0681434	ESB14L-A2 ■	—	—	
750	GSX L (X)(GS75X/ B895/ 1/ 2)	1981/1981	0651434	YB14L-A2	0681434	ESB14L-A2 ■	—	—	
750	GSX L (Z)(GS75X/ B895/ 1/ 2)	1982/1982	0651434	YB14L-A2	0681434	ESB14L-A2 ■	—	—	
750	GSX R (F/ H)	1985/1987	065123	YTX14AHL-BS ■	—	—	—	—	
750	GSX R (F/ H)	1985/1987	0651434	YB14L-A2	0681434	ESB14L-A2 ■	—	—	
750	GSX R (J/ L)	1988/1990	065123	YTX14AHL-BS ■	—	—	—	—	
750	GSX R (J/ L)	1988/1990	0651434	YB14L-A2	0681434	ESB14L-A2 ■	—	—	
750	GSX R (K4/ K5)	2004/2005	0651110	YT12A-BS ■	0681110	EST12A-BS ■	—	—	
750	GSX R (K6/ K7)	2006/2007	0651110	YT12A-BS ■	0681110	EST12A-BS ■	—	—	
750	GSX R (K8/ K9/ L0)	2008/2010	0651110	YT12A-BS ■	0681110	EST12A-BS ■	—	—	
750	GSX R (L1/ L2/ L3/ L4/ L5/ L6/ L7)	2011/2017	0651110	YT12A-BS ■	0681110	EST12A-BS ■	—	—	
750	GSX R (M)	1991/1991	065123	YTX14AHL-BS ■	—	—	—	—	
750	GSX R (M)	1991/1991	0651434	YB14L-A2	0681434	ESB14L-A2 ■	—	—	
750	GSX R (T/ V/ W/ X)	1996/1999	0650990	YTX9-BS ■	068099	ESTX9-BS ■	063099	FTX9-BS ■	
750	GSX R (Y/ K1/ K2/ K3)	2000/2003	0651110	YT12A-BS ■	0681110	EST12A-BS ■	—	—	
750	GSX R SP (R)	1994/1994	0651090	YTX12-BS ■	0681090	ESTX12-BS ■	063109	FTX12-BS ■	
750	GSX R W (N/ P/ R/ S)	1992/1995	0651090	YTX12-BS ■	0681090	ESTX12-BS ■	063109	FTX12-BS ■	
750	GSX S Katana (SE/ SF) (GR71A>GR72A)	1984/1985	065123	YTX14AHL-BS ■	—	—	—	—	
750	GSX S Katana (SE/ SF) (GR71A>GR72A)	1984/1985	0651434	YB14L-A2	0681434	ESB14L-A2 ■	—	—	
750	GSX S Katana (SX/ SZ/ SD)	1982/1983	065123	YTX14AHL-BS ■	—	—	—	—	
750	GSX S Katana (SX/ SZ/ SD)	1982/1983	0651434	YB14L-A2	0681434	ESB14L-A2 ■	—	—	
750	GSX S/ SK ABS (USA)	2015/2016	0651110	YT12A-BS ■	0681110	EST12A-BS ■	—	—	
750	LT A KingQuad XP	2008/2010	065187	YTX20CH-BS ■	068187	ESTX20CH-BS ■	—	—	
750	VS GL/ GLP Intruder	1985/1991	0651637	YB16B-A	0681637	ESB16B-A ■	—	—	
800	DR Big	1988/1990	0651439	YB14L-B2	0681439	ESB14L-B2 ■	—	—	
800	DR Big	1991/1997	065124	YTX14H-BS ■	—	—	—	—	
800	DR Big	1991/1997	065129	YTX14-BS ■	068129	ESTX14-BS ■	—	—	
800	VL Intruder C800	2006/2013	0651090	YTX12-BS ■	0681090	ESTX12-BS ■	063109	FTX12-BS ■	
800	VL Intruder Volusia	1999/2005	0651090	YTX12-BS ■	0681090	ESTX12-BS ■	063109	FTX12-BS ■	
800	VS GL Intruder (VS52A)	1992/1999	0651637	YB16B-A	0681637	ESB16B-A ■	—	—	
800	VS GL Intruder (VS52A)	2000/2004	0650990	YTX9-BS ■	068099	ESTX9-BS ■	063099	FTX9-BS ■	
800	VX	1990/1999	0651637	YB16B-A	0681637	ESB16B-A ■	—	—	
800	VZ Intruder M800	2005/2013	0651090	YTX12-BS ■	0681090	ESTX12-BS ■	063109	FTX12-BS ■	
800	VZ Marauder	1997/2003	0651090	YTX12-BS ■	0681090	ESTX12-BS ■	063109	FTX12-BS ■	
850	GS G (N/ T/ X/ Z/ E/ G)	1979/1983	065123	YTX14AHL-BS ■	—	—	—	—	
850	GS G (N/ T/ X/ Z/ E/ G)	1979/1986	0651434	YB14L-A2	0681434	ESB14L-A2 ■	—	—	
850	GS GL	1979/1983	065123	YTX14AHL-BS ■	—	—	—	—	
850	GS GL	1979/1983	0651434	YB14L-A2	0681434	ESB14L-A2 ■	—	—	
900	RF R	1994/1999	0650990	YTX9-BS ■	068099	ESTX9-BS ■	063099	FTX9-BS ■	

▲ - Factory Sealed / Attivata dalla Fabbrica ■ - con Acido a corredo ◇ - Non di produzione YUASA a completamento gamma

Marca / Cilindrata / Modello / Anno			Cod. SGR		Cod. SGR		Cod. SGR		
SUZUKI									
1000	DL V Strom (K2/ L0) (BS111/ BS121)	2002/2013	065124	YTX14H-BS■	—	—	—	—	—
1000	DL V Strom (K2/ L0) (BS111/ BS121)	2002/2013	065129	YTX14-BS■	068129	ESTX14-BS■	—	—	—
1000	DL V Strom (L4/ L5) (DD111)	2014/2015	065124	YTX14H-BS■	—	—	—	—	—
1000	DL V Strom (L4/ L5) (DD111)	2014/2015	065129	YTX14-BS■	068129	ESTX14-BS■	—	—	—
1000	GS	1978/1982	065123	YTX14AHL-BS■	—	—	—	—	—
1000	GS	1978/1982	0651434	YB14L-A2	0681434	ESB14L-A2■	—	—	—
1000	GS C (C/ N)	1978/1979	065123	YTX14AHL-BS■	—	—	—	—	—
1000	GS C (C/ N)	1978/1979	0651434	YB14L-A2	0681434	ESB14L-A2■	—	—	—
1000	GS H (C/ N)	1978/1979	065123	YTX14AHL-BS■	—	—	—	—	—
1000	GS H (C/ N)	1978/1979	0651434	YB14L-A2	0681434	ESB14L-A2■	—	—	—
1000	GS N (C/ N)	1979/1979	065123	YTX14AHL-BS■	—	—	—	—	—
1000	GS N (C/ N)	1979/1979	0651434	YB14L-A2	0681434	ESB14L-A2■	—	—	—
1000	GSX R (K1/ K2)	2001/2002	0651090	YTX12-BS■	0681090	ESTX12-BS■	063109	FTX12-BS■	—
1000	GSX R (K3/ K4)	2003/2004	0651090	YTX12-BS■	0681090	ESTX12-BS■	063109	FTX12-BS■	—
1000	GSX R (K5/ K6)	2005/2006	0651110	YT12A-BS■	0681110	EST12A-BS■	—	—	—
1000	GSX R (K7/ K8)	2007/2008	0651110	YT12A-BS■	0681110	EST12A-BS■	—	—	—
1000	GSX R (K9/ L0)	2009/2010	0651110	YT12A-BS■	0681110	EST12A-BS■	—	—	—
1000	GSX R (L1)	2011/2011	0651110	YT12A-BS■	0681110	EST12A-BS■	—	—	—
1000	GSX R (L2/ L3/ L4/ L5)	2012/2016	0651110	YT12A-BS■	0681110	EST12A-BS■	—	—	—
1000	GSX R (L7)	2017/2017	0651110	YT12A-BS■	0681110	EST12A-BS■	—	—	—
1000	GSX S / ABS	2015/2016	0651110	YT12A-BS■	0681110	EST12A-BS■	—	—	—
1000	GSX SF / ABS	2015/2016	0651110	YT12A-BS■	0681110	EST12A-BS■	—	—	—
1000	SV	2003/2007	065124	YTX14H-BS■	—	—	—	—	—
1000	SV	2003/2007	065129	YTX14-BS■	068129	ESTX14-BS■	—	—	—
1000	SV S	2003/2007	065124	YTX14H-BS■	—	—	—	—	—
1000	SV S	2003/2007	065129	YTX14-BS■	068129	ESTX14-BS■	—	—	—
1000	TL R	1998/2003	0651110	YT12A-BS■	0681110	EST12A-BS■	—	—	—
1000	TL S	1997/2001	0651090	YTX12-BS■	0681090	ESTX12-BS■	063109	FTX12-BS■	—
1100	GS E (T/ X/ Z/ D)	1980/1983	0651436	SYB14L-A2	—	—	—	—	—
1100	GS G (Z/ D)	1982/1984	065123	YTX14AHL-BS■	—	—	—	—	—
1100	GS G (Z/ D)	1982/1984	0651434	YB14L-A2	0681434	ESB14L-A2■	—	—	—
1100	GSX E (D/ E/ F/ G)	1983/1986	0651436	SYB14L-A2	—	—	—	—	—
1100	GSX E (T/ X/ Z)	1980/1982	0651436	SYB14L-A2	—	—	—	—	—
1100	GSX EF (E/ F/ G)	1984/1987	0651436	SYB14L-A2	—	—	—	—	—
1100	GSX ES (D/ E/ F/ G)	1983/1986	0651436	SYB14L-A2	—	—	—	—	—
1100	GSX F	1988/1993	065123	YTX14AHL-BS■	—	—	—	—	—
1100	GSX F	1988/1993	0651434	YB14L-A2	0681434	ESB14L-A2■	—	—	—
1100	GSX F	1994/1996	0651439	YB14L-B2	0681439	ESB14L-B2■	—	—	—
1100	GSX R	1986/1992	065123	YTX14AHL-BS■	—	—	—	—	—
1100	GSX R	1986/1992	0651434	YB14L-A2	0681434	ESB14L-A2■	—	—	—
1100	GSX R	1993/1996	0651090	YTX12-BS■	0681090	ESTX12-BS■	063109	FTX12-BS■	—

▲ - Factory Sealed / Attivata dalla Fabbrica ■ - con Acido a corredo ◇ - Non di produzione YUASA a completamento gamma

SUZUKI

1200	GSF Bandit (K1/ K2/ K3/ K4/ K5)	2001/2005	0651090	YTX12-BS■	0681090	ESTX12-BS■	063109	FTX12-BS■
1200	GSF Bandit (K6)	2006/2006	0651110	YT12A-BS■	0681110	EST12A-BS■	—	—
1200	GSF Bandit (T/ V/ W/ X/ Y)	1996/2000	0651090	YTX12-BS■	0681090	ESTX12-BS■	063109	FTX12-BS■
1200	GSF Bandit ABS	2006/2006	0651110	YT12A-BS■	0681110	EST12A-BS■	—	—
1200	GSF Bandit S	1996/2005	0651090	YTX12-BS■	0681090	ESTX12-BS■	063109	FTX12-BS■
1200	GSF Bandit S	2006/2006	0651110	YT12A-BS■	0681110	EST12A-BS■	—	—
1200	GSF Bandit S ABS	2006/2006	0651110	YT12A-BS■	0681110	EST12A-BS■	—	—
1200	GSX Inazuma	1999/2001	0651090	YTX12-BS■	0681090	ESTX12-BS■	063109	FTX12-BS■
1200	GV GL Madura	1985/1986	065123	YTX14AHL-BS■	—	—	—	—
1200	GV GL Madura	1985/1986	0651434	YB14L-A2	0681434	ESB14L-A2■	—	—
1250	GSF N Bandit	2007/2012	0651110	YT12A-BS■	0681110	EST12A-BS■	—	—
1250	GSF S Bandit Abs	2007/2012	0651110	YT12A-BS■	0681110	EST12A-BS■	—	—
1250	GSX FA ABS (CH135/ L0/ L1/ L2)	2010/2012	0651110	YT12A-BS■	0681110	EST12A-BS■	—	—
1250	GSX FA ABS (CH135/ L6)	2016/2016	0651110	YT12A-BS■	0681110	EST12A-BS■	—	—
1250	GSX SA Bandit ABS (CH113/ L6)	2016/2016	0651110	YT12A-BS■	0681110	EST12A-BS■	—	—
1300	GSX R Hayabusa	1999/2007	0651110	YT12A-BS■	0681110	EST12A-BS■	—	—
1340	GSX B King	2008/2012	0651090	YTX12-BS■	0681090	ESTX12-BS■	063109	FTX12-BS■
1340	GSX R Hayabusa	2008/2013	0651090	YTX12-BS■	0681090	ESTX12-BS■	063109	FTX12-BS■
1400	GSX	2002/2006	065124	YTX14H-BS■	—	—	—	—
1400	GSX	2002/2006	065129	YTX14-BS■	068129	ESTX14-BS■	—	—
1400	GV GD Cavalcade LX	1986/1988	065215	YTX24HL-BS■	—	—	—	—
1400	GV GD Cavalcade LX	1987/1988	0652035	SY50-N18L-AT	—	—	—	—
1400	GV GD Cavalcade LX	1988/2000	065169	YTX16-BS-1■	068169	ESTX16-BS-1■	—	—
1400	VS - VS GL Intruder	1987/2002	065169	YTX16-BS-1■	068169	ESTX16-BS-1■	—	—
1500	VL Intruder	1998/2004	065169	YTX16-BS-1■	068169	ESTX16-BS-1■	—	—
1500	VL Intruder	2005/2008	065187	YTX20CH-BS■	068187	ESTX20CH-BS■	—	—
1600	VZ Marauder	2004/2005	065187	YTX20CH-BS■	068187	ESTX20CH-BS■	—	—
1800	VLR C R Intruder	2008/2010	065187	YTX20CH-BS■	068187	ESTX20CH-BS■	—	—
1800	VZR M R Intruder	2006/2008	065187	YTX20CH-BS■	068187	ESTX20CH-BS■	—	—

SYM

50	Cinderella	1999/2002	0650700	YTX7A-BS■	068070	ESTX7A-BS■	—	—
50	DD 2T	2002/2002	0650390	YTX4L-BS■	068039	ESTX4L-BS■	—	—
50	DD E2 2T	2003/2013	0650390	YTX4L-BS■	068039	ESTX4L-BS■	—	—
50	Fiddle	1999/2005	0650390	YTX4L-BS■	068039	ESTX4L-BS■	—	—
50	Fiddle II 4T	2008/2009	0650700	YTX7A-BS■	068070	ESTX7A-BS■	—	—
50	Fiddle II S 4T	2009/2013	0650700	YTX7A-BS■	068070	ESTX7A-BS■	—	—
50	Jet	1999/2002	0650390	YTX4L-BS■	068039	ESTX4L-BS■	—	—
50	Jet Euro X E2 2T	2003/2012	0650700	YTX7A-BS■	068070	ESTX7A-BS■	—	—
50	Jet Sport X 2T	2006/2013	0650700	YTX7A-BS■	068070	ESTX7A-BS■	—	—
50	Jet Sport X SR 2T	2006/2013	0650700	YTX7A-BS■	068070	ESTX7A-BS■	—	—
50	Jet4 4T	2009/2013	0650700	YTX7A-BS■	068070	ESTX7A-BS■	—	—

Marca / Cilindrata / Modello / Anno			Cod. SGR		Cod. SGR		Cod. SGR	
SYM								
50	Jet4 R 2T	2011/2013	0650700	YTX7A-BS■	068070	ESTX7A-BS■	—	—
50	Jungle	1999/2000	0650390	YTX4L-BS■	068039	ESTX4L-BS■	—	—
50	Mask/ MaskE2	2000/2005	0650390	YTX4L-BS■	068039	ESTX4L-BS■	—	—
50	Mio / Mio E2 / Mio E3	2006/2013	0650700	YTX7A-BS■	068070	ESTX7A-BS■	—	—
50	Red Devil	1999/>	0650390	YTX4L-BS■	068039	ESTX4L-BS■	—	—
50	Super Fancy	1998/2000	0650390	YTX4L-BS■	068039	ESTX4L-BS■	—	—
50	Symphony 4T	2009/2010	0650700	YTX7A-BS■	068070	ESTX7A-BS■	—	—
50	Symphony S 4T	2010/2013	0650700	YTX7A-BS■	068070	ESTX7A-BS■	—	—
50	Symphony SR 4T	2010/2013	0650700	YTX7A-BS■	068070	ESTX7A-BS■	—	—
50	Symply 4T	2007/2008	0650700	YTX7A-BS■	068070	ESTX7A-BS■	—	—
50	Symply II 4T	2009/2014	0650700	YTX7A-BS■	068070	ESTX7A-BS■	—	—
50	X Pro 4T	2013/2015	0650700	YTX7A-BS■	068070	ESTX7A-BS■	—	—
100	Cinderella	1999/2001	0650700	YTX7A-BS■	068070	ESTX7A-BS■	—	—
100	Jet	1999/2000	065049	YTX5L-BS■	068049	ESTX5L-BS■	063049	FTX5L-BS■
100	Mio/ MioE2	2005/2013	0650700	YTX7A-BS■	068070	ESTX7A-BS■	—	—
125	Attila	1999/2000	0650700	YTX7A-BS■	068070	ESTX7A-BS■	—	—
125	Euro MX / Euro MX E2	2002/2004	0650990	YTX9-BS■	068099	ESTX9-BS■	063099	FTX9-BS■
125	Fiddle II	2008/2010	0650700	YTX7A-BS■	068070	ESTX7A-BS■	—	—
125	HD E3 (LH12W8-6)	2007/2012	0650990	YTX9-BS■	068099	ESTX9-BS■	063099	FTX9-BS■
125	HD EVO (LH12W5-6)	2005/2006	0650990	YTX9-BS■	068099	ESTX9-BS■	063099	FTX9-BS■
125	HD EVO E3 (LH12WB-6)	2007/2013	0650990	YTX9-BS■	068099	ESTX9-BS■	063099	FTX9-BS■
125	HD EVO E3 TAMBURO (LH12WA-6)	2008/2009	0650990	YTX9-BS■	068099	ESTX9-BS■	063099	FTX9-BS■
125	HD2 (LC12W1-6)	2011/2013	0650990	YTX9-BS■	068099	ESTX9-BS■	063099	FTX9-BS■
125	Husky	1989/1989	0650690	YTX7L-BS■	068069	ESTX7L-BS■	063069	FTX7L-BS■
125	Jet 4 4T	2009/2013	0650700	YTX7A-BS■	068070	ESTX7A-BS■	—	—
125	Jet 5 4T	2011/2013	065010	YTZ10S▲	—	—	063010	FTZ10S▲
125	Jet 5 4T	2011/2013	065910	TTZ10S-BS	068910	ESTTZ10S-BS■	—	—
125	Joyride	2001/2002	0650990	YTX9-BS■	068099	ESTX9-BS■	063099	FTX9-BS■
125	Joyride E2	2003/2006	0650990	YTX9-BS■	068099	ESTX9-BS■	063099	FTX9-BS■
125	Joyride E3	2007/2012	0650990	YTX9-BS■	068099	ESTX9-BS■	063099	FTX9-BS■
125	Joyride EVO E3	2009/2013	0650990	YTX9-BS■	068099	ESTX9-BS■	063099	FTX9-BS■
125	Megalo	2006/2008	0650700	YTX7A-BS■	068070	ESTX7A-BS■	—	—
125	Newduke	2000/2002	0650700	YTX7A-BS■	068070	ESTX7A-BS■	—	—
125	Shark	1999/>	0650990	YTX9-BS■	068099	ESTX9-BS■	063099	FTX9-BS■
125	Superduke	2000/2001	0650700	YTX7A-BS■	068070	ESTX7A-BS■	—	—
125	Symphony 4T	2009/2010	0650700	YTX7A-BS■	068070	ESTX7A-BS■	—	—
125	Symphony S 4T	2010/2013	0650700	YTX7A-BS■	068070	ESTX7A-BS■	—	—
125	Symphony SR 4T	2010/2013	0650700	YTX7A-BS■	068070	ESTX7A-BS■	—	—
125	Symply / Symply II	2007/2012	0650700	YTX7A-BS■	068070	ESTX7A-BS■	—	—
125	VS/ VS E3	2006/2008	065010	YTZ10S▲	—	—	063010	FTZ10S▲
125	VS/ VS E3	2006/2008	065910	TTZ10S-BS	068910	ESTTZ10S-BS■	—	—

▲ - Factory Sealed / Attivata dalla Fabbrica ■ - con Acido a corredo ◇ - Non di produzione YUASA a completamento gamma

Marca / Cilindrata / Modello / Anno			Cod. SGR		Cod. SGR		Cod. SGR		
SYM									
125	X Pro	2013/2013	0650700	YTX7A-BS ■	068070	ESTX7A-BS ■	—	—	
150	Attila	2000/2001	0650700	YTX7A-BS ■	068070	ESTX7A-BS ■	—	—	
150	Euro MX / Euro MX E2	2002/2004	0650990	YTX9-BS ■	068099	ESTX9-BS ■	063099	FTX9-BS ■	
150	Fiddle II	2010/2012	0650700	YTX7A-BS ■	068070	ESTX7A-BS ■	—	—	
150	Joyride	2001/2002	0650990	YTX9-BS ■	068099	ESTX9-BS ■	063099	FTX9-BS ■	
150	Shark	2000/>	0650990	YTX9-BS ■	068099	ESTX9-BS ■	063099	FTX9-BS ■	
150	Superduke	1999/2002	0650990	YTX9-BS ■	068099	ESTX9-BS ■	063099	FTX9-BS ■	
150	Symphony 4T	2009/2009	0650700	YTX7A-BS ■	068070	ESTX7A-BS ■	—	—	
150	Symphony S 4T	2009/2012	0650700	YTX7A-BS ■	068070	ESTX7A-BS ■	—	—	
150	Symphony SR 4T	2009/2012	0650700	YTX7A-BS ■	068070	ESTX7A-BS ■	—	—	
150	VS/ VS E3	2006/2008	065910	TTZ10S-BS	068910	ESTT10S-BS ■	—	—	
180	Track Runner	2006/2007	0650990	YTX9-BS ■	068099	ESTX9-BS ■	063099	FTX9-BS ■	
200	HD E2	2003/2004	0650990	YTX9-BS ■	068099	ESTX9-BS ■	063099	FTX9-BS ■	
200	HD E2 EVO	2005/2006	0650990	YTX9-BS ■	068099	ESTX9-BS ■	063099	FTX9-BS ■	
200	HD E3 IE	2007/2008	0650990	YTX9-BS ■	068099	ESTX9-BS ■	063099	FTX9-BS ■	
200	HD E3 IE EVO (LH18W7-6)	2007/2013	0650990	YTX9-BS ■	068099	ESTX9-BS ■	063099	FTX9-BS ■	
200	HD E3 IE EVO TAMBURO (LH182WA-6)	2008/2009	0650990	YTX9-BS ■	068099	ESTX9-BS ■	063099	FTX9-BS ■	
200	HD2 IE (LC18W1-6)	2011/2012	0650990	YTX9-BS ■	068099	ESTX9-BS ■	063099	FTX9-BS ■	
200	Joyride	2002/2003	0650990	YTX9-BS ■	068099	ESTX9-BS ■	063099	FTX9-BS ■	
200	Joyride E2	2003/2006	0650990	YTX9-BS ■	068099	ESTX9-BS ■	063099	FTX9-BS ■	
200	Joyride E3 IE	2007/2009	0650990	YTX9-BS ■	068099	ESTX9-BS ■	063099	FTX9-BS ■	
200	Joyride EVO IE	2009/2012	0650990	YTX9-BS ■	068099	ESTX9-BS ■	063099	FTX9-BS ■	
250	Joy Max GTS	2006/2007	0651090	YTX12-BS ■	0681090	ESTX12-BS ■	063109	FTX12-BS ■	
250	Joy Max GTS E3 IE	2007/2008	0651090	YTX12-BS ■	0681090	ESTX12-BS ■	063109	FTX12-BS ■	
250	Quad Lander	2006/2007	0651090	YTX12-BS ■	0681090	ESTX12-BS ■	063109	FTX12-BS ■	
300	Citycom / EFI	2007/2012	0651090	YTX12-BS ■	0681090	ESTX12-BS ■	063109	FTX12-BS ■	
300	Joy Max EVO	2009/2012	0651090	YTX12-BS ■	0681090	ESTX12-BS ■	063109	FTX12-BS ■	
300	Quad Lander S	2007/2011	0651090	YTX12-BS ■	0681090	ESTX12-BS ■	063109	FTX12-BS ■	
400	Maxsym I	2011/2012	065014	YTZ14S ▲	—	—	—	—	
400	Maxsym I	2011/2012	065914	TTZ14S-BS	068914	ESTT14S-BS ■	—	—	
TGB									
50	101R 2T	2004/2009	0650390	YTX4L-BS ■	068039	ESTX4L-BS ■	—	—	
50	101S 2T	TUTTI	0650390	YTX4L-BS ■	068039	ESTX4L-BS ■	—	—	
50	303 Laser	2004/2009	0650390	YTX4L-BS ■	068039	ESTX4L-BS ■	—	—	
50	303R5I Laser	2004/2009	0650390	YTX4L-BS ■	068039	ESTX4L-BS ■	—	—	
50	303RS Laser	2004/2009	0650390	YTX4L-BS ■	068039	ESTX4L-BS ■	—	—	
50	Akros	1979/1981	0650390	YTX4L-BS ■	068039	ESTX4L-BS ■	—	—	
50	Delivery 2T	2004/2009	0650390	YTX4L-BS ■	068039	ESTX4L-BS ■	—	—	
50	Ergon	1989/1989	0650390	YTX4L-BS ■	068039	ESTX4L-BS ■	—	—	
50	Hawk	TUTTI	0650390	YTX4L-BS ■	068039	ESTX4L-BS ■	—	—	
50	Laser R5 2T	TUTTI	0650390	YTX4L-BS ■	068039	ESTX4L-BS ■	—	—	

▲ - Factory Sealed / Attivata dalla Fabbrica ■ - con Acido a corredo ◇ - Non di produzione YUASA a completamento gamma



TGB

150 303 R	2004/2009	0650734	12N7-3B	0680734	ES12N7-3B■	—	—
150 Delivery	2004/2009	0650734	12N7-3B	0680734	ES12N7-3B■	—	—
250 Blade	TUTTI	065124	YTX14H-BS■	—	—	—	—
250 Blade	TUTTI	065129	YTX14-BS■	068129	ESTX14-BS■	—	—
250 X Motion LC 4T	TUTTI	065124	YTX14H-BS■	—	—	—	—
250 X Motion LC 4T	TUTTI	065129	YTX14-BS■	068129	ESTX14-BS■	—	—
325 Blade LE	TUTTI	065124	YTX14H-BS■	—	—	—	—
325 Blade LE	TUTTI	065129	YTX14-BS■	068129	ESTX14-BS■	—	—
400 Avenger LE	TUTTI	0650202	GYZ20HL▲	—	—	—	—
400 Avenger LE	TUTTI	065185	YTX20HL-BS■	—	—	—	—
400 Avenger LE	TUTTI	065209	YTX20L-BS■	068209	ESTX20L-BS■	—	—
425 Avenger	TUTTI	0650202	GYZ20HL▲	—	—	—	—
425 Avenger	TUTTI	065185	YTX20HL-BS■	—	—	—	—
425 Avenger	TUTTI	065209	YTX20L-BS■	068209	ESTX20L-BS■	—	—
425 Blade FLE/ S/ SE/ SL	TUTTI	0650202	GYZ20HL▲	—	—	—	—
425 Blade FLE/ S/ SE/ SL	TUTTI	065185	YTX20HL-BS■	—	—	—	—
425 Blade FLE/ S/ SE/ SL	TUTTI	065209	YTX20L-BS■	068209	ESTX20L-BS■	—	—
500 Avenger	TUTTI	0650202	GYZ20HL▲	—	—	—	—
500 Avenger	TUTTI	065185	YTX20HL-BS■	—	—	—	—
500 Avenger	TUTTI	065209	YTX20L-BS■	068209	ESTX20L-BS■	—	—
500 Targhet	TUTTI	0650202	GYZ20HL▲	—	—	—	—
500 Targhet	TUTTI	065185	YTX20HL-BS■	—	—	—	—
500 Targhet	TUTTI	065209	YTX20L-BS■	068209	ESTX20L-BS■	—	—
525 Blade	TUTTI	0650202	GYZ20HL▲	—	—	—	—
525 Blade	TUTTI	065185	YTX20HL-BS■	—	—	—	—
525 Blade	TUTTI	065209	YTX20L-BS■	068209	ESTX20L-BS■	—	—
525 Targhet	TUTTI	0650202	GYZ20HL▲	—	—	—	—
525 Targhet	TUTTI	065185	YTX20HL-BS■	—	—	—	—
525 Targhet	TUTTI	065209	YTX20L-BS■	068209	ESTX20L-BS■	—	—



TM

250 EN F Enduro 4T	2003/2010	0650690	YTX7L-BS■	068069	ESTX7L-BS■	063069	FTX7L-BS■
400 EN F Enduro 4T	2003/2003	0650690	YTX7L-BS■	068069	ESTX7L-BS■	063069	FTX7L-BS■
450 EN F Enduro 4T	2003/2009	0650690	YTX7L-BS■	068069	ESTX7L-BS■	063069	FTX7L-BS■
450 SMR F 4T	2005/2008	0650690	YTX7L-BS■	068069	ESTX7L-BS■	063069	FTX7L-BS■
530 EN F Enduro 4T	2003/2010	0650690	YTX7L-BS■	068069	ESTX7L-BS■	063069	FTX7L-BS■
530 SMM F 4T	2005/2009	0650690	YTX7L-BS■	068069	ESTX7L-BS■	063069	FTX7L-BS■
530 SMR F 4T	2003/2009	0650690	YTX7L-BS■	068069	ESTX7L-BS■	063069	FTX7L-BS■



TRIUMPH

600 Daytona (T806LW)	2003/2004	0650990	YTX9-BS■	068099	ESTX9-BS■	063099	FTX9-BS■
600 Speed Four (T801/ 811-T806LB)	2003/2005	0651090	YTX12-BS■	0681090	ESTX12-BS■	063109	FTX12-BS■
600 TT (T800)	2000/2004	0651090	YTX12-BS■	0681090	ESTX12-BS■	063109	FTX12-BS■



▲ - Factory Sealed / Attivata dalla Fabbrica ■ - con Acido a corredo ◇ - Non di produzione YUASA a completamento gamma

Marca / Cilindrata / Modello / Anno			Cod. SGR		Cod. SGR		Cod. SGR		
TRIUMPH									
650	Daytona (T385-T806LX)	2005/2005	0650990	YTX9-BS■	068099	ESTX9-BS■	063099	FTX9-BS■	
650	T120R Bonneville	1969/1979	0650737	YB7L-B	0680737	ESB7L-B■	—	—	
675	Daytona (TD10)	2006/2010	0650710	YT7B-BS■	068071	EST7B-BS■	—	—	
675	Daytona (TD10)	2011/2015	0650990	YTX9-BS■	068099	ESTX9-BS■	063099	FTX9-BS■	
675	Daytona R	2011/2015	0650990	YTX9-BS■	068099	ESTX9-BS■	063099	FTX9-BS■	
675	Street Triple	2007/2015	0650990	YTX9-BS■	068099	ESTX9-BS■	063099	FTX9-BS■	
675	Street Triple R	2008/2015	0650990	YTX9-BS■	068099	ESTX9-BS■	063099	FTX9-BS■	
750	Daytona	1991/1995	065123	YTX14AHL-BS■	—	—	—	—	
750	Daytona	1991/1995	0651434	YB14L-A2	0681434	ESB14L-A2■	—	—	
750	Trident	1991/1998	065123	YTX14AHL-BS■	—	—	—	—	
750	Trident	1991/1998	0651434	YB14L-A2	0681434	ESB14L-A2■	—	—	
790	America	2003/2006	0651090	YTX12-BS■	0681090	ESTX12-BS■	063109	FTX12-BS■	
790	Bonneville (908MD)	2001/2006	0651090	YTX12-BS■	0681090	ESTX12-BS■	063109	FTX12-BS■	
790	Bonneville America (908M)	2002/2002	0651090	YTX12-BS■	0681090	ESTX12-BS■	063109	FTX12-BS■	
790	Bonneville T100	2001/2004	0651090	YTX12-BS■	0681090	ESTX12-BS■	063109	FTX12-BS■	
790	Speedmaster (908ML)	2003/2004	0651090	YTX12-BS■	0681090	ESTX12-BS■	063109	FTX12-BS■	
800	Tiger	2011/2014	065168	YTX16-BS■	068168	ESTX16-BS■	—	—	
800	Tiger ABS	2011/2014	065168	YTX16-BS■	068168	ESTX16-BS■	—	—	
800	Tiger XC	2011/2014	065168	YTX16-BS■	068168	ESTX16-BS■	—	—	
800	Tiger XC ABS	2012/2014	065168	YTX16-BS■	068168	ESTX16-BS■	—	—	
800	Tiger XC/ XCX/ XCA	2015/2016	065168	YTX16-BS■	068168	ESTX16-BS■	—	—	
800	Tiger XR/ XRX	2015/2016	065168	YTX16-BS■	068168	ESTX16-BS■	—	—	
865	America	2007/2010	0651090	YTX12-BS■	0681090	ESTX12-BS■	063109	FTX12-BS■	
865	America	2011/2015	0651090	YTX12-BS■	0681090	ESTX12-BS■	063109	FTX12-BS■	
865	Bonneville	2007/2015	0651090	YTX12-BS■	0681090	ESTX12-BS■	063109	FTX12-BS■	
865	Bonneville SE ()	2009/2015	0651090	YTX12-BS■	0681090	ESTX12-BS■	063109	FTX12-BS■	
865	Bonneville T100	2005/2015	0651090	YTX12-BS■	0681090	ESTX12-BS■	063109	FTX12-BS■	
865	Scrambler	2006/2013	0651090	YTX12-BS■	0681090	ESTX12-BS■	063109	FTX12-BS■	
865	Speedmaster	2005/2013	0651090	YTX12-BS■	0681090	ESTX12-BS■	063109	FTX12-BS■	
865	Thrupton (T914)	2004/2013	0651090	YTX12-BS■	0681090	ESTX12-BS■	063109	FTX12-BS■	
885	Speed Triple (T509)	1997/1999	065123	YTX14AHL-BS■	—	—	—	—	
885	Speed Triple (T509)	1997/1999	0651434	YB14L-A2	0681434	ESB14L-A2■	—	—	
885	Speed Triple Carb. (T301)	1994/1996	065123	YTX14AHL-BS■	—	—	—	—	
885	Speed Triple Carb. (T301)	1994/1996	0651434	YB14L-A2	0681434	ESB14L-A2■	—	—	
885	Thunderbird	2013/2014	065123	YTX14AHL-BS■	—	—	—	—	
885	Thunderbird	2013/2014	0651434	YB14L-A2	0681434	ESB14L-A2■	—	—	
900	Adventurer (T309RC)	1996/2001	065123	YTX14AHL-BS■	—	—	—	—	
900	Adventurer (T309RC)	1996/2001	0651434	YB14L-A2	0681434	ESB14L-A2■	—	—	
900	Daytona (T309)	1991/1997	065123	YTX14AHL-BS■	—	—	—	—	
900	Daytona (T309)	1991/1997	0651434	YB14L-A2	0681434	ESB14L-A2■	—	—	
900	Daytona Super 3 (T311/ 312/ 313)	1993/1994	065123	YTX14AHL-BS■	—	—	—	—	

▲ - Factory Sealed / Attivata dalla Fabbrica ■ - con Acido a corredo ◇ - Non di produzione YUASA a completamento gamma

Marca / Cilindrata / Modello / Anno			Cod. SGR		Cod. SGR		Cod. SGR	
TRIUMPH								
900	Daytona Super 3 (T311/ 312/ 313)	1993/1994	0651434	YB14L-A2	0681434	ESB14L-A2 ■	—	—
900	Legend TT (T309RT)	1999/2001	065123	YTX14AHL-BS ■	—	—	—	—
900	Legend TT (T309RT)	1999/2001	0651434	YB14L-A2	0681434	ESB14L-A2 ■	—	—
900	Sprint Carb. (T388)	1993/1998	065123	YTX14AHL-BS ■	—	—	—	—
900	Sprint Carb. (T388)	1993/1998	0651434	YB14L-A2	0681434	ESB14L-A2 ■	—	—
900	Sprint Sport Carb. (T388)	1996/1998	065123	YTX14AHL-BS ■	—	—	—	—
900	Sprint Sport Carb. (T388)	1996/1998	0651434	YB14L-A2	0681434	ESB14L-A2 ■	—	—
900	Thunderbird (T309RD)	1994/2003	065123	YTX14AHL-BS ■	—	—	—	—
900	Thunderbird (T309RD)	1994/2003	0651434	YB14L-A2	0681434	ESB14L-A2 ■	—	—
900	Thunderbird (T309RT)	1995/2004	065123	YTX14AHL-BS ■	—	—	—	—
900	Thunderbird (T309RT)	1995/2004	0651434	YB14L-A2	0681434	ESB14L-A2 ■	—	—
900	Thunderbird Sport (T309RD)	1995/2004	065123	YTX14AHL-BS ■	—	—	—	—
900	Thunderbird Sport (T309RD)	1995/2004	0651434	YB14L-A2	0681434	ESB14L-A2 ■	—	—
900	Tiger (T409EN)	1993/1998	065123	YTX14AHL-BS ■	—	—	—	—
900	Tiger (T409EN)	1993/1998	0651434	YB14L-A2	0681434	ESB14L-A2 ■	—	—
900	Tiger (T409EN)	1999/2000	065124	YTX14H-BS ■	—	—	—	—
900	Tiger (T409EN)	1999/2000	065129	YTX14-BS ■	068129	ESTX14-BS ■	—	—
900	Trident (T309R)	1991/1998	065123	YTX14AHL-BS ■	—	—	—	—
900	Trident (T309R)	1991/1998	0651434	YB14L-A2	0681434	ESB14L-A2 ■	—	—
900	Trophy (T309ST)	1991/1997	065123	YTX14AHL-BS ■	—	—	—	—
900	Trophy (T309ST)	1991/1997	0651434	YB14L-A2	0681434	ESB14L-A2 ■	—	—
900	Trophy (T309ST)	1998/2001	065124	YTX14H-BS ■	—	—	—	—
900	Trophy (T309ST)	1998/2001	065129	YTX14-BS ■	068129	ESTX14-BS ■	—	—
955	Daytona (T502/ T595)	1996/1998	065123	YTX14AHL-BS ■	—	—	—	—
955	Daytona (T502/ T595)	1996/1998	0651434	YB14L-A2	0681434	ESB14L-A2 ■	—	—
955	Daytona IE (T502/ T595) (Bibraccio)	2001/2006	065124	YTX14H-BS ■	—	—	—	—
955	Daytona IE (T502/ T595) (Bibraccio)	2001/2006	065129	YTX14-BS ■	068129	ESTX14-BS ■	—	—
955	Daytona IE (T502/ T595) (Monobraccio)	1999/2000	065123	YTX14AHL-BS ■	—	—	—	—
955	Daytona IE (T502/ T595) (Monobraccio)	1999/2000	0651434	YB14L-A2	0681434	ESB14L-A2 ■	—	—
955	Daytona IE Centennial (T502/ T595) (Monobraccio)	2002/2002	065124	YTX14H-BS ■	—	—	—	—
955	Daytona IE Centennial (T502/ T595) (Monobraccio)	2002/2002	065129	YTX14-BS ■	068129	ESTX14-BS ■	—	—
955	Speed Triple (T508/ T551/ T566)	1999/2004	065124	YTX14H-BS ■	—	—	—	—
955	Speed Triple (T508/ T551/ T566)	1999/2004	065129	YTX14-BS ■	068129	ESTX14-BS ■	—	—
955	Sprint RS IE (T625)	1999/2005	065124	YTX14H-BS ■	—	—	—	—
955	Sprint RS IE (T625)	1999/2005	065129	YTX14-BS ■	068129	ESTX14-BS ■	—	—
955	Sprint ST	1999/2004	065124	YTX14H-BS ■	—	—	—	—
955	Sprint ST	1999/2004	065129	YTX14-BS ■	068129	ESTX14-BS ■	—	—
955	Tiger (T720)	2001/2006	065123	YTX14AHL-BS ■	—	—	—	—
955	Tiger (T720)	2001/2006	0651434	YB14L-A2	0681434	ESB14L-A2 ■	—	—
1000	Daytona	1991/1995	065123	YTX14AHL-BS ■	—	—	—	—
1000	Daytona	1991/1995	0651434	YB14L-A2	0681434	ESB14L-A2 ■	—	—

▲ - Factory Sealed / Attivata dalla Fabbrica ■ - con Acido a corredo ◇ - Non di produzione YUASA a completamento gamma

Marca / Cilindrata / Modello / Anno			Cod. SGR		Cod. SGR		Cod. SGR	
TRIUMPH								
1000	Daytona MK-1	1993/1993	065123	YTX14AHL-BS■	—	—	—	—
1000	Daytona MK-1	1993/1993	0651434	YB14L-A2	0681434	ESB14L-A2■	—	—
1000	Daytona MK-2	1993/1993	065123	YTX14AHL-BS■	—	—	—	—
1000	Daytona MK-2	1993/1993	0651434	YB14L-A2	0681434	ESB14L-A2■	—	—
1050	Speed Triple	2005/2015	0651090	YTX12-BS■	0681090	ESTX12-BS■	063109	FTX12-BS■
1050	Speed Triple ABS	2011/2016	0651090	YTX12-BS■	0681090	ESTX12-BS■	063109	FTX12-BS■
1050	Speed Triple R	2011/2015	0651090	YTX12-BS■	0681090	ESTX12-BS■	063109	FTX12-BS■
1050	Speed Triple R ABS	2011/2016	0651090	YTX12-BS■	0681090	ESTX12-BS■	063109	FTX12-BS■
1050	Sprint GT	2011/2013	0651090	YTX12-BS■	0681090	ESTX12-BS■	063109	FTX12-BS■
1050	Sprint ST	2005/2010	0651090	YTX12-BS■	0681090	ESTX12-BS■	063109	FTX12-BS■
1050	Tiger	2007/2014	0651090	YTX12-BS■	0681090	ESTX12-BS■	063109	FTX12-BS■
1050	Tiger SE ABS	2007/2014	0651090	YTX12-BS■	0681090	ESTX12-BS■	063109	FTX12-BS■
1050	Tiger Sport	2013/2015	065123	YTX14AHL-BS■	—	—	—	—
1050	Tiger Sport	2013/2015	0651434	YB14L-A2	0681434	ESB14L-A2■	—	—
1200	Daytona	1993/1994	065123	YTX14AHL-BS■	—	—	—	—
1200	Daytona	1993/1994	0651434	YB14L-A2	0681434	ESB14L-A2■	—	—
1200	Trophy	1991/1998	065123	YTX14AHL-BS■	—	—	—	—
1200	Trophy	1991/1998	0651434	YB14L-A2	0681434	ESB14L-A2■	—	—
1200	Trophy	1999/2003	065124	YTX14H-BS■	—	—	—	—
1200	Trophy	1999/2003	065129	YTX14-BS■	068129	ESTX14-BS■	—	—
1215	Tiger Explorer	2012/2015	0650202	GYZ20HL▲	—	—	—	—
1215	Tiger Explorer	2012/2015	065185	YTX20HL-BS■	—	—	—	—
1215	Tiger Explorer	2012/2015	065209	YTX20L-BS■	068209	ESTX20L-BS■	—	—
1215	Tiger Explorer XC	2012/2015	0650202	GYZ20HL▲	—	—	—	—
1215	Tiger Explorer XC	2012/2015	065185	YTX20HL-BS■	—	—	—	—
1215	Tiger Explorer XC	2012/2015	065209	YTX20L-BS■	068209	ESTX20L-BS■	—	—
1215	Trophy / SE	2012/2013	0650202	GYZ20HL▲	—	—	—	—
1215	Trophy / SE	2012/2013	065185	YTX20HL-BS■	—	—	—	—
1215	Trophy / SE	2012/2013	065209	YTX20L-BS■	068209	ESTX20L-BS■	—	—
1600	Thunderbird / SE	2009/2013	0650202	GYZ20HL▲	—	—	—	—
1600	Thunderbird / SE	2009/2013	065185	YTX20HL-BS■	—	—	—	—
1600	Thunderbird / SE	2009/2013	065209	YTX20L-BS■	068209	ESTX20L-BS■	—	—
1700	Thunderbird Big Bore/ Storm	2010/2013	0650202	GYZ20HL▲	—	—	—	—
1700	Thunderbird Big Bore/ Storm	2010/2013	065185	YTX20HL-BS■	—	—	—	—
1700	Thunderbird Big Bore/ Storm	2010/2013	065209	YTX20L-BS■	068209	ESTX20L-BS■	—	—
2300	Rocket 3	2005/2013	0650202	GYZ20HL▲	—	—	—	—
2300	Rocket 3	2005/2013	065185	YTX20HL-BS■	—	—	—	—
2300	Rocket 3	2005/2013	065209	YTX20L-BS■	068209	ESTX20L-BS■	—	—
VALPADANA								
Motore	agricoli	1989/1989	0652434	Y60-N24-A	—	—	—	—



▲ - Factory Sealed / Attivata dalla Fabbrica ■ - con Acido a corredo ◇ - Non di produzione YUASA a completamento gamma



YAMAHA

50	Beluga	TUTTI	06504340	YB4L-B	—	—	—	—
50	Beluga	TUTTI	065043410	YB4L-B■	0680434	ESB4L-B■	—	—
50	BW'S (5WW/ 5WWV-SA231)	2004/2015	06504340	YB4L-B	—	—	—	—
50	BW'S (5WW/ 5WWV-SA231)	2004/2015	065043410	YB4L-B■	0680434	ESB4L-B■	—	—
50	BW'S Easy (2DW1-SA236)	2013/2015	06504340	YB4L-B	—	—	—	—
50	BW'S Easy (2DW1-SA236)	2013/2015	065043410	YB4L-B■	0680434	ESB4L-B■	—	—
50	BW'S N.G. (1B01/ 2B11/ 2B13/ 2B15)	2003/2006	06504340	YB4L-B	—	—	—	—
50	BW'S N.G. (1B01/ 2B11/ 2B13/ 2B15)	2003/2006	065043410	YB4L-B■	0680434	ESB4L-B■	—	—
50	BW'S N.G. (4SB/ 5LF/ 5FX1/ 5NU)	1997/2002	06504340	YB4L-B	—	—	—	—
50	BW'S N.G. (4SB/ 5LF/ 5FX1/ 5NU)	1997/2002	065043410	YB4L-B■	0680434	ESB4L-B■	—	—
50	BW'S Naked (1D11/ 2B71-SA064/ SA231)	2003/2004	06504340	YB4L-B	—	—	—	—
50	BW'S Naked (1D11/ 2B71-SA064/ SA231)	2003/2004	065043410	YB4L-B■	0680434	ESB4L-B■	—	—
50	BW'S Naked (2B7B-SA231)	2009/2015	06504340	YB4L-B	—	—	—	—
50	BW'S Naked (2B7B-SA231)	2009/2015	065043410	YB4L-B■	0680434	ESB4L-B■	—	—
50	BW'S Original (4VU/ 4VU8/ 5LE/ 5MM/ 5NT3-3WW/ 4VV/ SA061)	1997/2001	06504340	YB4L-B	—	—	—	—
50	BW'S Original (4VU/ 4VU8/ 5LE/ 5MM/ 5NT3-3WW/ 4VV/ SA061)	1997/2001	065043410	YB4L-B■	0680434	ESB4L-B■	—	—
50	BW'S Original Euro 2 (5NT5/ 5XW/ 5XX-SA064)	2002/2003	06504340	YB4L-B	—	—	—	—
50	BW'S Original Euro 2 (5NT5/ 5XW/ 5XX-SA064)	2002/2003	065043410	YB4L-B■	0680434	ESB4L-B■	—	—
50	BW'S R (5XS1-SA061)	2001/2001	06504340	YB4L-B	—	—	—	—
50	BW'S R (5XS1-SA061)	2001/2001	065043410	YB4L-B■	0680434	ESB4L-B■	—	—
50	BW'S Bump	1997/1998	06504340	YB4L-B	—	—	—	—
50	BW'S Bump	1997/1998	065043410	YB4L-B■	0680434	ESB4L-B■	—	—
50	CR Z	1991/1995	06504340	YB4L-B	—	—	—	—
50	CR Z	1991/1995	065043410	YB4L-B■	0680434	ESB4L-B■	—	—
50	CS Jog R (5RW/ 5RW13D43/ 3D4C/ 4D4R)	2002/2013	0650390	YTX4L-BS■	068039	ESTX4L-BS■	—	—
50	CT S	1990/1995	06504340	YB4L-B	—	—	—	—
50	CT S	1990/1995	065043410	YB4L-B■	0680434	ESB4L-B■	—	—
50	CT SS	1992/1995	06504340	YB4L-B	—	—	—	—
50	CT SS	1992/1995	065043410	YB4L-B■	0680434	ESB4L-B■	—	—
50	CW BW'S L (5XY1/ 5XYA1/ 2B61)	2003/2004	06504340	YB4L-B	—	—	—	—
50	CW BW'S L (5XY1/ 5XYA1/ 2B61)	2003/2004	065043410	YB4L-B■	0680434	ESB4L-B■	—	—
50	CW BW'S Original / SP Euro 2 (5RH1/ 5RY1)	2002/2002	06504340	YB4L-B	—	—	—	—
50	CW BW'S Original / SP Euro 2 (5RH1/ 5RY1)	2002/2002	065043410	YB4L-B■	0680434	ESB4L-B■	—	—
50	CW RS Spy	1995/1998	06504340	YB4L-B	—	—	—	—
50	CW RS Spy	1995/1998	065043410	YB4L-B■	0680434	ESB4L-B■	—	—
50	DT R (13C)	2007/2013	06504340	YB4L-B	—	—	—	—
50	DT R (13C)	2007/2013	065043410	YB4L-B■	0680434	ESB4L-B■	—	—
50	DT R (1D4)	2003/2005	06504340	YB4L-B	—	—	—	—
50	DT R (1D4)	2003/2005	065043410	YB4L-B■	0680434	ESB4L-B■	—	—
50	DT R (2C2C)	2006/2006	06504340	YB4L-B	—	—	—	—
50	DT R (2C2C)	2006/2006	065043410	YB4L-B■	0680434	ESB4L-B■	—	—

▲ - Factory Sealed / Attivata dalla Fabbrica : ■ - con Acido a corredo : ◇ - Non di produzione YUASA a completamento gamma

Marca / Cilindrata / Modello / Anno			Cod. SGR		Cod. SGR		Cod. SGR		
YAMAHA									
50	DT R SM	2003/2005	06504340	YB4L-B	—	—	—	—	
50	DT R SM	2003/2005	065043410	YB4L-B■	0680434	ESB4L-B■	—	—	
50	DT X SM (2C3C/14P)	2006/2013	06504340	YB4L-B	—	—	—	—	
50	DT X SM (2C3C/14P)	2006/2013	065043410	YB4L-B■	0680434	ESB4L-B■	—	—	
50	EW Slider	2000/2002	06504340	YB4L-B	—	—	—	—	
50	EW Slider	2000/2002	065043410	YB4L-B■	0680434	ESB4L-B■	—	—	
50	NS Aerox (SA421)	2013/2016	06504340	YB4L-B	—	—	—	—	
50	NS Aerox (SA421)	2013/2016	065043410	YB4L-B■	0680434	ESB4L-B■	—	—	
50	NS Aerox Naked (SA424)	2013/2016	06504340	YB4L-B	—	—	—	—	
50	NS Aerox Naked (SA424)	2013/2016	065043410	YB4L-B■	0680434	ESB4L-B■	—	—	
50	TZR R	2003/2013	0650390	YTX4L-BS■	068039	ESTX4L-BS■	—	—	
50	XF Giggle	2008/2008	065049	YTX5L-BS■	068049	ESTX5L-BS■	063049	FTX5L-BS■	
50	YA R Axis S/ T	1995/1996	0650390	YTX4L-BS■	068039	ESTX4L-BS■	—	—	
50	YA ZA Jog Z (4SC1)	1995/1996	065030	YT4B-BS■	—	—	—	—	
50	YH Why	1998/2002	06504340	YB4L-B	—	—	—	—	
50	YH Why	1998/2002	065043410	YB4L-B■	0680434	ESB4L-B■	—	—	
50	YH Why E2	2003/2013	06504340	YB4L-B	—	—	—	—	
50	YH Why E2	2003/2013	065043410	YB4L-B■	0680434	ESB4L-B■	—	—	
50	YM Breeze	1994/1995	06504340	YB4L-B	—	—	—	—	
50	YM Breeze	1994/1995	065043410	YB4L-B■	0680434	ESB4L-B■	—	—	
50	YN F Neo's 4T	2009/2010	0650534	YB5L-B	0680534	ESB5L-B■	—	—	
50	YN F Neo's 4T	2011/2011	065123	YTX14AHL-BS■	—	—	—	—	
50	YN F Neo's 4T	2011/2011	0651433	12N14-3A	—	—	—	—	
50	YN F Neo's 4T	2012/2015	0650534	YB5L-B	0680534	ESB5L-B■	—	—	
50	YN Neo's	1997/2001	06504340	YB4L-B	—	—	—	—	
50	YN Neo's	1997/2001	065043410	YB4L-B■	0680434	ESB4L-B■	—	—	
50	YN Neo's E2	2002/2015	06504340	YB4L-B	—	—	—	—	
50	YN Neo's E2	2002/2015	065043410	YB4L-B■	0680434	ESB4L-B■	—	—	
50	YN Neo's Easy	2013/2015	06504340	YB4L-B	—	—	—	—	
50	YN Neo's Easy	2013/2015	065043410	YB4L-B■	0680434	ESB4L-B■	—	—	
50	YQ Aerox / R	1997/2002	06504340	YB4L-B	—	—	—	—	
50	YQ Aerox / R	1997/2002	065043410	YB4L-B■	0680434	ESB4L-B■	—	—	
50	YQ Aerox R E2	2003/2012	06504340	YB4L-B	—	—	—	—	
50	YQ Aerox R E2	2003/2012	065043410	YB4L-B■	0680434	ESB4L-B■	—	—	
100	BW'S	1999/2001	065049	YTX5L-BS■	068049	ESTX5L-BS■	063049	FTX5L-BS■	
100	YN Neo's	2000/2002	0650390	YTX4L-BS■	068039	ESTX4L-BS■	—	—	
100	YQ Aerox	2000/>	0650390	YTX4L-BS■	068039	ESTX4L-BS■	—	—	
115	XC D'elight (SE711)	2014/2014	0650061	YTZ6V■	—	—	—	—	
125	DT	1975/1977	0650335	YB3L-B	0680335	ESB3L-B■	—	—	
125	DT	1979/1981	0650335	YB3L-B	0680335	ESB3L-B■	—	—	
125	DT R LC (3PY)	1989/1992	0650335	YB3L-B	0680335	ESB3L-B■	—	—	



▲ - Factory Sealed / Attivata dalla Fabbrica ■ - con Acido a corredo ◇ - Non di produzione YUASA a completamento gamma





YAMAHA

125 DT R LC (3RM)	1999/2000	0650335	YB3L-B	0680335	ESB3L-B■	—	—
125 DT RE (1D0/1D04)	2005/2006	065007	YTZ7S▲	—	—	063007	FTZ7S▲
125 DT Ténéré LC	1989/1990	0650335	YB3L-B	0680335	ESB3L-B■	—	—
125 DT X Supermotard (2C81/ 2C82)	2005/2006	065007	YTZ7S▲	—	—	063007	FTZ7S▲
125 HW Xenter (SE591)	2012/2017	0650710	YT7B-BS■	068071	EST7B-BS■	—	—
125 MT / ABS (RE114/ RE115)	2014/2016	0650636	12N5.5-4A	—	—	—	—
125 N MAX GPDA (SE931)	2015/2017	0650071	YTZ7V▲	—	—	—	—
125 NXC Cygnus X (5ML/ 5MLA/ 4P91/ 4P93)	2004/2006	0650700	YTX7A-BS■	068070	ESTX7A-BS■	—	—
125 NXC Cygnus X (5ML/ 5MLA/ 4P91/ 4P93)	2007/2013	0650710	YT7B-BS■	068071	EST7B-BS■	—	—
125 RS	1975/1977	0651033	12N10-3B	—	—	—	—
125 SR / SR SE	1992/2003	0650737	YB7L-B	0680737	ESB7L-B■	—	—
125 SV E Sno-Sport	1990/1991	065123	YTX14AHL-BS■	—	—	—	—
125 TDR Italia (3XD/ 3SH)	1989/1993	0650533	12N5-3B	—	—	—	—
125 TDR R (4GW/ 4GX)	1993/2003	065049	YTX5L-BS■	068049	ESTX5L-BS■	063049	FTX5L-BS■
125 TW / TW R-S	1999/2003	0650738	YB7C-A	0680738	ESB7C-A■	—	—
125 TW / TW R-S	2004/2004	065007	YTZ7S▲	—	—	063007	FTZ7S▲
125 TZR	1979/1981	0650533	12N5-3B	—	—	—	—
125 TZR	1987/1992	0650534	YB5L-B	0680534	ESB5L-B■	—	—
125 TZR R	1993/1996	0650738	YB7C-A	0680738	ESB7C-A■	—	—
125 TZR R/ RR Italia (4DL)	1991/1995	0650533	12N5-3B	—	—	—	—
125 VP X City (SE431)	2008/2015	0650990	YTX9-BS■	068099	ESTX9-BS■	063099	FTX9-BS■
125 WR R 4T (DE071)	2009/2013	0650636	12N5.5-4A	—	—	—	—
125 WR X 4T (DE072)	2009/2016	0650636	12N5.5-4A	—	—	—	—
125 XC Beluga (3TE) 4T	1990/1995	0650738	YB7C-A	0680738	ESB7C-A■	—	—
125 XC Cygnus R (4KY/ 4LA/ 4NB/ 4TH/ 5MJ)	1995/2003	0650700	YTX7A-BS■	068070	ESTX7A-BS■	—	—
125 XC R Majesty S	2014/2015	0650710	YT7B-BS■	068071	EST7B-BS■	—	—
125 XC Vity	2008/2013	0650700	YTX7A-BS■	068070	ESTX7A-BS■	—	—
125 XN Teo's	2000/2002	0650739	YB7L-B2	0680739	ESB7L-B2■	—	—
125 XQ Maxster	2001/2002	0650739	YB7L-B2	0680739	ESB7L-B2■	—	—
125 XT R Enduro	2005/2012	0650690	YTX7L-BS■	068069	ESTX7L-BS■	063069	FTX7L-BS■
125 XT X Supermotard	2005/2012	0650690	YTX7L-BS■	068069	ESTX7L-BS■	063069	FTX7L-BS■
125 XV Virago	1997/2000	0651134	YB10L-A2	0681134	ESB10L-A2■	—	—
125 XVS Drag Star	2000/2004	065007	YTZ7S▲	—	—	063007	FTZ7S▲
125 YBR 4T (RE31/ RE51/ RE52/ RE54)	2007/2016	0650690	YTX7L-BS■	068069	ESTX7L-BS■	063069	FTX7L-BS■
125 YN BW'S	2010/2010	0650710	YT7B-BS■	068071	EST7B-BS■	—	—
125 YP Majesty DD	2001/2010	0650739	YB7L-B2	0680739	ESB7L-B2■	—	—
125 YP Majesty DT	1998/2000	0650739	YB7L-B2	0680739	ESB7L-B2■	—	—
125 YPR X Max (SE321/ SE541/ SG252)	2006/2013	0650990	YTX9-BS■	068099	ESTX9-BS■	063099	FTX9-BS■
125 YPR X Max (SE681 - 2DM1)	2014/2015	065081	YT9B-BS▲	068081	EST9B-BS■	—	—
125 YPR X Max (SE681 - 2DM1)	2014/2015	0650811	YT9B-BS■	—	—	—	—
125 YPR X Max ABS (SE544)	2011/2012	0650990	YTX9-BS■	068099	ESTX9-BS■	063099	FTX9-BS■



▲ - Factory Sealed / Attivata dalla Fabbrica ■ - con Acido a corredo ◇ - Non di produzione YUASA a completamento gamma

Marca / Cilindrata / Modello / Anno			Cod. SGR		Cod. SGR		Cod. SGR		
YAMAHA									
125	YPR X Max ABS (SE644)	2013/2013	0650990	YTX9-BS■	068099	ESTX9-BS■	063099	FTX9-BS■	
125	YPR X Max ABS (SE684)	2014/2016	065081	YT9B-BS▲	068081	EST9B-BS■	—	—	
125	YPR X Max ABS (SE684)	2014/2016	0650811	YT9B-BS■	—	—	—	—	
125	YW BW'S	2010/2014	0650700	YTX7A-BS■	068070	ESTX7A-BS■	—	—	
125	YZF R / ABS (RE061/ RE112)	2008/2013	0650634	12N5.5-3B	0680634	ES12N5.5-3B■	—	—	
125	YZF R / ABS (RE061/ RE112)	2014/2016	0650636	12N5.5-4A	—	—	—	—	
125	YZF R 50TH	2012/2012	0650634	12N5.5-3B	0680634	ES12N5.5-3B■	—	—	
150	HW Xenter (SG231)	2012/2017	0650710	YT7B-BS■	068071	EST7B-BS■	—	—	
150	N MAX GPDA (SG431)	2017/2017	0650071	YTZ7V▲	—	—	—	—	
150	XC Flyone	1990/1998	0650700	YTX7A-BS■	068070	ESTX7A-BS■	—	—	
150	XN Teo's	2000/2002	0650739	YB7L-B2	0680739	ESB7L-B2■	—	—	
150	XQ Maxster	2001/2002	0650739	YB7L-B2	0680739	ESB7L-B2■	—	—	
150	YP Majesty DD	2001/2005	0650739	YB7L-B2	0680739	ESB7L-B2■	—	—	
150	YP Majesty DT	1998/2000	0650739	YB7L-B2	0680739	ESB7L-B2■	—	—	
180	YP Majesty DD	2003/2006	0650739	YB7L-B2	0680739	ESB7L-B2■	—	—	
200	TW	1994/1994	0650738	YB7C-A	0680738	ESB7C-A■	—	—	
200	YFM DX Moto 4	1986/1989	065122	YTX14AH-BS■	068122	ESTX14AH-BS■	—	—	
200	YFM DX Moto 4	1986/1989	0651431	YB14A-A2	0681431	ESB14A-A2■	—	—	
200	YFM Moto 4	1985/1985	065122	YTX14AH-BS■	068122	ESTX14AH-BS■	—	—	
200	YFM Moto 4	1985/1985	0651431	YB14A-A2	0681431	ESB14A-A2■	—	—	
200	YFS Blaster	1991/2002	065122	YTX14AH-BS■	068122	ESTX14AH-BS■	—	—	
200	YFS Blaster	1991/2002	0651431	YB14A-A2	0681431	ESB14A-A2■	—	—	
200	YTM , E, ER Tri Moto	1983/1985	065122	YTX14AH-BS■	068122	ESTX14AH-BS■	—	—	
200	YTM , E, ER Tri Moto	1983/1985	0651431	YB14A-A2	0681431	ESB14A-A2■	—	—	
225	YFM Moto 4	1986/1988	065122	YTX14AH-BS■	068122	ESTX14AH-BS■	—	—	
225	YFM Moto 4	1986/1988	0651431	YB14A-A2	0681431	ESB14A-A2■	—	—	
225	YTM DR Tri-Moto	1985/1986	065122	YTX14AH-BS■	068122	ESTX14AH-BS■	—	—	
225	YTM DR Tri-Moto	1985/1986	0651431	YB14A-A2	0681431	ESB14A-A2■	—	—	
225	YTM DX Tri-Moto	1983/1985	065122	YTX14AH-BS■	068122	ESTX14AH-BS■	—	—	
225	YTM DX Tri-Moto	1983/1985	0651431	YB14A-A2	0681431	ESB14A-A2■	—	—	
230	YFU-1/ T Pro-Hauler	1989/1989	065122	YTX14AH-BS■	068122	ESTX14AH-BS■	—	—	
250	TDR	1989/1989	0650533	12N5-3B	—	—	—	—	
250	TZR	1975/1977	0650534	YB5L-B	0680534	ESB5L-B■	—	—	
250	VP X City	2007/2015	0650990	YTX9-BS■	068099	ESTX9-BS■	063099	FTX9-BS■	
250	WR F	2003/2007	065049	YTX5L-BS■	068049	ESTX5L-BS■	063049	FTX5L-BS■	
250	WR F	2008/2017	065007	YTZ7S▲	—	—	063007	FTZ7S▲	
250	WR R 4T (DG201)	2008/2013	065007	YTZ7S▲	—	—	063007	FTZ7S▲	
250	WR R 4T (DG201)	2008/2013	065907	TTZ7S▲	068907	ESTTZ7S-BS■	—	—	
250	WR X 4T (DG202)	2008/2012	065007	YTZ7S▲	—	—	063007	FTZ7S▲	
250	WR X 4T (DG202)	2008/2012	065907	TTZ7S▲	068907	ESTTZ7S-BS■	—	—	
250	XG Tricker	2005/2007	065007	YTZ7S▲	—	—	063007	FTZ7S▲	



▲ - Factory Sealed / Attivata dalla Fabbrica ■ - con Acido a corredo ◇ - Non di produzione YUASA a completamento gamma

Marca / Cilindrata / Modello / Anno		Cod. SGR		Cod. SGR		Cod. SGR	
YAMAHA							
250 XS	1979/1981	0651233	12N12A-4A-1	0681233	ES12N12A-4A-1■	—	—
250 XT	1989/1989	0600413	6N4-2A-4	—	—	—	—
250 XV Virago (3LV,3LS,VG01)	1988/2014	0651134	YB10L-A2	0681134	ESB10L-A2■	—	—
250 XV Virago / Route 66	1988/1990	0651134	YB10L-A2	0681134	ESB10L-A2■	—	—
250 XV/ XV S	1975/1977	0651134	YB10L-A2	0681134	ESB10L-A2■	—	—
250 XVS Drag Star	2001/2004	065007	YTZ7S▲	—	—	063007	FTZ7S▲
250 YBR	2007/2012	0650690	YTX7L-BS■	068069	ESTX7L-BS■	063069	FTX7L-BS■
250 YFM Bear Tracker	1999/2004	065122	YTX14AH-BS■	068122	ESTX14AH-BS■	—	—
250 YFM Big Bear	2007/2009	065122	YTX14AH-BS■	068122	ESTX14AH-BS■	—	—
250 YFM Big Bear	2007/2009	0651431	YB14A-A2	0681431	ESB14A-A2■	—	—
250 YFM Bruin	2005/2006	065122	YTX14AH-BS■	068122	ESTX14AH-BS■	—	—
250 YFM Bruin	2005/2006	0651431	YB14A-A2	0681431	ESB14A-A2■	—	—
250 YFM Moto 4	1989/1991	065122	YTX14AH-BS■	068122	ESTX14AH-BS■	—	—
250 YFM R Raptor	2008/2009	065007	YTZ7S▲	—	—	063007	FTZ7S▲
250 YP Majesty (4UC)	1996/1998	0650710	YT7B-BS■	068071	EST7B-BS■	—	—
250 YP Majesty (5GM/ 5SJ)	2000/2003	0650710	YT7B-BS■	068071	EST7B-BS■	—	—
250 YP Majesty DX (5DF)	1998/2000	0650710	YT7B-BS■	068071	EST7B-BS■	—	—
250 YPR X Max (SG161/ SG162/ SG221/ SG251/ SG261)	2005/2013	0650990	YTX9-BS■	068099	ESTX9-BS■	063099	FTX9-BS■
250 YPR X Max (SG161/ SG162/ SG221/ SG251/ SG261)	2014/2016	065081	YT9B-BS▲	068081	EST9B-BS■	—	—
250 YPR X Max (SG161/ SG162/ SG221/ SG251/ SG261)	2014/2016	0650811	YT9B-BS■	—	—	—	—
250 YPR X Max ABS (SG222/ SG252/ SG262)	2011/2013	0650990	YTX9-BS■	068099	ESTX9-BS■	063099	FTX9-BS■
250 YPR X Max ABS (SG222/ SG252/ SG262)	2014/2016	065081	YT9B-BS▲	068081	EST9B-BS■	—	—
250 YPR X Max ABS (SG222/ SG252/ SG262)	2014/2016	0650811	YT9B-BS■	—	—	—	—
300 VP Versity / XC Versity (5SE1/ 1S6/ 1S64)	2003/2006	0650990	YTX9-BS■	068099	ESTX9-BS■	063099	FTX9-BS■
321 YZF R3 (RH071)	2014/2017	0650081	YTZ8V▲	0680081	ESTZ8V▲	—	—
340 CS Ovation Deluxe/ LE	1989/1998	065123	YTX14AHL-BS■	—	—	—	—
340 EC Excel III	1981/1998	065123	YTX14AHL-BS■	—	—	—	—
340 ET E Enticer	1979/1979	065215	YTX24HL-BS■	—	—	—	—
340 ET E Enticer	1980/1980	065123	YTX14AHL-BS■	—	—	—	—
350 RD A/ B (RD1/ 4130)	1975/1979	0650634	12N5.5-3B	0680634	ES12N5.5-3B■	—	—
350 RD LC (4CE1/ 4CE2)	1991/1991	0650634	12N5.5-3B	0680634	ES12N5.5-3B■	—	—
350 RD LC (4CE4/ 4CE5/ 4CE6)	1992/1992	0650634	12N5.5-3B	0680634	ES12N5.5-3B■	—	—
350 RD LC (4L0)	1980/1982	0650634	12N5.5-3B	0680634	ES12N5.5-3B■	—	—
350 RD LC F2 (1UA/ 1WT)	1986/1986	0650634	12N5.5-3B	0680634	ES12N5.5-3B■	—	—
350 RD LC F2 (2UA)	1987/1987	0650634	12N5.5-3B	0680634	ES12N5.5-3B■	—	—
350 RD LC F2 (3DH)	1988/1990	0650634	12N5.5-3B	0680634	ES12N5.5-3B■	—	—
350 RD LC2 YPVS (57V/ 1WX/ 1WW/ 31K/ 1JF/ 1JG)	1983/1985	0650634	12N5.5-3B	0680634	ES12N5.5-3B■	—	—
350 TT	1986/1994	0600211	6N2-2A-1	—	—	—	—
350 XT	1975/1977	0650334	YB3L-A	0680334	ESB3L-A■	—	—
350 XT	1985/2000	0650335	YB3L-B	0680335	ESB3L-B■	—	—
350 YFM Bruin Auto 2X4,4x4, Hunter	2004/2005	065122	YTX14AH-BS■	068122	ESTX14AH-BS■	—	—



▲ - Factory Sealed / Attivata dalla Fabbrica ■ - con Acido a corredo ◇ - Non di produzione YUASA a completamento gamma

Marca / Cilindrata / Modello / Anno			Cod. SGR		Cod. SGR		Cod. SGR	
YAMAHA								
350	YFM FW Big Bear 4WD	1987/1999	065122	YTX14AH-BS■	068122	ESTX14AH-BS■	—	—
350	YFM FW Big Bear 4WD	1987/1999	0651431	YB14A-A2	0681431	ESB14A-A2■	—	—
350	YFM Grizzly 2WD	2008/2010	065122	YTX14AH-BS■	068122	ESTX14AH-BS■	—	—
350	YFM Grizzly 4WD	2007/2010	065122	YTX14AH-BS■	068122	ESTX14AH-BS■	—	—
350	YFM Moto 4	1985/1995	0651431	YB14A-A2	0681431	ESB14A-A2■	—	—
350	YFM Moto 4	1987/1995	065122	YTX14AH-BS■	068122	ESTX14AH-BS■	—	—
350	YFM Raptor	2004/2009	065010	YTZ10S▲	—	—	063010	FTZ10S▲
350	YFM Raptor	2004/2009	065910	TTZ10S-BS	068910	ESTTZ10S-BS■	—	—
350	YFM U Big Bear 2WD	1996/1999	065122	YTX14AH-BS■	068122	ESTX14AH-BS■	—	—
350	YFM U Big Bear 2WD	1996/1999	0651431	YB14A-A2	0681431	ESB14A-A2■	—	—
350	YFM X Wolverine	1995/2005	065122	YTX14AH-BS■	068122	ESTX14AH-BS■	—	—
350	YFM X Wolverine 2WD	2006/2009	065122	YTX14AH-BS■	068122	ESTX14AH-BS■	—	—
350	YFP TerraPro	1988/1988	065122	YTX14AH-BS■	068122	ESTX14AH-BS■	—	—
350	YFP TerraPro	1988/1988	0651431	YB14A-A2	0681431	ESB14A-A2■	—	—
360	DT	1979/1981	0600413	6N4-2A-4	—	—	—	—
400	DT	1975/1977	0600412	6N4B-2A	—	—	—	—
400	FZR	1987/1990	0651233	12N12A-4A-1	0681233	ES12N12A-4A-1■	—	—
400	XJ	1980/1982	0651233	12N12A-4A-1	0681233	ES12N12A-4A-1■	—	—
400	XS	1977/1982	0651233	12N12A-4A-1	0681233	ES12N12A-4A-1■	—	—
400	YFM Big Bear 2X4, 4X4	2000/2003	0650202	GYZ20HL▲	—	—	—	—
400	YFM Big Bear 2X4, 4X4	2000/2003	065185	YTX20HL-BS■	—	—	—	—
400	YFM FW Kodiak 2X4	1993/1995	065122	YTX14AH-BS■	068122	ESTX14AH-BS■	—	—
400	YFM FW Kodiak 2X4	1996/2002	0650202	GYZ20HL▲	—	—	—	—
400	YFM FW Kodiak 2X4	1996/2002	065185	YTX20HL-BS■	—	—	—	—
400	YFM FW Kodiak 4X4	1993/1995	065122	YTX14AH-BS■	068122	ESTX14AH-BS■	—	—
400	YFM FW Kodiak 4X4	1993/1995	0651431	YB14A-A2	0681431	ESB14A-A2■	—	—
400	YFM FW Kodiak 4X4	1996/2002	0650202	GYZ20HL▲	—	—	—	—
400	YFM FW Kodiak 4X4	1996/2002	065185	YTX20HL-BS■	—	—	—	—
400	YFM Grizzly	2007/2009	065122	YTX14AH-BS■	068122	ESTX14AH-BS■	—	—
400	YFM Kodiak Auto 2X4	1996/2002	0650202	GYZ20HL▲	—	—	—	—
400	YFM Kodiak Auto 2X4	1996/2002	065185	YTX20HL-BS■	—	—	—	—
400	YFM Kodiak Auto 2X4	2003/2006	065122	YTX14AH-BS■	068122	ESTX14AH-BS■	—	—
400	YFM Kodiak Auto 4X4	2000/2002	0650202	GYZ20HL▲	—	—	—	—
400	YFM Kodiak Auto 4X4	2000/2002	065185	YTX20HL-BS■	—	—	—	—
400	YFM Kodiak Auto 4X4	2003/2006	065122	YTX14AH-BS■	068122	ESTX14AH-BS■	—	—
400	YP Majesty	2004/2006	065081	YT9B-BS▲	068081	EST9B-BS■	—	—
400	YP Majesty	2004/2006	0650811	YT9B-BS■	—	—	—	—
400	YP Majesty (5RUJ/ 5RUH/ 5RUG/ 5RUX/ 5RUY)	2007/2014	065081	YT9B-BS▲	068081	EST9B-BS■	—	—
400	YP Majesty (5RUJ/ 5RUH/ 5RUG/ 5RUX/ 5RUY)	2007/2014	0650811	YT9B-BS■	—	—	—	—
400	YPR X MAX (SH071)	2013/2015	065081	YT9B-BS▲	068081	EST9B-BS■	—	—
400	YPR X MAX (SH071)	2013/2015	0650811	YT9B-BS■	—	—	—	—



▲ - Factory Sealed / Attivata dalla Fabbrica ■ - con Acido a corredo ◇ - Non di produzione YUASA a completamento gamma

Marca / Cilindrata / Modello / Anno			Cod. SGR		Cod. SGR		Cod. SGR		
YAMAHA									
400	YPR X MAX ABS (SH072)	2014/2016	065081	YT9B-BS▲	068081	EST9B-BS■	—	—	
400	YPR X MAX ABS (SH072)	2014/2016	0650811	YT9B-BS■	—	—	—	—	
450	WR F	2003/2016	065007	YTZ7S▲	—	—	063007	FTZ7S▲	
450	YFM FX Wolverine	2006/2010	0650202	GYZ20HL▲	—	—	—	—	
450	YFM FX Wolverine	2006/2010	065185	YTX20HL-BS■	—	—	—	—	
450	YFM FX Wolverine	2006/2010	065209	YTX20L-BS■	068209	ESTX20L-BS■	—	—	
450	YFM Grizzly / Hunter 2WD	2007/2010	0650202	GYZ20HL▲	—	—	—	—	
450	YFM Grizzly / Hunter 2WD	2007/2010	065185	YTX20HL-BS■	—	—	—	—	
450	YFM Grizzly / Hunter 2WD	2007/2010	065209	YTX20L-BS■	068209	ESTX20L-BS■	—	—	
450	YFM Grizzly / Hunter 4WD	2007/2010	0650202	GYZ20HL▲	—	—	—	—	
450	YFM Grizzly / Hunter 4WD	2007/2010	065185	YTX20HL-BS■	—	—	—	—	
450	YFM Grizzly / Hunter 4WD	2007/2010	065209	YTX20L-BS■	068209	ESTX20L-BS■	—	—	
450	YFM Kodiak Auto 4X4	2003/2006	0650202	GYZ20HL▲	—	—	—	—	
450	YFM Kodiak Auto 4X4	2003/2006	065185	YTX20HL-BS■	—	—	—	—	
450	YFM Kodiak Auto 4X4	2003/2006	065209	YTX20L-BS■	068209	ESTX20L-BS■	—	—	
450	YFZ R	2009/2015	065007	YTZ7S▲	—	—	063007	FTZ7S▲	
450	YFZ S	2004/2008	0650710	YT7B-BS■	068071	EST7B-BS■	—	—	
450	YFZ X	2010/2010	065007	YTZ7S▲	—	—	063007	FTZ7S▲	
480	PZ E Phazer Deluxe	1984/1989	065123	YTX14AHL-BS■	—	—	—	—	
480	PZ E Phazer II LE, SS	1990/1998	065123	YTX14AHL-BS■	—	—	—	—	
480	VT Venture GT	1992/1993	065123	YTX14AHL-BS■	—	—	—	—	
480	VT Venture TR Electric	1998/1998	065123	YTX14AHL-BS■	—	—	—	—	
480	VT Venture XL	1991/1997	065123	YTX14AHL-BS■	—	—	—	—	
500	MJ S/ T/ TW (Jet Ski)	TUTTI	0651640	YB16CL-B	0681640	ESB16CL-B■	—	—	
500	MJ S/ T/ TW (Jet Ski)	TUTTI	065186	YTX20HL-BS-PW■	—	—	—	—	
500	RD LC	TUTTI	0650634	12N5.5-3B	0680634	ES12N5.5-3B■	—	—	
500	SR	1978/1981	0650734	12N7-3B	0680734	ES12N7-3B■	—	—	
500	TX	1973/1974	065123	YTX14AHL-BS■	—	—	—	—	
500	TX	1973/1974	0651433	12N14-3A	—	—	—	—	
500	TX	1973/1974	0651434	YB14L-A2	0681434	ESB14L-A2■	—	—	
500	XP T-Max (SJ011)	2001/2003	065081	YT9B-BS▲	068081	EST9B-BS■	—	—	
500	XP T-Max (SJ011)	2001/2003	0650811	YT9B-BS■	—	—	—	—	
500	XP T-Max (SJ031/ SJ051/ SJ032/ SJ034/ SJ052)	2004/2007	065081	YT9B-BS▲	068081	EST9B-BS■	—	—	
500	XP T-Max (SJ031/ SJ051/ SJ032/ SJ034/ SJ052)	2004/2007	0650811	YT9B-BS■	—	—	—	—	
500	XP T-Max (SJ061/ SJ062/ SJ064)	2008/2011	065010	YTZ10S▲	—	—	063010	FTZ10S▲	
500	XP T-Max (SJ061/ SJ062/ SJ064)	2008/2011	065910	TTZ10S-BS	068910	ESTTZ10S-BS■	—	—	
500	XS	1975/1978	065123	YTX14AHL-BS■	—	—	—	—	
500	XS	1975/1978	0651434	YB14L-A2	0681434	ESB14L-A2■	—	—	
500	XT	TUTTI	0600634	6N6-3B-1	—	—	—	—	
500	XV SE/ Virago	1983/>	0651233	12N12A-4A-1	0681233	ES12N12A-4A-1■	—	—	
530	XP D T-Max DX ABS (SJ145)	2017/2017	065012	YTZ12S▲	—	—	063012	FTZ12S▲	



▲ - Factory Sealed / Attivata dalla Fabbrica ■ - con Acido a corredo ◇ - Non di produzione YUASA a completamento gamma

Marca / Cilindrata / Modello / Anno			Cod. SGR		Cod. SGR		Cod. SGR		
YAMAHA									
530	XP E T-Max ABS	2017/2017	065012	YTZ12S▲	—	—	063012	FTZ12S▲	
530	XP T-Max (SJ091/ SJ098/ SJ099)	2012/2016	065012	YTZ12S▲	—	—	063012	FTZ12S▲	
530	XP T-Max SX ABS (SJ142)	2017/2017	065012	YTZ12S▲	—	—	063012	FTZ12S▲	
535	XV Virago	1986/2002	06512400	YB12AL-A2	0681240	ESB12AL-A2■	—	—	
540	EC Excel	1979/1980	065215	YTX24HL-BS■	—	—	—	—	
550	XJ Maxim	1981/1983	0651233	12N12A-4A-1	0681233	ES12N12A-4A-1■	—	—	
550	XT	1982/1983	0650533	12N5-3B	—	—	—	—	
550	XZ R Vision	1982/1983	065123	YTX14AHL-BS■	—	—	—	—	
550	XZ R Vision	1982/1983	0651434	YB14L-A2	0681434	ESB14L-A2■	—	—	
600	FJ	1984/1985	0651233	12N12A-4A-1	0681233	ES12N12A-4A-1■	—	—	
600	FZ (3BX)	1986/1988	0651233	12N12A-4A-1	0681233	ES12N12A-4A-1■	—	—	
600	FZ6 Fazer, Abs, S2 (RJ07)	2004/2010	0651100	YT12B-BS■	0681100	EST12B-BS■	—	—	
600	FZ6 N,NS,S2(RJ07)	2004/2010	0651100	YT12B-BS■	0681100	EST12B-BS■	—	—	
600	FZR (3RG/ 3RH/ 3HE)	1989/1990	0651233	12N12A-4A-1	0681233	ES12N12A-4A-1■	—	—	
600	FZR (3RG/ 3RH/ 3HE)	1991/1993	06512400	YB12AL-A2	0681240	ESB12AL-A2■	—	—	
600	FZR R (4JH)	1994/1995	0651090	YTX12-BS■	0681090	ESTX12-BS■	063109	FTX12-BS■	
600	FZS Fazer (RJ02)	1997/2003	0651100	YT12B-BS■	0681100	EST12B-BS■	—	—	
600	FZS Fazer S (RJ02)	2000/2001	0651100	YT12B-BS■	0681100	EST12B-BS■	—	—	
600	SRX (1XL/ 1XM/ 1XN)	1986/1991	0650533	12N5-3B	—	—	—	—	
600	TT E (4GW/ 4LW)	1994/2001	0650990	YTX9-BS■	068099	ESTX9-BS■	063099	FTX9-BS■	
600	TT RE (5CH5)	2004/2004	065081	YT9B-BS▲	068081	EST9B-BS■	—	—	
600	TT RE (5CH5)	2004/2004	0650811	YT9B-BS■	—	—	—	—	
600	VT Venture	1999/2002	065215	YTX24HL-BS■	—	—	—	—	
600	VXDX Vmax Deluxe	1999/2001	065215	YTX24HL-BS■	—	—	—	—	
600	VXER Vmax ER	2002/2002	065215	YTX24HL-BS■	—	—	—	—	
600	XJ (51J/ 3KM/ 3KN)	1984/1991	0651233	12N12A-4A-1	0681233	ES12N12A-4A-1■	—	—	
600	XJ 6 F (RG198/ RG19M) (1CW)	2010/2011	0651100	YT12B-BS■	0681100	EST12B-BS■	—	—	
600	XJ 6 N (RJ195/ RJ224) (20S/ 36B)	2009/2015	0651100	YT12B-BS■	0681100	EST12B-BS■	—	—	
600	XJ 6 S Diversion (RJ191/ RJ229) (20S/ 36B)	2009/2015	0651100	YT12B-BS■	0681100	EST12B-BS■	—	—	
600	XJ S Diversion (4EB1)	1992/2003	0650990	YTX9-BS■	068099	ESTX9-BS■	063099	FTX9-BS■	
600	XT (2KF)	1987/1989	0650534	YB5L-B	0680534	ESB5L-B■	—	—	
600	XT (43F/ 47N)	1983/1986	0650534	YB5L-B	0680534	ESB5L-B■	—	—	
600	XT E (3UW/ 3TB/ 4PT)	1990/2002	0650990	YTX9-BS■	068099	ESTX9-BS■	063099	FTX9-BS■	
600	XT K (3TB)	1991/1993	0650990	YTX9-BS■	068099	ESTX9-BS■	063099	FTX9-BS■	
600	XT Z Ténéré (34L/ 55W/ 1VJ/ 3AJ)	1985/1990	06512400	YB12AL-A2	0681240	ESB12AL-A2■	—	—	
600	YFM FW Grizzly	1998/2001	0650202	GYZ20HL▲	—	—	—	—	
600	YFM FW Grizzly	1998/2001	065185	YTX20HL-BS■	—	—	—	—	
600	YFM FW Grizzly	1998/2001	065209	YTX20L-BS■	068209	ESTX20L-BS■	—	—	
600	YX Radian	1986/1988	065209	YTX20L-BS■	068209	ESTX20L-BS■	—	—	
600	YZF R Thundercat (4TV/ 4WD)	1996/2003	0651090	YTX12-BS■	0681090	ESTX12-BS■	063109	FTX12-BS■	
600	YZF R6 (RJ03/ RJ05/ RJ09)	1998/2000	0651100	YT12B-BS■	0681100	EST12B-BS■	—	—	

▲ - Factory Sealed / Attivata dalla Fabbrica ■ - con Acido a corredo ◇ - Non di produzione YUASA a completamento gamma

Marca / Cilindrata / Modello / Anno			Cod. SGR		Cod. SGR		Cod. SGR		
YAMAHA									
600	YZF R6 (RJ03/ RJ05/ RJ09)	2001/2005	065081	YT9B-BS▲	068081	EST9B-BS■	—	—	
600	YZF R6 (RJ03/ RJ05/ RJ09)	2001/2005	0650811	YT9B-BS■	—	—	—	—	
600	YZF R6 R (RJ11/ RJ151/ RJ152/ RJ155/ RJ156)	2006/2016	065010	YTZ10S▲	—	—	063010	FTZ10S▲	
600	YZF R6 S	2006/2006	065081	YT9B-BS▲	068081	EST9B-BS■	—	—	
600	YZF R6 S	2006/2006	0650811	YT9B-BS■	—	—	—	—	
650	MJ T/ TW/ M (Jet Ski)	TUTTI	0651640	YB16CL-B	0681640	ESB16CL-B■	—	—	
650	MJ T/ TW/ M (Jet Ski)	TUTTI	065186	YTX20HL-BS-PW■	—	—	—	—	
650	TX	1974/>	0651433	12N14-3A	—	—	—	—	
650	TX	1974/1974	065123	YTX14AHL-BS■	—	—	—	—	
650	TX	1974/1974	0651434	YB14L-A2	0681434	ESB14L-A2■	—	—	
650	X1/ X2	1980/1983	065123	YTX14AHL-BS■	—	—	—	—	
650	XJ	1981/>	0651434	YB14L-A2	0681434	ESB14L-A2■	—	—	
650	XJ Midnight	1981/1982	0651233	12N12A-4A-1	0681233	ES12N12A-4A-1■	—	—	
650	XJ R Seca	1982/1983	0651233	12N12A-4A-1	0681233	ES12N12A-4A-1■	—	—	
650	XJ T Turbo LJ/ LK (11T)	1982/1984	0651233	12N12A-4A-1	0681233	ES12N12A-4A-1■	—	—	
650	XS	1975/1983	065123	YTX14AHL-BS■	—	—	—	—	
650	XS	1975/1983	0651434	YB14L-A2	0681434	ESB14L-A2■	—	—	
650	XVS Drag Star (4XR/ 4VR)	1997/2002	0651090	YTX12-BS■	0681090	ESTX12-BS■	063109	FTX12-BS■	
650	XVS Drag Star (4XR/ 4VR)	2002/2006	0651100	YT12B-BS■	0681100	EST12B-BS■	—	—	
650	XVS Drag Star Classic (VM022/ VM025)	1998/2002	0651090	YTX12-BS■	0681090	ESTX12-BS■	063109	FTX12-BS■	
650	XVS Drag Star Classic (VM022/ VM025)	2002/2006	0651100	YT12B-BS■	0681100	EST12B-BS■	—	—	
660	MT03	2005/2013	065081	YT9B-BS▲	068081	EST9B-BS■	—	—	
660	MT03	2005/2013	0650811	YT9B-BS■	—	—	—	—	
660	SZR	1996/2000	0650990	YTX9-BS■	068099	ESTX9-BS■	063099	FTX9-BS■	
660	XT R	2004/2015	065081	YT9B-BS▲	068081	EST9B-BS■	—	—	
660	XT R	2004/2015	0650811	YT9B-BS■	—	—	—	—	
660	XT X	2004/2015	065081	YT9B-BS▲	068081	EST9B-BS■	—	—	
660	XT X	2004/2015	0650811	YT9B-BS■	—	—	—	—	
660	XT Z Ténéré (DM021/ DM025/ DM041)	2008/2015	065081	YT9B-BS▲	068081	EST9B-BS■	—	—	
660	XT Z Ténéré (DM021/ DM025/ DM041)	2008/2015	0650811	YT9B-BS■	—	—	—	—	
660	XTZ Ténéré	1990/1998	0650990	YTX9-BS■	068099	ESTX9-BS■	063099	FTX9-BS■	
660	YFM FWAP Grizzly	2002/2008	0650202	GYZ20HL▲	—	—	—	—	
660	YFM FWAP Grizzly	2002/2008	065185	YTX20HL-BS■	—	—	—	—	
660	YFM FWAP Grizzly	2002/2008	065209	YTX20L-BS■	068209	ESTX20L-BS■	—	—	
660	YFM R Raptor	2001/2005	065124	YTX14H-BS■	—	—	—	—	
660	YFM R Raptor	2001/2005	065129	YTX14-BS■	068129	ESTX14-BS■	—	—	
700	FZ Genesis	1987/1987	065123	YTX14AHL-BS■	—	—	—	—	
700	FZ Genesis	1987/1987	0651434	YB14L-A2	0681434	ESB14L-A2■	—	—	
700	FZX Fazer	1986/1987	065123	YTX14AHL-BS■	—	—	—	—	
700	FZX Fazer	1986/1987	0651434	YB14L-A2	0681434	ESB14L-A2■	—	—	
700	MT07 / MT07 ABS (RM042)	2014/2016	065010	YTZ10S▲	—	—	063010	FTZ10S▲	



▲ - Factory Sealed / Attivata dalla Fabbrica ■ - con Acido a corredo ◇ - Non di produzione YUASA a completamento gamma

Marca / Cilindrata / Modello / Anno			Cod. SGR		Cod. SGR		Cod. SGR		
YAMAHA									
700	MT07A (RM171)	2017/2017	065010	YTZ10S▲	—	—	063010	FTZ10S▲	
700	MT07A Tracer (RM141)	2016/2016	065010	YTZ10S▲	—	—	063010	FTZ10S▲	
700	SXV ER Viper	2002/2002	065215	YTX24HL-BS■	—	—	—	—	
700	VT Venture	1998/2002	065215	YTX24HL-BS■	—	—	—	—	
700	VX ER/ DX Vmax Deluxe	1999/2002	065215	YTX24HL-BS■	—	—	—	—	
700	VX XTCD Vmax XTC Deluxe	1998/1998	065215	YTX24HL-BS■	—	—	—	—	
700	XJ Maxim	1986/1987	065123	YTX14AHL-BS■	—	—	—	—	
700	XJ Maxim	1986/1987	0651434	YB14L-A2	0681434	ESB14L-A2■	—	—	
700	XJ X Maxim X	1985/1985	065123	YTX14AHL-BS■	—	—	—	—	
700	XJ X Maxim X	1985/1985	0651434	YB14L-A2	0681434	ESB14L-A2■	—	—	
700	XSR (RM111)	2016/2017	065010	YTZ10S▲	—	—	063010	FTZ10S▲	
700	XV Virago (L/ N/ CS/ SS/ CT)	1984/1987	06516340	YB16AL-A2	0681634	ESB16AL-A2■	—	—	
700	YFM F Grizzly FI Auto 4X4	2007/2015	0650202	GYZ20HL▲	—	—	—	—	
700	YFM F Grizzly FI Auto 4X4	2007/2015	065185	YTX20HL-BS■	—	—	—	—	
700	YFM F Grizzly FI Auto 4X4	2007/2015	065209	YTX20L-BS■	068209	ESTX20L-BS■	—	—	
700	YFM F Grizzly FI Auto 4X4 EPS	2007/2010	0650202	GYZ20HL▲	—	—	—	—	
700	YFM F Grizzly FI Auto 4X4 EPS	2007/2010	065185	YTX20HL-BS■	—	—	—	—	
700	YFM F Grizzly FI Auto 4X4 EPS	2007/2010	065209	YTX20L-BS■	068209	ESTX20L-BS■	—	—	
700	YFM R Raptor	2006/2015	065081	YT9B-BS▲	068081	EST9B-BS■	—	—	
700	YFM R Raptor	2006/2015	0650811	YT9B-BS■	—	—	—	—	
750	FZ / FZ Genesis	1985/1990	065123	YTX14AHL-BS■	—	—	—	—	
750	FZ / FZ Genesis	1985/1990	0651434	YB14L-A2	0681434	ESB14L-A2■	—	—	
750	FZR R Genesis	1987/1988	065123	YTX14AHL-BS■	—	—	—	—	
750	FZR R Genesis	1987/1988	0651434	YB14L-A2	0681434	ESB14L-A2■	—	—	
750	FZX	1987/1994	0651434	YB14L-A2	0681434	ESB14L-A2■	—	—	
750	TX	1973/1974	0650202	GYZ20HL▲	—	—	—	—	
750	TX	1973/1974	0651636	YB16L-B	0681636	ESB16L-B■	—	—	
750	TX	1973/1974	065185	YTX20HL-BS■	—	—	—	—	
750	XJ	1981/1983	065123	YTX14AHL-BS■	—	—	—	—	
750	XJ	1981/1983	0651434	YB14L-A2	0681434	ESB14L-A2■	—	—	
750	XJ Maxim	1982/1985	065123	YTX14AHL-BS■	—	—	—	—	
750	XJ Maxim	1982/1985	0651434	YB14L-A2	0681434	ESB14L-A2■	—	—	
750	XJ R Seca	1982/1983	0651434	YB14L-A2	0681434	ESB14L-A2■	—	—	
750	XS	1977/1979	065123	YTX14AHL-BS■	—	—	—	—	
750	XS	1977/1979	0651434	YB14L-A2	0681434	ESB14L-A2■	—	—	
750	XTZ Super Ténéré	1989/1997	0651432	YB14L-A	—	—	—	—	
750	XV Virago (H/ J/ K)	1981/1983	06516340	YB16AL-A2	0681634	ESB16AL-A2■	—	—	
750	XV Virago (U/ WA/ B/ C/ D/ E/ F/ G/ H/ J)	1988/2000	06516340	YB16AL-A2	0681634	ESB16AL-A2■	—	—	
750	YZF R	1993/1998	0650990	YTX9-BS■	068099	ESTX9-BS■	063099	FTX9-BS■	
750	YZF R SP	1993/1997	0650990	YTX9-BS■	068099	ESTX9-BS■	063099	FTX9-BS■	
750	YZF R7 (OW02)	1999/2002	065081	YT9B-BS▲	068081	EST9B-BS■	—	—	



▲ - Factory Sealed / Attivata dalla Fabbrica ■ - con Acido a corredo ◇ - Non di produzione YUASA a completamento gamma

Marca / Cilindrata / Modello / Anno		Cod. SGR		Cod. SGR		Cod. SGR	
YAMAHA							
750	YZF R7 (OW02)	1999/2002	0650811	YT9B-BS■	—	—	—
754	All WaveRunner Models	1987/2002	065186	YTX20HL-BS-PW■	—	—	—
800	FZ8 N / ABS (RN255/ RN256)	2011/2015	065010	YTZ10S▲	—	—	063010 FTZ10S▲
800	FZ8 S Fazer / ABS (RN251/ RN252)	2011/2015	065010	YTZ10S▲	—	—	063010 FTZ10S▲
850	MT09 / MT09 ABS (RN291/ RN296)(IRC/ 2DR)	2014/2016	065010	YTZ10S▲	—	—	063010 FTZ10S▲
850	MT09 Tracer (R29F)(2SC1/ 2SC9/ 2SCA/ 2SCC)	2015/2016	065010	YTZ10S▲	—	—	063010 FTZ10S▲
850	TDM	1991/1995	0651090	YTX12-BS■	0681090	ESTX12-BS■	063109 FTX12-BS■
850	TDM	1996/2001	0651100	YT12B-BS■	0681100	EST12B-BS■	—
850	XS (G/ H)	1980/1981	065123	YTX14AHL-BS■	—	—	—
850	XS (G/ H)	1980/1981	0651434	YB14L-A2	0681434	ESB14L-A2■	—
850	XSR900 (RN431)	2016/2016	065010	YTZ10S▲	—	—	063010 FTZ10S▲
900	TDM	2002/2013	0651100	YT12B-BS■	0681100	EST12B-BS■	—
900	XJ	1983/1992	0651434	YB14L-A2	0681434	ESB14L-A2■	—
900	XJ R Seca	1983/1983	065123	YTX14AHL-BS■	—	—	—
900	XJ R Seca	1983/1983	0651434	YB14L-A2	0681434	ESB14L-A2■	—
900	XJ S Diversion	1994/2003	065124	YTX14H-BS■	—	—	—
900	XJ S Diversion	1994/2003	065129	YTX14-BS■	068129	ESTX14-BS■	—
920	XV M Midnight Virago (K)	1983/1983	0652034	Y50-N18L-A	0682034	ES50-N18L-A■	—
920	XV M Midnight Virago (K)	1983/1983	065215	YTX24HL-BS■	—	—	—
920	XV R Virago (H/ J/ K)	1981/1983	0652034	Y50-N18L-A	0682034	ES50-N18L-A■	—
920	XV R Virago (H/ J/ K)	1981/1983	065215	YTX24HL-BS■	—	—	—
920	XV Virago (J/ K)	1982/1983	0652034	Y50-N18L-A	0682034	ES50-N18L-A■	—
920	XV Virago (J/ K)	1982/1983	065215	YTX24HL-BS■	—	—	—
950	XV (VN031) (2DE1)	2014/2015	065014	YTZ14S▲	—	—	—
950	XV / ABS (VN032) (1XC1/ 1CX3)	2014/2016	065014	YTZ14S▲	—	—	—
950	XV R (VN036) (2DX7/ 2DXL/ 2DXM)	2014/2016	065014	YTZ14S▲	—	—	—
950	XVS Midnight Star (VN021)(26P)	2009/2015	065014	YTZ14S▲	—	—	—
1000	FZ1-N/ NA	2006/2015	065014	YTZ14S▲	—	—	—
1000	FZ1-S Fazer / Fazer Abs	2006/2015	065014	YTZ14S▲	—	—	—
1000	FZR	1987/1990	065123	YTX14AHL-BS■	—	—	—
1000	FZR	1987/1990	0651434	YB14L-A2	0681434	ESB14L-A2■	—
1000	FZR	1991/1995	065124	YTX14H-BS■	—	—	—
1000	FZR	1991/1995	065129	YTX14-BS■	068129	ESTX14-BS■	—
1000	FZS Fazer (RN06)	2001/2005	065130	YT14B-BS▲	068130	EST14B-BS■	—
1000	GTS/ GTS ABS	1993/2000	065124	YTX14H-BS■	—	—	—
1000	GTS/ GTS ABS	1993/2000	065129	YTX14-BS■	068129	ESTX14-BS■	—
1000	MT10 (RN451)	2016/2016	065010	YTZ10S▲	—	—	063010 FTZ10S▲
1000	MT10D (RN455)	2017/2017	065010	YTZ10S▲	—	—	063010 FTZ10S▲
1000	XV SE Virago	1984/1985	0652034	Y50-N18L-A	0682034	ES50-N18L-A■	—
1000	XV SE Virago	1984/1985	065215	YTX24HL-BS■	—	—	—
1000	YZF R1 (RN011)(4XV)	1998/1999	0651100	YT12B-BS■	0681100	EST12B-BS■	—

▲ - Factory Sealed / Attivata dalla Fabbrica ■ - con Acido a corredo ◇ - Non di produzione YUASA a completamento gamma

Marca / Cilindrata / Modello / Anno			Cod. SGR		Cod. SGR		Cod. SGR	
YAMAHA								
1000	YZF R1 (RN041)(5JJ)	2000/2001	0651100	YT12B-BS■	0681100	EST12B-BS■	—	—
1000	YZF R1 (RN091)(5PW)	2002/2003	0651100	YT12B-BS■	0681100	EST12B-BS■	—	—
1000	YZF R1 (RN121/ 124)(5VY)	2004/2005	065010	YTZ10S▲	—	—	063010	FTZ10S▲
1000	YZF R1 (RN126/ 127)(5VY)	2006/2006	065010	YTZ10S▲	—	—	063010	FTZ10S▲
1000	YZF R1 (RN191/ 192)(4C8)	2007/2008	065010	YTZ10S▲	—	—	063010	FTZ10S▲
1000	YZF R1 (RN221/ 222)(14B)	2009/2011	065010	YTZ10S▲	—	—	063010	FTZ10S▲
1000	YZF R1 (RN225)(1KB)	2012/2014	065010	YTZ10S▲	—	—	063010	FTZ10S▲
1000	YZF R1 (RN321)(2CR)	2015/2016	065007	YTZ7S▲	—	—	063007	FTZ7S▲
1000	YZF R1M (RN326)(2KS)	2015/2016	065007	YTZ7S▲	—	—	063007	FTZ7S▲
1000	YZF Thunderace (4VD)	1996/2000	065124	YTX14H-BS■	—	—	—	—
1000	YZF Thunderace (4VD)	1996/2000	065129	YTX14-BS■	068129	ESTX14-BS■	—	—
1100	BT Bulldog	2002/2007	065130	YT14B-BS▲	068130	EST14B-BS■	—	—
1100	FJ (47E)	1984/1985	065123	YTX14AHL-BS■	—	—	—	—
1100	FJ (47E)	1984/1985	0651434	YB14L-A2	0681434	ESB14L-A2■	—	—
1100	XJ Maxim	1982/1982	0652034	Y50-N18L-A	0682034	ES50-N18L-A■	—	—
1100	XJ Maxim	1982/1982	065215	YTX24HL-BS■	—	—	—	—
1100	XS	1978/1981	0652034	Y50-N18L-A	0682034	ES50-N18L-A■	—	—
1100	XS	1978/1981	065215	YTX24HL-BS■	—	—	—	—
1100	XS S	1978/1981	0652034	Y50-N18L-A	0682034	ES50-N18L-A■	—	—
1100	XS S	1978/1981	065215	YTX24HL-BS■	—	—	—	—
1100	XV Virago	1986/1998	0652035	SY50-N18L-AT	—	—	—	—
1100	XV Virago	1986/1999	065215	YTX24HL-BS■	—	—	—	—
1100	XVS Drag Star	1997/2006	065130	YT14B-BS▲	068130	EST14B-BS■	—	—
1100	XVS Drag Star / V Star Classic	2000/2009	065130	YT14B-BS▲	068130	EST14B-BS■	—	—
1131	All WaveRunner Models	1987/2002	065186	YTX20HL-BS-PW■	—	—	—	—
1200	FJ A Fairing ABS	1991/1993	065124	YTX14H-BS■	—	—	—	—
1200	FJ A Fairing ABS	1991/1993	065129	YTX14-BS■	068129	ESTX14-BS■	—	—
1200	FJ Fairing	1986/1992	0651434	YB14L-A2	0681434	ESB14L-A2■	—	—
1200	V Max	1985/2003	06516340	YB16AL-A2	0681634	ESB16AL-A2■	—	—
1200	XJR	1994/1997	065124	YTX14H-BS■	—	—	—	—
1200	XJR	1994/1997	065129	YTX14-BS■	068129	ESTX14-BS■	—	—
1200	XTZ Superténéré (DP011/ 041/ 046)(23P/ 2BS/ 2KB)	2010/2015	065012	YTZ12S▲	—	—	063012	FTZ12S▲
1200	XVZ 12TD Venture Royale	1983/1985	0652035	SY50-N18L-AT	—	—	—	—
1200	XVZ 12TD Venture Royale	1983/1985	065215	YTX24HL-BS■	—	—	—	—
1300	FJR (RP081/ 084/ 111)(5JW)	2001/2005	065130	YT14B-BS▲	068130	EST14B-BS■	—	—
1300	FJR A - FJR AS	2006/2015	065130	YT14B-BS▲	068130	EST14B-BS■	—	—
1300	XJR (RP021/ 022/ 024/ 061/ 064/ 101/ 104/ 191/ 192/ 194)(5EA/ 5WM/ 2PN)	1999/2006	065130	YT14B-BS▲	068130	EST14B-BS■	—	—
1300	XJR (RP021/ 022/ 024/ 061/ 064/ 101/ 104/ 191/ 192/ 194)(5EA/ 5WM/ 2PN)	2007/2015	065014	YTZ14S▲	—	—	—	—
1300	XVS A Midnight Star (VP261)(11C1/ 11C2)	2007/2010	0650202	GYZ20HL▲	—	—	—	—
1300	XVS A Midnight Star (VP261)(11C1/ 11C2)	2007/2010	065185	YTX20HL-BS■	—	—	—	—
1300	XVS A Midnight Star (VP261)(11C1/ 11C2)	2007/2010	065209	YTX20L-BS■	068209	ESTX20L-BS■	—	—

▲ - Factory Sealed / Attivata dalla Fabbrica ■ - con Acido a corredo ◇ - Non di produzione YUASA a completamento gamma

Marca / Cilindrata / Modello / Anno			Cod. SGR		Cod. SGR		Cod. SGR		
YAMAHA									
1300	XVS A Midnight Star (VP264)(11C5/ 11C7/ 11C9)	2011/2016	0650202	GYZ20HL▲	—	—	—	—	
1300	XVS A Midnight Star (VP264)(11C5/ 11C7/ 11C9)	2011/2016	065185	YTX20HL-BS■	—	—	—	—	
1300	XVS A Midnight Star (VP264)(11C5/ 11C7/ 11C9)	2011/2016	065209	YTX20L-BS■	068209	ESTX20L-BS■	—	—	
1300	XVS A Midnight Star (VP266)(1CS1/ 1CS5/ 1CS6)	2011/2016	0650202	GYZ20HL▲	—	—	—	—	
1300	XVS A Midnight Star (VP266)(1CS1/ 1CS5/ 1CS6)	2011/2016	065185	YTX20HL-BS■	—	—	—	—	
1300	XVS A Midnight Star (VP266)(1CS1/ 1CS5/ 1CS6)	2011/2016	065209	YTX20L-BS■	068209	ESTX20L-BS■	—	—	
1300	XVS CU Custom (VP361)(2SS)	2014/2016	0650202	GYZ20HL▲	—	—	—	—	
1300	XVS CU Custom (VP361)(2SS)	2014/2016	065185	YTX20HL-BS■	—	—	—	—	
1300	XVS CU Custom (VP361)(2SS)	2014/2016	065209	YTX20L-BS■	068209	ESTX20L-BS■	—	—	
1300	XVZ 13TD Venture Royale (3JT)	1986/1995	0652035	SY50-N18L-AT	—	—	—	—	
1300	XVZ 13TD Venture Royale (3JT)	1986/1995	065215	YTX24HL-BS■	—	—	—	—	
1300	XVZ Royal Star (4NK/ 4YP)	1996/2000	0650202	GYZ20HL▲	—	—	—	—	
1300	XVZ Royal Star (4NK/ 4YP)	1996/2000	065185	YTX20HL-BS■	—	—	—	—	
1300	XVZ Royal Star (4NK/ 4YP)	1996/2000	065209	YTX20L-BS■	068209	ESTX20L-BS■	—	—	
1300	XVZ Royal Star Boulevard (VP09)	1999/2005	0650202	GYZ20HL▲	—	—	—	—	
1300	XVZ Royal Star Boulevard (VP09)	1999/2005	065185	YTX20HL-BS■	—	—	—	—	
1300	XVZ Royal Star Boulevard (VP09)	1999/2005	065209	YTX20L-BS■	068209	ESTX20L-BS■	—	—	
1300	XVZ Royal Star Midnight	2003/2006	0650202	GYZ20HL▲	—	—	—	—	
1300	XVZ Royal Star Midnight	2003/2006	065185	YTX20HL-BS■	—	—	—	—	
1300	XVZ Royal Star Midnight	2003/2006	065209	YTX20L-BS■	068209	ESTX20L-BS■	—	—	
1300	XVZ Royal Star Venture (VP09)	1999/2006	0650202	GYZ20HL▲	—	—	—	—	
1300	XVZ Royal Star Venture (VP09)	1999/2006	065185	YTX20HL-BS■	—	—	—	—	
1300	XVZ Royal Star Venture (VP09)	1999/2006	065209	YTX20L-BS■	068209	ESTX20L-BS■	—	—	
1600	XV A Wild Star (5JA)	1999/2003	0650202	GYZ20HL▲	—	—	—	—	
1600	XV A Wild Star (5JA)	1999/2003	065185	YTX20HL-BS■	—	—	—	—	
1600	XV A Wild Star (5JA)	1999/2003	065209	YTX20L-BS■	068209	ESTX20L-BS■	—	—	
1600	XV Road Star Midnight	1999/2003	0650202	GYZ20HL▲	—	—	—	—	
1600	XV Road Star Midnight	1999/2003	065185	YTX20HL-BS■	—	—	—	—	
1600	XV Road Star Silverado	1999/2003	0650202	GYZ20HL▲	—	—	—	—	
1600	XV Road Star Silverado	1999/2003	065185	YTX20HL-BS■	—	—	—	—	
1700	MT01	2005/2011	065130	YT14B-BS▲	068130	EST14B-BS■	—	—	
1700	VMX V-MAX	2009/2016	065014	YTZ14S▲	—	—	—	—	
1700	XV PC Road Star Warrior	2002/2005	065130	YT14B-BS▲	068130	EST14B-BS■	—	—	
1700	XV Road Star	2004/2006	065130	YT14B-BS▲	068130	EST14B-BS■	—	—	
1900	XV Midnight Star	2006/2015	065130	YT14B-BS▲	068130	EST14B-BS■	—	—	

▲ - Factory Sealed / Attivata dalla Fabbrica ■ - con Acido a corredo ◇ - Non di produzione YUASA a completamento gamma

SynchroMATE



COD. **450143**

SynchroMate offre accurate misurazioni elettroniche di stato solido a un costo non troppo superiore rispetto a un set di sensori di rilevazione, ma senza il problema delle vibrazioni dei puntatori.

SynchroMate mostra la differenza di regolazioni di depressione di due carburatori distinti (o corpi farfallati per l'iniezione di carburante) su un unico motore con estrema precisione su un unico display orizzontale a 30 LED a risoluzione fissa "East-West". Al centro esatto, un LED lampeggiante, "Pa", indica che le pressioni di aspirazione comparate sono uguali entro i limiti di 0,5 cmHg (centimetri di mercurio).

CARATTERISTICHE PRINCIPALI:

Precisione e risoluzione fissa di 0,5 cmHg – come consigliato dai produttori di ricambi originali dell'industria motociclistica e marittima.

Un tachimetro integrato permette di visualizzare la velocità del motore in RPM (per impulsi di pressione, nessun pick-up aggiuntivo necessario).

Trasduttore di pressione MOTOROLA di grado medico/industriale.

Strumento approvato e consigliato da ROAN, club ufficiale dell'aeronautica Rotax. Disponibili kit speciali ROTAX.

CILINDRI	2 (o anche 4 con adattatore da 2 o 4 cilindri)
METODO	Confronta e mostra la differenza di pressione tra due carburatori/collettori a iniezione di carburante su un unico display.
DISPLAY/RISOLUZIONE	1 display da 30 LED ad alta luminosità, risoluzione a 0,5 cmHg.
INTERVALLO	<ul style="list-style-type: none"> • SYNC • RPM : 500 - 2000rpm • Vuoto assoluto (0-60 cmHg), determinazione accurata vuoto collettore.
ALIMENTAZIONE	12 VCC (11-15 VCC), l'alimentazione può derivare dalla batteria del veicolo.
TIPO/INCLUSO	Custodia strumenti in ABS con etichette resistenti in policarbonato, tubi in gomma resistenti al carburante e all'olio e involucro protettivo in gomma, presa di alimentazione CC con connettore della batteria da 200 cm e morsetti della batteria, istruzioni per l'uso (su strumenti e incluse), 2 adattatori di collegamento M5 e 2 M6 + splitter a T per scatto a vuoto del carburante, borsa di trasporto in nylon.
OPZIONI	da 2 o 4 cilindri, opzioni per cavo adattatore-prolunga, adattatori ROTAX, kit Rotax.



COD. **450145**

VacuumMate Allweather rappresenta lo standard industriale per una sincronizzazione veloce e accurata di 4 carburatori/valvole a farfalla per l'iniezione di carburante su motori a 2 o 4 tempi.

VacuumMate visualizza la pressione di ogni collettore di 4 carburatori distinti (o corpi farfallati per iniezione del carburante) su quattro barre a LED verticali (40 LED per barra) visibili anche alla luce del sole. Ideale per essere utilizzato sulle imbarcazioni e per usi esterni. Due modelli disponibili: VacuumMate Allweather ME (marine) con batteria ricaricabile al NiMH, caratteristiche indicate di seguito. VacuumMate Allweather WS (workshop), alimentato dalla batteria del veicolo.

CARATTERISTICHE PRINCIPALI:

Precisione e risoluzione fissa da 0,5 cmHg – come consigliato dai maggiori produttori di ricambi originali dell'industria motociclistica e marittima.

Un tachimetro integrato permette di visualizzare la velocità del motore in RPM (per impulsi di pressione, nessun pick-up aggiuntivo necessario).

Modalità "DYNamic" per la risoluzione dei problemi e la scarsa sincronizzazione del motore.

4 Trasduttori di pressione MOTOROLA di grado medico/industriale.

Strumento approvato e consigliato da Mercury, Honda, Yamaha.

CILINDRI	4 (o anche 6 con adattatore da 4 o 6 cilindri)
METODO	Confronta e mostra la singola pressione di 4 carburatori/collettori a iniezione di carburante.
DISPLAY/RISOLUZIONE	4 display da 40 LED ad alta luminosità, risoluzione fissa a 0,5 cmHg.
INTERVALLO	<ul style="list-style-type: none"> • SYNC : intervalli da 5-25 cmHg, 20-40 cmHg, 35-55 cmHg. • RPM : intervallo da 500-2.500 rpm, selettore 2/4 tempi. • Modalità "DYNamic" per la risoluzione dei problemi della tenuta della valvola. • Interruttore ON/OFF
ALIMENTAZIONE	Batteria da 7,2 V NiMH che offre 6 ore di autonomia, ricaricabile da 12 VCC (11-15 VCC), l'alimentazione può derivare dalla batteria del veicolo.
TIPO/INCLUSO	Custodia composita resistente agli urti e impermeabile in poliuretano stampato composito e policarbonato con etichette resistenti in policarbonato e interruttori in gomma sigillanti e con protezioni, tubi in gomma resistenti al carburante e all'olio, presa di alimentazione CC con connettore della batteria da 200 cm e morsetti della batteria, 4 adattatori di collegamento flexi-rigidi M5 e 4 adattatori di collegamento flexi-rigidi M6, splitter a T per scatto di carburante, borsa di trasporto in nylon, istruzioni per l'uso.
OPZIONI	adattatore da 4 o 6 cilindri.

COD. **450149** - Kit Opzionale VACUUMMATE per 6 Cilindri



COD. **450140**

Strumento per la risoluzione dei problemi dei sistemi di accensione basato sul confronto di due diversi segnali in un unico cilindro.

Il tester di accensione compatto a doppio display e tensione di picco che permette di rilevare i problemi in tutti i tipi di sistemi di accensione a scintilla in modo facile, sicuro e veloce.

I segnali di accensione sono impulsi di energia veloci e ad alta tensione in grado di danneggiare anche un multimetro digitale in buono stato, mentre IgnitionMate è stato appositamente progettato per misurare sia i segnali di accensione primari che quelli secondari su un indicatore grafico di valori visualizzato su un luminoso display LED.

CARATTERISTICHE PRINCIPALI:

Diversi tipi di sistemi di accensione (CA-CDI, CC-CDI, transistor, magnetici, bobina e "punti") hanno gli stessi componenti di base, quindi i segnali misurati sono generalmente simili nella natura e nella grandezza.

Non è necessario smontare i componenti di accensione. (Questo permette di evitare l'introduzione accidentale, o la correzione, dei contatti deboli presenti nel sistema, che potrebbero ulteriormente confondere e ritardare la soluzione dei problemi non ancora individuati).

Possono essere confrontati due segnali dallo stesso cilindro, incluso:

Scale secondarie di alta tensione/picchi da 10, 20, 40 kV – usare la pinza a induzione per misurare l'alta tensione tra la bobina d'accensione e la candela.

Scala di corrente di **SCINTILLA** per misurare la consistenza del segnale di corrente ad alta tensione per determinare le mancate accensioni.

Scale di tensione primaria/di picco da 10, 40 o 400 Vpk – usare i cavi tester in silicone ROSSI e NERI per misurare i segnali primari tra l'unità di controllo dell'accensione e il dispositivo di alimentazione (batteria o bobina di carica), sincronizzazione pick-up (bobina a impulsi o sensore corsia), bobina d'accensione e switch (chiave, stop di emergenza, piedistallo, regolatore).

Lo strumento per la risoluzione dei problemi dei sistemi di accensione più raccomandato dall'industria dei veicoli sportivi.

CILINDRI	1 (due segnali).
METODO	Confronto di due diversi segnali in un unico cilindro.
DISPLAY/RISOLUZIONE	<p>Display sinistro: Selezione tra 20 kV e SCINTILLA. Regolazione della sensibilità della SCINTILLA.</p> <p>Display destro: Selezione tensione primaria 10, 40 o 400 Vpk. Selezione tensione secondaria 10, 20 o 40 kV.</p> <p>Polarità tensione in kV: le bobine a uscita singola hanno segnali negativi e le bobine a uscita doppia hanno segnali positivi e negativi.</p> <p>ALIMENTAZIONE ON/OFF incluso "spegnimento automatico" se non viene misurato nessun segnale.</p>
ALIMENTAZIONE	Batteria ricaricabile da 7,2 V NiMH che offre 6 ore di autonomia, alimentazione esterna da 12 VCC (11-15 VCC).
TIPO/INCLUSO	Il kit standard include lo strumento con una resistente custodia protettiva in gomma, una pinza a induzione con cavo di candela al piombo silicio, adattatore per bobina integrata, set di cavi test siliconici con morsetti coccodrillo isolati, sonde concave Probulator, cavo di alimentazione 12 VCC da 200 cm, un manuale di istruzioni e una guida rapida, il tutto in una borsa di trasporto.



COD. **450191**

Caricabatterie professionale con recupero di batteria rivolto al settore degli sport motoristici e a quello dei motori di piccola cilindrata da 12 V. Il centro per la cura delle batterie raccomandato dai produttori di ricambi originali per la corretta attivazione di batterie NUOVE e il ripristino, la carica e il test di batterie trascurate e solfatate/a bassa tensione.

CARATTERISTICHE PRINCIPALI:

NUOVA modalità – Carica di attivazione di solo 1 ora per le nuove batterie* che hanno ricevuto acido poco prima della carica, come le batterie STD con liquido e tappi di riempimento removibili e le batterie AGM-MF “caricate a secco” che sono consegnate con diversi pacchi di acidi personalizzati.

Modalità 2 A/4 A – tappa di carica max. di 12 ore per diagnosi, ripristino, carica, test di batterie solfatate a bassa tensione. Adatto per ricaricare tutte le batterie comprese le batterie sigillate AGM attivate in fabbrica (ad es. Yuasa YTZ, GYZ) prima della vendita.

Include locandina con istruzioni su come preparare e caricare le batterie.

SICUREZZA: nessun rischio di sovraccarico. Assenza di scintille Sicuro per il mantenimento della batteria nel lungo termine. Spegnimento automatico in caso di cortocircuito o disconnessione della batteria 2 anni di garanzia.

CORRENTE DI CARICA	max. 4 A, controllo Ampmatic (max. 2 A quando è selezionato 2 A).
USO	al chiuso/in laboratorio (temperatura minima: -20 °C).
RECUPERO	accensione a bassa tensione a 1,8 V + recupero desolfatazione a 2 fasi.
IDEALE PER	STD AGM GEL 2 – 40Ah
INGRESSO	Disponibile a 110-120 VCA/220-240 VCA 50-60 Hz, con interruttore ON/OFF e protezione del fusibile sostituibile.
TIPO	Custodia industriale ventilata con occhielli di montaggio a parete, connettore di alimentazione da 180 cm CA e connettore di carica da 180 cm che termina nel connettore SAE. 1 set standard morsetto della batteria incluso.



COD. **450192**

Caricabatterie professionale automatico a due uscite rivolto ai settori dei motori di piccola cilindrata, degli sport motoristici e del tempo libero. Il centro per la cura delle batterie a 2 uscite raccomandato dai produttori di ricambi originali per il ripristino, la carica e il test di tutte le batterie da 12 V, incluse le batterie trascurate e solfatate/a bassa tensione.

CARATTERISTICHE PRINCIPALI:

Interamente automatico – nessuna selezione da fare, nessuna conoscenza della batteria necessaria. Connetti 2 batterie da 12 V e lascia che il caricabatterie faccia tutto il resto.

Corrente di carica Ampmatic 2 A – la corrente sarà regolata in base alla dimensione e stato della batteria, le batterie più piccole riceveranno meno corrente, le batterie solfatate inizieranno a bassa corrente e poi tale sarà aumentata con il ripristino della batteria stessa.

USCITE/STAZIONI DI CARICA	2 (ogni uscita funziona in modo indipendente)
CORRENTE DI CARICA (PER USCITA)	max. 2 A, controllo Ampmatic .
USO	al chiuso/in laboratorio (temperatura minima: -20 °C).
RECUPERO	accensione a bassa tensione a 1,8 V + recupero desolfatazione a 2 fasi.
IDEALE PER	STD AGM GEL batterie 12 V da 2 Ah.
INGRESSO	Disponibile a 110-120 VCA/220-240 VCA 50-60 Hz, con interruttore ON/OFF e protezione del fusibile sostituibile.
TIPO	Custodia industriale ventilata da tavolo con occhielli di montaggio a parete integrati, connettore di alimentazione da 180 cm CA e 2 connettori di carica da 180 cm che terminano nel connettore SAE. 2 set standard morsetto della batteria inclusi.



COD. **450150**

Caricabatterie professionale a quattro uscite con recupero di batteria rivolto al settore degli sport motoristici e quello dei motori di piccola cilindrata da 12.

Il centro per la cura delle batterie a 4 uscite raccomandato dai produttori di ricambi originali per la corretta attivazione di batterie NUOVE e il ripristino, la carica e il test di batterie trascurate e solfatate/a bassa tensione.

CARATTERISTICHE PRINCIPALI:

NUOVA modalità – Carica di attivazione di solo 1 ora per le nuove batterie* che hanno ricevuto acido poco prima della carica, come le batterie STD con liquido e tappi di riempimento removibili e le batterie AGM-MF “caricate a secco” che sono consegnate con diversi pacchi di acidi personalizzati.

Modalità 2 A/4 A – tappa di carica max. di 12 ore per diagnosi, ripristino, carica, test di batterie solfatate a bassa tensione. Adatto per ricaricare tutte le batterie comprese le batterie sigillate AGM attivate in fabbrica (ad es. Yuasa YTZ, GYZ) prima della vendita.

Include locandina con istruzioni su come preparare e caricare le batterie.

USCITE/STAZIONI DI CARICA	4 (ogni uscita funziona in modo indipendente)
CORRENTE DI CARICA (PER USCITA)	max. 4 A, controllo Ampmatic . (max. 2 A quando è selezionato 2 A).
USO	al chiuso/in laboratorio (temperatura minima: -20 °C).
RECUPERO	accensione a bassa tensione a 1,8 V + recupero desolfatazione a 2 fasi.
IDEALE PER	STD AGM GEL batterie 12 V da 2-40 Ah
INGRESSO	Disponibile a 110-120 VCA/220-240 VCA 50-60 Hz, con interruttore ON/OFF e protezione del fusibile sostituibile.
TIPO	Custodia industriale ventilata da tavolo con opzione di montaggio a parete (TS-218), connettore di alimentazione da 180 cm CA e 4 connettori di carica da 180 cm che terminano nel connettore SAE. 4 set standard morsetto della batteria inclusi.



COD. **450180**

Caricabatterie professionale a otto uscite con recupero di batteria rivolto ai settori degli sport motoristici, dei motori di piccola cilindrata e per batterie a ciclo profondo da 6 e 12 V

Il centro per la cura delle batterie a 8 uscite raccomandato dai produttori di ricambi originali per il ripristino, la carica e il test di tutte le batterie da 6 V e 12 V, incluse le batterie trascurate e solfatate/a bassa tensione

CARATTERISTICHE PRINCIPALI:

Tensione di carica selezionabile – Selezionare tensione batteria da 6 V o 12 V per ogni uscita.

Interamente automatico – una volta che è stata selezionata la tensione, non è necessaria nessuna conoscenza ulteriore della batteria. Collega fino a 8 batterie da 6 e 12 V e lascia che il caricabatterie faccia tutto il resto!

USCITE/STAZIONI DI CARICA	8 (ogni uscita funziona in modo indipendente)
CORRENTE DI CARICA (PER USCITA)	1 A
USO	al chiuso/in laboratorio (temperatura minima: -20 °C).
RECUPERO	accensione a bassa tensione a 1,8 V + recupero desolfatazione monofase.
IDEALE PER	STD AGM GEL batterie 6 V o 12 V da 2 Ah
INGRESSO	Disponibile a 110-120 VCA/220-240 VCA 50-60 Hz, con interruttore ON/ OFF e protezione del fusibile sostituibile.
TIPO	Custodia industriale ventilata da tavolo con opzione di montaggio a parete (TS-218), connettore di alimentazione da 8 cm CA e 8 connettori di carica da 180 cm che terminano nel connettore SAE. 8 set standard morsetto della batteria inclusi.

ACCUMATE PRO

12V/24V



COD. **450178**

Caricabatterie professionale automatico da 12 V/24 V rivolto ai settori automobilistico, marittimo e del tempo libero ideale per batterie a ciclo profondo e di avviamento.

AccuMate PRO con il suo programma a 4 fasi è ideale per batterie a ciclo profondo e di avviamento. Disponibile a 12/24 V (7 A/3,5 A). Completamente automatico, con caratteristiche di sicurezza totalmente elettroniche e mantenimento a lungo termine "Connect & Forget".

CARATTERISTICHE PRINCIPALI:

Approvato dai produttori di ricambi originali nell'industria automobilistica e marina

Spazio di immagazzinamento cavi, facile montaggio a parete

Indicazioni LED chiare e molto visibili

CORRENTE DI CARICA	3,5 A (24 V)/7 A (12 V) (temperatura compensata)
USO	al chiuso (temperatura minima: -20 °C).
RECUPERO	accensione a bassa tensione (3 V) per batterie da 12, 16 o 24 V.
IDEALE PER	STD AGM GEL batterie piombo-acido, per ciclo di avviamento e ciclo profondo da 12 V e 24 V da 17 Ah (12 V) o 9 Ah (24 V) fino a 300 Ah.
INGRESSO	Europa: 220-240 V 50-60 Hz America del Nord: 110-120 V 50-60 Hz.
TIPO	custodia standard (ventilata) con connettore di alimentazione da 180 cm CA e connettore di carica che termina nel connettore SAE. Set standard morsetto della batteria e prolunga da 180 cm inclusi

ACCUMATE PRO

12V/4A



COD. **450170**

Caricabatterie professionale automatico da 12 V/4 A rivolto ai settori automobilistico, marittimo e del tempo libero ideale per batterie a ciclo profondo e di avviamento.

AccuMate PRO con il suo programma a 4 fasi è ideale per batterie a ciclo profondo e di avviamento. Completamente automatico, con caratteristiche di sicurezza totalmente elettroniche e mantenimento a lungo termine "Connect & Forget".

CARATTERISTICHE PRINCIPALI:

Approvato dai produttori di ricambi originali nell'industria automobilistica e marina

Spazio di immagazzinamento cavi, facile montaggio a parete

Indicazioni LED chiare e molto visibili

- **Carica batteria automatico compatto con algoritmo di carica interattivo per batterie d'avviamento 12V piombo/acido di capienza minima 10Ah.**
- **Adatto per batterie MF/AGM/VRLA, STD, GEL per auto, moto, ATV/quad, imbarcazioni, motoslitte e agricolo/industriale.**
- **Di facile utilizzo:** collegare alla batteria ed alla alimentazione di rete. Il resto è completamente automatico.
- **Sensore di temperatura ambientale:** per variare i parametri della tensione in uscita ed è ideale, oltre che alla carica rapida, per la manutenzione a lungo termine delle batterie.
- **Dimensione:** 140 x 160 x 150 mm. manico incluso.
- **Corrente di carica:** 4A.
- **Alimentazione:** 220/240V-50Hz.
- **Non utilizzabile per batterie al Nickel, NiCd, NC, NiMH, Litio, Li-Ion, Li-Poly, Li-Po, non ricaricabili e pile a secco.**

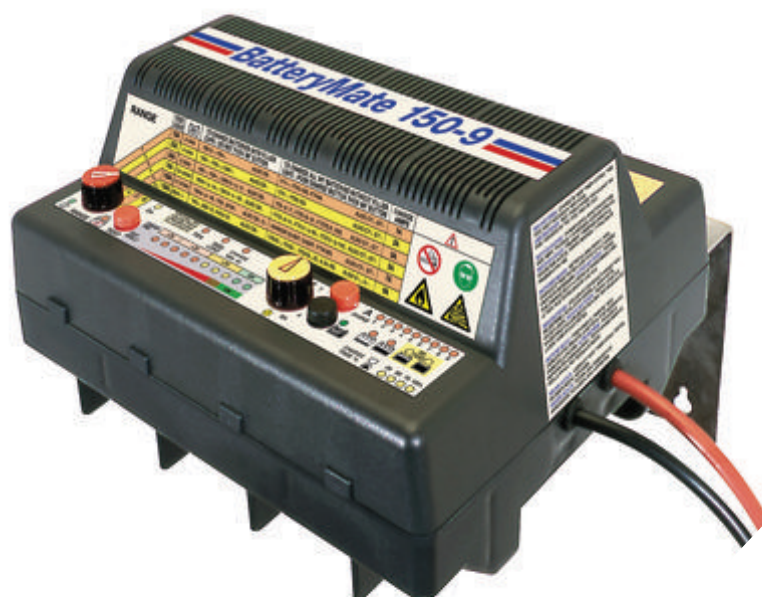

COD. **450190**

Test dinamico selezionabile, attivatore di batterie NUOVE, desolfatore e caricabatterie per batterie trascurate.
Il tester dinamico, desolfatore e caricabatterie raccomandato dai maggiori produttori di pezzi di ricambio originali per sport motorizzati per tutti i tipi di batterie piombo-acido da 12 V. BatteryMate recupera batterie da 25 anni!

CARATTERISTICHE PRINCIPALI:

Attivazione rapida di nuova batteria – Carica di attivazione di 30 minuti per le nuove batterie che hanno ricevuto acido poco prima della carica, come le batterie STD con liquido e tappi di riempimento removibili e le batterie AGM-MF “caricate a secco” che sono consegnate con diversi pacchi di acidi personalizzati.

Efficace tester dinamico selezionabile da 15 A a 150 A – Testa in modo automatico amp di avviamento della batteria fino a 330 CCA. Un test da 3 secondi simula il normale avviamento del motore.; Un test da 15 secondi verifica lo stato di salute della batteria.

Algoritmo di carica specifico per sport motorizzati – metodo di carica a 4 fasi per il recupero di qualsiasi batteria da 12 V. La modalità MF è adatta a batterie AGM “caricate a secco” fino a 16,9 V.

Carica a temperatura controllata – La corrente di carica viene regolata in base alla temperatura ambiente. (-4 mV/°C/cella sopra/sotto 20 °C).

Accurata sensibilità di tensione – I connettori di carica hanno fili integrati per misurare l'esatta tensione della batteria.

Facile da usare – Selettore a 6 posizioni che consente di selezionare il test e la corrente di carica adeguati per la batteria collegata. Selezionare TEST e poi il tempo di carica massimo in base al risultato, premere il pulsante CARICA. Il programma completa la carica in modo automatico e quindi testa la batteria.

CORRENTE DI CARICA	max. 9 A, selezione da 1, 2, 3, 5, 7, 9 A.
CORRENTE DI TEST	max. 150 A, selezione da 15, 35, 50, 70, 100, 150 A.
USO	al chiuso/in laboratorio (temperatura minima: -20 °C).
RECUPERO	accensione a bassa tensione a 1 V + recupero desolfatazione a potenza elevata.
IDEALE PER	STD AGM GEL batterie 12 V da 2-40 Ah
INGRESSO	Disponibile a 110-120 VCA/220-240 VCA 50-60 Hz, con interruttore ON/OFF e protezione del fusibile sostituibile.
TIPO	Custodia industriale ventilata da tavolo con opzione di montaggio a parete (TS-218), connettore di alimentazione da 180 cm CA e 1 paio di connettori per elevata corrente di carica da 180 cm che terminano in morsetti della batteria per uso intensivo.



COD. **4501951**

Tester dello stato di carica della batteria da 12 V, delle prestazioni all'avvio e del sistema di carica del veicolo.

L'ultimissimo tester tascabile delle prestazioni della batteria e della tensione dell'alternatore su veicolo che ogni tecnico della manutenzione o esperto di motori dovrebbe avere.

CARATTERISTICHE PRINCIPALI:

Facile da usare! Collegare i morsetti alla batteria, o collegarli a un connettore SAE della batteria, poi:

- Verificare il livello di carica della batteria. Una batteria con poca carica avvia male il motore.
- Avviamento motore. TEST OptiMate registra e indica (per 20 sec.) le tensioni di avviamento più basse.
- Con il motore in funzione, verificare la tensione di carica proveniente dall'alternatore e dal regolatore di tensione.

CONSIGLIO: una tensione di carica bassa porta a scarse prestazioni della batteria. Una tensione di carica troppo alta causa un'ebollizione eccessiva e può perfino danneggiare una batteria piombo-acido. Una tensione di carica troppo alta CAUSA DANNI PERMANENTI a una batteria di avviamento LiFePO4!

• **Precisione del microprocessore.**

• **Istruzioni di facile impiego sul pannello posteriore del tester.**

• **Connettore di alimentazione SAE standard a 2 pin.**

• **Set morsetto della batteria da 100 cm.**

• **Completamente sigillata.**



COD. **4501952**

Tester dello stato della carica per tutte le batterie piombo-acido da 12 V e al litio da 12,8 V-13,2 V.

La scelta intelligente per i negozi di batterie. Controllare le nuove batterie prima di venderle o testare quelle restituite!

AccuMate PRO con il suo programma a 4 fasi è ideale per batterie a ciclo profondo e di avviamento. Disponibile a 12/24 V (7 A/3,5 A). Completamente automatico, con caratteristiche di sicurezza totalmente elettroniche e mantenimento a lungo termine "Connect & Forget"

Facile da usare! Collegare i morsetti alla batteria e leggere il risultato. Il microprocessore del tester di batteria OptiMate assorbe una minima quantità di energia dalla batteria stessa al fine di stabilire e visualizzare lo stato della batteria. Testa tutte le batterie piombo-acido da 12 V e quelle al litio da 12,8 V e 13,2 V LiFePO4 (LFP) I risultati sul monitor possono essere usati per fornire informazioni al cliente.

- Risultati dello stato della carica in VOLT e %, 3 diverse strisce per le batterie serie STD, AGM/GEL e LiFePO4.
- Istruzioni di facile impiego sul pannello posteriore del tester.
- Connettore di alimentazione SAE standard a 2 pin.
- Set morsetto della batteria da 100 cm.
- Indicatore lampeggiante di batteria scarica.



COD. **450193**

Tester di batterie 12V digitale per motoveicoli, quads e PWC.

TestMate fornisce in pochi secondi una valutazione professionale dello stato generale e di carica, nonché della capacità CCA di una batteria da 12 V. Compatto e leggero, può essere utilizzato in laboratorio o presso il banco vendita.

Modello SPORT per motocicli e batterie simili a partire da 2-35 Ah.

- **Tester di batteria da 12 V professionale ed economico.**
- **Scegliere il tipo di batteria e Ah/CCA, quindi TEST.**
- **Adatto a tutte le tipologie di batteria (STD, AGM, GEL).**
- **Risultato disponibile in pochi secondi.**
- **Robusto, ideale per l'utilizzo in officina.**

Optimate 1

DUO



- | | | | |
|--|-----------------------------------|---------------------------------|--------------------------------------|
| 1
Accensione
a bassa
tensione 4V | 2
CARICA
controllata | 3
OTTIMIZZA-
ZIONE | 4
OptiMate
manutenzione |
|--|-----------------------------------|---------------------------------|--------------------------------------|



OPTIMATE 1 DUO

Cod. **450152**

Caricatore autodiagnostico a 4 fasi per batterie 12 V piombo-acido e 12.8V Lithium (LiFeP04) da 2Ah-20Ah.

OptiMate 1 DUO, un vero caricabatterie e manutentore automatico da "collegare e dimenticare" che ottimizza le prestazioni delle moderne batterie di veicolo sportivo motorizzato. È adatto per batterie 12V piombo-acido (STD, AGM, GEL) e 12.8-13.2V Lithium (LiFeP04) di tutti i tipi con capacità tra 2 e 20Ah.

Caratteristiche speciale dell'Optimate 1 DUO

- **Recupero, tramite sistema elettronico a impulsi di passa tensione**, per le batterie scaricate totalmente ($\geq 4V$).
- **Erogazione di carica PRINCIPALE e DI OTTIMIZZAZIONE** per la carica ottimale di ogni batteria.
- **Manutenzione OptiMate "24-7-365"** - La carica fluttuante interattiva mantiene qualsiasi tipo di batteria senza sovraccaricarla. Ideale per veicoli che sono usati raramente o stagionalmente.

CORRENTE DI CARICA: 0,6 A (corrente costante),

USO: al chiuso (temperatura minima: $-20^{\circ}C$),

RECUPERO: accensione a bassa tensione (4 V),

IDEALE PER: batterie STD, AGM, GEL 12 V e Lithium (LiFeP04) da 2-20 Ah.

INGRESSO: universale (100-240 V 50-60 Hz), alta efficienza (presente nell'elenco CEC), completamente ermetico.

TIPO: custodia resistente alle intemperie con occhielli di montaggio a parete con connettore di alimentazione da 180 cm CA e connettore di carica da 180 cm che termina nel connettore SAE. Connettore della batteria resistente alle intemperie e set standard morsetto della batteria inclusi.

SIUREZZA: nessun rischio di sovraccarico. Completamente sicuro per elettronica, automobilistica. Assenza di scintille. Sicuro per il mantenimento della batteria nel lungo termine. Spegnimento automatico in caso di cortocircuito o disconnessione della batteria. Garanzia di sostituzione limitata di tre anni.

Optimate 1 GLOBAL



- 1 Accensione a bassa tensione 4V
- 2 CARICA controllata
- 3 OTTIMIZZAZIONE
- 4 OptiMate manutenzione

OPTIMATE 1 GLOBAL

Cod. **4501541**



2-30Ah



Caricatore-mantenitore quattro fasi 12 V 0,6 A

Mantenimento della batteria da 12 V con un ottimo rapporto qualità/prezzo.

OptiMate 1 permette di avere un caricamento preciso controllato da un microprocessore e un mantenimento a lungo termine. Per il mantenimento di qualunque tipo di batteria piombo-acido a 12 volt senza sovraccaricarle, a celle umide/con tappo di riempimento, sigillato AGM (MF) o GEL. Ideale per veicoli che sono usati raramente o stagionalmente, oppure tenuti in magazzino. Il programma di mantenimento di OptiMate eroga solo la corrente di cui la batteria ha bisogno, senza sovraccaricarla o sottocaricarla.

CORRENTE DI CARICA: 0,6 A (corrente costante),

USO: al chiuso (temperatura minima: -20 °C),

RECUPERO: accensione a bassa tensione (4 V),

IDEALE PER: batterie STD, AGM e GEL 12 V da 2-30 Ah,

INGRESSO: universale (100-240 V 50-60 Hz), alta efficienza (presente nell'elenco CEC), completamente ermetico.

TIPO: custodia a innesto resistente alla polvere con connettore di carica da 370 cm che termina nel connettore SAE; connettore della batteria resistente alle intemperie, e piccolo morsetto della batteria inclusi.

SICUREZZA: *nessun rischio di sovraccarico. Completamente sicuro per elettronica, automobilistica. Assenza di scintille. Sicuro per il mantenimento della batteria nel lungo termine. Spegnimento automatico in caso di cortocircuito o disconnessione della batteria. Garanzia di sostituzione limitata di tre anni.*

Optimate 2



- 1 Accensione a bassa tensione 4V
- 2 CARICA controllata
- 3 OTTIMIZZAZIONE
- 4 OptiMate manutenzione

OPTIMATE 2

Cod. **450155**



3-96Ah



Caricatore-mantenitore quattro fasi 12 V 0,8 A

Mantenimento della batteria da 12 V avanzato!

OptiMate 2 prolunga la durata e migliora le prestazioni di una batteria a 12 V, montata in un veicolo/imbarcazione o in un sistema a batteria non utilizzato quotidianamente, anche a temperature sottozero. OptiMate 2 rileva lo stato della batteria, la ricarica e quindi la mantiene pronta al 100% e fornisce alimentazione all'allarme antifurto, al monitor, al computer a bordo ecc. Il programma di mantenimento OptiMate eroga solo ciò di cui la batteria ha bisogno, senza sovraccaricarla o sottocaricarla.

CORRENTE DI CARICA: 0,8 A (corrente costante)

USO: al chiuso/all'aperto (temperatura minima: -20 °C).

RECUPERO: accensione a bassa tensione (2 V)

IDEALE PER: batterie STD, AGM e GEL 12 V da 3-96 Ah

INGRESSO: universale (100-240 V 50-60 Hz), alta efficienza (presente nell'elenco CEC), completamente ermetico.

TIPO: custodia resistente alle intemperie con occhielli di montaggio a parete con connettore di alimentazione da 180 cm CA e connettore di carica da 180 cm che termina nel connettore SAE. Connettore della batteria resistente alle intemperie e set standard morsetto della batteria inclusi.

SICUREZZA: *nessun rischio di sovraccarico. Completamente sicuro per elettronica automobilistica. Assenza di scintille. Sicuro per il mantenimento della batteria nel lungo termine. Spegnimento automatico in caso di cortocircuito o disconnessione della batteria. Garanzia di sostituzione limitata di tre anni.*

OptiMATE 3



- 1 Accensione a bassa tensione 2V
- 2 RECUPERO Turbo
- 3 RECUPERO Impulsi
- 4 CARICA controllata
- 5 OTTIMIZZAZIONE
- 6 TEST dopo la CARICA
- 7 OptiMate manutenzione

OPTIMATE 3

Cod. **4501351**



3-50Ah



Caricabatterie con recupero di batteria, manutentore e tester sette fasi 12V 0,8 A

Il caricabatterie più AFFIDABILE negli sport motorizzati!

OptiMate 3, lo strumento tutto-in-uno per la cura delle batterie da 12 V a casa propria. Fa la diagnosi, recupera, carica, testa ed esegue una manutenzione perfetta in modo del tutto automatico. L'ultima versione di OptiMate 3 mantiene tutte le caratteristiche semplici da usare degli oltre 2 milioni di OptiMate prodotti dal 1995, ma ora è più leggero e più efficiente che mai. OptiMate 3 recupera le batterie solfatate e poi le testa dopo la ricarica. Il programma di mantenimento eroga solo la corrente di cui la batteria ha bisogno, senza sovraccaricarla o sottocaricarla.

CORRENTE DI CARICA: 0,8 A (corrente costante)

USO: al chiuso/all'aperto (temperatura minima: -20 °C).

RECUPERO: accensione a bassa tensione a 2 V + recupero desolfatazione a 2 fasi.

IDEALE PER: batterie STD, AGM e GEL 12 V da 3-50 Ah.

INGRESSO: universale (100-240 V 50-60 Hz), alta efficienza (presente nell'elenco CEC), completamente ermetico.

TIPO: custodia resistente alle intemperie con occhielli di montaggio a parete con connettore di alimentazione da 180 cm CA e connettore di carica da 180 cm che termina nel connettore SAE. Connettore della batteria resistente alle intemperie e set standard morsetto della batteria inclusi.

SICUREZZA: *nessun rischio di sovraccarico. Completamente sicuro per elettronica automobilistica. Assenza di scintille Sicuro per il mantenimento della batteria nel lungo termine. Spegnimento automatico in caso di cortocircuito o disconnessione della batteria Garanzia di sostituzione limitata di tre anni.*

OptiMATE 4 dual program



- 1 CAN-bus 'Risveglio' a impulsi
- 2 CAN-bus controllo a bassa tensione
- 3 TEST prima della CARICA
- 4 RECUPERO Impulsi
- 5 CARICA controllata
- 6 CAN-bus OTTIMIZZAZIONE
- 7 CAN-bus TEST dopo la CARICA
- 8 CAN-bus OptiMate manutenzione

OPTIMATE 4 CAN-BUS ED.(1A)

Cod. **4501653**

OPT. 4 CAN-BUS ED.(0.8A)

Cod. **4501652**



DEEP CYCLE

3-50Ah



Caricabatterie con recupero di batteria, manutentore e tester otto/nove fasi 12 V 1 A

Il caricabatterie più AVANZATO e AFFIDABILE negli sport motorizzati - versione CAN-bus.

OptiMate 4 Dual Program, versione CAN-bus, include due programmi di carica; il programma 1 è per la carica normale diretta di una batteria, il programma 2 consente una carica sicura e senza sorveglianza attraverso una presa da 12 V controllata dal **bus CAN di una moto BMW**. La versione CAN-bus di OptiMate 4 viene consegnata con il programma 2 preselezionato.

Caratteristiche speciali nel programma bus CAN:

- **Attivazione automatica SENZA CHIAVE e mantenimento continuo fino allo scollegamento del caricabatterie.**
- **Desolfatazione a impulsi a bassa tensione sicura.**

CORRENTE DI CARICA: 1 A (corrente costante)

USO: al chiuso/all'aperto (temperatura minima: -40 °C).

RECUPERO: Accensione a bassa tensione a 0,5 V + recupero desolfatazione a 2 fasi^ (^recupero dell'impulso a bassa tensione monofase durante la modalità CAN-bus).

IDEALE PER: batterie STD, AGM e GEL 12 V da 3-50 Ah.

INGRESSO: universale (100-240 V 50-60 Hz), alta efficienza (presente nell'elenco CEC), completamente ermetico.

TIPO: custodia resistente alle intemperie con occhielli di montaggio a parete con connettore di alimentazione da 180 cm CA e connettore di carica da 180 cm che termina nel connettore SAE. Adattatore-prolunga, spina 180° MOTO e set standard morsetto della batteria inclusi.

SICUREZZA: *nessun rischio di sovraccarico. Completamente sicuro per elettronica automobilistica. Assenza di scintille Sicuro per il mantenimento della batteria nel lungo termine. Spegnimento automatico in caso di cortocircuito o disconnessione della batteria Garanzia di sostituzione limitata di tre anni.*

OptiMATE 4 dual program

INDOOR/
OUTDOOR



OPTIMATE 4 DUAL PROGRAM (1A)

Cod. **450163**

OPT. 4 DUAL PROG. (0.8A)

Cod. **4501651**



3 - 50Ah

AGM

GEL

STD

Caricabatterie con recupero di batteria, manutentore e tester nove fasi 12 V 1 A

Il caricabatterie più AVANZATO e AFFIDABILE negli sport motorizzati!

OptiMate 4 Dual Program include due programmi di carica: il programma 1 è per la carica diretta di una batteria, il programma 2 consente una carica sicura e senza sorveglianza attraverso una presa da 12 V controllata del CAN-bus di una moto BMW. OptiMate 4 Dual Program effettua un test prima e dopo la ricarica e può recuperare una batteria fuori uso da un minimo di 0,5 V.

Caratteristiche speciali nel programma bus CAN:

- **Attivazione automatica SENZA CHIAVE e mantenimento continuo fino allo scollegamento del caricabatterie.**
- **Desolfatazione a impulsi a bassa tensione sicura.**

CORRENTE DI CARICA: 1 A (corrente costante)

USO: al chiuso/all'aperto (temperatura minima: -40 °C).

RECUPERO: Accensione a bassa tensione a 0,5 V + recupero desolfatazione a 2 fasi ^ (^recupero dell'impulso a bassa tensione monofase durante la modalità CAN-bus).

IDEALE PER: batterie STD, AGM e GEL 12 V da 3-50 Ah.

INGRESSO: universale (100-240 V 50-60 Hz), alta efficienza (presente nell'elenco CEC), completamente ermetico.

TIPO: custodia resistente alle intemperie con occhielli di montaggio a parete con connettore di alimentazione da 180 cm CA e connettore di carica da 180 cm che termina nel connettore SAE. Connettore della batteria resistente alle intemperie e set standard morsetto della batteria inclusi.

SICUREZZA: *nessun rischio di sovraccarico. Completamente sicuro per elettronica automobilistica. Assenza di scintille Sicuro per il mantenimento della batteria nel lungo termine. Spegnimento automatico in caso di cortocircuito o disconnessione della batteria Garanzia di sostituzione limitata di tre anni.*

OptiMATE 5 start/stop

INDOOR/
OUTDOOR



OPTIMATE 5 START/STOP

Cod. **450167**



15 - 192Ah

AGM

EFB

GEL

STD

Caricabatterie con recupero di batteria, manutentore e tester sei fasi 12 V 4 A

Ideale per la cura per START/STOP & applicazioni ciclo profondo di potenza da 12 V.

OptiMate 5 recupera le batterie da un minimo di 2 V e poi le ricarica e le mantiene, tutto automaticamente. Perfetto per il mantenimento per molti mesi di batterie piombo-acido da 12 V 15-192 Ah di tutte le dimensioni - ciclo profondo, settore automobilistico (anche per batterie EFB - sistemi start/stop), marino, motocicli, ecc.

CORRENTE DI CARICA: 4 A (corrente costante, temperatura compensata)

USO: al chiuso/all'aperto (temperatura minima: -20 °C).

RECUPERO: accensione a bassa tensione a 2 V + recupero desolfatazione monofase.

IDEALE PER: batterie EFB, STD, AGM e GEL 12 V da 15-192 Ah.

INGRESSO: universale (100-240 V 50-60 Hz), completamente ermetico.

TIPO: custodia resistente alle intemperie con occhielli di montaggio a parete con connettore di alimentazione da 180 cm CA e connettore di carica da 180 cm che termina nel connettore SAE. Connettore della batteria resistente alle intemperie e set standard morsetto della batteria inclusi.

SICUREZZA: *nessun rischio di sovraccarico. Completamente sicuro per elettronica automobilistica. Assenza di scintille Sicuro per il mantenimento della batteria nel lungo termine. Spegnimento automatico in caso di cortocircuito o disconnessione della batteria Garanzia di sostituzione limitata di tre anni.*





OptiMate 5
voltmatic

INDOOR/
OUTDOOR

GLOBAL INPUT
100V - 240V

- | | | | | | | | |
|---|---------------------------------------|------------------------|--------------------------|----------------------------|--------------------------|-----------------------------|-------------------------------|
| 1
Accensione
a bassa
tensione (1V) | 2
CARICA
Voltmatic
selezione | 3
RECUPERO
Turbo | 4
RECUPERO
Impulsi | 5
CARICA
controllata | 6
OTTIMIZZA-
ZIONE | 7
TEST dopo
la CARICA | 8
OptiMate
manutenzione |
|---|---------------------------------------|------------------------|--------------------------|----------------------------|--------------------------|-----------------------------|-------------------------------|

OPTIMATE 5 VOLT MATIC

Cod. **450168**



DEEP
CYCLE

8 - 120Ah

AGM GEL STD

Caricatore, Tester e Mantentore di batterie 12V 4/2,8A a 8 fasi/stadi

Cura avanzata delle batterie per sport/auto/imbarcazioni di potenza da 6 e 12 V.

OptiMate 5 VoltMatic è in grado di RECUPERARE E CARICARE tutte le batterie piombo-acido da 6 e 12 V. Basta semplicemente collegare il caricabatterie alla batteria, e il microprocessore VoltMatic automaticamente seleziona la tensione di carica corretta per la batteria da 6 V in qualunque condizione o per la batteria da 12 V in buono stato e poi procede alla ricarica.

Disponibile funzionamento manuale per batterie da 12 V con bassissima tensione. La corrente di carica viene regolata secondo le dimensioni e le condizioni della batteria collegata.

CORRENTE DI CARICA: 4 A (6 V)/2,8 A (12 V) (Ampmatic)

USO: al chiuso/all'aperto (temperatura minima: -20 °C).

RECUPERO: accensione a bassa tensione a 1 V + recupero desolfatazione a 2 fasi.

IDEALE PER: batterie STD, AGM e GEL da 6 e 12 V da 8-120 Ah (fino a 192 Ah per quella da 6 V).

INGRESSO: universale (100-240 V 50-60 Hz), alta efficienza (presente nell'elenco CEC), completamente ermetico.

TIPO: custodia resistente alle intemperie con occhielli di montaggio a parete con connettore di alimentazione da 180 cm CA e connettore di carica da 180 cm che termina nel connettore SAE. Connettore della batteria resistente alle intemperie e set standard morsetto della batteria inclusi.

SICUREZZA: nessun rischio di sovraccarico. Completamente sicuro per elettronica automobilistica. Assenza di scintille Sicuro per il mantenimento della batteria nel lungo termine. Spegnimento automatico in caso di cortocircuito o disconnessione della batteria Garanzia di sostituzione limitata di tre anni.



OptiMate 6
12V-24V

INDOOR/
OUTDOOR

40°

GLOBAL INPUT
100V - 240V

- | | | | | | | | |
|----------------------------------|-------------------------------|---------------------------------|--|----------------------------|--------------------------|-----------------------------|-------------------------------|
| 1
Selezione
della tensione | 2
Protezione
automatica | 3
TEST prima
della CARICA | 4
RECUPERO
impulsi bassa
tensione | 5
CARICA
controllata | 6
OTTIMIZZA-
ZIONE | 7
TEST dopo
la CARICA | 8
OptiMate
manutenzione |
|----------------------------------|-------------------------------|---------------------------------|--|----------------------------|--------------------------|-----------------------------|-------------------------------|

OPTIMATE 6 12V-24V

Cod. **450162**



DEEP
CYCLE



3-200Ah / (24) 1-100Ah

AGM EFB GEL STD

Caricabatterie con recupero di batteria, mantentore e tester 8 fasi 5A 12V / 2.5A 24V

Il caricabatterie completamente automatico più avanzato al mondo!

OptiMate 6 12V-24V è perfetto per batterie di avviamento e a ciclo profondo da 12 V e 24 V che richiedono una carica accurata a temperatura controllata e un mantenimento senza sorveglianza e in sicurezza a lungo termine.

CARATTERISTICHE SPECIALI: progettate per componenti elettronici sensibili: il programma di RECUPERO è stato progettato per un avvio SICURO completamente automatico e a basso voltaggio (a partire da 0,5 V) e per il recupero a IMPULSI di batterie molto scariche collegate a componenti elettronici molto sensibili, ad esempio quelli per velivoli leggeri o attrezzature industriali.

Protezione in caso di una errata selezione della tensione: se viene selezionata una batteria a 24 V ma ne viene collegata una da 12 V OptiMate 6 12-24 V avviserà l'utente che è stata rilevata una bassa tensione e quindi non effettuerà la carica. Prima che si attivi la modalità di RECUPERO, l'UTENTE dovrà confermare che la tensione nominale della batteria collegata sia di 24 V.

CORRENTE DI CARICA: 5A @ 12V / 2.5A @ 24V (Ampmatic)

USO: al chiuso/all'aperto (temperatura minima: -40 °C).

RECUPERO: accensione a bassa tensione a 0,5 V (12 V) + recupero desolfatazione a 1 fase.

IDEALE PER: batterie STD, AGM e GEL 12 V da 3-240 Ah / 24 V da 1-100 Ah.

INGRESSO: universale (100-240 V 50-60 Hz), alta efficienza (presente nell'elenco CEC), completamente ermetico.

TIPO: custodia resistente alle intemperie con occhielli di montaggio a parete con connettore di alimentazione da 180 cm CA e connettore di carica da 180 cm che termina nel connettore SAE. Connettore della batteria resistente alle intemperie e set standard morsetto della batteria inclusi.

SICUREZZA: nessun rischio di sovraccarico. Completamente sicuro per elettronica automobilistica. Assenza di scintille Sicuro per il mantenimento della batteria nel lungo termine. Spegnimento automatico in caso di cortocircuito o disconnessione della batteria Garanzia di sostituzione limitata di tre anni.

Optimate6 ampmatic

INDOOR/
OUTDOOR



OPTIMATE 6 AMPMATIC

Cod. **450166**



3 - 240Ah



Caricabatterie con recupero di batteria, manutentore e tester nove fasi 12 V 5 A
Il caricabatterie da 12 V completamente automatico più avanzato al mondo!

OptiMate 6 recupera le batterie che altri caricabatterie non riescono a recuperare perché riconosce la differenza tra una batteria completamente scarica da caricare e una batteria solfatata "morta" da recuperare.



- **Desolfatazione multistadio:** recupera batterie completamente scariche a partire da un minimo di 0,5 Volt.
- **Il controllo della carica Ampmatic regola la corrente per qualunque dimensione (da 3 a 240 Ah) O condizione della batteria, per una carica più veloce e più completa.**
- **La modalità di equalizzazione della tensione delle celle prepara correttamente le batterie NUOVE al primo uso e ne ottimizza le prestazioni.**
- **Test sullo stato della batteria svolti ogni giorno e carica fluttuante interattiva mantengono la batteria completamente carica per settimane o mesi.**

CORRENTE DI CARICA: 5 A (Ampmatic)

USO: al chiuso/all'aperto (temperatura minima: -40 °C).

RECUPERO: accensione a bassa tensione a 0,5 V + recupero desolfatazione a 2 fasi.

IDEALE PER: batterie STD, AGM e GEL 12 V da 3-240 Ah.

INGRESSO: universale (100-240 V 50-60 Hz), alta efficienza (presente nell'elenco CEC), completamente ermetico.

TIPO: custodia resistente alle intemperie con occhielli di montaggio a parete con connettore di alimentazione da 180 cm CA e connettore di carica da 180 cm che termina nel connettore SAE. Connettore della batteria resistente alle intemperie e set standard morsetto della batteria inclusi.

SICUREZZA: nessun rischio di sovraccarico. Completamente sicuro per elettronica automobilistica. Assenza di scintille Sicuro per il mantenimento della batteria nel lungo termine. Spegnimento automatico in caso di cortocircuito o disconnessione della batteria Garanzia di sostituzione limitata di tre anni.

Optimate6 select

INDOOR/
OUTDOOR



OPTIMATE 6 SELECT

Cod. **450161**



3-200Ah



Caricabatterie con recupero di batteria, manutentore e tester 9 fasi 12 V 5 A
Il caricabatterie (12V) più avanzato al mondo!

OptiMate 6 Select è perfetto per batterie di avviamento e a ciclo profondo da 12 V che richiedono una carica accurata a temperatura controllata e un mantenimento senza sorveglianza e in sicurezza a lungo termine. La selezione della tensione (14,4 V/17,4 V) garantisce che la batteria riceva carica alla tensione corretta. .

Special feature: POWER SUPPLY

L'ALIMENTAZIONE eroga potenza stabile per la riprogrammazione del sistema del veicolo, per dimostrazioni in autosalone o per il mantenimento delle impostazioni memorizzate quando i cavi della batteria sono scollegati, per collegare accessori alimentati direttamente o sostituire la batteria.

CORRENTE DI CARICA: 5A (Ampmatic) @ 14.4V / 14.7V / 4A@ 13.6V

USO: al chiuso/all'aperto (temperatura minima: -40 °C).

RECUPERO: accensione a bassa tensione a 0,5 V (12 V) + recupero desolfatazione a 2 fasi

IDEALE PER: batterie STD, AGM, GEL e Deep Cycle 12 V da 3-240 Ah

INGRESSO: universale (100-240 V 50-60 Hz), alta efficienza (presente nell'elenco CEC), completamente ermetico.

TIPO: vedi Optimate 6 AMPMATIC.

SICUREZZA: nessun rischio di sovraccarico. Completamente sicuro per elettronica automobilistica. Assenza di scintille Sicuro per il mantenimento della batteria nel lungo termine. Spegnimento automatico in caso di cortocircuito o disconnessione della batteria Garanzia di sostituzione limitata di tre anni.





Optimate 7 12-24V

INDOOR/
OUTDOOR

-40°

GLOBAL INPUT
100V - 240V

- | | | | | | | | |
|-------------------------------|----------------------------|------------------------------|--------------------------------------|-------------------------|---------------------|--------------------------|----------------------------|
| 1
Selezione della tensione | 2
Protezione automatica | 3
TEST prima della CARICA | 4
RECUPERO impulsi bassa tensione | 5
CARICA controllata | 6
OTTIMIZZAZIONE | 7
TEST dopo la CARICA | 8
OptiMate manutenzione |
|-------------------------------|----------------------------|------------------------------|--------------------------------------|-------------------------|---------------------|--------------------------|----------------------------|

OPTIMATE 7 12V-24V

Cod. **450172**



Caricabatterie con recupero di batteria, manutentore e tester 8 fasi 12V-10A / 24V-5A

Il caricabatterie 12V 10A & 24V 5A più avanzato al mondo!

OptiMate 7 12V-24V è perfetto per batterie di avviamento e a ciclo profondo da 12 V e 24 V che richiedono una carica accurata a temperatura controllata e un mantenimento senza sorveglianza e in sicurezza a lungo termine.

CARATTERISTICHE SPECIALI: progettate per componenti elettronici sensibili: il programma di RECUPERO è stato progettato per un avvio SICURO completamente automatico e a basso voltaggio (a partire da 0,5 V) e per il recupero a IMPULSI di batterie molto scariche collegate a componenti elettronici molto sensibili, ad esempio quelli per velivoli leggeri o attrezzature industriali.

Protezione in caso di una errata selezione della tensione: se viene selezionata una batteria a 24 V ma ne viene collegata una da 12 V OptiMate 7 12-24 V avviserà l'utente che è stata rilevata una bassa tensione e quindi non effettuerà la carica. Prima che si attivi la modalità di RECUPERO, l'UTENTE dovrà confermare che la tensione nominale della batteria collegata sia di 24 V.

CORRENTE DI CARICA: 10A @ 12V / 5A @ 24V (Ampmatic)

USO: al chiuso/all'aperto (temperatura minima: -40 °C).

RECUPERO: accensione a bassa tensione a 0,5 V (12 V) + recupero desolfatazione a 1 fase.

IDEALE PER: batterie STD, AGM e GEL 12 V da 3-400 Ah / 24 V da 1-200 Ah.

INGRESSO: universale (100-240 V 50-60 Hz), alta efficienza (presente nell'elenco CEC), completamente ermetico.

TIPO: custodia resistente alle intemperie con occhielli di montaggio a parete con connettore di alimentazione da 180 cm CA e connettore di carica da 180 cm che termina nel connettore SAE. Connettore della batteria resistente alle intemperie e set standard morsetto della batteria inclusi.

SICUREZZA: nessun rischio di sovraccarico. Completamente sicuro per elettronica automobilistica. Assenza di scintille Sicuro per il mantenimento della batteria nel lungo termine. Spegnimento automatico in caso di cortocircuito o disconnessione della batteria Garanzia di sostituzione limitata di tre anni.



Optimate 7 select

INDOOR/
OUTDOOR

-40°

GLOBAL INPUT
100V - 240V

- | | | | | |
|-------------------------|---|------------------------------|----------------------------|-----------------------|
| 1
Selezione | 2
Accensione a bassa tensione (0.5V) | 3
TEST prima della CARICA | 4
RECUPERO Turbo | 5
RECUPERO Impulsi |
| 6
CARICA controllata | 7
OTTIMIZZAZIONE Ampmatic | 8
TEST dopo la CARICA | 9
OptiMate manutenzione | |

OPTIMATE 7 SELECT

Cod. **450171**



Caricabatterie da 10 A a 9 fasi per batterie di avviamento e a ciclo profondo da 12 V

Il caricabatterie da 10 A più avanzato al mondo per batterie di avviamento e a ciclo profondo!

OptiMate 7 Select è perfetto per batterie di avviamento e a ciclo profondo da 12 V che richiedono una carica accurata a temperatura controllata e un mantenimento senza sorveglianza e in sicurezza a lungo termine. La selezione della tensione (14.4 V/14.7 V) garantisce che la batteria riceva carica alla tensione corretta.

Special feature: POWER SUPPLY

L'ALIMENTAZIONE eroga potenza stabile per la riprogrammazione del sistema del veicolo, per dimostrazioni in autosalone o per il mantenimento delle impostazioni memorizzate quando i cavi della batteria sono scollegati, per collegare accessori alimentati direttamente o sostituire la batteria.

CORRENTE DI CARICA: 10A (Ampmatic) @ 14.4V / 14.7V / 8A @ 13.6V

USO: al chiuso/all'aperto (temperatura minima: -40 °C).

RECUPERO: accensione a bassa tensione a 0,5 V (12 V) + recupero desolfatazione a 2 fasi

IDEALE PER: batterie STD, AGM, GEL e Deep Cycle 12 V da 3-400 Ah

INGRESSO: universale (100-240 V 50-60 Hz), alta efficienza (presente nell'elenco CEC), completamente ermetico.

TIPO: custodia resistente alle intemperie con occhielli di montaggio a parete con connettore di alimentazione da 180 cm CA e connettore di carica da 180 cm che termina nel connettore SAE. Connettore della batteria resistente alle intemperie e set standard morsetto della batteria inclusi.

SICUREZZA: nessun rischio di sovraccarico. Completamente sicuro per elettronica automobilistica. Assenza di scintille Sicuro per il mantenimento della batteria nel lungo termine. Spegnimento automatico in caso di cortocircuito o disconnessione della batteria Garanzia di sostituzione limitata di tre anni.

OptiMATE LFP
lithium 4s 0.8A

INDOOR/
OUTDOOR



- 1 Accensione a bassa tensione (0.5V)
- 2 RECUPERO a tensione ultra bassa
- 3 BASSO VOLTAGGIO RECUPERO / monitoraggio delle celle
- 4 TEST danni alla cella
- 5 CARICA per equalizzazione delle celle
- 6 OTTIMIZZAZIONE
- 7 TEST dopo la CARICA
- 8 OptiMate manutenzione

OPTIMATE LITHIUM 4S 0.8A

Cod. **450157**



LFP fino a 30Ah

Caricabatterie con recupero di batteria, manutentore e tester otto fasi 12,8/13,2 V 0,8 A

Protezione della batteria Unique LiFePO4!

OptiMate Lithium 0,8 A 4S carica batterie di serie 4 LiFePO4/LFP (litio ferro-fosfato) con tensione nominale 12,8 V-13,2 V.

Caratteristiche speciali:

- Consente il recupero delle batterie LiFePO4 a bassa tensione
- Ciclo di carica specifico per batterie LiFePO4
- Consente la protezione e il mantenimento delle batterie LiFePO4
- Reset BMS della batteria.

CORRENTE DI CARICA: 8 A

USO: al chiuso/all'aperto (temperatura minima: -20 °C).

RECUPERO: Accensione a bassa tensione a 0,5 V + recupero e test a 3 fasi a bassa tensione.

IDEALE PER: Batterie con celle serie 4 LiFePO4 (LFP) 12,8 V-13,2 V 2-30 Ah.

INGRESSO: universale (100-240 V 50-60 Hz), alta efficienza (presente nell'elenco CEC), completamente ermetico.

TIPO: custodia resistente alle intemperie con occhielli di montaggio a parete con connettore di alimentazione da 180 cm CA e connettore di carica da 180 cm che termina nel connettore SAE. Connettore della batteria resistente alle intemperie e set standard morsetto della batteria.

SICUREZZA: nessun rischio di sovraccarico. Completamente sicuro per elettronica automobilistica. Assenza di scintille Sicuro per il mantenimento della batteria nel lungo termine. Spegnimento automatico in caso di cortocircuito o disconnessione della batteria Garanzia di sostituzione limitata di tre anni.



OptiMATE LFP
lithium 4s 5A

INDOOR/
OUTDOOR



- 1 Accensione a bassa tensione (0.5V)
- 2 TEST prima della CARICA
- 3 CONTROLLO termico
- 4 RECUPERO a tensione ultra bassa
- 5 BASSO VOLTAGGIO RECUPERO / monitoraggio delle celle
- 6 TEST danni alla cella
- 7 CARICA per equalizzazione delle celle
- 8 OTTIMIZZAZIONE
- 9 TEST dopo la CARICA
- 10 OptiMate manutenzione

OPTIMATE LITHIUM 4S 5A

Cod. **450156**



LFP fino a 100Ah

Caricabatterie con recupero di batteria, manutentore e tester dieci fasi 12,8 V/13,2 V 5 A

Caricabatterie di livello professionale Ultimate LiFePO4.

Caricabatterie e tester con funzione di diagnosi ad alta efficienza per batterie LiFePO4/LFP. Perfetto per carica e mantenimento stagionale di una batteria da 12,8 V-13,2 V LiFePO4/LFP da 2 a 100 Ah.

Caratteristiche speciali:

- **Modalità di RECUPERO della batteria con reset BMS della batteria:** inizia da 0,5 V con sorveglianza continua/test dell'accettazione della carica o stato di cella difettosa/cortocircuitata. Previene la carica inutile (e non sicura) di una batteria difettosa.
- **SafeT:** regolazione automatica della velocità di carica in base alla temperatura ambiente rilevata dal caricabatterie. Carica ridotta in caso di temperature sotto il punto di congelamento, carica nulla in caso di temperature inferiori a -20 °C (si possono verificare danni alle batterie al litio).
- **Ampmatic:** il microprocessore regola la corrente alla curva di carica LiFePO4 ideale in base alle dimensioni/allo stato della batteria, per una carica più veloce e più completa.

CORRENTE DI CARICA: 5 A (Ampmatic)

USO: al chiuso/all'aperto (temperatura minima: -20 °C).

RECUPERO: accensione a bassa tensione a 0,5 V + RECUPERO e TEST a 3 fasi a bassa tensione.

IDEALE PER: batterie di serie 4 LiFePO4 (LFP) 2-100 Ah.

INGRESSO: universale (100-240 V 50-60 Hz), alta efficienza (presente nell'elenco CEC), completamente ermetico.

TIPO: vedi OptiMate LITHIUM 4S 0.8A

SICUREZZA: nessun rischio di sovraccarico. Completamente sicuro per elettronica automobilistica. Assenza di scintille Sicuro per il mantenimento della batteria nel lungo termine. Spegnimento automatico in caso di cortocircuito o disconnessione della batteria Garanzia di sostituzione limitata di tre anni.





- | | | | | |
|--|---|-------------------------------|---|---|
| 1
Accensione a bassa tensione (0.5V) | 2
TEST prima della CARICA | 3
CONTROLLO termico | 4
RECUPERO a tensione ultra bassa | 5
BASSO VOLTAGGIO RECUPERO / monitoraggio delle celle |
| 6
TEST danni alla cella | 7
CARICA per equalizzazione delle celle | 8
OTTIMIZZAZIONE | 9
TEST dopo la CARICA | 10
OptiMATE manutenzione |

OPTIMATE LITHIUM SELECT

Cod. **450153**

16V fino a 200Ah

Caricabatterie con recupero di batteria, manutentore e tester dieci fasi 12,8 V / 16 V 9.5 A
Il nuovissimo caricabatterie professionale per batterie al litio da 12,8 V e 16 V

OptiMate Lithium LFP Select è perfetto per batterie LiFePO4/LFP ad alte prestazioni da 12,8 V (4 s) e 16 V (5 s) che richiedono una carica rapida, accurata, a temperatura controllata e completamente automatica. Perfetto per batterie LiFePO4/LFP da 12,8 V/16 V, da 2,5 a 200 Ah. Modalità stand-by per risparmio energetico. Protezione elettronica completa da errori.

Caratteristiche speciali:

- **Modalità di RECUPERO della batteria con reset BMS della batteria:** inizia da 0.5 V con sorveglianza continua/test dell'accettazione della carica o stato di cella difettosa/cortocircuitata. Previene la carica inutile (e non sicura) di una batteria difettosa.
- **SafeT°:** regolazione automatica della velocità di carica in base alla temperatura ambiente rilevata dal caricabatterie. Carica ridotta in caso di temperature sotto il punto di congelamento, carica nulla in caso di temperature inferiori a -20 °C (si possono verificare danni alle batterie al litio).
- **Ampmatic:** il microprocessore regola la corrente alla curva di carica LiFePO4 ideale in base alle dimensioni/allo stato della batteria, per una carica più veloce e più completa.
- **Protezione in caso di una errata selezione della tensione:** se viene selezionata una batteria a 16 V ma ne viene collegata una da 12,8 V (serie 4), OptiMate 7 LFP Select avviserà l'utente che è stata rilevata una bassa tensione e quindi non effettuerà la carica. Prima che si attivi la modalità di RECUPERO, l'UTENTE dovrà confermare che la tensione nominale della batteria collegata sia di 16 V (serie 5). Durante la modalità di RECUPERO viene monitorata la curva di carica in modo da interromperne l'avanzamento nel caso in cui la batteria sembri avere una tensione inferiore a quella di una batteria da 16 V serie 5.

CORRENTE DI CARICA: 9.5A @ 12.8V / 7.5A @ 16V (AmpMatic)

USO: al chiuso/all'aperto (temperatura minima: -20 °C).

RECUPERO: accensione a bassa tensione a 0.5 V + RECUPERO e TEST a 3 fasi a bassa tensione.

IDEALE PER: batterie di serie 4 / 5 LiFePO4 (LFP) 2.5-200 Ah.

INGRESSO: universale (100-240 V 50-60 Hz), alta efficienza (presente nell'elenco CEC), completamente ermetico.

TIPO: custodia resistente alle intemperie con occhielli di montaggio a parete con connettore di alimentazione da 180 cm CA e connettore di carica da 180 cm che termina nel connettore SAE. Connettore della batteria resistente alle intemperie e set standard morsetto.

SICUREZZA: nessun rischio di sovraccarico. Completamente sicuro per elettronica automobilistica. Assenza di scintille. Sicuro per il mantenimento della batteria nel lungo termine. Spegnimento automatico in caso di cortocircuito o disconnessione della batteria. Garanzia di sostituzione limitata di tre anni.



OPTIMATE SOLAR + PANNELLO SOLARE A 6 W

Cod. **450159**



Caricatore, Tester e Mantentore Solare ad Impulsi per batterie 12V, con pannello solare 10W
Il sistema di caricabatterie solare a impulsi più efficiente del mondo che può recuperare la vostra batteria "fuori uso" e garantirne un mantenimento sicuro a lungo termine.



OptiMATE Solar utilizza una tecnologia di ricarica innovativa per caricare e mantenere efficacemente la vostra batteria a 12 V tramite un pannello solare standard. OptiMATE Solar converte la bassa potenza prodotta dal pannello solare in impulsi di corrente elevata più efficaci per la carica e il mantenimento di una batteria a 12 V. L'unità di controllo di carica OptiMATE è separata dal pannello e può essere collocata vicino al veicolo o alla batteria in modo da poter seguire facilmente l'avanzamento di carica e mantenimento.

Pannello solare:

- **POTENZA:** 6 Watt (max.)
- **VOLT:** 12 V nominale, 22 V massimo.
- **USO:** esterno.
- **TIPO:** involucro resistente alle intemperie con 4 fori di montaggio.

Unità di controllo di carica OptiMATE Charge:

- **CORRENTE DI CARICA:** 2 A (massima corrente media)
- **USO:** al chiuso/all'aperto (temperatura minima: -20 °C).
- **RECUPERO:** accensione a bassa tensione di 1 V.
- **IDEALE PER:** batterie STD, AGM e GEL 12 V da 2-240 Ah.
- **INGRESSO:** 15-22 V
- **TIPO:** involucro dell'unità di controllo di carica resistente alle intemperie Connettore della batteria resistente alle intemperie e set standard di morsetti della batteria inclusi.

SICUREZZA: nessun rischio di sovraccarico. Completamente sicuro per l'elettronica del veicolo. Assenza di scintille. Sicuro per il mantenimento della batteria nel lungo termine. Spegnimento automatico in caso di cortocircuito o scollegamento della batteria. Garanzia di sostituzione limitata di 3 anni.



UNITÀ DI CONTROLLO OPTIMATE SOLAR 12 V-2 A

Cod. **450158**

Tester e Mantentore Solare ad Impulsi per batterie 12V

Il sistema di caricabatterie solare a impulsi più efficiente del mondo che può recuperare la vostra batteria "fuori uso" e garantirne un mantenimento sicuro a lungo termine.

OptiMATE Solar utilizza una tecnologia di ricarica innovativa per caricare e mantenere efficacemente la vostra batteria a 12 V tramite un pannello solare standard. OptiMATE Solar converte la bassa potenza prodotta dal pannello solare in impulsi di corrente elevata più efficaci per la carica e il mantenimento di una batteria a 12 V. L'unità di controllo di carica OptiMATE è separata dal pannello e può essere collocata vicino al veicolo o alla batteria in modo da poter seguire facilmente l'avanzamento di carica e mantenimento.

Unità di controllo di carica OptiMATE Charge:

- **CORRENTE DI CARICA:** 2 A (massima corrente media)
- **USO:** al chiuso/all'aperto (temperatura minima: -20 °C).
- **RECUPERO:** accensione a bassa tensione di 1 V.
- **IDEALE PER:** batterie STD, AGM e GEL 12 V da 2-240 Ah.
- **INGRESSO:** 15-22 V
- **TIPO:** involucro dell'unità di controllo di carica resistente alle intemperie Connettore della batteria resistente alle intemperie e set standard di morsetti della batteria inclusi.

SICUREZZA: nessun rischio di sovraccarico. Completamente sicuro per l'elettronica del veicolo. Assenza di scintille. Sicuro per il mantenimento della batteria nel lungo termine. Spegnimento automatico in caso di cortocircuito o scollegamento della batteria. Garanzia di sostituzione limitata di 3 anni.



ACCUMATE
6V/12V



1

PRINCIPALE

2

ASSORBIMENTO

3

MANTENIMENTO

4

INVERSIONE

ACCUMATE 6/12 1.2A

Cod. **450130**

Caricabatterie-manutentore ChargeMatic a quattro fasi da 6 V/12 V

Carica qualunque batteria piombo-acido da 6 o 12 V, sia nel ciclo di avviamento sia nel ciclo profondo!

Caricabatterie compensato T° con programma di carica a 4 fasi IUoU e inversione dallo stadio di MANTENIMENTO se si assorbe alta tensione durante la carica di conservazione. Basta selezionare il voltaggio giusto, collegare la batteria e questo affidabile caricabatterie a temperatura compensata, a 4 fasi, farà il resto

CORRENTE DI CARICA: 1,2 A (temperatura compensata)

USO: al chiuso (temperatura minima: -20 °C).

ACCENSIONE A BASSA TENSIONE: accensione a bassa tensione (2 V) per batterie da 6 o 12 V.

IDEALE PER: batterie piombo-acido, STD, AGM e GEL da 6 V e 12 V, per ciclo di avviamento e ciclo profondo, fino a 50 Ah.

INGRESSO: Europa: 220-240 V 50-60 Hz America del Nord: 110-120 V 50-60 Hz.

TIPO: custodia standard (ventilata) con connettore di alimentazione da 180 cm CA e connettore di carica da 180 cm che termina nel connettore SAE. Connettore della batteria con fusibile e set standard morsetto della batteria inclusi.

SICUREZZA: *nessun rischio di sovraccarico. Completamente sicuro per elettronica automobilistica. Assenza di scintille Sicuro per il mantenimento della batteria nel lungo termine. Spegnimento automatico in caso di cortocircuito o disconnessione della batteria Garanzia di sostituzione limitata di tre anni.*

Optimate monitor

PIOMBO-ACIDO 12V: STD / AGM / GEL

MODALITÀ DI LAMPEGGIAMENTO (ogni 5 secondi)
Indica il livello di carica della batteria.

✓✓ Indicazione per alte prestazioni
(tensione superiore) AGM.

MODALITÀ FRECCIA
Indica la tensione di carica ideale
(motore in funzione)

✓✓ 13.5V ✓✓ 14V+

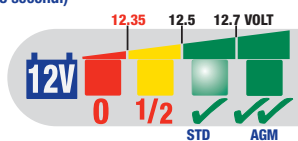

SAE

125 Piombo-acido 12V: Cod. **4502125**



SAE



SAE

12.8V LITHIUM (LiFePO₄)

MODALITÀ DI LAMPEGGIAMENTO (ogni 10 secondi)
Indica il livello di carica della batteria.

MODALITÀ FRECCIA Indica la tensione
di carica ideale (motore in funzione).
14.2 - 14.5 V

AVVERTENZA SOVRACCARICO
14.6V e superiore.



COLLEGAMENTO BATTERIA

127 12.8V Lithium (LiFePO₄) Cod. **4502127**



Spina SAE



M6 1/4"

Optimate LED

SAE

120 Torcia 12V 6-LED Cod. **4502120**



SAE



Batteria e carica controllo di sistema

TM

121 Torcia 12V 6-LED Cod. **4502121**



TM



Batteria e carica controllo di sistema

AGM/GEL

122 Cod. **4502122**



Con luce di controllo caricabatteria e batteria 12V.
Segnala con luce lampeggiante intermittente se il voltaggio della batteria
scende sotto la soglia minima di carica (per batterie sigillate AGM).

STD

123 Cod. **4502123**



Con luce di controllo caricabatteria e batteria 12V.
Segnala con luce lampeggiante intermittente se il voltaggio della batteria
scende sotto la soglia minima di carica.

Optimate

USB

STICK SAE

2400mA

100 con protezione batteria 8cm 3-1/4" Cod. **4502100**



SAE

USB

MOTO Dual 90°

3300mA

105 Cod. **4502105**



con protezione batteria
BMW - TRIUMPH

BIKE plug

2x USB

Spina AUTO

2100mA

106 Cod. **4502106**



12 - 24V

Spina AUTO

2x USB

CAVO

SPLITTER A Y

110 Cod. **4502110**



Codificata Apple 1A per gamba

USB

2x USB

ADATTATORE

mini USB

111 Cod. **4502111**



GPS / telecamera cavo di carica
+ Prolunga USB

USB

mini USB

ADATTATORE

micro USB

112



Cod. **4502112**

Microsoft & Android phones
+ Prolunga USB

USB

micro USB

ADATTATORE

Lightning 2x

113 iPhone 5x, 6x; iPad 3, 4, Air Cod. **4502113**



2 cavi
100cm 40in
30cm 12in

USB

8-pin USB Lightning

Optimate

cable

CONNETTORE PER BATTERIA RESISTENTE ALLE INTEMPERIE CAVO APPROVATO SPT-2W UL

01 Cod. **4501371**



SAE



M6 1/4"

PROLUNGA

03 180cm 6ft Cod. **4501942**



Caricabatterie ≤ OptiMate 6

SAE

SAE

SPINA AUTO ACCENDISIGARI Ø21 MM

02 Cod. **4501321**



Adattabile

Spina MOTO/AUTO

SAE

PRESA AUTO
ACCENDISIGARI Ø21MM

06

Cod. **4501971**



Presse AUTO



SAE

SAE

ADATTATORE : MOTOCICLETTA
Si adatta a connettore OEM - MV AGUSTA

57

Cod. **450187**



SAE



MV AGUSTA

MV AGUSTA

MORSETTI DELLA BATTERIA
SI ADATTA A POLI QUADRATI, ARROTONDATI E PIATTI

04

Cod. **4501381**



SAE



Standard

MORSETTI OptiMATE

15

Cod. **4502015**



SAE



Standard

2x SAE

ADATTATORE : TM/KET A SAE
OptiMATE > 2010

07

Cod. **4501991**



Spina TM / KET



Collegamento
per batteria

SAE

17

Cod. **450199**



SAE



caricabatterie

Presse TM / KET

PRESA MOTO
DIN Ø12 MM BMW-TRIUMPH-VICTORY

08

Cod. **4501341**



SAE + 0-01



100cm 40in

PRESA IN
PLASTICA
con tappo
di tenuta

SPINA MOTO
DIN Ø12 MM BMW-TRIUMPH-VICTORY

09

Cod. **4501291**



SAE



DRITTO
120cm 48in

Spina MOTO (180°)

19

Cod. **4502019**



SAE



PROFILO BASSO
15cm 6in

Spina MOTO (90°)

29

Cod. **4502029**



SAE



PROFILO BASSO
100cm 40in

Spina MOTO (90°)

ADATTATORE : MOTOCICLETTA
Si adatta a connettore OEM - DUCATI

47

Cod. **450186**



SAE



DUCATI

DUCATI

MONTAGGIO SU PANNELLO

20

Cod. **4502020**



Presse SAE



Ø 25mm 1"
Montaggio
anteriore,
fissaggio
anteriore
5mm 3/16"
pannello

SAE

MONTAGGIO SU PANNELLO

40



SAE



Cod. **4502040**

Ø 18mm 23/32"
Montaggio anteriore,
fissaggio posteriore
100cm 40in cavo

SAE

Optimate

connect

PROLUNGA SAE-73

SAE-73

Cod. **450128**



Prolunga SAE-73 4,60 mt. per Accumate/Optimate con prese SAE.

PRESA IMPERMEABILE PER NAV.

TM-68

Cod. **450197**



Connettore AMCLCON
Connettore impermeabile 12V c/cavo 0,9 mt. con presa TM
per navigatore satellitare.

CONNETTORE AMEYEDL

TM-71

Cod. **450137**



Connettore impermeabile c/cappuccio e fusibile
utilizzabile con i carica batteria serie Optimate e Accumate
con presa TM (max 5A), occhielli M6, lunghezza 50 cm.

CONNETTORE AMDCPLUG

TM-72

Cod. **450132**



Connettore 12V per accendisigari utilizzabile con i carica batteria serie
Optimate e Accumate e/o per moto BMW con prese TM, lunghezza 50 cm.

CONNETTORE AMEXTEND

TM-73

Cod. **450198**



Prolunga 2,5 metri per carica batteria serie Accumate/Optimate
con presa TM maschio/femmina

CONNETTORE AMCLAMP

TM-74

Cod. **450138**



Pinze con connettore utilizzabile con i carica batteria serie
Optimate e Accumate con presa TM.

CONNETTORE DIN SOCKET

TM-78

Cod. **450134**



Presa impermeabile 12V tipo femmina c/cavo 0,9 mt. utilizzabile con i
carica batteria serie Optimate e Accumate con prese TM.

CONNETTORE OMPRO8SEXT

TM-79

Cod. **450194**



Prolunga 2,5 metri c/connettori maschi per carica batterie serie
Accumate/Optimate con presa TM

PRESA CAN-BUS C/CONNETTORE TM

TM-95

Cod. **450129**



Presa DIN TM-95 Can-Bus c/connettore TM lunghezza 1,2 mt.
Per: moto BMW e carica batterie con presa TM (max 5A).

RETE AGENTI NAZIONALE



■ **MAURO SANTANGELETTA**

+39 348 5800752
ag0018@sgr-it.com
PIEMONTE | VALLE D'AOSTA

■ **OTTAVIO TAGLIARINI**

+39 335 6138630
ag0011@sgr-it.com
MILANO | MONZA e BRIANZA |
LODI

■ **MAURIZIO BARILLI**

+39 392 1726587
ag0010@sgr-it.com
LOMBARDIA

■ **FRANCESCO MASI**

+39 335 5956605
ag0021@sgr-it.com
VENETO | TRENTO ALTO ADIGE |
FRIULI VENEZIA GIULIA

■ **MASSIMO FRIGERIO**

+39 338 8417813
ag0013@sgr-it.com
LIGURIA

■ **ALDO ALMAVIVA**

+39 346 7221076
ag0002@sgr-it.com
EMILIA ROMAGNA | ROVIGO

■ **MARCO MASINI**

+39 333 5965863
ag0020@sgr-it.com
TOSCANA | UMBRIA

■ **CHRISTIAN COSTANZO**

+39 348 4204334
ag0019@sgr-it.com

MARCHE | ABRUZZO | MOLISE

■ **MASSIMO EVANGELISTA**

+39 348 2255336
ag0006@sgr-it.com
LAZIO

■ **MARIO FRENNA**

+39 335 8332035
ag0007@sgr-it.com
CAMPANIA

■ **ROCCO MASTROLONARDO**

+39 335 6064565
ag0014@sgr-it.com

PUGLIA | BASILICATA

■ **GIUSEPPE LA MALFA**

+39 347 2593210
ag0009@sgr-it.com
CALABRIA

■ **VINCENZO MIGNEMI**

+39 340 0652609
ag0024@sgr-it.com
CATANIA | MESSINA | SIRACUSA |
RAGUSA | ENNA

■ **GIUSEPPE MIGNEMI**

+39 340 7629426
ag0023@sgr-it.com
TRAPANI | PALERMO | AGRIGENTO |
CALTANISSETTA

■ **ALBERTO TOFFOLONI**

+39 335 5950061
ag0012@sgr-it.com
SARDEGNA



Società Generale Ricambi (Europa) p. A.

T +39. 051. 722557 W www.sgr-it.com
F +39. 051. 720376 E info@sgr-it.com

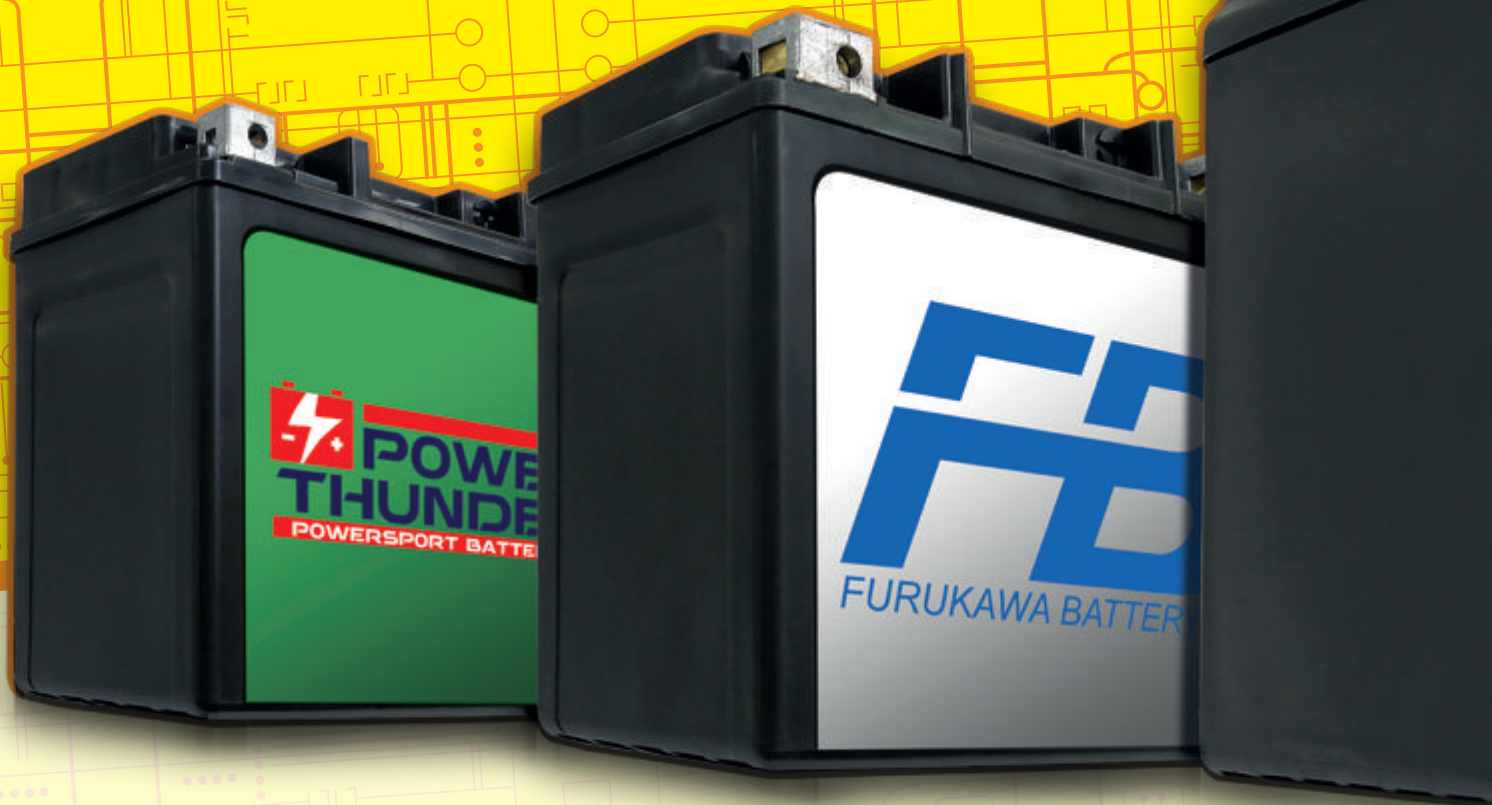

SOCIETÀ GENERALE RICAMBI (EUROPA) P.A.

SEDE DI BOLOGNA: MAGAZZINO DI MILANO:

40012 CALDERARA DI RENO - Via Armaroli 10/12

20129 MILANO - Via Pasquale Sottocorno 52

Tel: +39 051722557

Tel: +39 027382368 - 0276110273

Fax: +39 051720376

Fax +39 0270106598

info@sgr-it.com

www.sgr-it.com